

# Panasonic

Personal Facsimile

Model No.

## KX-FT33NZ

### Quick Start



To get started,  
please read the  
Quick Start section.

Initial Preparation

Telephone

Fax/Copy

Help

General Information

# OPERATING INSTRUCTIONS

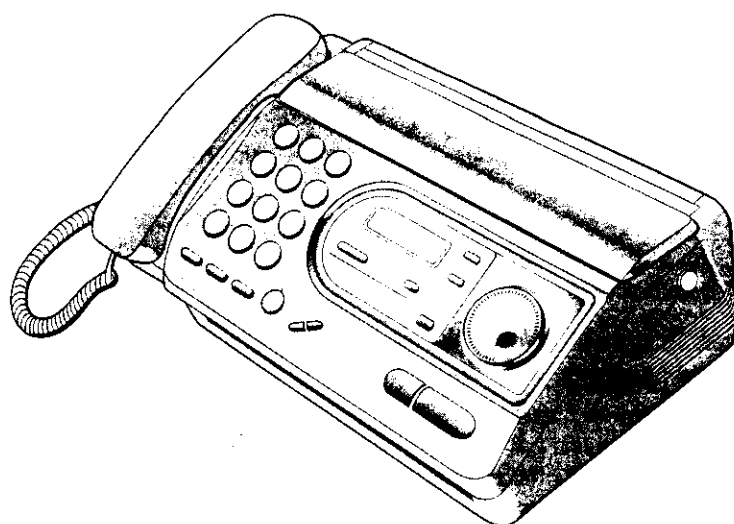

Please read these Operating Instructions before using the unit and save for future reference.

# Important safety instructions

---

---

When using this unit, basic safety precautions should always be followed to reduce the risk of fire, electric shock, or personal injury.

1. Read and understand all instructions.
2. Follow all warnings and instructions marked on this unit.
3. Unplug this unit from AC outlets before cleaning. Do not use liquid or aerosol cleaners. Use a damp cloth for cleaning.
4. Do not use this unit near water, for example, near a bath tub, wash bowl, kitchen sink, or the like.
5. Place the unit securely on a stable surface. Serious damage and/or injury may result if the unit falls.
6. Do not cover slots and openings on the unit. They are provided for ventilation and protection against overheating. Never place the unit near radiators, or in a place where proper ventilation is not provided.
7. Use only the power source marked on the unit. If you are not sure of the type of power supplied to your home, consult your dealer or local power company.
8. For safety purposes this product is equipped with a three prong grounded plug. If you do not have this type of outlet, please have one installed. Do not use any type of adaptor plug to defeat this safety feature.
9. Do not place objects on the power cord. Install the unit where no one can step or trip on the cord.
10. Do not overload wall outlets and extension cords. This can result in the risk of fire or electric shock.
11. Never push any objects through slots in this unit. This may result in the risk of fire or electric shock. Never spill any liquid on the unit.
12. To reduce the risk of electric shock, do not disassemble this unit. Take the unit to an authorized servicer when service is required. Opening or removing covers may expose you to dangerous voltages or other risks. Incorrect reassembly can cause electric shock when the unit is subsequently used.
13. Unplug this unit from the wall outlet and refer servicing to an authorized servicer when the following conditions occur:
  - A. When the power supply cord or plug is damaged or frayed.

- B. If liquid has been spilled into the unit.
  - C. If the unit has been exposed to rain or water.
  - D. If the unit does not work normally by following the operating instructions. Adjust only controls covered by the operating instructions. Improper adjustment may require extensive work by an authorized servicer.
  - E. If the unit has been dropped or physically damaged.
  - F. If the unit exhibits a distinct change in performance.
14. During thunderstorms, avoid using telephones except cordless types. There may be a remote risk of an electric shock from lightning.
  15. Do not use this unit to report a gas leak, when in the vicinity of the leak.

## SAVE THESE INSTRUCTIONS

### INSTALLATION:

1. Never install telephone wiring during a lightning storm.
2. Never install telephone jacks in wet locations unless the jack is specifically designed for wet locations.
3. Never touch uninsulated telephone wires or terminals unless the telephone line has been disconnected at the network interface.
4. Use caution when installing or modifying telephone lines.



### WARNING:

- To prevent the risk of fire or electrical shock, do not expose this product to rain or any type of moisture.

### OTHER INFORMATION:

- Keep the unit away from electrical noise-generating devices, such as fluorescent lamps and motors.
- The unit should be kept free from dust, high temperature, and vibration.
- The unit should not be exposed to direct sunlight.
- Do not place heavy objects on top of this unit.
- Do not touch the plug with wet hands.

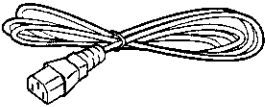
## Included accessories

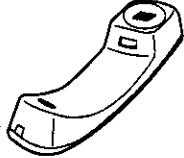
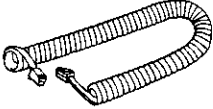
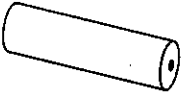
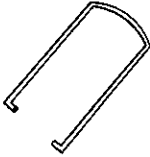
<p>Power cord ..... 1 pc.</p> 	<p>Telephone line cord ..... 1 pc.</p> 	<p>Handset ..... 1 pc.</p> 
<p>Handset cord ..... 1 pc.</p> 	<p>Recording paper ..... 1 pc.</p>  <p>— See the next page for ordering the recording paper.</p>	<p>Paper stacker..... 1 pc.</p> 

- If any items are missing or damaged, check with the place of purchase.
- Save the original carton and packing materials for future shipping and transporting of the unit.

# Accessory order information

Use the following types of recording paper for replacement.

Model No.	Description	Specifications
KX-A106	Standard thermal recording paper	216 mm x 30 m (8½" x 98") roll, with 25 mm (1") core
KX-A125	Super thermal recording paper (Like plain paper)	216 mm x 30 m (8½" x 98") roll, with 25 mm (1") core

# Help function

You can print a quick reference for assistance as follows.

**1** Select which operation you want to print out by pressing **HELP** repeatedly.

- Pressing **HELP** one time

1. HOW TO SET UP

two times

2. EASY DIAL

three times

3. FAX OPERATION

four times

4. RECEIVE MODE

**2** Press **START/COPY/SET**.

PRINTING

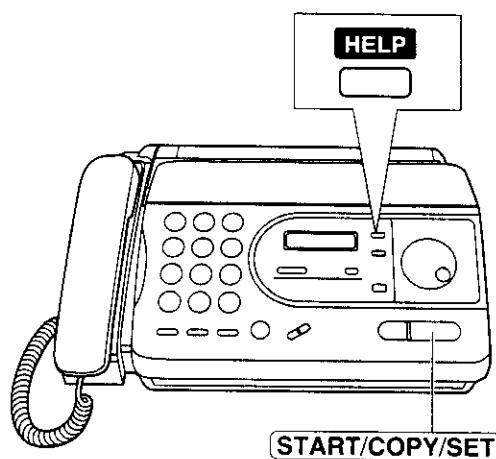

# Table of Contents

## Quick Start

To install the recording paper	8
To connect the unit	9
To make a voice call	10
To answer a voice call	10
To send faxes	11
To receive faxes	12
To make a copy	13

## Initial Preparation

<b>Finding the Controls</b>	Location	14
	Overview	16
<b>Setup</b>	Installing the recording paper	17
	Installing the paper stacker	17
	Connections	18
	Programming the date and time, your name and facsimile telephone number	19
<b>Volumes</b>	Adjusting volumes	23

## Telephone

<b>Making and Answering Calls</b>	Making a voice call manually	24
	Answering a voice call	24
	TONE, RECALL and PAUSE buttons	25
<b>EASY DIAL</b>	Storing names and telephone numbers in the EASY DIAL directory	26
	Making a voice call using the EASY DIAL directory	29
<b>Voice Contact</b>	Talking to the caller after fax transmission or reception	30

## Fax/Copy

<b>Sending Faxes</b>	Sending faxes manually	31
	Sending faxes using the EASY DIAL directory	32
	Documents you can send	33
	Printing the transmission report	34
	Setting the journal report to print automatically	35
	Delayed transmission (sending a fax at a specific time)	36
	Sending documents overseas	37
	Transmit polling (letting another machine retrieve a fax on your unit)	37

(continued)

# Quick Start

<b>Fax/Copy</b>	<b>Receiving Faxes</b>	Selecting the way to receive calls . . . . .	38	<b>Initial Preparation</b>	
		TEL mode (answering all calls manually) . . . . .	40		
		FAX ONLY mode (all calls are received as faxes) . . . . .	41		
		TEL/FAX mode (receiving voice calls with rings and fax calls without rings) . . . . .	42		
		Distinctive ring service (FaxAbility) . . . . .	45		
		Receiving faxes using an extension telephone . . . . .	46		
		Changing the fax activation code . . . . .	46		
		Receive polling (retrieving faxes placed on another party's machine) . . . . .	47		
		Setting the friendly reception . . . . .	47		
		Signaling your pager when your unit receives a fax . . . . .	48		
<b>Help</b>	<b>Copying</b>	Making a copy . . . . .	49	<b>Telephone</b>	
		<b>Error Messages</b>	Error messages on printed reports . . . . .		50
			Error messages on the LCD display . . . . .		51
		<b>Operations</b>	When a function does not work, check here before requesting help . . . . .		52
			If a power failure occurs . . . . .		53
		<b>Jams</b>	Clearing a recording paper jam . . . . .		54
			When a document you are sending jams . . . . .		55
			When documents you send do not feed, or multi-feed . . . . .		55
		<b>Cleaning</b>	Cleaning the document feeder . . . . .		56
			Cleaning the thermal head . . . . .		56
<b>General Information</b>	<b>Print Reports</b>	Printing the feature settings, telephone numbers, and the journal . . . . .	57	<b>Fax/Copy</b>	
	<b>Display Contrast</b>	Changing the LCD display contrast . . . . .	58		
	<b>Original Mode</b>	Setting the original mode . . . . .	58		
	<b>Reset</b>	Resetting the advanced features . . . . .	59		
	<b>Features Summary</b>	Summary of user programmable features . . . . .	60		
	<b>Specifications</b>	Technical data about this product . . . . .	62		
	<b>Index</b>	Index . . . . .	63		
				<b>General Information</b>	

# Quick Start

## To install the recording paper

**1** Open the cover by pressing the cover open button.

**2** Install a recording paper roll.

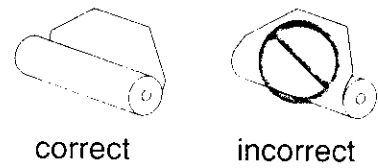
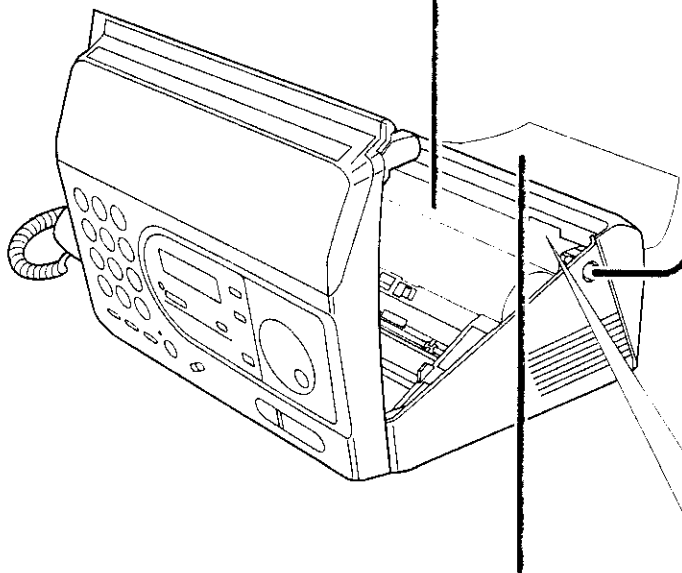

**3** Insert the leading edge of the paper into the opening above the thermal head and pull it out of the unit.

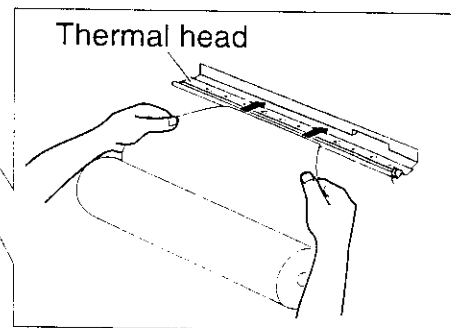

**4** Close the cover securely by pushing down on both corners.

**5** Install the paper stacker.

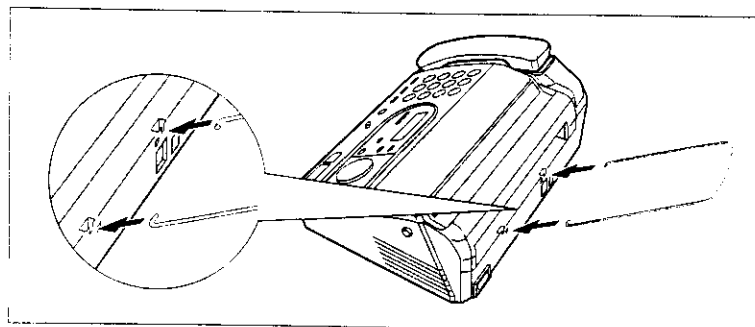

• For further details, see page 17.

# Quick Start

## To connect the unit

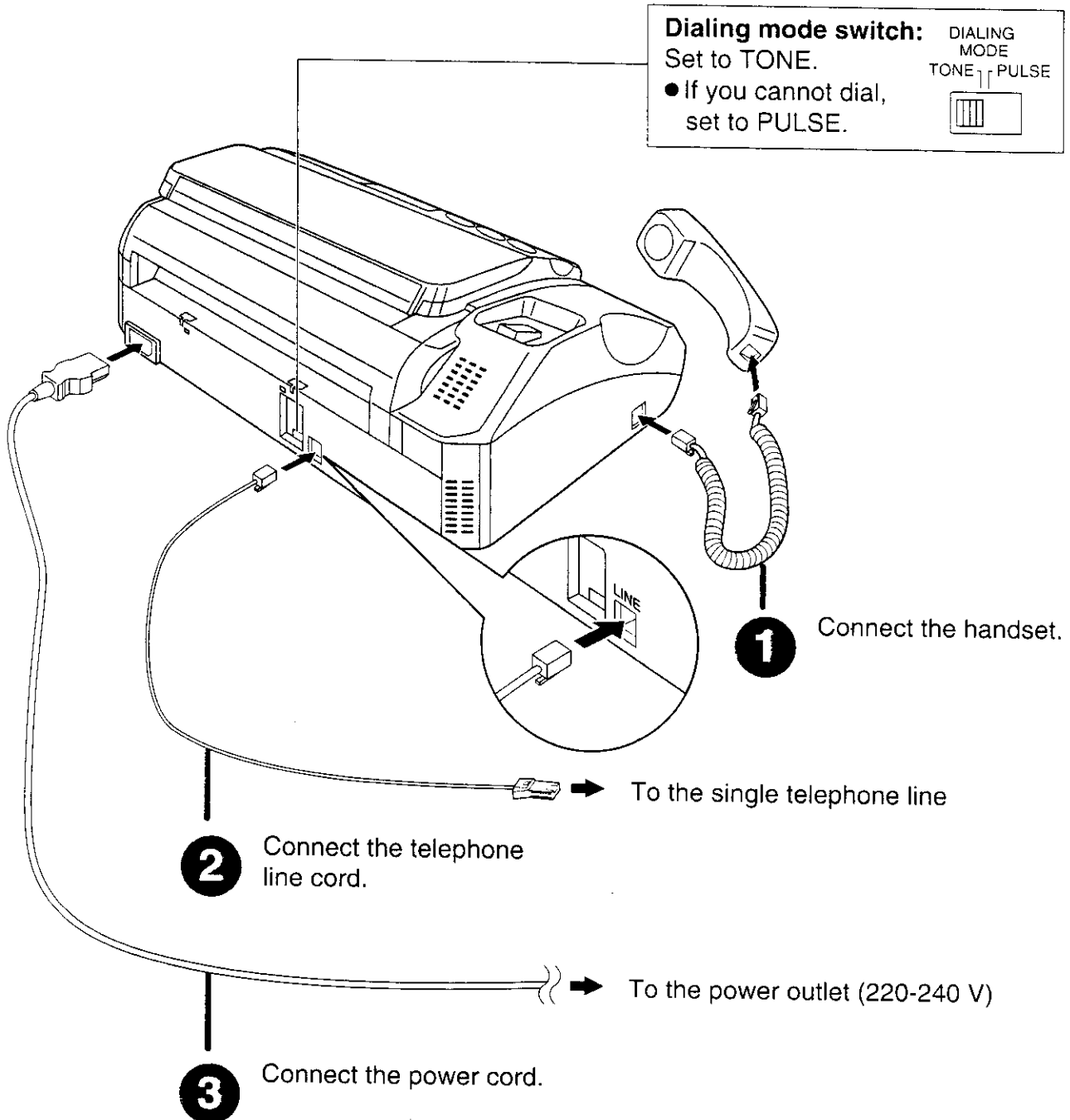

- This device is equipped with pulse dialling while the Telecom standard is DTMF tone dialling. There is no guarantee that Telecom lines will always continue to support pulse dialling.
- Use of pulse dialling, when this equipment is connected to the same line as other equipment, may give rise to bell tinkle or noise and may also cause a false answer condition. Should such problems occur, the user should NOT contact Telecom Faults Service.
- For further details, see page 18.
- You can print a quick reference for assistance (see the "Help function" on page 5).



# Quick Start

## To make a voice call

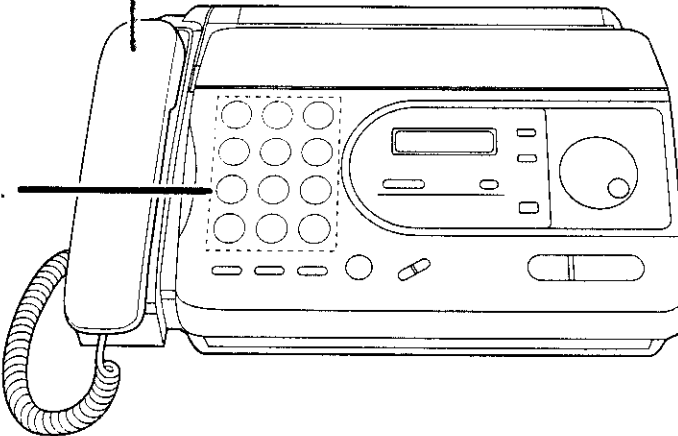
- 1** Lift the handset.
  - 2** Dial the number.
  - 3** When finished, hang up the handset.
- 
- A line drawing of a corded telephone. A line from step 1 points to the handset. A line from step 2 points to the numeric keypad. The telephone has a handset on the left, a numeric keypad, a display screen, and various function buttons on the main unit.

## To answer a voice call

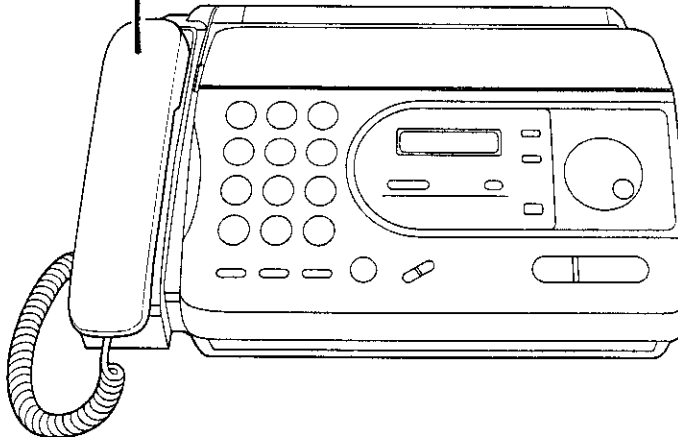
- 1** When the unit rings, lift the handset.
  - 2** When finished, hang up the handset.
- 
- A line drawing of a corded telephone, identical to the one in the first section. A line from step 1 points to the handset. The telephone has a handset on the left, a numeric keypad, a display screen, and various function buttons on the main unit.

• For further details, see page 24.

## To send faxes

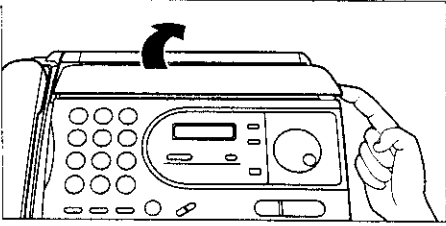
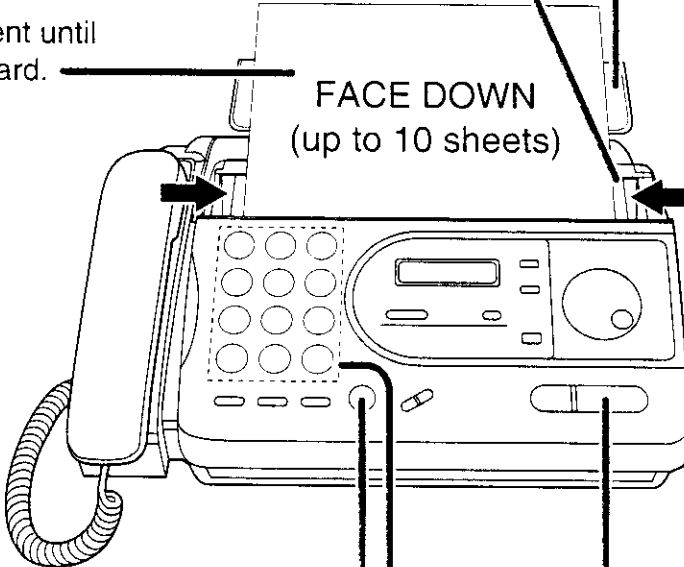
- 1** Open the document feeder tray.  

- 2** Adjust the width of the document guides to the size of the document.
- 3** Insert the document until a beep tone is heard.  

- 4** Press **MONITOR**.
- 5** Dial the fax number.
- 6** When a fax tone is heard, press **START/COPY/SET**.

● For further details, see page 31.

# Quick Start

## To receive faxes

---

---

- 1** When the unit rings, lift the handset.

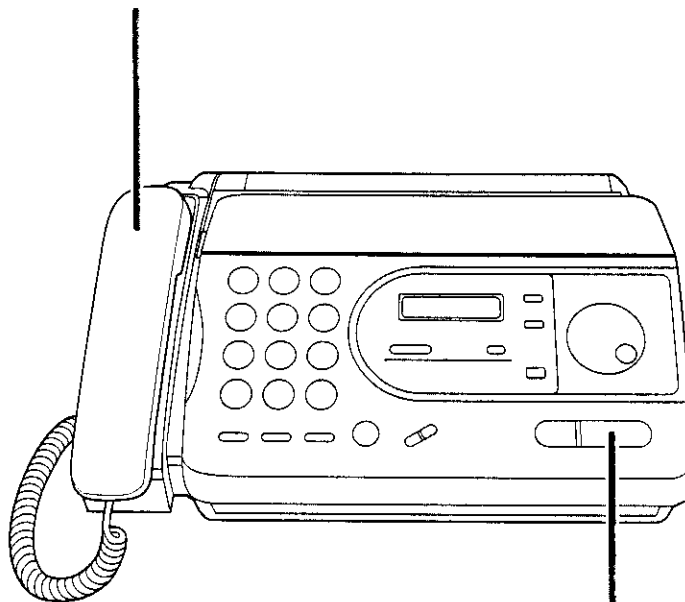

- 2** When:
  - document reception is required,
  - a fax calling tone (slow beep) is heard, or
  - no sound is heard,press **START/COPY/SET**.

- 3** Hang up the handset.

- For further details, see page 40.
- You can select the desired receive mode according to your needs. See pages 38 and 39.

## To make a copy

- 1 Open the document feeder tray.

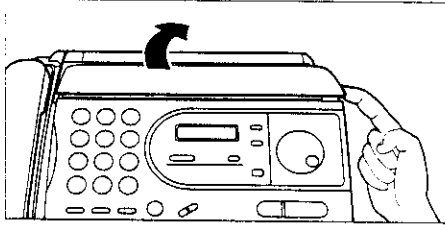

- 2 Adjust the width of the document guides to the size of the document.

- 3 Insert the document until a beep tone is heard.

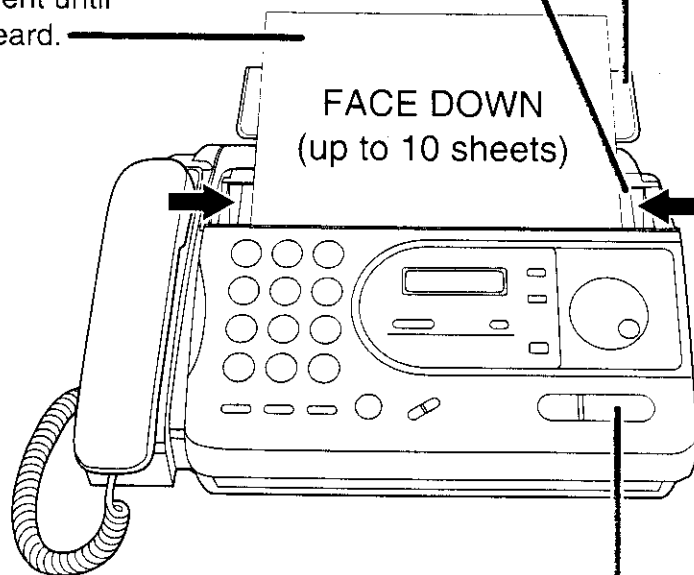

- 4 Press **START/COPY/SET**.

● For further details, see page 49.

# Finding the Controls

## Location

- Used to change from pulse to tone during dialing (p. 25).
- Used to turn on/off the auto receive mode (p. 38, 39).
- Used as an insert key (p. 20, 21, 27).
- Used to select a resolution (p. 31).
- Used as a secret key (p. 26).

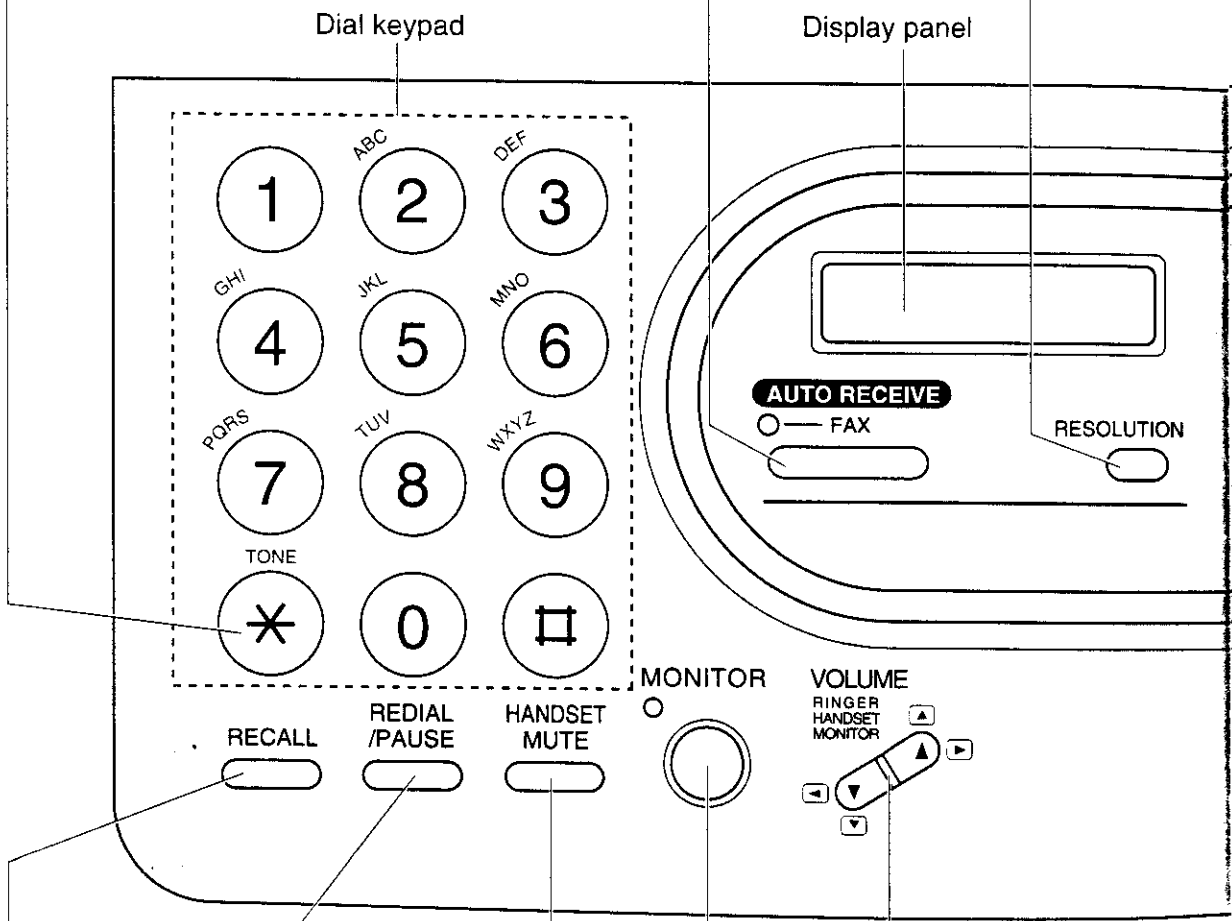

- Used to redial the last number dialed (p. 24, 31).
- Used to insert a pause during dialing (p. 25).
- Used to adjust volumes (p. 23).
- Used to select feature settings during programming.
- Used to dial without lifting the handset.
- Used as a hookswitch (p. 25).
- Used for handset muting (p. 24).
- Used as a hyphen key (p. 27).

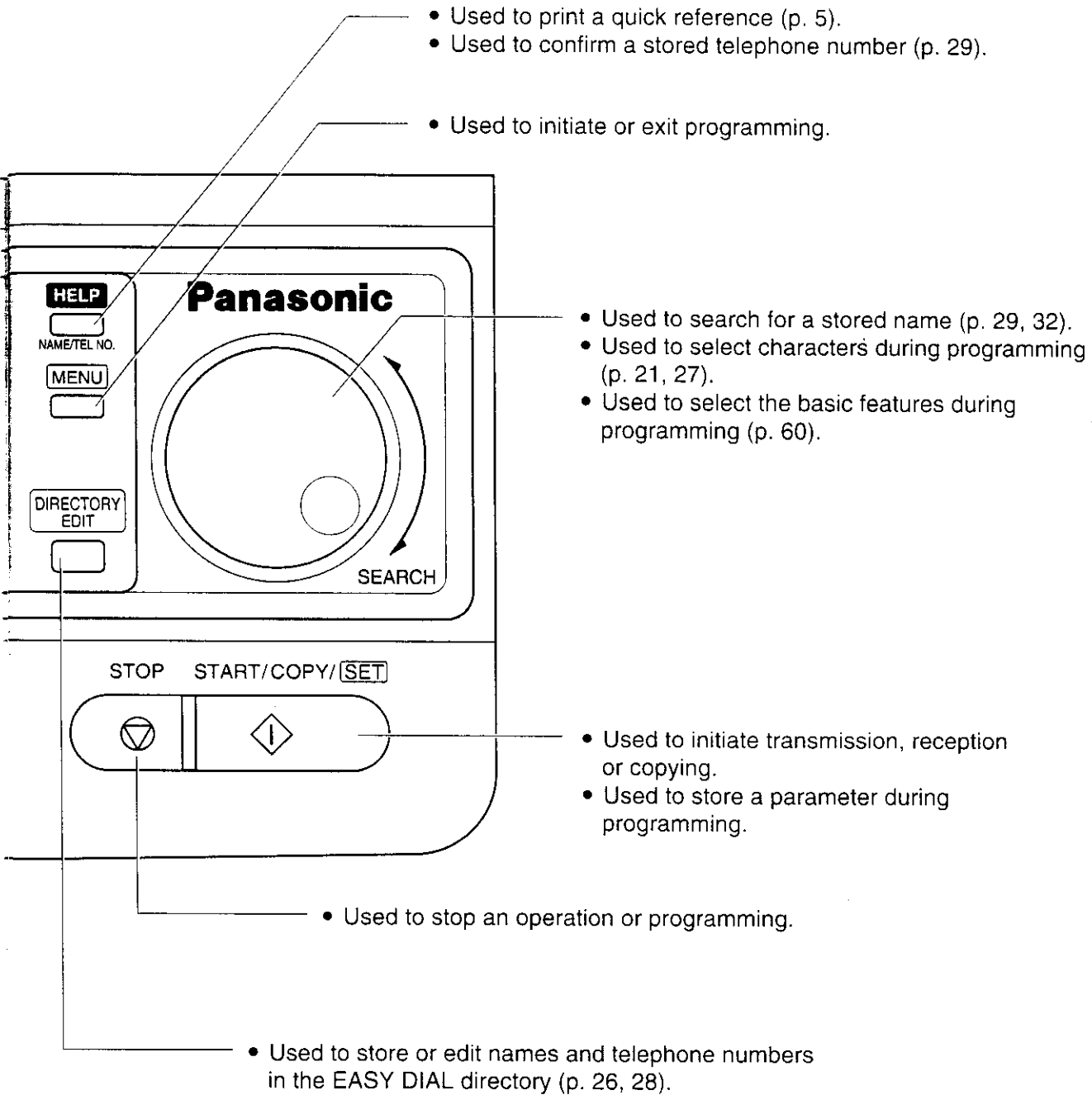

# Overview

---

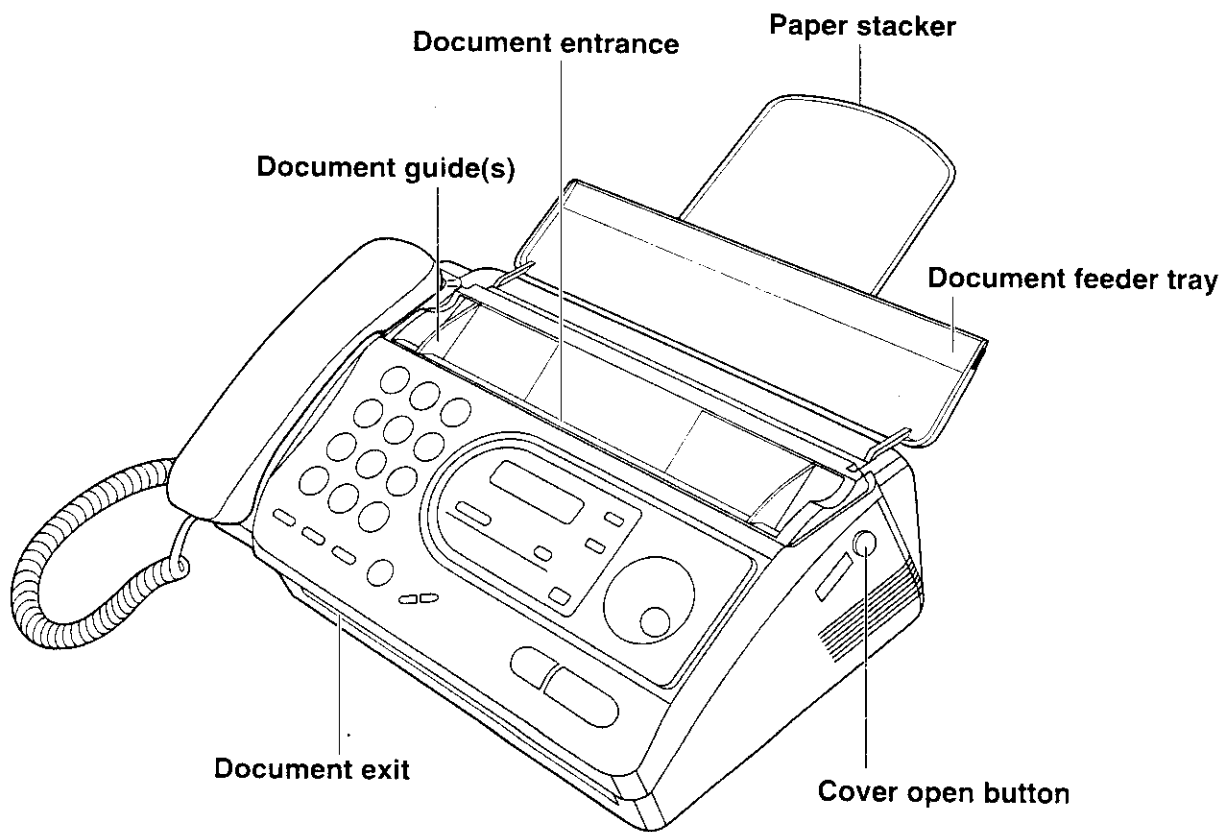

## Installing the recording paper

- 1** Open the cover by pressing the cover open button and install the recording paper roll.

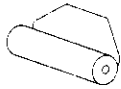

correct



incorrect

- If the paper is secured with glue or tape, cut approximately 15 cm (6 inches) from the beginning of the roll.

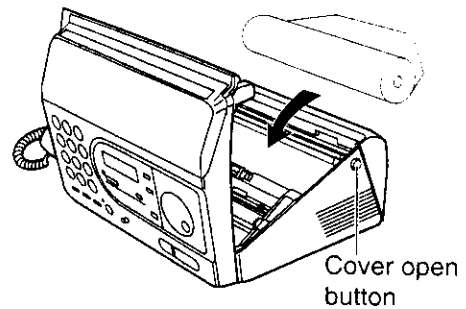

- 2** Insert the leading edge of the paper into the opening above the thermal head and pull it out of the unit.

- Make sure that there is no slack in the paper roll.

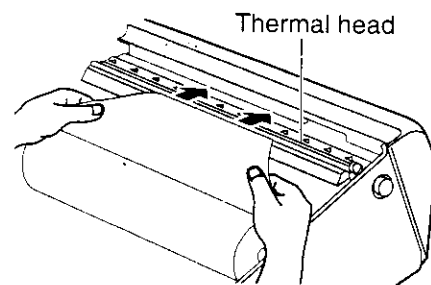

- 3** Close the cover securely by pushing down on both corners.

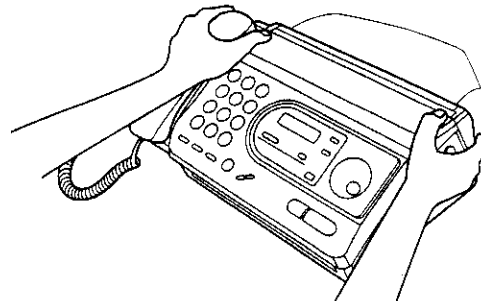

**Note:**

- Only use the included roll of paper or specified recording paper, or else the print quality may be affected and/or excessive thermal head wear may occur.
- To order recording paper, see page 5.
- When the power cord is connected, everytime you close the cover a message will be printed. If the recording paper is set to the wrong side, a message will not be printed. Install the paper correctly.

## Installing the paper stacker

Install the paper stacker.

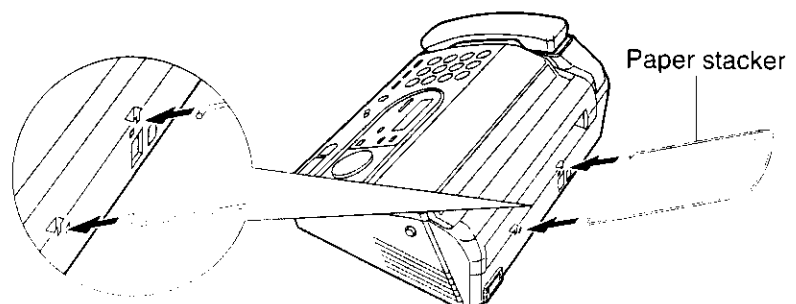



# Connections

- 1 Connect the handset cord.
- 2 Connect the telephone line cord.
- 3 Connect the power cord.

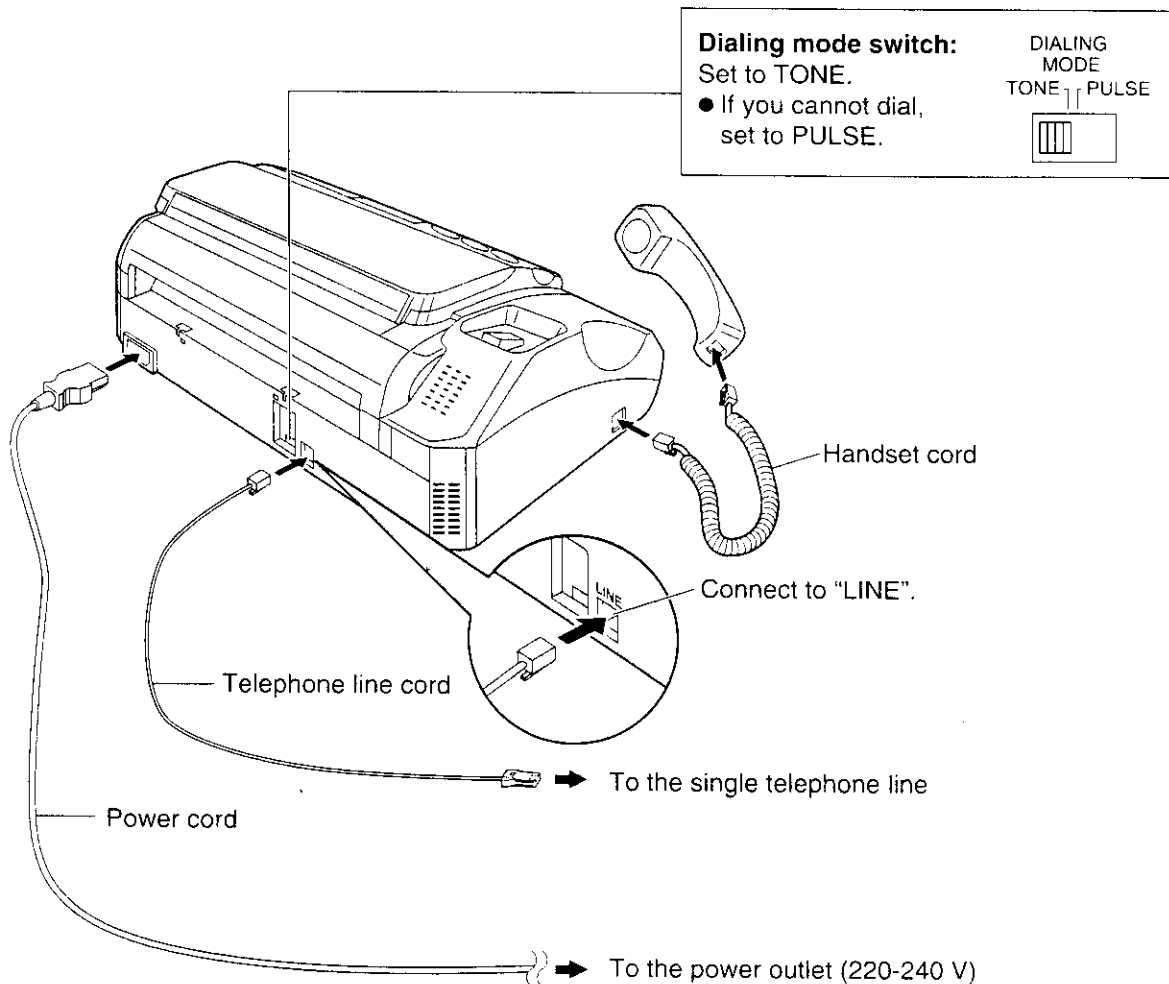

**Note:**

- When you operate this product, the power outlet should be near the product and easily accessible.
- This device is equipped with pulse dialling while the Telecom standard is DTMF tone dialling. There is no guarantee that Telecom lines will always continue to support pulse dialling.
- Use of pulse dialling, when this equipment is connected to the same line as other equipment, may give rise to bell tinkle or noise and may also cause a false answer condition. Should such problems occur, the user should NOT contact Telecom Faults Service.

# Programming the date and time, your name and facsimile telephone number

You can program the date and time, your logo and facsimile telephone number and this information will be printed on each page transmitted from your unit.

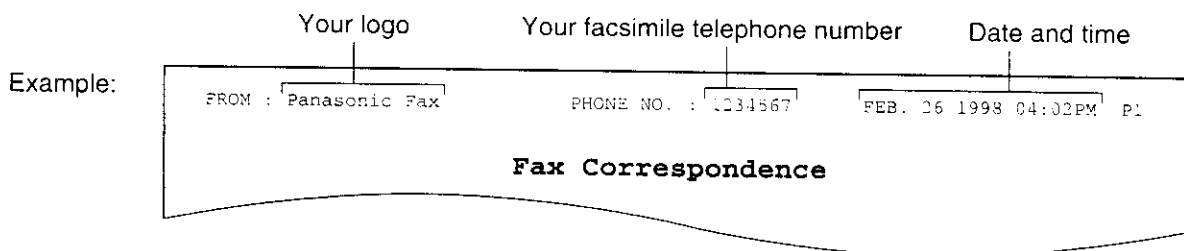

## Setting the date and time

**1** Press **MENU**.  
Display: 1.SYSTEM SET UP

**2** Press **□**, then **0 1**.  
SET DATE & TIME

**3** Press **START/COPY/SET**.  
M:01/D:01/Y:98  
Cursor

**4** Enter the correct month/day/year by selecting each 2 digits.

**Example:** Aug. 10, 1998

Press **0 8 1 0 9 8**.

M:08/D:10/Y:98

**5** Press **START/COPY/SET**.  
TIME: 12:00AM

**6** Enter the correct hour/minute by selecting each 2 digits. Press **\*** to select "AM" or "PM".

**Example:** 3:15PM

1. Press **0 3 1 5**.

TIME: 03:15AM

2. Press **\*** until "PM" is displayed.

TIME: 03:15PM

**7** Press **START/COPY/SET**.  
SETUP ITEM ( )

**8** Press **MENU**.

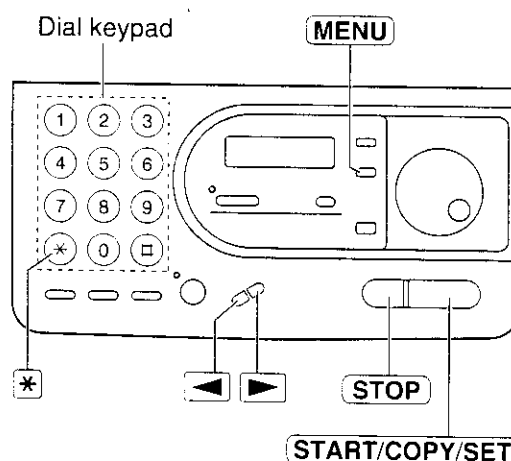

### Note:

- The **\*** key can be used to select "AM" or "PM" wherever the cursor is located.
- The accuracy of the clock will be approximately  $\pm 60$  seconds a month.
- This unit is year 2000 compliant.

### To correct a mistake

- Press **◀** or **▶** to move the cursor to the incorrect number, then make the correction.
- If you press **STOP** while programming, the display will return to the previous one.

## Setup

# Setting your logo

The logo can be your company, division or personal name.

**1** Press **MENU**.  
Display: 1.SYSTEM SET UP

**2** Press **□**, then **0 2**.  
YOUR LOGO

**3** Press **START/COPY/SET**.  
LOGO=

**4** Enter your logo, up to 30 characters, by following the instructions on the next page.

**Example** (using the dial keypad): Bill

1. Press **2** twice. LOGO=B  
Cursor

2. Press **4** six times. LOGO=Bil

3. Press **5** six times. LOGO=Billl

4. Press **▶** to move the cursor to the next space and press **5** six times.

LOGO=Billl

**5** Press **START/COPY/SET**.  
SETUP ITEM [ ]

**6** Press **MENU**.

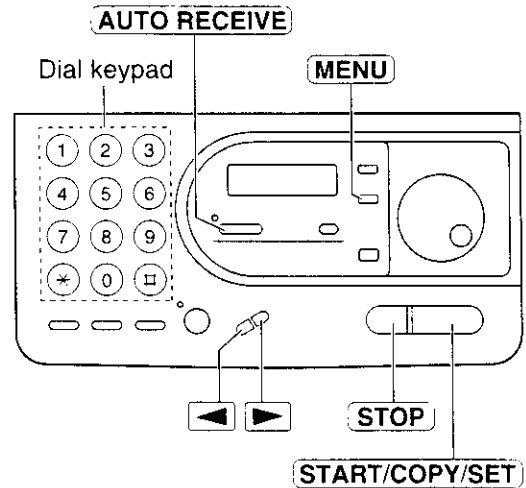

### To correct a mistake

- Press **◀** or **▶** to move the cursor to the incorrect character, then make the correction.

### To delete a character

- Move the cursor to the character you want to delete and press **STOP**.

### To insert a character

1. Press **◀** or **▶** to move the cursor to the position to the right of where you want to insert the character.
2. Press **AUTO RECEIVE** to insert a space and enter the character.

## Selecting characters with the dial keypad

Pressing the dial keys will select a character as shown below.

Keys	Characters
①	1 [ ] { } + - / = , . _ ` : ; ? !
②	A B C a b c 2
③	D E F d e f 3
④	G H I g h i 4
⑤	J K L j k l 5
⑥	M N O m n o 6
⑦	P Q R S p q r s 7
⑧	T U V t u v 8
⑨	W X Y Z w x y z 9
⑩	0 ( ) < > ! " # \$ % & ¥ * @ ^ ' →
<b>AUTO RECEIVE</b>	<b>Insert</b> key (Used to insert a space.)
<b>VOLUME</b> ▼	◀ key (Used to move the cursor to the left.)
<b>VOLUME</b> ▲	▶ key (Used to move the cursor to the right.) To enter the same number key continuously, move the cursor to the next space.

## Selecting characters with the EASY DIAL

Instead of pressing the dial keys, you can select characters using the EASY DIAL.

1. Rotate **EASY DIAL** until the desired character is displayed.
2. Press ▶ to move the cursor to the next space.
  - The character displayed in step 1 is inserted.
3. Return to step 1 to enter the next character.

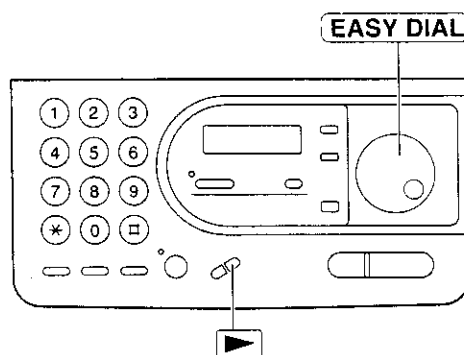

### Display order of characters

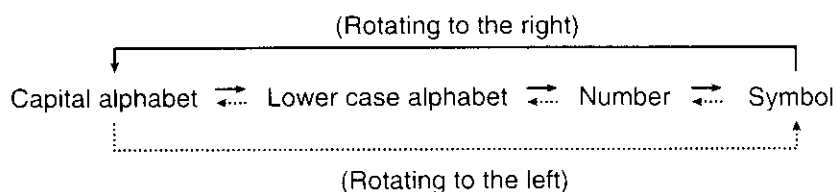

## Setup

### Setting your facsimile telephone number

---

- 1** Press **MENU**.  
Display: 1.SYSTEM SET UP
- 2** Press **□**, then **0** **3**.  
YOUR TEL NO.
- 3** Press **START/COPY/SET**.  
NO.=
- 4** Enter your facsimile telephone number up to 20 digits.  
Example: NO.=1234567
- 5** Press **START/COPY/SET**.  
SETUP ITEM [ ]
- 6** Press **MENU**.

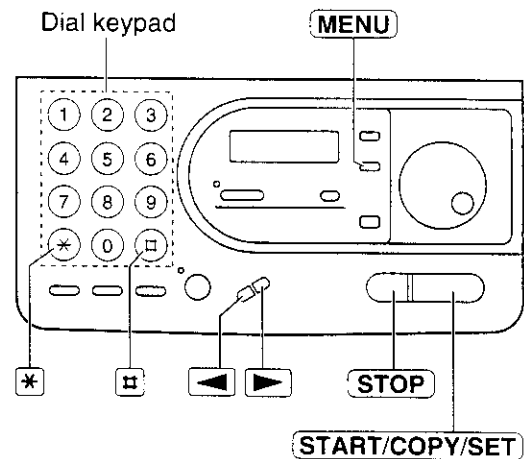

#### Note:

- The **□** button inserts a space and the **\*** button a "+".

Example: +64 9 1234567

Press **\*64□9□1234567**.

#### To correct a mistake



- Press **◀** or **▶** to move the cursor to the incorrect number, then make the correction.

#### To delete a number

- Move the cursor to the number you want to delete and press **STOP**.

# Adjusting volumes

## Ringer volume

4 levels (high/middle/low/off) are available.  
Press  or  while the unit is idle.

### ■ To turn the ringer off:

1. Press  repeatedly until the following message is displayed.

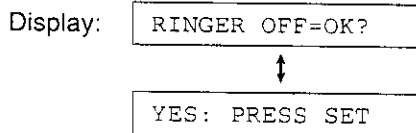

2. Press **START/COPY/SET**.

- To turn the ringer back on, press .

### ■ While the ringer volume is set to off:

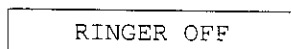

The display will flash the following message.



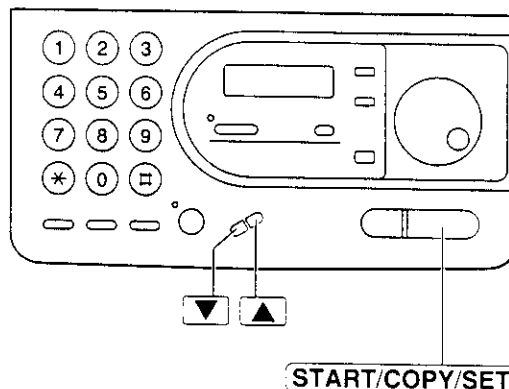
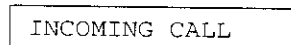

When receiving a call, the unit will not ring but will display the following.



## Handset receiver volume

3 levels (high to low) are available.  
Press  or  while using the handset.

## Monitor speaker volume

8 levels (high to low) are available.  
Press  or  while using the monitor.

## Making and Answering Calls

### Making a voice call manually

---

- 1 Press **MONITOR** or lift the handset.  
Display:
- 2 Dial the telephone number.  
Example: 
  - If you misdial, hang up and dial again.
- 3 When the other party answers, talk using the handset.
- 4 When finished, hang up the handset.

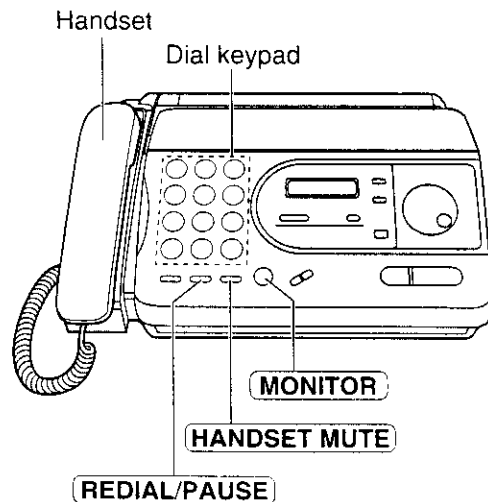

### To redial the last number

1. Press **MONITOR** or lift the handset.
2. Press **REDIAL/PAUSE**.
  - If the line is busy when using the **MONITOR** button, the unit will automatically redial the number up to 2 times.
  - While waiting for redial, the following will be displayed.

### Answering a voice call

---

- 1 When the unit rings, lift the handset.
- 2 When finished, hang up the handset.

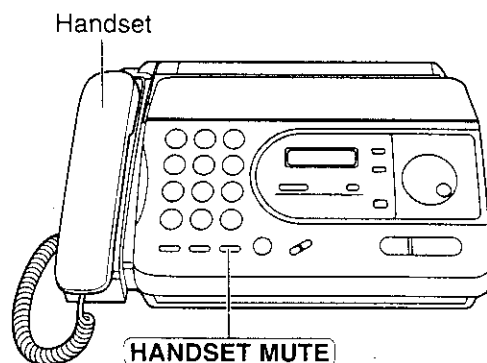

### Muting your voice to the other party

1. Press **HANDSET MUTE** during a telephone conversation with the handset.  
Display: 
  - The other party cannot hear you, but you can hear them.
2. To resume the conversation, press **HANDSET MUTE**.

## TONE, RECALL and PAUSE buttons

### TONE button

The **TONE** (\*) button is used for rotary pulse dial services and allows you to temporarily change from the pulse to tone mode during a dialing operation. When you hang up, the unit will automatically return to the pulse mode.

### RECALL button

The **RECALL** button functions as the hookswitch on a regular telephone. If you misdial a telephone number, press the **RECALL** button firmly.

The **RECALL** button also allows you to use special features of a host exchange (if connected) or local telephone company services such as call waiting. For further details, contact your host exchange supplier or local telephone company.

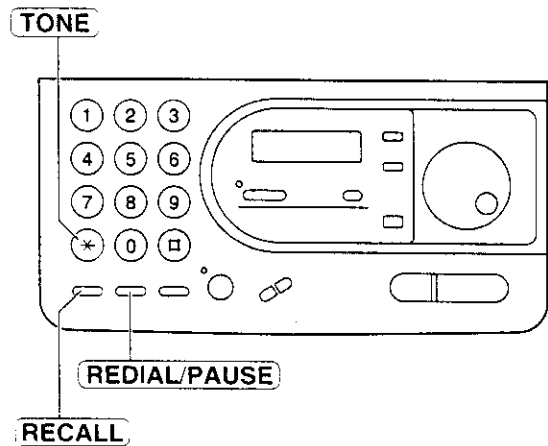

Telephone

### Entering pauses

When the **REDIAL/PAUSE** button is pressed during dialing, a pause will be inserted.

#### Example 1:

When your unit is connected to a host exchange, insert a pause before the telephone number to get an outside line.

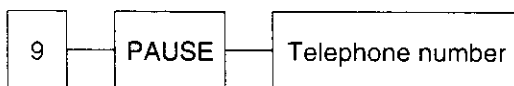

Line access code

#### Example 2:

If a transmission error occurs during an overseas transmission, add two pauses at the end of the telephone number.

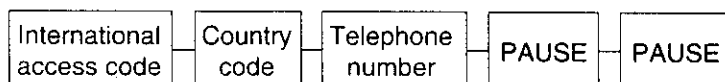

#### Note:

- TONE, RECALL and PAUSE can be stored into a telephone number in the EASY DIAL directory.



# EASY DIAL

## Storing names and telephone numbers in the EASY DIAL directory

You can store up to 100 names and telephone numbers for rapid access to frequently dialed numbers.

- 1** Press **DIRECTORY EDIT**.  
The number of entries available in the directory

Display:

- 2** Enter the name, up to 10 characters, by following the instructions on the next page.

Example:

- 3** Press **START/COPY/SET**.

- 4** Enter the telephone number up to 30 digits.

Example:

- 5** Press **START/COPY/SET**.

- To program other items, repeat steps 2 to 5.

- 6** Press **STOP** to exit the program.

### Note:

- To confirm the stored names and telephone numbers, print a telephone number list (see page 57).
- You can store items during a telephone conversation.
- After 95 items are stored, the following message will be displayed in step 5.

- By rotating **EASY DIAL** to the right, stored items can be displayed. The order is as follows: alphabet, number, symbol and telephone number (when a name is not stored).

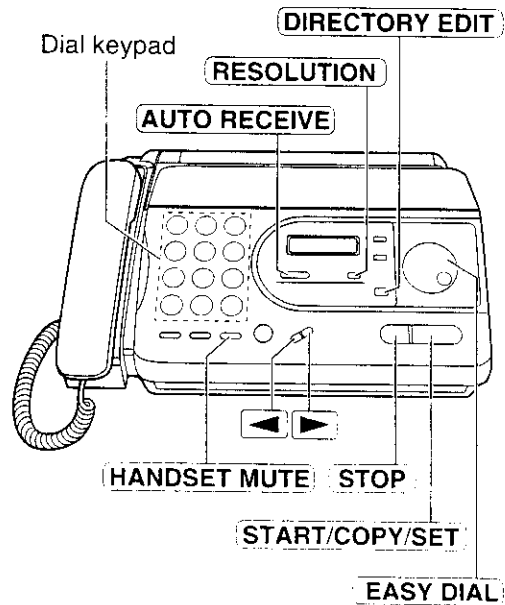

### To correct a mistake

- Press **◀** or **▶** to move the cursor to the incorrect character, then make the correction.

### To delete a character

- Move the cursor to the character you want to delete and press **STOP**.

### To keep the telephone number secret

Press **RESOLUTION** after entering the telephone number in step 4.

- The telephone number will not appear on the telephone number list.
- Pressing **RESOLUTION** does not count as a digit.

## Selecting characters with the dial keypad

Pressing the dial keys will select a character as shown below.

Keys	Characters
①	1 [ ] { } + - / = , . _ ` : ; ?
②	A B C a b c 2
③	D E F d e f 3
④	G H I g h i 4
⑤	J K L j k l 5
⑥	M N O m n o 6
⑦	P Q R S p q r s 7
⑧	T U V t u v 8
⑨	W X Y Z w x y z 9
⑩	0 ( ) < > ! " # \$ % & . ¥ * @ ^ ' →
<b>AUTO RECEIVE</b>	<b>Insert key</b> (Used to insert a space.)
<b>HANDSET MUTE</b>	<b>Hyphen key</b> (Used to insert a hyphen in the telephone number.)
<b>RESOLUTION</b>	<b>Secret key</b> (Used to keep the telephone number secret.)
<b>VOLUME ▼</b>	<b>◀ key</b> (Used to move the cursor to the left.)
<b>VOLUME ▲</b>	<b>▶ key</b> (Used to move the cursor to the right.) To enter the same number key continuously, move the cursor to the next space.

### Note:

- A hyphen or a space entered in a telephone number is counted as two digits.

## Selecting characters with the EASY DIAL

Instead of pressing the dial keys, you can select characters using the EASY DIAL.

1. Rotate **EASY DIAL** until the desired character is displayed.
2. Press **▶** to move the cursor to the next space.
  - The character displayed in step 1 is inserted.
3. Return to the step 1 to enter the next character.

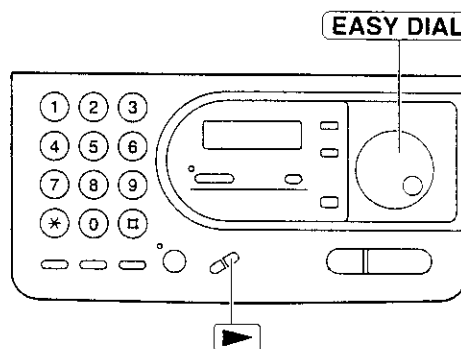

### Display order of characters

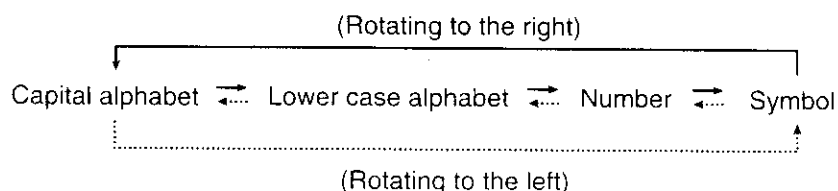

## EASY DIAL

### Editing a stored name and number

- 1 Rotate **EASY DIAL** until the desired name is displayed.  
Example:
- 2 Press **DIRECTORY EDIT**.
- 3 Press **\*** to select "EDIT".  
  - If you do not need to edit the name, skip to step 5.
- 4 Edit the name by following the instructions on page 27.
- 5 Press **START/COPY/SET**.  
Example: 
  - If you do not need to edit the telephone number, skip to step 7.
- 6 Edit the telephone number. For further details, see page 26.
- 7 Press **START/COPY/SET**.

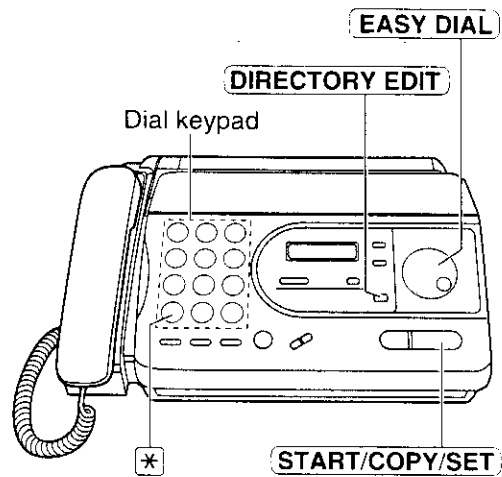

### Erasing a stored name and number

- 1 Rotate **EASY DIAL** until the desired name is displayed.  
Example:
- 2 Press **DIRECTORY EDIT**.
- 3 Press **#** to select "DELETE".  
  
↓  
  - If you do not want to erase the item, press **STOP**.
- 4 Press **START/COPY/SET**.  
  - The stored name and number are deleted.

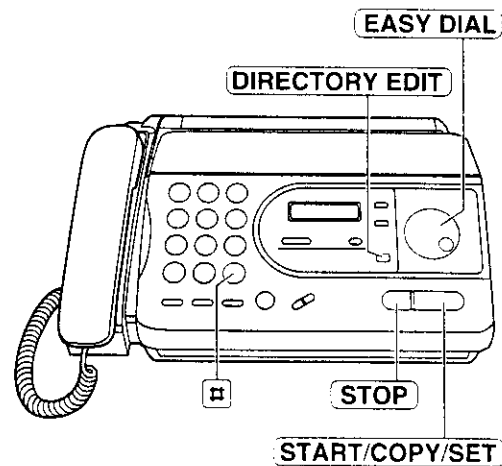

## Making a voice call using the EASY DIAL directory

- 1 Rotate **EASY DIAL** until the desired name is displayed.

Example:

- 2 Press **MONITOR** or lift the handset.
  - The unit will start dialing automatically.

- 3 When the other party answers, talk using the handset.

- 4 When finished, hang up the handset.

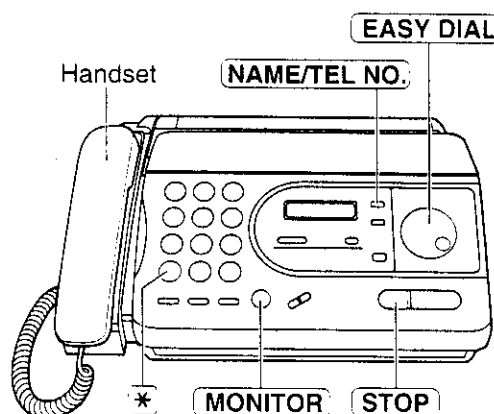

Telephone

### Note:

- If the desired name has not been stored, press **STOP** and dial the number manually. To store the name and number, see page 26.

## Searching for a name by the initial

**Example:** When you want to search for the name "Lisa"

1. Rotate **EASY DIAL** until any name is displayed.

Example:

2. Press **5** repeatedly until any name with the initial "L" is displayed (see the character table on page 27).

3. Rotate **EASY DIAL** to the right until "Lisa" is displayed.

- To stop the operation, press **STOP**.

4. Press **MONITOR** or lift the handset, and the unit will automatically dial the number.

### Note:

- When you want to search for symbols (not alphabet or numbers), press the \* key in step 2.

## Confirming a stored telephone number

1. Rotate **EASY DIAL** until the desired name is displayed.

Example:

2. Press **NAME/TEL NO.**

- To stop the operation, press **STOP**.

3. Press **MONITOR** or lift the handset, and the unit will automatically dial the number.

## Voice Contact

# Talking to the caller after fax transmission or reception

---

You can have a conversation with the same call after a fax message is completed. This will save the added expense and time of making another call.

**This feature only works when the other party's unit is equipped with a voice contact feature.**

## Initiating voice contact

---

- 1 Press **MONITOR** while transmitting or receiving documents.

Display: VOICE STANDBY

- Your unit will call the other party with a distinctive ring.
- When the other party answers, your unit will emit a distinctive ring.

- 2 Lift the handset to start talking.

### Note:

- If you initiate voice contact during transmission, the unit will call you with a distinctive ring after all of the documents have been transmitted.
- If you initiate voice contact during reception, the unit will call you with a distinctive ring after the current page of the document is received.

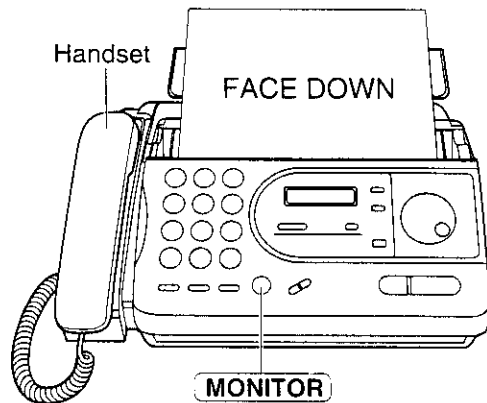

## Receiving a request for voice contact

---

- 1 Your unit will sound a distinctive ring after transmission or reception is completed.

- 2 Lift the handset to start talking.

### Note:

- If you do not answer within 10 seconds of the distinctive ring, the line will be automatically disconnected.

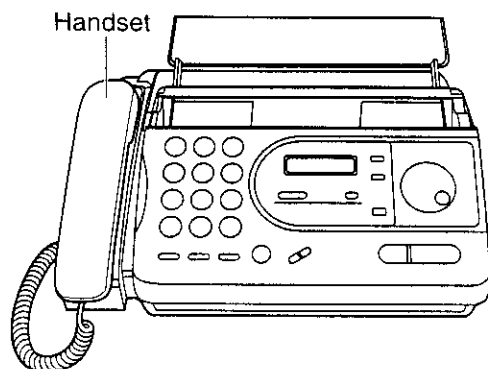

# Sending faxes manually

- 1 Open the document feeder tray.
- 2 Adjust the width of the document guides to the size of the document.
- 3 Insert the document **FACE DOWN** (up to 10 sheets) until a beep tone is heard.

Display: STANDARD

- 4 Press **RESOLUTION** repeatedly to select the desired setting, if necessary (see the bottom of this page).

- 5 Press **MONITOR** or lift the handset.

TEL=

- 6 Dial the fax number.

Example: TEL=5678901

- 7 **When a fax tone is heard, press **START/COPY/SET**, and hang up the handset if using it.**

CONNECTING

**Note:**

- If the other party answers your call, ask them to start receiving a fax, then press your **START/COPY/SET**.

## To feed 11 or more sheets at a time

Insert the first 10 sheets of the document. Add the extra sheets (up to 10) before the last sheet is fed into the unit.

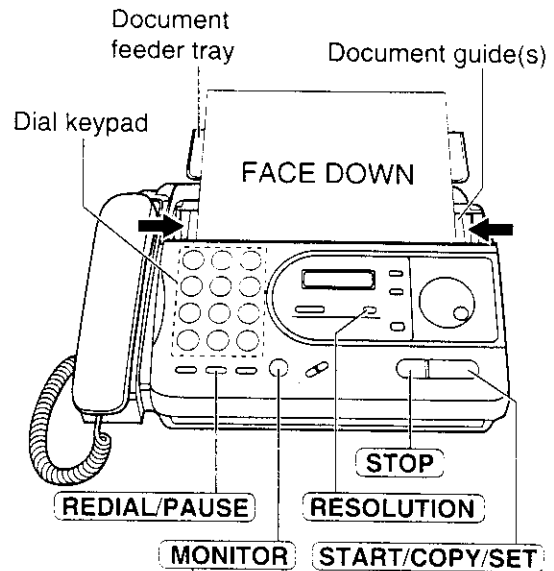

## To redial the last number

Press **REDIAL/PAUSE**.

- If the line is busy, the unit will automatically redial the number up to 2 times.
- While waiting for redial, the following will be displayed.

WAITING REDIAL

## To stop transmission

Press **STOP**.

To eject the document, press **STOP** again.

## Selecting the resolution

Select the desired resolution according to the type of document.

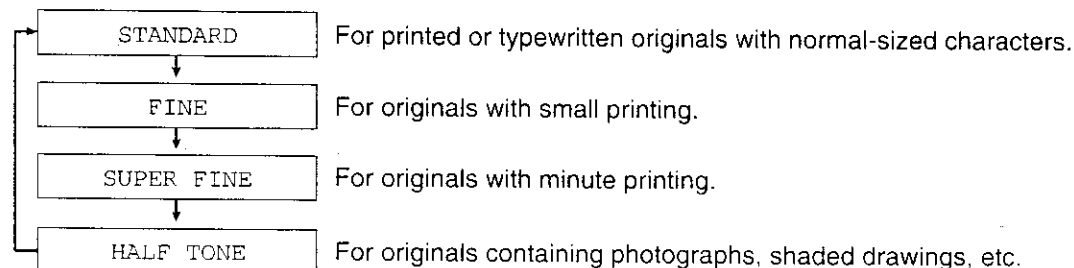

- Using the fine, super fine or half tone setting will increase the transmission time.
- If the resolution setting is changed during feeding, it will be effective from the next sheet.
- The super fine resolution only works with other compatible machines.

## Sending Faxes

# Sending faxes using the EASY DIAL directory

Before using this feature, program the desired names and telephone numbers into the directory (see page 26). To confirm the items stored in the directory, print a telephone number list (see page 57).

- 1 Open the document feeder tray.
- 2 Adjust the width of the document guides to the size of the document.
- 3 Insert the document FACE DOWN (up to 10 sheets) until a beep tone is heard.

Display:

- 4 Press **RESOLUTION** repeatedly to select the desired setting, if necessary (see the bottom of page 31).

- 5 Rotate **EASY DIAL** until the desired name is displayed.

Example:

- 6 Press **START/COPY/SET**.

Example:

↓

- The unit will start transmission.

### Note:

- If the desired name has not been stored, press **STOP** and dial the number manually. To store the name, see page 26.
- For further details about using the EASY DIAL, see page 29.

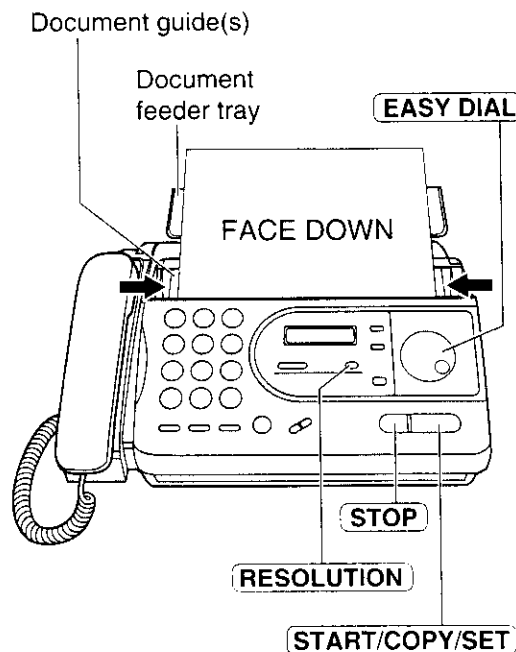

## Fax auto redial

If the line is busy or there is no answer, the unit will automatically redial the number up to 2 times.

- This feature is also available for;
  - delayed transmission (page 36).
  - receive polling (page 47).
- While waiting for redial, the following will be displayed.

Display:

- To cancel redialing, press **STOP**.

## Documents you can send

### Minimum size

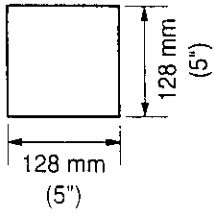

### Maximum size

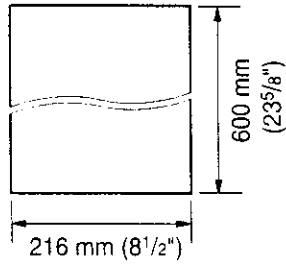

### Effective scanning area

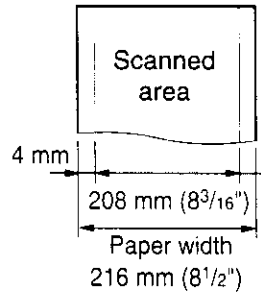

### Document weight

Single sheet:  
45 to 90 g/m<sup>2</sup> (12 to 24 lb.)

Multiple sheets:  
60 to 75 g/m<sup>2</sup> (16 to 20 lb.)

### Note:

- Remove clips, staples or other similar fastening objects.
- Check that ink, paste or correction fluid has dried.
- Do not send the following types of documents. Use copies for fax transmission.
  - Chemically treated paper such as carbon or carbonless duplicating paper
  - Electrostatically charged paper
  - Heavily curled, creased or torn paper
  - Paper with a coated surface
  - Paper with a faint image
  - Paper with printing on the opposite side that can be seen through the front (e.g. newspaper)



# Printing the transmission report

The transmission report will provide you with a printed record of the fax transmission result. One of the following choices is available.

- ERROR:** The transmission report will print out only when fax transmission fails (pre-selected setting).
- ON:** The transmission report will always print out, indicating whether fax transmission is successful or not.
- OFF:** The transmission report will not print.

- 1 Press **MENU**.  
Display: 1.SYSTEM SET UP
- 2 Press **0 4**.  
TX-REPORT MODE
- 3 Press **START/COPY/SET**.  
MODE=ERROR ▼▲
- 4 Press ▼ or ▲ to select the desired setting.
- 5 Press **START/COPY/SET**.  
SETUP ITEM [ ]
- 6 Press **MENU**.

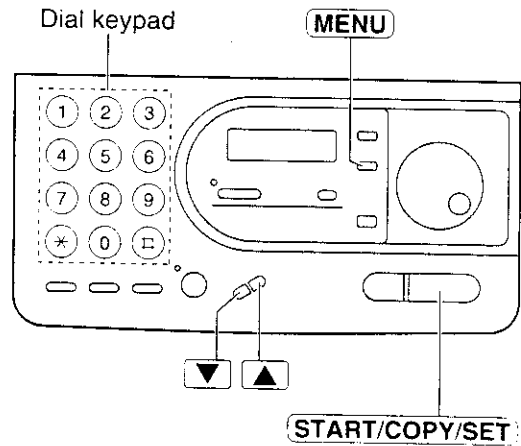

## Sample of a transmission report

[ TRANSMISSION REPORT ]						
JAN. 20 1998 01:19PM						
NO.	OTHER FACSIMILE	START TIME	USAGE TIME	MODE	PAGES	RESULT
01	2345678	JAN. 20 01:18PM	00:51	SND	00	COMMUNICATION ERROR (65)

Communication message  
(See page 50.)

Error code (for service personnel use only)

# Setting the journal report to print automatically

This feature prints a journal report automatically after every 35 new fax communications. After printing, only the oldest communication result will be erased when a new communication occurs. When this feature is deactivated, the unit will store the records of the fax communications, but will not print the journal report automatically.

- 1 Press **MENU**.  
Display: 1.SYSTEM SET UP
- 2 Press **□**, then **2** **2**.  
AUTO JOURNAL
- 3 Press **START/COPY/SET**.  
MODE=ON ▼▲
- 4 Press ▼ or ▲ to select the desired setting.  
• If this feature is not required, select "OFF".
- 5 Press **START/COPY/SET**.  
SETUP ITEM [ ]
- 6 Press **MENU**.

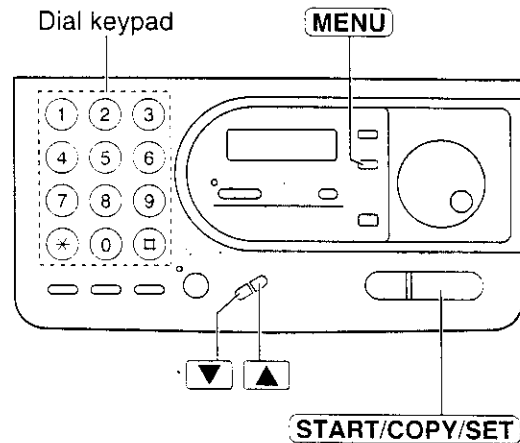

Fax/Copy

## Sample of a journal report

[ JOURNAL ]							
JAN. 25 1998 05:22PM							
NO.	OTHER FACSIMILE	START TIME	USAGE TIME	MODE	PAGES	RESULT	*CODE
01	3332222	JAN. 21 02:14PM	00'45	SND	01	OK	
02	9998765	JAN. 21 03:17PM	00'58	SND	02	OK	
03	2121444	JAN. 21 05:18PM	00'48	RCV	01	OK	
04	55556677	JAN. 22 10:35AM	02'45	SND	03	COMMUNICATION ERROR	(65)
05			02'50	SND	05	OK	
				RCV	03	OK	

Communication message  
(See page 50.)

Error code (for service personnel use only)

# Delayed transmission --- ---

## (sending a fax at a specific time)

Using a built-in clock, this unit can send documents automatically at a specific time. This allows you to take advantage of low-cost calling hours offered by your telephone company. The delayed transmission can be reserved to take place up to 24 hours in advance.

**1** Insert the document **FACE DOWN**.

Display: STANDARD

**2** Press **MENU**.

1.SYSTEM SET UP

**3** Press **[ ]**, then **[2][5]**.

DELAYED SEND

**4** Press **START/COPY/SET**.

MODE=OFF ▼▲

**5** Press **▼** or **▲** to select "ON".

MODE=ON ▼▲

• If this feature is not required, select "OFF".

**6** Press **START/COPY/SET**.

NO. =

**7** Enter the fax number.

**8** Press **START/COPY/SET**.

\*TIME=12:00AM

**9** Enter the transmission start time.

**Example:** 11:30PM

Press **[1][1][3][0]**, then press **[\*]** to select "PM" (or "AM").

TIME=11:30PM

**10** Press **START/COPY/SET**.

SETUP ITEM [ ]

**11** Press **MENU**.

SEND AT 11:30PM

• When the programmed time has come, the unit will automatically start transmission.

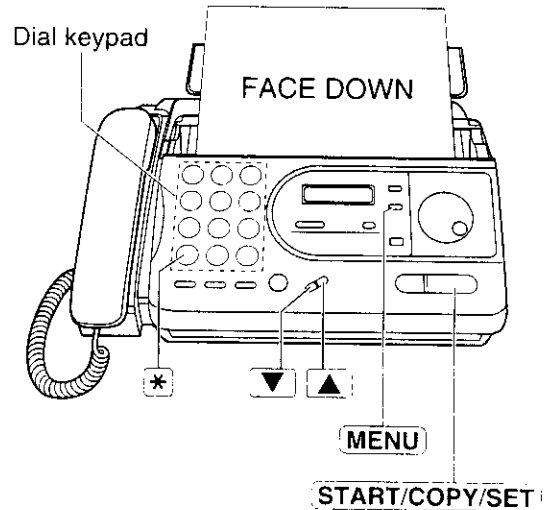

**Note:**

- You can receive, transmit and copy documents while delayed transmission is set.
- When transmit polling (see page 37) is set to "ON", delayed transmission is not available.
- You cannot use the EASY DIAL directory to enter the fax number for this feature.

## Sending documents overseas

You may experience difficulty when transmitting documents overseas. This feature makes sending documents easier as the transmission speed is slowed down. Before starting transmission, follow the steps below.

- 1 Press **MENU**.  
Display: 1. SYSTEM SET UP
- 2 Press **□**, then **2 3**.  
OVERSEAS MODE
- 3 Press **START/COPY/SET**.  
MODE=OFF ▼▲
- 4 Press ▼ or ▲ to select "ON".  
MODE=ON ▼▲
- If this feature is not required, select "OFF".
- 5 Press **START/COPY/SET**.  
SETUP ITEM [ ]
- 6 Press **MENU**.

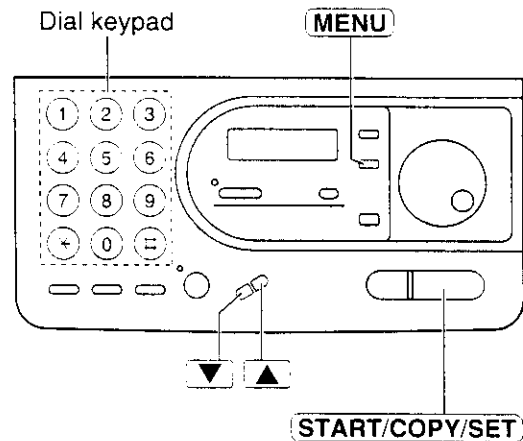

**Note:**

- After transmission, this feature will turn off automatically.

Fax/Copy

## Transmit polling

(letting another machine retrieve a fax on your unit)

This feature allows another person to call your unit to retrieve a document loaded on your unit. This saves you the call charges. This feature will not work when the unit is set to the TEL mode.

- 1 Insert the document FACE DOWN.  
Display: STANDARD
- 2 Press **MENU** four times.  
4. POLLED  
↓  
YES: PRESS SET
- 3 Press **START/COPY/SET**.  
MODE=OFF ▼▲
- 4 Press ▼ or ▲ to select "ON".  
MODE=ON ▼▲
- If this feature is not required, select "OFF".
- 5 Press **START/COPY/SET**.  
POLLED ON

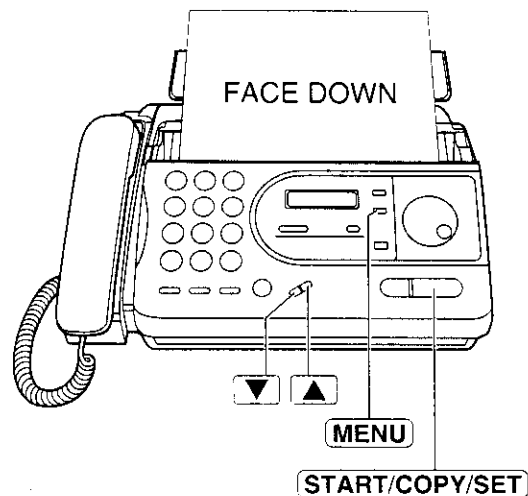

**Note:**

- The caller pays for the document transmission.
- When delayed transmission (see page 36) is set to "ON", transmit polling is not available.

## Selecting the way to receive calls

This unit has three types of receive modes. Select one of these modes according to your needs.

- Regardless of the mode you select, you can always place calls and send faxes.

### MANUAL RECEIVE

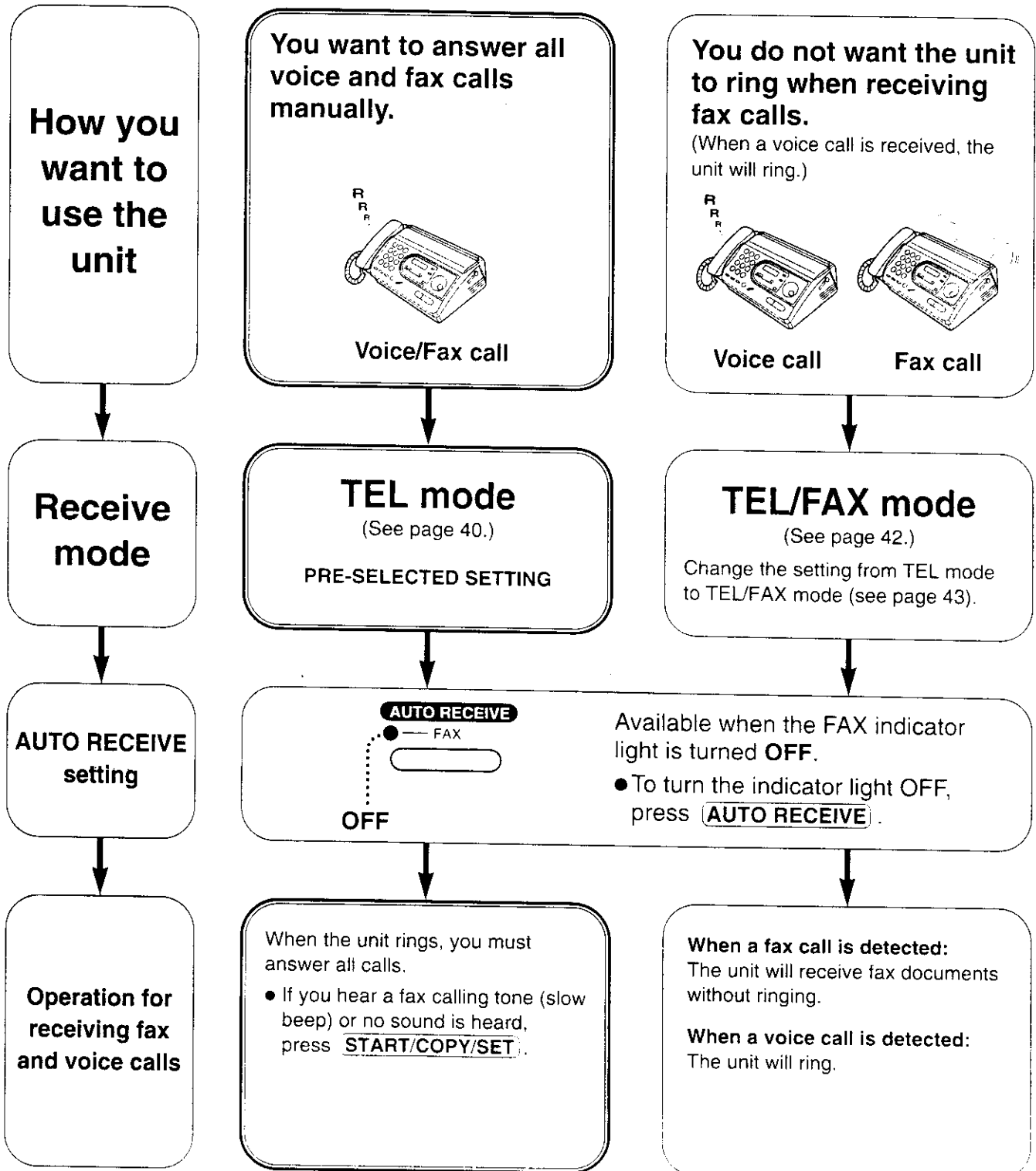

## AUTO RECEIVE

You want to receive fax documents only.

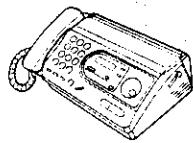

Fax call only

**FAX ONLY mode**

(See page 41.)

**AUTO RECEIVE**

○ — FAX

ON

Available when the FAX indicator light is turned **ON**.

- To turn the indicator light **ON**, press **AUTO RECEIVE**.

The unit will automatically answer all calls and only receive fax documents.

## TEL/FAX mode

(receiving voice calls with rings and fax calls without rings)

Use this mode when you wish to receive voice calls with rings, but do not want the unit to ring when faxes are received.

When a call is received, the unit will work as follows.

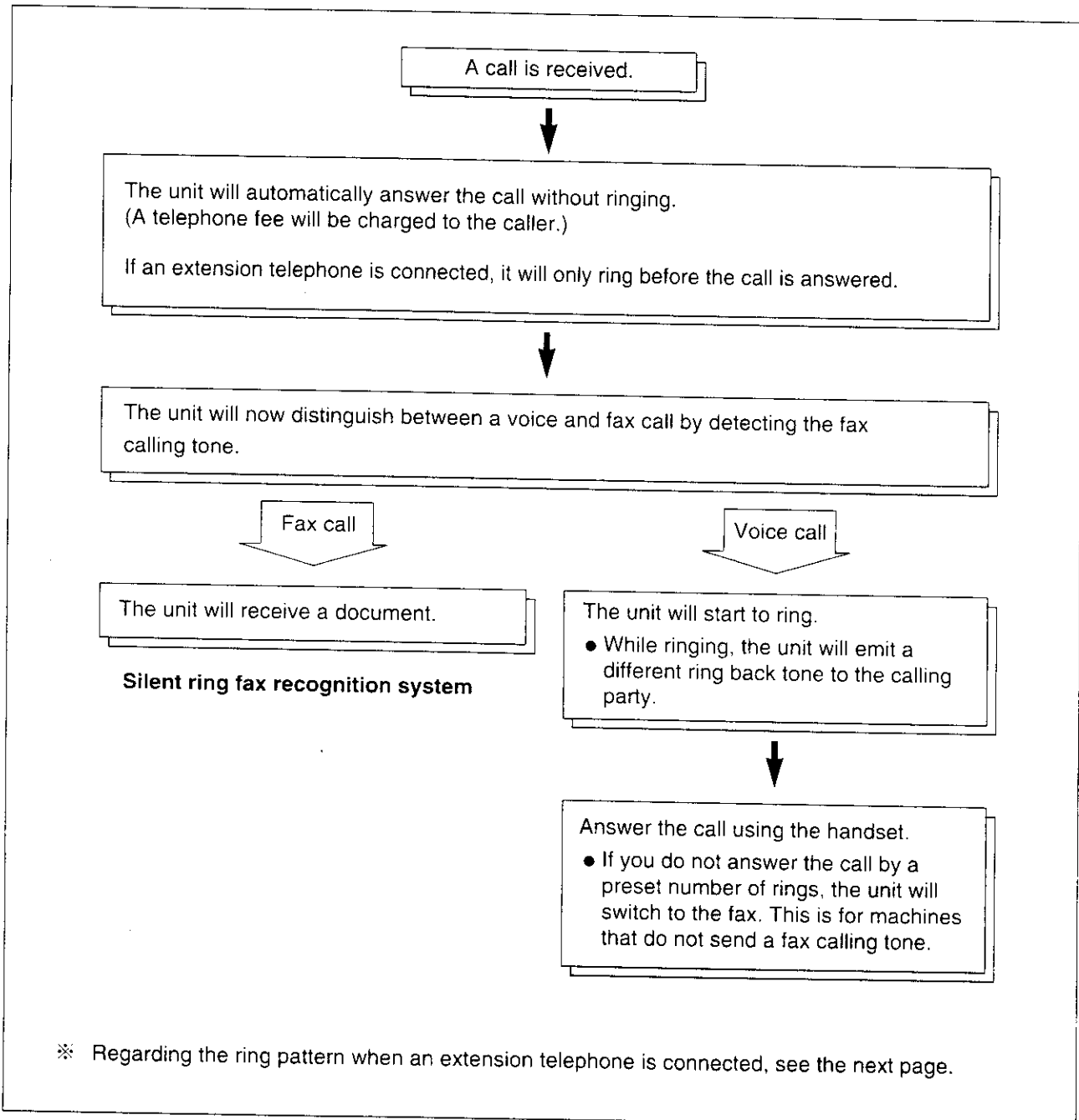

※ Regarding the ring pattern when an extension telephone is connected, see the next page.

**Note:**

- Some fax messages that are transmitted manually may not send a fax calling tone. These calls must be received manually.

## Ring pattern when an extension telephone is connected \_\_\_\_\_

When an extension telephone is connected, it will ring as follows.

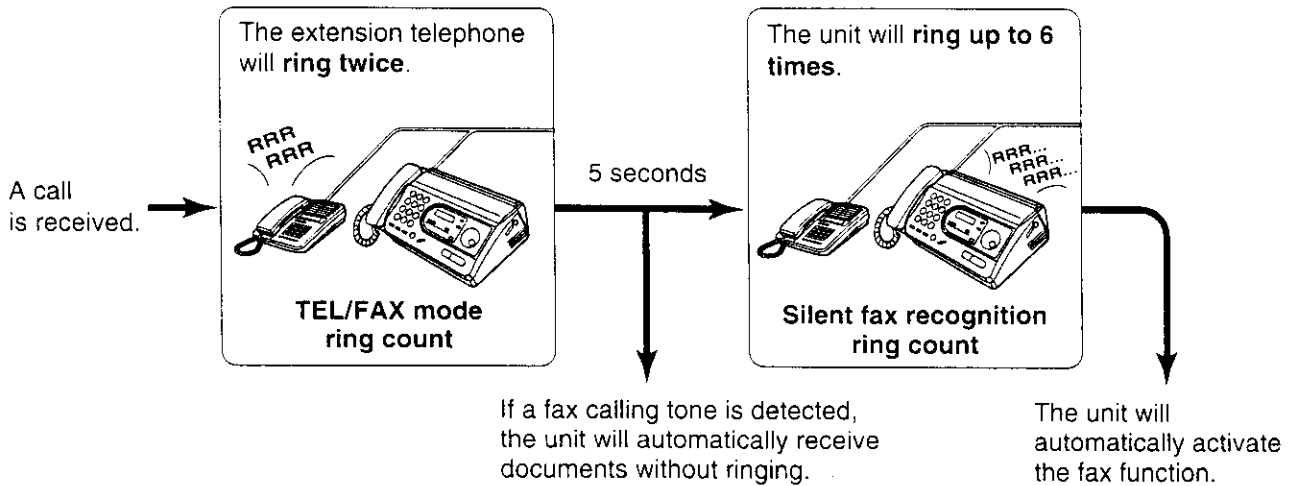

**Note:**

- You can change the **TEL/FAX mode ring count** and **silent fax recognition ring count** (see page 44).
- The unit will display the following when the extension telephone starts to ring.

INCOMING CALL

Fax/Copy

## Changing the TEL mode to the TEL/FAX mode \_\_\_\_\_

Change the MANUAL RECEIVE setting from the TEL mode to the TEL/FAX mode.

- 1 Press **MENU**.  
Display: 1. SYSTEM SET UP
- 2 Press **□**, then **0 8**.  
MANUAL RECEIVE
- 3 Press **START/COPY/SET**.  
MODE=TEL ▼▲
- 4 Press ▼ or ▲ to select "TEL/FAX".  
MODE=TEL/FAX ▼▲
- 5 Press **START/COPY/SET**.  
SETUP ITEM [ ]
- 6 Press **MENU**.
- 7 If the FAX indicator light is on, turn it off by pressing **AUTO RECEIVE**.  
TEL/FAX MODE

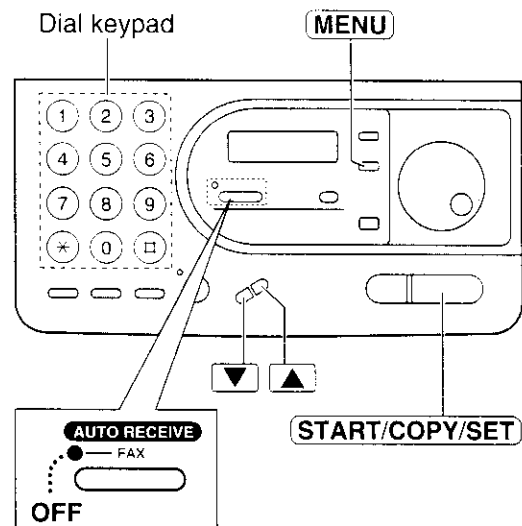

**Note:**

- To return to the TEL mode, select "TEL" in step 4.



## Receiving Faxes

### Setting the TEL/FAX mode ring count

This setting determines the number of the extension telephone rings in the TEL/FAX mode. You can choose from 2 to 9 rings.

When an extension telephone is not connected, changing this setting is not necessary.

- 1 Press **MENU**.  
Display: 1.SYSTEM SET UP
- 2 Press **#**, then **0 9**.  
TEL/FAX RING
- 3 Press **START/COPY/SET**.  
RING=2 ▼▲
- 4 Press ▼ or ▲ to select the desired number.
- 5 Press **START/COPY/SET**.  
SETUP ITEM [ ]
- 6 Press **MENU**.

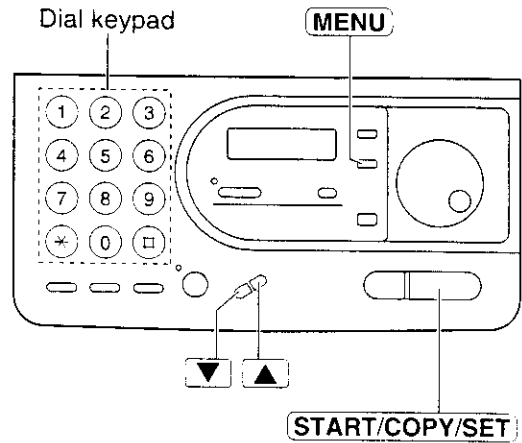

**Note:**

- If the number of rings is increased, you may not be able to receive documents from some older model facsimiles which do not send a fax calling tone.

### Setting the silent fax recognition ring count

When the unit detects a voice call in the TEL/FAX mode, it will ring up to 6 times. The number of rings can be changed up to 9. If a voice call is not answered within the selected number of rings (3 to 9 rings), the unit will automatically start to receive a fax.

- 1 Press **MENU**.  
Display: 1.SYSTEM SET UP
- 2 Press **#**, then **3 0**.  
SILENT FAX RING
- 3 Press **START/COPY/SET**.  
RING=6 ▼▲
- 4 Press ▼ or ▲ to select the desired number.
- 5 Press **START/COPY/SET**.  
SETUP ITEM [ ]
- 6 Press **MENU**.

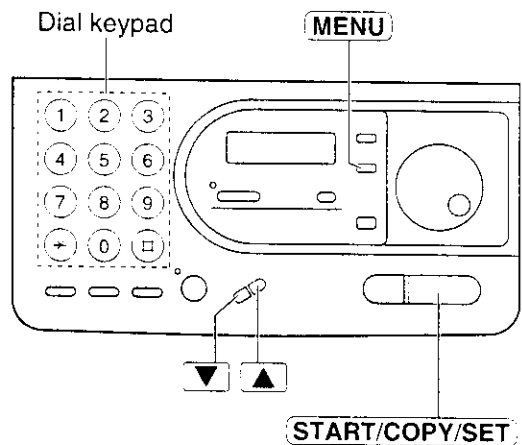

**Note:**

- If the number of rings is increased, you may not be able to receive documents from some older model facsimiles which do not send a fax calling tone.

## Distinctive ring service (FaxAbility)

### Note for users in New Zealand:

Telecom has called this service "FaxAbility".

This feature is only for use if you subscribe to a distinctive ring pattern service from their telephone company. For more information on the availability of this service in your area, please contact your telephone company **before** setting this feature on your unit.

The distinctive ring service gives you an additional phone number on a single telephone line, with a different ringing pattern.

When you wish to use the additional phone number as a facsimile telephone number, set the ring pattern detection feature to ON. When the unit detects a call matching the distinctive ring pattern, the unit will automatically activate depending on the receive mode setting.

To use this feature properly, set the unit to the TEL/FAX mode (see page 43).

## Setting the ring pattern detection

- 1 Press **MENU**.  
Display: 1. SYSTEM SET UP
- 2 Press **□**, then **3 1**.  
RING DETECTION
- 3 Press **START/COPY/SET**.  
MODE=OFF ▼▲
- 4 Press ▼ or ▲ to select "ON".  
• If this feature is not required, select "OFF".
- 5 Press **START/COPY/SET**.  
PRINTING  
• The unit will print an information list.  
SETUP ITEM [ ]
- 6 Press **MENU**.

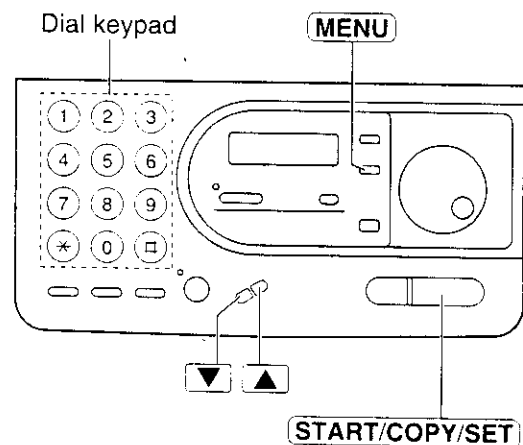

Fax/Copy

## How the unit will answer in each receive mode

**TEL/FAX mode:** When a distinctive ring pattern is detected, the unit will automatically answer the call without ringing and activate the fax function.

When a standard ring pattern is received, the unit will ring until you answer the call.

**TEL mode:** You have to answer all calls manually.

If a fax calling tone (slow beep) is heard or no sound is heard, press **START/COPY/SET** to receive documents.

**FAX ONLY mode:** The unit will answer all calls automatically and activate the fax function.

### Note:

- In the FAX ONLY mode, the unit automatically answers a distinctive ring call after the second ring. To change the number of rings, change the FAX ONLY mode ring count (see page 41) after setting the ring pattern detection.

## Receiving Faxes

# Receiving faxes using an extension telephone

When you connect an extension telephone on the same line, you can receive fax documents using the extension telephone. You do not have to go to the unit and press **START/COPY/SET**.

### Important:

- Use a touch tone telephone as the extension telephone and enter the fax activation code **firmly**.

- 1** When the extension telephone rings, lift the handset of the extension telephone.
- 2** When:
  - document reception is required,
  - a fax calling tone (slow beep) is heard, or
  - no sound is heard,press **\* 9** (pre-selected fax activation code) **firmly**.
- 3** Hang up the handset.
  - The unit will start reception.

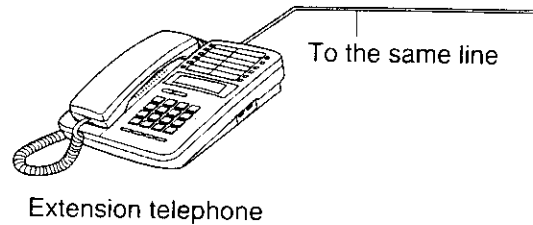

### Note:

- You can change the fax activation code (see below).

# Changing the fax activation code

The fax activation code is used when receiving faxes using an extension telephone (see above).

- 1** Press **MENU**.  
Display: 1. SYSTEM SET UP
- 2** Press **□**, then **4 1**.  
FAX ACTIVATION
- 3** Press **START/COPY/SET**.  
MODE=ON ▼▲
- 4** Press ▼ or ▲ to select the desired setting.
  - If this feature is not required, select "OFF".
- 5** Press **START/COPY/SET**.  
CODE= \* 9
  - The display will show the pre-selected code.
- 6** Enter the new code number.
  - This code can be from 2 to 4 digits in length using 0 - 9 and \*.
- 7** Press **START/COPY/SET**.  
SETUP ITEM [ ]
- 8** Press **MENU**.

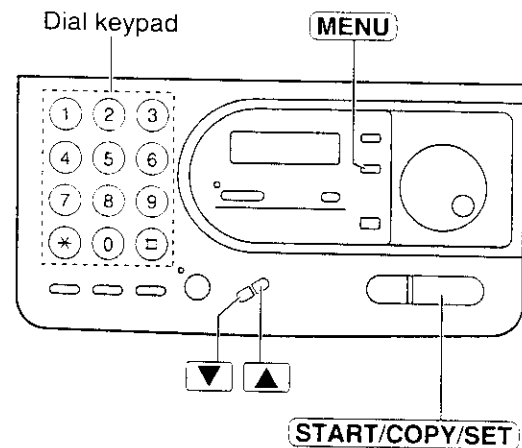

### Note:

- If you subscribe to some special telephone company services, all or part of the fax activation code must be different from the service access code.
- The fax activation code should not be set to "0000".

## Receive polling --- --- (retrieving faxes placed on another party's machine)

This feature allows you to retrieve a document from another compatible machine. Therefore, you pay for the call, saving the sending party the call charges.

Make sure that no documents are fed into your unit and that the other party's machine is ready for your call.

- 1** Press **MENU** three times.

Display: 3 . POLLING  
↓  
YES: PRESS SET

- 2** Press **START/COPY/SET**.

NO. =

- 3** Dial the fax number.

Example: NO. = 3331111

- 4** Press **START/COPY/SET**.

CONNECTING

- The unit will start reception.

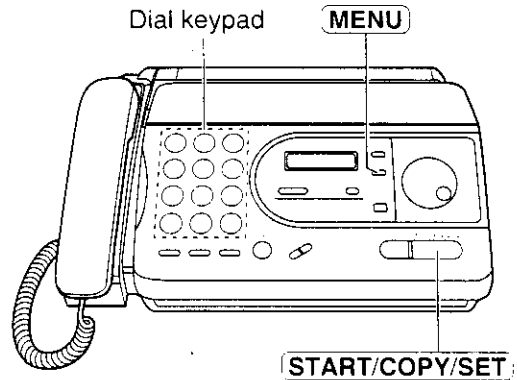

**Note:**

- You cannot use the EASY DIAL directory to enter the fax number for this feature.

Fax/Copy

## Setting the friendly reception --- ---

The friendly reception feature allows you to receive fax documents automatically without pressing **START/COPY/SET** (see page 40).

When this feature is deactivated, you will have to press **START/COPY/SET** to receive fax documents each time you answer a fax call.

- 1** Press **MENU**.

Display: 1 . SYSTEM SET UP

- 2** Press **4**, then **6**.

FRIENDLY RCV

- 3** Press **START/COPY/SET**.

MODE=ON ▼▲

- 4** Press ▼ or ▲ to select the desired setting.

- If this feature is not required, select "OFF".

- 5** Press **START/COPY/SET**.

SETUP ITEM [ ]

- 6** Press **MENU**.

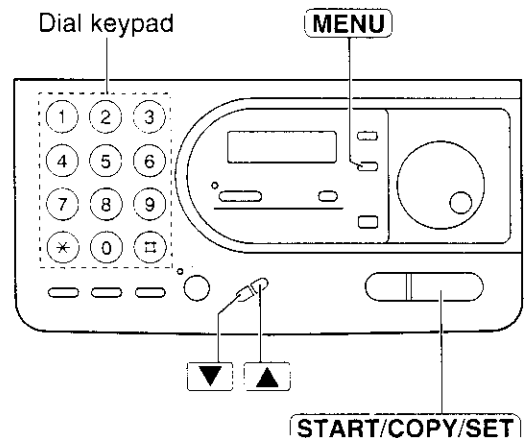

## Receiving Faxes

# Signaling your pager when your unit receives a fax

This feature allows your unit to call your pager when your unit receives a fax document.

**1** Press **MENU**.  
Display: 1.SYSTEM SET UP

**2** Press **Ⓜ**, then **7 0**.  
FAX PAGER

**3** Press **START/COPY/SET**.  
MODE=OFF ▼▲

**4** Press ▼ or ▲ to select "ON".  
MODE=ON ▼▲

- If this feature is not required, select "OFF".

**5** Press **START/COPY/SET**.  
NO. =

**6** Enter your pager number.  
• You can enter a total of 46 digits and/or pauses.  
Example: NO. =1122333

**7** Press **START/COPY/SET**.  
SETUP ITEM [ ]

**8** Press **MENU**.

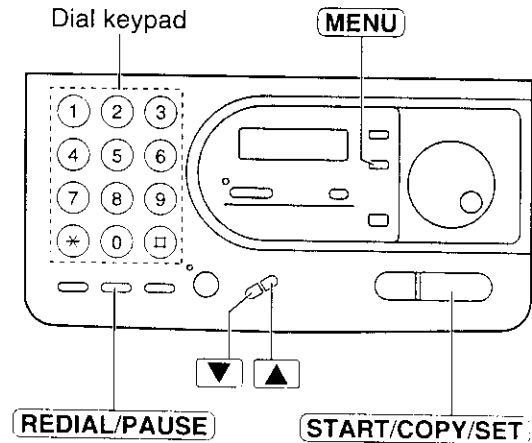

### Note:

- If this feature does not work properly, enter more than one pause by pressing **REDIAL/PAUSE** at the end of your pager number to extend the paging time.
- If you wish to display a message on your pager, enter your pager number, pause(s) and the message.
- Message programming methods may vary depending on the pager company. Contact your pager company for details.

## Making a copy

Any transmittable document (see page 33) can be copied.

- 1 Open the document feeder tray.
- 2 Adjust the width of the document guides to the size of the document.
- 3 Insert the document (up to 10 sheets) FACE DOWN until a beep tone is heard.

Display: STANDARD

- 4 Press **RESOLUTION** repeatedly to select the desired setting, if necessary (see the bottom of page 31).

- 5 Press **START/COPY/SET**.
  - The unit will start printing.

COPYING

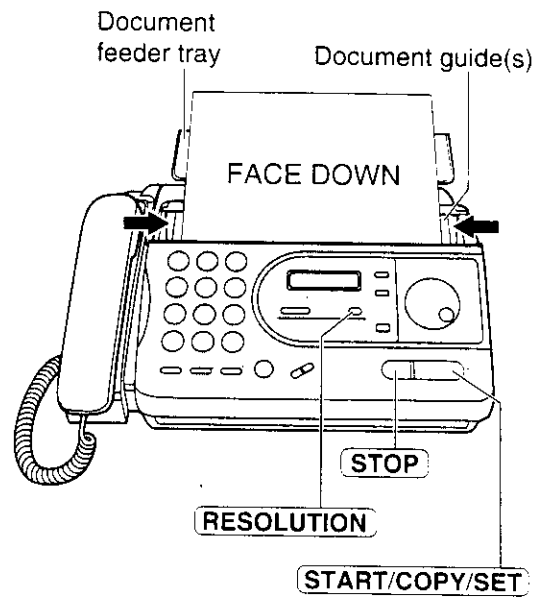

Fax/Copy

### Note:

- When you copy a multiple page document which is longer than A4 size paper (approx. 300 mm), we recommend to insert the pages one at a time.
- If a resolution is not set, FINE resolution will automatically be selected.
- You can make or receive a voice call while making a copy.

### To stop copying

Press **STOP**.

To eject the document, press **STOP** again.

## Error Messages

### Error messages on printed reports

When a problem has occurred, one of the following messages will be printed on the transmission and journal reports (see pages 34 and 35).

Communication message	Error code	Cause & Remedy
COMMUNICATION ERROR	41-72 FF	● A transmission or reception error occurred. Try again or check with the other party.
DOCUMENT JAMMED	—	● The document is jammed. Remove the jammed document (p. 55).
ERROR-NOT YOUR UNIT	53, 54 59, 70	● A transmission or reception error occurred because of a problem with the other party's machine. Check with the other party.
NO DOCUMENT	—	● The document was not fed into the unit properly. Reinsert the document and try again.
OTHER FAX NOT RESPOND	—	<ul style="list-style-type: none"><li>● The other party's machine was busy or ran out of recording paper. Try again.</li><li>● The document was not fed properly. Reinsert the document and try again.</li><li>● The other party's machine rings too many times. To send a fax manually, dial the number, confirm the fax tone, and press <b>START/COPY/SET</b>.</li><li>● The other party's machine is not a facsimile. Check with the other party.</li></ul>
PAPER JAMMED	—	● The recording paper is jammed. Clear the jammed paper (p. 54).
PAPER OUT	—	● The unit ran out of recording paper. Install a recording paper roll (p. 17).
PRESSED THE STOP KEY	—	● The <b>STOP</b> button was pressed and fax communication was canceled.
PRINTER OVERHEATED	—	● The printer overheated. Let the unit cool down.
THE COVER WAS OPENED	—	● The cover was opened. Close it and try again.
OK	—	● Fax communication was successful.

## Error messages on the LCD display

If the unit detects a problem, one or more of the following messages will appear on the display.

Display message	Cause & Remedy
CALL SERVICE	<ul style="list-style-type: none"> <li>There is something wrong with the unit. Contact your service personnel.</li> </ul>
CHECK COVER	<ul style="list-style-type: none"> <li>The cover is open. Close it.</li> </ul>
CHECK DOCUMENT	<ul style="list-style-type: none"> <li>The document is not fed into the unit properly. Reinsert the document and try again. If misfeeding occurs frequently, clean the document feeder rollers (p. 56). If the problem remains, adjust the feeder pressure (p. 55).</li> <li>Attempted to transmit a document longer than 600 mm (23<sup>5</sup>/<sub>8</sub>" ). Press the <b>STOP</b> button to remove the document. Divide the document into two or more sheets and try again.</li> </ul>
CHECK MEMORY	<ul style="list-style-type: none"> <li>Memory (telephone numbers, parameters, etc.) has been erased. Re-program.</li> </ul>
NO RESPONSE	<ul style="list-style-type: none"> <li>The other party's machine is busy or ran out of recording paper. Try again.</li> </ul>
OUT OF PAPER	<ul style="list-style-type: none"> <li>The unit ran out of recording paper. Install a recording paper roll (p. 17).</li> </ul>
PAPER JAMMED	<ul style="list-style-type: none"> <li>The recording paper is jammed. Clear the jammed paper (p. 54).</li> </ul>
POLLING ERROR	<ul style="list-style-type: none"> <li>The other party's machine does not have a polling feature. Check with the other party.</li> </ul>
REDIAL TIME OUT	<ul style="list-style-type: none"> <li>The other party's machine is busy or ran out of recording paper. Try again.</li> </ul>
REMOVE DOCUMENT	<ul style="list-style-type: none"> <li>The document is jammed. Remove the jammed document (p. 55).</li> </ul>
TRANSMIT ERROR	<ul style="list-style-type: none"> <li>A transmission error occurred. Try again.</li> </ul>
UNIT OVERHEATED	<ul style="list-style-type: none"> <li>The unit is too hot. Let the unit cool down.</li> </ul>



## Operations

# When a function does not work, check here before requesting help

### General

Problem	Cause & Remedy
I cannot make and receive calls.	<ul style="list-style-type: none"><li>● The power cord or telephone line cord is not connected. Check the connections (p. 18).</li></ul>
I cannot make calls.	<ul style="list-style-type: none"><li>● The dialing mode setting is wrong. Change to TONE or PULSE (p. 18).</li></ul>
The unit does not work.	<ul style="list-style-type: none"><li>● Disconnect the unit from the telephone line and connect the line to a known working telephone. If the working telephone operates properly, contact your service personnel to have the unit repaired. If the working telephone does not operate properly, contact your telephone company.</li></ul>
The unit does not ring.	<ul style="list-style-type: none"><li>● The ringer volume is set to off. Adjust to a suitable level (p. 23).</li></ul>
The <b>REDIAL/PAUSE</b> button does not function properly.	<ul style="list-style-type: none"><li>● If this button is pressed during dialing, a pause will be inserted. If pressed immediately after a dial tone is obtained, the last number dialed will be redialed.</li></ul>
The receive mode does not function as explained on pages 38 and 39.	<ul style="list-style-type: none"><li>● A ring pattern detection is set (p. 45).</li></ul>

### Fax transmission

Problem	Cause & Remedy
The other party complains that letters on their received document are distorted.	<ul style="list-style-type: none"><li>● If your line has special telephone services such as call waiting, the service may have been activated during fax transmission. Connect the unit to a line that does not have these services.</li><li>● The extension telephone on the same line is off the hook. Hang up the extension telephone and try again.</li></ul>
The other party complains that dirty patterns or black lines appear on their received documents.	<ul style="list-style-type: none"><li>● The glass or rollers are dirty. Clean them (p. 56).</li></ul>
I cannot make an international fax call.	<ul style="list-style-type: none"><li>● Use the overseas transmission mode (p. 37).</li><li>● Add two pauses at the end of the telephone number (p. 25).</li></ul>

## Fax reception

Problem	Cause & Remedy
I cannot receive documents automatically.	<ul style="list-style-type: none"> <li>● The receive mode is set to the TEL mode. Set to the TEL/FAX or FAX ONLY mode.</li> <li>● The time to answer the call is too long. Decrease the number of rings (p. 41, 44).</li> </ul>
The recording image is faint.	<ul style="list-style-type: none"> <li>● The sender transmitted a faint document. Ask them to transmit a clearer copy of the document.</li> <li>● The thermal head is dirty. Clean it (p. 56).</li> </ul>
The received document is blank.	<ul style="list-style-type: none"> <li>● The recording paper roll is installed incorrectly. Make sure that the shiny side of the paper is facing down and re-install the paper (p. 17).</li> </ul>

## Copying

Problem	Cause & Remedy
A dirty pattern or a black line appears on the copied documents.	<ul style="list-style-type: none"> <li>● The glass or rollers are dirty. Clean them (p. 56).</li> </ul>
The copied image is distorted.	<ul style="list-style-type: none"> <li>● The thermal head is dirty. Clean it (p. 56).</li> </ul>
The copied document is blank.	<ul style="list-style-type: none"> <li>● The recording paper roll is installed incorrectly. Make sure that the shiny side of the paper is facing down and re-install the paper (p. 17).</li> </ul>

## If a power failure occurs

- The unit will not function.
- The memory contents will not be erased.
- When you set delayed transmission and the programmed start time has passed during a power failure, the transmission will be attempted after power is restored.

## Jams

# Clearing a recording paper jam

If the unit does not eject any recording paper during reception or copying, the recording paper has jammed. Remove the jammed paper as shown below.

- 1 Open the cover by pressing the cover open button. Then press the blue lever to release the paper cutter and remove the recording paper roll.

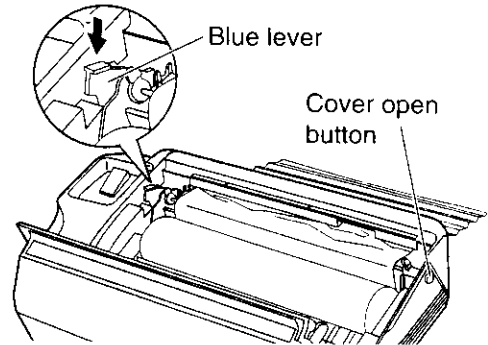

- 2 Cut off the wrinkled portion, and replace the recording paper roll in the proper direction.

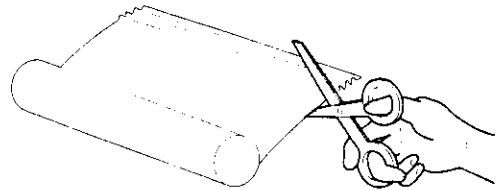

- 3 Insert the leading edge of the paper into the opening above the thermal head and pull it out of the unit.
  - Make sure that there is no slack in the paper roll.
  - If the paper cannot be inserted, try pressing the blue lever again.

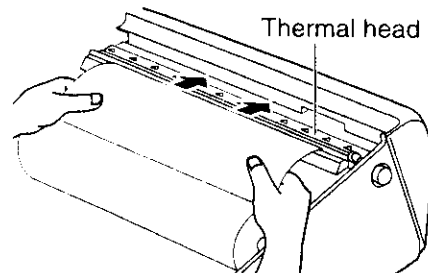

- 4 Close the cover securely by pushing down on both corners.

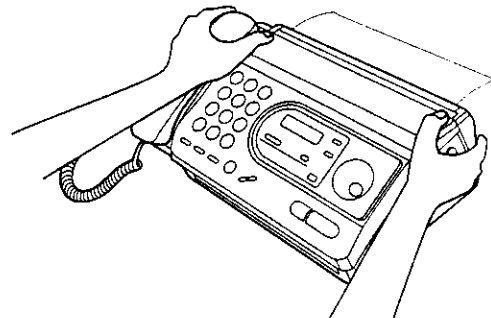

### Note:

- When the power cord is connected, everytime you close the cover a message will be printed. If the recording paper is set to the wrong side, a message will not be printed. Install the paper correctly.

## When a document you are sending jams

If the unit does not release the document during feeding, remove the document as follows.

- 1 Open the cover by pressing the cover open button.
- 2 Remove the jammed document carefully.
- 3 Close the cover securely by pushing down on both corners.

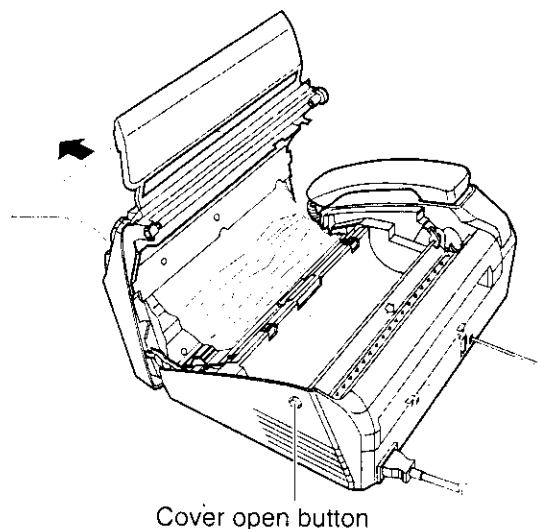

**Note:**

- Before opening the cover, do not pull out the jammed paper forcibly.

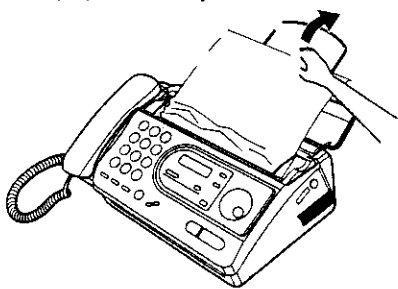

## When documents you send do not feed, or multi-feed

If no feeding or multiple feeding occurs frequently, adjust the feeder pressure.

- 1 Open the cover by pressing the cover open button.
- 2 Shift the position of the lever by using an instrument with a pointed end, like a paper clip.

- Right:** When documents do not feed.  
**Center:** Standard position (pre-selected)  
**Left:** When documents multiple feed.

- 3 Close the cover securely by pushing down on both corners.

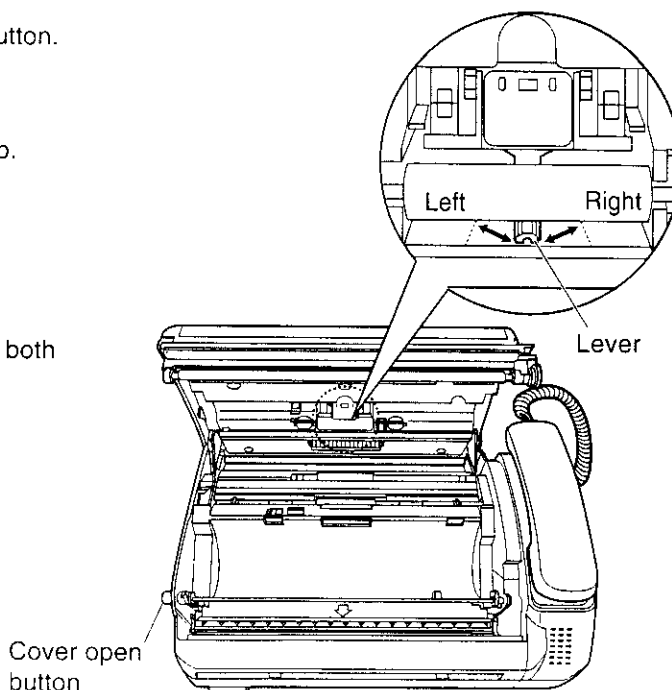

## Cleaning

### Cleaning the document feeder

---

If misfeeding occurs frequently or if dirty patterns or black bands appear on a copied or transmitted document, clean the document feeder.

- 1** Disconnect the power cord and the telephone line cord.
- 2** Open the cover by pressing the cover open button.
- 3** Clean the document feeder rollers, sub roller and rubber flap with a cloth moistened with isopropyl rubbing alcohol, and let all parts dry thoroughly.
- 4** Clean the white plate and glass with a soft dry cloth.
- 5** Close the cover securely by pushing down on both corners.
- 6** Connect the power cord and the telephone line cord.

**Caution:**

- Do not use paper products, such as paper towels or tissues, to clean the inside of the unit.

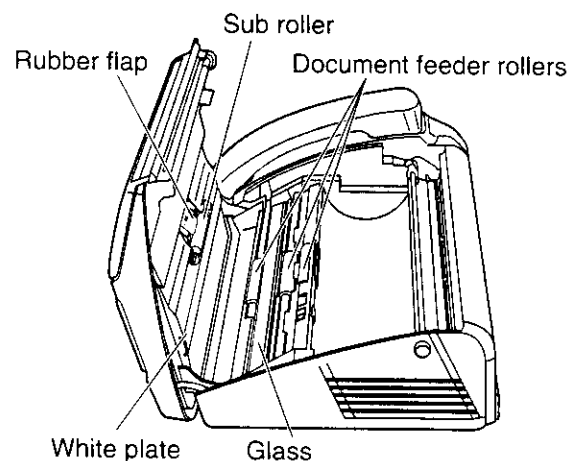
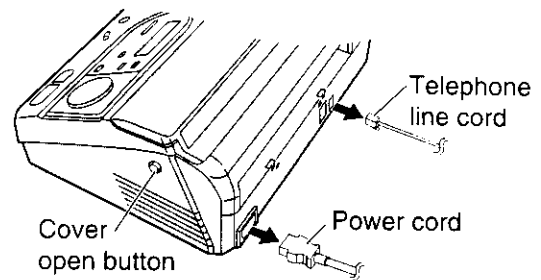

### Cleaning the thermal head

---

If dirty patterns or black bands appear on a copied or received document, clean the thermal head.

- 1** Disconnect the power cord and the telephone line cord.
- 2** Open the cover by pressing the cover open button.
- 3** Clean the thermal head with a cloth moistened with isopropyl rubbing alcohol, and let it dry thoroughly.
- 4** Close the cover securely by pushing down on both corners.
- 5** Connect the power cord and the telephone line cord.

**Caution:**

- To prevent a malfunction due to static electricity, do not use a dry cloth and do not touch the thermal head directly with your fingers.

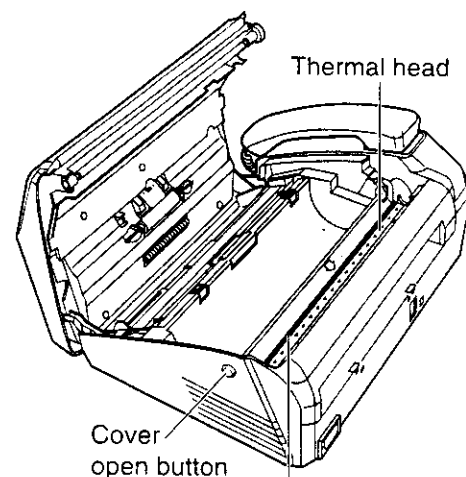

**Caution:**

- Do not push on the black cover.

# Printing the feature settings, telephone numbers, and the journal

You can print out the following documents.

**Basic feature list** — provides you with the current settings of the basic programming features (see page 60).

**Advanced feature list** — provides you with the current settings of the advanced programming features (see page 61).

**Telephone number list** — provides you with names and telephone numbers which are stored in the EASY DIAL directory. The telephone number codes are as shown below.  
 P: A pause has been entered.  
 F: A recall has been entered.  
 [ ]: A secret telephone number has been entered. (The telephone number is not printed.)

**Journal report** — keeps records of fax transmissions and receptions. Also, this report will be printed automatically after every 35 fax communications (see page 35).

**1** Press **MENU** two times.  
 Display: 2.PRINT LIST

**2** For the **basic feature list**, press **[ ]**, then **1**.  
 BASIC LIST

For the **advanced feature list**, press **[ ]**, then **2**.  
 ADVANCED LIST

For the **telephone number list**, press **[ ]**, then **3**.  
 TEL NO. LIST

For the **journal report**, press **[ ]**, then **4**.  
 JOURNAL REPORT

**3** Press **START/COPY/SET** to start printing.  
 PRINTING

- To stop printing, press **STOP**.
- After printing, the following will be displayed.

PRINT ITEM [ ]

**4** Press **MENU**.

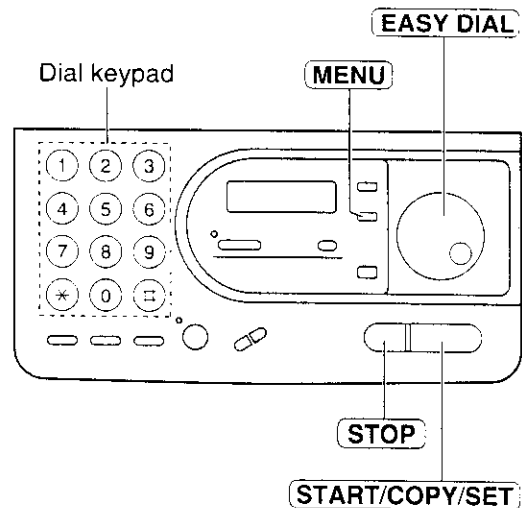

**Note:**

- In step 2, you can select the feature by rotating **EASY DIAL**.

## Display Contrast / Original Mode

### Changing the LCD display contrast

Use this feature to adjust the display contrast.

**NORMAL:** (Pre-selected setting)

**LIGHT:** Used when the display contrast is too dark.

**DARKER:** Used when the display contrast is too light.

- 1 Press **MENU**.  
Display: 1.SYSTEM SET UP
- 2 Press **⇐**, then **3 9**.  
LCD CONTRAST
- 3 Press **START/COPY/SET**.  
MODE=NORMAL ▼▲
- 4 Press ▼ or ▲ to select the desired setting.
- 5 Press **START/COPY/SET**.  
SETUP ITEM [ ]
- 6 Press **MENU**.

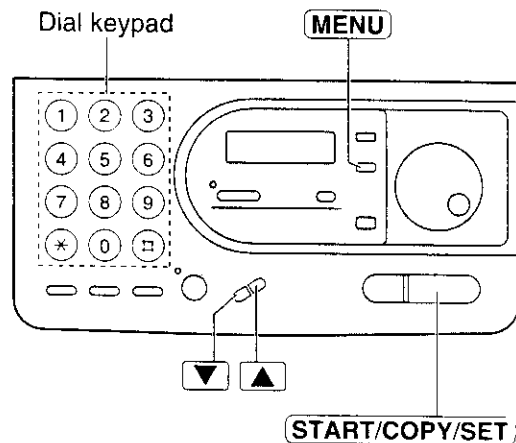

### Setting the original mode

Use this feature when you need to transmit or copy a document with faint or dark writing.

One of the following choices is available.

**NORMAL:** Used for a document with normal writing (pre-selected setting).

**LIGHT:** Used for a document with faint writing.

**DARKER:** Used for a document with dark writing.

Set this feature before starting transmission or copying.

- 1 Press **MENU**.  
Display: 1.SYSTEM SET UP
- 2 Press **⇐**, then **5 8**.  
ORIGINAL
- 3 Press **START/COPY/SET**.  
MODE=NORMAL ▼▲
- 4 Press ▼ or ▲ to select the desired setting.
- 5 Press **START/COPY/SET**.  
SETUP ITEM [ ]
- 6 Press **MENU**.

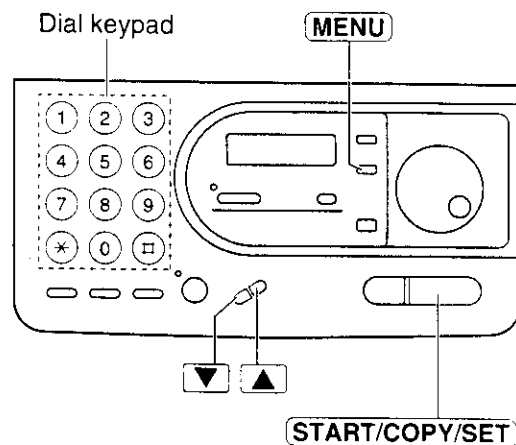

**Note:**

- This feature will return to the normal mode after transmission or copying is completed.
- These settings are available in the standard, fine and super fine resolutions.

## Resetting the advanced features

Use this feature to return the advanced features (see page 61) to their pre-selected settings.

- 1 Press **MENU**.  
Display: 1.SYSTEM SET UP
- 2 Press **□**, then **8 0**.  
SET DEFAULT
- 3 Press **START/COPY/SET**.  
RESET=NO ▼▲
- 4 Press ▼ or ▲ to select "YES".  
RESET=YES ▼▲
- 5 Press **START/COPY/SET**.  
RESET OK?
- If this feature is not required, press **STOP**.
- 6 Press **START/COPY/SET** again for confirmation.  
RESET COMPLETED  
↓  
SETUP ITEM [ ]
- 7 Press **MENU**.

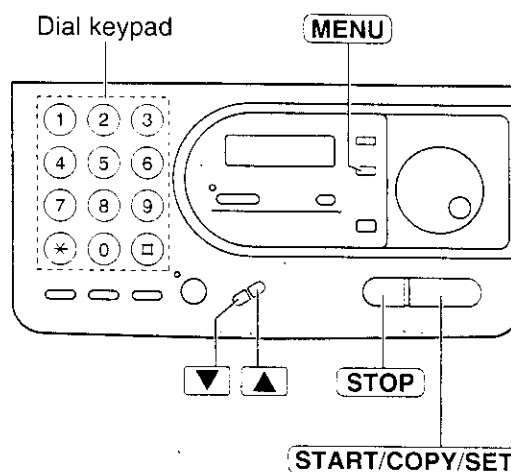



## Features Summary

# Summary of user programmable features

### Basic features

Code	Feature & Display	Available settings	Meaning	Page
#01	Setting the date and time SET DATE & TIME	(2 digits for each entry)	mm/dd/yy hh:mm	19
#02	Setting your logo YOUR LOGO	(Up to 30 characters)	/	20
#03	Setting your facsimile telephone number YOUR TEL NO.	(Up to 20 digits)		22
#04	Printing the transmission report TX-REPORT MODE	<b>ERROR</b> ON OFF		If transmission fails Activate Deactivate
#07	Setting the FAX ONLY mode ring count FAX RING	<b>2</b> , 3, 4, 5, 6, 7, 8, 9	2 to 9 rings	41
#08	Changing the MANUAL RECEIVE setting MANUAL RECEIVE	<b>TEL</b> TEL/FAX	Telephone mode Telephone/Facsimile mode	43
#09	Setting the TEL/FAX mode ring count TEL/FAX RING	<b>2</b> , 3, 4, 5, 6, 7, 8, 9	2 to 9 rings	44

(Pre-selected is in bold.)

#### Note:

- You can display the basic features in the order above by rotating **EASY DIAL** instead of entering the code number (#01, #02, etc.).

Advanced features

Code	Feature & Display	Available settings	Meaning	Page
#22	Setting the journal report to print automatically <div style="border: 1px solid black; padding: 2px; width: fit-content; margin: 5px auto;">AUTO JOURNAL</div>	<b>ON</b> OFF	Activate Deactivate	35
#23	Sending documents overseas <div style="border: 1px solid black; padding: 2px; width: fit-content; margin: 5px auto;">OVERSEAS MODE</div>	<b>ON</b> <b>OFF</b>	Activate Deactivate	37
#25	Sending a fax at a specific time <div style="border: 1px solid black; padding: 2px; width: fit-content; margin: 5px auto;">DELAYED SEND</div>	<b>ON</b> <b>OFF</b>	Activate Deactivate	36
#30	Setting the silent fax recognition ring count <div style="border: 1px solid black; padding: 2px; width: fit-content; margin: 5px auto;">SILENT FAX RING</div>	3, 4, 5, <b>6</b> , 7, 8, 9	3 to 9 rings	44
#31	Setting the ring pattern detection <div style="border: 1px solid black; padding: 2px; width: fit-content; margin: 5px auto;">RING DETECTION</div>	<b>ON</b> <b>OFF</b>	Activate Deactivate	45
#39	Changing the LCD display contrast <div style="border: 1px solid black; padding: 2px; width: fit-content; margin: 5px auto;">LCD CONTRAST</div>	<b>NORMAL</b> LIGHT DARKER	Normal contrast Lighter contrast Darker contrast	58
#41	Changing the fax activation code <div style="border: 1px solid black; padding: 2px; width: fit-content; margin: 5px auto;">FAX ACTIVATION</div>	<b>ON / CODE= * 9</b> OFF	Activate Deactivate	46
#46	Setting the friendly reception <div style="border: 1px solid black; padding: 2px; width: fit-content; margin: 5px auto;">FRIENDLY RCV</div>	<b>ON</b> OFF	Activate Deactivate	47
#58	Setting the original mode <div style="border: 1px solid black; padding: 2px; width: fit-content; margin: 5px auto;">ORIGINAL</div>	<b>NORMAL</b> LIGHT DARKER	Normal contrast Lighter contrast Darker contrast	58
#70	Signaling your pager when your unit receives a fax <div style="border: 1px solid black; padding: 2px; width: fit-content; margin: 5px auto;">FAX PAGER</div>	<b>ON</b> <b>OFF</b>	Activate Deactivate	48
#80	Resetting the advanced features <div style="border: 1px solid black; padding: 2px; width: fit-content; margin: 5px auto;">SET DEFAULT</div>	<b>YES</b> <b>NO</b>	Reset Will not reset	59

(Pre-selected is in bold.)

## Specifications

### Technical data about this product

---

---

<b>Applicable Lines:</b>	Public Switched Telephone Network
<b>Document Size:</b>	Max. 216 mm (8 <sup>1</sup> / <sub>2</sub> " ) in width Max. 600 mm (23 <sup>5</sup> / <sub>8</sub> " ) in length
<b>Effective Scanning Width:</b>	208 mm (8 <sup>3</sup> / <sub>16</sub> " )
<b>Printing Paper Size:</b>	216 mm × max. 30 m (8 <sup>1</sup> / <sub>2</sub> " × 98' ) roll
<b>Effective Printing Width:</b>	208 mm (8 <sup>3</sup> / <sub>16</sub> " )
<b>Transmission Time *:</b>	Approx. 15 s/page (Original mode) Approx. 30 s/page (G3 Normal mode)
<b>Scanning Density:</b>	Horizontal: 8 pels/mm (203 pels/inch) Vertical: 3.85 lines/mm (98 lines/inch) —STANDARD mode 7.7 lines/mm (196 lines/inch) —FINE/HALF TONE mode 15.4 lines/mm (392 lines/inch) —SUPER FINE mode
<b>Halftone Level:</b>	64-level
<b>Scanner Type:</b>	Contact Image Sensor (CIS)
<b>Printer Type:</b>	Thermal Printing
<b>Data Compression System:</b>	Modified Huffman (MH), Modified READ (MR)
<b>Modem Speed:</b>	9,600 / 7,200 / 4,800 / 2,400 bps; Automatic Fallback
<b>Operating Environment:</b>	5–35 °C (41–95 °F), 45–85 % RH (Relative Humidity)
<b>Dimensions (H×W×D):</b>	135 × 323 × 229 mm (5 <sup>3</sup> / <sub>16</sub> " × 12 <sup>23</sup> / <sub>32</sub> " × 9" )
<b>Mass (Weight):</b>	Approx. 2.9 kg (6.4 lb.)
<b>Power Consumption:</b>	Standby: Approx. 6.5 W Transmission: Approx. 17 W Reception: Approx. 40 W Copy: Approx. 40 W Maximum: Approx. 125 W
<b>Power Supply:</b>	220-240 V AC, 50/60 Hz

- \* Transmission speed depends upon the contents of the pages, resolution, telephone line conditions and capability of the receiving unit.  
The 15 second speed is based upon CCITT No.1 Test Chart.

CCITT No.1 Test Chart

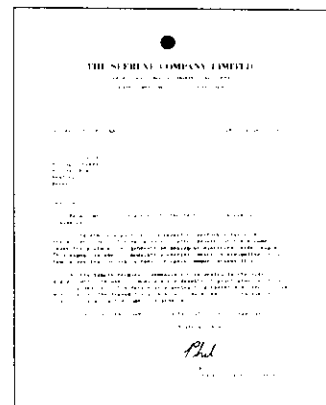

#### Note:

- Any details given in these instructions are subject to change without notice.
- The pictures and illustrations in these instructions may vary slightly from the actual product.

## Index

- |          |   |          |                                    |
|----------|---|----------|------------------------------------|
| <b>A</b> | Accessories.....4                       | <b>J</b> | Jam ..... 54, 55                   |
|          | Advanced feature list .....57           |          | Journal auto print .....35         |
|          | Advanced features .....61               |          | Journal report .....57             |
|          | (Resetting) .....59                     | <b>L</b> | Location panel.....14, 15          |
|          | AUTO RECEIVE button .....38, 39         |          | Logo .....20                       |
|          | AUTO RECEIVE mode .....39               | <b>M</b> | MANUAL RECEIVE mode .....38        |
| <b>B</b> | Basic feature list.....57               |          | MONITOR button .....29, 30, 31     |
|          | Basic features .....60                  |          | Muting .....24                     |
| <b>C</b> | Character table .....21, 27             | <b>O</b> | Original mode.....58               |
|          | Cleaning.....56                         |          | Overseas transmission mode .....37 |
|          | Connections .....18                     |          | Overview .....16                   |
|          | COPY button .....49                     | <b>P</b> | Paper jam.....54, 55               |
| <b>D</b> | Date and time.....19                    |          | PAUSE button .....25               |
|          | Delayed transmission.....36             |          | Polling (Receiving) .....47        |
|          | Dialing mode .....18                    |          | (Transmitting) .....37             |
|          | Directory feature .....26, 29, 32       |          | Power failure .....53              |
|          | Display contrast .....58                |          | Power supply .....18, 62           |
|          | Distinctive ring service .....45        |          | Printing paper size .....62        |
|          | Document size .....33, 62               |          | Printing reports.....57            |
| <b>E</b> | EASY DIAL (Making a voice call) .....29 |          | Programmable features .....60, 61  |
|          | (Selecting characters) .....21, 27      | <b>R</b> | RECALL button .....25              |
|          | (Sending faxes) .....32                 |          | Recording paper .....5, 17, 54     |
|          | (Storing) .....26                       |          | REDIAL button .....24, 31          |
|          | Error messages.....50, 51               |          | RESOLUTION button.....31           |
|          | Extension telephone .....43, 46         |          | Ring pattern detection.....45      |
| <b>F</b> | Facsimile telephone number.....22       | <b>S</b> | Secret key .....26, 27             |
|          | FaxAbility .....45                      |          | Set default.....59                 |
|          | Fax activation code .....46             |          | Silent fax recognition ring.....44 |
|          | Fax auto redial .....32                 |          | Specifications.....62              |
|          | FAX ONLY mode .....39, 41               | <b>T</b> | TEL mode .....38, 40               |
|          | FAX ONLY ring count .....41             |          | TEL/FAX mode .....38, 42           |
|          | Fax pager .....48                       |          | TEL/FAX ring count.....44          |
|          | Features summary .....60, 61            |          | Telephone number list .....57      |
|          | Feeder pressure.....55                  |          | TONE button .....25                |
|          | Friendly reception .....40, 47          |          | Transmission report .....34        |
| <b>H</b> | HANDSET MUTE button.....24              |          | Transmittable document .....33     |
|          | HELP button.....5                       | <b>V</b> | Voice contact .....30              |
|          | Hyphen key .....27                      |          | VOLUME button.....23               |
| <b>I</b> | Insert key .....20, 21, 27              |          |                                    |