

Panasonic

Compact Plain Paper FAX
with Cordless Phone

Operating Instructions

Model No. **KX-FPC91**

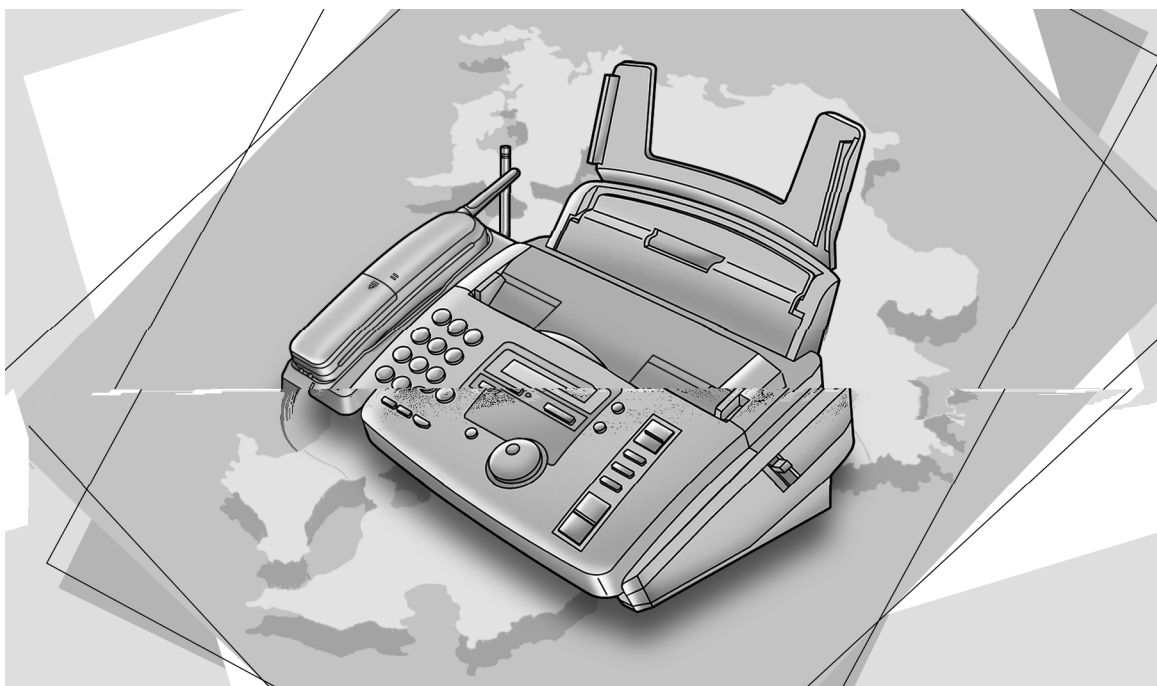

FOR FAX ADVANTAGE ASSISTANCE:

– CALL

1-800-HELP-FAX (1-800-435-7329)

– E-MAIL TO

consumerproducts@panasonic.com

for customers in the USA or

Puerto Rico

– REFER TO

www.panasonic.com

for customers in the USA or

Puerto Rico

Please read these Operating Instructions before using the unit and save for future reference.

Thank you for purchasing a Panasonic facsimile.

Welcome to the world of Panasonic facsimiles.

This product combines facsimile, telephone and copier features to provide you with more efficient office or home use. By utilizing these convenient features, you can maximize the effectiveness of this unit.

Things you should keep record of

Attach your sales receipt here

For your future reference

Date of purchase

Serial number

(found on the rear of the unit)

Dealer's name and address

Dealer's telephone number

Caution:

- The Telephone Protection Act of 1991 requires the following information to be clearly stated either at the top or bottom margin of the first message page when transmitting messages via telephone facsimile:
 - Date and time of transmission,
 - Identification of the business, entity or person(s) sending the facsimile, and
 - Telephone number of the business, entity or person(s).To program this information into your unit, complete all the instructions on pages 15 to 18.
- Note that the images of copied or received documents will remain on the used ink film. Use discretion when disposing of the used ink film.
- Do not rub or use an eraser on the printed side of recording paper, as the print may smear.

Trademarks

Hammermill® is a registered trademark of INTERNATIONAL PAPER in the United States and/or other countries.

All other trademarks identified herein are the property of their respective owners.

Copyright:

This manual is copyrighted by Kyushu Matsushita Electric Co., Ltd. (KME) and its licensee. Under the copyright laws, this manual may not be reproduced in any form, in whole or part, without the prior written consent of KME and its licensee.

© Kyushu Matsushita Electric Co., Ltd. 2000

For best performance

Battery charge

To power the handset, charge for about **4 hours** before initial use (p. 20).

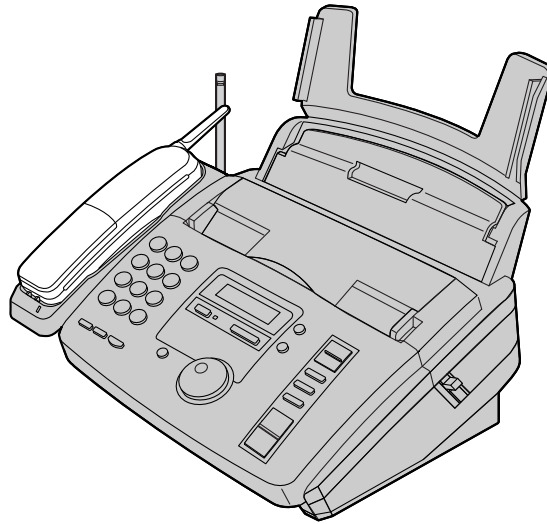

Operating distance and noise

Calls are transmitted between the main unit and the handset using wireless radio waves.
For maximum distance and noise free operation, the recommended main unit location is:

Away from electrical appliances such as TVs, radios, or personal computers.

In a **HIGH** and **CENTRAL** location with no obstructions such as walls.

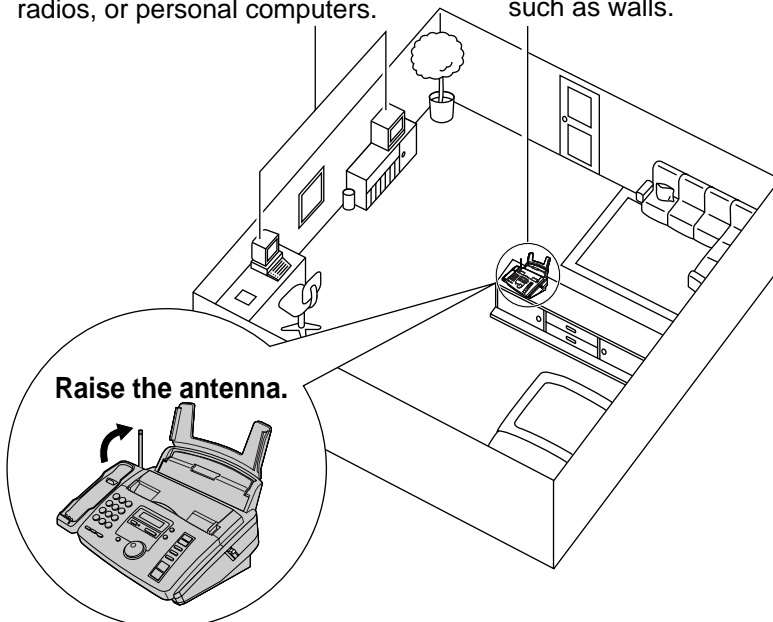

Raise the antenna.

Important safety instructions

When using this unit, basic safety precautions should always be followed to reduce the risk of fire, electric shock, or personal injury.

1. Read and understand all instructions.
2. Follow all warnings and instructions marked on this unit.
3. Unplug this unit from power outlets before cleaning. Do not use liquid or aerosol cleaners. Use a damp cloth for cleaning.
4. Do not use this unit near water, for example near a bath tub, wash bowl, kitchen sink, or the like.
5. Place the unit securely on a stable surface. Serious damage and/or injury may result if the unit falls.
6. Do not cover slots and openings on the unit. They are provided for ventilation and protection against overheating. Never place the unit near radiators, or in a place where proper ventilation is not provided.
7. Use only the power source marked on the unit. If you are not sure of the type of power supplied to your home, consult your dealer or local power company.
8. For safety purposes this unit is equipped with a three prong grounded plug. If you do not have this type of outlet, please have one installed. Do not use any type of adaptor plug to defeat this safety feature.
9. Do not place objects on the power cord. Install the unit where no one can step or trip on the cord.
10. Do not overload wall outlets and extension cords. This can result in the risk of fire or electric shock.
11. Never push any objects through slots in this unit. This may result in the risk of fire or electric shock. Never spill any liquid on the unit.
12. To reduce the risk of electric shock, do not disassemble this unit. Take the unit to an authorized servicenter when service is required. Opening or removing covers may expose you to dangerous voltages or other risks. Incorrect reassembly can cause electric shock when the unit is subsequently used.
13. Unplug this unit from the wall outlet and refer servicing to an authorized servicenter when the following conditions occur:
 - A. When the power supply cord or plug is damaged or frayed.
 - B. If liquid has been spilled into the unit.
 - C. If the unit has been exposed to rain or water.
 - D. If the unit does not work normally by following the operating instructions. Adjust only controls covered by the operating instructions. Improper adjustment may require extensive work by an authorized servicenter.
 - E. If the unit has been dropped or physically damaged.
 - F. If the unit exhibits a distinct change in performance.
14. During thunderstorms, avoid using telephones except cordless types. There may be a remote risk of an electric shock from lightning.
15. Do not use this unit to report a gas leak, when in the vicinity of the leak.

**SAVE THESE
INSTRUCTIONS**

CAUTION

To reduce the risk of fire or injury to persons, read and follow these instructions.

1. Use only the battery(ies) specified.
2. Do not dispose of the battery(ies) in a fire. They may explode. Check with local waste management codes for special disposal instructions.
3. Do not open or mutilate the battery(ies). Released electrolyte is corrosive and may cause burns or injury to the eyes or skin. The electrolyte may be toxic if swallowed.
4. Exercise care in handling batteries in order not to short the battery to conductive materials such as rings, bracelets, and keys. The battery and/or conductor may overheat and cause burns.
5. Charge the battery(ies) provided with or identified for use with this product only in accordance with the instructions and limitations specified in this manual.

INSTALLATION

1. Never install telephone wiring during a lightning storm.
2. Never install telephone jacks in wet locations unless the jack is specifically designed for wet locations.
3. Never touch uninsulated telephone wires or terminals unless the telephone line has been disconnected at the network interface.
4. Use caution when installing or modifying telephone lines.

WARNING

- To prevent the risk of fire or electrical shock, do not expose this product to rain or any type of moisture.

OTHER INFORMATION

- Keep the unit away from electrical noise generating devices, such as fluorescent lamps and motors.
- The unit should be kept free from dust, high temperature and vibration.
- The unit should not be exposed to direct sunlight.
- Do not place heavy objects on top of this unit.
- Do not touch the plug with wet hands.

Table of Contents

Initial Preparation

Accessories	Included accessories	8
	Accessory order information	9
Help Button	Help function	10
Finding the Controls (Main unit)	Location	11
	Overview	12
Setup (Main unit)	Removing the information leaflet	12
	Paper tray	12
	Recording paper	13
	Connections	14
	Date and time, your logo and facsimile telephone number	15
Setup (Handset)	Location	19
	Battery charge	20
	Belt clip	21
	Headset (not included)	21
Volumes	Adjusting volumes	22

Telephone

Making and Answering Calls	Voice calls - making	23
	Voice calls - answering	25
	Paging the handset from the main unit (handset locator)	25
	Remote monitor	26
	TONE, FLASH and PAUSE buttons	27
Automatic Dialing (Handset)	Storing telephone numbers in the handset	28
	Making a voice call with the handset using stored numbers	28
	Storing a telephone number in the DIRECT button	29
	Dialing a stored number in the DIRECT button	29
JOG DIAL	Storing names and telephone numbers in the JOG DIAL directory	30
	Making a voice call using the JOG DIAL directory	33
Voice Contact	Talking to the other party after fax transmission or reception	34

Fax

Sending Faxes	Sending a fax manually/using the JOG DIAL directory	35
	One time broadcast transmission	38
	Broadcast transmission to pre-programmed parties	39
Receiving Faxes	Setting the unit to receive faxes	42
	TEL mode (answering all calls manually)	44
	FAX ONLY mode (all calls are received as faxes)	45
	Using the unit with an answering machine	46

(continued)

Fax

Receiving Faxes (continued)	TEL/FAX mode (receiving voice calls with rings and fax calls without rings when you are near the unit)	48
	Extension telephone	50
	Pager call - when the unit receives a fax	51

Copy

Copying	Making a copy	52
----------------	-------------------------	----

Programmable Features

Features Summary	Programming	54
	Basic features	55
	Advanced features	56

Help







Error Messages	Reports	60
	Display	61
Operations	When a function does not work, check here before requesting help	63
	If a power failure occurs	68
Jams	Recording paper jam	69
	Sending document jams	70
	Sending document does not feed, or multi-feeds	70
Battery	Replacing the handset battery	71
Ink Film	Replacing the ink film	72
Cleaning	Document feeder	74
	Thermal head	75
	Charge contacts	75

General Information

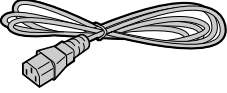
Print Reports	Reference lists and reports	76
FCC Information	List of FCC requirements and information	77
Limited Warranty	Limited Warranty	78
	Servicenter Directory	79
	Notes for product service and shipping the product	80
Energy Star	Energy Star	80
Specifications	Technical data about this product	81
Index	Index	82

Accessories

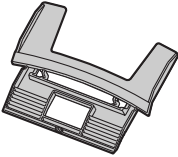
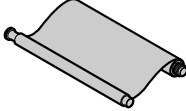
Included accessories

<p>Power cord.....1</p>  <p>Part No. PFJA1030Z</p>	<p>Telephone line cord...1</p>  <p>Part No. PQJA10075Z</p>	<p>Cordless handset1</p>  <p>—The rechargeable battery is pre-installed.</p>	<p>Belt clip1</p>  <p>Part No. PQKE10079Z3</p>
<p>Paper tray1</p>  <p>Part No. PFKS1040Y1</p>	<p>Ink film.....1 (included film roll)</p>  <p>—The ink film is pre-installed.</p>	<p>Operating instructions...1</p>  <p>Part No. PFQX1453Z</p>	

- If any items are missing or damaged, check with the place of purchase.
- The part numbers listed above are subject to change without notice.
- Save the original carton and packing materials for future shipping and transportation of the unit.

Accessory order information

- The included film roll is 10 meters (32½') long.
We recommend that you buy full-size replacement film – 50 meters (164') for continuous use of your unit.
For best results, use genuine Panasonic replacement film Model No. KX-FA53 or KX-FA55.
- To install legal size recording paper, use a legal paper tray, Model No. KX-FA50 (p. 12).

To order

Telephone:

Call 1-201-348-7292.

Fax:

Send a fax to 1-877-375-4020.

Include:

- your name, shipping address and telephone number,
- credit card type, number, expiration date and your signature,
- order part number and quantity.

Via the Internet: Visit our web site: <http://www.panasonic.com/store>
(for customers in the USA or Puerto Rico ONLY)

- If you have any questions regarding accessory orders, please contact us at this E-MAIL ADDRESS: panasonicdirect@panasonic.com
(for customers in the USA or Puerto Rico ONLY)
or call us at: 201-348-7292

Model No.	Item	Specifications / Usage
KX-FA53	Replacement film	1 roll – 216 mm x 50 m (8½" x 164')
KX-FA55	Replacement film	2 rolls – 216 mm x 50 m (8½" x 164')
KX-FA50	Legal paper tray	To install legal size recording paper.
KX-A36	Rechargeable battery	Ni-Cd battery
KX-TCA87	Headset	For a hands-free telephone conversation

Note:

- The ink film is not reusable. Do not rewind and use the ink film again.

Help Button

Help function

You can print a quick reference for assistance as follows.

1 Press **HELP**.

Display: ROTATE ↻ & SET

2 Rotate **JOG DIAL** until the desired item is displayed.

1. How to set the date, time, your logo and fax number

1. QUICK SET UP

2. How to program the features

2. FEATURE LIST

3. How to store names in the JOG DIAL directory and how to dial them

3. JOG-DIAL

4. Help with problems sending/receiving faxes

4. FAX SND/RCV

5. How to use the copier function

5. COPIER

6. Frequently asked questions and answers

6. Q and A

7. Explanation of error messages shown on the display

7. ERRORS

8. List of available reports

8. REPORTS

3 Press **SET**.

PRINTING

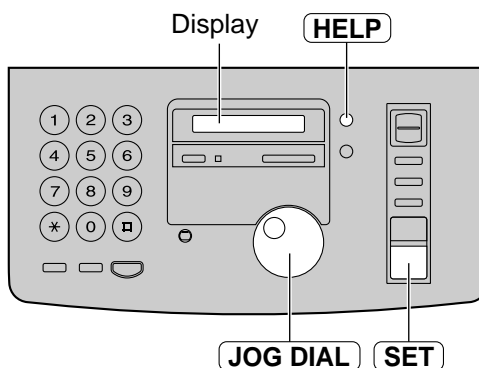

Finding the Controls (Main unit)

Location

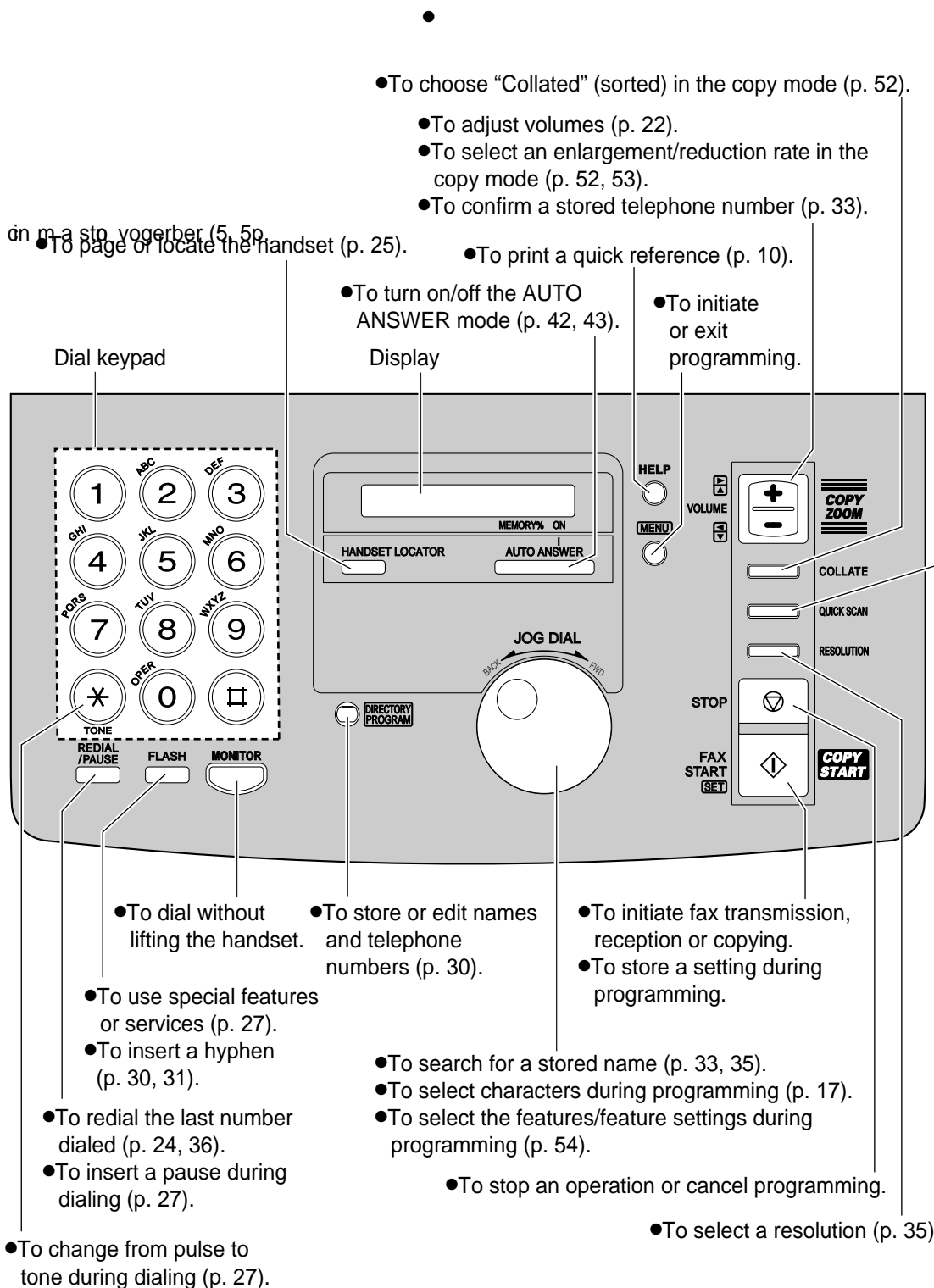

Finding the Controls/Setup (Main unit)

Overview

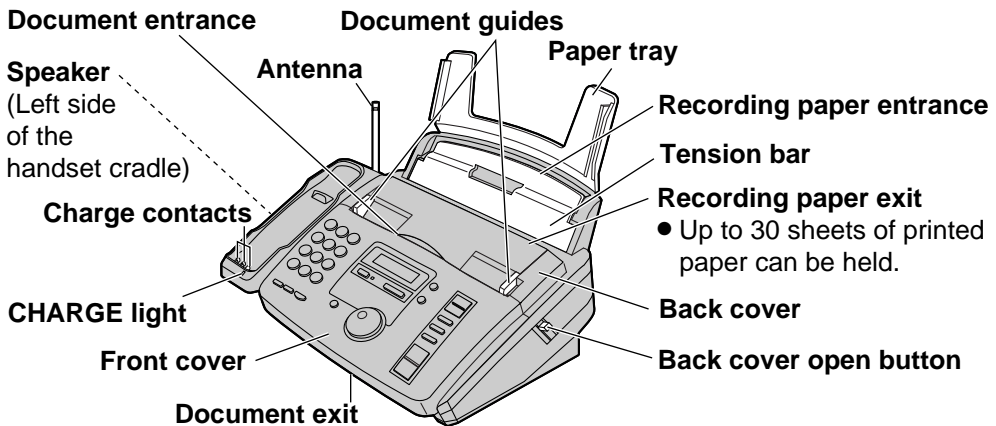

Note:

- The document will be ejected from the front of the unit. Install the unit on a desk or floor with a smooth surface and do not place anything in front of the unit.

Removing the information leaflet

- 1 Open the front cover by pulling up the center part.
- 2 Remove and read the information leaflet.
- 3 Close the front cover securely.

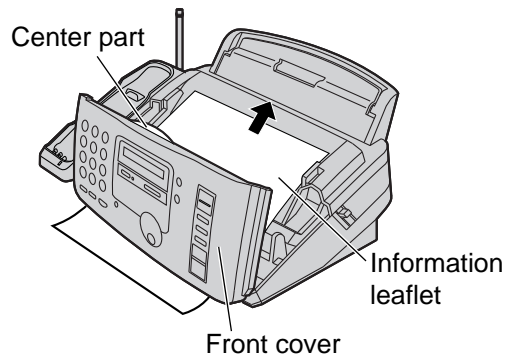

Paper tray

Insert one tab on the paper tray into one slot on the back of the unit (①) and then insert the other tab into the other slot (②).

Note:

- Do not place the unit in areas where the paper tray may be obstructed by a wall, etc.

To use legal size paper

Please purchase a legal paper tray, Model No. KX-FA50 (p. 9) and install as shown above.

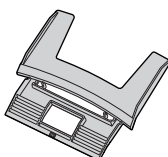

KX-FA50
Legal paper tray

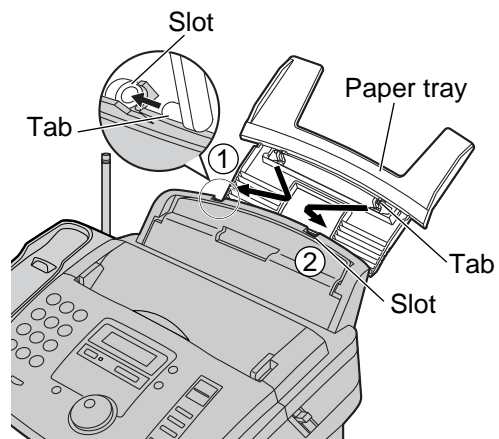

Recording paper

Letter* or legal** size recording paper can be loaded. The unit can hold up to 50 sheets of 60 g/m² to 75 g/m² (16 lb. to 20 lb.) paper or 30 sheets of 90 g/m² (24 lb.) paper.

* Letter=216 mm x 279 mm (8½" x 11")

**Legal=216 mm x 356 mm (8½" x 14")

If you use legal size paper, please purchase a legal paper tray, Model No. KX-FA50 (p. 9) and install it (p. 12).

For best results, only use inkjet paper such as Hammermill® Jet Print. If you use other types of paper, the print quality may be affected.

- 1 Fan the stack of paper to prevent a paper jam.
- 2 Pull the tension bar forward and hold open while inserting the paper.
 - The paper should not be over the tab.
 - If the paper is not inserted correctly, readjust the paper or the paper may jam.

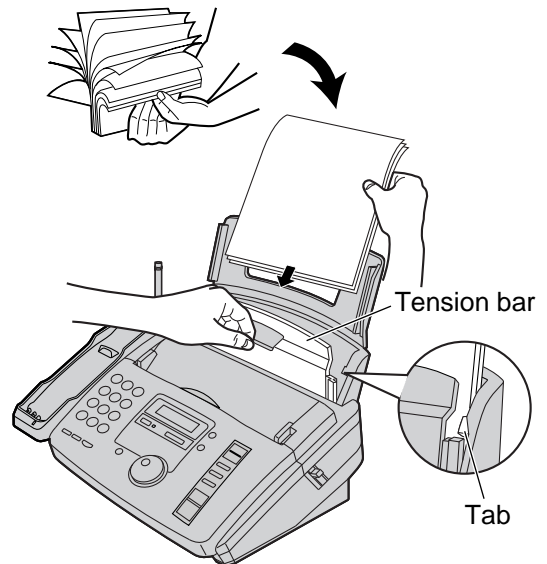
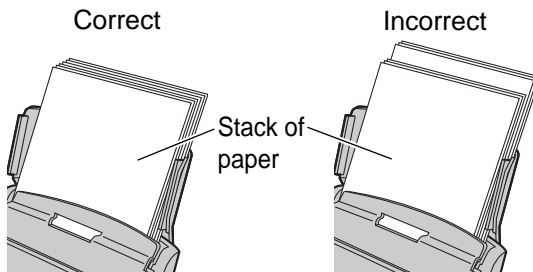

Note for recording paper:

- Avoid paper with a cotton and/or fiber content that is over 20%, such as letterhead paper or paper used for resumes.
- Do not use different types or thicknesses of paper at the same time. This may cause a paper jam.
- Avoid extremely smooth or shiny paper that is highly textured.
- Avoid paper that is coated, damaged or wrinkled.

Note:

- Avoid double-sided printing.
- Do not use paper printed from this unit for double-sided printing with other copiers or printers, or the paper may jam.
- Some paper only accepts print on one side. Try using the other side of paper if you are not happy with the print quality.

Adding paper

1. Pull the tension bar forward and hold open while removing all of the installed paper.
2. Add paper to the removed paper and straighten.
3. Fan the stack of paper.
4. Pull the tension bar forward and hold open while inserting the paper.

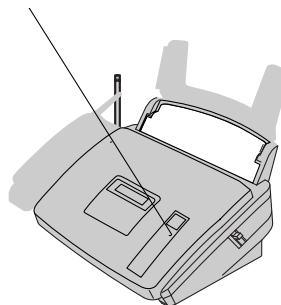

Setup (Main unit)

Connections

- 1 Connect the telephone line cord.
- 2 Connect the power cord.
 - When the power is turned on for the first time, the unit will print some basic information.

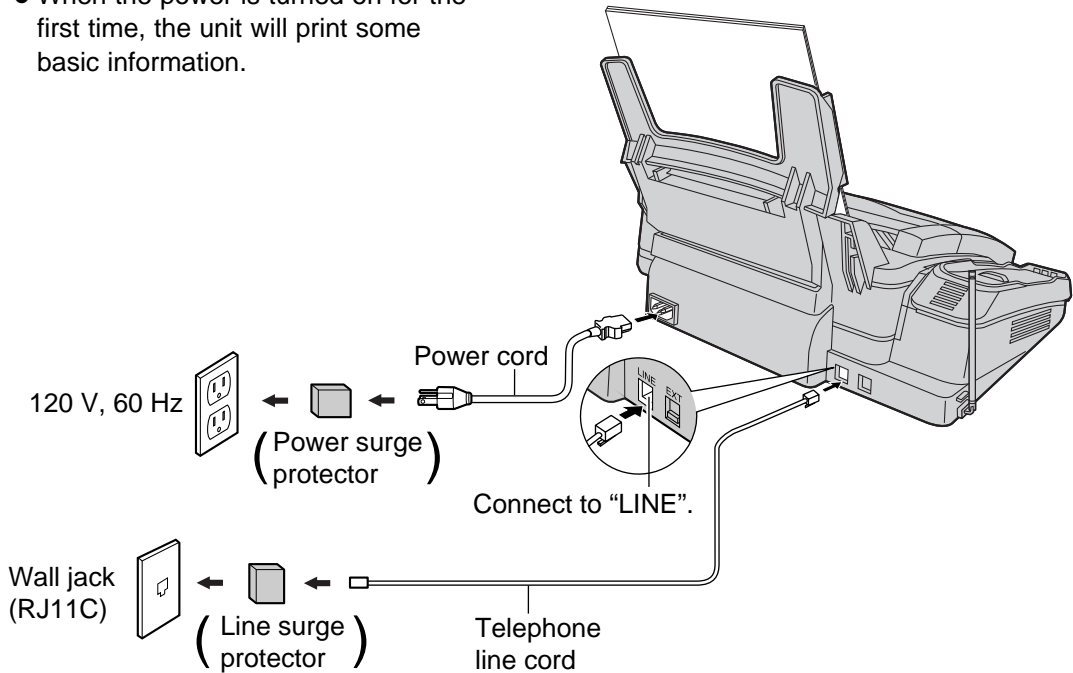

Note:

- For additional equipment protection, we recommend the use of a surge protector. The following types are available; TELESPIKE BLOK MODEL TSB (TRIPPE MFG. CO.), SPIKE BLOK MODEL SK6-0 (TRIPPE MFG. CO.), SUPER MAX (PANAMAX) or MP1 (ITW LINX).
The warranty does not cover damage due to power line surges or lightning.
- When you operate this product, the power outlet should be near the product and easily accessible.
- If you want to connect an answering machine to the unit, see page 46.

Date and time, your logo and facsimile telephone number

You should program the date and time, your logo and facsimile telephone number. This information will be printed on each page transmitted from your unit, fulfilling the requirements of the Telephone Protection Act of 1991.

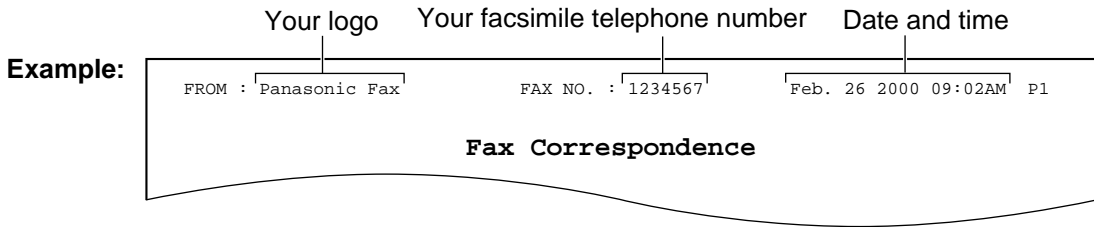

Setting the date and time

1 Press **MENU** .
Display: 1.SYSTEM SET UP

2 Press **□**, then **0 1** .
SET DATE & TIME

3 Press **SET** .
M: 01 / D: 01 / Y: 00
Cursor

4 Enter the correct month/day/year by selecting 2 digits for each, using the dial keypad.
Example: Aug. 10, 2000
Press **0 8 1 0 0 0** .
M: 08 / D: 10 / Y: 00

5 Press **SET** .
TIME: 12:00AM

6 Enter the correct hour/minute by selecting 2 digits for each, using the dial keypad.
Press ***** to select "AM" or "PM".
Example: 3:15PM
1. Press **0 3 1 5** .
TIME: 03:15AM

2. Press ***** until "PM" is displayed.
TIME: 03:15PM

7 Press **SET** .
SETUP ITEM []

8 Press **MENU** .

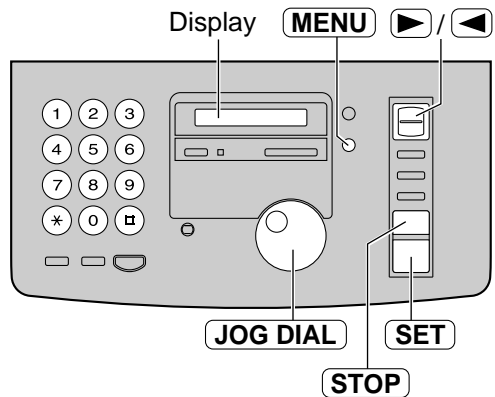

Note:

- You can enter your number by rotating **JOG DIAL** in steps 4 and 6. In this case, press **▶** to move the cursor.
- The accuracy of the clock is approximately ± 60 seconds a month.

To correct a mistake

- Press **▶** or **◀** to move the cursor to the incorrect number, and make the correction.
- If you press **STOP** while programming, the display will return to the previous one.

Setup (Main unit)

Setting your logo

The logo can be your company, division or name.

1 Press **MENU**.
Display: 1.SYSTEM SET UP

2 Press **⏏**, then **0 2**.
YOUR LOGO

3 Press **SET**.
LOGO=

4 Enter your logo, up to 30 characters, using the dial keypad. See next page for details.

Example: Bill

1. Press **2** twice.

LOGO=B
Cursor

2. Press **4** six times.

LOGO=Bi

3. Press **5** six times.

LOGO=Bi

4. Press **▶** to move the cursor to the next space and press **5** six times.

LOGO=Bill

5 Press **SET**.
SETUP ITEM []

6 Press **MENU**.

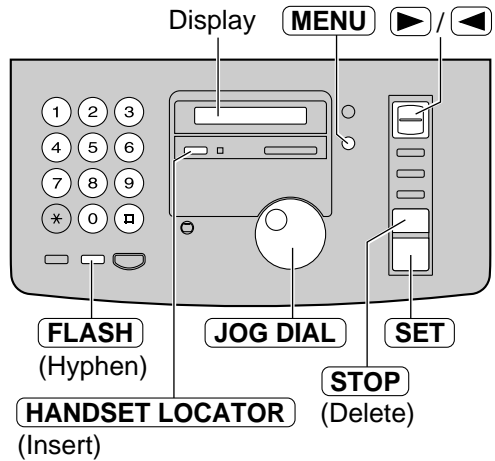

Note:

- You can enter your logo by rotating **JOG DIAL** (see next page).

To correct a mistake

- Press **▶** or **◀** to move the cursor to the incorrect character, and make the correction.

To delete a character



- Move the cursor to the character you want to delete and press **STOP**.

To insert a character

- Press **▶** or **◀** to move the cursor to the position to the right of where you want to insert the character.
- Press **HANDSET LOCATOR (Insert)** to insert a space and enter the character.

To select characters with the dial keypad

Pressing the dial keys will select a character as shown below.

Keys	Characters
①	1 [] { } + - / = , . _ ` : ; ?
②	A B C a b c 2
③	D E F d e f 3
④	G H I g h i 4
⑤	J K L j k l 5
⑥	M N O m n o 6
⑦	P Q R S p q r s 7
⑧	T U V t u v 8
⑨	W X Y Z w x y z 9
⑩	0 () < > ! " # \$ % & ¥ * @ ^ ' →
FLASH	Hyphen button (To insert a hyphen.)
HANDSET LOCATOR	Insert button (To insert one character or one space.)
STOP	Delete button (To delete a character.)
	▶ key (To move the cursor to the right.) To enter another character using the same number key, move the cursor to the next space.
	◀ key (To move the cursor to the left.)

To select characters using the JOG DIAL

Instead of pressing the dial keys, you can select characters using the JOG DIAL.

1. Rotate **JOG DIAL** until the desired character is displayed.
2. Press  to move the cursor to the next space.
 - The character displayed in step 1 is inserted.
3. Return to step 1 to enter the next character.

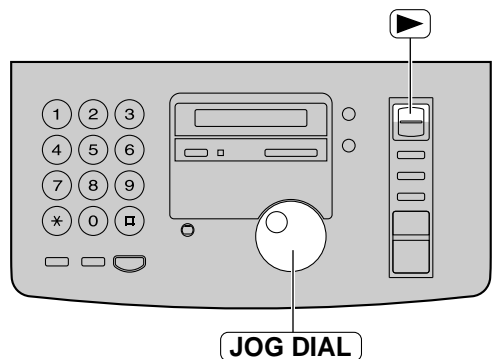

Display order of characters

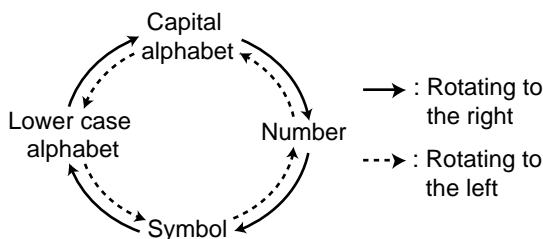

Setup (Main unit)

Setting your facsimile telephone number

1 Press **MENU**.
Display: 1.SYSTEM SET UP

2 Press **▣**, then **0 3**.
YOUR FAX NO.

3 Press **SET**.
NO. =

4 Enter your facsimile telephone number, up to 20 digits, using the dial keypad.
Example: NO. =1234567

5 Press **SET**.
SETUP ITEM []

6 Press **MENU**.

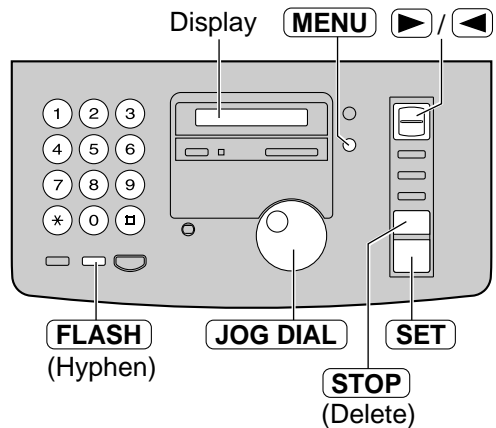

Note:

- You can enter your facsimile telephone number by rotating **JOG DIAL**. If using **FLASH**, press **FLASH** to move the cursor.
- The **FLASH** button replaces the digit with a "+" and the **▣** button replaces it with a space.
Example (using the dial keypad): +234 5678
Press ***234▣5678**.
- To enter a hyphen in a telephone number, press **FLASH** (Hyphen).

Location

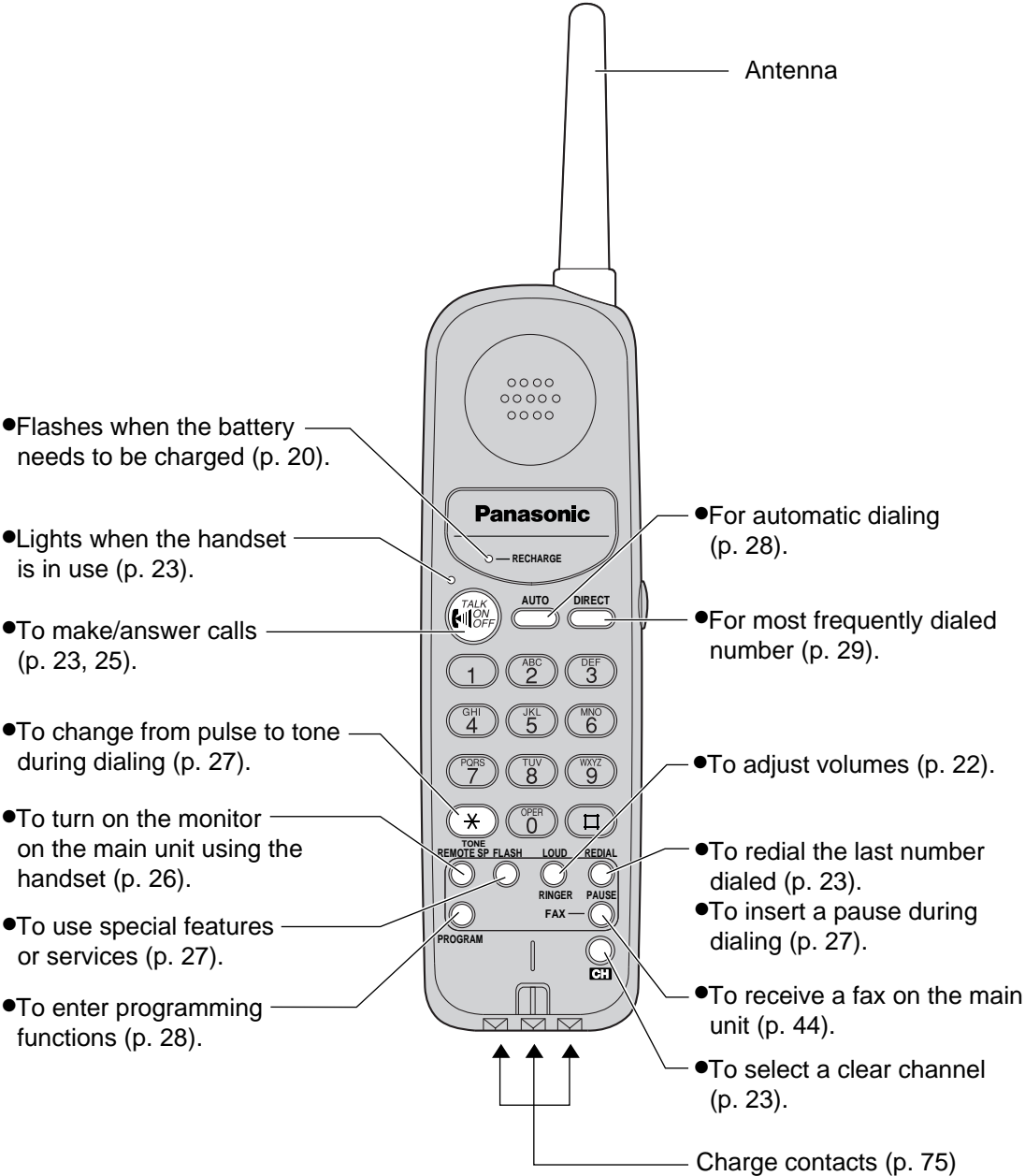

Setup (Handset)

Battery charge

Place the handset on the cradle of the main unit for about **4 hours**.

- The CHARGE light will turn on.

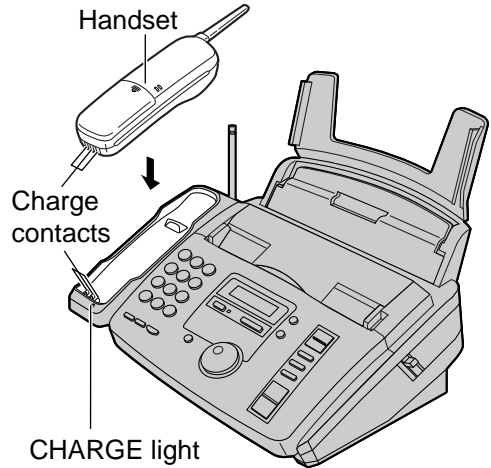

Note:

- **Clean the handset and the main unit charge contacts with a dry cloth once a month**, or the battery may not charge properly (p. 75).
- The battery cannot be overcharged.

Automatic security code setting

Whenever you place the handset on the main unit, the unit will automatically select one of a million security codes. These codes help to avoid unauthorized use of your telephone line by another cordless telephone.

Battery life

If your Panasonic battery is fully charged, the battery life will be as follows.

While in use (on conversation)	Up to about 8 hours
While not in use (stand-by/off the main unit)	Up to about 21 days

Note:

- Battery life may vary depending on usage conditions and ambient temperature.

Recharge

When the RECHARGE indicator flashes or the handset beeps intermittently, place the handset on the cradle to recharge the battery.

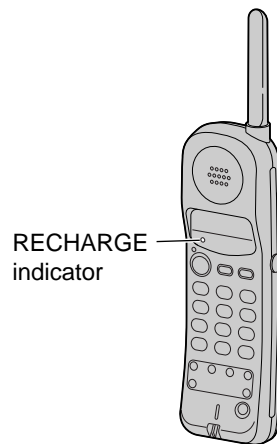

Belt clip

Wearing the belt clip

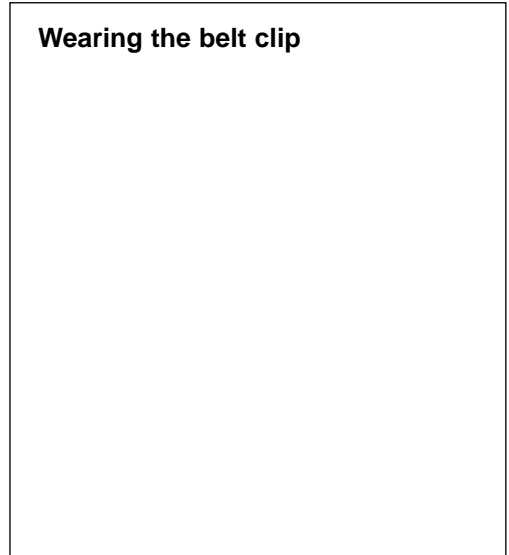

Headset (not included)

Plugging the headset into the handset allows a hands-free telephone conversation. For best results, use the Panasonic headset Model No. KX-TCA87. To order, see page 9.

■ To connect the headset

Open the headset jack cover, and connect the headset to the headset jack as shown below.

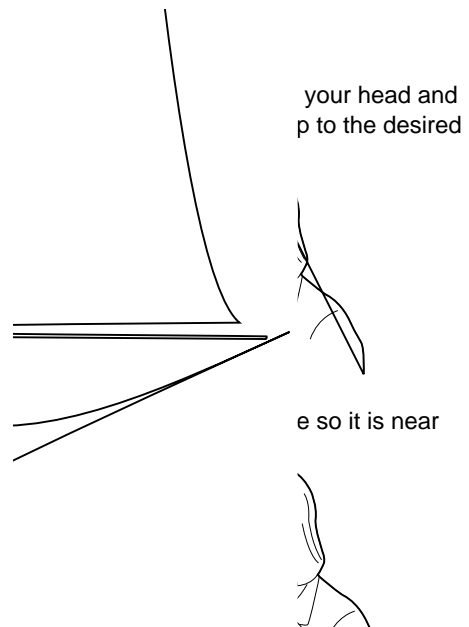
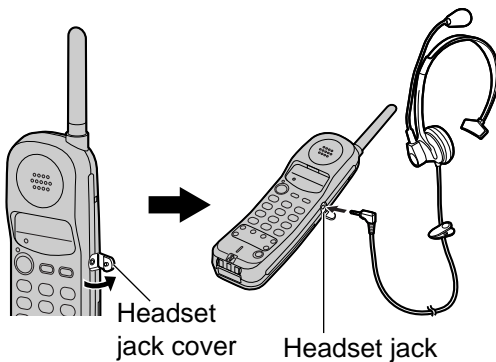

Volumes

Adjusting volumes

Handset

Ringer volume

3 levels (high/low/off) are available.

Make sure the TALK indicator is off.

1. Press **LOUD/RINGER**.
 - The current ringer will sound.
2. To change the volume, press **LOUD/RINGER** again within 5 seconds.
 - The new ringer will sound.
 - If you do not press **LOUD/RINGER** within 5 seconds, the volume will not change.

■ To turn the ringer off:

Press and hold **LOUD/RINGER** until 2 beeps sound.

- To turn the ringer back on, press **LOUD/RINGER**. It will sound at a high level.

■ While the ringer volume is set to off:

When receiving a call, the handset will not ring, and the TALK indicator will flash.

Handset volume

3 levels (high/middle/low) are available.

While talking, press **LOUD/RINGER.**

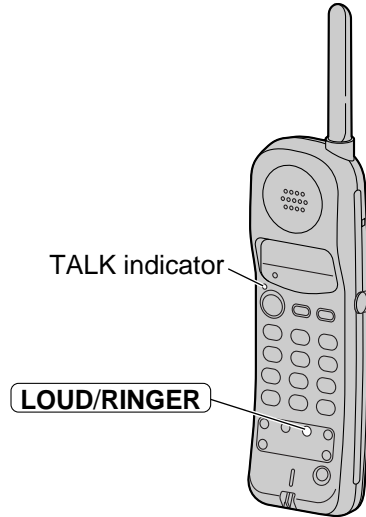

Main unit

Ringer volume

4 levels (high/middle/low/off) are available.

While the unit is idle, press **▲ or **▼**.**

■ To turn the ringer off:

1. Press **▼** repeatedly until the following message is displayed.

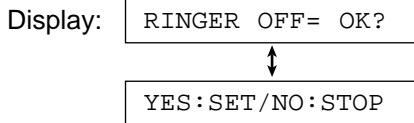

2. Press **SET**.

- To turn the ringer back on, press **▲**.

■ While the ringer volume is set to off:

The display will show the following message.



When a call is received, the unit will not ring and will show the following message.



Monitor volume

8 levels (high to low) are available.

While using the monitor, press **▲ or **▼**.**

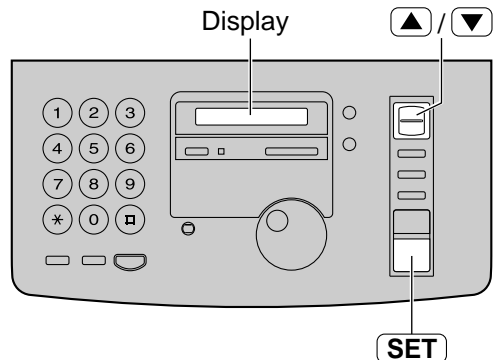

Voice calls - ma

1

Use

TALK

TALK

Handset is on

Lift the handset

TALK

- The TALK indicator light.

2

ial the

If you

again

3

When fir

press TALK

place the

the main un

• The T

Making and Answering Calls

With the main unit

- 1 Press **MONITOR** .
Display:
- 2 Dial the telephone number.
Example:
 - If you misdial, hang up and dial again.
- 3 When the other party answers, speak with the handset.
- 4 When finished talking, replace the handset.

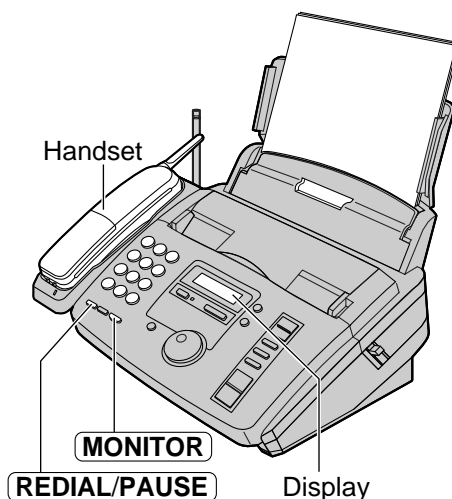

Note:

- If the TALK button on the handset is pressed while using the main unit, the call is switched to the handset and the main unit is disconnected.
- The dialing mode is set to "TONE" as a default setting. If you cannot dial, change to "PULSE" with feature #13 (p. 55).

To redial the last number

Regardless of whether the main unit or the handset was used, the last number dialed will be redialed.

1. Press **MONITOR** .
2. Press **REDIAL/PAUSE** .
3. When the other party answers, speak with the handset.

Making and Answering Calls

- 1** ■ **Handset is off the main unit:**
 - Press **TALK** when the handset rings.
 - You can also answer a call by pressing any dial key 0 to 9, * or #.
(Any key talk feature)
 - **Handset is on the main unit:**
 - Lift the handset when the main unit rings.
- 2** When finished talking, press **TALK** or place the handset on the main unit.

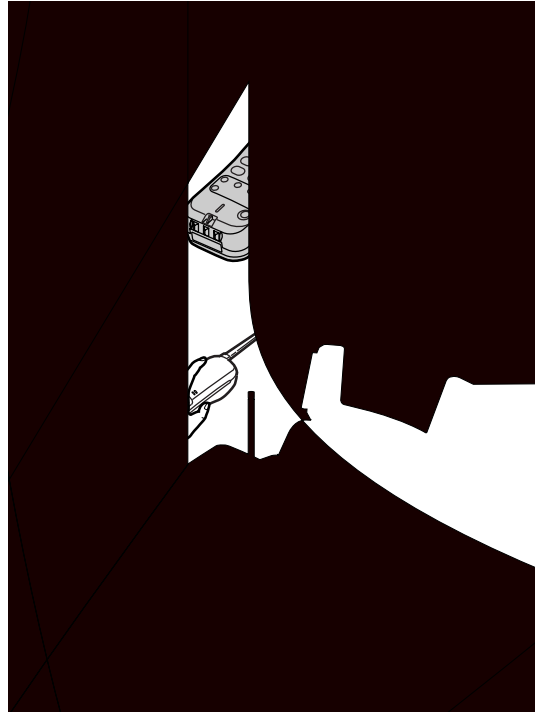

Making and Answering Calls

Remote monitor

Switching a call to the MONITOR with the handset

- 1 Press **REMOTE SP** on the handset during a call.
 - The TALK indicator flashes.
 - The call is switched to the main unit.
- 2 When you hear the other party answer, press **TALK** on the handset to begin the conversation.
 - To hang up, press **TALK**.

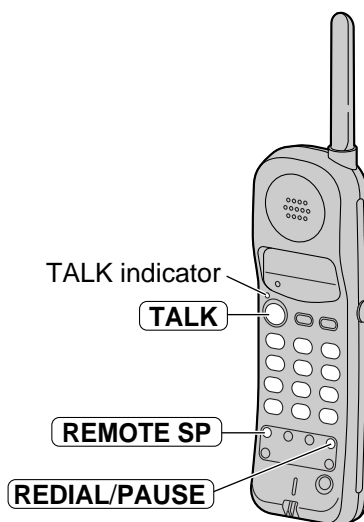

Making a call using the handset as a remote control

- 1 Press **REMOTE SP**.
Display:
- 2 Dial the telephone number.
 - You can also dial with the main unit keypad.Example:
- 3 When you hear the other party answer, press **TALK** on the handset to begin the conversation.
- 4 To hang up, press **TALK**.

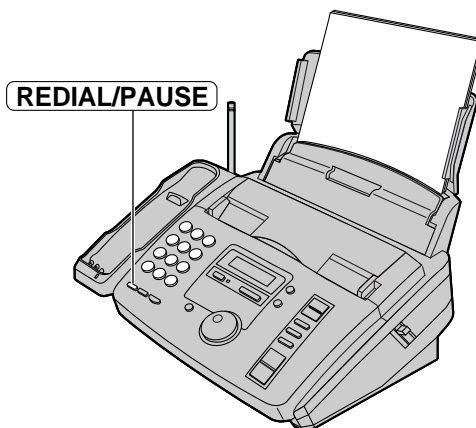

To redial the last number

Regardless of whether the main unit or the handset was used, the last number dialed will be redialed.

1. Press **REMOTE SP**.
2. Press **REDIAL/PAUSE**.

Making and Answering Calls

TONE, FLASH and PAUSE buttons

TONE button

The **TONE** (*) button is used for rotary pulse dial services and allows you to temporarily change from pulse to tone mode during a dialing operation.

When you hang up, the unit will automatically return to the pulse mode.

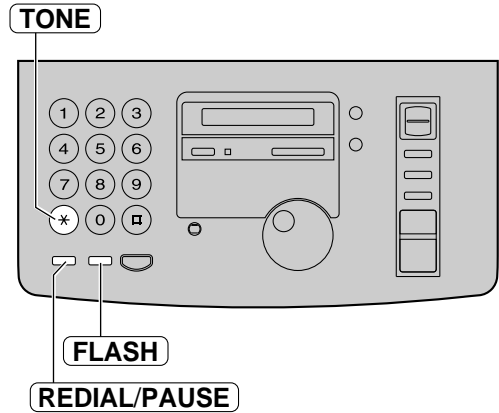

FLASH button

The **FLASH** button also allows you to use special features of a host exchange (if connected) or local telephone company services such as call waiting. For further details, contact your host exchange supplier or local telephone company.

Entering pauses

When the **REDIAL/PAUSE** button is pressed during dialing, a pause will be inserted.

Example 1:

If your unit is connected to a host exchange, insert a pause to get an outside line.



Line access code

Example 2:

If a transmission error occurs during an overseas fax transmission, add two pauses at the end of the telephone number.

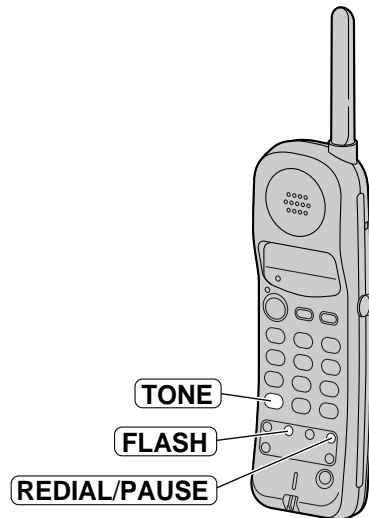
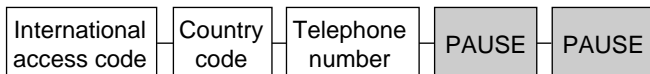

Note:

- TONE and PAUSE can be stored into a telephone number in the JOG DIAL directory.

Automatic Dialing (Handset)

Storing telephone numbers in the handset

You can store up to 10 telephone numbers in the handset. The dial keys (0 to 9) function as memory stations. Make sure the TALK indicator is off.

- 1 Press **PROGRAM**.
 - The TALK indicator will flash.
- 2 Enter the telephone number up to 22 digits.
 - If you misdial, press **PROGRAM** to end storing, and start again from step 1.
- 3 Press **AUTO**.
- 4 Press a memory station number (0 to 9).
 - A one beep confirmation tone will sound.
 - The TALK indicator will turn off.
 - To store other numbers, repeat steps 1 to 4.

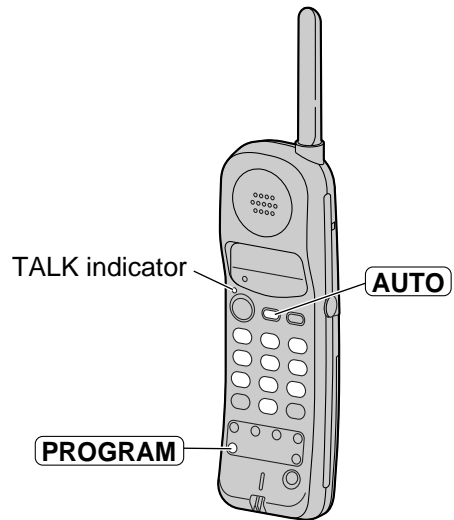

Note:

- Numbers stored in the handset cannot be accessed by the main unit.
- A pause entered in a telephone number counts as one digit.

To erase a stored number

1. Press **PROGRAM**.
2. Press **AUTO**.
3. Press the memory station number (0 to 9) you want to erase.
 - 1 beep sounds and erasing is completed.

Making a voice call with the handset using stored numbers

- 1 Press **TALK**.
 - The TALK indicator will light.
- 2 Press **AUTO**.
- 3 Press the desired memory station number (0 to 9).
 - The stored telephone number will be dialed.
- 4 When finished talking, press **TALK**.
 - The TALK indicator will turn off.

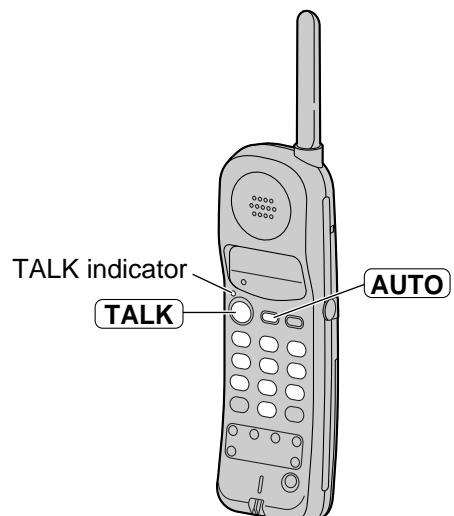

Note:

- Numbers stored in the handset cannot be accessed by the main unit.
- For further details on handset operation, see page 23.

Automatic Dialing (Handset)

Storing a telephone number in the DIRECT button

You can store a telephone number in the **DIRECT** button. The stored number can be dialed with a one-touch operation.

The **TALK** indicator light must be off before programming.

- 1 Press **PROGRAM**.
 - The TALK indicator will flash.
- 2 Enter a telephone number up to 22 digits.
 - If you misdial, press **PROGRAM** to end storing, then start from step 1.
- 3 Press **DIRECT**.
 - A beep sounds.

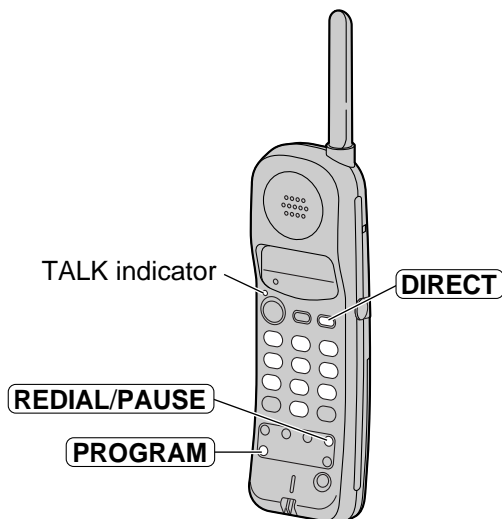

Note:

- If a pause is required for dialing, press **REDIAL/PAUSE** where needed. Pressing **REDIAL/PAUSE** counts as one digit.

To erase a stored number

1. Press **PROGRAM**.
2. Press **DIRECT** for the telephone number to be erased.

Dialing a stored number in the DIRECT button

- 1 Press **TALK**.
- 2 Press **DIRECT**.
 - The stored telephone number will be dialed.

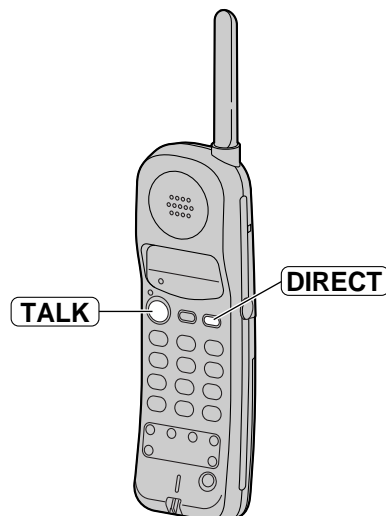

Storing names and telephone numbers in the JOG DIAL directory

For rapid access to frequently dialed numbers, the unit provides a JOG DIAL directory (50 stations).

For your convenience, the following station has been pre-programmed.

HELP-FAX (1-800-435-7329): If you cannot correct a problem after trying the help function (p. 10), call using this station (p. 33).

If you do not need the above station, you can erase it (p. 32).

1 Press **DIRECTORY PROGRAM** .

Display:

↓

2 Rotate **JOG DIAL** until the following is displayed.

3 Enter the name, up to 10 characters, by following the instructions on the next page.

Example:

4 Press **SET** .

5 Enter the telephone number, up to 30 digits, using the dial keypad.

Example:

• If you want to enter a hyphen, press **FLASH** .

6 Press **SET** .

↓

• To program other items, repeat steps 3 to 6.

7 Press **DIRECTORY PROGRAM** to exit the program.

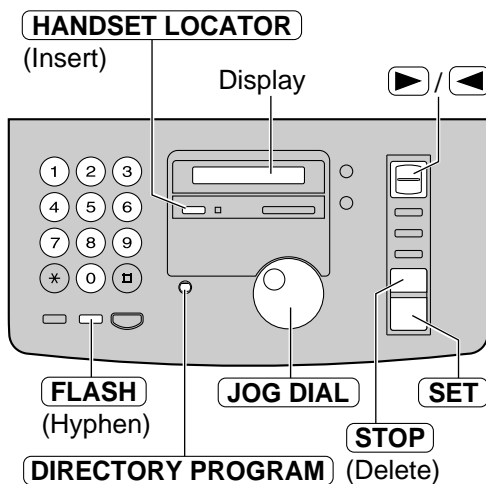

Helpful hint:

- You can confirm the stored items on the display (p. 33) or on the telephone number list (p. 76).

Note:

- When the following message is displayed in step 6, you can only store 5 more items.

Display:

- If there is no space to store new stations, the following message is displayed in step 1.

Erase unnecessary stations (p. 32).

- A hyphen or a space entered in a telephone number counts as two digits.

To correct a mistake



- Press **▶** or **◀** to move the cursor to the incorrect character/number, and make the correction.

To delete a character/number

- Move the cursor to the character/number you want to delete and press **STOP** .

To select characters with the dial keypad

Pressing the dial keys will select a character as shown below.

Keys	Characters
①	1 [] { } + - / = , . _ ` : ; ?
②	A B C a b c 2
③	D E F d e f 3
④	G H I g h i 4
⑤	J K L j k l 5
⑥	M N O m n o 6
⑦	P Q R S p q r s 7
⑧	T U V t u v 8
⑨	W X Y Z w x y z 9
⑩	0 () < > ! " # \$ % & ¥ * @ ^ ' →
FLASH	Hyphen button (To insert a hyphen.)
HANDSET LOCATOR	Insert button (To insert one character or one space.)
STOP	Delete button (To delete a character.)
	▶ key (To move the cursor to the right.) To enter another character using the same number key, move the cursor to the next space.
	◀ key (To move the cursor to the left.)

To select characters using the JOG DIAL

Instead of pressing the dial keys, you can select characters using the JOG DIAL.

1. Rotate **JOG DIAL** until the desired character is displayed.
2. Press  to move the cursor to the next space.
 - The character displayed in step 1 is inserted.
3. Return to step 1 to enter the next character.

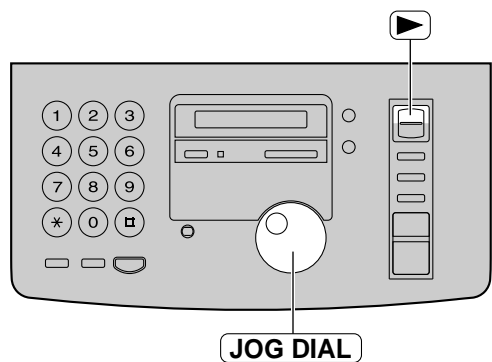

Display order of characters

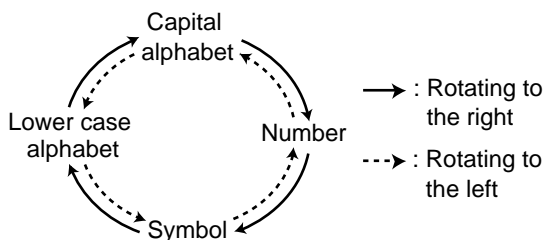

JOG DIAL

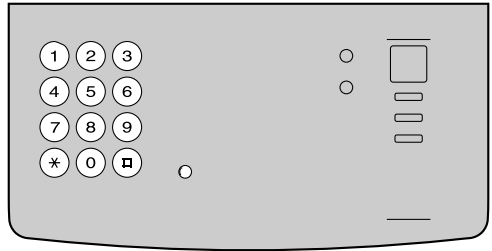

Making a voice call using the JOG DIAL directory

Before using this feature, program the desired names and telephone numbers into the directory (p. 30).

- 1 Rotate **JOG DIAL** until the desired name is displayed.

Example:

- 2 ■ **Handset is off the main unit:**
Press **TALK** on the handset.
■ **Handset is on the main unit:**
Press **MONITOR** or lift the handset.
● The unit will start dialing automatically.

- 3 When the other party answers, speak with the handset.

- 4 When finished talking, press **TALK** or replace the handset.

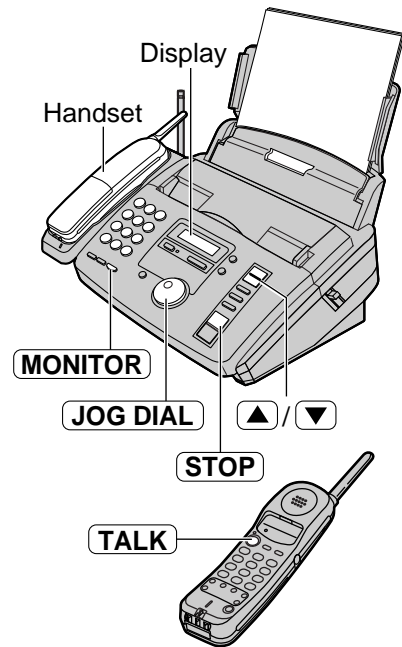

Helpful hint:

- You can confirm the stored items on the display (see below) or on the telephone number list (p. 76).

Note:

- If the desired name has not been stored, press **STOP** and dial the number manually.

To confirm the stored items on the display

1. Rotate **JOG DIAL** until the desired name is displayed.

Example:

2. Press **▲** or **▼**.

- To stop the operation, press **STOP**.
3. ■ **Handset is off the main unit:**
Press **TALK** on the handset.
■ **Handset is on the main unit:**
Press **MONITOR** or lift the handset.
● The unit will automatically dial the number.

To search for a name by initial

Example: If you want to search for the name "Lisa"

1. Rotate **JOG DIAL** until any name is displayed.

Example:

2. Press **5** repeatedly until any name with the initial "L" is displayed (see the character table on page 31).

3. Rotate **JOG DIAL** to the right until "Lisa" is displayed.

- To stop the operation, press **STOP**.
4. ■ **Handset is off the main unit:**
Press **TALK** on the handset.
■ **Handset is on the main unit:**
Press **MONITOR** or lift the handset.
● The unit will automatically dial the number.

Note:

- When you want to search for symbols (not letters or numbers), press **✖** in step 2.

Voice Contact

Talking to the other party after fax transmission or reception

You can talk to the other party after a fax message is completed. This will save the added expense and time of making another call.

This feature only works when the other party's fax machine is equipped with a voice contact feature.

Initiating voice contact

- 1 Press **MONITOR** while transmitting or receiving documents.

Display: VOICE STANDBY

- Your unit will call the other party with a distinctive ring.
- When the other party answers, your unit will emit a distinctive ring.

- 2 To start talking, press **TALK** on the handset or lift the handset from the main unit.

Note:

- If you initiate voice contact during transmission, the unit will call you with a distinctive ring after all of the documents have been transmitted.
- If you initiate voice contact during reception, the unit will call you with a distinctive ring after the current page of the document has been received.

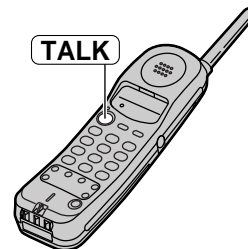
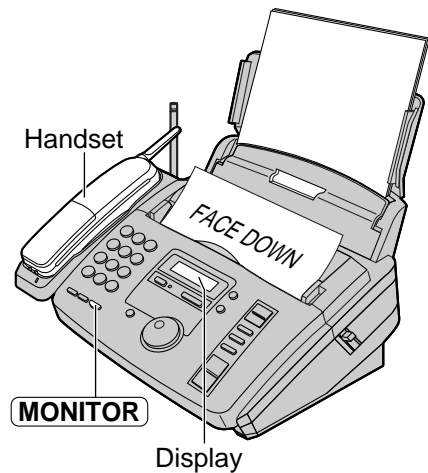

Receiving a request for voice contact

- 1 If the other party initiates voice contact, your unit will sound a distinctive ring and the following will be displayed.

Display: PLEASE PICK UP

- 2 To start talking, press **TALK** on the handset or lift the handset from the main unit within 10 seconds of the distinctive ring.

Sending a fax manually/using the JOG DIAL directory

- 1 Adjust the width of the document guides to the size of the document.
- 2 Insert the document (up to 10 pages) **FACE DOWN** until a single beep is heard and the unit grabs the document.

Display:

- 3 If necessary, press **RESOLUTION** repeatedly to select the desired setting (see right).

Manually

- 4 Press **MONITOR** on the main unit.

- 5 Dial the fax number.

Example:

- 6 **When a fax tone is heard:** Press **FAX START**.

OR

When the other party answers your call: Lift the handset and ask them to press their start button. When a fax tone is heard, press **FAX START** and replace the handset.

Using the JOG DIAL directory

- 4 Rotate until the desired name is displayed.

Example:

- To confirm the number, press or .
- For further details about using the JOG DIAL, see page 33.

- 5 Press **FAX START**.

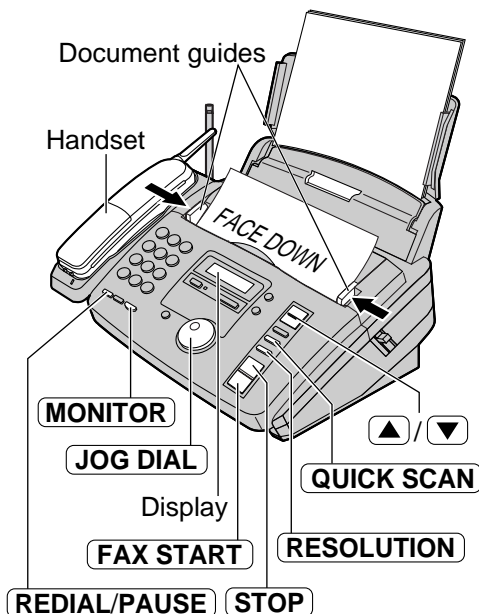

To select the resolution

Select the desired resolution according to the type of document.

STANDARD: For printed or typewritten originals with normal-sized characters.

FINE: For originals with small printing.

SUPER FINE: For originals with minute printing.

HALF TONE: For originals containing photographs, shaded drawings, etc.

- Using the "FINE", "SUPER FINE" or "HALF TONE" setting will increase the transmission time.
- If the resolution setting is changed during feeding, it will be effective from the next sheet.
- The "SUPER FINE" resolution only works with other compatible fax machines.

From memory

You can press **QUICK SCAN** instead of to scan the document into memory before sending. After storing, the unit will transmit the document.

- The memory capacity is approx. 25 pages based on the ITU-T No. 1 Test Chart in standard resolution (p. 81).
- If the document exceeds the memory capacity, sending will be canceled.

Sending Faxes

To transmit more than 10 pages at a time

Insert the first 10 pages of the document. Add the extra pages (up to 10) before the last page is fed into the unit.

To stop transmission

Press **STOP**.

To redial the last number

Regardless of whether the main unit or the handset was used, the last number dialed will be redialed.

Press **REDIAL/PAUSE**.

- If the line is busy, the unit will automatically redial the number up to 2 times.
- During redial, the following will be displayed.

Display: WAITING REDIAL

- To cancel redialing, press **STOP**.

Convenient way to send a fax

You can dial the fax number first before inserting the document. This is convenient if the other party's number is indicated on the document.

1. Enter the fax number.
 - The handset must be on the cradle.
2. Insert the document.
3. Press **FAX START**.

Fax auto redial for the JOG DIAL directory

If the line is busy or there is no answer when using the JOG DIAL directory, the unit will automatically redial the number up to 2 times.

- This feature is also available for delayed transmission (feature #25 on page 56).
- During redial, the following will be displayed.

Display: WAITING REDIAL

- To cancel redialing, press **STOP**.

If your unit does not send a fax using the JOG DIAL directory

- Confirm the stored items on the display (p. 33) or on the telephone number list (p. 76).
- Check that the number dialed is answered by the other party's machine.

1. Rotate **JOG DIAL** until the desired name is displayed.
2. Press **MONITOR**.
 - The connecting tone will be heard during dialing to tell you the status of the other party's machine (feature #76 on page 59).

Documents you can send

Minimum size

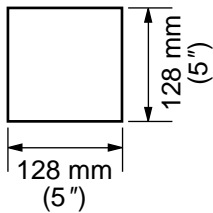

Maximum size

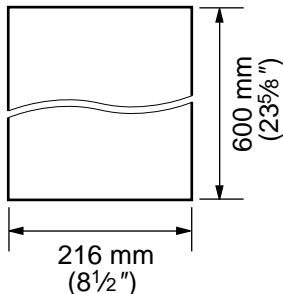

Effective scanning area

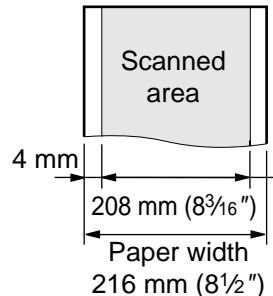

Document weight

Single sheet:
45 g/m² to 90 g/m²
(12 lb. to 24 lb.)

Multiple sheets:
60 g/m² to 75 g/m²
(16 lb. to 20 lb.)

Note:

- Remove clips, staples or other similar fastening objects.
- Check that ink, paste or correction fluid has dried.
- Do not send the following types of documents. Use copies for fax transmission.
 - Chemically treated paper such as carbon or carbonless duplicating paper
 - Electrostatically charged paper
 - Heavily curled, creased or torn paper
 - Paper with a coated surface
 - Paper with a faint image
 - Paper with printing on the opposite side that can be seen through the front (e.g. newspaper)

Reports for confirmation

To confirm the communication results, the following reports are available.

Sending report

This report will provide you with a printed record of transmission results. To use this feature, activate feature #04 (p. 55).

Sample of a sending report

SENDING REPORT									
Jan. 20 2000 09:19AM									
YOUR LOGO :									
YOUR FAX NO. :									
NO.	OTHER FACSIMILE	START TIME	USAGE TIME	MODE	PAGES	RESULT	*CODE		
01	2345678	Jan. 20 09:18AM	00'51	SND	00	COMMUNICATION ERROR	43		

SND: Sent directly.	Communication message (p. 60)	Error code message (p. 60)
---------------------	-------------------------------	----------------------------

Journal report

The unit stores the 30 most recent fax communication results. When a new communication occurs, the oldest communication result will be erased.

- To print manually, see page 76.
- To print automatically after every 30 new fax communications, select “ON” with feature #22 (p. 56). If you select “OFF”, the unit will not print the journal automatically but store the records of fax communications.

Sample of a journal report

JOURNAL									
Jan. 25 2000 11:22AM									
YOUR LOGO :									
YOUR FAX NO. :									
NO.	OTHER FACSIMILE	START TIME	USAGE TIME	MODE	PAGES	RESULT	*CODE		
01	3332222	Jan. 21 07:14AM	00'45	SND	01	OK			
02	9998765	Jan. 21 08:17AM	00'58	RCV	02	OK			
03	John	Jan. 21 09:18AM	00'48	RCV	01	OK			
04	55556666	Jan. 21 10:25AM	02'45	SND	03	COMMUNICATION ERROR	43		
				SND	05	OK			
				SND	02	OK			

SND: Sent directly.	Communication message (p. 60)	Error code message (p. 60)
RCV: Received directly.		

Sending Faxes

One time broadcast transmission

This feature is useful for sending the same document to selected parties whose fax numbers are stored in the JOG DIAL directory. If you only wish to send a document once, select the parties for each transmission.

Before programming, make sure that the desired stations have been stored in the JOG DIAL directory (p. 30).

- 1 Insert the document **FACE DOWN**.
 - If necessary, press **RESOLUTION** repeatedly to select the desired setting (p. 35).
- 2 Rotate **JOG DIAL** until the following is displayed.
Display: <ONE TIME BROAD>
- 3 Press **SET**.
DIR= [000]
- 4 Rotate **JOG DIAL** until the desired name is displayed.
Example: Bill [000]
- 5 Press **SET**.
DIR=Bill [001]
 - To program other stations, repeat steps 4 and 5 (up to 20 stations).
- 6 Press **FAX START** after programming all of the desired stations.
 - The document will be fed into the unit and scanned into memory. The unit will then transmit the data to each station, calling each number sequentially.
 - After transmission, the stored document will be erased automatically, and the unit will automatically print a broadcast sending report (p. 41).

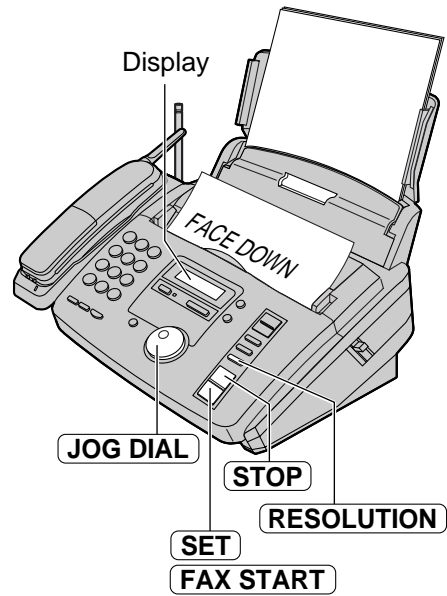

Note:

- If you select the "FINE", "SUPER FINE" or "HALF TONE" resolution, the number of pages that the unit can transmit will decrease.
- If one of the stations is busy or does not answer, the station will be skipped. All skipped stations will be redialed up to 2 times after all of the other stations have been called.

To cancel the broadcast setting

1. Press **STOP** while the unit displays the following message.

Display: BROADCASTING

- The display will show the following.

SEND CANCELED?
↑
YES:SET/NO:STOP

2. Press **SET**.

Programming the stations in the broadcast memory

1 Press twice.
Display:

Sending Faxes

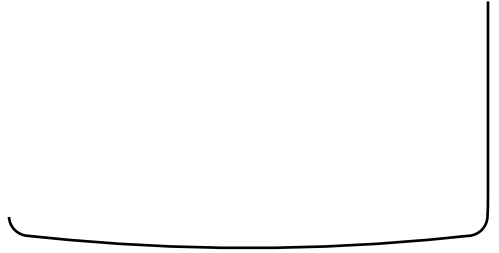

*

Sending to pre-programmed parties in the broadcast memory

The same document will be sent to the specific parties whose numbers are stored in broadcast memory.

The memory capacity is approx. 25 pages based on the ITU-T No. 1 Test Chart in standard resolution (p. 81).

- 1 Insert the document **FACE DOWN**.
 - If necessary, press **RESOLUTION** repeatedly to select the desired setting (p. 35).

- 2 Rotate **JOG DIAL** until the following is displayed.

Display:

- 3 Press **FAX START**.
 - The document will be fed into the unit and scanned into memory. The unit will then transmit the data to each station, calling each number sequentially.
 - After transmission, the stored document will be erased automatically, and the unit will automatically print a broadcast sending report (see below).

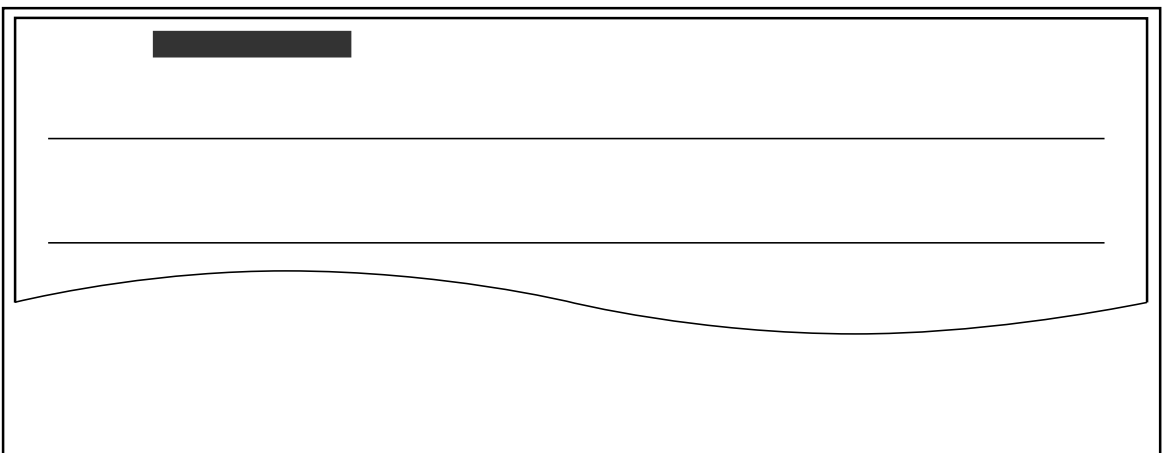
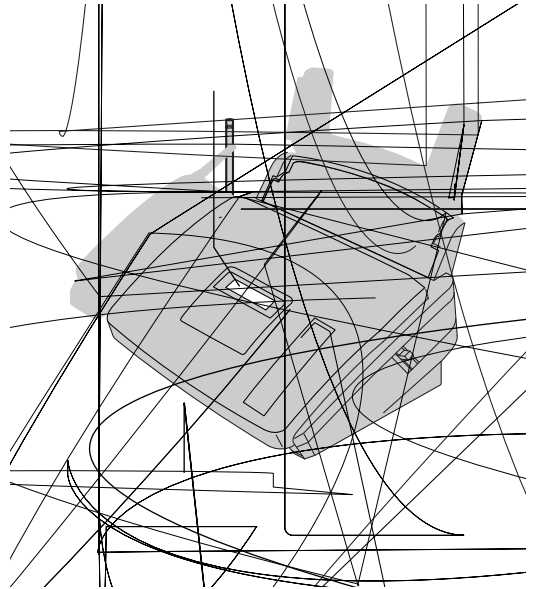

Receiving Faxes

Setting the unit to receive faxes

Use only as fax

With answering machine

How you want the unit to receive calls

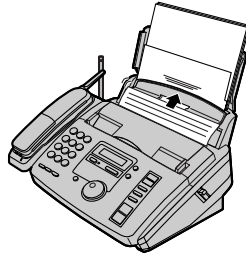

You have a separate telephone line just for faxes.

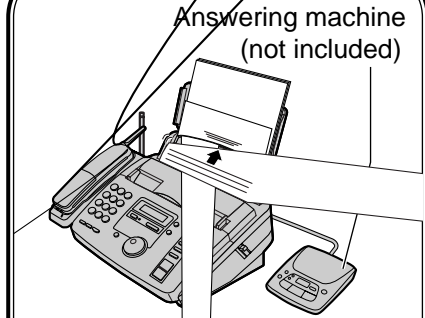

You want to use the fax machine with an answering machine.

You have to set this.

FAX ONLY mode (p. 45)

Turn AUTO ANSWER on by pressing **AUTO ANSWER**, and set the desired ring count (default setting: 3 rings).

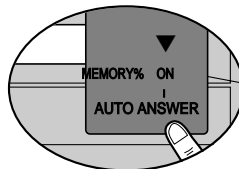

Activating an answering machine (p. 46, 47)

Connect an answering machine and set the ring count of the answering machine to less than 4.

- Set the ring count in the FAX ONLY mode of the fax machine to "5 EXT.TAM", if you use with AUTO ANSWER on.

This is how the unit will operate.

When receiving calls:

All incoming calls will be answered as faxes.

When receiving voice calls:

The answering device will record voice messages.

When receiving fax calls:

The fax machine will disconnect the answering machine and receive documents.

Voice mail service (Distinctive Ring)

2-number example

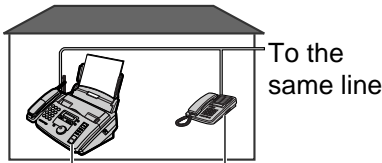

Facsimile No. (555-1333) Telephone No. (555-1111)

You need to subscribe to Distinctive Ring Service.

Mostly voice calls



You plan to answer the calls yourself.

Other options

With PC

If you have a computer attached to the same telephone line, see page 47.

TEL/FAX mode

If you are near the unit and want to use it to receive voice calls yourself and fax calls automatically, see pages 48 and 49.

Setting the Distinctive Ring pattern (feature #31 on page 57)

Select the same ring pattern assigned to the facsimile number.

- A:** Standard ring (one long ring)
- B:** Double ring (two short rings)
- C:** Triple ring (short-long-short rings)
- D:** Other triple ring (short-short-long rings)

TEL mode (p. 44)

Turn AUTO ANSWER off by pressing **AUTO ANSWER**.

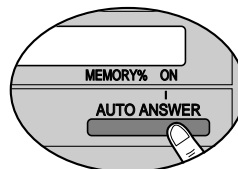

When the fax machine detects a call matching the selected Distinctive Ring pattern: The fax machine will activate the fax function.
When the fax machine detects other ring patterns: The fax machine will operate based on the AUTO ANSWER setting.

When receiving calls: You have to answer all calls manually.
To receive a fax document, press **FAX START** for each fax call.

Remote fax activation

You can also receive a fax from an extension phone. If you answer a call with an extension phone and hear the fax calling tone, press *** 9** (pre-selected fax activation code) to receive a fax (p. 50).

Receiving Faxes

- 1** When the unit rings, lift the handset to answer the call.
- 2** When:
 - document reception is required,
 - a fax calling tone (slow beep) is heard, or
 - no sound is heard,press **FAX START**.

CONNECTING.....

- 3** Replace the handset.
 - The unit will start fax reception.

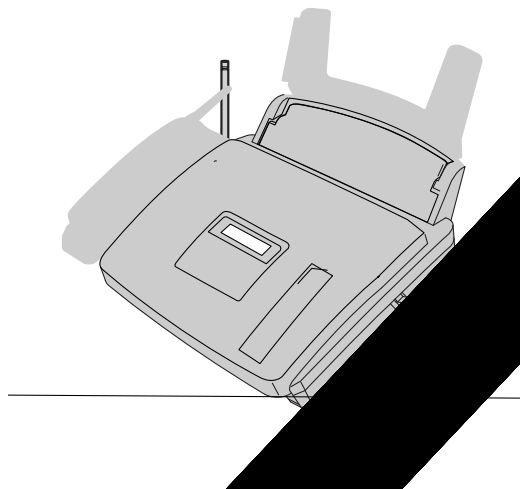

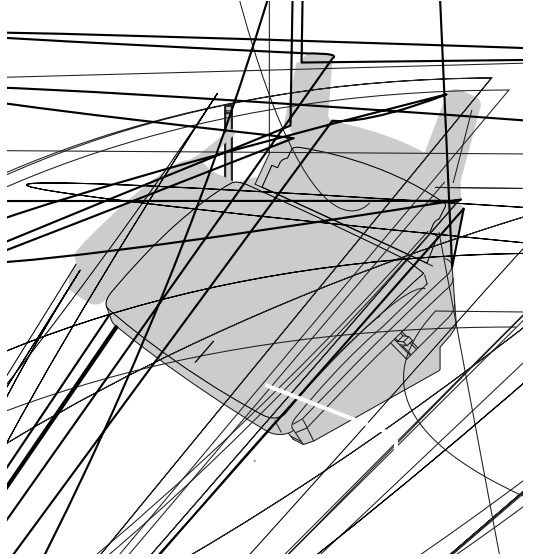

Receiving Faxes

Using the unit with an answering machine

Setting up the fax machine and an answering machine

- 1 Connect the answering machine.

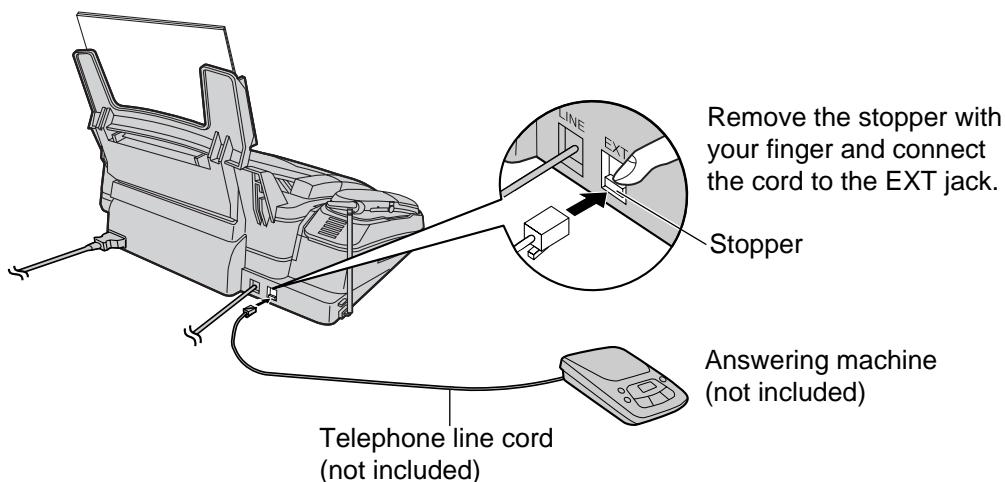

- 2 Set the number of rings on the answering machine to less than 4.
 - This will allow the answering machine to answer the call first.
- 3 Record a greeting message on the answering machine.

Example: *"This is (your name, business and/or telephone number). We are unable to answer the phone right now. To send a fax, start transmission. To leave a message, please speak after the beep. Thank you."*
- 4 Activate the answering machine.
- 5 Set the receive mode of the fax machine to the TEL mode (p. 44) or FAX ONLY mode (p. 45).
 - If you set to the FAX ONLY mode, **set the ring count in the FAX ONLY mode to "5 EXT.TAM" (feature #06 on page 55)**. Using the FAX ONLY mode will allow you to receive faxes if the answering machine is full.
- 6 Check the remote access code of the answering machine and program the same code into the remote operation ID of the fax machine. See feature #12 on page 55.

Note:

- Do not pause for more than 4 seconds during the greeting message. If a 4-second pause is stored in the greeting message, all incoming calls will be routed to the fax machine from the answering machine even while the greeting message is playing.
- We recommend you keep the greeting message to around 10 seconds long. If the greeting message is too long, some incoming fax calls may not be answered by the fax machine.
- Every time the fax machine receives a document, a silent pause or fax tone may be recorded on the answering machine.

How the fax machine and answering machine work

Receiving voice calls

The answering machine will record voice messages automatically.

Receiving fax calls

The fax machine will receive documents automatically.

Receiving a voice message and fax document in one call

The answering machine will record the voice message first. The fax machine will then be activated by the caller's request and will receive the document.

Receiving a voice message and fax document in one call

The caller can leave a voice message and send a fax document during the same call. Inform the caller of the following procedure beforehand.

1. The caller calls your fax machine.
 - The answering machine will answer the call.
2. The caller can leave a message after the greeting message.
3. The caller presses *** 9** (pre-selected fax activation code).
 - The fax machine will activate the fax function.
4. The caller presses the start button to send a document.

Note:

- The fax activation code can be changed in feature #41 (p. 58).
- If the wrong fax activation code is entered, the caller must wait at least 5 seconds to reenter the correct code.

To use with an answering machine and computer

We recommend that you always connect the fax machine directly to the wall jack.

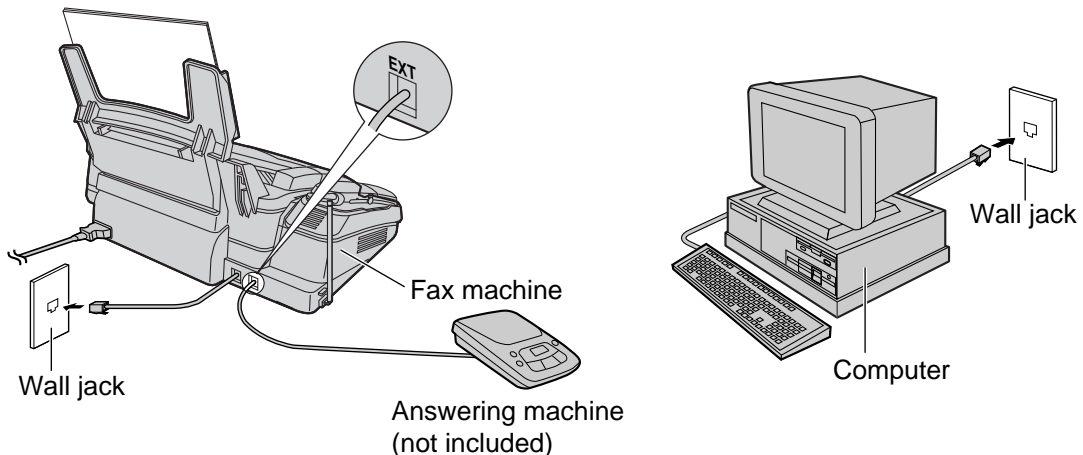

Note:

- Set the fax machine to the TEL mode.
- The device which has the shortest ring count will answer a call first.
- If you use your computer as an answering machine, connect the telephone line cord from the EXT jack to the computer.

Receiving Faxes

TEL/FAX mode (receiving voice calls with rings and fax calls without rings when you are near the unit)

Use this mode when you are always near the fax machine, and want to receive faxes without ringing. When a call is received, the fax machine will work as follows. To set the TEL/FAX mode, see below.

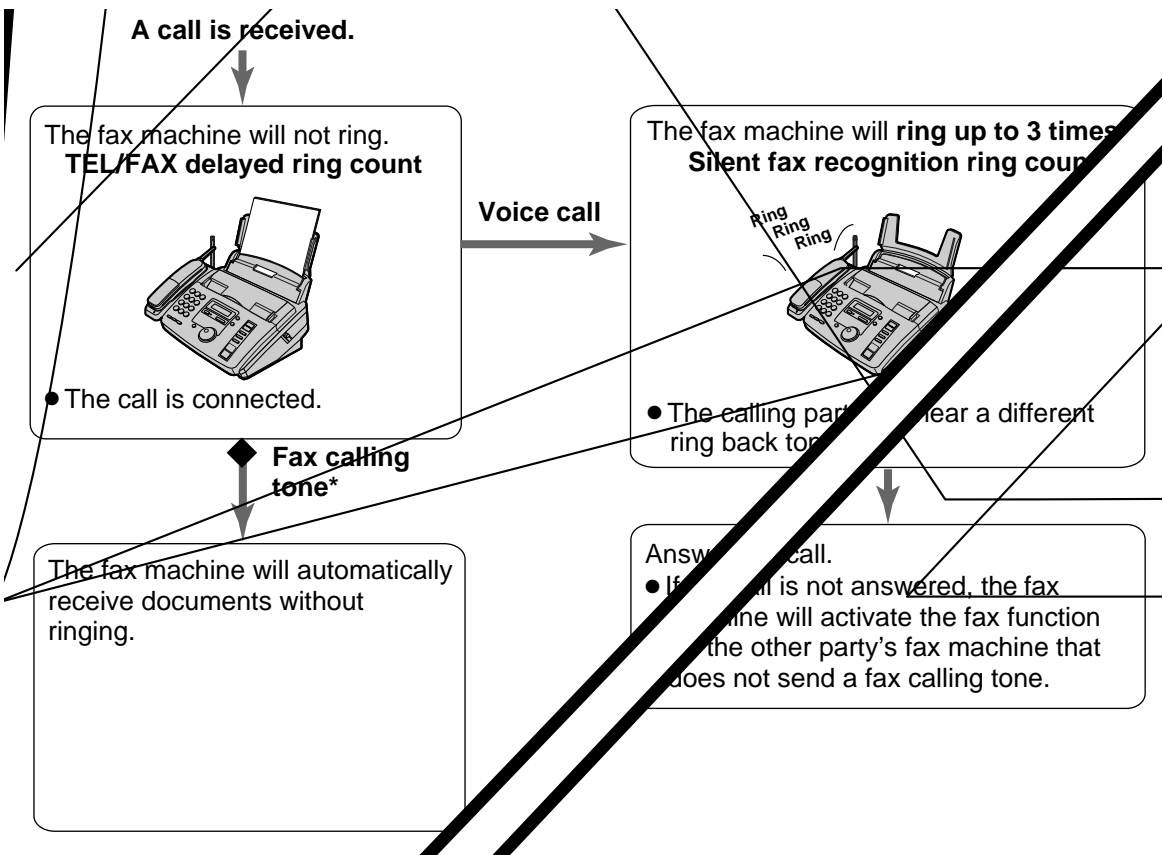

Note:

- The fax machine will display the following when a call is received.

Display: INCOMING CALL

- The ringer should be on (p. 22).

To set the TEL/FAX mode

1. Set feature #77 to "TEL/FAX" (p. 59).
2. If the arrow (▼) is not shown on the right of the display, turn it on by pressing AUTO ANSWER.

Display: ▼
ON

When an extension telephone is connected

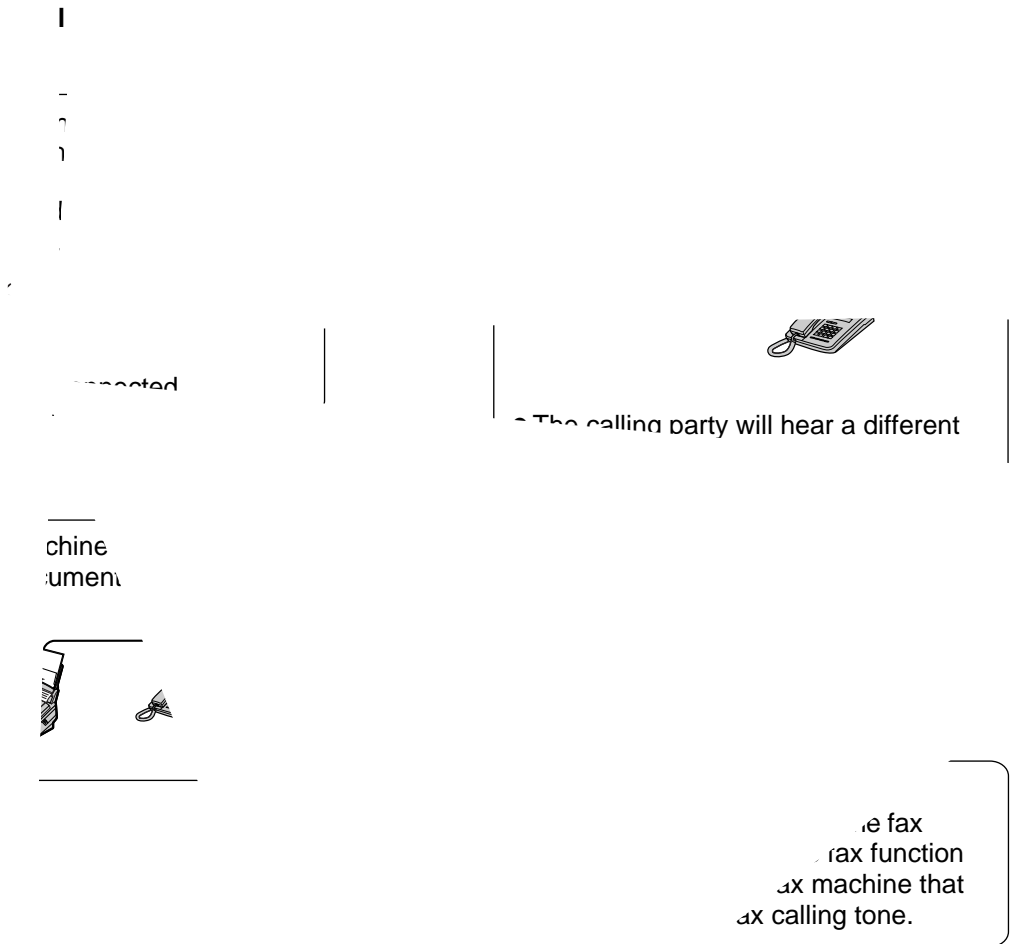

TEL/FAX delayed ring count

The number of rings generated before the fax machine answers depends on the setting of feature #78 on page 59. The fax machine will not generate an audible ring during this time.

Silent fax recognition ring count

The fax machine generates audible rings to indicate that it is receiving a voice call. The number of rings generated depends on the setting of feature #30 on page 57. This signal will not ring at an extension telephone.

Receiving Faxes

Extension telephone

If you use the fax machine with an extension telephone, you can receive fax documents using the extension telephone.

You do not have to press **FAX START** on the fax machine.

Important:

- Use a touch tone telephone as the extension telephone and enter the fax activation code **firmly**.

1 When the extension telephone rings, lift the handset of the extension telephone.

2 When:
— document reception is required,
— a fax calling tone (slow beep) is heard, or
— no sound is heard,
press *** 9** (pre-selected fax activation code) **firmly**.

3 Hang up the handset.
• The fax machine will start reception.

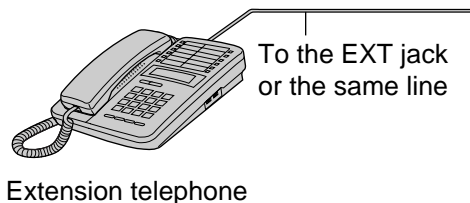

Note:

- You can change the fax activation code in feature #41 (p. 58).

Pager call - when the unit receives a fax

This feature allows your unit to call your pager when your unit receives a fax document.

1 Press **MENU** .
Display: 1 .SYSTEM SET UP

2 Press **#** , then **7 0** .
FAX PAGER CALL

3 Press **SET** .
MODE=OFF ↻

4 Rotate **JOG DIAL** to select "ON".
MODE=ON ↻

- If this feature is not required, select "OFF".

5 Press **SET** .
NO. =

6 Enter your pager number.
• You can enter a total of 46 digits and/or pauses.

Example:

1 202 555 1234PP12345678PP5555#

Your pager number

Pauses

Your pager access code, if required.

Message you want displayed on your pager when your unit receives a fax.

7 Press **SET** .
• The unit will dial the stored number.
PAGER TEST

8 Check that the message is displayed on your pager.

9 Press **MONITOR** .

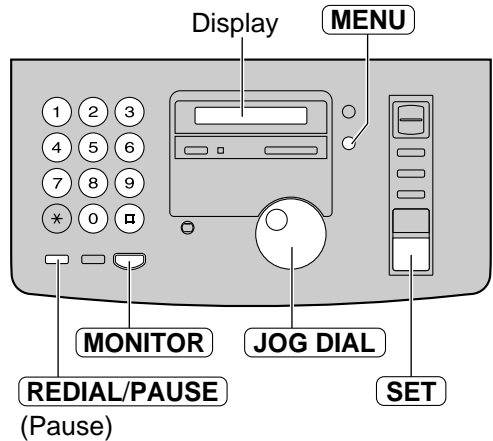

When your pager receives a pager call



Your pager will display the message you entered in step 6 above. (For example: 5555)

Copying

Making a copy

The unit can make single or multiple copies (up to 50). Any transmittable document (p. 36) can be copied.

1 Adjust the width of the document guides to the size of the document.

2 Insert the document (up to 10 pages) **FACE DOWN** until a single beep is heard and the unit grabs the document.

Display:

- If necessary, press **RESOLUTION** repeatedly to select the desired setting (p. 35).

3 Press **COPY START**.

- If necessary, enter the number of copies (up to 50).
- If necessary, choose an enlargement/reduction rate by pressing **COPY ZOOM**. See next page.
- If you want to print collated (sorted) copies, press **COLLATE** until the following is displayed.

4 Press **COPY START**.

- The unit will start printing.
- If you want to remove the copy document for other uses, press **QUICK SCAN** instead of **COPY START**. The unit will feed the document and scan it into memory, then start printing.

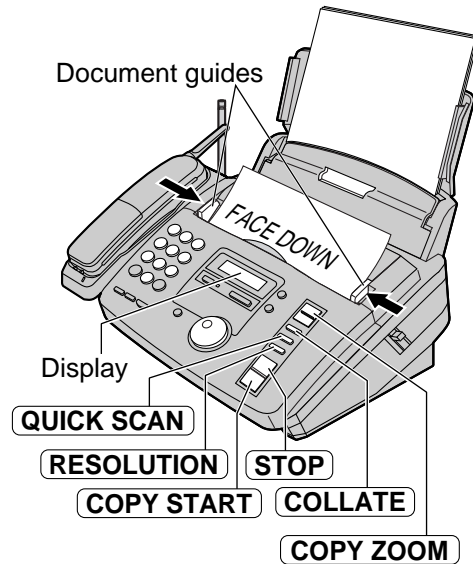

Note:

- If a resolution is not selected, "FINE" resolution will automatically be selected.
- You can make or receive a voice call while making copies.
- After copying, the enlargement/reduction rate setting will return to "100%".

To stop copying

Press **STOP**.

Printing collated (sorted) copies

Example: Making two copies of a 4-page original document

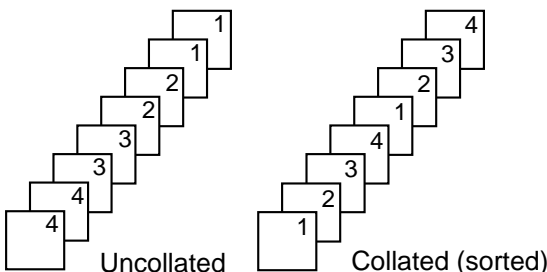

Note:

- If you turn the collating feature on, the unit will store the documents into memory. If memory becomes full while storing, the unit will only print out the stored pages.
- After copying, the collating feature will turn off automatically.

To enlarge a document

Select "200%" or "150%" by pressing **COPY ZOOM** (+). The unit will only enlarge the center part of the document and print it on two pages.

Example of a 200% enlarged copy

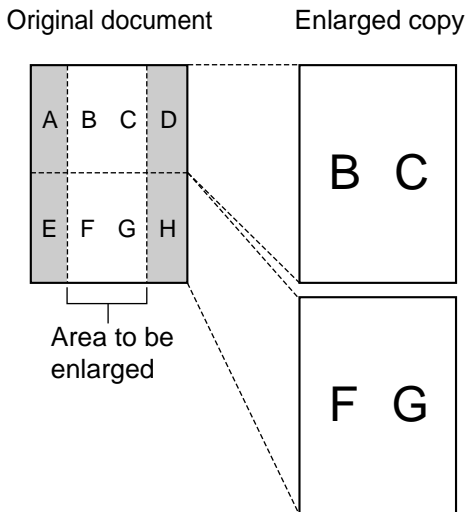

Example of a 150% enlarged copy

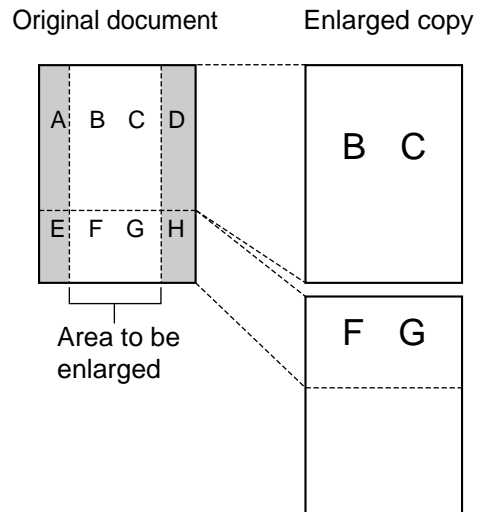

To reduce a document

The unit can reduce the original document.

Select the desired setting by pressing **COPY ZOOM** (-).

Recommended reduction rates:

Setting	Size of recording paper	Size of original document
100% (default)	Letter	Letter
	Legal*	Letter, A4, Legal
92%	Letter	A4
86%	Letter	A4
72%	Letter	Legal

Letter = 216 mm x 279 mm (8¹/₂" x 11")

Legal = 216 mm x 356 mm (8¹/₂" x 14")

A4 = 210 mm x 297 mm (8¹/₄" x 11¹¹/₁₆")

*If you use legal size paper, please purchase a legal paper tray, Model No. KX-FA50 (p. 9) and install it (p. 12).

Note:

- If the appropriate reduction rate is not programmed, the document may be divided and the top of the second sheet will be deleted.

Features Summary

Programming

The unit provides various programming features. Program the desired setting by referring to the programming tables (p. 55–59).

General programming method

1 Press **MENU**.

Display: 1.SYSTEM SET UP

2 Select the feature you wish to program.

■ **For basic features** (p. 55)

Rotate **JOG DIAL** until the desired feature is displayed.

■ **For advanced features** (p. 56–59)

Rotate **JOG DIAL** until the following is displayed.

ADVANCED MODE

Press **SET** and rotate **JOG DIAL** until the desired feature is displayed.

3 Press **SET**.

- The current setting of the feature will be displayed.

4 Rotate **JOG DIAL** until the desired setting is displayed.

- This step may be slightly different depending on the feature.

5 Press **SET**.

- The setting you selected is set, and the next feature will be displayed.

6 To exit programming, press **MENU**.

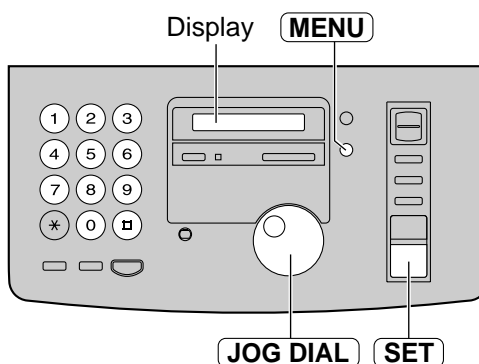

Programming by entering the program code number directly

You can select a feature by directly entering the program code (# and 2-digit number) instead of using **JOG DIAL**.

1. Press **MENU**.

2. Press **#** and the 2-digit code number.

3. Follow steps 3 to 6 above.

- See programming tables (p. 55–59) for codes.

To cancel programming

Press **MENU** to exit the program.

Basic features

Programming table

Code	Display & Feature	Settings	How the unit operates
#01	<div style="border: 1px solid black; padding: 2px; width: fit-content; margin-bottom: 5px;">SET DATE & TIME</div> To set the date and time	mm/dd/yy hh:mm (2 digits for each entry)	See page 15 for details.
#02	<div style="border: 1px solid black; padding: 2px; width: fit-content; margin-bottom: 5px;">YOUR LOGO</div> To set your logo	(Up to 30 characters)	See pages 16 and 17 for details.
#03	<div style="border: 1px solid black; padding: 2px; width: fit-content; margin-bottom: 5px;">YOUR FAX NO.</div> To set your facsimile telephone number	(Up to 20 digits)	See page 18 for details.
#04	<div style="border: 1px solid black; padding: 2px; width: fit-content; margin-bottom: 5px;">SENDING REPORT</div> To print and check the sending report for fax transmission results	ERROR	“ERROR”: The sending report will be printed only when fax transmission fails (p. 37). “ON”: The sending report will be printed out after every transmission.
		ON	
		OFF	
#06	<div style="border: 1px solid black; padding: 2px; width: fit-content; margin-bottom: 5px;">FAX RING COUNT</div> To change the number of rings before the unit answers a call in the FAX ONLY mode	1, 2, 3 , 4, 5 EXT.TAM	This setting is also available after activating the FAX ONLY mode (p. 45). “5 EXT.TAM” is used when using the unit with an answering machine (p. 46).
#12	<div style="border: 1px solid black; padding: 2px; width: fit-content; margin-bottom: 5px;">REMOTE TAM ACT.</div> If you use the unit with an answering machine, activate this feature and set the remote activation ID for remote operation to secure the remote operation for the answering machine.	ON / ID=11	To select “ON” and enter ID: 1. Press MENU . 2. Rotate JOG DIAL and select this feature. 3. Press SET . 4. Rotate JOG DIAL to select “ON”. 5. Press SET . 6. Enter your ID from 1 to 5 digits, using 0–9, * and #. 7. Press SET . 8. Press MENU .
		OFF	
#13	<div style="border: 1px solid black; padding: 2px; width: fit-content; margin-bottom: 5px;">DIALING MODE</div> If you cannot dial, change the setting depending on your telephone line service.	TONE	“TONE”: For tone dial service. “PULSE”: For rotary pulse dial service.
		PULSE	

(The default setting is in bold type.)

Features Summary

Advanced features

How to set menu options

1. Press **MENU**.
2. Rotate **JOG DIAL** until the following is displayed.
 Display: ADVANCED MODE
 Press **SET** and rotate **JOG DIAL** until the desired feature is displayed.
3. Press **SET**.
4. Rotate **JOG DIAL** until the desired setting is displayed.
5. Press **SET**.
6. Press **MENU**.

Note:

- Step 4 may be slightly different depending on the feature.
- See page 54 for more details.

Programming table

Code	Display & Feature	Settings	How the unit operates
#22	<div style="border: 1px solid black; padding: 2px; display: inline-block;">AUTO JOURNAL</div> To print the journal report automatically for fax communications	ON	"ON": The unit will print the journal report automatically after every 30 new fax communications (p. 37).
		OFF	
#23	<div style="border: 1px solid black; padding: 2px; display: inline-block;">OVERSEAS MODE</div> If you have difficulty sending an overseas fax, activate this feature before starting transmission. This feature makes sending documents easier as the transmission speed is slowed down.	NEXT FAX	"NEXT FAX": For the next attempted fax transmission. After transmission, the unit will return to the previous setting. "ERROR": When previous fax transmission fails and you redial the same number. ● This feature is not available for broadcast transmission. ● The calling charge may be higher.
		ERROR	
		OFF	
#25	<div style="border: 1px solid black; padding: 2px; display: inline-block;">DELAYED SEND</div> To send a fax automatically at a specified time. This allows you to take advantage of low-cost calling hours offered by your telephone company. ● The setting can be reserved to take place up to 24 hours in advance.	ON / fax no. / hh:mm	To send a document: 1. Insert the document. 2. Follow steps 1–3 above. 3. Rotate JOG DIAL to select "ON". 4. Press SET . 5. Enter the fax number. 6. Press SET . 7. Enter the transmission start time. Press * to select "AM" or "PM". 8. Press SET . 9. Press MENU . ● To cancel after programming, press STOP then SET .
		OFF	

(The default setting is in bold type.)

Features Summary

Code	Display & Feature	Settings	How the unit operates																	
#30	<div style="border: 1px solid black; padding: 2px; width: fit-content; margin-bottom: 5px;">SILENT FAX RING</div> To change the number of rings when the unit detects a voice call in the TEL/FAX mode	3, 4, 5, 6	See pages 48 and 49 for details.																	
#31	<div style="border: 1px solid black; padding: 2px; width: fit-content; margin-bottom: 5px;">RING DETECTION</div> If you subscribe to a Distinctive Ring Service (Identa-Ring) from your telephone company, activate this feature. This feature is also required for voice mail service.	A, B, C, D	Select the ring pattern to be assigned to the facsimile number. A: Standard ring (one long ring) B: Double ring (two short rings) C: Triple ring (short-long-short rings) D: Other triple ring (short-short-long rings) • For more information about telephone services, contact your telephone company.																	
		OFF																		
#36	<div style="border: 1px solid black; padding: 2px; width: fit-content; margin-bottom: 5px;">RCV REDUCTION</div> If the size of the document sent by the other party is as large as, or larger than the recording paper, the unit can reduce and print the document. Select the desired reduction rate.	100%	<table border="1" style="width: 100%; border-collapse: collapse;"> <thead> <tr> <th>Setting</th> <th>Recording paper</th> <th>Original document</th> </tr> </thead> <tbody> <tr> <td>100%</td> <td>Legal</td> <td>Letter, A4</td> </tr> <tr> <td rowspan="2">92%</td> <td>Letter</td> <td>Letter</td> </tr> <tr> <td>Legal</td> <td>Legal</td> </tr> <tr> <td>86%</td> <td>Letter</td> <td>A4</td> </tr> <tr> <td>72%</td> <td>Letter</td> <td>Legal</td> </tr> </tbody> </table>	Setting	Recording paper	Original document	100%	Legal	Letter, A4	92%	Letter	Letter	Legal	Legal	86%	Letter	A4	72%	Letter	Legal
		Setting		Recording paper	Original document															
		100%		Legal	Letter, A4															
		92%		Letter	Letter															
				Legal	Legal															
86%	Letter	A4																		
72%	Letter	Legal																		
92%																				
86%																				
72%																				
#39	<div style="border: 1px solid black; padding: 2px; width: fit-content; margin-bottom: 5px;">LCD CONTRAST</div> To adjust the display contrast	NORMAL	“NORMAL”: For normal contrast “DARKER”: Used when the display contrast is too light.																	
		DARKER																		
#40	<div style="border: 1px solid black; padding: 2px; width: fit-content; margin-bottom: 5px;">SILENT DETECT.</div> If you use the unit with an answering machine and wish to receive faxes from older model fax machines, activate this feature.	ON	<ul style="list-style-type: none"> • If the other party’s fax machine does not send a fax calling tone, select “ON”. The unit detects a silent pause and activate the fax function. • If you use an answering machine to give greeting messages and record incoming messages on a single cassette tape, select “OFF”. 																	
		OFF																		

(The default setting is in bold type.)

(continued)

Features Summary

Advanced features (cont.)

How to set menu options

1. Press **MENU**.
2. Rotate **JOG DIAL** until the following is displayed.

Display: ADVANCED MODE

Press **SET** and rotate **JOG DIAL** until the desired feature is displayed.

3. Press **SET**.
4. Rotate **JOG DIAL** until the desired setting is displayed.
5. Press **SET**.
6. Press **MENU**.

Note:

- Step 4 may be slightly different depending on the feature.
- See page 54 for more details.

Programming table (cont.)

Code	Display & Feature	Settings	How the unit operates
#41	<div style="border: 1px solid black; padding: 2px; display: inline-block;">FAX ACTIVATION</div> If you use an extension telephone and wish to use it to receive a fax, activate this feature, and enter the code (p. 50).	ON / CODE= * 9	<ol style="list-style-type: none"> 1. Follow steps 1–3 above. 2. Rotate JOG DIAL to select "ON". 3. Press SET. 4. Enter your code from 2 to 4 digits, using 0–9 and *. 5. Press SET. 6. Press MENU. <ul style="list-style-type: none"> • Do not enter "0000". • This code is also used to receive a voice message and a fax in the same call (p. 47).
		OFF	
#44	<div style="border: 1px solid black; padding: 2px; display: inline-block;">RECEIVE ALERT</div> To alert you with beeps when a received document is stored into memory due to a problem.	ON	If you hear slow beeps, clear the printing problem or supply paper to print the stored document. The beeps will stop.
		OFF	
#46	<div style="border: 1px solid black; padding: 2px; display: inline-block;">FRIENDLY RCV</div> To receive a fax automatically when you answer a call and hear a fax calling tone (slow beep).	ON	"ON": You do not have to press FAX START for fax reception.
		OFF	

(The default setting is in bold type.)

Features Summary

Code	Display & Feature	Settings	How the unit operates
#49	<div style="border: 1px solid black; padding: 2px; display: inline-block;">AUTO DISCONNECT</div> To answer a call with an extension telephone in the TEL/FAX mode	ON / CODE= * 0	See page 49 for details. To program: 1. Follow steps 1–3 on page 58. 2. Rotate JOG DIAL to select “ON”. 3. Press SET . 4. Enter your code from 2 to 4 digits, using 0–9 and *. 5. Press SET . 6. Press MENU .
		OFF	
#70	<div style="border: 1px solid black; padding: 2px; display: inline-block;">FAX PAGER CALL</div> If you have a pager and wish to know when your unit receives a fax, activate this feature.	ON	See page 51 for details.
		OFF	
#76	<div style="border: 1px solid black; padding: 2px; display: inline-block;">CONNECTING TONE</div> If you often have trouble when sending a fax, this feature allows you to hear connecting tones; fax tone, ring back tone and busy tone.	ON	You can confirm the status of the other party’s machine. <ul style="list-style-type: none"> ● If the ring back tone continues, the other party’s machine may not be a facsimile or may have run out of paper. Check with the other party. ● The connecting tone volume cannot be adjusted.
		OFF	
#77	<div style="border: 1px solid black; padding: 2px; display: inline-block;">AUTO ANSWER</div> To change the receive mode in the AUTO ANSWER setting	FAX ONLY	“FAX ONLY”: Facsimile only mode (p. 45) “TEL/FAX”: Telephone/Facsimile mode (p. 48, 49) ● If you select “TEL/FAX”, the unit will print an information list.
		TEL/FAX	
#78	<div style="border: 1px solid black; padding: 2px; display: inline-block;">TEL/FAX RING</div> If you use an extension telephone in the TEL/FAX mode, select the desired number of rings to be generated before the unit answers.	1, 2, 3, 4	See pages 48 and 49 for details.
#80	<div style="border: 1px solid black; padding: 2px; display: inline-block;">SET DEFAULT</div> To reset the advanced features to their default settings	YES	1. Follow steps 1–3 on page 58. 2. Rotate JOG DIAL to select “YES”. 3. Press SET . 4. Press SET again. 5. Press MENU .
		NO	

(The default setting is in bold type.)

Error Messages

Reports

If your unit cannot send a fax, check the following.

- The number you dialed is correct.
- The other party's machine is a facsimile.

If the problem remains, correct it by following the communication message printed on the sending and journal reports (p. 37).

Communication message	Error code	Cause & Remedy
COMMUNICATION ERROR	40–42 46–52 58, 65 68, 72 FF	● A transmission or reception error occurred. Try again or check with the other party.
	43 44	● An overseas transmission error occurred. Try using the overseas mode (feature #23 on page 56).
DOCUMENT JAMMED	—	● The document is jammed. Remove the jammed document (p. 70).
ERROR-NOT YOUR UNIT	54 59 70	● A transmission or reception error occurred because of a problem with the other party's fax machine. Check with the other party.
MEMORY FULL	—	● The document was not received due to memory being full.
NO DOCUMENT	—	● The document was not fed into the unit properly. Reinsert the document and try again.
OTHER FAX NOT RESPOND	—	<ul style="list-style-type: none">● The other party's fax machine is busy or has run out of recording paper. Try again.● The document was not fed properly. Reinsert the document and try again.● The other party's fax machine rings too many times. Send a fax manually – dial the number, confirm the fax tone, and press FAX START.● The other party's machine is not a facsimile. Check with the other party.● The number you dialed is not in service.
PRESSED THE STOP KEY	—	● STOP was pressed and fax communication was canceled.
THE COVER WAS OPENED	—	● The covers were opened. Close them and try again.
OK	—	● Fax communication was successful.

Display

If the unit detects a problem, one or more of the following messages will appear on the display.

Display message	Cause & Remedy
CALL SERVICE CALL SERVICE2	<ul style="list-style-type: none"> ● There is something wrong with the unit. Contact our service personnel.
COVER OPEN ↕ CHECK FILM	<ul style="list-style-type: none"> ● The covers are open. Close them. ● The ink film is empty. Replace the ink film with a new one (p. 72, 73). ● The ink film is not installed. Install it (p. 72, 73). ● The ink film is slack. Tighten it (see step 6 on page 73).
CHECK DOCUMENT	<ul style="list-style-type: none"> ● The document is not fed into the unit properly. Reinsert the document. If misfeeding occurs frequently, clean the document feeder rollers (p. 74) and try again. If the problem remains, adjust the feeder pressure (p. 70).
CHECK MEMORY	<ul style="list-style-type: none"> ● Memory (telephone numbers, parameters, etc.) has been erased. Re-program.
CHECK PAPER	<ul style="list-style-type: none"> ● The recording paper is not installed or the unit has run out of paper. Install paper and press SET to clear the message. ● The recording paper is not fed into the unit properly. Reinstall paper (p. 13) and press SET to clear the message. ● The recording paper has jammed near the recording paper entrance. Clear the jammed paper (p. 69) and press SET to clear the message. Do not install folded or heavily curled paper.
FAX IN MEMORY	<ul style="list-style-type: none"> ● The unit has a document in memory. See the other displayed message instructions to print out the document.
FAX MEMORY FULL	<ul style="list-style-type: none"> ● Memory is full of received documents due to a lack of recording paper or a recording paper jam etc. Install paper or clear the jammed paper. ● When performing memory transmission, the document being stored exceeds the memory capacity of the unit. Transmit the entire document manually.
JOG-DIAL FULL	<ul style="list-style-type: none"> ● There is no space to store new stations in the JOG DIAL directory. Erase unnecessary stations (p. 32).

(continued)

Error Messages

Display message	Cause & Remedy
MEMORY FULL	<ul style="list-style-type: none">● When making a copy, the document being stored exceeds the memory capacity of the unit. Press STOP to clear the message. Divide the document and try again.
MODEM ERROR	<ul style="list-style-type: none">● There is something wrong with the modem circuit. Contact our service personnel.
NO FAX REPLY	<ul style="list-style-type: none">● The other party's fax machine is busy or has run out of recording paper. Try again.
PAPER JAMMED	<ul style="list-style-type: none">● A recording paper jam occurred. Clear the jammed paper (p. 69).
PLEASE WAIT	<ul style="list-style-type: none">● The unit is checking that there is no slack on the ink film. Wait for a while.
REDIAL TIME OUT	<ul style="list-style-type: none">● The other party's fax machine is busy or has run out of recording paper. Try again.
REMOVE DOCUMENT	<ul style="list-style-type: none">● The document is jammed. Remove the jammed document (p. 70).● Attempted to transmit a document longer than 600 mm (23⁵/₈"). Press STOP to remove the document. Divide the document into two or more sheets and try again.
TRANSMIT ERROR	<ul style="list-style-type: none">● A transmission error occurred. Try again.
UNIT OVERHEATED	<ul style="list-style-type: none">● The unit is too hot. Let the unit cool down.

When a function does not work, check here before requesting help

General

Problem

I cannot make and receive calls.

I cannot make calls.

The unit does not work.

The unit does not ring.

The unit displays the following message though the paper is inserted.

The other party complains they only hear a fax tone and cannot talk.

The _____ button does not function properly.

The receive mode does not function as explained on pages 42 and 43.

During programming, I cannot enter the code or ID number.

The ink film runs out quickly.

The unit beeps.

The **HANDSET LOCATOR** button does not function.

The **CHARGE** light never goes out while charging.

Operations

Cordless handset

Problem	Cause & Remedy
The handset does not work.	<ul style="list-style-type: none"> ● Make sure that the battery is installed correctly (p. 71). ● Charge the battery fully (p. 20). ● Clean the charge contacts (p. 75) and charge again.
The handset does not ring.	<ul style="list-style-type: none"> ● The ringer volume is set to off. Press LOUD/RINGER (p. 22).
An alarm tone sounds when I press TALK or REMOTE SP .	<ul style="list-style-type: none"> ● The handset is too far from the main unit. Move closer and try again. ● Place the handset on the main unit and try again. ● The power cord is disconnected. Plug in the power cord.
An alarm tone sounds continuously while using the handset.	<ul style="list-style-type: none"> ● Quickly move closer to the main unit or the call will be terminated within 60 seconds. ● The power cord is disconnected. Plug in the power cord.
Static, sound cuts in/out, fades. Interference from other electrical units.	<ul style="list-style-type: none"> ● Locate the handset and the main unit away from electrical appliances. ● Move closer to the main unit. ● Press CH to select a clear channel. ● Raise the main unit antenna.
The handset stops working while being used.	<ul style="list-style-type: none"> ● Place the handset on the main unit, and disconnect the power cord to reset the unit. Connect the power cord, and try again.
I cannot store a telephone number in the handset memory.	<ul style="list-style-type: none"> ● You cannot store a number while the unit is in the talk or intercom mode. ● Do not pause for over 30 seconds while storing a number.
While storing a telephone number in the handset, it starts to ring.	<ul style="list-style-type: none"> ● To answer a call, press TALK. The program will be canceled. Store the number again.
I cannot redial by pressing REDIAL/PAUSE .	<ul style="list-style-type: none"> ● The redial function does not work right after storing telephone numbers in the handset or DIRECT (p. 28, 29). ● If the last number dialed was more than 32 digits long, the number will not be redialed.
The RECHARGE indicator flashes or the handset beeps intermittently.	<ul style="list-style-type: none"> ● Charge the battery fully (p. 20).
I charged the battery fully, but the RECHARGE indicator flashes.	<ul style="list-style-type: none"> ● Clean the charge contacts (p. 75) and charge again. ● It is time to replace the battery. Please purchase a new battery (p. 9).
I cannot receive documents by pressing FAX on the handset.	<ul style="list-style-type: none"> ● Press FAX until a single beep is heard.

Fax – sending

Problem	Cause & Remedy
I cannot send documents.	<ul style="list-style-type: none"> ● The telephone line cord is connected to the EXT jack on the unit. Connect to the LINE jack (p. 14). ● The other party's fax machine is busy or has run out of recording paper. Try again. ● The other party's machine is not a facsimile. Check with the other party. ● The other party's fax machine rings too many times. Send a fax manually – dial the number, confirm the fax tone, then press FAX START .
The other party complains that letters on their received document are distorted or not clear.	<ul style="list-style-type: none"> ● If your line has special telephone services such as call waiting, the service may have been activated during fax transmission. Connect the unit to a line that does not have these services. ● The extension telephone on the same line is off the hook. Hang up the extension telephone and try again. ● Try copying the document. If the copied image is clear, there may be something wrong with the other party's machine.
The other party complains that dirty patterns or black lines appear on their received document.	<ul style="list-style-type: none"> ● The glass or rollers are dirty. Clean them (p. 74).
I cannot make an international fax call.	<ul style="list-style-type: none"> ● Use the overseas transmission mode of feature #23 (p. 56). ● Add two pauses at the end of the telephone number (p. 27) or dial manually.

Fax – receiving

Problem	Cause & Remedy
I cannot receive documents.	<ul style="list-style-type: none"> ● The telephone line cord is connected to the EXT jack on the unit. Connect to the LINE jack (p. 14).
I cannot receive documents automatically.	<ul style="list-style-type: none"> ● The receive mode is set to the TEL mode. Set to the FAX ONLY or TEL/FAX mode (p. 42, 43). ● The time taken to answer the call is too long. Decrease the number of rings of features #06 (p. 55), #30 (p. 57) and #78 (p. 59).
The display shows the following message but faxes are not received. <div style="border: 1px solid black; padding: 2px; width: fit-content; margin-top: 5px;">CONNECTING.....</div>	<ul style="list-style-type: none"> ● The incoming call is not a fax. Change the receive mode to the TEL mode (p. 43).

(continued)

Operations



Fax – receiving (cont.)

Problem	Cause & Remedy
The recording image is faint.	<ul style="list-style-type: none"> ● The other party sent a faint document. Ask them to send a clearer copy of the document. ● The thermal head is dirty. Clean it (p. 75).
The printing quality is poor.	<ul style="list-style-type: none"> ● Some paper has instructions recommending which side to print on. Try turning the paper over. We recommend smooth paper such as Hammermill® Jet Print for clearer printing. ● Check the document of the other party.
A blank sheet is ejected.	<ul style="list-style-type: none"> ● If a blank sheet is ejected after the received document is printed out, the receiving reduction rate is not programmed correctly. Program the proper rate in feature #36 (p. 57). ● The other party placed the document in their fax machine the wrong way. Check with the other party.
I cannot receive documents by pressing FAX on the handset.	<ul style="list-style-type: none"> ● Press FAX until a single beep is heard.

Receive mode

Problem	Cause & Remedy
I cannot select the desired receive mode.	<ul style="list-style-type: none"> ● If you want to set the FAX ONLY or TEL/FAX mode: <ul style="list-style-type: none"> — Select the desired mode using feature #77 (p. 59), and — Press AUTO ANSWER to turn on the arrow (▼) on the right of the display. <p style="text-align: right;">Display: <input style="width: 100px;" type="text"/> ▼ ON</p> ● If you want to set the TEL mode: <ul style="list-style-type: none"> — Press AUTO ANSWER to turn off the arrow (▼) on the right of the display. <p style="text-align: right;"><input style="width: 100px;" type="text"/> ON</p>
The other party complains that they cannot send a document.	<ul style="list-style-type: none"> ● The unit is not in AUTO ANSWER mode. Press AUTO ANSWER to turn on the arrow (▼) on the right of the display. <p style="text-align: right;"><input style="width: 100px;" type="text"/> ▼ ON</p>

Copying

Problem	Cause & Remedy
The unit does not make a copy.	<ul style="list-style-type: none"> You cannot make a copy during programming. Make the copy after programming or stop the programming.
A dirty pattern or a black line appears on the copied document.	<ul style="list-style-type: none"> The glass or rollers are dirty. Clean them (p. 74).
The copied image is distorted.	<ul style="list-style-type: none"> The thermal head is dirty. Clean it (p. 75).
The printing quality is poor.	<ul style="list-style-type: none"> Some paper has instructions recommending which side to print on. Try turning the paper over. We recommend smooth paper such as Hammermill® Jet Print for clearer printing.
The printing is faint. <div style="display: flex; justify-content: space-around; align-items: center;"> <div style="text-align: center;"> <p>Original</p>  </div> <div style="text-align: center;"> <p>Copy</p>  </div> </div>	<ul style="list-style-type: none"> You may have used paper with a cotton and/or fiber content that is over 20%, such as letterhead or resume paper. We recommend smooth paper such as Hammermill® Jet Print for clearer printing.

Using an answering machine

Problem	Cause & Remedy
I cannot receive documents automatically.	<ul style="list-style-type: none"> Your greeting message on the answering machine is too long. Shorten the message (up to 10 seconds). The answering machine rings too many times. Set to 1 or 2 rings. The silent detection feature is deactivated. Activate feature #40 (p. 57).
I cannot receive voice messages.	<ul style="list-style-type: none"> Check if the answering machine is turned on and connected to the fax machine properly (p. 46). Set the number of rings on the answering machine to 1 or 2.
I cannot retrieve recorded voice messages on the answering machine from a remote location.	<ul style="list-style-type: none"> The remote access code on your answering machine is the same as your fax activation code. Set a different number for features #12 (p. 55) and #41 (p. 58). You did not program your remote access code in your fax machine correctly. Program the same code that is programmed on the answering machine to the fax machine with feature #12 (p. 55).
The greeting message on the answering machine is interrupted halfway and the caller cannot leave a voice message.	<ul style="list-style-type: none"> The greeting message has a silent pause longer than 4 seconds. Re-record the greeting message.

(continued)

Operations

Using an answering machine (cont.)

Problem	Cause & Remedy
I pressed the remote access code to access the answering machine remotely, but the line was disconnected.	<ul style="list-style-type: none"> The code may include “#” which is used for certain features provided by telephone companies. Change the code on the answering machine to another number which does not include “#”. Also change the code of the fax machine with feature #12 (p. 55).
Callers complain that their voice message is interrupted halfway and they cannot leave a message.	<ul style="list-style-type: none"> Advise the caller not to pause for over 4 seconds while recording their voice message.
Callers complain that they cannot send a document.	<ul style="list-style-type: none"> Your answering machine has run out of recording tape. Rewind the tape to record messages. You set the answering machine to only give a greeting message.
When I answer a call with the extension telephone, the fax machine switches to the fax mode and I cannot talk with the other party.	<ul style="list-style-type: none"> You paused for over 4 seconds during the conversation. Do not pause for more than 4 seconds, or turn off feature #40 (p. 57).

If a power failure occurs

- The unit will not function.
- Fax transmission and reception will be interrupted.
- If delayed transmission of feature #25 (p. 56) is programmed and the start time has passed during a power failure, transmission will be attempted soon after power is restored.
- If an extension telephone/answering machine is connected to the EXT jack of the fax machine, you may be able to use it during a power failure.
- If fax documents are stored in memory, they will be lost. When power is restored, a power down report will be printed out stating which contents in memory have been erased.

Sample of a power down report

POWER DOWN REPORT				
		POWER DOWN AT:Jan. 05 2000 04:30AM		
		RESTARTED AT:Jan. 05 2000 04:31AM		
		YOUR LOGO :		
		YOUR FAX NO. :		
<< WARNING >>				
CONTENTS HAVE BEEN CLEARED DUE TO POWER DOWN.				
FOR ADDITIONAL INFORMATION, PLEASE SEE THE JOURNAL REPORT.				
NO.	OTHER FACSIMILE	MODE	PAGES	FUNCTION
01	<FAX # NOT AVAIL.>	RCV	01	MEMORY RECEIVE

Recording paper jam

If the unit does not eject any recording paper during fax reception or copying, the recording paper has jammed and the display will show the following message.

Display:

PAPER JAMMED

Remove the jammed paper as follows.

- 1 Open the front cover by pulling up the center part.

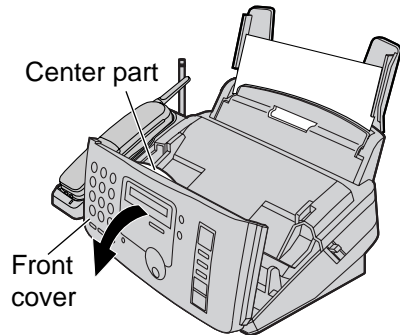

- 2 Push the back cover open button (①) and open the back cover (②).

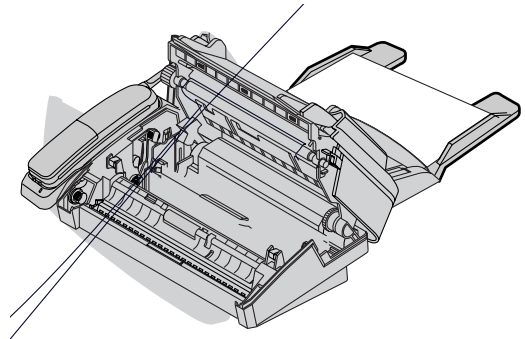

Sending document jams

- 1** Open the front cover by pulling up the center part.
- 2** Remove the jammed document carefully.
- 3** Close the front cover securely.

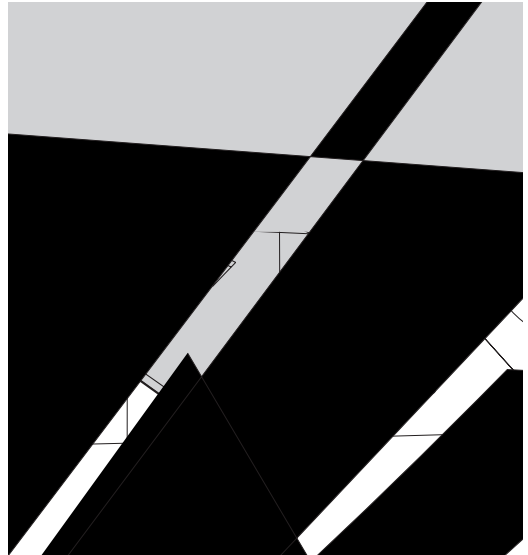

Replacing the handset battery

If the RECHARGE indicator flashes after being fully charged, replace the battery with a new Panasonic rechargeable battery Model No. KX-A36. To order, see page 9. To prevent memory loss, replace the battery within 3 minutes.

- 1 Press down on the arrow and slide the handset cover.

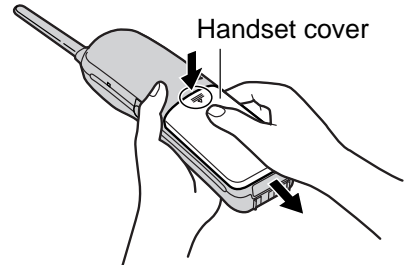

- 2 Disconnect the battery lead and remove the battery.

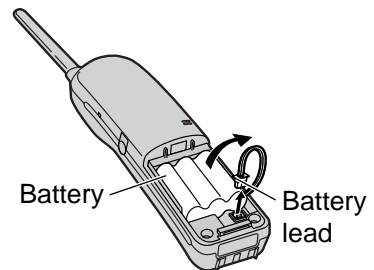

- 3 Connect the new battery lead and insert the battery into the handset.

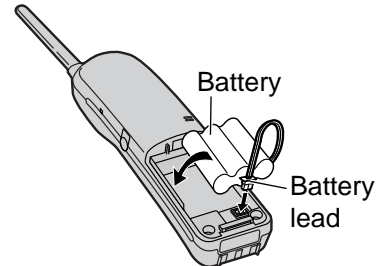

- 4 Replace the handset cover on the handset.
 - Be sure to charge the new battery for about **4 hours** (p. 20).

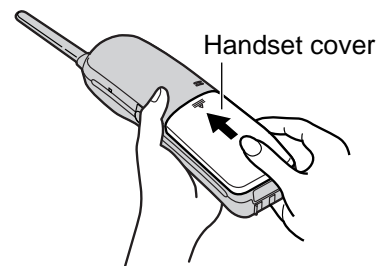

Attention:

- Use only a Panasonic rechargeable battery Model No. KX-A36.
- The product you have purchased is powered by a nickel cadmium battery which is recyclable.

At the end of its useful life, under various state and local laws, it is illegal to dispose of this battery into your municipal waste stream.

Please call 1-800-8-BATTERY for information on how to recycle this battery.



Replacing the ink film

When the unit runs out of ink film, the following message will be displayed.

Display:

CHECK FILM

Install a new ink film. The following ink films are available for replacement. Each roll prints about 150 letter-size pages. See page 9 for accessory order information.

Model No. KX-FA53: Replacement film (1 roll)

Model No. KX-FA55: Replacement film (2 rolls)

- 1 Open the front cover by pulling up the center part.

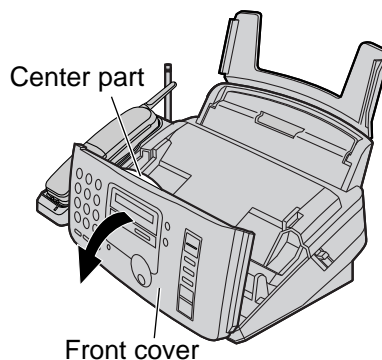

- 2 Push the back cover open button (①) and open the back cover (②).

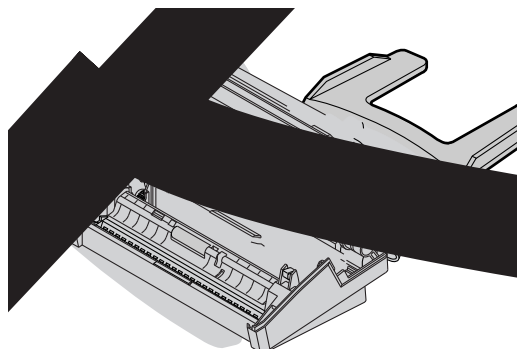

- 4** Remove the stoppers and tags from the new ink film. Find the "T" shaped gear (blue).

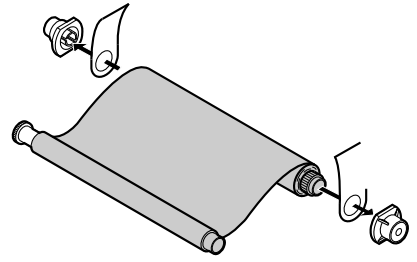

Document feeder

- 1** Disconnect the power cord and the telephone line cord.
- 2** Open the front cover by pulling up the center part.
- 3** Clean the document feeder rollers and rubber flap with a cloth moistened with isopropyl rubbing alcohol, and let all parts dry thoroughly.
- 4** Clean the glass with a soft dry cloth.
- 5** Close the front cover securely.
- 6** Connect the power cord and the telephone line cord.

Thermal head

If dirty patterns or black or white bands appear on a copied or received document, clean the thermal head.

- 1** Disconnect the power cord and the telephone line cord.
- 2** Open the front cover by pulling up the center part.
- 3** Open the back cover by pushing the back cover open button.
- 4** Clean the thermal head with a cloth moistened with isopropyl rubbing alcohol, and let it dry thoroughly.
- 5** Close the back cover securely by pushing down on the dotted area at both ends. Close the front cover securely.
- 6** Connect the power cord and the telephone line cord.

Caution:

- To prevent malfunction due to static electricity, do not use a dry cloth and do not touch the thermal head directly.

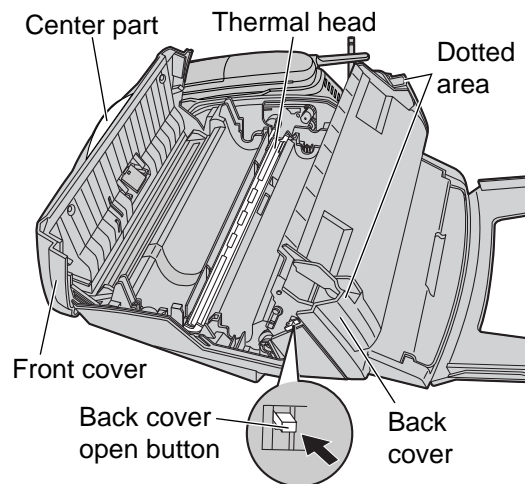

Print Reports

Reference lists and reports

You can print out the following lists and reports for your reference.

Setup list: provides you with the current settings of the basic and advanced programming features (p. 55–59).

Telephone number list: provides you with names and telephone numbers which are stored in the JOG DIAL directory. The telephone number codes are as shown below.

P: A pause has been entered.

F: A flash has been entered.

Journal report: keeps records of fax transmission and reception. This report will be printed automatically after every 30 fax communications (p. 37).

Printer test list: allows you to check the print quality of your unit. If the test print has a dirty pattern, or blurred points or lines, clean the thermal head (p. 75).

Broadcast programming list: provides you with names and telephone numbers which are stored in the broadcast feature (p. 39).

1 Press **MENU** two times.

Display: 2.PRINT REPORT

2 Rotate **JOG DIAL** until the desired item is displayed.

SETUP LIST

TEL NO. LIST

JOURNAL REPORT

PRINTER TEST

BROADCAST LIST

3 Press **SET** to start printing.

PRINTING

- To stop printing, press **STOP**.
- After printing, the printed item will be displayed.

4 Press **MENU**.

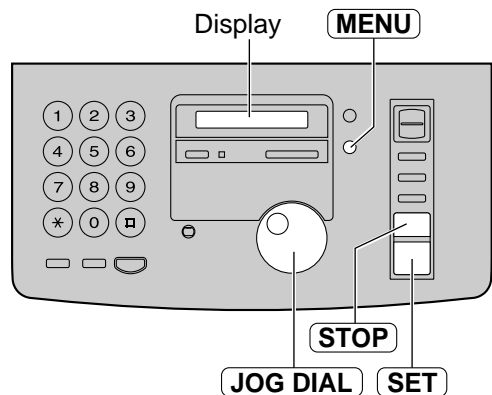

List of FCC requirements and information

If required by the telephone company, inform them of the following.

- FCC Registration No.:
(found on the rear of the unit)
- Ringer Equivalence No.:
(found on the rear of the unit)
- The particular telephone line to which the equipment is connected.

This unit must not be connected to a coin operated line. If you are on a party line, check with your local telephone company.

Ringer Equivalence Number (REN):

This REN is useful in determining the quantity of devices you may connect to your telephone line and still have all of those devices ring when your telephone number is called. In most but not all areas, the sum of the REN's of all devices connected to one line should not exceed five (5.0). To be certain of the number of devices you may connect to your line, as determined by the REN, you should contact your local telephone company to determine the maximum REN for your calling area.

In the event that terminal equipment causes harm to the telephone network, the telephone company should notify the customer, if possible, that service may be stopped. However, where prior notice is impractical, the company may temporarily cease service providing that they:

- a) Promptly notify the customer.
- b) Give the customer an opportunity to correct the problem with their equipment.
- c) Inform the customer of the right to bring a complaint to the Federal Communication Commission pursuant to procedures set out in FCC Rules and Regulations Subpart E of Part 68.

The Telephone Company may make changes in its communications facilities, equipment operations, or procedures where such action is reasonably required in the operation of its business and is not inconsistent with the rules and regulations in FCC Part 68. If such changes can be reasonably expected to render any customer terminal equipment incompatible with telephone company communications facilities, or require modification or

alteration of such terminal equipment, or otherwise materially affect its use or performance, the customer shall be given adequate notice in writing, to allow the customer an opportunity to maintain uninterrupted service.

CAUTION:

Any changes or modifications not expressly approved by the party responsible for compliance could void the user's authority to operate this device.

When programming emergency numbers and/or making test calls to emergency numbers:

1. Remain on the line and briefly explain to the dispatcher the reason for the call before hanging up.
2. Perform such activities in the off-peak hours; such as early morning or late evenings.

This telephone provides magnetic coupling to hearing aids.

NOTE:

This equipment has been tested and found to comply with the limits for a Class B digital device, pursuant to Part 15 of the FCC Rules. These limits are designed to provide reasonable protection against harmful interference in a residential installation. This equipment generates, uses, and can radiate radio frequency energy and, if not installed and used in accordance with the instructions, may cause harmful interference to radio communications. However, there is no guarantee that interference will not occur in a particular installation. If this equipment does cause harmful interference to radio or television reception, which can be determined by turning the equipment off and on, the user is encouraged to try to correct the interference by one or more of the following measures:

- Reorient or relocate the receiving antenna.
- Increase the separation between the equipment and receiver.
- Connect the equipment into an outlet on a circuit different from that to which the receiver is connected.
- Consult the dealer or an experienced radio/TV technician for help.

Limited Warranty

**Panasonic Consumer Electronics Company,
Division of Matsushita Electric Corporation
of America**

One Panasonic Way, Secaucus,
New Jersey 07094

**Panasonic Sales Company
Division of Matsushita Electric of
Puerto Rico, Inc.**

Ave. 65 de Infantería, Km. 9.5, San Gabriel
Industrial Park, Carolina, Puerto Rico 00985

PANASONIC Facsimile Products Limited Warranty

Have any questions? CALL 1-800-HELP-FAX (1-800-435-7329) on:

How to operate the unit, How to get repair service, How to get supplies.

Panasonic Consumer Electronics Company or Panasonic Sales Company (collectively referred to as "the warrantor"), will repair this product with new or refurbished parts, free of charge, in the USA or Puerto Rico for one (1) year limited warranty from the date of original purchase in the event of a defect in materials or workmanship.

This Limited Warranty Excludes both Labor and Parts for: batteries, antennas, and cosmetic parts (cabinet).

Carry-in or mail-in service in the USA or Puerto Rico can be obtained during the warranty period by contacting a Panasonic Services Company (PASC) Factory Servicenter listed in the Servicenter Directory. Or call, toll free, 1-800-HELP-FAX (1-800-435-7329) to locate a PASC Factory Servicenter. Carry-in or mail-in service in Puerto Rico can be obtained during the warranty period by calling the Panasonic Sales Company telephone number listed in the Servicenter Directory.

This warranty is extended only to the original purchaser. A purchase receipt or other proof of date of original purchase will be required before warranty service is rendered.

This warranty only covers failures due to defects in material or workmanship which occur during normal use and (when applicable) does not cover the ink film, the toner cartridge and drum unit or the print and ink film. The inability of this product to interface with any specific computer is not a manufacturing defect and is outside of the scope of this Limited Warranty. In no event shall the warrantor be liable by reason of such incompatibility. The warranty does not cover damages which occur in shipment, or failures which are caused by products not supplied by the warrantor such as non Panasonic ink film, or failures which result from accident, misuse, abuse, neglect, mishandling, faulty installation, misapplication, set-up adjustments, improper operation or maintenance, alteration, modification, power line surge, improper voltage supply, lightning damage, signal reception problems, rental use of the product, or service by anyone other than a PASC Factory Servicenter or a PASC authorized Servicenter, or damage that is attributable to acts of God.

LIMITS AND EXCLUSIONS

There are no express warranties except as listed above.

THE WARRANTOR SHALL NOT BE LIABLE FOR INCIDENTAL OR CONSEQUENTIAL DAMAGES RESULTING FROM THE USE OF THIS PRODUCT, OR ARISING OUT OF ANY BREACH OF THIS WARRANTY. ALL EXPRESS AND IMPLIED WARRANTIES, INCLUDING THE WARRANTIES OF MERCHANTABILITY, ARE LIMITED TO THE APPLICABLE WARRANTY PERIOD SET FORTH ABOVE.

Some states do not allow the exclusion or limitation of incidental or consequential damages, or limitations on how long an implied warranty lasts, so the above exclusions or limitations may not apply to you.

This warranty gives you specific legal rights and you may also have other rights which vary from state to state. If a problem with this product develops during or after the warranty period, you may contact your dealer or Servicenter. If the problem is not handled to your satisfaction, then write to the Customer Satisfaction Center at the company address indicated above.

Servicenter Directory

For Product Information, Operating Assistance, Literature Request, Dealer Locations, and all Customer Service inquiries please contact:
1-800-HELP-FAX (1-800-435-7329), Monday-Friday 9am - 8pm EST.

Web Site: www.panasonic.com

(for customers in the USA or Puerto Rico ONLY)

You can purchase parts, accessories or locate your nearest servicenter by visiting our Web Site.

Factory Servicenters Locations

CALIFORNIA

6550 Katella Avenue
Cypress, CA 90630

800 Dubuque Avenue
S. San Francisco,
CA 94080

20201 Sherman Way
Suite 102
Canoga Park, CA 91306

3878 Ruffin Road
Suite A
San Diego, CA 92123

COLORADO

1640 South Abilene Street
Suite D
Aurora, CO 80012

FLORIDA

3700 North 29th Avenue
Suite 102
Hollywood, FL 33020

GEORGIA

8655 Roswell Road
Suite 100
Atlanta, GA 30350

ILLINOIS

9060 Golf Road
Niles, IL 60714

1703 North Randall Road
Elgin, IL 60123
(Pick-up / Drop-off only)

MARYLAND

62 Mountain Road
Glen Burnie, MD 21061

MASSACHUSETTS

60 Glacier Drive
Suite G
Westwood, MA 02090

MICHIGAN

37048 Van Dyke Avenue
Sterling Heights, MI 48312

MINNESOTA

7850-12th Avenue South
Airport Business Center
Bloomington, MN 55425

OHIO

2236 Waycross Road
Civic Center Plaza
Forest Park, OH 45240

PENNSYLVANIA

2221 Cabot Blvd. West
Suite B
Langhorne, PA 19047

TEXAS

13615 Welch Road
Suite #101
Farmers Branch,
TX 75244

WASHINGTON

20425-84th Avenue South
Kent, WA 98032

HAWAII

99-859 Iwaiwa Street
Aiea, Hawaii 96701
Phone (808) 488-1996
Fax (808) 486-4369

Service in Puerto Rico

Matsushita Electric of Puerto Rico, Inc. Panasonic Sales Company/ Factory Servicenter:
Ave. 65 de Infantería, Km. 9.5, San Gabriel Industrial Park, Carolina, Puerto Rico 00985
Phone (787) 750-4300 Fax (787) 768-2910

Limited Warranty / Energy Star

Notes for product service and shipping the product

For product service

- Servicers are listed on page 79.
- Call toll-free 1-800-HELP-FAX (1-800-435-7329) for the location of an authorized servicer.
- After the fax advantage program, please contact our Continued Services Technical Support Line at 1-900-555-PANA (1-900-555-7262). If you have difficulty reaching this number, it may be blocked by your phone company. Please contact your local phone company to correct this.

When you ship the product

- Carefully pack your unit, preferably in the original carton.
- Attach a letter, detailing the symptom or problem, to the outside of the carton.
- Send the unit to an authorized servicer, prepaid and adequately insured.
- Do not send your unit to the Panasonic Consumer Electronics Company or to any executive or regional sales offices. These locations do not repair consumer products.

Energy Star

As an ENERGY STAR® Partner, Panasonic has determined that this product meets the ENERGY STAR® guidelines for energy efficiency.
ENERGY STAR is a U.S. registered mark.



Technical data about this product

■ Main unit

Applicable Lines:	Public Switched Telephone Network
Document Size:	Max. 216 mm (8½") in width Max. 600 mm (23⅝") in length
Effective Scanning Width:	208 mm (8¾")
Recording Paper Size:	Letter: 216 mm x 279 mm (8½" x 11") Legal: 216 mm x 356 mm (8½" x 14")
Effective Printing Width:	208 mm (8¾")
Transmission Time*:	Approx. 15 s/page (Original mode)**
Scanning Density:	Horizontal: 8 pels/mm (203 pels/inch) Vertical: 3.85 lines/mm (98 lines/inch) –“STANDARD” mode 7.7 lines/mm (196 lines/inch) –“FINE”/“HALF TONE” mode 15.4 lines/mm (392 lines/inch) –“SUPER FINE” mode
Halftone Level:	64-level
Scanner Type:	Contact Image Sensor (CIS)
Printer Type:	Thermal Transfer on plain paper
Data Compression System:	Modified Huffman (MH), Modified READ (MR)
Modem Speed:	9,600 / 7,200 / 4,800 / 2,400 bps; Automatic Fallback
Operating Environment:	5 °C – 35 °C (41 °F – 95 °F), 20 % – 80 % RH (Relative Humidity)
Dimensions (H x W x D):	185 mm x 368 mm x 276 mm (7⅞" x 14½" x 10⅞")
Mass (Weight):	Approx. 3.8 kg (8.5 lb.)
Power Consumption:	Standby: Approx. 5.0 W Transmission: Approx. 15 W Reception: Approx. 35 W (When receiving a 20% black document) Copy: Approx. 37 W (When copying a 20% black document) Maximum: Approx. 138 W (When copying a 100% black document)
Power Supply:	120 V AC, 60 Hz
Memory Capacity:	Approx. 28 pages of memory reception Approx. 25 pages of memory transmission (Based on the ITU-T No. 1 Test Chart in standard resolution.)

■ Handset

Operating Environment:	5 °C – 35 °C (41 °F – 95 °F), 45 % – 85 % RH (Relative Humidity)
Dimensions (H x W x D):	Approx. 39 mm x 55 mm x 271 mm (1⅞" x 2⅝" x 10⅞")
Mass (Weight):	Approx. 200 g (0.4 lb.)
Power Supply:	Ni-Cd battery (3.6 V, 600 mAh)
Frequency:	926 MHz–927 MHz, 902 MHz–903 MHz (30 channels)
Security Codes:	1,000,000

* Transmission speed depends upon the contents of the pages, resolution, telephone line conditions and capability of the other party's machine.

** The 15 second speed is based upon the ITU-T No. 1 Test Chart and original mode.

If the capability of the other party's machine is inferior to your unit, the transmission time may be longer.

Note:

- Any details given in these instructions are subject to change without notice.
- The pictures and illustrations in these instructions may vary slightly from the actual product.

ITU-T No. 1 Test Chart

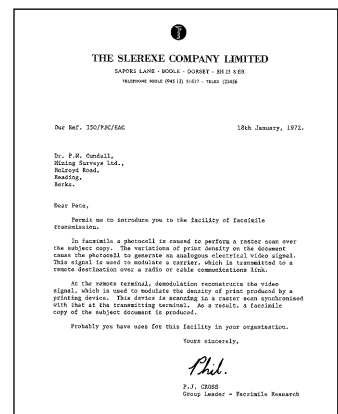

Index

- A** Accessories 8, 9
 - Advanced features 56–59
 - Answering machine 46, 47
 - Any key talk feature 25
 - AUTO ANSWER button/mode .. 42, 43
 - AUTO ANSWER setting (Feature #77) . 59
 - AUTO button 28
 - Auto disconnection (Feature #49) . . 59
- B** Basic features 55
 - Battery
 - (Charging) 20
 - (Life) 20
 - (Replacing) 71
 - Belt clip 21
 - Broadcast programming list 76
 - Broadcast sending report 41
 - Broadcast transmission 38–41
- C** CH button 23
 - Character table 17
 - Cleaning 74, 75
 - COLLATE button 52
 - Communication messages 60
 - Computer, using with 47
 - Connecting tone (Feature #76) 59
 - Connections 14
 - Copy 52, 53
 - Copy enlargement/reduction . . . 52, 53
 - COPY START button 52
- D** Date and time (Feature #01) . . . 15, 55
 - Delayed transmission (Feature #25) . 56
 - Delete button 16, 17, 30, 31
 - Dialing mode (Feature #13) 55
 - DIRECT button 29
 - Directory feature 30
 - DIRECTORY PROGRAM button . . . 30
 - Display
 - (Contrast)(Feature #39) 57
 - (Error messages) 61, 62
 - Distinctive Ring Service
 - (Feature #31) 43, 57
 - Document feeder 74
 - Document jam 70
 - Document size 36, 81
- E** Enlarge copy 52, 53
 - Error messages 60–62
 - Extension telephone 49, 50
- F** Facsimile telephone number
 - (Feature #03) 18, 55FAX button 44
 - Fax activation code (Feature #41) . . 58
 - Fax auto redial 36
 - FAX ONLY mode 42, 45
 - FAX ONLY ring count
 - (Feature #06) 45, 55
 - Fax pager (Feature #70) 51, 59
 - FAX START button 35
 - Feature programming 54–59
 - Feeder cleaning 74
 - Feeder jam 70
 - Feeder pressure 70
 - Film 9, 72, 73
 - FLASH button 27
 - Friendly reception (Feature #46) . 44, 58
- H** HANDSET LOCATOR button 25
 - Handset volume 22
 - Headset 21
 - HELP button 10
 - Hyphen button 30, 31
- I** Identia-Ring (Feature #31) 57
 - Ink film 72, 73
 - Insert button 16, 17
- J** Jams 69, 70
 - JOG DIAL
 - (Making a voice call) 33
 - (Selecting characters) 31
 - (Sending faxes) 35
 - (Storing) 30–32
 - Journal auto print (Feature #22) . . . 56
 - Journal report 37, 76
- L** Legal paper 12, 13
 - List / Report
 - (Broadcast programming) 76
 - (Broadcast sending) 41
 - (Journal) 37, 76
 - (Power down) 68
 - (Printer test) 76
 - (Sending) 37
 - (Setup) 76
 - (Telephone number) 76
 - Logo (Feature #02) 16, 55
 - LOUD/RINGER button 22

- M** Memory reception alert (Feature #44)44, 58
- Memory transmission35
- MONITOR button24, 34
- Monitor volume22
- O** Overseas transmission mode (Feature #23)56
- P** Pager call (Feature #70)51, 59
- Paper jam69
- Paper tray12
- PAUSE button27
- Power down report68
- Power failure68
- Power supply14, 81
- Printer test list76
- Printing paper size81
- Printing reports76
- Problem solving63–68
- PROGRAM button28, 29
- Programmable features54–59
- Pulse dialing (Feature #13)55
- Q** QUICK SCAN button35, 52
- R** Receiving (Fax)44 (Setting)42, 43
- Receiving alert (Feature #44)58
- Receiving reduction (Feature #36)57
- Recording paper13, 81
- Recording paper jam69
- REDIAL button (Handset)23, 26 (Main unit)24, 36
- Reduce copy52, 53
- Remote activation ID (Feature #12)55
- REMOTE SP button26
- Replacement film9, 72, 73
- Reset (Feature #80)59
- RESOLUTION button35
- Ring count (FAX ONLY)(Feature #06)55 (Silent fax recognition)(Feature #30)57 (TEL/FAX)(Feature #78)59
- Ring pattern detection (Feature #31)57
- Ringer volume (Handset)22 (Main unit)22
- S** Sending (Broadcast)38–41 (From memory)35 (JOG DIAL)35 (Manually)35
- Sending document (Does not feed or multi-feeds)70
- Sending report (Feature #04)37, 55
- Set default (Feature #80)59
- Setup list76
- Silent detection (Feature #40)57
- Silent fax recognition ring (Feature #30)57
- Specifications81
- Storing (DIRECT button)29 (Handset)28 (JOG DIAL)30–32
- T** TALK button23, 25
- TEL mode44
- TEL/FAX delayed ring count (Feature #78)59
- TEL/FAX mode48, 49
- Telephone number list76
- Thermal head cleaning75
- TONE button27
- Tone dialing (Feature #13)55
- Transmission (Broadcast)38–41 (From memory)35 (JOG DIAL)35 (Manually)35
- Transmittable document36
- V** Voice call (Answering)25 (JOG DIAL)33 (Making)23, 24
- Voice contact34
- Voice mail43
- VOLUME button22

Panasonic FAX ADVANTAGE PROGRAM

*Free peace of mind,
direct from Panasonic*

NO EXTRA COST



- **1-year limited warranty¹ parts & labor**
- **Toll-free help line**
- **Free overnight replacement³ and repair program**

The Panasonic Fax Advantage Consumer Service Program.

Panasonic knows that if your fax machine is not up and running, neither is your business. That's why we created the Panasonic Fax Advantage Program. Included at no extra cost with the purchase of a Panasonic Fax Machine, the Fax Advantage Program can provide a free replacement unit³ overnight if your original unit is in need of repair.

Here's how it works:

1. If you have a problem with your fax while it is covered by the one-year limited warranty¹, call our toll-free help-line at 1-800-HELP-FAX².
2. Talk to one of our technical experts to diagnose your problem over the phone.
3. If repairs are necessary and you are entitled to service under the terms and conditions of the limited warranty⁴, we will send a refurbished replacement unit to you overnight or second business day delivery, depending on the time of your call.

A second option available under our one-year limited warranty is to mail-in or carry-in your fax to one of our Regional Service centers, where the unit will be repaired and returned to you.

Instructions

If you choose to receive a replacement unit under the Fax Advantage Program, Panasonic will provide a replacement unit which will be completely refurbished, quality-tested by Panasonic technicians and individually hand-inspected before it is shipped to you. You will keep the replacement unit and send the original unit to us in the replacement unit's box. UPS will pick up the unit at no charge to you, should it be determined that you are entitled to warranty service. A proof-of-purchase must be included with the returned product. Any unit that is replaced by Panasonic and not shipped with proper proof-of-purchase by you will be subject to a minimum \$100.00 charge. The original unit must be properly packaged in the same manner as the replacement unit, utilizing

the packing materials provided. Damage due to improper or inadequate packing will be charged to you as an out-of-warranty cost. If our 1-800-HELP-FAX technicians determine that your unit may be an "out-of-box failure"⁵, we will attempt to provide you with a factory-new replacement unit⁶. You must ship a copy of your receipt with your original unit to verify that you purchased the unit within 10 days prior to your 1-800-HELP-FAX call.

Requirements

You must give our technicians a valid credit card number (Discover, VISA, Master Card, or American Express/Optima). Product that is not returned to Panasonic by 10 business days after shipment of the replacement product will be charged to your credit card account at Panasonic's Suggested Retail Price (see dealer for details). If your original unit is not eligible for warranty service, your card will be charged for the non-warranty repair of the unit at Panasonic's current rate for parts and labor and for any shipping charges associated with this program. If you do not wish to pay out-of-warranty repair costs, you will be responsible for returning the replacement unit to Panasonic and for paying all shipping charges associated with this program including the overnight delivery of the replacement product to you, shipment of the problem unit to Panasonic, shipment of the replacement unit back to Panasonic and the return of your original unit back to you. Credit status will be verified prior to sending the replacement product.

1. See dealer for limited warranty details.
2. After the fax advantage program, contact our Continued Services Technical Support Line at 1-900-555-PANA (1-900-555-7262), for fee based technical support.
3. Replacement unit is refurbished.
4. Replacement program excludes Puerto Rico and is subject to termination at any time without advance notice.
5. "Out-of-box failure" is an inoperable unit that was purchased no more than 10 days prior to your 1-800-HELP-FAX call, and would otherwise qualify for warranty service under the terms and conditions of the limited warranty.
6. Panasonic reserves the right to send a refurbished unit.

**Panasonic Consumer Electronics
Company, Division of Matsushita
Electric Corporation of America**
One Panasonic Way, Secaucus,
New Jersey 07094

**Panasonic Sales Company,
Division of Matsushita Electric of
Puerto Rico, Inc. ("PSC")**
Ave. 65 de Infantería, Km. 9.5
San Gabriel Industrial Park, Carolina,
Puerto Rico 00985