



Regalo Model 2010 Portable Bed Rail



WARNING :

Failure to follow these instructions for the assembly and use of your bedrail could result in serious injury or death.

This bed rail is intended for use with children 2 years to 5 years of age.

Regalo International, LLC
14305 Southcross Drive, Suite 100
Burnsville, MN 55306

Phone: 952-435-1080
Fax: 952-435-1088

WARNING:

- Suffocation and Strangulation Hazard.
- Death or Serious Injury Can Occur.
- Infants who cannot get in and out of an adult bed without help can be trapped between a mattress and a wall and suffocate.
- Never place infants in adult bed with or without a bed rail.
- Use only for children who have outgrown a crib. NEVER use in place of crib.
- Use only with children who can get in and out of adult bed without help (typically 2 years and up).
- ALWAYS keep bed rail pushed firmly against mattress and at least 9 in. from headboard and footboard.
- NEVER use on toddler bed. Bunk bed. Water bed. Or bed with inflatable mattress. Use only on adult bed with mattress and mattress support as defined by the manufacturer.
- Discontinue use if damaged, broken or if parts are missing.
- BED RAIL USE:
 - Bed rail can trap young children against mattress, headboard, or footboard.

Parts List:



Upper Rail Tube (1)



Upper Rail Tube (3)

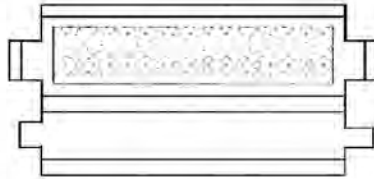

Secondary Side Mesh Wall (2)



Vertical Tube (4)



Vertical Tube (5)



2X Horizontal Lower Tube (6)



2X Horizontal Lower Tube (7)

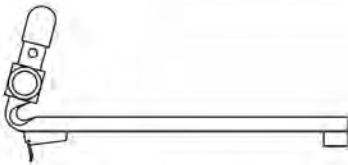

"L" shape Anchoring Tube (8)

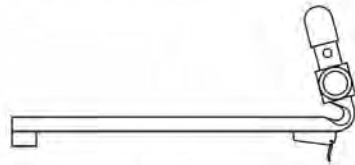

"L" shape Anchoring Tube (9)



"L" shape tube with long strap and black cap (10)



"L" shape tube with long strap and black cap (10)

How to Assemble and Attach the Mesh Wall of the Bed Rail

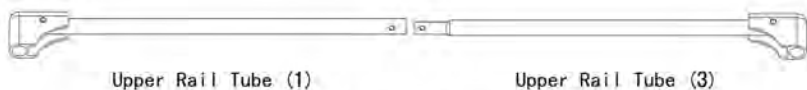

DIAGRAM A (1)



DIAGRAM A (2)

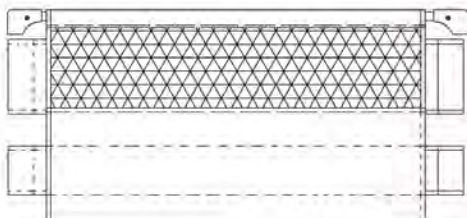
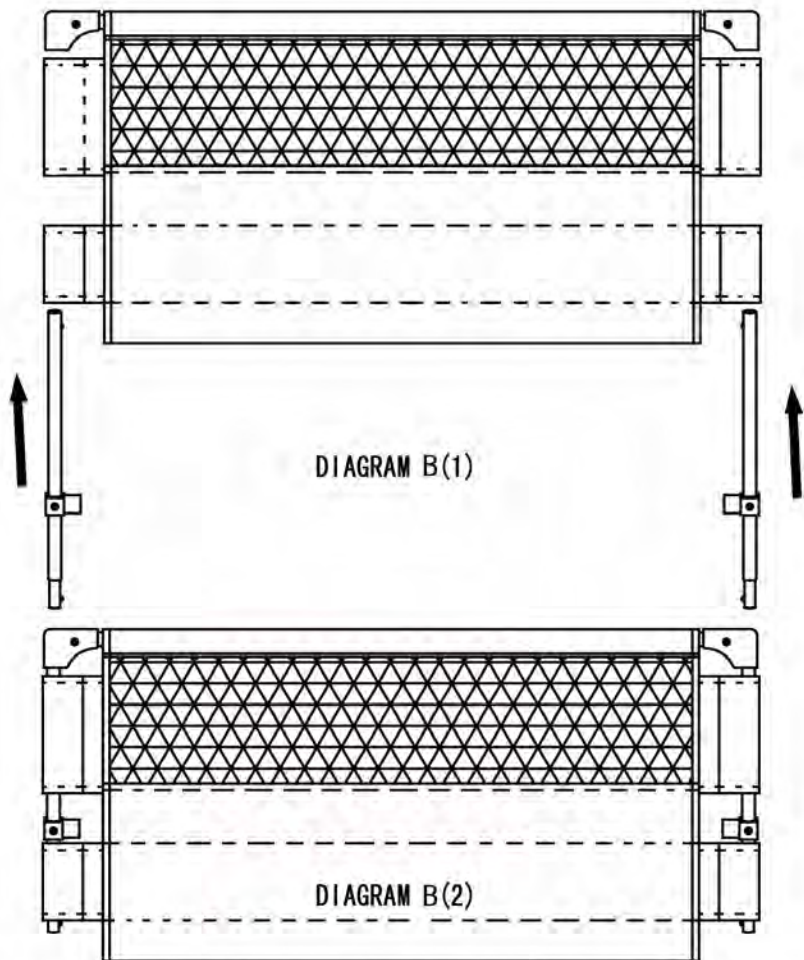

DIAGRAM A (3)

Step 1, Diagram A: To begin this step you will need to take your Upper Rail Tube # 1 and slide it through the opening in the top of the Mesh Wall. Slide it all the way through until the end of Tube 1 comes out the other side of the Mesh Wall opening. This will require that you gather the mesh together as shown in Diagram A(2). Next, you will connect the shrink end of Upper Rail Tube # 3 into the round end of Upper Rail Tube # 1. Simply push the silver locking button down, insert the tube end until the Silver Locking Button pops out of the hole in Tube # 1. Once the 2 tubes are connected you can spread the mesh wall material out over the full length of the Upper Rail Tube as shown in Diagram A(3).



Step 2, Diagram B: Next, assemble one of the Vertical Tubes # 4 or 5 to the Upper Rail Tube by sliding the Vertical Tube through the opening in the side of the Mesh Wall as shown in Diagram B (1) . NOTE: The Silver Locking Button should be facing inward as shown in Diagram B (1) . Depress the Silver locking button on the Vertical tube; align it with the hole on the inside of the Plastic Corner Housing, and insert the Vertical Tube until the Silver Locking Button pops all the way through the hole in the Plastic Corner Housing. Repeat this procedure on the opposite corner of the Mesh Wall using the second Vertical Tube # 4 or 5 .

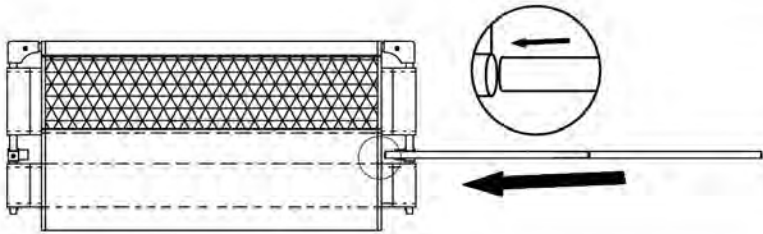

DIAGRAM C(1)

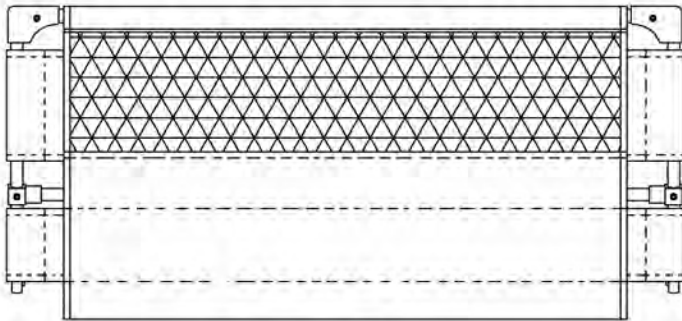

DIAGRAM C(2)

Step 3, Diagram C : Connect the remaining tubes #6 and #7 together. Once connected, slide tubes through upper opening of mesh wall. Insert both ends of tube into "U" shaped mounting bracket on either side. Do the same for the lower mesh wall opening and second set of tubes #6 and #7.

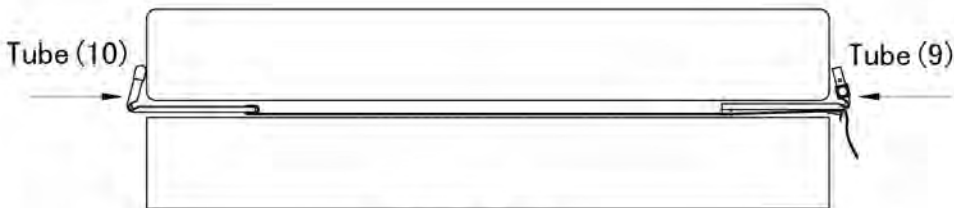

DIAGRAM D

Step 4: For this step you will need the "L" tubes 9 & 10 that are joined by the adjusting strap. You will notice that there are two "L" Tubes (9) that do not have black plastic caps on them. NOTE: These "L" tubes (9) MUST be placed on side of the mattress that you want the bed rail mesh panel.

IMPORTANT: Proceed by making sure the straps connecting the "L" tubes (9) and (10) are not twisted before installing them under the mattress. If the straps are twisted it will effect the final adjustment in Step 7. Continue by sliding the "L" tubes (9) and (10) under each side of the mattress. See Diagram D. Again, make sure that the "L" tubes (9) are both on the side of the mattress where you want the bed rail mesh panel.

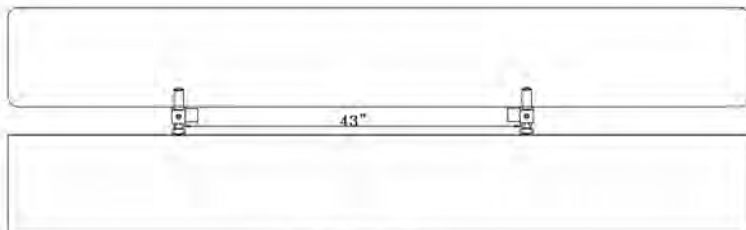

DIAGRAM E

Step 5. Pull the loose adjustment end of the strap located near the buckle on the "L" tubes (9) in the direction of the arrow indicated on Diagram E. DO NOT fully tighten the straps in this step. Instead, just pull the adjusting strap ends so that the "L" tubes are just touching the side of the mattress. Final adjustment will come later. Once you have completed this step, adjust each "L" tube, on both sides of the mattress so that they are approximately 43 inches apart, and generally centered on the mattress. See Diagram E. You are now ready to go to step 6.

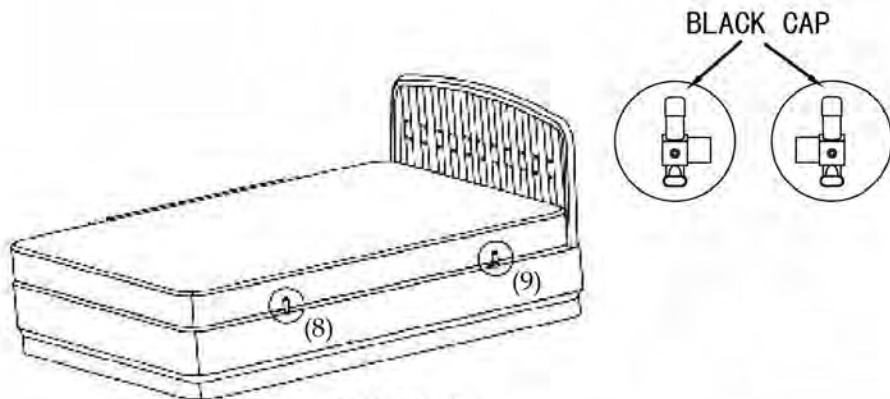

DIAGRAM F

Step 6, Diagram F : To assemble your Wall to the bed you will first need to remove the protective black rubber caps from the top of the "L" Shaped Anchoring Tubes (8) (9) protruding out from under the mattress. HELPFUL HINT: It is sometimes easier to remove the black caps by pushing them off from the bottom rather than pulling them off.

Step 7, Diagram G: After removing the black caps, insert tubes # 8 and # 9, of the anchoring tubes, into the accessory side rail. Connect by pushing in the silver lock button. The accessory side rail should now be secured.

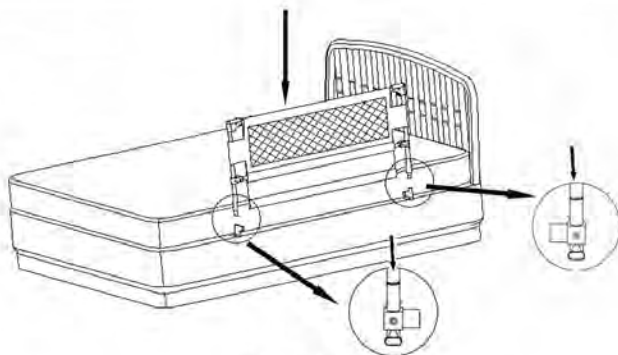

DIAGRAM G(1)

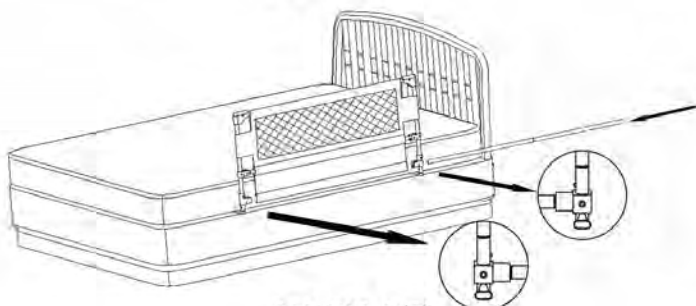

DIAGRAM G(2)

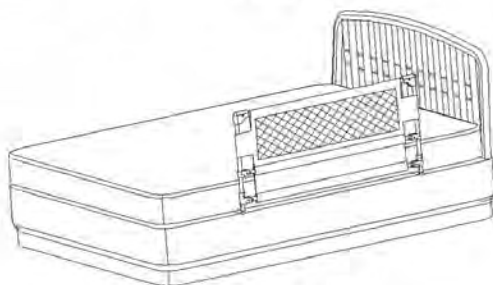

DIAGRAM G(3)

Care And Maintenance

Periodically check the Bed rail for signs of damage, wear or for missing components. Do not use if any part is missing, worn or damaged components. Check the bed rail regularly to make sure all the hardware and mountings are tight Do not use abrasive cleaners or bleach. Clean it by sponging with warm water and mild detergent.



Regalo International, LLC

14305 Southcross Drive, Suite 100
Burnsville, MN 55306
952-435-1080

2009/5/6-V1