

DIGITAL PROGRAMMABLE ALGORITHM SYNTHESIZER

DX7 II · FD/D

SERVICE MANUAL

DX7 II · FD



DX7 II · D



■ CONTENTS

• SPECIFICATIONS	2
• PANEL LAYOUT	2
• CIRCUIT BOARDS LAYOUT	4
• BLOCK DIAGRAM	6
• DISASSEMBLY PROCEDURE	8
• PARAMETERS LIST	11
• INITIALIZING	12
• MEMORY CONFIGURATION	13
• ERROR MESSAGES	14
• MIDI DATA FORMAT	17
• MIDI IMPLEMENTATION CHART	24
• LSI DATA TABLE	25
• IC BLOCK DIAGRAM	28
• CIRCUIT BOARDS	30
• PARTS LIST	

006725

SINCE 1887



YAMAHA

NIPPON GAKKI CO., LTD. HAMAMATSU, JAPAN
2.0K-872 © Printed in Japan '87.1

DX7 II · FD · D

IMPORTANT NOTICE

This manual has been provided for the use of authorized Yamaha Retailers and their service personnel. It has been assumed that basic service procedures inherent to the industry, and more specifically Yamaha Products, are already known and understood by the users, and have therefore not been restated.

WARNING: Failure to follow appropriate service and safety procedures when servicing this product may result in personal injury, destruction of expensive components and failure of the product to perform as specified. For these reasons, we advise all Yamaha product owners that all service required should be performed by an authorized Yamaha Retailer or the appointed service representative.

IMPORTANT: The presentation or sale of this manual to any individual or firm does not constitute authorization, certification, recognition of any applicable technical capabilities, or establish a principle-agent relationship of any form.

The data provided is believed to be accurate and applicable to the unit(s) indicated on the cover. The research, engineering, and service departments of Yamaha are continually striving to improve Yamaha products. Modifications are, therefore, inevitable and changes in specification are subject to change without notice or obligation to retrofit. Should any discrepancy appear to exist, please contact the distributor's Service Division.

WARNING: Static discharges can destroy expensive components. Discharge any static electricity your body may have accumulated by grounding yourself to the ground buss in the unit (heavy gauge black wires connect to this buss).

IMPORTANT: Turn the unit OFF during disassembly and parts replacement. Recheck all work before you apply power to the unit.

This product uses a lithium battery for memory back-up.

WARNING: Lithium batteries are dangerous because they can be exploded by improper handling. Observe the following precautions when handling or replacing lithium batteries.

- Leave lithium battery replacement to qualified service personnel.
- Always replace with batteries of the same type.
- When installing on the PC board, solder using the connection terminals provided on the battery cells. Never solder directly to the cells. Perform the soldering as quickly as possible.
- Never reverse the battery polarities when installing.
- Do not short the batteries.
- Do not attempt to recharge these batteries.
- Do not disassemble the batteries.
- Never heat batteries or throw them into fire.

ADVARSEL!

Lithiumbatteri. Eksplosionsfare.

Udskiftning må kun foretages af en sagkyndig, og som beskrevet i servicemanualen.

■ SPECIFICATIONS

- **Keyboard** 61 keys (C1 - C6), with Initial/After touch
- **Tone Generator** FM tone Generator (6 operators 32 algorithms)
- **Simultaneous Note Output (Reverse priority)**
1-voice: 16 notes (Single play)
2-voice: 8 notes (Dual play)
2-voice: 16 notes (Split play)
- **Internal Memory** 64 voices/32 performances, 2 micro tunings, 1 system set-up
- **External ROM Memory** 128 voices/64 performances, micro tuning, fractional level scaling
- **External Memory** RAM cartridge (Optional, RAM4) = Internal Memory
*Micro floppy disk (Optional, MF2DD) = Internal Memory x 40, MIDI exclusive data

- **Control Sliders and switches**
Volume slider, Continuous sliders CS1, CS2 (Data entry)
Data entry switch x 2,
Mode setting switch x 12,
Voice switch x 32
- **Controls** PITCH BEND WHEEL, MODULATION WHEEL
- **External Control Terminals**
BREATH CONTROL, SUSTAIN, FOOT SWITCH (Sustain, Portamento, Key hold, Soft), FOOT CONTROL 1 (Volume, Modulation, Voice parameter), FOOT CONTROL 2 (Volume, Modulation).
RAM-ROM CARTRIDGE SLOT
MIDI IN-OUT-THRU
- **Output Terminals** Output A/MIX-B, Headphones

- **Disk Drive** 3.5" Micro Floppy Disk Drive, built-in.
2DD 1M Bytes (120K bytes when formatting)
- **Display** LC: 40 letters x 2 lines (illuminated)
LED: 7 segments x 2
- **Dimensions (W x H x D), Weight**
999 x 85.8 x 333.7 mm,
10.5 kg/11.2 kg* (*DX7II FD)
- **Power Supply, Power Consumption**
U.S. & Canadian Models:
120V, 50/60Hz
General Model:
110V/220V/240V 50Hz
- **Standard Accessories** Music holder, ROM cartridge, 3.5" Micro floppy disk (MF2DD)

- **Optional Accessories**
RAM Cartridge RAM4
Flight Case LC-7IIF
Hard Case LC-7IIF
Soft Case SC-7IIS
Cartridge Adaptor ADP1

Foot Switch FC4/FC5, Foot Controller FC7, Breath Controller BC1, Stand LG-100, MIDI Cable MIDI 01/03/15, 3.5" Micro Floppy Disk MF2DD.

■ PANEL LAYOUT

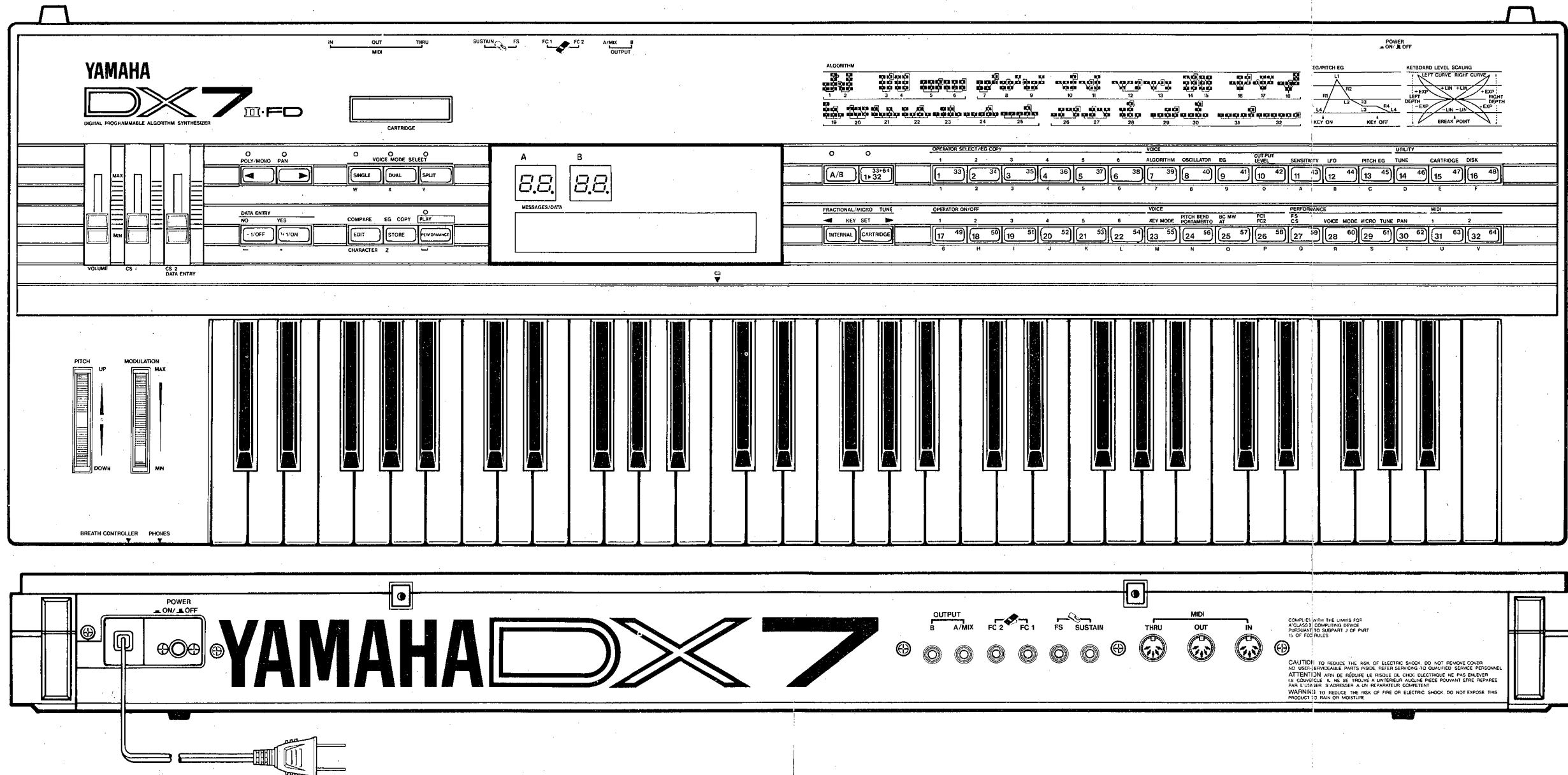

CIRCUIT BOARDS LAYOUT

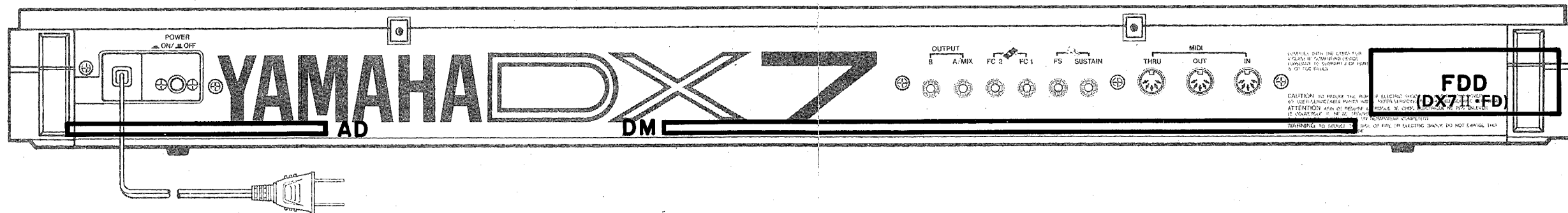
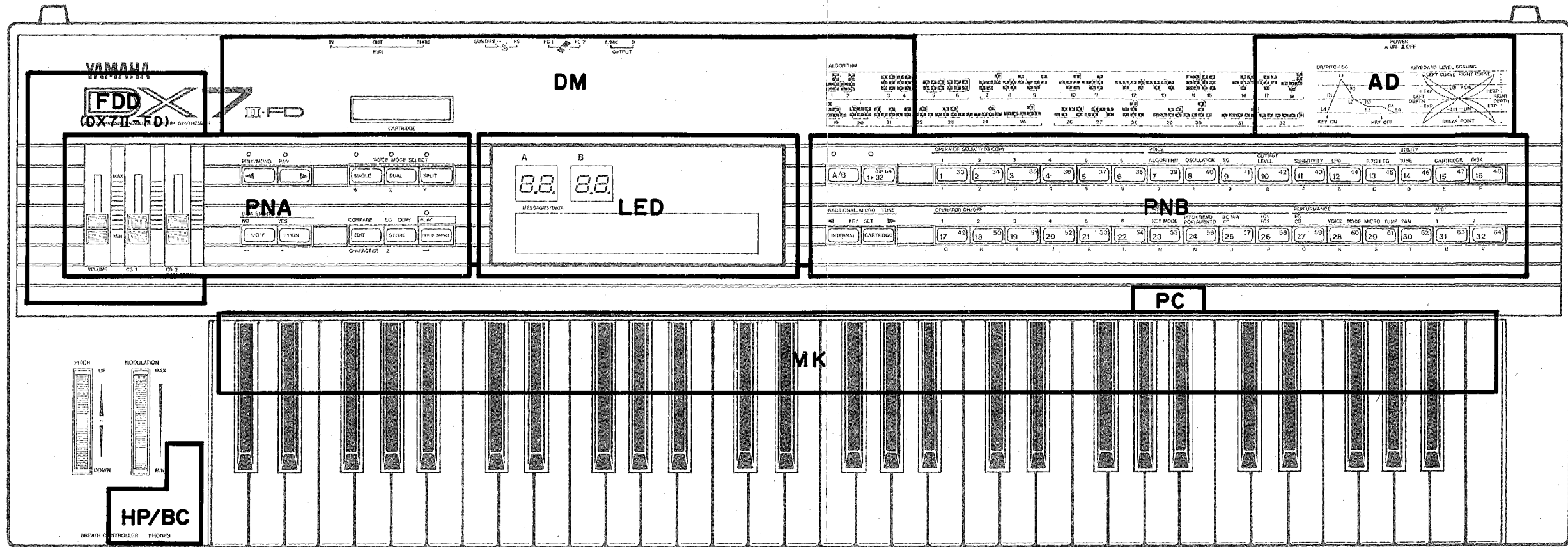

DX7II • FD/D

■ BLOCK DIAGRAM

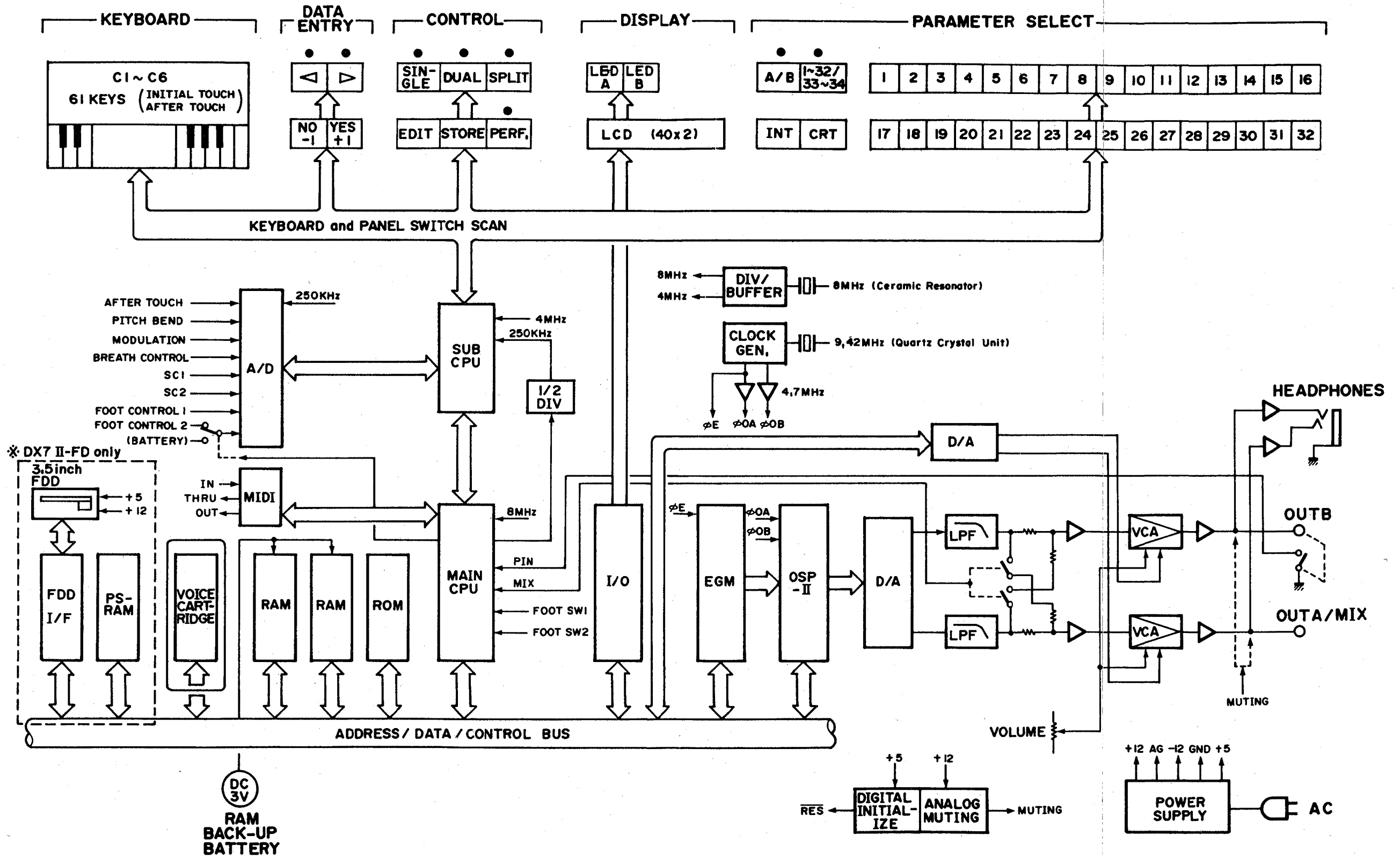

■ DISASSEMBLY PROCEDURE

1. Bottom Panel Removal (Refer to fig. 1.)

Remove the 14 screws (A 4 × 6 Bind tapping screw, 4 pcs. B 4 × 12 Bind head screw, 6 pcs. C 4 × 8 Bind head screw, 4 pcs.) and then remove the bottom panel as shown in figure 1.

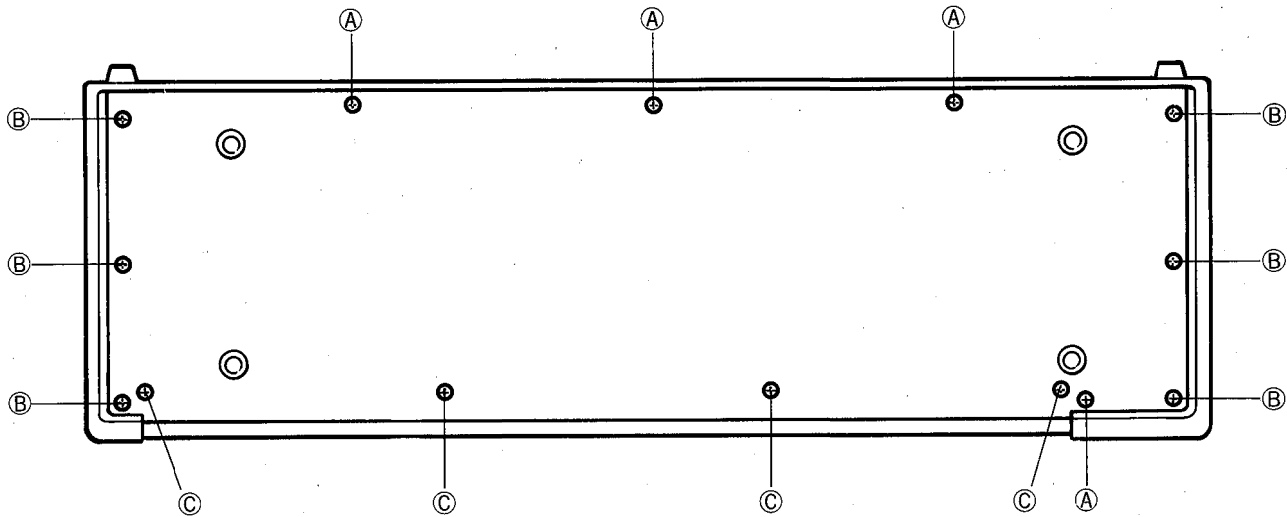

< fig. 1 >

2. DM Circuit Board and Power Supply Unit Removal (Refer to fig. 1 and fig. 2.)

•Remove the bottom panel. (Refer to step 1).

2-1. To remove the DM circuit board, remove the 9 screws. (A 4 × 8 Bind head screw, 3 pcs. B 3 × 20 Bind tapping screw, 2 pcs. C 4 × 12 Bind head screw, 4 pcs.).

2-2. To remove the power supply unit, remove the 6 screws. (D 4 × 8 Bind head screw, 3 pcs. E 4 × 12 Bind head screw, 3 pcs.).

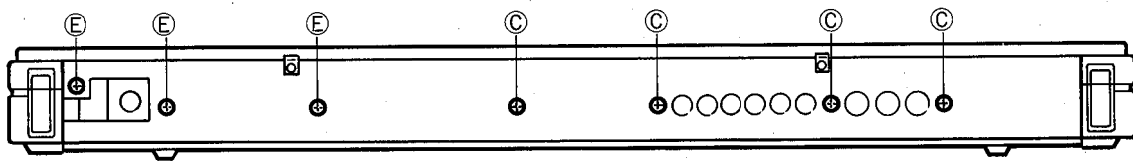

< fig. 2 >

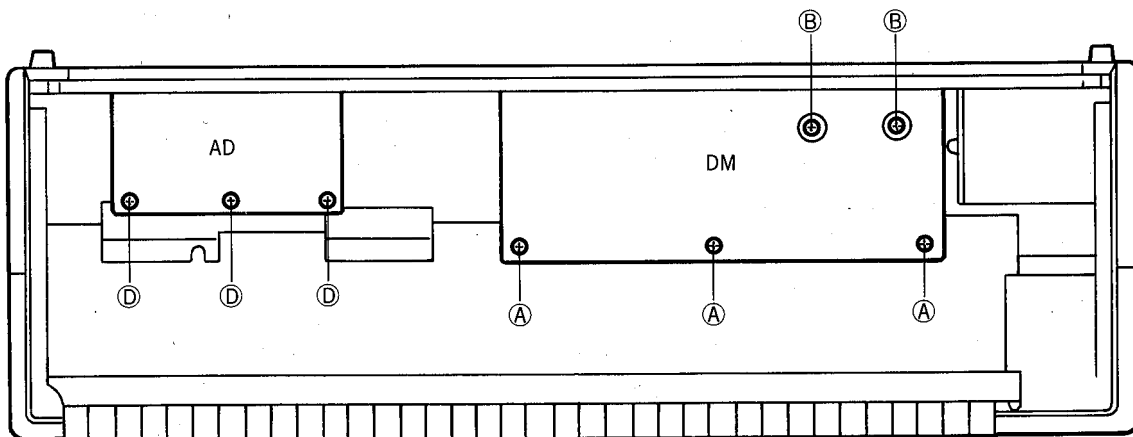

< fig. 3 >

3. Floppy Disk Drive (FDD) Assembly Removal (Refer to fig. 4). — *DX7II-FD model only —

- Remove the bottom panel. (Refer to step 1).
- Remove the DM circuit board. (Refer to step 2-1).

Remove the 3 screws (**A** 4 × 8 Bind tapping screw, 1 pc. **B** 4 × 10 Bind tapping screw, 2 pcs.) and then remove the FDD assembly.

4. Keyboard Unit Removal (Refer to fig. 4).

- Remove the bottom panel. (Refer to step 1).
- Remove the DM circuit board and the power supply unit. (Refer to step 2).

Remove the 3 angle brackets fixing screws (**C** 3 × 8 Bind tapping screws) and the 4 keyboard frame fixing screws (**D** 4 × 16 Bind tapping screws) then remove the keyboard unit.

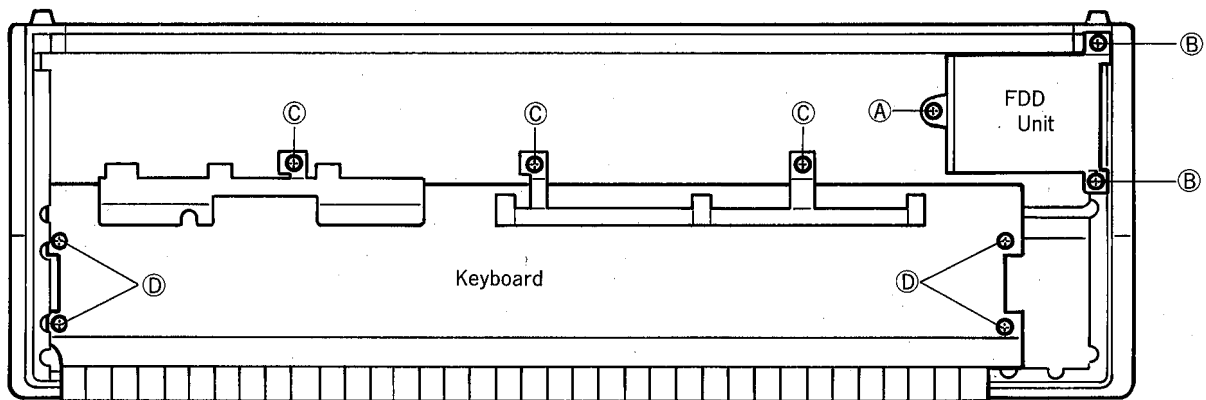

< fig. 4 >

5. PNA Circuit Board, PNB Circuit Board and LCD/LED Display Assembly Removal (Refer to fig. 5).

- Remove the bottom panel. (Refer to step 1).
- Remove the DM circuit board and the power supply unit. (Refer to step 2).
- Remove the FDD assembly. (Refer to step 3). — *DX7II-FD model only —
- Remove the keyboard unit. (Refer to step 4).

Remove the 5 screws (**A** 4 × 8 Bind tapping screws) and then remove the cartridge guide assembly and the bushing.

Remove the 22 screws (**B** 4 × 8 Bind tapping screws) and then remove the PNA circuit board, the PNB circuit board and the display assembly together.

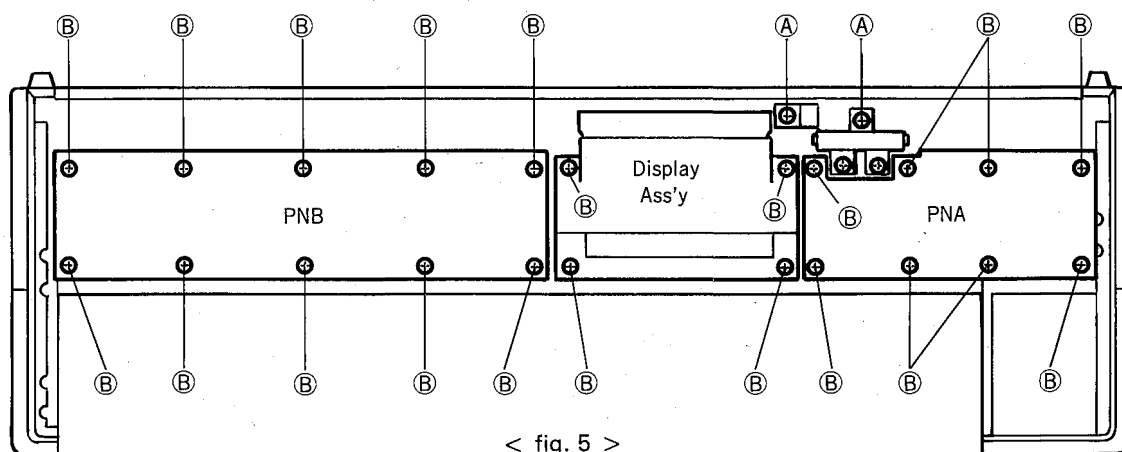

< fig. 5 >

★ Display Assembly/Disassembly

Remove the filter which is attached with double-sided tape. (Be careful not to damage it). Remove the 4 screws (A) 3 × 6 Flat head screws) and then remove the LCD unit and the LED circuit board from the chassis. (Refer to fig. 6).

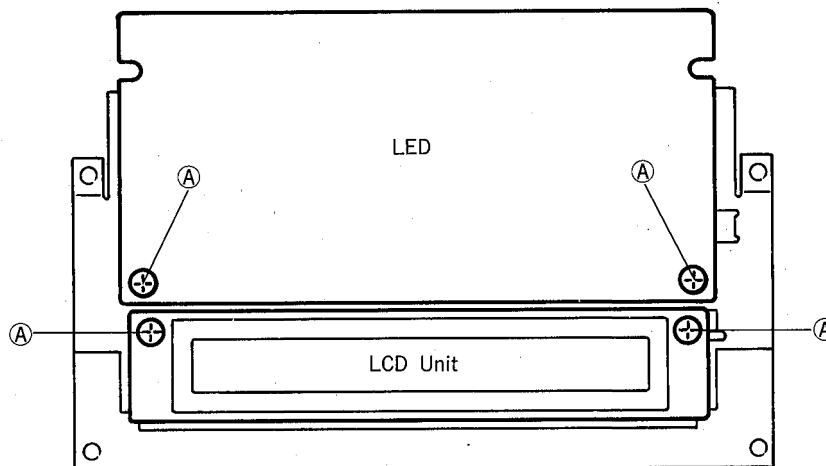

< fig. 6 >

6. Wheel Assembly and Headphone (HP) Circuit Board Removal (Refer to fig. 7).

- Remove the bottom panel. (Refer to step 1).
 - Remove the DM circuit board. (Refer to step 2-1).
- 6-1. To remove each wheel assembly, remove the 2 screws. (A) 3 × 8 Bind tapping screws).
- 6-2. To remove the HP circuit board:
- Remove the power supply unit. (Refer to step 2-2).
 - Remove the keyboard unit. (Refer to step 4).

Now remove the 2 screws (B) 3 × 8 Bind tapping screws) and then remove the HP circuit board.

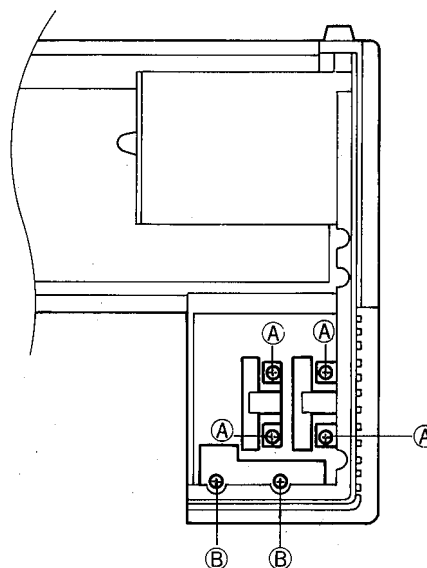

< fig. 7 >

PARAMETERS LIST

• Voice Parameters List

<p style="text-align: center;">ALGORITHM</p> <div style="border: 1px solid black; padding: 2px; width: fit-content; margin: 0 auto;">7</div> <ul style="list-style-type: none"> >ALG >FBL >OSC.SYNC >Transpose >Voice name 	<p style="text-align: center;">OSCILLATOR</p> <div style="border: 1px solid black; padding: 2px; width: fit-content; margin: 0 auto;">8 40</div> <ul style="list-style-type: none"> >Mode >Coarse >Fine >Detune 	<p style="text-align: center;">EG</p> <div style="border: 1px solid black; padding: 2px; width: fit-content; margin: 0 auto;">9</div> <ul style="list-style-type: none"> >RS >R1~R4 >L1~L4 	<p style="text-align: center;">OUTPUT LEVEL</p> <div style="border: 1px solid black; padding: 2px; width: fit-content; margin: 0 auto;">10</div> <ul style="list-style-type: none"> >Scaling mode >Level >LD >LC >BP >RC >RD >OFST Fractional scaling
<p style="text-align: center;">SENSITIVITY</p> <div style="border: 1px solid black; padding: 2px; width: fit-content; margin: 0 auto;">11</div> <ul style="list-style-type: none"> >Velocity >AMS >PMS(ALL OP) 	<p style="text-align: center;">LFO</p> <div style="border: 1px solid black; padding: 2px; width: fit-content; margin: 0 auto;">12</div> <ul style="list-style-type: none"> >Wave >Speed >Delay >Mode >PMD >AMD >SYNC 	<p style="text-align: center;">PITCH EG</p> <div style="border: 1px solid black; padding: 2px; width: fit-content; margin: 0 auto;">13 45</div> <ul style="list-style-type: none"> >RNG >VEL >RS >R1~R4 >L1~L4 	
<p style="text-align: center;">KEY MODE</p> <div style="border: 1px solid black; padding: 2px; width: fit-content; margin: 0 auto;">23</div> <ul style="list-style-type: none"> >Key assign mode >Unison detune 	<p style="text-align: center;">PITCH BEND PORTAMENTO</p> <div style="border: 1px solid black; padding: 2px; width: fit-content; margin: 0 auto;">24</div> <ul style="list-style-type: none"> Pitch Bend <ul style="list-style-type: none"> >Range >Step >Mode Portamento <ul style="list-style-type: none"> >Mode >Step >Time Random pitch <ul style="list-style-type: none"> >Sense 	<p style="text-align: center;">BC MW AT</p> <div style="border: 1px solid black; padding: 2px; width: fit-content; margin: 0 auto;">25</div> <ul style="list-style-type: none"> Mod.Wheel <ul style="list-style-type: none"> >P.MOD >A.MOD >EG.Bias Breath Control <ul style="list-style-type: none"> >P.MOD >A.MOD >EG.Bias >P.Bias After touch <ul style="list-style-type: none"> >P.MOD >A.MOD >EG.Bias >P.Bias 	<p style="text-align: center;">FC1 FC2</p> <div style="border: 1px solid black; padding: 2px; width: fit-content; margin: 0 auto;">26</div> <ul style="list-style-type: none"> Foot control 1 <ul style="list-style-type: none"> >CS 1 >P.MOD >A.MOD >EG.Bias >VOL Foot control 2 <ul style="list-style-type: none"> >P.MOD >A.MOD >EG.Bias >VOL MIDI IN control <ul style="list-style-type: none"> >P.MOD >A.MOD >EG.Bias >VOL

● PERFORMANCE Parameters List

<div style="text-align: center;"> FS CS 27 59 </div> <p>Sustain foot switch >A >B</p> <p>Foot switch >Select >A >B >Range (>Select=softのとき)</p> <p>Continuous slider 1 >Select >A >B</p> <p>Continuous slider 2 >Select >A >B</p>	<div style="text-align: center;"> VOISE MODE 28 60 </div> <p>>Voice mode >Total volume >Balance >Dual Detune >Split point</p>	<div style="text-align: center;"> MICRO TUNE 29 61 </div> <p>>Micro tuning table select >Key >A >B >EG forced damping</p> <p>Note shift >A >B >Performance name</p>	<div style="text-align: center;"> PAN 30 62 </div> <p>PAN >Mode >Range >Select</p> <p>PAN EG >R1~R4 >L1~L4</p>
---	---	--	--

■ INITIALIZING

- (1) Press PERFORMANCE to enter PERFORMANCE mode.
- (2) Press EDIT to enter EDIT mode.
- (3) Then push 14 46 repeatedly until the following message appears.

Initialize >Voice A >Voice B >Performance

- (4) Move the cursor to the kind of data you want to initialize, the press YES .
The LCD display will ask you to reconfirm Are you sure?.
- (5) If you are, answer YES again.
- (6) Initialization is thus Completed !

MEMORY CONFIGURATION

The chart shows the data flow.

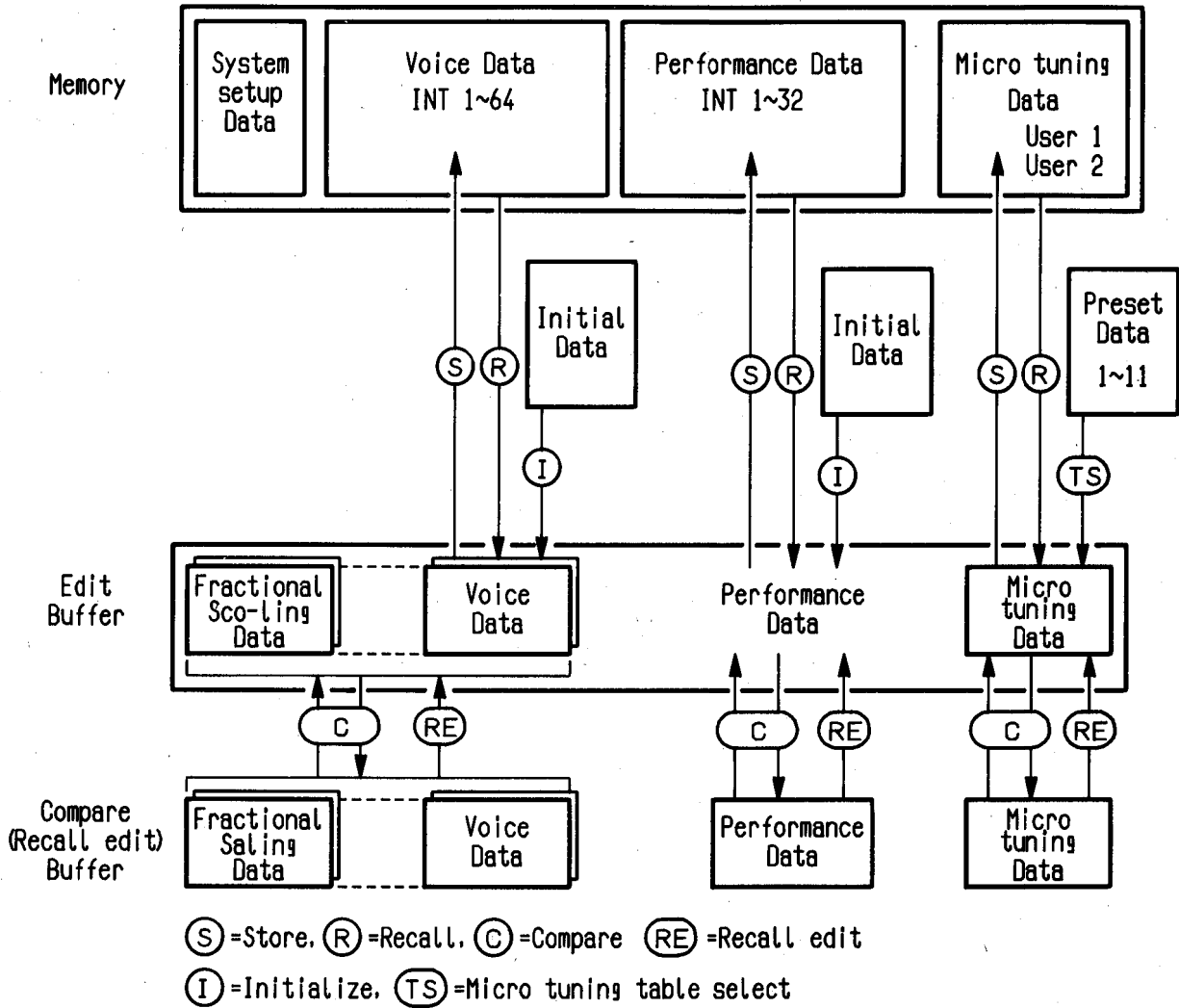

■ ERROR MESSAGES

(1) Internal and Cartridge Data Access

LCD Display	ERROR Message
Memory protected !	This message will be displayed when Memory Protect is set to ON, protecting data such as voice, PERFORMANCE, and Micro tuning in the internal or cartridge memories. To store data in the internal memory, turn off the internal Memory Protect function. To store data in the cartridge, set the cartridge Memory Protect switch to OFF.
Memory protected ! (CRT/fractional)	Cartridge Memory Protect is set to ON for fractional scaling data when storing voices using fractional scaling. Set Memory Protect to OFF for the cartridge, and turn the memory protect switch of the cartridge OFF as well.
Cartridge not ready !	The cartridge is either not inserted or is improperly inserted. Reinsert the cartridge correctly into the slot before carrying out such operations as data access, store, save or load with the cartridge.
Cartridge not ready ! (CRT/fractional)	The cartridge for fractional scaling data is not inserted, or improperly inserted, when carrying out operations such as data access, store, save or load of voice data using fractional scaling. Reinsert a RAM cartridge formatted for fractional scaling.
Cartridge format err ! Format err !	The desired data cannot be accessed due to the inappropriate bank format of the cartridge for storing or saving data or improper bank specification. Make sure that the bank format is appropriate for the specified bank. Re-formatting may be necessary.
Cartridge format err ! (CRT/fractional)	The bank format of the cartridge is not for fractional scaling when storing voice data using fractional scaling. The cartridge not for fractional scaling data is inserted or the desired data cannot be accessed due to the improper bank specification when loading voice data using fractional scaling. Make sure that the bank format is appropriate for the specified bank. Re-formatting may be necessary.

(3) MIDI Data Reception

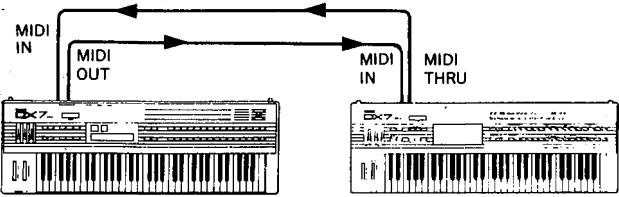
LCD Display	ERROR Message
<p>**MIDI data error! **MIDI checksum error!</p>	<p>Abnormal MIDI data reception has occurred. Repeat the operation. The display will indicate whether the transmitting MIDI device can be turned ON after the receiving device has been turned ON.</p>
<p>**MIDI receive buffer full!</p>	<p>Indicates a single reception of bulk data which exceeds the maximum storage capacity. This rarely occurs. The display will indicate if a loop connection is produced.</p> 
<p>**MIDI bulk rejected by memory protect!</p>	<p>32 voice data, 32 performance data and 2 micro tuning data are not received because the internal memory protect function is set to ON. Set it to OFF.</p>
<p>**MIDI bulk rejected by dev # conflict!</p>	<p>No data is transmitted because of a mismatch of the device No. with the transmitting device. Match the No. to the transmitting device.</p> <ul style="list-style-type: none"> • The LCD display will indicate f when the transmission of fractional scaling data is attempted with an inappropriate cartridge installed. • The LCD display will indicate T when the performance mode, in which micro tuning data is used, is implemented with an inappropriate cartridge installed.

MIDI DATA FORMAT

[1] Transmission Requirements

ACTIVE SENSING

- NOTE ON/OFF
- MODULATION WHEEL
- BREATH CONTROL
- FOOT CONTROL
- PORTAMENTO TIME
- DATA ENTRY
- VOLUME

- CONTINUOUS SLIDER 1
- CONTINUOUS SLIDER 2
- SUSTAIN SWITCH
- PORTAMENTO SWITCH
- SOSTENUTO
- SOFT
- DATA ENTRY +1
- DATA ENTRY -1

- PROGRAM CHANGE
- AFTER TOUCH
- PITCH BENDER

- VOICE EDIT BUFFER
- SUPPLEMENT EDIT BUFFER
- PACKED 32 SUPPLEMENT
- PACKED 32 VOICE
- PACKED 32 PERFORMANCE
- PERFORMANCE EDIT BUFFER
- SYSTEM SETUP
- MICRO TUNING EDIT BUFFER
- MICRO TUNING IN MEMORY
- MICRO TUNING IN CARTRIDGE
- FRACTIONAL SCALING EDIT BUFFER
- FRACTIONAL SCALING IN CARTRIDGE

- VOICE PARAMETER CHANGE
- SUPPLEMENT PARAMETER CHANGE
- PERFORMANCE PARAMETER CHANGE
- MICRO TUNING PARAMETER CHANGE
- FRACTIONAL SCALING PARAMETER CHANGE

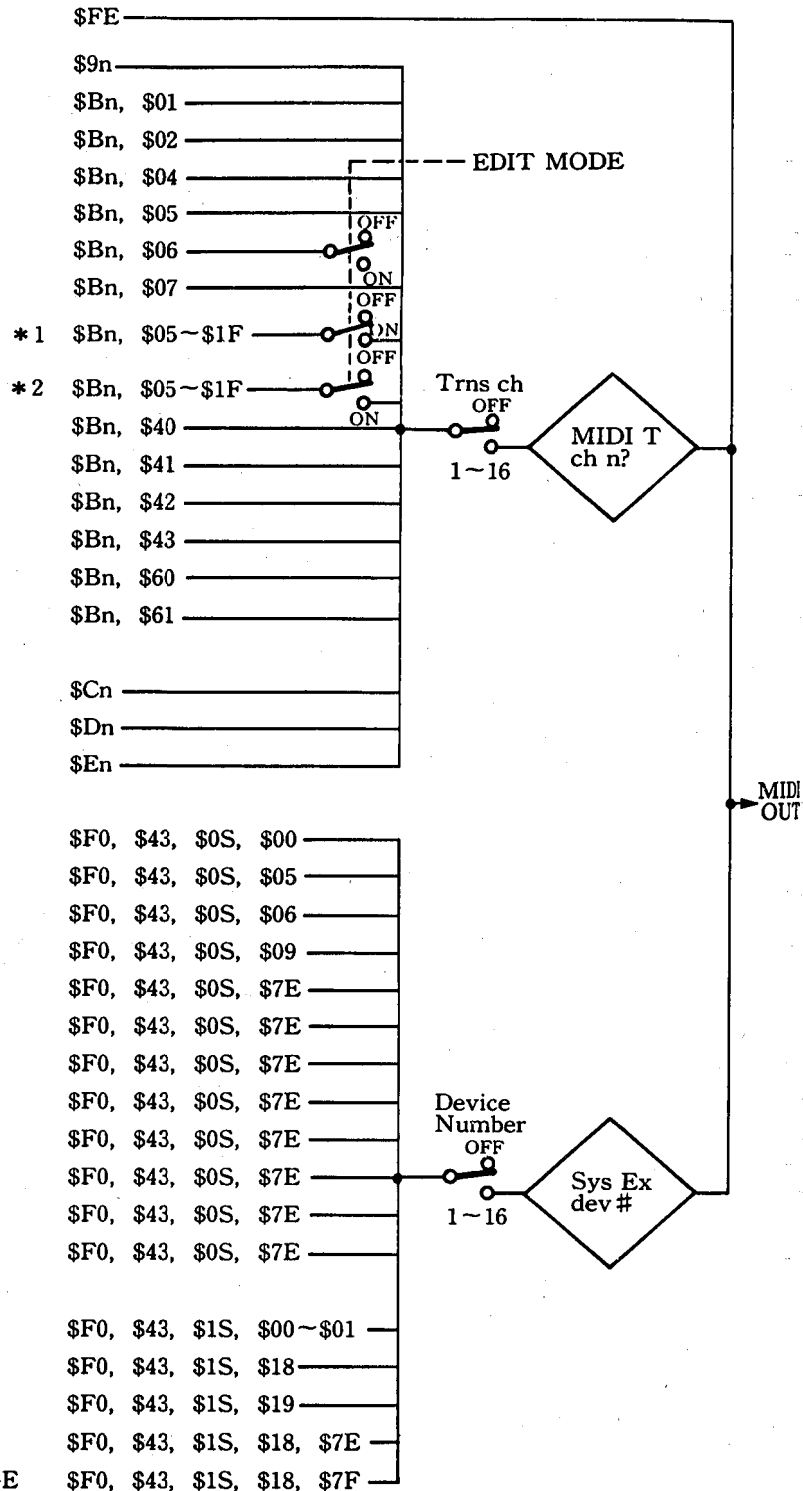

*1 BALANCE \$Bn, \$08 in EDIT MODE
 *2 DATA ENTRY \$Bn, \$06 in EDIT MODE



[2] Transmission Data

[2]-1 Channel Information

Transmission is possible only when 1~ 16 is specified as the transmission channel.

1) Channel voice message

1 Key ON/OFF

Status 1 0 0 1 n n n n (9n) n=channel No.
 Note No. 0 k k k k k k k k k k=36(C1)~96(C6)
 Velocity 0 v v v v v v v v (v=0) Key ON
 0 0 0 0 0 0 0 0 (v=0) Key OFF

2 Control change

Status 1 0 1 1 n n n n (Bn) n=channel No.
 Control No. 0 c c c c c c c c
 Control Value 0 v v v v v v v v

Control No.

- c=1 Modulation wheel v=0~127
- c=2 Breath control v=0~127
- c=4 Foot control v=0~127
- c=5 Portamento time v=0~127
- c=6 Data entry slider v=0~127
- c=7 Volume v=0~127
- c=5~
c=31 Continuous slider v=0~127
- c=64 Sustain SW v=0: OFF, 127: ON
- c=65 Portamento SW v=0: OFF, 127: ON
- c=66 Sostenuto v=0: OFF, 127: ON
- c=67 Soft v=0: OFF, 127: ON
- c=96 Data entry +1
- c=97 Data entry -1

3 Program change

Status 1 1 0 0 n n n n (Cn) n=channel No.
 Program No. 0 p p p p p p p p p p=0~63:
 INTERNAL
 p=64~127:
 CARTRIDGE

4 After touch

Status 1 1 0 1 n n n n (Dn) n=channel No.
 Value 0 v v v v v v v v v=0~127

5 Pitch bender

Status 1 1 1 0 n n n n (En) n=channel No.
 Value (LSB) 0 u u u u u u u u
 Value (MSB) 0 v v v v v v v v
 Resolution 7bit

The transmission data are as follows:

MSB		LSB		
00000000	(00)	00000000	(00)	Min.
01000000	(40)	00000000	(00)	Mid.
01111111	(7F)	01111110	(7E)	Max.

[2]-2 System Information

1) System real time message

Active sensing
 Status 1 1 1 1 1 1 1 0 (FE)

2) System exclusive message

Transmission is possible only when the device No. is set to 1~16.

1 Parameter change

Status 1 1 1 1 0 0 0 0 (F0)
 ID No. 0 1 0 0 0 0 1 1 (43)
 Substatus/
 device No. 0 0 0 1 n n n n (1n)
 Parameter
 group No. 0 g g g g g h h
 Parameter No. 0 p p p p p p p p
 Data 0 d d d d d d d } Single or multiple
 0 d d d d d d d } bytes
 EOX 1 1 1 1 0 1 1 1 (F7)

There are seven parameter group Nos. and parameter Nos.

Parameter	g	h	p	No. of data byte
Voice	0	0	0~127	1
	0	1	0~28	1
Supplement Note 3)	6	0	0~73	1
Performance	6	1	0~52	1
System set-up	6	1	64~	1
Micro tuning	6	0	126	3 Note 1)
Fractional scaling	6	0	127	4 Note 2)

NOTE 1

Data bytes				} total of 3 bytes
0 k k k k k k k k	key number			
0 h h h h h h h h	data (high)	0-84 binary		
0 1 1 1 1 1 1 1	data (low)	0-127 binary		

NOTE 2

Data bytes				} total of 4 byte
0 0 0 0 0 p p p	operator number			
0 0 k k k k k k k k	key group number			
0 h h h h h h h h	data (high)	0-1 binary		
0 1 1 1 1 1 1 1	data (low)	0-127 binary		

NOTE 3

Under the Supplement parameter change, DX7 function parameter change will be transmitted along with the above.



• Fractional Scaling Parameter Change

Operator number

P	Operator
0	op 6
1	op 5
2	op 4
3	op 3
4	op 2
5	op 1

Key group number

K	Key	Data
0	offset	-128~127
1	C#-2~C-1	0~256
2	C#-1~D#-1	↓
3	E-1~F#-1	
4	G-1~A-1	
5	A#-1~C0	
6	C#0~D#0	
7	E0~F#0	
8	G0~A0	
9	A#0~C1	
10	C#1~D#1	
11	E1~F#1	
12	G1~A1	
13	A#1~C2	
14	C#2~D#2	
15	E2~F#2	
16	G2~A2	
17	A#2~C3	
18	C#3~D#3	
19	E3~F#3	
20	G3~A3	
21	A#3~C4	
22	C#4~D#4	
23	E4~F#4	
24	G4~A4	
25	A#4~C5	
26	C#5~D#5	
27	E5~F#5	
28	G5~A5	
29	A#5~C6	
30	C#6~D#6	
31	E6~F#6	
32	G6~A6	
33	A#6~C7	
34	C#7~D#7	
35	E7~F#7	
36	G7~A7	
37	A#7~C8	
38	C#8~D#8	
39	E8~F#8	
40	G8	

(Complement of 2)
(Binary)

2 Bulk data

For {
 Voice edit buffer
 Supplement edit buffer
 Packed 32 supplement
 Packed 32 voice

Status 1 1 1 1 0 0 0 0 (F0)
 ID No. 0 1 0 0 0 0 1 1 (43)
 Substatus/
 device No. 0 0 0 0 n n n n (0n)
 Format No. 0 f f f f f f f
 Byte count (MSB) 0 b b b b b b b
 Byte count (LSB) 0 b b b b b b b
 Data 0 d d d d d d d
 ↓
 0 d d d d d d d
 Checksum 0 e e e e e e e
 EOX 1 1 1 1 0 1 1 1 (F7)

Format No.	Data	Byte count
0	Voice edit buffer	155
5	Supplement edit buffer	49
6	Packed 32 supplement	1120
9	Packed 32 voice	4096

• When using universal Bulk Dump

Status 1 1 1 1 0 0 0 0 (F0)
 ID No. 0 1 0 0 0 0 1 1 (43)
 Substatus/
 device No. 0 0 0 0 n n n n (0n)
 Format No. 0 1 1 1 1 1 1 0 (7E)
 Byte count (MSB) 0 b b b b b b b
 Byte count (LSB) 0 b b b b b b b
 Classification 0 a a a a a a a ASCII'L
 name 0 a a a a a a a 'M
 (4 bytes) 0 a a a a a a a 'L
 0 a a a a a a a 'L Repeat group
 Data format 0 m m m m m m m ASCII
 name (6 bytes) ↓
 0 m m m m m m m
 Data 0 d d d d d d d
 ↓
 0 d d d d d d d
 Checksum 0 e e e e e e e
 EOX 1 1 1 1 0 1 1 1 (F7)



Data	Byte count	Classification name	Data format name	No. of repeats
DX7 II Performance Edit Buffer	61	LM _ _	8973P E	1
DX7 II Packed 32 Performance	1642	LM _ _	9873P M	1
DX7 II System Set-up	112	LM _ _	8973 S _	1
Micro Tuning Edit Buffer	266	LM _ _	MCRYE	1
Micro Tuning with Memory #x	266	LM _ _	MCRYMx	2
Micro Tuning Cartridge	266	LM _ _	MCRYC _	64
Fractional Scaling Edit Buffer	502	LM _ _	FKSYE _	1
Fractional Scaling in Cartridge with Memory #	502	LM _ _	FKSYC _	32

Note 1) The x of MCRYMx is a memory No. expressed in binary form, 0 or 1.

Note 2) When the number of repeats is 64, the data group from byte count to checksum will be transmitted 64 times.

[3] Reception Requirements

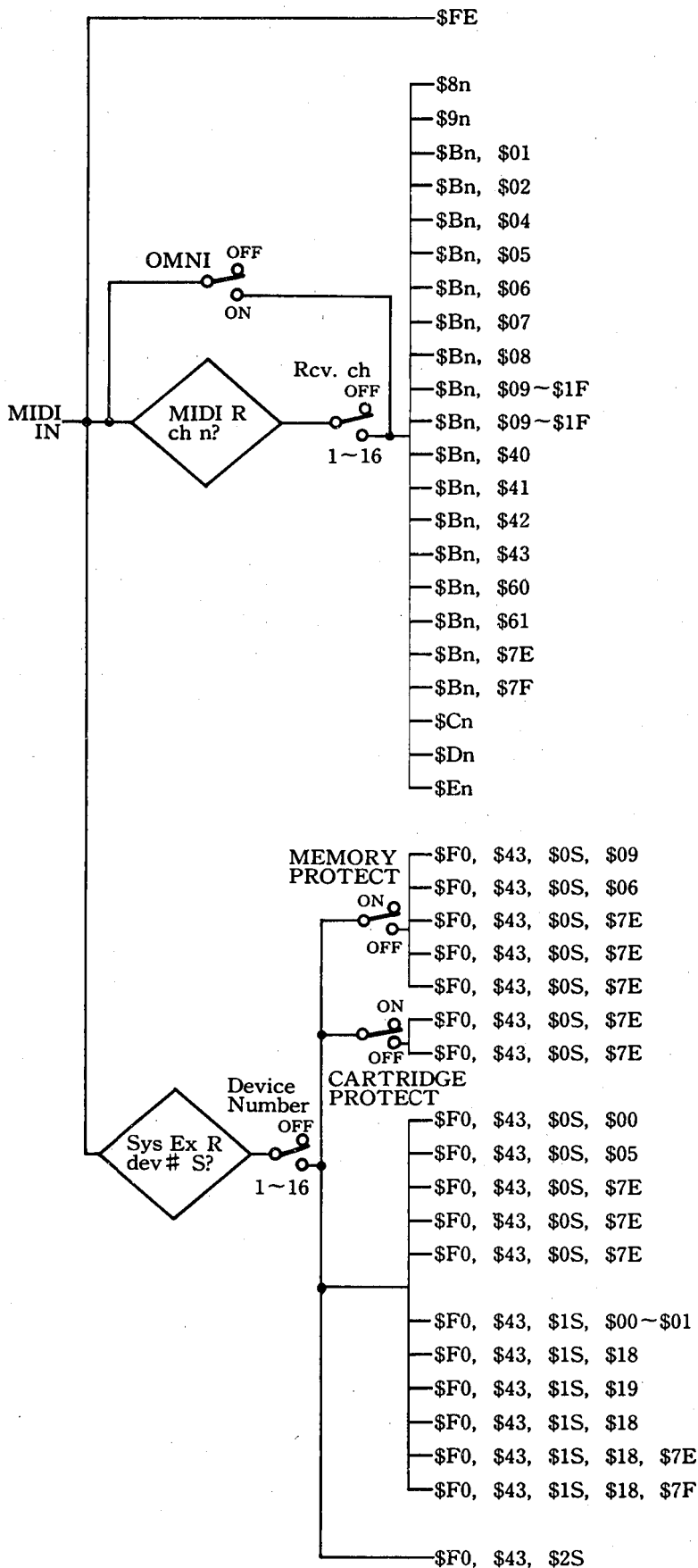

ACTIVE SENSING

- NOTE OFF
- NOTE ON/OFF
- MODULATION WHEEL
- BREATH CONTROL
- FOOT CONTROL
- PORTAMENTO TIME
- DATA ENTRY
- VOLUME
- BALANCE
- CONTINUOUS SLIDER
- MIDI CONTROL
- SUSTAIN SWITCH
- PORTAMENTO SWITCH
- SOSTENUTO
- SOFT
- DATA ENTRY +1
- DATA ENTRY -1
- POLY
- MONO
- PROGRAM CHANGE
- AFTER TOUCH
- PITCH BENDER

- PACKED 32 VOICE
- PACKED 32 SUPPLEMENT
- PACKED 32 PERFORMANCE
- SYSTEM SETUP
- MICRO TUNING IN MEMORY
- MICRO TUNING IN CARTRIDGE
- FRACTIONAL SCALING IN CARTRIDGE

- VOICE EDIT BUFFER
- SUPPLEMENT EDIT BUFFER
- PERFORMANCE EDIT BUFFER
- MICRO TUNING EDIT BUFFER
- FRACTIONAL SCALING EDIT BUFFER

- VOICE PARAMETER CHANGE
- SUPPLEMENT PARAMETER CHANGE
- PERFORMANCE PARAMETER CHANGE
- REMOTE SWITCH
- MICRO TUNING PARAMETER CHANGE
- FRACTIONAL SCALING PARAMETER CHANGE

- DUMP REQUEST



[4] Reception Data

[4]-1 Channel Information

There are two types of MIDI reception channels for channel messages: A and B.

Single mode : Only A is effective
 Dual mode : Only A is effective
 Split mode : A, B independent
 The split point function is effective when A=B, assigning A to the lower half and B to the upper half.

1) Channel voice message

1 Key OFF

Status 1 0 0 0 n n n n (8n) n=channel No.
 Note No. 0 k k k k k k k k k k=0(C₂)~127(G₈)
 Velocity 0 v v v v v v v v v v ignore vs

2 Key ON/OFF

Status 1 0 0 1 n n n n (9n) n=channel No.
 Note No. 0 k k k k k k k k k k=0(C₂)~127(G₈)
 Velocity 0 v v v v v v v v v v=1~127 Key ON
 0 0 0 0 0 0 0 0 0 0 Key OFF

3 Control change

Status 1 0 1 1 n n n n (Bn)
 Control No. 0 c c c c c c c c
 Control Value 0 v v v v v v v v

c=1	Modulation wheel	v=0~127
c=2	Breath control	v=0~127
c=4	Foot control	v=0~127
c=5	Portamento time	v=0~127
c=6	Data entry slider	v=0~127
c=8	Balance	v=0~127
c=9-31	Continuous slider	v=0~127
c=9-31	MIDI control	v=0~127
c=64	Sustain SW	v=0~63: OFF, 64~127: ON
c=65	Portamento SW	v=0~63: OFF, 64~127: ON
c=66	Sostenuto	v=0~63: OFF, 64~127: ON
c=67	Soft	v=0~63: OFF, 64~127: ON
c=96	Date entry + 1	
c=97	Date entry - 1	

The continuous sliders can be assigned to certain internal effects.

MIDI control can be assigned in the same way as foot control.

4 Program change

Status 1 1 0 0 n n n n (Cn) n=channel No.
 Program No. 0 p p p p p p p p p p=0~127

0~31 select internal PERFORMANCE combinations in PERFORMANCE mode.

32~63 select cartridge PERFORMANCE combinations. Values over 63 repeat this order of selection (INT 1~32 → CRT 1~32).

In Single, Dual or Split mode, 0~63 select INT voices, 64~127 CRT voices.

5 After touch

Status 1 0 1 1 n n n n (Dn) n=channel No.
 Value 0 v v v v v v v v v v=0~127

6 Pitch bender

Status 1 1 1 0 n n n n (En) n=channel No.
 Value (LSB) 0 u u u u u u u u
 Value (MSB) 0 v v v v v v v v

Operates with only the MSB data.

MSB

00000000 Min.
 01000000 Mid.
 01111111 Max.

2) Channel mode message

1 Poly/All note off

1 0 1 1 n n n n (Bn)
 0 1 1 1 1 1 1 0 (7E) Poly/All note off
 0 0 0 0 0 0 0 0

2 Mono/All note off

1 0 1 1 n n n n (Bn)
 0 1 1 1 1 1 1 1 (7F) Mono/All note off
 0 m m m m m m m m Set to the Mono mode with only m=1 recognized.
 Ignore when m=1.

[4]-2 System Information

1) System real time messages

Active sensing

Status 1 1 1 1 1 1 1 0 (FE)

Upon reception of the code, sensing will start. When there is no status byte or data for 300 msec, the MIDI reception buffer is cleared and the on-going sound turned OFF.

2) System exclusive messages

1 Parameter change (Switch remote)

Status 1 1 1 1 0 0 0 0 (F0)
 ID No. 0 1 0 0 0 0 1 1 (43)
 Substatus/
 device No. 0 0 0 1 n n n n (1n)
 Parameter
 group No. 0 0 0 1 1 0 1 1 (1B)
 Switch No. 0 m m m m m m m
 Data 0 d d d d d d d d = 0: OFF d = 127: ON
 EOX 1 1 1 1 0 1 1 1 (F7)

All the panel switches are controlled.

The switch numbers are follows:

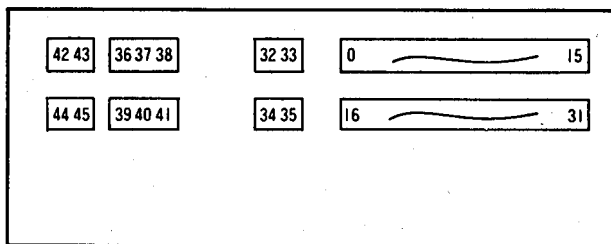

2 Parameter change

Same as for transmission

3 Bulk data

Same as for transmission

4 Dump request

For { Voice edit buffer (f=0)
 Supplement edit buffer (f=5)
 Packed 32 supplement (f=6)
 Packed 32 voice (f=9)

Status 1 1 1 1 0 0 0 0 (F0)
 ID No. 0 1 0 0 0 0 1 1 (43)
 Substatus/
 device No. 0 0 1 0 n n n n (2n)
 Format No. 0 f f f f f f f f f = 0, 5, 6, 9
 EOX 1 1 1 1 0 1 1 1 (F7)

• **Universal bulk dump**

Status 1 1 1 1 0 0 0 0 (F0)
 ID No. 0 1 0 0 0 0 1 1 (43)
 Substatus/
 device No. 0 0 1 0 n n n n (2n)
 Format No. 0 1 1 1 1 1 1 0 (7E)
 Classification 0 a a a a a a a
 name ↓
 (ASCII 4 letters) 0 a a a a a a a
 Data format 0 m m m m m m m
 name ↓
 (ASCII 6 letters) 0 m m m m m m m
 EOX 1 1 1 1 0 1 1 1

Classification name and data format name are same as for transmission.

DX7 II • FD/D

[Digital Programmable Algorithm Synthesizer]
 Model DX7-2 MIDI Implementation Chart

Date : 11/21, 1986
 Version : 1.0

Function ...	Transmitted	Recognized	Remarks
Basic Default	: 1 - 16	: 1 - 16	: memorized
Channel Changed	: 1 - 16	: 1 - 16	:
Mode Default	: 3	: 1, 2, 3, 4	: memorized
Mode Messages	: x	: POLY, MONO(M=1)	:
Mode Altered	: XXXXXXXXXXXXXXXX	: x X2	:
Note Number	: 36 - 96 X1	: 0 - 127 X2	:
Note True voice	: XXXXXXXXXXXXXXXX	: 1 - 127	:
Velocity Note ON	: o 9nH, v=1-127	: o v=1-127	:
Velocity Note OFF	: x 9nH, v=0	: x	:
After Key's	: x	: x	:
Touch Ch's	: o X1	: o X2	:
Pitch Bender	: o X1	: o 0-12 semi X2	: 7 bit resolution
Control	1 : o X1	o X2	: Modulation wheel
	2 : o X1	o X2	: Breath control
	4 : o X1	o X2	: Foot Controller
	5 : x X1	o X2	: Portamento time
	6 : o X1	x X2	: Data entry knob
Change	7 : o X1	o X2	: Volume
	8/10 : x / x	o / o X2	: Balance / Pan
	64 : o X1	o X2	: Sustain foot sw
	65 : o X1	o X2	: Portamento f sw
	66 : o X1	o X2	: Sostenuto
	67 : o X1	o X2	: Soft
	96/97 : o / o X1	o / o X2	: Data entry +/-1
	5-31 : o X1	o (11-31) X2	: Continuous slidr
Prog Change	: o 0 - 127 X1	: o 0 - 127 X2	:
Change True #	: XXXXXXXXXXXXXXXX	: 0 - 127	: 64-127:Cartridge
System Exclusive	: o X3	: o X3	: Voice parameters
System : Song Pos	: x	: x	:
: Song Sel	: x	: x	:
Common : Tune	: x	: x	:
System : Clock	: x	: x	:
Real Time : Commands	: x	: x	:
Aux : Local ON/OFF	: x	: x	:
: All Notes OFF	: x	: o (126,127)	:
Mes- : Active Sense	: o	: o	:
sages:Reset	: x	: x	:
Notes:	X1 = transmit if transmit channel is not off.		
	X2 = receive if receive channel is not off.		
	X3 = transmit/receive if device number is not off.		

Mode 1 : OMNI ON, POLY Mode 2 : OMNI ON, MONO
 Mode 3 : OMNI OFF, POLY Mode 4 : OMNI OFF, MONO

o : Yes
 x : No 24

LSI DATA TABLE

● HD6805S1A33P (IG105300) CPU

PIN NO.	NAME	I/O	FUNCTION	PIN NO.	NAME	I/O	FUNCTION
1	V _{ss}	I	Ground	15	B3	I/O	Port B
2	INT	I	Interrupt	16	B4	I/O	
3	V _{cc}	I	DC Supply	17	B5	I/O	
4	EXTAL	I	Clock	18	B6	I/O	
5	XTAL	I					
6	NUM	I	Ground (not user's application)	20	A0	I/O	Port A
7	TIMER	I	Timer control	21	A1	I/O	
8	C0	I/O	Port C	22	A2	I/O	
9	C1	I/O					
10	C2	I/O					
11	C3	I/O	Port B	24	A4	I/O	
12	B0	I/O		25	A5	I/O	
13	B1	I/O		26	A6	I/O	
14	B2	I/O		27	A7	I/O	
				28	RES	I	Reset

● HD63B03YP (XA444001) MAIN-CPU

PIN NO.	NAME	I/O	FUNCTION	PIN NO.	NAME	I/O	FUNCTION
1	V _{ss}	I	Ground	33	V _{cc}	O	DC Supply (+5V)
2	XTAL	I	Clock (8MHz)	34	V15	O	Address bus
3	EXTAL	I					
4	MPO	I	Mode program	35	A14	O	
5	MP1	I					
6	RES	I	Reset	36	A13	O	
7	STBY	I	Stand-by mode signal	37	A12	O	
8	NMi	I	Non-maskable interrupt	38	A11	O	
9	P20	I/O	Port 2	39	A10	O	
10	P21	I/O					
11	P22	I/O					
12	P23	I/O					
13	P24	I/O					
14	P25	I/O					
15	P26	I/O					
16	P27	I/O					
17	P50	I/O	Port 5	40	A9	O	
18	P51	I/O					
19	P52	I/O					
20	P53	I/O					
21	P54	I/O					
22	P55	I/O					
23	P56	I/O					
24	P57	I/O					
25	P60	I/O	Port 6	41	A8	O	
26	P61	I/O					
27	P62	I/O					
28	P63	I/O					
29	P64	I/O					
30	P65	I/O					
31	P66	I/O					
32	P67	I/O					
				42	V _{ss}	O	Ground
				43	A7	O	Address bus
				44	A6	O	
				45	A5	O	
				46	A4	O	
				47	A3	O	
				48	A2	O	Data bus
				49	A1	O	
				50	A0	O	
				51	D7	I/O	
				52	D6	I/O	
				53	D5	I/O	
				54	D4	I/O	
				55	D5	I/O	
				56	D2	I/O	
				57	D1	I/O	
				58	D0	I/O	
				59	BA	O	Bus available
				60	LIR	O	Load instruction resistor
				61	R/W	O	Read/Write control
				62	WR	O	Write
				63	RD	O	Read
				64	E	O	Enable

● M58990P-1 (IG106100) Analog Digital Converter

PIN NO.	NAME	I/O	FUNCTION	PIN NO.	NAME	I/O	FUNCTION
1	IN3	I	Analog data in	15	2-6	O	Digital data output
2	IN4	I					
3	IN5	I					
4	IN6	I					
5	IN7	I					
6	START	I	Start data in	16	REF(-)	O	Reference voltage (-)
7	EOC	O	End of conversion data output	17	2-8	O	Digital data output
8	2-5	O	Digital data output	18	2-4	O	
9	OE	I	Output enable data in	19	2-3	O	
10	CLK	I	Clock data in	20	2-2	O	
11	V _{cc}	I	Supply power (+5V)	21	2-1	O	
12	REF(+)	I	Reference voltage (+)	22	ALE	I	Address latch enable data in
13	GND	I	Supply power (0V)	23	ADD A	I	Address data in
14	2-7	O	Digital data output	24	ADD B	I	
				25	ADD C	I	
				26	IN 0	I	Analog data in
				27	IN 1	I	
				28	IN 2	I	



● YM2604 (XA489001) OPSII (Operator-S)

PIN NO.	NAME	I/O	FUNCTION	PIN NO.	NAME	I/O	FUNCTION
1	V _{SS}	I	DC supply (0V)	33	DA7	O	Digital code for analog convert
2	D6	I/O	Data buses	34	DA8	O	
3	D7	I/O		35	DA9	O	
4	DS	I		36	DA10	O	
5	WR	I	Read write control	37	DA11	O	
6	—	—	Non connection	38	DA12	O	
7	—	—		39	DA13	O	
8	—	—		40	DA14	O	
9	SH1	O		Sample and hold data	41	DA15	
10	SH2	O	42		DA16	O	
11	SYNC	O	43		E1	I	
12	F1	I	Frequency data (from EGS)	44	E2	I	
13	F2	I		45	E3	I	
14	F3	I		46	E4	I	
15	F4	I		47	E5	I	
16	F5	I		48	E6	I	
17	V _{SS}	I		DC supply (0V)	49	E7	I
18	F6	I	Frequency data (from EGS)	50	E8	I	
19	F7	I		51	E9	I	
20	F8	I		52	E10	I	
21	F9	I		53	E11	I	
22	F10	I		54	E12	I	
23	F11	I		55	KON	I	Key ON data
24	F12	I	56	D0	I/O		
25	F13	I	Digital code for analog convert	57	D1	I/O	
26	F14	I		58	D2	I/O	
27	DA2	O		59	D3	I/O	
28	DA3	O		60	D4	I/O	
29	DA4	O		61	D5	I/O	
30	DA5	O		62	V _{DD}	I	DC supply (+5V)
31	DA6	O	63	φ1	I		
32	V _{SS}	I	64	φ2	I		
						Master clock pulse	

● YM3609 (XA898001) Envelope Generator

PIN NO.	NAME	I/O	FUNCTION	PIN NO.	NAME	I/O	FUNCTION
1	V _{CC}		Power supply	33	V _{SS}	.	Ground
2	NC		Envelope data	34	φ2	I	Clock IN
3	E6	O		35	TEST	I	Test pin
4	E7	O		36	D0	I	Data bus
5	E8	O		37	D1	I	
6	E9	O		38	D2	I	
7	E10	O		39	D3	I	
8	E11	O		40	NC		Data bus
9	E12	O		41	NC		
10	NC			42	NC		
11	NC		43	D4	I		
12	NC		44	D5	I	Data bus	
13	KON	O	45	D6	I		
14	F1	O	46	D7	I		
15	F2	O	47	NC			Address bus
16	F3	O	48	A0	I		
17	F4	O	49	A1	I		
18	F5	O	50	A2	I		
19	F6	O	Frequency data	51	A3	I	
20	F7	O		52	A4	I	
21	F8	O		53	NC		
22	F9	O		54	NC		
23	NC			55	CE1	I	Chip enable
24	NC			56	CE2	I	
25	NC		57	NC		Synchro pulse	
26	F10	O	58	NC			
27	F11	O	59	SYNC	I		
28	F12	O	60	E1	O		Envelope data
29	F13	O	61	E2	O		
30	F14	O	62	E3	O		
31	IC	I	63	E4	O		
32	V _{CC}		64	E5	O		

● **PCM54HP (XA566001)** Digital Analog Converter

PIN NO.	NAME	I/O	FUNCTION	PIN NO.	NAME	I/O	FUNCTION
1	Vpot		Not used	15	DA4		Bit 13
2	DA16		Bit 1 (MSB)	16	DA3		Bit 14
3	DA15		Bit 2	17	DA2		Bit 15
4	NC		Not used	18	LSB		Bit 16
5	DA14		Bit 3	19	V ₀		Voltage Output
6	DA13		Bit 4	20	FBR		Not used
7	DA12		Bit 5	21	INV		Summing Junction
8	DA11		Bit 6	22	GND		Common
9	DA10		Bit 7	23	I ₀		Current Output
10	DA9		Bit 8	24	NC		Not Used
11	DA8		Bit 9	25	OFF-S		Not Used
12	DA7		Bit 10	26	+V _{cc}		+15V
13	DA6		Bit 11	27	ADJ		Not Used
14	DA5		Bit 12	28	-V _{cc}		-15V

● **WD1772PH-02 (XB623001)** Floppy Disk Controller/formatter

PIN NO.	NAME	I/O	FUNCTION	PIN NO.	NAME	I/O	FUNCTION
1	CS	I	Chip select	15	V _{cc}	O	Power supply
2	R/W	I	Read/Write control	16	STEP	O	Step pulse
3	A0	I	Address bus	17	DIRC	O	Direction control
4	A1	I		18	CLK	I	Clock IN
5	DAL0	I/O		19	RD	I	Read data
6	DAL1	I/O		20	MO	O	Motor ON
7	DAL2	I/O	Data access lines	21	WG	O	Write gate
8	DAL3	I/O		22	WD	O	Write data
9	DAL4	I/O		23	TR00	I	Track 00 signal
10	DAL5	I/O		24	IP	I	Index pulse
11	DAL6	I/O		25	WPRT	I	Write protect
12	DAL7	I/O		26	DDEN	I	Double density request
13	MR	I		27	DRQ	O	Data request
14	V _{ss}		Ground	28	INTRQ	O	Interrupt request

● **μPD8255AC-2 (XA052001)** I/O PORT A-D

PIN NO.	NAME	I/O	FUNCTION	PIN NO.	NAME	I/O	FUNCTION
1	PA3		Port A	40	PA4		Port A
2	PA2			39	PA5		
3	PA1			38	PA6		
4	PA0			37	PA7		
5	RD		Read control	36	WR		Write control
6	CS		Chip Select	35	RST		Reset
7	GND		DC Supply (0V)	34	D0	I/O	Data bus
8	A1		Port address	33	D1	I/O	
9	A0			32	D2	I/O	
10	PC7			31	D3	I/O	
11	PC6		30	D4	I/O		
12	PC5		29	D5	I/O		
13	PC4		28	D6	I/O		
14	PC0		Port C	27	D7	I/O	
15	PC1		Port B	26	V _{cc}		DC Supply
16	PC2			25	PB7		
17	PC3			24	PB6		
18	PB0			23	PB5		
19	PB1			22	PB4		
20	PB2			21	PB3		

IC BLOCK DIAGRAM

- **HD7405 (IG105500)**
TC40H004P (IG051000)
Hex Inverter

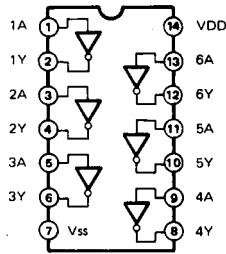

- **SN74HC08N (IR000850)**
Quad 2 Input AND

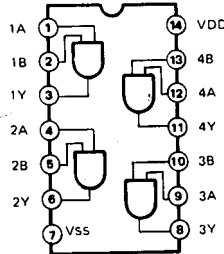

- **HD74LS14P (IG049600)**
Hex Inverter

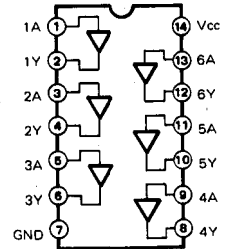

- **TC40H010P (iG100200)**
Triple 3 Input NAND

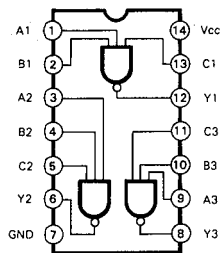

- **SN74HC32N (IR003250)**
TC40H032P (IG052800)
Quad 2 Input OR

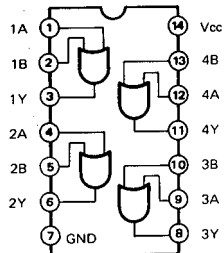

- **TC40H074P (IG051100)**
Dual D-Type Flip-Flop

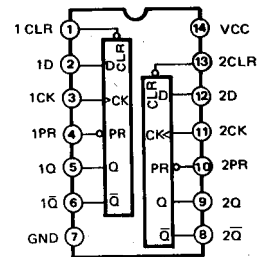

INPUTS				OUTPUTS	
PR	CLR	CLK	D	Q	Q̄
L	H	X	X	H	L
H	L	X	X	L	H
L	L	X	X	H	H
H	H	↑	H	L	L
H	H	↑	L	L	H
H	H	L	X	Q _o	Q̄ _o

- **TC74HC138P (IR013800)**
TC40H138P (IG111900)
3 to 8 Demultiplexer

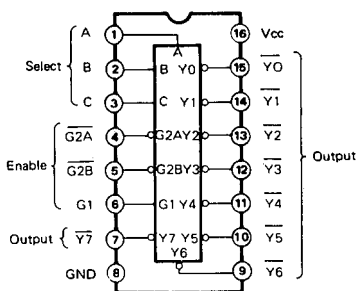

- **TC40H139P (IG078300)**
Dual 2 to 4 Demultiplexer

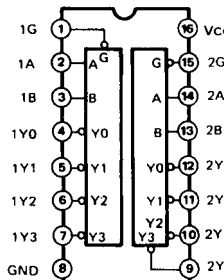

- **HD74LS174P (IG050000)**
TC40H174P (IG064100)
Hex D-Type Flip-Flop

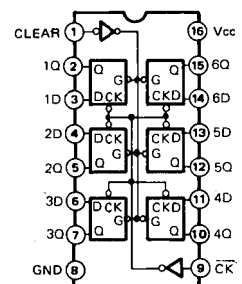

DX7 II • FD/D

- **TC40H240P (IG068100)**
Octal Bus Inverter

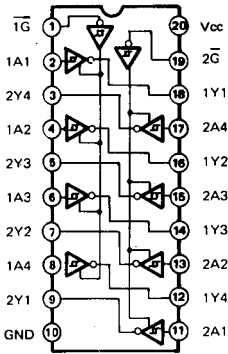

- **HD74LS244P (IG060000)**
Octal 3-State Bus Buffer

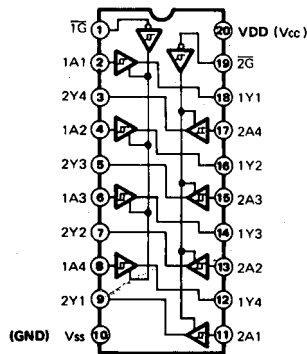

- **MC74HC245N (IR024570)**
Octal 3-State Bus Transceiver

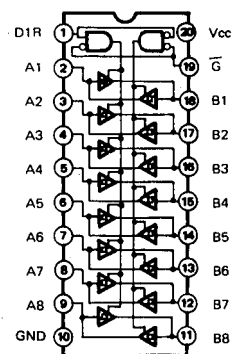

- **HD74LS365AP (IG103200)**
Hex 3-State Bus Buffer

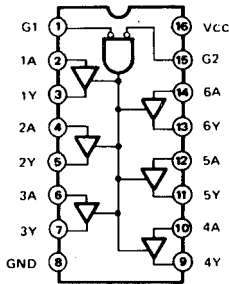

- **TC4066BP (IG001270)**
Quad Bilateral Switch

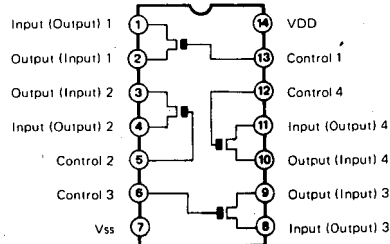

- **NJM4558DV (IG001390)**
Dual Operation Amplifier

