



GENUINE PARTS



## iPOD INSTALLATION INSTRUCTIONS

### 1. DESCRIPTION: iPod

2. PART NUMBERS:	iPod Gateway Module Kit (Nissan 2004-05)	999U7-VR000
	iPod Gateway Module Kit (Infiniti 2004-05)	999U7-VR001
	N-Bus harness for iPod Gateway	999U7-VS000
	N-Bus harness for [optional] SAT Radio	999U7-VS001

3. MODEL APPLICATION: ARMADA, TITAN & QX56 (2004~5) w/ SAT Pre-wired N-Bus Harness

### 4. IPOD GATEWAY MODULE KIT CONTENTS (999U7-VR000/1):

No.	Parts	Qty	Parts View
1	iPod Gateway Module	1	
2	Cable tie (8")	12	
3	Cable tie (15")	6	
4	Double-Sided Tape	1	
5	Foam Tape	9	
6	Grommet	1	
7	Alcohol Wipe	1	
8	iPod Cable	1	
9	Quick Reference Card	1	
10	Owners Manual	1	
11	Service Info Insert	1	
12	Critical Installation Info	1	

### ⚠ CAUTION

- Cut the excess cable tie(s) as flush with the head as possible. Face head of cable tie away from sheet metal and other objects.
- Use caution when removing/re-installing interior components to avoid damage, scratches, or breaking of mounting clips.

### NOTE

- This is a universal installation kit so all parts may not be used.
- Refer to the vehicle specific SAT radio Installation Instructions on ASIST.NET for further information.
- Ensure the Owners Manual and Quick Reference Card are placed in the customers glove box.
- Check the customer's iPod to make sure it has the most current software version before starting the install. ([www.apple.com/ipod](http://www.apple.com/ipod))

- In the event the iPod system needs to be serviced, order the iPod Service Kit below.

**iPod Gateway Service Kit      999U7-VS002SP**

### 5. TOOLS & MATERIALS REQUIRED:

1. Phillips screwdriver (#2)
2. Electrical tape
3. Masking tape
4. Drill
5. 1/8", 11/16" drill bits
6. 1/4" driver w/ 8mm socket
7. Plastic Pry bar
8. PGF Stick

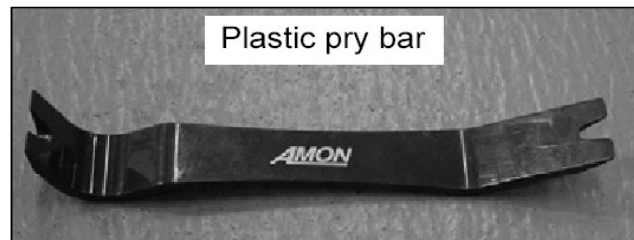
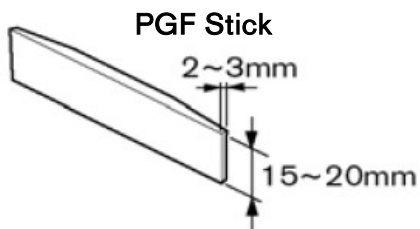

### 6. INSTALLATION OUTLINE:

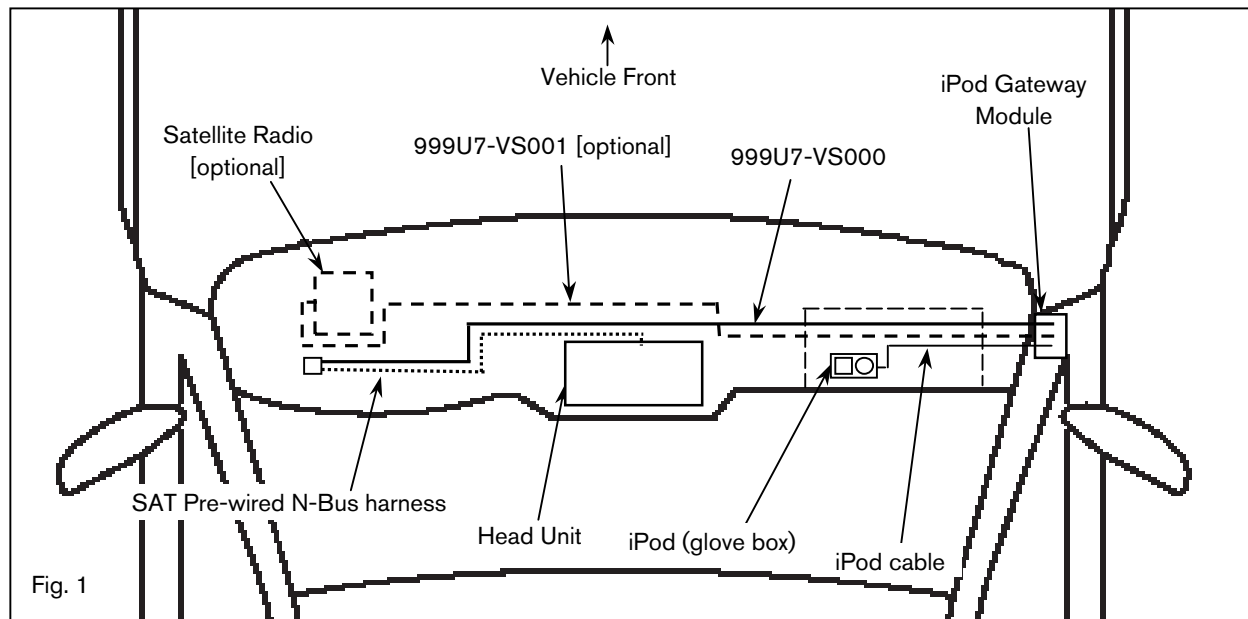

## 7. VEHICLE PREPARATION:

- (1) Apply parking brake.
- (2) Record the customer radio presets.

Bank	1	2	3	4	5	6	7
A							
B							
C							

- (3) Make sure that the shift lever is engaged in the "P" position.
- (4) If equipped, move the accelerator and brake pedals to the front most position.
- (5) Turn the ignition switch OFF
- (6) Open engine hood.
- (7) Disconnect the battery negative terminal to prevent short circuits during installation.
- (8) Locate N-BUS harness on the speaker amplifier bracket. Fig. 2



(9) Remove the following interior parts as shown in Fig. 2 (Refer to vehicle service manual)

- a) Instrument lower cover LH
- b) Instrument lower cover RH
- c) Glove Box assembly

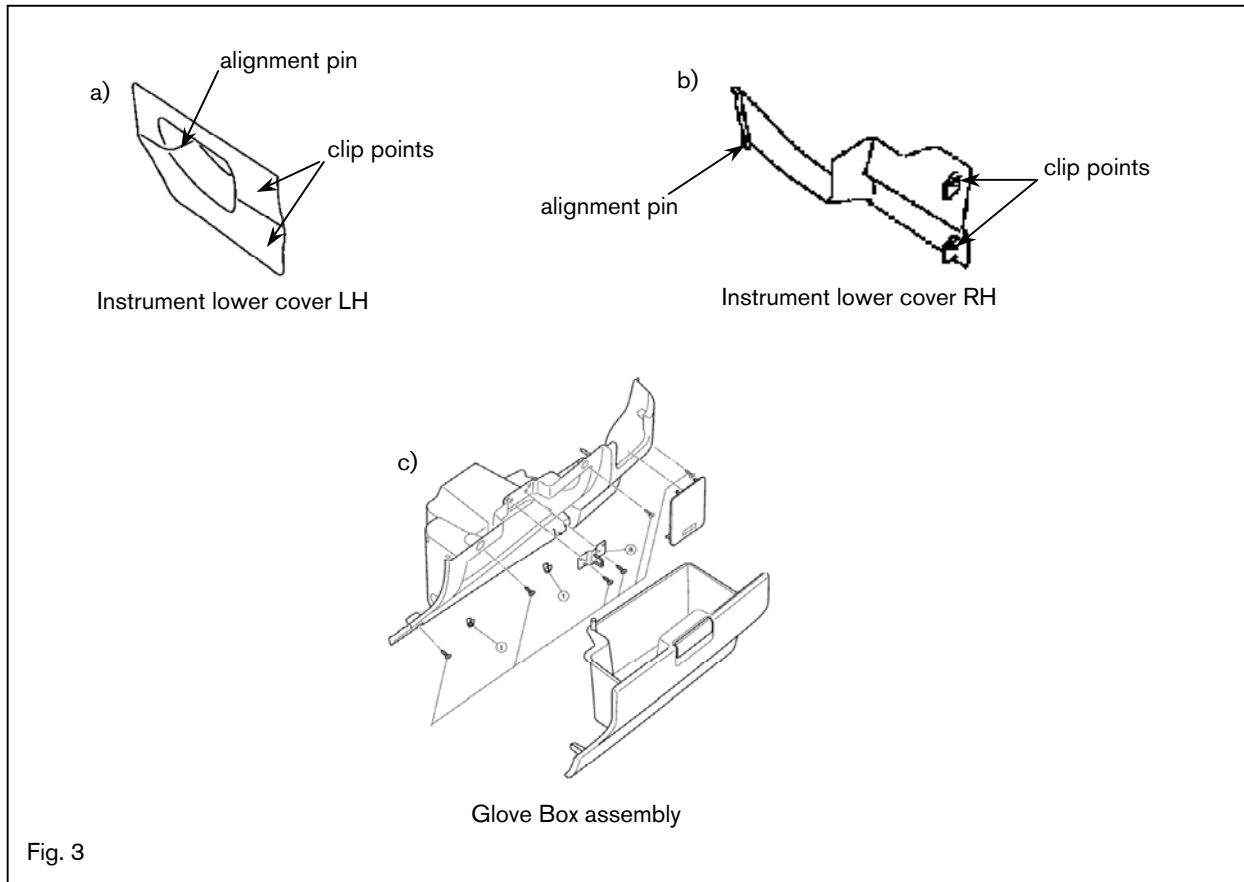
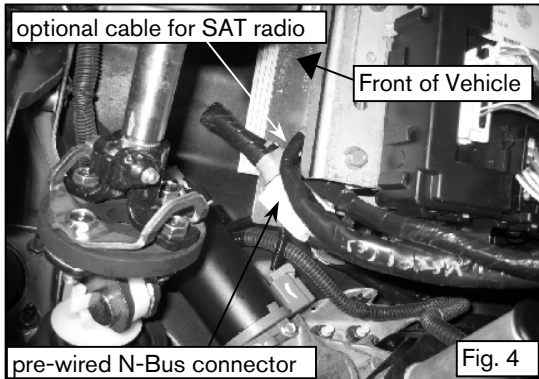
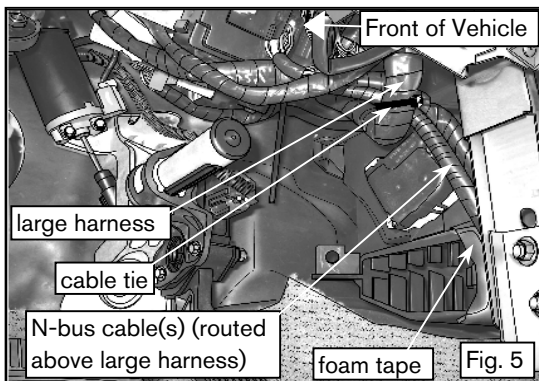

Fig. 3

8. CABLE ROUTING (iPOD GATEWAY & [OPTIONAL: SATELLITE RADIO]):



- (1) Connect corresponding connector of the iPod gateway harness to the vehicle's prewired N-Bus. From vehicle's N-Bus prewired connector start by routing down to lower center console. Route cable on passenger side of (above) large harness near center console. [Optional: Connect corresponding connector of the Satellite harness to the correct tuner connector. Route cable the same as iPod gateway harness.] Secure the cable(s) to the large harness with one (1) cable tie. Fig. 4 & 5



- (2) Route cable down to lower vent. Before routing cable further add two (2) pieces of foam tape to outer edge of the vent on both sides to prevent vibration noise. Route to other side of center console through cavity below vent opening. Add one (1) piece of foam tape to the edge of the metal framing where the cable(s) exit near the vent. [Optional: Route Satellite cable in the same fashion.] Secure cable(s) to nearby metal framing with one (1) cable tie threaded through the hole in the metal framing. Fig. 5 & 6

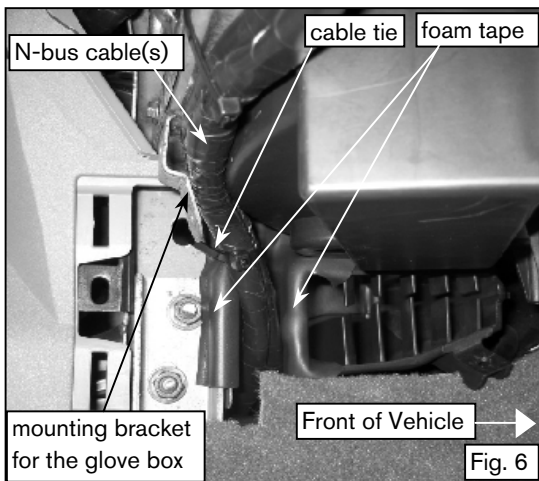

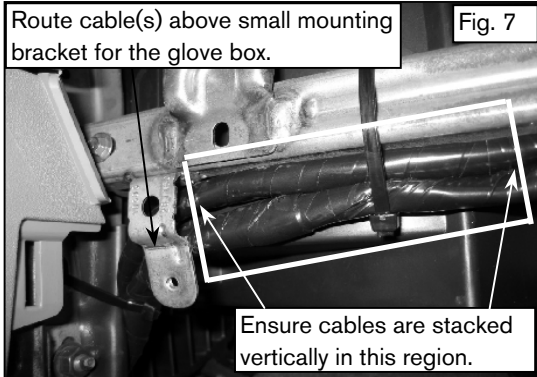

- (3) Before routing cable(s) into C-channel, route cable(s) behind and above small mounting bracket for the glove box. Route cable(s) up towards C-channel in the glove box's cavity. [Optional: Route Satellite cable in the same fashion.] Fig. 7

- (4) If routing the satellite radio bus cable ensure that they are stacked vertically directly to the right of the glove box mounting bracket to the point they are inserted into the C-channel. Fig. 7

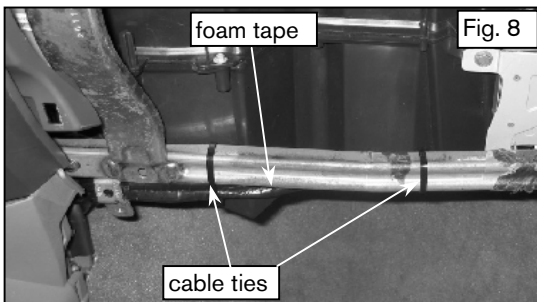

**CAUTION**

If cables are not orientated vertically the glove box will not fit nor shut properly.

- (5) Add one (1) piece of foam tape to the sharp edge of the lower part of C-channel where cable(s) will enter the channel. Route cable into C-channel towards RH door. [Optional: Route Satellite cable in the same fashion.] Attach two (2) cable ties around C-channel. While cinching the left most cable tie ensure that the cables remain vertically stacked. Fig. 7 & 8

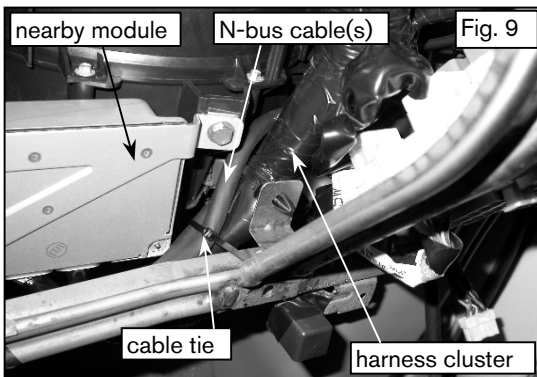

- (6) Route cable(s) out of C-channel between nearby module and large harness cluster. [Optional: Route Satellite cable in the same fashion.] Secure with one (1) cable tie to the harness cluster. Fig. 9

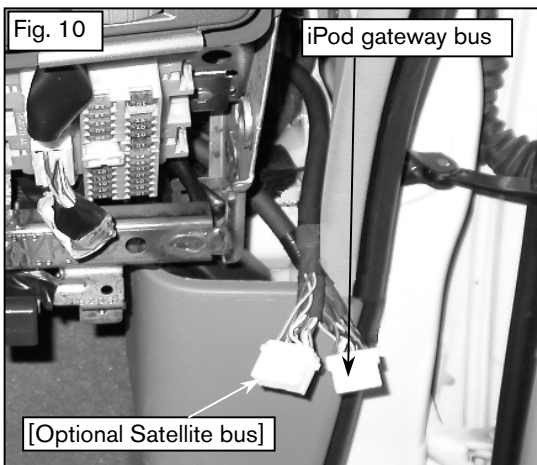

- (7) Route behind harness cluster and through rear of RH dash frame. Continue to route cable towards the opening in dash to the right of the fuse panel and leave dangling until installing the module later. [Optional: Route Satellite cable in the same fashion.] Fig. 10

## 9. CABLE ROUTING (IPOD CABLE):

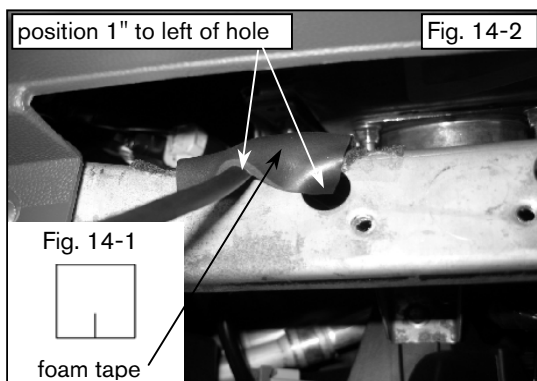
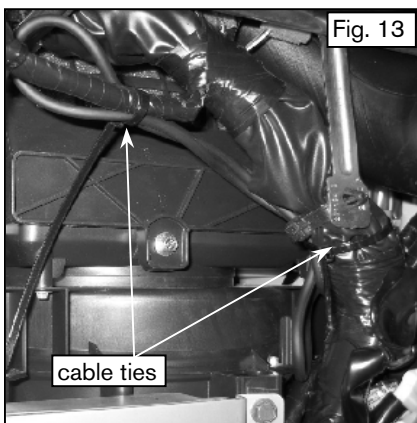
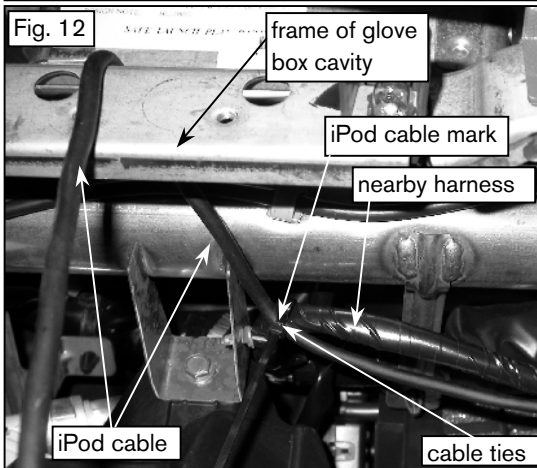
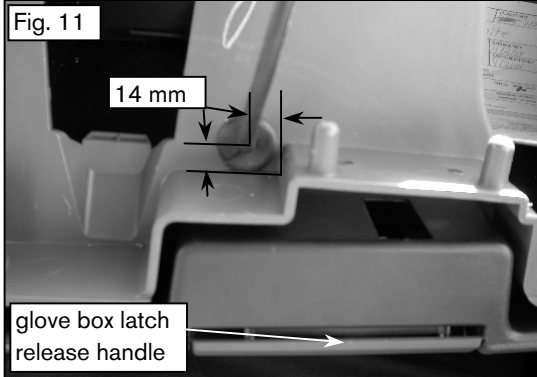

- (1) Using a 1/8" bit, drill a pilot hole in the upper part of the glove box 14mm +/-1 mm (0.55in) from both front and right walls of the box. Then use an 11/16" drill bit to open up the hole. Fig. 11

### ⚠ CAUTION

Accurate measuring is important in this step due to possible interference issues with the iPod cable and the opening/closing of the glove box.

- (2) Mark the iPod cable 762mm +/- 25mm (30in +/- 1in) from the iPod connector (rectangular connector). Start routing iPod cable from inside of glove box with DIN connector end (round connector). Route out of glove box through the drilled hole. Place split grommet over wire and feed into drilled hole in glove box. A PGF stick or other plastic prying tool may be helpful. Fig. 11
- (3) Route cable up and over upper frame of glove box cavity. Continue routing down and to the right of the glove box cavity. Secure with one (1) cable tie on the iPod cable mark made earlier to nearby harness. Fig. 12
- (4) Follow bus cables to the iPod gateway mounting location allowing enough room for a connection to the module. Any extra cable can be wrapped into a 8"-9" bundle. Wrap electrical tape around the bundle in two (2) places for at least two (2) revolutions and secure with (2) cable ties behind the nearby large harness. Fig. 13
- (5) Cut one (1) piece of foam tape in half width-wise. Cut slit in middle of foam tape piece 1/3 of the length. Position the iPod cable 25mm (1") to the left measuring from the center of the left most hole in the upper frame. Place piece of foam tape over iPod cable and secure to upper frame of glove box cavity with the slit facing the front of the vehicle. Fig 14-1 & 14-2

### NOTE

When re-installing the glove box any slack needs to be pulled out. When lifting the glove box in place pull the cable from the inside of the glove box.

- (6) Temporarily put the glove box back into place.
- (7) With glove box in place, and the slack pulled into the box, the distance from the grommet in the glove box to the iPod end of the cable should be 560mm +/- 25mm (22in +/- 1in).

## 10. IPOD GATEWAY MOUNTING:



Fig. 15

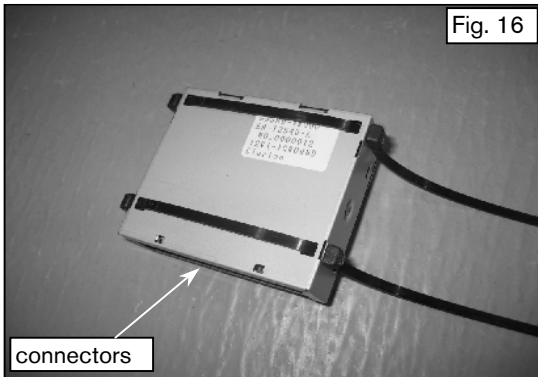

Fig. 16

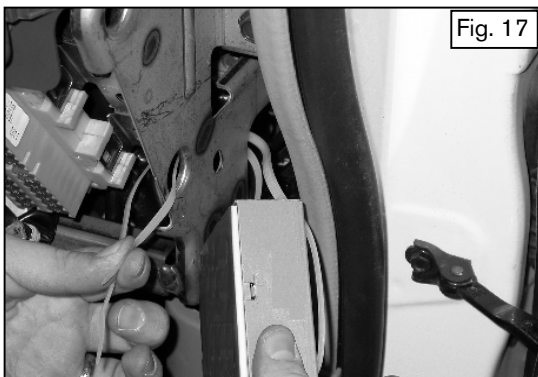

Fig. 17

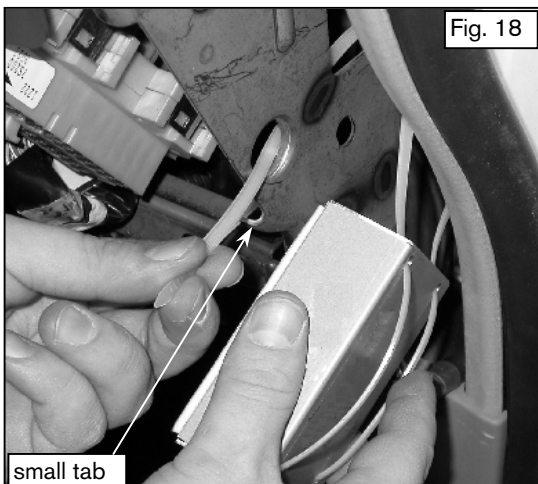

Fig. 18

small tab

- (1) Connect all routed cables to the corresponding terminals of the iPod gateway. Fig. 15
- (2) Thread the two (2) large cable ties through the holes in the chassis from left to right (label facing up). Ensure that the cable ties are pulled through with no slack and the head is pulled right up to module. Fig. 16
- (3) Attach another two (2) large cable ties, one to each of the threaded cable ties from the previous step. Fig. 16
- (4) Cut the threaded cable ties from step 2 even with the head of the cable ties from step 3. Fig. 16
- (5) Using the provided alcohol wipe, clean the bottom of the module and corresponding mounting location. Attach provided double-sided tape to bottom of module. Do not peel off tape liner on the other side yet.

### NOTE

Partially removing the door molding may help provide more room for maneuvering.

- (6) Feed both large cable ties around metal frame as shown. Keep track of the upper and lower cable tie. Feed upper cable tie through small hole in frame and connect to head of cable tie for a few clicks. Feed lower cable tie around frame under the small tab and connect to cable tie head for a few clicks. Fig. 17, 18 & 19

### CAUTION

Ensure that the large cable ties do not wrap around any other cables or objects.



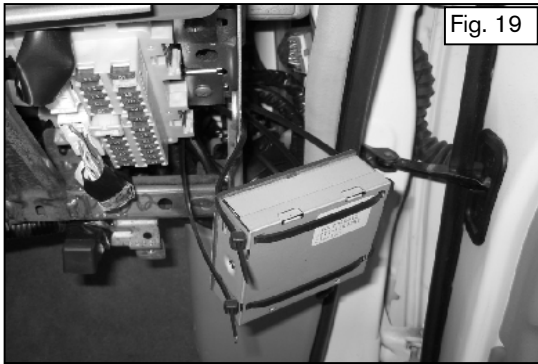

(7) Now the tape liner can be removed and the assembly put into place. Fig 20

(8) Position the assembly just in front of and at equal height as the top of the hole in the metal frame. Apply equal pressure to the module for at least 20 seconds. After attaching to metal frame let the module sit for 5 minutes to ensure good adhesion before applying any shear pressure. Fig. 20

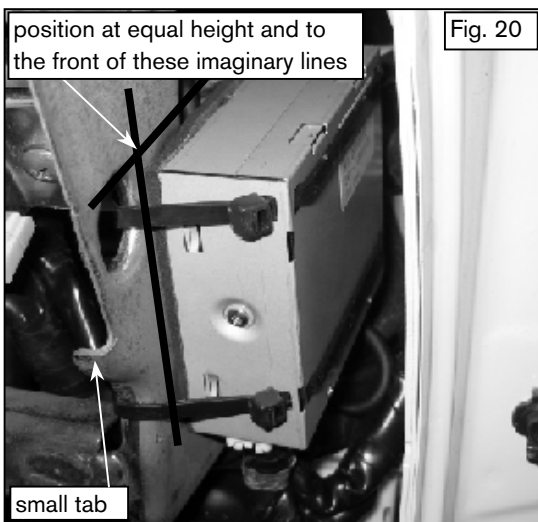

(9) Tighten the large cable ties. Fig. 20

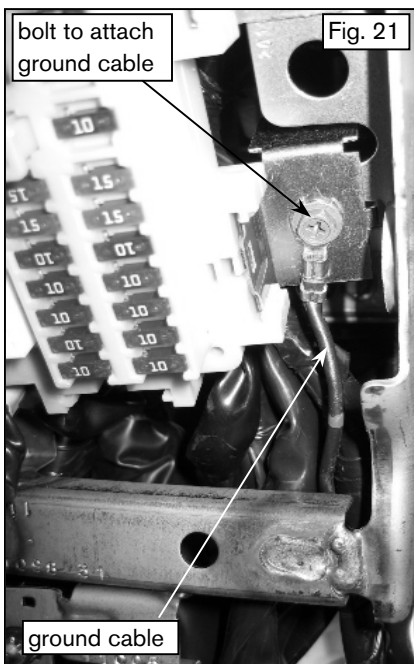

(10) Take the ground wire tapped off of the N-bus harness and route towards lower bolt securing the fuse panel. Fig. 21

(11) Use an 8mm socket to remove the bolt. Insert the eyelet connector. Tighten the bolt back down to secure the eyelet. Fig. 21

**11. OPERATION CHECK:**

- (1) Connect the battery negative terminal.
- (2) Turn vehicle ignition switch to the "ACC" position.
  
- (3) Reference the vehicle specific Satellite Radio Installation Instructions for further information. If Satellite radio was part of installation turn radio on then select satellite radio mode. Acquiring (Sirius) or Loading (XM) will display for a while. If not, move vehicle to outside and try again.
- (4) If Satellite radio was part of installation tune to preview channel (XM: channel "1" / Sirius: channel "184") to make sure receiving preview channel correctly. For Sirius tuner installations the preview channel may not be accessible. For further information reference the Operation Check section of the vehicle specific Satellite Radio Installation Instructions.
  
- (5) Confirm proper audio operation. (AM / FM / SAT / TAPE / CD)
- (6) Confirm accelerator pedal function per service manual.
- (7) If no iPod is present the head unit display should show "NO IPOD". If an iPod is connected to the system a check mark should be displayed on the iPod screen and audio should start playing in 5-20
- (8) A full diagnostic tree is available on the next page for troubleshooting the system.

**12. REINSTALLATION OF REMOVED PARTS:**

- (1) Re-install the RH Instrument Lower Cover referring to the service manual for the vehicle.
- (2) Re-install all removed vehicle parts referring to the service manual for the vehicle.

 **CAUTION**

Use caution when re-installing interior components to avoid damage, scratches, or breaking of mounting clips. Refer to the vehicle specific service manual for more information.

- (3) Clean interior of vehicle.

**13. FINAL INSPECTION:**

- (1) Inspect the vehicle interior and exterior for damage.
  
- (2) Confirm proper operation of vehicle systems.
  
- (3) Reset radio presets to the recorded settings.
  
- (4) If equipped, verify proper sunroof operation and perform the reset procedure if necessary. Refer to Service Manual requirements.
  
- (5) Place the Owners Manual and Quick Reference Card in the customers glove box.

NISSAN IPOD INTERFACE DIAGNOSTIC FLOW CHART

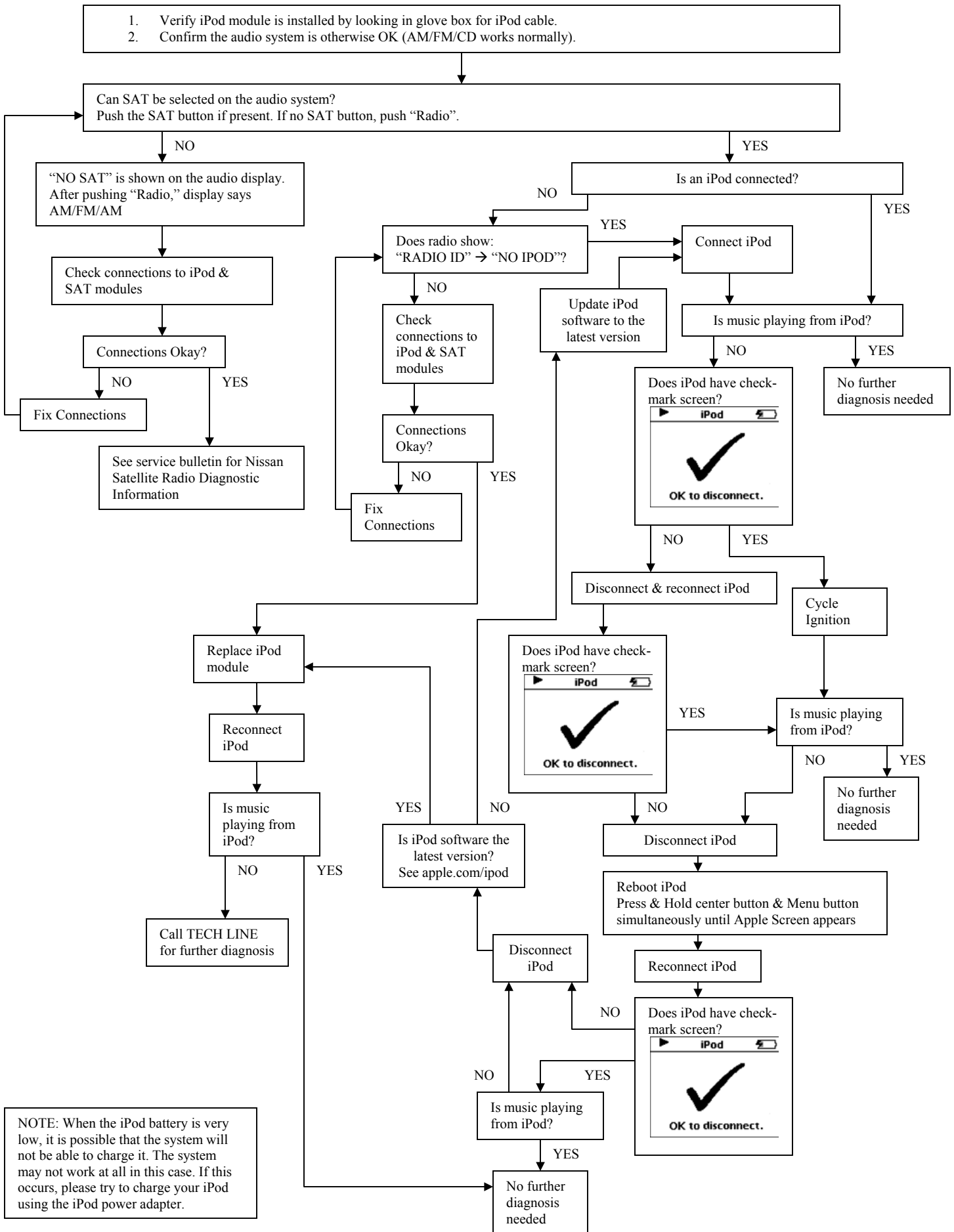

NOTE: When the iPod battery is very low, it is possible that the system will not be able to charge it. The system may not work at all in this case. If this occurs, please try to charge your iPod using the iPod power adapter.