







DIGITAL PIANO DP-900

Owner's Manual

Thank you, and congratulations on your choice of the Roland Digital Piano DP-900.



Before using this unit, carefully read the sections entitled: "USING THE UNIT SAFELY" and "IMPORTANT NOTES" (p. 2; p. 4). These sections provide important information concerning the proper operation of the unit. Additionally, in order to feel assured that you have gained a good grasp of every feature provided by your new unit, Owner's manual should be read in its entirety. The manual should be saved and kept on hand as a convenient reference.

Assembling the DP-900		p. 6
Before You Start Playing		p. 11
Enjoying the Internal Songs		p. 15
Playing the Keyboard		p. 16
Contents		p. 10
Index		p. 46







USING THE UNIT SAFELY

INSTRUCTIONS FOR THE PREVENTION OF FIRE, ELECTRIC SHOCK, OR INJURY TO PERSONS

About  WARNING and  CAUTION Notices







 WARNING	Used for instructions intended to alert the user to the risk of death or severe injury should the unit be used improperly.
 CAUTION	Used for instructions intended to alert the user to the risk of injury or material damage should the unit be used improperly. * Material damage refers to damage or other adverse effects caused with respect to the home and all its furnishings, as well to domestic animals or pets.

About the Symbols







	The  symbol alerts the user to important instructions or warnings. The specific meaning of the symbol is determined by the design contained within the triangle. In the case of the symbol at left, it is used for general cautions, warnings, or alerts to danger.
	The  symbol alerts the user to items that must never be carried out (are forbidden). The specific thing that must not be done is indicated by the design contained within the circle. In the case of the symbol at left, it means that the unit must never be disassembled.
	The  symbol alerts the user to things that must be carried out. The specific thing that must be done is indicated by the design contained within the circle. In the case of the symbol at left, it means that the power-cord plug must be unplugged from the outlet.

ALWAYS OBSERVE THE FOLLOWING

WARNING

- Before using this unit, make sure to read the instructions below, and the Owner's Manual. 
- Do not open (or modify in any way) the unit or its AC adaptor. 
- Do not attempt to repair the unit, or replace parts within it (except when this manual provides specific instructions directing you to do so). Refer all servicing to your retailer, the nearest Roland Service Center, or an authorized Roland distributor, as listed on the "Information" page. 
- Never use or store the unit in places that are:
 - Subject to temperature extremes (e.g., direct sunlight in an enclosed vehicle, near a heating duct, on top of heat-generating equipment); or are 
 - Damp (e.g., baths, washrooms, on wet floors); or are 
 - Humid; or are
 - Exposed to rain; or are
 - Dusty; or are
 - Subject to high levels of vibration.
- Make sure you always have the unit placed so it is level and sure to remain stable. Never place it on stands that could wobble, or on inclined surfaces. 

WARNING

- Be sure to use only the AC adaptor supplied with the unit. Also, make sure the line voltage at the installation matches the input voltage specified on the AC adaptor's body. Other AC adaptors may use a different polarity, or be designed for a different voltage, so their use could result in damage, malfunction, or electric shock. 
- Use only the attached power-supply cord. Also, the supplied power cord must not be used with any other device. 
- Do not excessively twist or bend the power cord, nor place heavy objects on it. Doing so can damage the cord, producing severed elements and short circuits. Damaged cords are fire and shock hazards! 
- This unit, either alone or in combination with an amplifier and headphones or speakers, may be capable of producing sound levels that could cause permanent hearing loss. Do not operate for a long period of time at a high volume level, or at a level that is uncomfortable. If you experience any hearing loss or ringing in the ears, you should immediately stop using the unit, and consult an audiologist. 
- Do not allow any objects (e.g., flammable material, coins, pins); or liquids of any kind (water, soft drinks, etc.) to penetrate the unit. 

⚠ WARNING

- Immediately turn the power off, remove the AC adaptor from the outlet, and request servicing by your retailer, the nearest Roland Service Center, or an authorized Roland distributor, as listed on the “Information” page when:
 - The AC adaptor, the power-supply cord, or the plug has been damaged; or
 - If smoke or unusual odor occurs
 - Objects have fallen into, or liquid has been spilled onto the unit; or
 - The unit has been exposed to rain (or otherwise has become wet); or
 - The unit does not appear to operate normally or exhibits a marked change in performance.

- In households with small children, an adult should provide supervision until the child is capable of following all the rules essential for the safe operation of the unit.

- Protect the unit from strong impact. (Do not drop it!)

- Do not force the unit’s power-supply cord to share an outlet with an unreasonable number of other devices. Be especially careful when using extension cords—the total power used by all devices you have connected to the extension cord’s outlet must never exceed the power rating (watts/ampères) for the extension cord. Excessive loads can cause the insulation on the cord to heat up and eventually melt through.

- Before using the unit in a foreign country, consult with your retailer, the nearest Roland Service Center, or an authorized Roland distributor, as listed on the “Information” page.

⚠ CAUTION

- The unit and the AC adaptor should be located so their location or position does not interfere with their proper ventilation.

- At regular intervals, you should unplug the AC adaptor and clean it by using a dry cloth to wipe all dust and other accumulations away from its prongs. Also, disconnect the power plug from the power outlet whenever the unit is to remain unused for an extended period of time. Any accumulation of dust between the power plug and the power outlet can result in poor insulation and lead to fire.

⚠ CAUTION

- Always grasp only the plug on the AC adaptor cord when plugging into, or unplugging from, an outlet or this unit.

- Try to prevent cords and cables from becoming entangled. Also, all cords and cables should be placed so they are out of the reach of children.

- Never climb on top of, nor place heavy objects on the unit.

- Never handle the AC adaptor or its plugs with wet hands when plugging into, or unplugging from, an outlet or this unit.

- If you need to move the instrument, take note of the precautions listed below. At least two persons are required to safely lift and move the unit. It should be handled carefully, all the while keeping it level. Make sure to have a firm grip, to protect yourself from injury and the instrument from damage.
 - Check to make sure the attachment screws and stabilizer screw securing the unit to the stand have not become loose. Fasten them again securely whenever you notice any loosening.
 - Disconnect the power cord.
 - Disconnect all cords coming from external devices.
 - Close the lid.

- Before cleaning the unit, turn off the power and unplug the AC adaptor from the outlet (p. 11).

- Whenever you suspect the possibility of lightning in your area, disconnect the AC adaptor from the outlet.

- Be careful when opening/closing the lid so you do not get your fingers pinched (p. 13). Adult supervision is recommended whenever small children use the unit.

- Keep any attachment screw, stabilizer screws, and cord clamp you may remove and the included attachment screw, stabilizer screws, and cord clamp in a safe place out of children’s reach, so there is no chance of them being swallowed accidentally.

- The rear panel may become hot, so take care to avoid burns.

IMPORTANT NOTES

In addition to the items listed under “USING THE UNIT SAFELY” on page 2, please read and observe the following:

Power Supply

- Do not connect this unit to same electrical outlet that is being used by an electrical appliance that is controlled by an inverter (such as a refrigerator, washing machine, microwave oven, or air conditioner), or that contains a motor. Depending on the way in which the electrical appliance is used, power supply noise may cause this unit to malfunction or may produce audible noise. If it is not practical to use a separate electrical outlet, connect a power supply noise filter between this unit and the electrical outlet.
- The AC adaptor will begin to generate heat after long hours of consecutive use. This is normal, and is not a cause for concern.
- Before connecting this unit to other devices, turn off the power to all units. This will help prevent malfunctions and/or damage to speakers or other devices.

Placement

- Using the unit near power amplifiers (or other equipment containing large power transformers) may induce hum. To alleviate the problem, change the orientation of this unit; or move it farther away from the source of interference.
- This device may interfere with radio and television reception. Do not use this device in the vicinity of such receivers.
- Noise may be produced if wireless communications devices, such as cell phones, are operated in the vicinity of this unit. Such noise could occur when receiving or initiating a call, or while conversing. Should you experience such problems, you should relocate such wireless devices so they are at a greater distance from this unit, or switch them off.
- Do not expose the unit to direct sunlight, place it near devices that radiate heat, leave it inside an enclosed vehicle, or otherwise subject it to temperature extremes. Also, do not allow lighting devices that normally are used while their light source is very close to the unit (such as a piano light), or powerful spotlights to shine upon the same area of the unit for extended periods of time. Excessive heat can deform or discolor the unit.
- When moved from one location to another where the temperature and/or humidity is very different, water droplets (condensation) may form inside the unit. Damage or malfunction may result if you attempt to use the unit in this condition. Therefore, before using the unit, you must allow it to stand for several hours, until the condensation has completely evaporated.
- Do not allow rubber, vinyl, or similar materials to remain on the unit for long periods of time. Such objects can discolor or otherwise harmfully affect the finish.
- Do not allow objects to remain on top of the keyboard or pedal board. This can be the cause of malfunction, such as keys ceasing to produce sound.
- Do not paste stickers, decals, or the like to this instrument. Peeling such matter off the instrument may damage the exterior finish.

Maintenance

- To clean the unit, use a dry, soft cloth; or one that is slightly dampened. Try to wipe the entire surface using an equal amount of strength, moving the cloth along with the grain of the wood. Rubbing too hard in the same area can damage the finish.
- Never use benzine, thinners, alcohol or solvents of any kind, to avoid the possibility of discoloration and/or deformation.

Additional Precautions

- Unfortunately, it may be impossible to restore the contents of data that was stored in the unit’s memory once it has been lost. Roland Corporation assumes no liability concerning such loss of data.
- Use a reasonable amount of care when using the unit’s buttons, sliders, or other controls; and when using its jacks and connectors. Rough handling can lead to malfunctions.
- Never strike or apply strong pressure to the display.
- A small amount of noise may be heard from the display during normal operation.
- When connecting / disconnecting all cables, grasp the connector itself—never pull on the cable. This way you will avoid causing shorts, or damage to the cable’s internal elements.
- To avoid disturbing your neighbors, try to keep the unit’s volume at reasonable levels. You may prefer to use headphones, so you do not need to be concerned about those around you (especially when it is late at night).
- When you need to transport the unit, package it in the box (including padding) that it came in, if possible. Otherwise, you will need to use equivalent packaging materials.
- Do not apply undue force to the music rest while it is in use.
- Use a cable from Roland to make the connection. If using some other make of connection cable, please note the following precautions.
 - Some connection cables contain resistors. Do not use cables that incorporate resistors for connecting to this unit. The use of such cables can cause the sound level to be extremely low, or impossible to hear. For information on cable specifications, contact the manufacturer of the cable.
- Before opening or closing the keyboard lid, always make sure that no pets or other small animals are located on top of the instrument (in particular, they should be kept away from the keyboard and its lid). Otherwise, due to the structural design of this instrument, small pets or other animals could end up getting trapped inside it. If such a situation is encountered, you must immediately switch off the power and disconnect the power cord from the outlet. You should then consult with the retailer from whom the instrument was purchased, or contact the nearest Roland Service Center.

Introduction

Congratulations on your choice of the Roland Digital Piano DP-900.

In order to enjoy reliable performance of your new keyboard for many years to come, please take the time to read through this manual in its entirety.

Main Features

Refined Wood Grain, Compact Design

The simple design and light wood grain finish is at home both in the living room as well as in the children's room. When its lid (which descends slowly and smoothly) is closed, the instrument presents a clean, flat look.

And at a compact about 300 millimeters deep, it fits in perfectly with other furniture.

Authentic Piano Performances

High-quality concert grand piano tones, along with the keyboard which gives more realistic piano touch by providing a heavier feel in the low end and a lighter feel in the upper notes, let you enjoy truly authentic piano performances.

The two pedals are securely attached to the piano, ensuring that they will be stable when operated.

Practice Functions to Foster Great Musicianship

In addition to a metronome, the instrument also features a "Two-Track Recorder," which lets you record and check what you practice, along with a variety of other piano lesson features that are possible only with an electronic piano.

Tones For Use in a Wide Variety of Musical Genres

The DP-900 offers twenty different onboard tones, including piano, which can be used for almost every conceivable style of music.

65 Piano Songs Built-In

The 65 internal songs are mainly classical pieces, and include compositions for listening enjoyment as well as for lessons.

Keyboard Touch Can Be Set to Match Finger Strength

You can change the keyboard touch so it better suits the finger strength of the person playing the keyboard.

High-Performance Two-Box Speaker Construction

The lateral speaker box features two independent left and right speaker boxes, providing unexpectedly superior volume and sonic quality.

The speakers can also be directed rearward if conditions require.

Checking the Included Items

Check to see if you have all of the items that normally are supplied with the DP-900.

If any items are missing, please contact the dealer where you purchased this unit.

DP-900 (For installing the DP-900, refer to p. 6)

Side Board right

Side Board left

Speaker Box

Pedal Board

Stabilizer x 2

Stabilizer screw x 6

Attachment screw x 10

Cord Clamp x 3

AC Adaptor (DC 9V), Power Cord

Owner's manual (this document)

Assembling the DP-900



Make sure that another person is on hand to help with the assembly and setup.

To move the piano, lift it carefully-all the while keeping it level. Be very careful, when you assemble and move the piano, to make sure that you do not drop it on your hands or feet.

Should you remove screws, cord clamps, or stabilizer, make sure to put them in a safe place out of children's reach, so there is no chance of them being swallowed accidentally.

Check the Parts

Before you begin assembling the DP-900, check that all the parts were supplied.

You will also need to have a Phillips screwdriver.

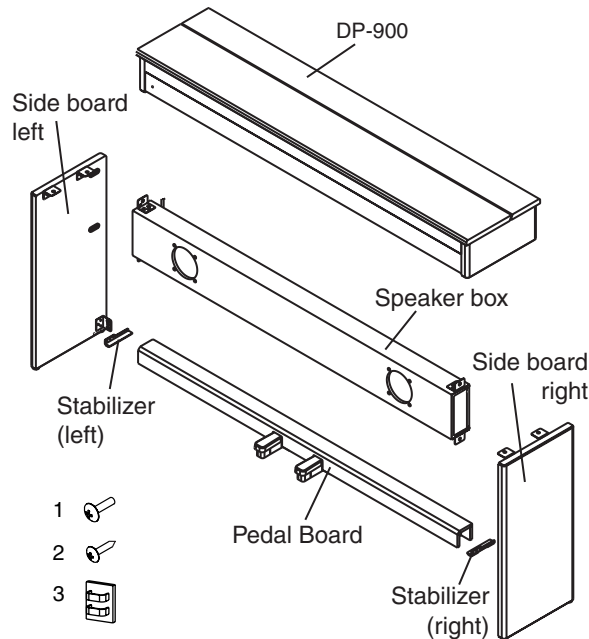

- 1: Attachment screw (M6 x 20mm) x10
- 2: Stabilizer screw (M4 x 16mm) x6
- 3: Cord clamp x3

MEMO

The speaker box can also be installed so that it faces toward the rear instead of toward the front. Having the speaker box face out the rear of the instrument allows the speakers to be directed toward listeners when the back of the instrument faces the audience.

Normal direction

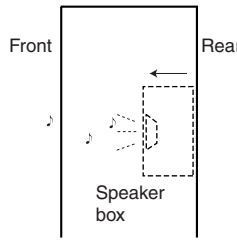

When facing to the rear

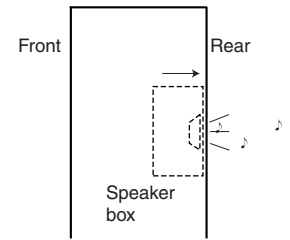

Assembly Procedure

- At first, assemble the entire unit in a temporary fashion, without really tightening the screws. Then, after checking the overall alignment of the boards (and gently shifting certain parts where necessary), go around and tightly fasten each of the screws.
- Be careful when assembling the DP-900, so as to avoid scratching the side boards.

When securing the screws, lay the entire unit sideways with the rear side of the DP-900 at the bottom.

1. Secure the left side board to the speaker box with the screws (in two places).

Attach so that the speaker cable at the rear of the speaker box is directed to the right.

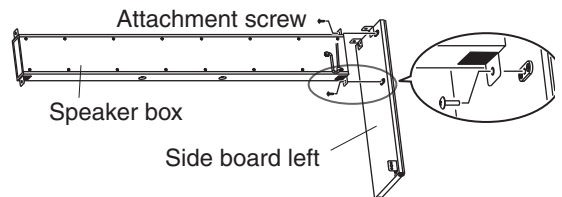

- 2. Secure the right side board to the speaker box with the screws (in two places).**

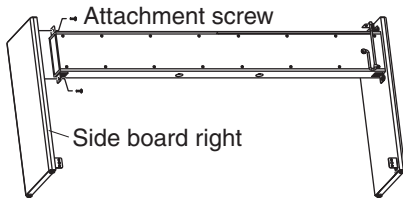

- 3. Set the stabilizer in the holes in the side boards (in six places).**

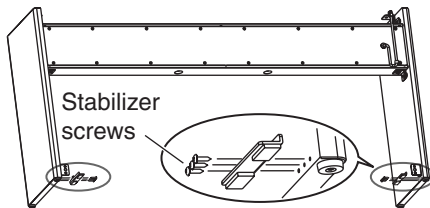

Take care not to attach the left and right stabilizer to the wrong sides.

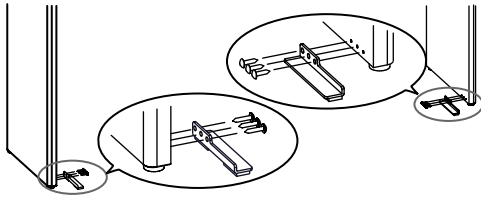

- 4. Raise the entire assembly.**

When standing the assembled unit up, grasp near the speaker box and center part of the DP-900, and gently raise the assembly.

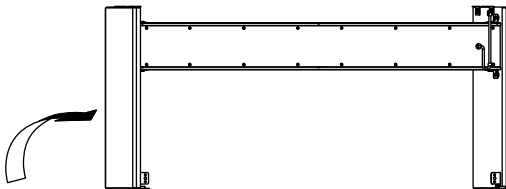

- 5. Put the Pedal Board on the stabilizer.**

When putting the Pedal Board on the stabilizer, first loosen the screws securing the speaker box to the side boards.

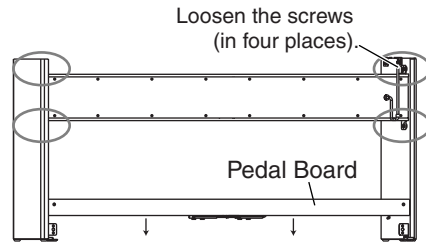

- 6. Secure the Pedal Board to the side boards with the attachment screws (in two places).**

Retighten the screws loosened in Step 5.

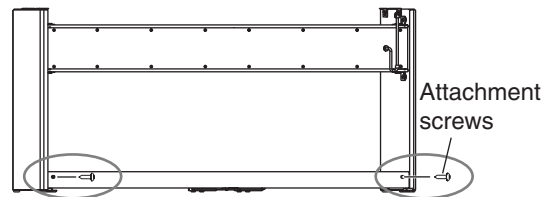

To stabilize the pedals

Temporarily loosen the screws that fasten the pedal board.

Step on the pedal, and after verifying that the pedal is in firm contact with the floor, re-tighten the screws firmly.

Introduction

7. Lay the DP-900's keyboard onto the stand and secure it with the screws (in four places).

Place the keyboard so that it is centered, both front to back and left to right.

- * Take care not to allow your hands to become caught when holding the keyboard.

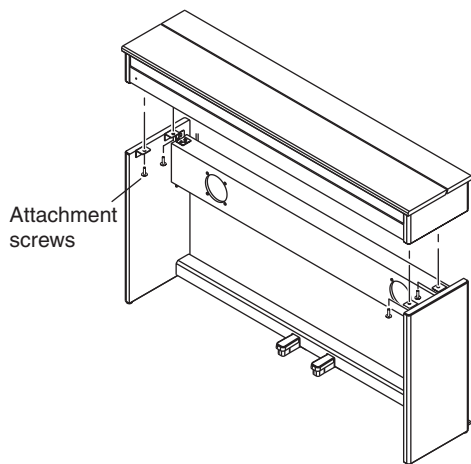

8. Connect the speaker cable extending from the rear of the speaker box to the DP-900's speaker connector.

Press the speaker cable completely into the connector so that it is securely fastened.

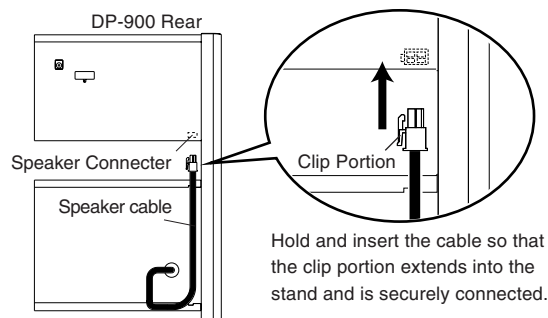

9. Connect the pedal cables to the Pedal [Damper] jack and [Soft] jack.

Connect the brown plug to the Damper jack, and the black plug to the Soft jack.

10. As necessary, affix cord clamps as shown in the diagram to fasten the pedal cable.

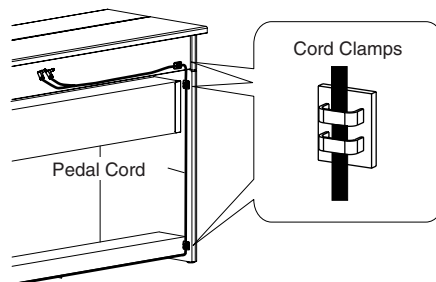

When Moving the Instrument

Disconnect the AC cord and cables from the DP-900.

Then lift the piano while keeping it level, and move it with care, so that you do not drop it on your feet, or get your hands caught.

Check the stability of the pedal, and make adjustments as necessary.

When Disassembling

Disassemble the unit by carrying out assembly Steps 1-10 in reverse order.

When Changing the Orientation of the Speaker Box

Be sure to completely disassemble the unit, change the speaker box orientation, then reassemble it.

Panel Descriptions

Front Panel

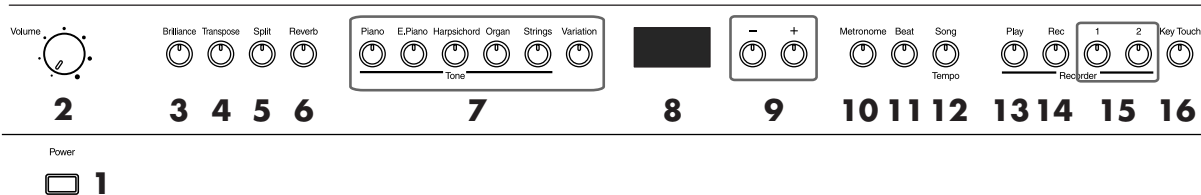

- 1 [Power] switch**
Turns the power on/off (p. 14).
- 2 [Volume] knob**
Adjusts the volume level (p. 14).
- 3 [Brilliance] button**
Adjusts the tone brightness (p. 14).
- 4 [Transpose] button**
Transposes the pitch of the keyboard (p. 22).
- 5 [Split] button**
Divides the keyboard into right-hand and left-hand areas, allowing you to play a different sound in each area (p. 18).
- 6 [Reverb] button**
Adds reverberation to the sound (p. 21).
- 7 Tone buttons**
They are used to choose the kinds of tones (tone groups) played by the keyboard (p. 16).
- 8 Display**
Displays information such as the song number, tempo, beat, and parameter settings values.
- 9 [+] [-] buttons**
Allows you to select the value of various settings. Pressing both the [+] and [-] buttons simultaneously returns the setting of a particular item or function to its original value.

- 10 [Metronome] button**
Activates the built-in metronome (p. 19).
By holding down this button and the [Beat] button, and pressing other specified button, you can make settings for various functions (p. 31–p. 33, p. 35–p. 36).
- 11 [Beat] button**
Specifies the time signature (beat) (p. 20).
- 12 [Song/Tempo] Button**
Plays back the internal songs (p. 15).
Each time you press this button, the song number and the tempo will be displayed alternately.

Recorder

- 13 [Play] button**
Starts and stops playback of internal songs and recorded performances (p. 15, p. 24).
- 14 [Rec] button**
Puts the DP-900 in recording-standby mode (p. 26–p. 30).
- 15 [1] [2] buttons**
Plays back or records a performance separately for each hand. (p. 25, p. 28–p. 30).
This button and the following [2] button are collectively referred to as the “track buttons.”
- 16 [Key Touch] button**
Modifies the playing feel of the keyboard (p. 23).

Rear Panel

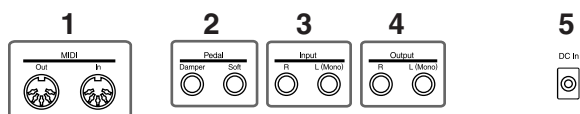

- 1 MIDI connectors**
Connect to external MIDI devices to exchange performance data (p. 34).
- 2 Pedal connectors**
Connect the pedal to this connector (p. 8).

- 3 Input jacks**
These jacks can be connected to another sound generating device or an audio device, so that the sound of that device will be output from the DP-900’s speakers (p. 34).
- 4 4 Output jacks**
Allows you to output the piano’s sound to sound reinforcement equipment to obtain a more powerful sound. These can also be connected to a tape recorder or other recording device to record a performance (p. 34).
- 5 5 DC In connector**
Connect the supplied AC adaptor to this connector (p. 11).

Contents

USING THE UNIT SAFELY	2
IMPORTANT NOTES.....	4
Introduction	5
Main Features.....	5
Checking the Included Items.....	5
Assembling the DP-900	6
Check the Parts	6
Assembly Procedure	6
Panel Descriptions	9
Front Panel	9
Rear Panel.....	9
Before You Start Playing	11
Connect the AC Adaptor.....	11
About the Pedals	12
Pedal Functions	12
Connecting Headphones (Sold Separately).....	12
Opening and Closing the Lid	13
Opening the Lid.....	13
Closing the Lid.....	13
Turning the Power On and Off	14
Turning On the Power.....	14
Turning Off the Power.....	14
Adjusting the Sound's Volume and Brilliance.....	14
Enjoying the Internal Songs.....	15
Listening to Internal Songs	15
Playing Back All Songs Continuously (All Song Play).....	15
Choosing the song to play back	15
Playing the Keyboard.....	16
Performing with a Variety of Sounds.....	16
Playing Two Sounds Together (Dual Play)	17
Adjusting the Volume Balance in Dual Play...17	
Playing Different Tones with the Left and Right Hands (Split Play)	18
Changing the Keyboard's Split Point	18
Using Metronome.....	19
Sounding the Metronome	19
Changing the Metronome Volume	20
Changing the Metronome Sound.....	21
Adding Reverberation to the Sound (Reverb)	21
Changing the Amount of Effect Applied.....	21
Transposing the Key of the Keyboard (Transpose).....	22
Adjusting the Keyboard Touch (Key Touch)	23
Playing Along with the Internal Songs	24
Changing the Tempo.....	24
Adding a Count-in to Match the Timing (Count-In)	24
Playing Each Hand Separately	25
Recording Your Performance.....	26
Notes Regarding Recording	26
Recording a New Song	27
Recording Along with a Song.....	28
Selecting and Recording the Track for Each Hand Separately	29
Erasing Recorded Performances	30
Erasing a Performance from the Specified Track ...	30
Erasing a Song.....	30
Changing Various Settings.....	31
Changing the Damper Pedal's Resonance	31
Making Detailed Settings (Function).....	31
Tuning to Other Instruments' Pitches (Master Tuning)	31
Changing the Temperament	32
Setting the Tuning Curve (Stretch Tuning)	32
Applying the Damper Pedal to the Left-hand Keyboard Area	33
Preventing the Settings from Changing During Performance	33
Tone Lock	33
Disabling Everything Except Piano Play (Panel Lock).....	33
Connecting External Devices	34
Connecting to Audio Equipment	34
Connecting MIDI Devices	34
What's MIDI?	34
Making MIDI-related Settings	35
MIDI Send Channel Settings.....	35
Switching Local Control on and Off	36
Transmitting a Performance You Recorded ...	36
Appendices	37
Troubleshooting	37
Error Messages/Other Messages.....	39
Tone List.....	40
Internal Song List	41
Easy Operation List.....	43
MIDI Implementation Chart.....	44
Main Specifications	45
INDEX.....	46

Before You Start Playing

Connect the AC Adaptor

NOTE

To prevent malfunction and/or damage to speakers or other devices, always turn down the volume, and turn off the power on all devices before making any connections.

1. Connect the supplied AC adaptor and AC cord.

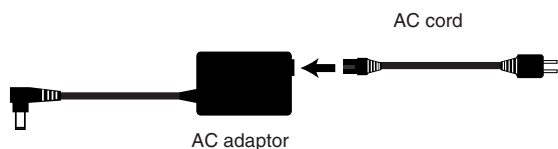

2. Connect the AC adaptor to the DC In connector on the rear panel.

3. As shown in the diagram, loop the AC adaptor cord around the cord hook to fasten it in place.

Rear panel

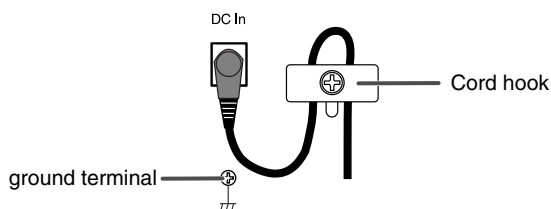

4. Plug the AC cord into a power outlet.

As necessary, clamp the AC adaptor cord with the cord clamps (p. 8).

NOTE

To prevent the inadvertent disruption of power to your unit (should the plug be pulled out accidentally), and to avoid applying undue stress to the AC adaptor jack, anchor the power cord using the cord hook, as shown in the illustration above.

Even if the cord is fastened, strong tension applied to the cord may cause it to be damaged or broken. Be careful not to pull the cord accidentally, or to apply strong pressure to it.

NOTE

Depending on the circumstances of a particular setup, you may experience a discomforting sensation, or perceive that the surface feels gritty to the touch when you touch this device or the metal portions of other objects connected to it. This is due to an infinitesimal electrical charge, which is absolutely harmless. However, if you are concerned about this, connect the ground terminal (see figure) with an external ground. When the unit is grounded, a slight hum may occur, depending on the particulars of your installation. If you are unsure of the connection method, contact the nearest Roland Service Center, or an authorized Roland distributor, as listed on the "Information" page.

Unsuitable places for connection

- Water pipes (may result in shock or electrocution)
- Gas pipes (may result in fire or explosion)
- Telephone-line ground or lightning rod (may be dangerous in the event of lightning)

About the Pedals



For more on connecting the DP-900's pedals, refer to p. 8.

■ Pedal Functions

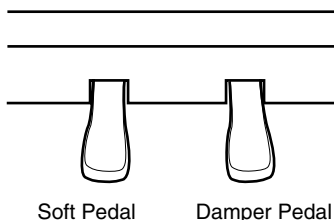

Soft Pedal

This pedal is used to make the sound softer.

Playing with the soft pedal depressed produces a sound that is not as strong as when otherwise played with the equivalent strength.

This is the same function as the left pedal of an acoustic piano. Some tones are affected less than others.

Damper Pedal

Use this pedal to sustain the sound.

While the pedal is depressed, long lingering reverberations continue to be added to the sound after you release from the keys.

This is the same function as the right pedal of an acoustic piano.



Unplugging a pedal cord from the unit while the power is on may cause the pedal's effect to be applied without stopping. The power of the DP-900 must be turned off before inserting or removing a pedal cord.

Connecting Headphones (Sold Separately)

The DP-900 has two jacks for plugging in headphones. This allows two people to listen through headphones simultaneously, making it very useful for lessons and when performing piano pieces for four hands. Additionally, this allows you to play without having to worry about bothering others around you, even at night.

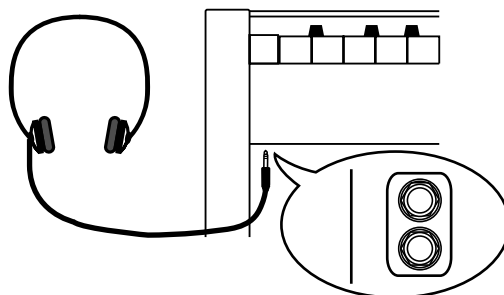

Connect the headphones to either of the headphone jacks.

The headphone volume is adjusted by the [Volume] knob of the DP-900.



Use stereo headphones that have a 1/4" phone plug.

Some notes on using headphones

- To prevent damage to the cord, handle the headphones only by the headset or the plug.
- Connecting the headphones when the volume of connected equipment is turned up may result in damage to the headphones. Lower the volume on the DP-900 before plugging in the headphones.
- Listening at excessively high volume levels will not only damage the headphones, but may also cause hearing loss. Use the headphones at a moderate volume level.

Opening and Closing the Lid

NOTE

Always use two hands to open and close the lid. Although the DP-900's lid is designed to close slowly and gently when it is released, the lid immediately closes if it has been opened only slightly. Take care not to allow your fingers to become pinched by the lid.

■ Opening the Lid

1. Grasp and lift the lid with both hands.

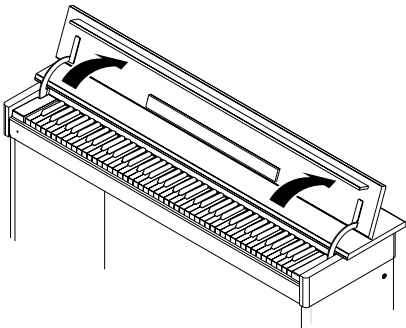

2. Close the blind and open the music rest as shown in the figure.

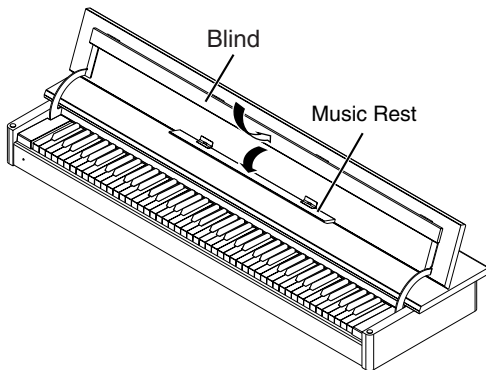

■ Closing the Lid

1. When closing the lid, be sure to close the music rest and open the blind.

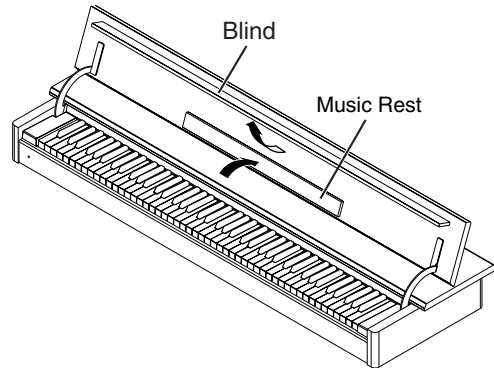

2. Grasp and gently lower the lid with both hands.

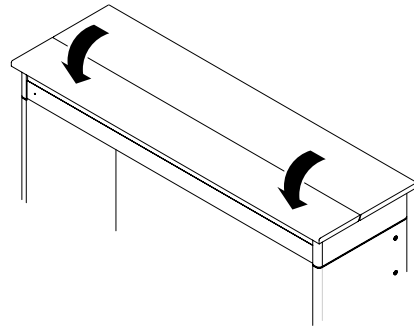

NOTE

Adult supervision is recommended whenever small children use the unit.

NOTE

If you need to move the piano, make sure the lid is closed first to prevent accidents. In addition, do not hold onto the lid when moving or setting up the instrument.

NOTE

When opening and closing the lid, take care not to allow your fingers to become pinched in the gap.

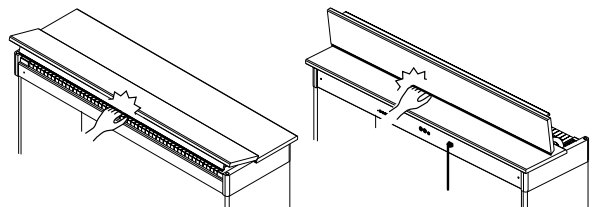

Turning the Power On and Off

Turning On the Power

NOTE

Once the connections have been completed, turn on power to your various devices in the order specified. By turning on devices in the wrong order, you risk causing malfunction and/or damage to speakers and other devices.

1. Turn the [Volume] knob completely to the left to lower the volume to the minimum level.

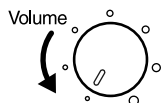

2. Push the [Power] switch to turn on the DP-900.

After a few seconds, the unit becomes operable and playing the keyboard produces sound.

Adjust the volume to obtain the proper volume level.

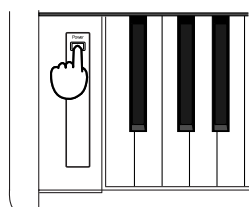

Lower position

ON

NOTE

This unit is equipped with a protection circuit. A brief interval (a few seconds) after power up is required before the unit will operate normally.

Turning Off the Power

1. Turn the [Volume] knob completely to the left to lower the volume to the minimum level.

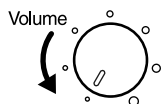

2. Push the [Power] switch to turn off the DP-900.

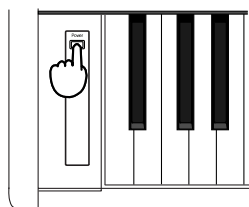

Upper position

OFF

Adjusting the Sound's Volume and Brilliance

Turn the [Volume] knob to adjust the overall volume.

Press the [Brilliance] button to adjust the brightness of the sound.

Select one of the three available settings to obtain the desired brilliance.

[Brilliance] button's indicator	Off	Lit in red	Lit in green
Brilliance	Medium	Mellow	Bright

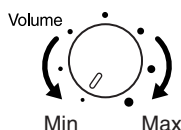

Brilliance



NOTE

Raising the volume excessively may cause the sound to distort. Enjoy the piano at an appropriate volume level.

Enjoying the Internal Songs

Listening to Internal Songs

The DP-900 comes with 65 piano songs onboard.

■ Playing Back All Songs Continuously (All Song Play)

The internal songs can be played back consecutively.



“Playing Along with the Internal Songs” (p. 24)
“Internal Song List” (p. 41)

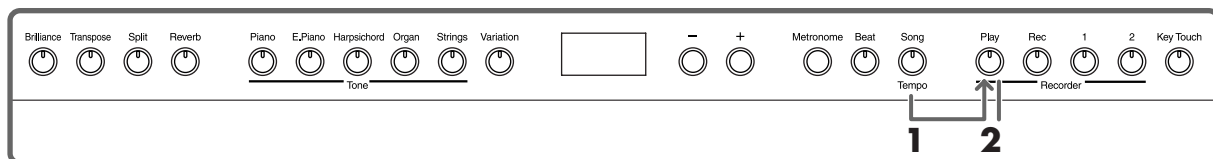

1. Hold down the [Song/Tempo] button, and press the [Play] button.

The [Song/Tempo] button's indicator will light, the [Play] button's indicator will blink, and the songs will play back successively, starting with the currently selected song.

The song number appears in the display.

You can press the [+] or [-] button to select the song that you want to play back.

When all songs have been played, playback will return to the first song and resume.

2. To stop the performance, press the [Play] button once more.



When you play back an internal song, the reverb effect will automatically be turned on (the button's indicator lights).



When an internal song is played back, the metronome sounds the ordinary metronome sound.

■ Choosing the song to play back

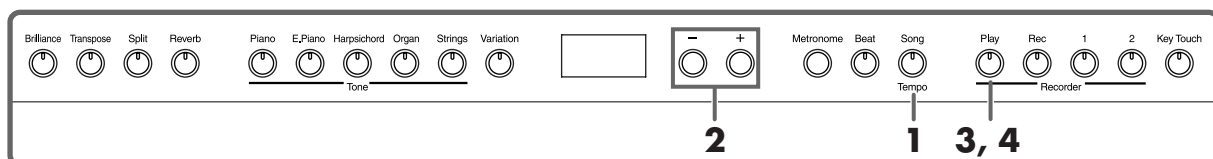

1. Press the [Song/Tempo] button, getting its indicator to light in red.

The song number appears in the display.

2. Press the [+] or [-] button to select a song.

Holding down the button causes the numbers to change continuously.



3. Press the [Play] button.

The button's indicator will light, and the selected song will play.

4. To stop the performance, press the [Play] button once more.

The button's indicator goes out, and playback stops.

he next time you press the [Play] button, the song that was stopped is played from the beginning.



About the display for the internal songs

USr (user)...The location where you can record your performance. (For details on recording → p. 27)

Numbers with a “d.”

...internal songs.

Playing the Keyboard

Performing with a Variety of Sounds

The DP-900 contains 20 different internal tones. The tones are organized into five tone groups, which are assigned to the Tone buttons.

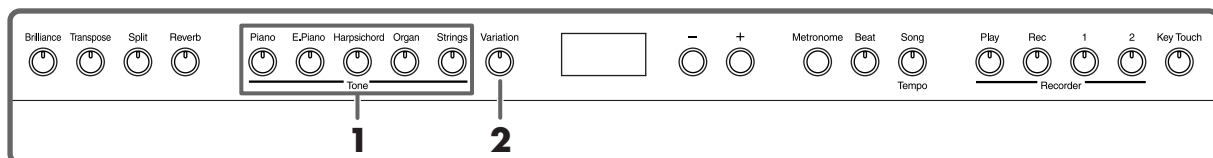

Selecting a tone group

1. Press any Tone button.

The indicator of the button you pressed will light.

When you play the keyboard, you will hear a sound in the selected tone group.

Selecting variation tones

2. Press the [Variation] button.

Four different tones (numbered 1–4) are assigned to each Tone button. Use the [Variation] button to select among them.

Each time you press the [Variation] button, the button's indicator will change color, and the four sounds will be selected successively.

Tone number	1	2	3	4
[Variation] button's indicator	Dark	Red	Green	Orange

Some of the number 3 and 4 tones form pairs, which can be layered and sounded together.

The tone you've selected is heard when you finger the keyboard.



For more details, refer to "Tone List" (p. 40).



When Dual play is used, only sound number 1 or 2 can be selected.

If you use Dual play with a Tone button for which tone number 3 or 4 is selected, tone number 1 will be selected for that Tone button.



The sound can tend to distort easily with certain tones and at certain volume levels.

Playing Two Sounds Together (Dual Play)

Simultaneously playing two tones when one key is pressed is called “Dual play.”

1. Simultaneously press the two Tone buttons that you want to play together.

The indicator of the button you pressed will light.

When you play the keyboard, the tones of the two Tone buttons you selected will sound simultaneously.

To cancel Dual play, press any Tone button.



When Dual play is used, the [Variation] button's indicator will light to indicate the selection of the right button of the two selected tones.



When Dual play is used, only sound number 1 or 2 can be selected. If you use Dual play with a Tone button for which tone number 3 or 4 is selected, tone number 1 will be selected for that Tone button.

To change the tone of the right button of the two selected tones

Press the [Variation] button.

Dual play now features the tone of the left side's tone button along with the newly selected tone.

To change the tone of the left button of the two selected tones

Cancel the Dual play, and then re-select the tone.

■ Adjusting the Volume Balance in Dual Play

You can change the volume balance between the two layered sounds in Dual play.

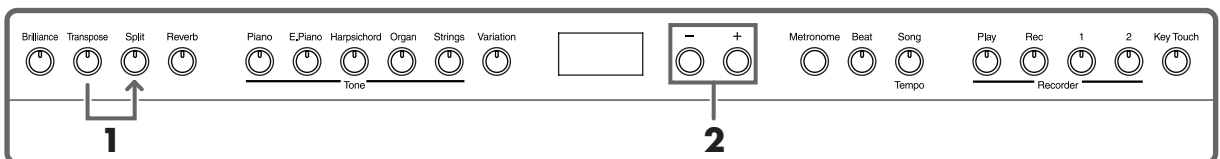

1. Hold down the [Transpose] button and press the [Split] button.

The indicators of the buttons you pressed will blink.

The current volume balance appears in the display.

2. Press the [+] or [-] button to change the value.

The volume balance changes.

To return to the original volume balance, press the [+] and [-] buttons simultaneously.



When the power is turned on, this will be set to “8-2” (volume of the left button tone - volume of the right button tone).



Volume of the left button tone Volume of the right button tone

Press the [Transpose] or [Split] button, and the button's indicator will return to the previous state.

Playing Different Tones with the Left and Right Hands (Split Play)

Dividing the keyboard into right-hand and left-hand areas, then playing different sounds in each is called “Split play.” The boundary key is called the “split point.”

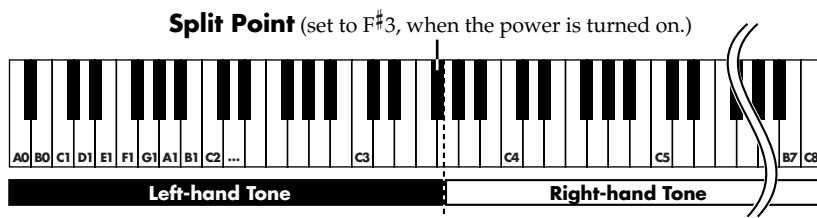

MEMO

The split point key is included in the left-hand keyboard area.

MEMO

If you use Split play with a Tone button for which tone numbers 3 or 4 selected, tone number 1 will be selected for that Tone button.

When Split play is used, only tone numbers 1 or 2 can be selected.

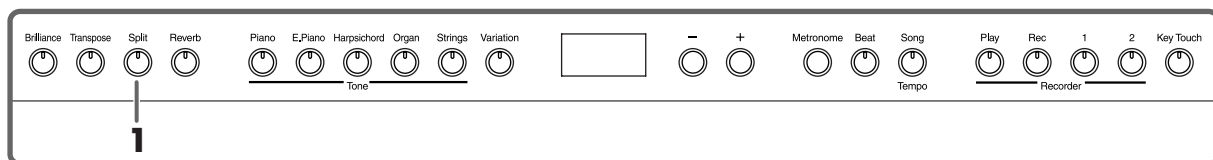

1. Press the [Split] button.

The button’s indicator will light.

The keyboard is divided into right-hand and left-hand areas.

The tone you were playing before you pressed the [Split] button will be selected for the right-hand area.

To cancel Split play, press the [Split] button, getting its indicator to go dark.

MEMO

When using Dual play, press the [Split] button

The right hand will play the tone of the left button of Dual play, and the left hand will play a suitable match for the right-hand tone.

MEMO

For information about the tones that can be selected for the left hand section, refer to the “Tone List” (p. 40).

MEMO

The selected left hand tone is remembered for each Tone button. When you turn off the power, it will return to the original setting.

MEMO

In Split play, the damper pedal will be applied only to the right-hand area of the keyboard. If you want the damper pedal to be applied to the left-hand area, refer to “Applying the Damper Pedal to the Left-hand Keyboard Area” (p. 33)

Changing tone played by the left hand

Press the [Variation] button.

Each time you press the [Variation] button, the button’s indicator will change color, and the left-hand tone will change.

Some tones assign the tone that had been selected before you pressed the [Split] button to the left hand area of the keyboard.

Changing tone played by the right hand

Press the Tone button.

The tone of the right-hand area will change. A tone that is a suitable match for the right-hand tone will be selected for the left-hand area.

If you want to change the variation for the right-hand tone, cancel Split play and then re-select the tone.

■ Changing the Keyboard's Split Point

You can change the location where the keyboard is divided (the split point) within the range of B1 through B6.

The setting is at "F#3" when the piano is powered up.

- 1. While continuing to hold the [Split] button, press the key that you want to specify as the split point.**

The key you pressed becomes the split point, and belongs to the left-hand section of the keyboard.

You can also change the setting by pressing the [+] or [-] button while continuing to hold down the [Split] button.

If you hold down the [Split] button and simultaneously press the [+] and [-] buttons, the setting will return to its original value (F#3).



Using Metronome

■ Sounding the Metronome

The DP-900 features a built-in metronome.

While a song plays back, the metronome will sound at the tempo and time signature (Beat) of that song.

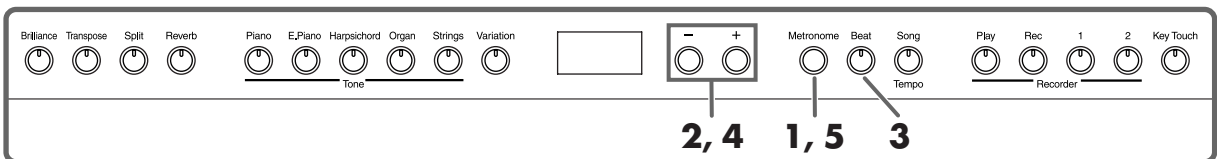

Sounding the metronome

- 1. Press the [Metronome] button.**

The metronome will sound.

The button flashes in red and green in time with the beat selected at that time.

The indicator lights in red on the downbeats, and in green on weak beats.

Changing the tempo

- 2. Press the [+] or [-] button to adjust the tempo.**

MEMO

The split point key is displayed as follows.

Display	C	d _♭	d	E _♭
Letter name	C	D _♭	D	E _♭
Display	E	F	F _♯	G
Letter name	E	F	F _♯	G
Display	A _♭	A	B _♭	B
Letter name	A _♭	A	B _♭	B

MEMO

When you continue holding the [Split] button, the currently specified split point will be displayed.

Changing the beat of metronome

3. Press the [Beat] button.

The currently selected beat will be displayed.

4. Press the [+] or [-] button.

If you press the [+] or [-] button, the beat will change.

If you press the [+] and [-] buttons simultaneously, the beat will go back to what it was before you changed it.



Display	beat	Display	beat
2.2	2/2	6.4	6/4
0.4	Only weak beats	7.4	7/4
2.4	2/4	3.8	3/8
3.4	3/4	6.8	6/8
4.4	4/4	9.8	9/8
5.4	5/4	12.8	12/8

Stopping the metronome

5. Once again press the [Metronome] button, getting its indicator to go dark.

The metronome will stop.

■ Changing the Metronome Volume

The volume of the metronome can be adjusted, with eight volume levels available.

1. Hold down the [Metronome] button and press the [+] or [-] button.

The currently specified volume will be displayed.

Continue to hold down the [Metronome] button, and press the [+] or [-] button to sound the metronome, and change the volume.



It is not possible to change the beat during song playback or recording.



Correspondence between beat and tempo display

Beat	Tempo Value
2/2	♩ = 10-125
x/4	♩ = 20-250
x /8	♩ = 40-500



This is set to "4" when the instrument is turned on.



When you hold down the [Metronome] button, the currently specified metronome volume will be displayed.

■ Changing the Metronome Sound

1. Hold down the [Beat] button and press the [+] or [-] button.

The currently specified sound number will be displayed.

Continue to hold down the [Beat] button, and press the [+] or [-] button to sound the metronome, and change the metronome sound.



Display	beat
t. 1	Ordinary metronome sound
t. 2	Dog and cat cries
t. 3	A voice counting "1, 2, 3" in English
t. 4	A voice counting "1, 2, 3" in Japanese

Adding Reverberation to the Sound (Reverb)

By applying the reverb effect you can produce a pleasant reverberation, making it sound as though you were performing in a concert hall.

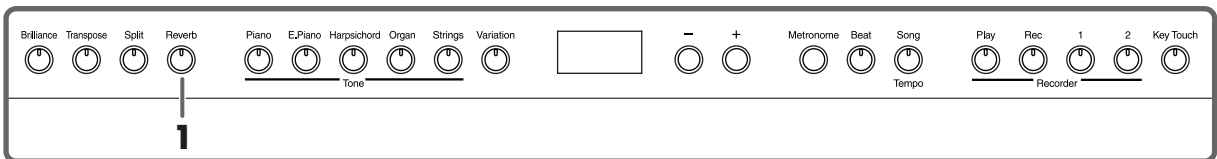

1. Press the [Reverb] button.

The button's indicator will light, and a reverb effect will be applied to the sound.

To cancel the reverb effect, press the [Reverb] button, getting its indicator to go dark.

■ Changing the Amount of Effect Applied

The depth of the reverb effect can be adjusted over eight steps.

When the power is turned on, reverb is set to "4."

1. Hold down the [Reverb] button and press the [+] or [-] button.

The currently specified value will be displayed.

Higher values will produce a deeper effect.

MEMO

This is set to "t. 1" when the instrument is turned on.

MEMO

When you hold down the [Beat] button, the currently specified sound number will be displayed.

MEMO

When an internal song is played back, the metronome sounds the ordinary metronome sound. When a recorded performance is played back, the metronome sounds the sound that was selected when the recording was made.

MEMO

The reverb effect setting for each tone is not remembered.

MEMO

When you play back an internal song, the reverb effect will automatically be turned on (the button's indicator lights).

MEMO

When you hold down the [Reverb] button, the currently specified reverb depth value will be displayed.

Transposing the Key of the Keyboard (Transpose)

By using the “Transpose function,” you can transpose your performance without changing the notes you play. For example, even if the song is in a difficult key with numerous sharps (♯) or flats (♭), you can transpose it to a key that is easier for you to play.

When accompanying a vocalist, you can easily transpose the pitch to a range that is comfortable for the singer, while still playing the notes as written (i.e., with the same fingering positions).

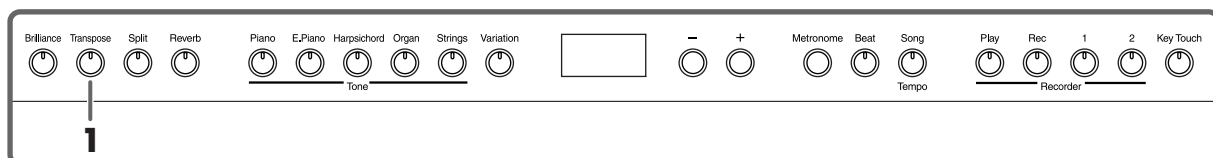

1. Continue to hold down the [Transpose] button, and press a note to indicate the tonic of the key to which you want to transpose.

The button’s indicator will light, and the keyboard will be transposed.

You can also transpose by holding down the [Transpose] button and pressing the [+] or [-] button.

If you hold down the [Transpose] button and press the [+] and [-] buttons simultaneously, the setting will return to the original value (0).

This can be set in a range of -6–0–5 (semitone steps).

For example, if you want the E pitch to sound when you play the C key, hold down the [Transpose] button and press the E key.

Counting from C as a reference point, one moves up four keys, including the black keys, to reach E, thus “4” appears in the display.

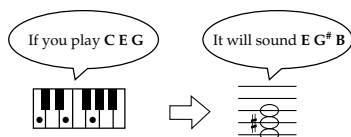

When the transpose value is set to “0,” the button’s indicator will remain dark even if you press the [Transpose] button.

To cancel the transpose function, press the [Transpose] button, extinguishing its indicator.

When you press the [Transpose] button once again, getting its indicator to light, the keyboard will be transposed to the note you specified here.

MEMO

When you hold down the [Transpose] button, the currently specified value will be displayed.

MEMO

This setting returns to the original value (0) when you turn off the power.

Adjusting the Keyboard Touch (Key Touch)

You can adjust the touch (playing feel) of the keyboard.

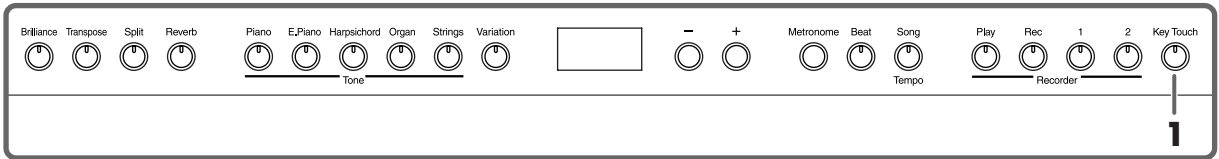

1. Press the [Key Touch] button.

The button's indicator will light, and the feel of the keyboard will change. Each time you press the [Key Touch] button, the button's indicator will change color, and the feel of the keyboard will change.

Indicator	Settings	
OFF	Medium	This allows you to play using the most natural touch. This is the closest to the touch of an acoustic piano.
Red	Heavy	Fortissimo (ff) cannot be produced unless you play more strongly than usual, making the keyboard feel heavier. Dynamic fingering adds even more feeling to what you play.
Green	Light	Fortissimo (ff) can be produced by playing less strongly than usual, making the keyboard feel lighter. This setting makes it easy to play, even for children.
Orange	Fixed	Sounds at a fixed volume, regardless of your keyboard playing strength.

Playing Along with the Internal Songs

Here's how you can play along with the internal songs.

You can slow down the playback tempo of the song, or play back each hand separately.

Before you try playing the song, listen to it several times to get a general feel for the song.

For details on operation, refer to "Choosing the song to play back" (p. 15).



If you turn on the metronome while the song plays back, the metronome will sound at the beat and tempo of the song.

Changing the Tempo

If the song has a rapid tempo, you can slow down the tempo so that you can practice it more easily. It is effective to gradually raise the tempo as you practice.

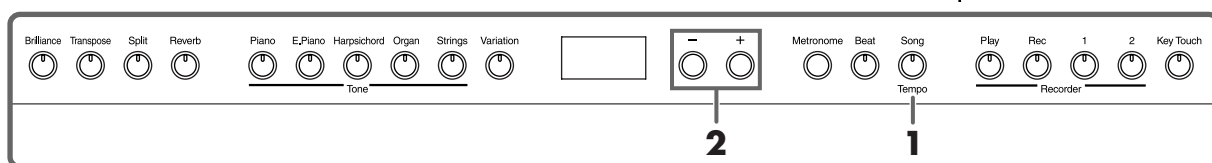

1. Press the [Song/Tempo] button, getting its indicator to light in green.

The tempo appears in the display.

Each time you press the [Song/Tempo] button, the tempo and the currently selected song number (prefixed by "d.") will be displayed alternately.

While the tempo is displayed, the [Song/Tempo] button indicator will light in green.

While the song number is displayed, it will light in red.

2. Press the [+] or [-] button to adjust the tempo.

The tempo can be adjusted in a range of ♩=20–250.

You can also change the tempo during playback.

Pressing the [+] button once increases the tempo by one unit. Holding down the button increases the tempo continuously.

Pressing the [-] button once decreases the tempo by one unit. Holding down the button makes the tempo change (slow down) continuously.

If you press the [+] and [-] buttons simultaneously, you will return to the basic tempo of the song (the tempo before you modified it).



Indication of the tempo during song playback

While the song is playing, the initial tempo of the song will continue to be displayed, regardless of tempo changes during the song.



About the display for the internal songs

USr (user) ... The location where you can record your performance. (For details on recording → p. 27)

Numbers with a "d." ... internal songs.



During the count-in, the count measure is indicated in the display as "-2" then "-1."



"Sounding the metronome" (p. 19)

■ Adding a Count-in to Match the Timing (Count-In)

When you're playing along with a song, you can make sure that your playing is in time with the song by sounding a count before the song starts playing. Sounding a "count sound" leading up to playback of a song is called "Count-In."

On the DP-900, if you playback a song while the metronome is sounding, two measures of lead-in count will be heard at the beginning of the song.

Playing Each Hand Separately

The internal songs allow you to select the performance part that will be played back.

The left-hand performance of the internal songs is assigned to the [1] button, while the right-hand performance is assigned to the [2] button. The place where each part of the performance is held is called a “track,” and the [1] and [2] buttons are called “track buttons.”

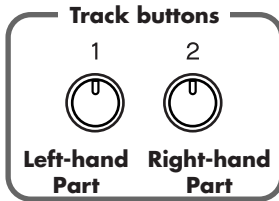

Here’s how to practice each hand separately along with the song.

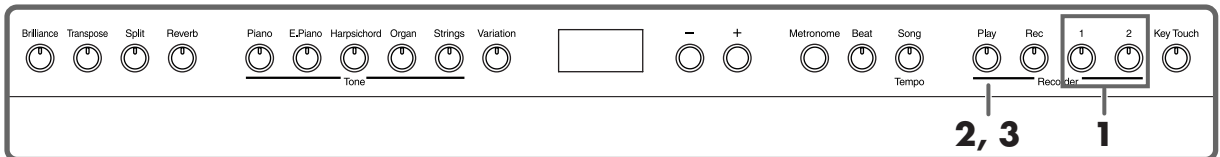

First select the song that you want to play back (p. 15).

Selecting the part that you yourself will play

1. Press the [1] or [2] button.

The indicator of the button you’ve pressed goes out, and the sound of the selected part will no longer be heard.

For example, if you want to practice the right hand, press button [2] and get its indicator to go dark.

When you play back the song, the right-hand performance will not sound.

Practice your right-hand performance along with the left-hand playback.

Playing back a song

2. Press the [Play] button.

The song will begin playing back.

The part you selected in step 1 will not sound.

Once again press the button you selected in step 1. The button’s indicator will light, and the sound will be heard once again.

Even while the song is playing, you can press the track buttons to mute or unmute the sound.

Stopping the song

3. Press the [Play] button.

The song will stop.

Recording Your Performance

You can easily record your performances.

A recorded performance can be played back to hear your own playing, or to add additional parts.

The following types of recording can be done using the DP-900.

- Recording just your own keyboard performance (→ “Recording a New Song” (p. 27))
- Recording along with an internal song (→ “Recording Along with a Song” (p. 28))
- Recording each hand separately (→ “Selecting and Recording the Track for Each Hand Separately” (p. 29))

■ Notes Regarding Recording

- Only one song can be recorded.
- Recorded performances are erased when the power is turned off. If you want to keep your performance, you can either record it on an external audio device, or use an external MIDI device to save the performance data on a floppy disk. For details, refer to “Connecting External Devices” (p. 34).

If you see the following...

If you attempt to record using a different internal song when a performance has already been recorded, the following will appear, and the [Rec] button's indicator will blink.



If it is OK to erase the performance, press the [Rec] button.

If you do not want to erase the performance, press the [Play] button.

Recording a New Song

Record only the keyboard performance without playing along with an internal song.

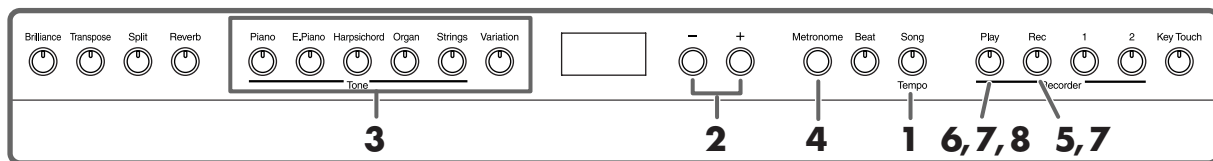

Recording settings (select “USr”)

1. Press the [Song/Tempo] button, getting its indicator to light in red.
The song number appears in the display.
2. Press [+] and [-] buttons simultaneously, and “USr” appears in the display.

Specifying the tone and tempo for recording

3. Select the tone that you want to play (p. 16).
4. If necessary, turn on the metronome.
Sound the metronome while you set the tempo and beat of the song (p. 19).

5. Press the [Rec] button.

The [Rec] button’s indicator will light, the [Play] button’s indicator will blink, and you will be in recording-standby mode.

Start recording

6. Recording will start when you either press the [Play] button or play the keyboard.

The DP-900 counts down two measures, then recording starts. Note that recording will also begin as soon as you play anything on the keyboard, even if you do not press the [Play] button. There is no count sound played when you start in this manner.

When recording begins, the [Play] button and [Rec] button indicators will light.

Go ahead and perform on the keyboard.

Stop recording

7. Press the [Play] or [Rec] button.

The indicators for the [Play] and [Rec] buttons will go dark.

NOTE

If you layer a newly recorded performance without erasing the recorded song, the song tempo and beat will be stored with the settings that were recorded first.

MEMO

About the “USr” display
When you stop recording,

the “USr” display will change to “USr.”. The “.” in the lower right of the display indicates that there is already a recorded performance.

MEMO

If you record without specifying the recording track, the performance will be recorded to the [1] button. If you want to record the right and left hands separately on separate recording tracks, refer to “Selecting and Recording the Track for Each Hand Separately” (p. 29).

Play back the recorded performance

8. Press the [Play] button.

You will hear the recorded performance.

Once again press the [Play] button, and playback will stop.



When a recorded performance is played back, the metronome sounds the sound that was selected when the recording was made.

Recording Along with a Song

You can record a performance that you play along with an internal song. Using the [1] or [2] buttons, you can (for example) perform and record just the righthand part of a song while listening to the left-hand playback of an internal song.

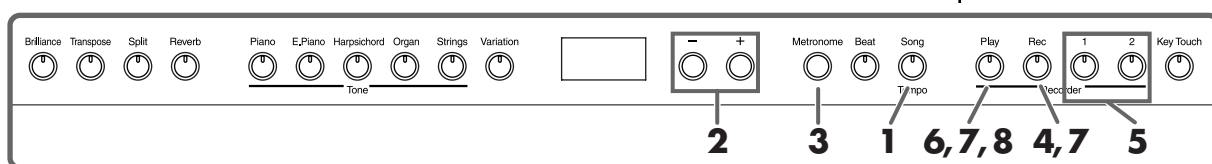

Selecting the song to record

1. Press the [Song/Tempo] button, getting its indicator to light in red.

The display will indicate the song number.

2. Use the [+] or [-] button to select the song that you want to play.

3. As necessary, set the metronome and tempo (p. 19).

4. Press the [Rec] button.

The [Rec] button's indicator will light.

Selecting the track to record

5. Press the [1] or [2] button.

When you want to record the left-hand performance, press the [1] button; to record that of the right hand, press the [2] button.

The indicators of the button you pressed and of the [Play] button will blink, and the DP-900 enters recording-standby mode.

Starting to record

6. Press the [Play] button.

Recording begins after two measures of count sound.

Play along with the song.



If "dEL" appears in the display, refer to p. 26.

Stop recording

7. Press the [Play] or [Rec] button.

Recording will stop, and the indicators for the [Play] and [Rec] buttons will go dark.

The recorded performance is stored in “USr (User).”

Play back the recorded performance

8. Press the [Play] button.

You will hear the recorded performance.

Once again press the [Play] button, and playback will stop.



When a recorded performance is played back, the metronome sounds the ordinary metronome sound.

Selecting and Recording the Track for Each Hand Separately

The recorder of the DP-900 has two recording tracks, allowing you to record the right and left hands separately. Use the [1] button or [2] button to specify the recording track.

If you want to re-do the recording, you can re-record just a specific track.

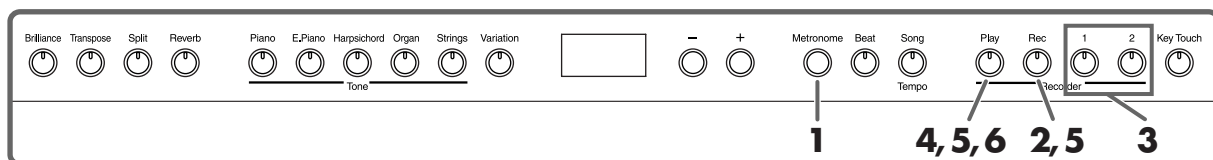

As described in steps 1 and 2 of “Recording a New Song” (p. 27), select “USr” before you continue.

1. As necessary, turn on the metronome (p. 19).

2. Press the [Rec] button.

The [Rec] button’s indicator will light.

The button indicators of tracks that are already recorded will light.

The track button for which you will next be recording will be blinking.

Selecting the track to record

3. Press the [1] or [2] button to select the track that you want to record.

The indicator of the button you pressed will blink, and the DP-900 enters recording standby mode.

Start recording

4. Press the [Play] button.

The DP-900 counts down two measures, then recording starts.

Note that recording will also begin as soon as you play anything on the keyboard, even if you do not press the [Play] button. There is no count sound played when you start in this manner.



If you go on to record additional material without erasing the recorded song, the song tempo, beat, and metronome settings of the original recording will be used for the new material as well.



The track buttons allow you to record to either the [1] or the [2] button, one at a time.

Stop recording

5. Press the [Play] or [Rec] button.

Recording will stop, and the indicators for the [Play] and [Rec] buttons will go dark.

Your performance has been recorded to the specified track button.

If you want to record on the other track, return to step 2 to record your performance again. You can record while you listen to the previously recorded performance.

Play back the recorded performance

6. Press the [Play] button.

You will hear the recorded performance.

Press the [Play] button once again, and playback will stop.



When a recorded performance is played back, the metronome sounds the sound that was selected when the recording was made.

Erasing Recorded Performances

You can erase a recorded performance.

■ Erasing a Performance from the Specified Track

You can select a recorded track and erase it.

1. Hold down either the [1] or [2] button and press the [Rec] button.

The indicator of the button you pressed will go dark, and the performance of the selected track will be erased.

■ Erasing a Song

You can erase a song you've recorded.

1. Hold down the [Song/Tempo] button and press the [Rec] button.

The following display will appear, and the [Rec] button's indicator will blink.



2. Once again press the [Rec] button.

The recorded performance is erased.

If you decide not to erase the performance, press the [Play] or [Song/Tempo] button.

Changing Various Settings

Changing the Damper Pedal's Resonance

On an acoustic piano, depressing the damper pedal makes the notes you play resonate with other strings, adding rich reverberations and fatness to the sound. The damper pedal on the DP-900 recreates this resonance (sympathetic resonance) when depressed.

You can select from eight levels of depth for the resonant sound (resonance level).

This is set to "5" when the instrument is turned on.

* *This setting is valid only for some piano tones. It cannot be made for other tones.*

1. Hold down the [Reverb] button and [Split] button, and press the [-] or [+] button.

The currently specified value will be displayed.

Larger values will produce a deeper effect.



Making Detailed Settings (Function)

You can make performance-related settings such as tuning and temperament.

How to enter function mode

1. Hold down the [Metronome] button, and press the [Beat] button.

The indicators of the buttons you pressed will blink, and you will enter function mode.

The display will indicate the value of the currently selected function.

Setting the various functions

2. Press the button to which the desired function is assigned.

The indicator of the button you pressed will blink.

Button	Function	Page
[Piano]	Master Tuning	p. 31
[E. Piano]	Temperament	p. 32
[Harpichord]	Stretch Tuning	p. 32
[Organ]	Applying the damper pedal to the left-hand keyboard area	p. 33
[Strings]	MIDI send channel	p. 35
[Variation]	Local Control	p. 36
[Play]	Transmitting a recorded performance	p. 36

For details on each function, refer to the explanations below.

3. Press the [+] or [-] button to change the value.

If you press the [+] and [-] buttons simultaneously, the value will return to the power-up default setting.

How to exit function mode

4. Press the [Metronome] or [Beat] button.

The button's indicator will return to the previous state.

■ Tuning to Other Instruments' Pitches (Master Tuning)

In situations such as when playing ensemble with other instruments, you can tune the DP-900's reference pitch to the pitch of another instrument. The standard pitch generally refers to the pitch of the note that's played when you finger the middle A key. This tuning of all the instruments to a standard pitch is called "tuning."

If you press the **[Piano] button** in step 2 of "Making Detailed Settings (Function)" (p. 31), a display like the following will appear.



The last three digits are indicated in the display. "440.0 Hz" is indicated in the figure above.

Value 415.3 Hz-440.0 Hz-466.2 Hz

Power-up default setting 440.0 Hz

This setting remains in effect until you turn off the power.

■ Changing the Temperament

You can play classical styles such as Baroque using historic temperaments (tuning methods).

Today, compositions are generally created with equal temperament in mind and are played using equal temperament. However in past ages of classical music, a variety of temperaments were used. Playing a composition with its original tuning lets you enjoy the sonorities of the chords that the composer originally intended.

If you press **the [E.Piano] button** in step 2 of “Making Detailed Settings (Function)” (p. 31), a display like the following will appear.



Temperament Tonic

You can choose from among the seven temperaments described below.

Display	Temperament	Qualities
1	Equal	In this tuning, each octave is divided into twelve equal steps. Every interval produces about the same amount of slight dissonance. This setting is in effect when you turn on the power.
2	Pythagorean	This tuning, devised by the philosopher Pythagoras, eliminates dissonance in fourths and fifths. Dissonance is produced by third-interval chords, but melodies are euphonious.
3	Just Major	This tuning eliminates ambiguities in the fifths and thirds. It is unsuited to playing melodies and cannot be transposed, but is capable of beautiful sonorities.
4	Just Minor	The Just tunings differ from major and minor keys. You can get the same effect with the minor scale as with the major scale.
5	Mean Tone	This scale makes some compromises in just intonation, enabling transposition to other keys.
6	Werckmeister	This temperament combines the Mean Tone and Pythagorean tunings. Performances are possible in all keys (first technique, III).
7	Kirn-berger	This is an improvement of the Mean Tone and Just tunings that provides a high degree of freedom of modulation. Performances are possible in all keys (III).

Power-up default setting 1 C

Tonic

When playing with tuning other than equal temperament, you need to specify the keynote for tuning the song to be performed (that is, the note that corresponds to C for a major key or to A for a minor key).

While hold down **the [E. Piano] button**, and press **a note** to specify the desired tonic key.

The tonic note you specify will be displayed as follows.

Display	C	d_	d	E_	E	F	F ⁻	G	A_	A	b_	b
Letter name	C	D ^b	D	E ^b	E	F	F [#]	G	A ^b	A	B ^b	B

If you choose an equal temperament, there's no need to select a keynote.

- * If you record with a temperament other than equal temperament selected, and then want to play back that performance, use this setting to select the same temperament for playback as the temperament you used when recording.
- * When performing in ensemble with other instruments, be aware that depending on the key, there may be some shifting of the pitch. Tune the DP-900 to the fundamental pitch of the other instruments.

■ Setting the Tuning Curve (Stretch Tuning)

A piano is generally tuned to a pitch with a lower bass range and a higher treble range than equal temperament. This special tuning method for pianos is called “Stretch Tuning.”

If you press **the [Harpisichord] button** in step 2 of “Making Detailed Settings (Function)” (p. 31), a display like the following will appear.



Values

- OFF This is the standard tuning curve. This is the right choice when using Dual play (p. 17), or when playing in ensemble with other instruments.
- On This tuning curve expands the bass and treble ends somewhat. It is suitable for performances such as piano solos. This setting is in effect when you turn on the power.

Power-up default setting On

→ This effect works only with the piano tones.

■ Applying the Damper Pedal to the Left-hand Keyboard Area

When you are using Split play (p. 18), you can apply the damper pedal effect to the sound played by the left-hand keyboard area.

If you press the **[Organ] button** in step 2 of “Making Detailed Settings (Function)” (p. 31), a display like the following will appear.



Values

On The damper pedal effect will be applied to the sound of the left and right hand keyboard area.

OFF The damper pedal effect will not be applied to the sound of the left-hand keyboard area.

Power-up default setting OFF

Preventing the Settings from Changing During Performance

■ Tone Lock

You can set the instrument so all of its buttons are disabled (the settings in effect at that time will be maintained). This prevents the settings from being inadvertently modified even if children press the buttons accidentally.

1. Hold down the **[Brilliance] button** and press the **[Key Touch] button**.

The song or the metronome sound that is playing will stop.

The following will appear in the display:



All buttons are disabled while the instrument is set like this.

To cancel the Tone Lock function, once again hold down the **[Brilliance] button** while you press the **[Key Touch] button**. Alternatively, you can lower the instrument’s volume all the way and switch its power off. Then, turn it on again.

■ Disabling Everything Except Piano Play (Panel Lock)

The “Panel Lock” function locks the DP-900 in a state where only piano performance can be used, and all buttons will be disabled. In the Panel Lock state, only the grand piano sound can be played.

1. Turn the volume to the minimum, and press the **[Power] switch** to turn off the power.
2. Hold down the **[Piano] button** and press the **[Power] switch** to turn on the power.

Then, continue to hold down these two buttons for a few seconds.

The following display will appear.



All buttons are disabled.

Adjust the volume.

When you play the keyboard, the grand piano sound will be heard.

To defeat the Panel Lock function, turn the volume down to the minimum, and turn on the power once again.

Connecting External Devices

Connecting to Audio Equipment

You can connect audio devices to play the sound of the DP-900 through the speakers of your audio system, or to record your performance on a tape recorder or other recording device.

When connecting, please use an audio cable with a standard phone plug (sold separately).

Connection Examples

- * To prevent malfunction and/or damage to speakers or other devices, always turn down the volume, and turn off the power on all devices before making any connections.

Playing the sound of the DP-900 through the speakers of an audio system/Recording the performance of the DP-900 on a recording device

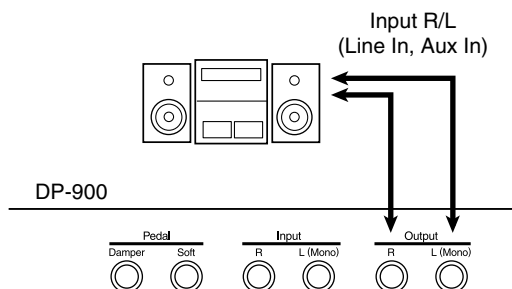

- Use the following procedure when turning on the power.

1. Turn on the power of the DP-900.
2. Turn on the power of the connected device.
3. Adjust the volume of each device.
When Recording DP-900 Performances on a Recording Device
4. Start recording with the connected device.
5. Perform on the DP-900.
6. When the performance ends, stop recording on the connected equipment.

Playing the sound of an audio device through the speakers of the DP-900

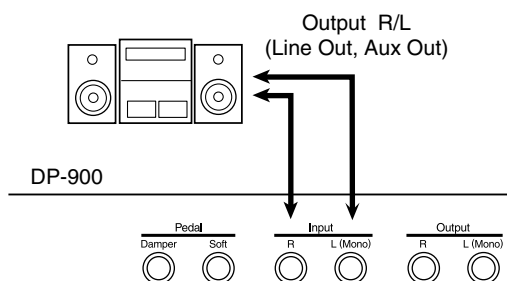

- Use the following procedure when turning on the power.

1. Turn on the power of the connected device.
2. Turn on the power of the DP-900.
3. Adjust the volume of each device.

Turning off the power

1. Set the volume of the DP-900 and of the connected devices to the minimum position.
2. Turn off the power to the DP-900.
3. Turn off the connected equipment.

Connecting MIDI Devices

By connecting an external MIDI device and exchanging performance data, you can control the performances on one device from the other. For instance, you can output sound from the other instrument or switch tones on the other instrument.

■ What's MIDI?

MIDI stands for Musical Instrument Digital Interface, an international standard which allows performance information to be communicated among electronic musical instruments and computers.

The DP-900 provides MIDI connectors, which allow performance data to be exchanged with external devices. When these connectors are used to connect the DP-900 to external devices, an even wider range of possibilities becomes available.

- * A separate publication titled "MIDI Implementation" is also available. It provides complete details concerning the way MIDI has been implemented on this unit. If you should require this publication (such as when you intend to carry out byte-level programming), please contact the nearest Roland Service Center or authorized Roland distributor.

Connection Examples

- * To prevent malfunction and/or damage to speakers or other devices, always turn down the volume, and turn off the power on all devices before making any connections.

Playing the DP-900 from a MIDI sequencer/Recording an DP-900 performance on a MIDI sequencer

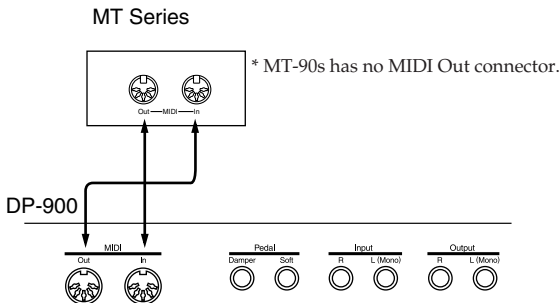

- * Set Local Off if you have connected the DP-900 to a MIDI sequencer. Refer to "Switching Local Control on and Off" (p. 36). Also set your MIDI sequencer to MIDI Thru mode (so that messages received at MIDI IN will be re-transmitted without change from MIDI OUT). For details, refer to the owner's manual of your MIDI sequencer.

Perform on the DP-900 to play a MIDI sound generator

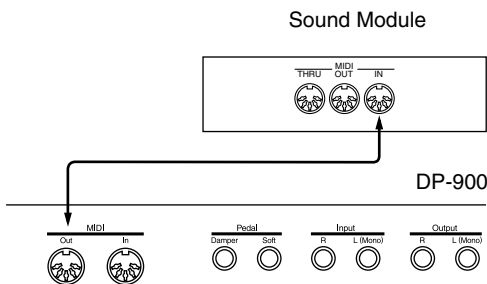

Making MIDI-related Settings

Here's how you can set the transmit channel and other MIDI-related settings.

How to enter function mode

1. Hold down the [Metronome] button and press the [Beat] button.

The indicators of the buttons you pressed will blink, and you will enter function mode.

The display will indicate the value of the currently selected function.

Setting various functions

2. Press the button to which the desired function is assigned.

The indicator of the button you pressed will blink.

For details on the contents of each function, refer to the explanations that follow.

3. Press the [+] or [-] button to change the value.

If you press the [+] and [-] buttons simultaneously, the setting will return to the original value.

How to exit function mode

4. Press either the [Metronome] button or the [Beat] button.

The button's indicator will return to the previous state.

MIDI Send Channel Settings

MIDI features sixteen MIDI channels, numbered 1-16. Simply connecting a cable is not enough for communication to take place. The connected devices must be set to use the same MIDI channels. Otherwise, no sound will be produced, and no sounds can be selected.

- * The DP-900 receives all channels 1-16.

- * If you are using Dual play (p. 17) or Split play (p. 18) on the DP-900, only the channel you specify here will be transmitted.

If you press the [Strings] button in step 2 of "Making MIDI-related settings," a display like the following will appear.



Value 1-16
Power-up default setting 1

■ Switching Local Control on and Off

When connecting a MIDI sequencer, set Local Control to “Off.”

As illustrated, information describing what has been played on the keyboard is passed to the internal sound generator over two different routes, (1) and (2). As a result, you hear overlapping or intermittent sounds. To prevent this from happening, route (1) must be severed, by setting the unit to what is known as “Local Off.”

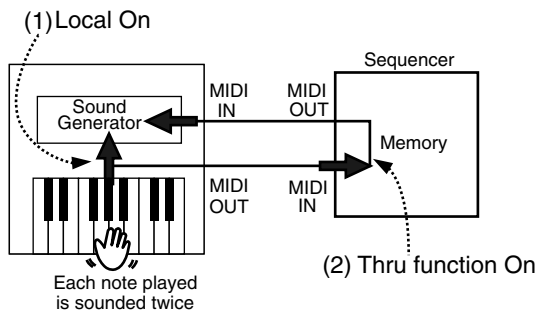

Local Control ON: The keyboard and the internal sound generator are in a linked state.

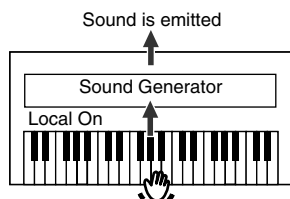

Local Control OFF: The keyboard and the internal sound generator are in an unlinked state. No sound will be produced by the keyboard when it is played.

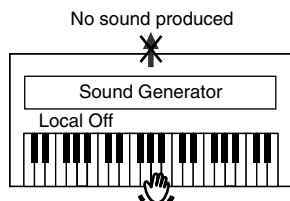

* When a Roland MT series instrument is connected, it is not necessary to make the Local Off setting. MT units transmit Local Off messages when their power is switched on. If you turn on the power in the order of the DP-900 → MT series, Local Off will be set automatically.

If you press the **[Variation]** button in step 2 of “Making MIDI-related settings,” a display like the following will appear.



Value On, OFF

Power-up default setting On

■ Transmitting a Performance You Recorded

If you want to transmit a performance recorded on the DP-900 to an external MIDI device or computer, turn this setting “On.” If this is “Off,” the data will not be transmitted.

If you press the **[Play]** button in step 2 of “Making MIDI-related settings,” a display like the following will appear.



Value On, OFF

Power-up default setting OFF

If you wish to save the performance, use the following procedure. In this situation, your external sequencer is set its MIDI Thru feature to be OFF. For details, refer to the owner’s manual of your MIDI sequencer.

1. **Connect a MIDI sequencer such as the MT series (p. 34).**
2. **Record the performance on the DP-900 (p. 27).**
3. **Set this setting to “On.”**
4. **Start recording with the connected MIDI device.**
5. **Start playback of the recorded song on the DP-900.**
6. **When playback ends, stop recording with the connected MIDI device.**
7. **Use a connected MIDI sequencer to save the data on a floppy disk or other media.**

Troubleshooting

If you think there's a problem, read this first.

Case	Cause/Remedy
The power doesn't come on	Is the power cord connected and plugged in correctly? (p. 11)
The button doesn't work	Is the tone or panel locked? (p. 33) Turn the power off, then back on.
No sound is heard	Is the volume level of the DP-900 turned all the way down? (p. 14) Are headphones plugged in? (p. 12) Has a plug remained connected to the Phones jack? When headphones are connected, the keyboard's speaker stops playing. Is Local Off selected? (p. 36) Set Local Control to "ON".
No sound is heard (when a MIDI instrument is connected)	Have all devices been switched on? Are the MIDI cables connected correctly? Does the MIDI channel match the connected instrument? (p. 35)
Sounds are heard twice (doubled) when the keyboard is played	Is the DP-900 in Dual play? (p. 17) When the DP-900 is connected to an external sequencer, set it to the Local OFF mode (p. 36). Alternatively, the sequencer could be set so its MIDI Thru feature is OFF.
The tone has changed in the Split or Dual play	If you use Dual play or Split play with a Tone button for which tone number 3 or 4 is selected, tone number 1 will be selected for that Tone button (p. 17). Some tones assign the tone that had been selected before you pressed the [Split] button to the left hand area of the keyboard. Please refer to "Tone List" (p. 40).
Tone doesn't change	Is the tone or panel locked? (p. 33) Turn the power off, then back on. Are the indicators for the [Metronome] and [Beat] buttons flashing? Setting of functions is in progress. Press the [Metronome] or [Beat] button to exit function mode (p. 31, p. 35).
Not all played notes are sounded	The maximum number of notes that the DP-900 can play simultaneously is 64. Frequent use of the damper pedal when playing along with a song may result in performance data with too many notes, causing some notes to drop out.
The tuning or pitch of the keyboard or song is off	Have you set Transpose? (p. 22) Are the settings for the "Temperament" and "Stretch Tuning" correct? (p. 32) Is the setting for the "Master Tuning" correct? (p. 31)

Case	Cause/Remedy
Song doesn't play back/ Only the sound of a particular instrument in a song does not play	Are the indicator for the Track buttons ([1] and [2] buttons) extinguished? (p. 25) If the button indicator is out, the music on that track is not heard. Press the track button so the indicator is illuminated.
Can't record	Has one of the track buttons for recording been selected? (p. 28-p. 29)
Tempo of recorded song or metronome is off	If you select an internal song in which the tempo changes during the song, and then record, the tempo will change in the same way for the performances. The tempo of the metronome will also change in the same way. If you record additional material without erasing the previously recorded song, the song will be recorded at the first-recorded tempo. Please erase the previously recorded song before you re-record (p. 30).
The metronome sound doesn't change	When an internal song is played back, the metronome sounds the ordinary metronome sound. When a recorded performance is played back, the metronome sounds the sound that was selected when the recording was made.
The recorded performance has disappeared	Any performance that has been recorded is deleted when the power to the DP-900 is turned off. A performance cannot be restored once it's been deleted.
Depressing a pedal has no effect, or the pedal effect doesn't stop	Is the pedal connected correctly? Make sure the pedal cord extending from the stand is securely connected to the pedal jack on the rear of the unit (p. 12).
Reverberation still audible even with Reverb turned off	Since the DP-900's piano sounds faithfully reproduce the sense of spaciousness and reverberation of an actual acoustic piano's sound, a certain amount of reverberation is still perceptible, even with the reverb effect deactivated.
The sound is distorted	The sound may distort if the volume is turned up too much. Adjust the volume with the [Volume] knob (p. 14). Also, with certain tones the sound can seem to be distorted.

Troubleshooting

Case	Cause/Remedy
In the upper range, the sound changes abruptly beyond a certain key	On an acoustic piano, notes in the upper one and a half octaves of the keyboard continue to sound until they decay naturally, regardless of the damper pedal. There is a difference in the timbre as well. Roland pianos faithfully simulate such characteristics of the acoustic piano. On the DP-900, the range that is unaffected by the damper pedal will change depending on the Key Transpose setting.
A High-pitched whine is produced	<p>When listening through headphones: Some of the more flamboyant and effervescent piano tones feature an ample high-end component, which may make the sound appear to have metallic reverberation added. Since this reverberation becomes particularly audible when supplemented by heavy reverb, you may be able to diminish the problem by reducing the amount of reverb applied to the sound.</p> <p>If you can't hear the problem in the headphones: Here, a different cause (such as resonance produced by the DP-900) would be suspect. Consult your Roland dealer or nearest Roland Service Center.</p>

Case	Cause/Remedy
The bass range sounds odd, or there is a vibrating resonance	<p>If you can't hear the problem in the headphones: Playing at loud volumes may cause instruments near the DP-900 to resonate. Resonance can also occur with fluorescent light tubes, glass doors, and other objects. In particular, this problem occurs more easily when the bass component is increased, and when the sound is played at higher volumes. Use the following measures to suppress such resonance.</p> <ul style="list-style-type: none"> • Place speakers so they are 10–15 cm from walls and other surfaces. • Reduce the volume. • Move the speakers away from any resonating objects. <p>When listening through headphones: Here, a different cause (such as resonance produced by the DP-900) would be suspect. Consult your Roland dealer or nearest Roland Service Center.</p>
The volume level of the instrument connected to Input jacks is too low	<p>Could you be using a connection cable that contains a resistor? Use a connection cable that does not contain a resistor.</p>

Error Messages/Other Messages

Display	Meaning
USr	User. Stores recorded performances (p. 27).
USr.	The "." in the display indicates that there is performance material already recorded (p. 27).
d.	Internal song number (p. 15).
t.	Metronome sound number (p. 21).
PU	This appears when a song with a pickup (a song that does not start on the first beat) is played back.
dEL	This appears when you attempt to delete a recorded song (p. 26, p. 30).
E.32	The amount of performance information is too large, and further recording is not possible.
E.41	A problem such as a loose MIDI cable occurred. Make sure the MIDI cables are correctly hooked up.

* Error messages are indicated by an "E." before the number. Press any button, and you can cancel the error message.

Tone List

Button name	[Variation]	[Split] Off	[Split] On		
		Tone	[Variation] Dark	[Variation] Red	[Variation] Green
[Piano]	Dark	Grand Piano1	Grand Piano1 /Acoustic Bass	Grand Piano1 /Acoustic Bass & Cymbal	Grand Piano1 /Strings
	Red	Grand Piano2	Grand Piano2 /Acoustic Bass	Grand Piano2 /Acoustic Bass & Cymbal	Grand Piano2 /Strings
	Green	Piano + Strings			
	Orange	Piano + Choir			
[E. Piano]	Dark	Electric Piano1	Electric Piano1 /Electric Bass	Electric Piano1 /Acoustic Bass	Electric Piano1 /Strings
	Red	Electric Piano2	Electric Piano2 /Electric Bass	Electric Piano2 /Acoustic Bass	Electric Piano2 /Strings
	Green	Vibraphone			
	Orange	Electric Piano+Choir			
[Harpsi- chord]	Dark	Harpsichord	Harpsichord /Strings	Harpsichord /Organ Flute	Harpsichord /Acoustic Bass
	Red	Organ Flute	Organ Flute /Organ Bass	Organ Flute /Strings	Organ Flute /Choir
	Green	Harpsichord + Strings			
	Orange	Harpsichord + Choir			
[Organ]	Dark	Church Organ	Church Organ /Organ Bass	Church Organ /Strings	Church Organ /Choir
	Red	Rotary Organ	Rotary Organ /Lower Organ	Rotary Organ /Electric Bass	Jazz Organ /Rotary Organ
	Green	Organ + Strings			
	Orange	Organ + Choir			
[Strings]	Dark	Strings	Strings /Pizzicato	Strings /Choir	Oboe /Strings
	Red	Slow Strings	Slow Strings /Pizzicato	Slow Strings /Choir	Flute /Slow Strings
	Green	Strings + Choir			
	Orange	Strings + Brass			

* A+B: *simultaneously playing two tones*

You can change the volume balance between the two tones, refer to "Adjusting the Volume Balance in Dual Play" (p. 17).

A/B: A, the right-hand tone; and B, the left-hand tone in Split play

Internal Song List

Song No.	Song Name	Composer	Copyright
d. 1	Iére Arabesque	C. Debussy	© 1995 Roland Corporation
d. 2	Late Night Chopin	F. Chopin/ Arranged by John Maul	© 2002 Roland Corporation
d. 3	Sonate für Klavier No. 15	W. A. Mozart	© 1996 Roland Corporation
d. 4	Fly Free	J. Maul	© 1998 Roland Corporation
d. 5	Liebesträume III	F. Liszt	© 2001 Roland Corporation
d. 6	Étude, op.10-3	F. Chopin	© 2001 Roland Corporation
d. 7	Je te veux	E. Satie	© 1997 Roland Corporation
d. 8	Valse, op.64-1	F. Chopin	© 2001 Roland Corporation
d. 9	Golliwog's Cake walk	C. Debussy	© 1995 Roland Corporation
d. 10	Fantaisie-Impromptu	F. Chopin	© 2001 Roland Corporation
d. 11	An der schönen, blauen Donau	J. Strauss	© 1996 Roland Corporation
d. 12	Auf Flügeln des Gesanges	F. Mendelsshon	© 1996 Roland Corporation
d. 13	Mazurka No.5	F. Chopin	© 1995 Roland Corporation
d. 14	1ère Gymnopédie	E. Satie	© 1997 Roland Corporation
d. 15	Étude, op.25-1	F. Chopin	© 1995 Roland Corporation
d. 16	Clair de Lune	C. Debussy	© 1998 Roland Corporation
d. 17	Étude, op.10-5	F. Chopin	© 2001 Roland Corporation
d. 18	Doctor Gradus ad Parnassum	C. Debussy	© 1995 Roland Corporation
d. 19	Grande Valse Brillante	F. Chopin	© 1995 Roland Corporation
d. 20	La prière d'une Vierge	T. Badarzewska	© 1996 Roland Corporation
d. 21	Course en Troïka	P. Tchaikovsky	© 1996 Roland Corporation
d. 22	To The Spring	E. Grieg	© 1996 Roland Corporation
d. 23	Valse, op.64-2	F. Chopin	© 1996 Roland Corporation
d. 24	Radetzky Marsch	J. Strauss	© 1996 Roland Corporation
d. 25	Träumerei	R. Schumann	© 1996 Roland Corporation
d. 26	Moments Musicaux III	F. Schubert	© 1996 Roland Corporation
d. 27	Prélude, op.28-15	F. Chopin	© 1996 Roland Corporation
d. 28	The harmonious blacksmith	G. Handel	© 1996 Roland Corporation
d. 29	Ungarische Tänze V	J. Brahms	© 1996 Roland Corporation
d. 30	Türkischer Marsch (Beethoven)	L. v. Beethoven	© 1996 Roland Corporation
d. 31	Nocturne No.2	F. Chopin	© 1996 Roland Corporation
d. 32	Frühlingslied	F. Mendelsshon	© 1996 Roland Corporation
d. 33	Präludium	J. S. Bach	© 1996 Roland Corporation
d. 34	Jägerlied	F. Mendelsshon	© 1996 Roland Corporation
d. 35	Menuet Antique	M. Ravel	© 1996 Roland Corporation
d. 36	Für Elise	L. v. Beethoven	© 1996 Roland Corporation
d. 37	Türkischer Marsch (Mozart)	W. A. Mozart	© 1996 Roland Corporation

Internal Song List

Song No.	Song Name	Composer	Copyright
d. 38	Ständchen	F. Schubert	© 1996 Roland Corporation
d. 39	Humoreske	A. Dvorjak	© 1996 Roland Corporation
d. 40	Blumenlied	G. Lange	© 1996 Roland Corporation
d. 41	Alpenglöckchen	T. Oesten	© 1996 Roland Corporation
d. 42	Menuett G dur (Beethoven)	L. v. Beethoven	© 1996 Roland Corporation
d. 43	Venezianisches Gondellied	F. Mendelsshon	© 1996 Roland Corporation
d. 44	Alpenabendröte	T. Oesten	© 1996 Roland Corporation
d. 45	Farewell to the Piano	L. v. Beethoven	© 1996 Roland Corporation
d. 46	Brautchor	W. Wagner	© 1996 Roland Corporation
d. 47	Battle of Waterloo	W. Anderson	© 1996 Roland Corporation
d. 48	Wiener Marsch	C. Czerny	© 1996 Roland Corporation
d. 49	Le Coucou	L. C. Daquin	© 1996 Roland Corporation
d. 50	Menuett G dur (Bach)	J. S. Bach	© 1992 Roland Corporation
d. 51	Spinnerlied	A. Ellmenreich	© 1996 Roland Corporation
d. 52	Gavotte	F. Gossec	© 1996 Roland Corporation
d. 53	Heidenröslein	G. Lange	© 1996 Roland Corporation
d. 54	Zigeuner Tanz	H. Lichner	© 1996 Roland Corporation
d. 55	La Cinquantaine	G. Marie	© 1996 Roland Corporation
d. 56	Csikos Post	H. Necke	© 1996 Roland Corporation
d. 57	Dolly's Dreaming Awakening	T. Oesten	© 1996 Roland Corporation
d. 58	La Violette	L. Streabbog	© 1996 Roland Corporation
d. 59	Fröhlicher Landmann	R. Schumann	© 1996 Roland Corporation
d. 60	Sonatine op.36-1 (Clementi)	M. Clementi	© 1996 Roland Corporation
d. 61	Sonatine op.20-1 (Kuhlau)	F. Kuhlau	© 1996 Roland Corporation
d. 62	Sonatine No.5 (Beethoven)	L. v. Beethoven	© 1996 Roland Corporation
d. 63	Hungarian Rag: Hungarian Dance No. 5 Ragtime Arrangement For Solo Piano	J. Brahms/ Arranged by John Maul	© 1996 Roland Corporation
d. 64	Paganooogie Variation: Jazz Variation Based on "Caprice No. 24 in A Minor"	N. Paganini/ Arranged by John Maul	© 1998 Roland Corporation
d. 65	L'éveil del l'amour	Masashi & Kazuko Hirashita	© 2000 Roland Corporation

* All rights reserved. Unauthorized use of this material for purposes other than private, personal enjoyment is a violation of applicable laws.

Easy Operation List

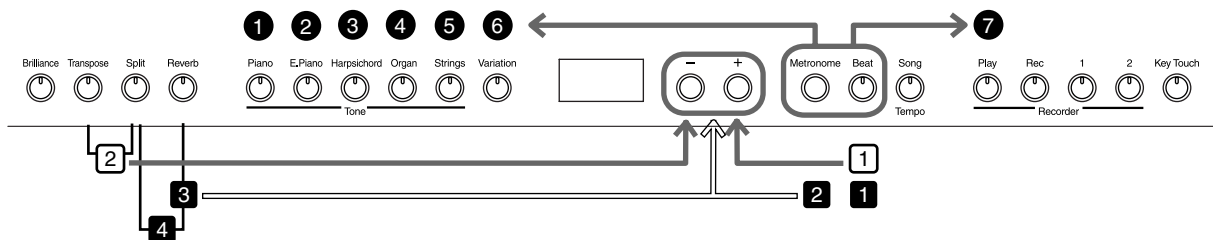

No.	You want to	Buttons	Page
Press the [Metronome] and [Beat] buttons simultaneously, and press the [●] button.			
①	Master Tuning	[Metronome]+ [Beat] → [Piano]	p. 31
②	Selecting a temperament Specifying the keynote	[Metronome] + [Beat] → [E. Piano] → [E. Piano] + key	p. 32
③	Stretch tuning	[Metronome] + [Beat] → [Harpsichord]	p. 32
④	Applying the damper pedal to the left-hand keyboard area	[Metronome] + [Beat] → [Organ]	p. 33
⑤	MIDI send channel settings	[Metronome] + [Beat] → [Strings]	p. 35
⑥	Local Control	[Metronome] + [Beat] → [Variation]	p. 36
⑦	Transmitting a recorded performance	[Metronome]+ [Beat] → [Play]	p. 36
Press the [□] button, and press the [-] or [+] button.			
①	Beat of metronome	[Beat] → [-] [+]	p. 20
②	Dual Balance	[Transpose] + [Split] → [-][+]	p. 17
Hold down the [■] button and press the [-] or [+] button.			
①	Metronome volume	[Metronome] + [-] [+]	p. 20
②	Metronome sound	[Beat] + [-] [+]	p. 21
③	Depth of the Reverb effect	[Reverb] + [-] [+]	p. 21
④	Damper pedal's resonance level	[Reverb] + [Split] + [-] [+]	p. 31
Hold down the [Split] or [Transpose] button and press the key.			
	Split Point	[Split] + key	p. 19
	Key Transpose	[Transpose] + key	p. 22

MIDI Implementation Chart

Digital Piano
Model DP-900

MIDI Implementation Chart

Date : Sep. 1, 2003
Version : 1.00

Function...	Transmitted	Recognized	Remarks
Basic Channel Default Changed	1 1-16	1 1-16	
Mode Default Messages Altered	Mode 3 x *****	Mode 3	
Note Number : True Voice	15-113 *****	0-127 15-113	
Velocity Note ON Note OFF	O x 8n v=64	O x	
After Touch Key's Ch's	x x	x x	
Pitch Bend	x	x	
Control Change 6, 38 7 11 64 66 67 91 100, 101	O x x O x O O O	O O *1 O *1 O *1 O *1 O *1 O O	Data entry Volume Expression Hold 1 Sostenuto Soft Effect 1 (Reverb) RPN LSB, MSB
Prog Change : True Number	O (0...117) *****	O (0-127) 0...119	
System Exclusive	O	O	
System Common : Song Pos : Song Sel : Tune	x x x	x x x	
System Real Time : Clock : Commands	x x	x x	
Aux Message : All sound off : Reset all controllers : Local Control : All Notes OFF : Active Sense : Reset	x x x x O x	x O O O (123-127) O x	
Notes			

Mode 1 : OMNI ON, POLY
Mode 3 : OMNI OFF, POLY

Mode 2 : OMNI ON, MONO
Mode 4 : OMNI OFF, MONO

O : Yes
X : No

Main Specifications

Keyboard	
Keyboard	88 keys (Progressive Hammer-Action keyboard)
Touch Sensitivity	Light, Medium, Heavy, Fixed
Keyboard Modes	Whole, Dual (volume balance adjustable), Split (split point adjustable)
Sound Generator	
Max. Polyphony	64 voices
Tones	5 groups 20 variations
Temperament	7 types, selectable tonic
Stretched Tuning	2 types
Master Tuning	415.3 Hz–466.2 Hz (adjustable in increments of 0.1 Hz)
Transpose	Key Transpose (-6– +5 in units of semitones)
Effects	Reverb (8 levels), Chorus (for E. Piano only), Sympathetic Resonance (for Piano only, 8 levels)
Metronome	
Beat	2/2, 0/4, 2/4, 3/4, 4/4, 5/4, 6/4, 7/4, 3/8, 6/8, 9/8, 12/8
Volume	8 levels
Recorder	
Tracks	2 tracks
Song	1 song
Note Storage	Approx. 5,000 notes
Tempo	Quarter note = 20–250
Resolution	96 ticks per quarter note
Control	Play/Stop, Rec, Tempo, All Song Play, Track Select
Preset Songs	65 songs
Others	
Rated Power Output	7 W x 2
Speakers	12 cm x 2
Display	7 segment, 3 characters (LED)
Control	Volume, Brilliance (3 levels)
Pedals	Damper, Soft
Other Functions	Tone Lock, Panel Lock
Connectors	Output jacks (L/Mono, R), Input jacks (L/Mono, R), Headphones jack x 2 (Stereo), MIDI In/MIDI Out connectors, Pedal jack
Power Supply	DC 9 V (AC Adaptor)
Power Consumption	23 W
Dimensions (including piano stand)	(lid close) 1,398 (W) x 344 (D) x 781 (H) mm 55-1/16 (W) x 13-9/16 (D) x 30-3/4 (H) inches
	(lid open) 1,398 (W) x 339 (D) x 974 (H) mm 55-1/16 (W) x 13-3/8 (D) x 38-3/8 (H) inches
Weights (including piano stand)	43.5 kg/ 95 lbs 15 oz
Accessories	Owner's Manual, AC Adaptor, Power cord

* In the interest of product improvement, the specifications and/or appearance of this unit are subject to change without prior notice.

INDEX

A

AC Adaptor	11
All Song Play	15
Assemble	6
Audio Equipment	34

B

Beat	20
------------	----

C

Count-In	24
----------------	----

D

Damper Pedal	12, 33
Resonance	31
Dual Play	17

E

Effects	21
Erase	30

H

Headphones	12
------------------	----

I

Internal Songs	15, 24
----------------------	--------

K

Key Touch	23
-----------------	----

L

Local Control	36
---------------------	----

M

Master Tuning	31
Metronome	19
Sound	21
Volume	20
MIDI	35
MIDI Channel	35
MIDI Devices	34
MIDI Send Channel	35
Music rest	13

P

Panel Lock	33
Pedals	12
Play	
All Songs Continuously	15
Each Hand	25
Selecting a song	15
Power	14

R

Recording	26
Along with a Song	28
Reference pitch	31
Resonance	31
Reverb	21

S

Settings	31
MIDI	35
Soft Pedal	12
Split	18
Split Play	18
Split Point	18
Stretch Tuning	32
Sympathetic resonance	31

T

Temperament	32
Tempo	19, 24
Tone button	16
Touch	23
Track buttons	25, 29
Transpose	22
Tuning Curve	32

V

Variation tones	16
Volume	14
Metronome	20

For the U.K.

IMPORTANT: THE WIRES IN THIS MAINS LEAD ARE COLOURED IN ACCORDANCE WITH THE FOLLOWING CODE.

BLUE: NEUTRAL
BROWN: LIVE

As the colours of the wires in the mains lead of this apparatus may not correspond with the coloured markings identifying the terminals in your plug, proceed as follows:

The wire which is coloured BLUE must be connected to the terminal which is marked with the letter N or coloured BLACK.
The wire which is coloured BROWN must be connected to the terminal which is marked with the letter L or coloured RED.
Under no circumstances must either of the above wires be connected to the earth terminal of a three pin plug.

For EU Countries



This product complies with the requirements of European Directive 89/336/EEC.

For the USA

FEDERAL COMMUNICATIONS COMMISSION RADIO FREQUENCY INTERFERENCE STATEMENT

This equipment has been tested and found to comply with the limits for a Class B digital device, pursuant to Part 15 of the FCC Rules. These limits are designed to provide reasonable protection against harmful interference in a residential installation. This equipment generates, uses, and can radiate radio frequency energy and, if not installed and used in accordance with the instructions, may cause harmful interference to radio communications. However, there is no guarantee that interference will not occur in a particular installation. If this equipment does cause harmful interference to radio or television reception, which can be determined by turning the equipment off and on, the user is encouraged to try to correct the interference by one or more of the following measures:

- Reorient or relocate the receiving antenna.
- Increase the separation between the equipment and receiver.
- Connect the equipment into an outlet on a circuit different from that to which the receiver is connected.
- Consult the dealer or an experienced radio/TV technician for help.

This device complies with Part 15 of the FCC Rules. Operation is subject to the following two conditions:

- (1) This device may not cause harmful interference, and
- (2) This device must accept any interference received, including interference that may cause undesired operation.

Unauthorized changes or modification to this system can void the users authority to operate this equipment.
This equipment requires shielded interface cables in order to meet FCC class B Limit.

For Canada

NOTICE

This Class B digital apparatus meets all requirements of the Canadian Interference-Causing Equipment Regulations.

AVIS

Cet appareil numérique de la classe B respecte toutes les exigences du Règlement sur le matériel brouilleur du Canada.

