

KAWAI

DIGITAL PIANO
CN 31

Owner's Manual

PART NAMES AND FUNCTIONS
1

PLAYING THE PIANO
2

LESSON FUNCTION
3

RECORDER
4

FUNCTION BUTTONS
5

APPENDICES
6

THANK YOU FOR PURCHASING A KAWAI DIGITAL PIANO!

This KAWAI digital piano is a revolutionary new keyboard instrument, combining the latest in electronic advances with traditional craftsmanship inherited from KAWAI's many years of experience building fine pianos. The CN31 keyboard provides the touch response and full dynamic range required for a superb performance of piano, harpsichord, organ, and other instruments. The CN31's Lesson function helps performers to practice the piano with a collection of etudes from Czerny and Burgmüller, or songs from *Alfred's Basic Piano Library* and *Alfred's Premiere Piano Course* lesson books (USA, Canada, Australia and UK only).

In addition, the CN piano is equipped with reverb and digital effects processors, providing an unrivalled richness of sound. Industry standard MIDI (Musical Instrument Digital Interface) jacks are included, allowing a number of other electronic instruments to be controlled and played simultaneously, creating a range of musical possibilities.

This Owner's Manual contains valuable information to help performers make full use of the instrument's many capabilities. Please read all sections carefully and keep this manual handy for future reference.

Table of Contents

<p>◆ Important Safety Instructions 4</p> <p>1. PART NAMES AND FUNCTIONS 8</p> <p style="padding-left: 20px;">◇ FRONT PANEL 8</p> <p style="padding-left: 20px;">◇ PEDALS 8</p> <p style="padding-left: 20px;">◇ HEADPHONES 9</p> <p>2. PLAYING THE PIANO 10</p> <p style="padding-left: 20px;">1) BASIC OPERATIONS 10</p> <p style="padding-left: 40px;">◇ SETTING UP THE PIANO 10</p> <p style="padding-left: 40px;">◇ DEMO SONGS 11</p> <p style="padding-left: 40px;">◇ SELECTING A PRESET SOUND 12</p> <p style="padding-left: 20px;">2) DUAL 13</p> <p style="padding-left: 20px;">3) SPLIT 14</p> <p style="padding-left: 20px;">4) 'FOUR HANDS' MODE 16</p> <p style="padding-left: 40px;">◇ ENTERING 'FOUR HANDS' MODE 16</p> <p style="padding-left: 40px;">◇ EXITING 'FOUR HANDS' MODE 16</p> <p style="padding-left: 20px;">5) EFFECTS/REVERB 17</p> <p style="padding-left: 40px;">◇ ADDING REVERB 17</p> <p style="padding-left: 40px;">◇ ADDING OTHER EFFECTS 18</p> <p style="padding-left: 20px;">6) SELECTING THE TOUCH SENSITIVITY 19</p> <p style="padding-left: 20px;">7) TRANSPOSING THE PIANO 20</p> <p style="padding-left: 20px;">8) PLAYING WITH CONCERT MAGIC 21</p> <p style="padding-left: 40px;">◇ SELECTING A SONG 21</p> <p style="padding-left: 40px;">◇ LISTENING TO THE SONG 21</p> <p style="padding-left: 40px;">◇ PERFORMING A SONG 22</p> <p style="padding-left: 40px;">◇ CONCERT MAGIC PART VOLUME BALANCE 22</p> <p style="padding-left: 40px;">◇ CONCERT MAGIC SONG ARRANGEMENT TYPES ... 23</p> <p style="padding-left: 40px;">◇ STEADY BEAT 24</p> <p style="padding-left: 40px;">◇ CONCERT MAGIC DEMO MODES 24</p> <p style="padding-left: 40px;">◇ CONCERT MAGIC PLAYBACK SPEED 25</p> <p style="padding-left: 20px;">9) METRONOME 26</p> <p style="padding-left: 40px;">◇ STARTING THE METRONOME 26</p> <p style="padding-left: 40px;">◇ CHANGING THE TIME SIGNATURE 26</p> <p style="padding-left: 40px;">◇ ADJUSTING THE METRONOME VOLUME 27</p> <p>3. LESSON FUNCTION 28</p> <p style="padding-left: 20px;">1) SELECTING A BOOK/SONG 28</p> <p style="padding-left: 20px;">2) LISTENING TO AND PLAYING A SONG 29</p> <p style="padding-left: 40px;">◇ EXITING THE LESSON FUNCTION 29</p> <p style="padding-left: 40px;">◇ PRACTICING THE LEFT AND RIGHT-HAND PARTS ... 29</p> <p style="padding-left: 40px;">◇ ADJUSTING THE TEMPO OF A SONG 29</p> <p style="padding-left: 20px;">3) RECORDING A SONG PRACTICE 30</p> <p style="padding-left: 40px;">◇ PLAYING BACK THE RECORDING 30</p> <p style="padding-left: 40px;">◇ ERASING THE RECORDING 30</p>	<p>4. RECORDER 31</p> <p style="padding-left: 20px;">1) RECORDING (REC BUTTON) 31</p> <p style="padding-left: 40px;">◇ RECORDING A SECOND PART 32</p> <p style="padding-left: 20px;">2) PLAYING BACK A SONG 34</p> <p style="padding-left: 40px;">◇ PLAYING BACK RECORDED PARTS SEPARATELY ... 34</p> <p style="padding-left: 20px;">3) ERASING A SONG 35</p> <p>5. FUNCTION BUTTONS 36</p> <p style="padding-left: 20px;">◇ ENTERING A FUNCTION MODE 36</p> <p style="padding-left: 20px;">◇ EXITING A FUNCTION MODE 36</p> <p style="padding-left: 20px;">1) TUNING 37</p> <p style="padding-left: 20px;">2) TEMPERAMENT 38</p> <p style="padding-left: 40px;">◇ KEY SIGNATURE OF TEMPERAMENT 39</p> <p style="padding-left: 40px;">◇ MIDI OVERVIEW 40</p> <p style="padding-left: 40px;">◇ CN31 MIDI functions 40</p> <p style="padding-left: 20px;">3) MIDI CHANNEL 41</p> <p style="padding-left: 20px;">4) TRANSMIT PROGRAM CHANGE ON/OFF 42</p> <p style="padding-left: 20px;">5) LOCAL CONTROL ON/OFF 44</p> <p style="padding-left: 20px;">6) MULTI-TIMBRAL MODE ON/OFF 45</p> <p style="padding-left: 20px;">7) CHANNEL MUTE 46</p> <p style="padding-left: 20px;">8) SENDING PROGRAM CHANGE NUMBERS 47</p> <p style="padding-left: 20px;">9) LOWER OCTAVE SHIFT 48</p> <p style="padding-left: 20px;">10) LOWER PEDAL ON/OFF 49</p> <p>6. APPENDICES 50</p> <p style="padding-left: 20px;">◇ CONNECTING TO OTHER DEVICES 50</p> <p style="padding-left: 20px;">◇ ASSEMBLY INSTRUCTIONS 51</p> <p style="padding-left: 20px;">◇ SPECIFICATIONS 53</p> <p style="padding-left: 20px;">◇ MIDI EXCLUSIVE DATA FORMAT 54</p> <p style="padding-left: 20px;">◇ MIDI IMPLEMENTATION CHART 55</p>
--	---

Important Safety Instructions

SAVE THESE INSTRUCTIONS

INSTRUCTIONS PERTAINING TO A RISK OF FIRE, ELECTRIC SHOCK, OR INJURY TO PERSONS



WARNING

TO REDUCE THE RISK OF FIRE OR ELECTRIC SHOCK, DO NOT EXPOSE THIS PRODUCT TO RAIN OR MOISTURE.

AVIS : RISQUE DE CHOC ELECTRIQUE - NE PAS OUVRIR.

TO REDUCE THE RISK OF ELECTRIC SHOCK, DO NOT REMOVE COVER (OR BACK). NO USER-SERVICEABLE PARTS INSIDE. REFER SERVICING TO QUALIFIED SERVICE PERSONNEL.



The lightning flash with arrowhead symbol, within an equilateral triangle, is intended to alert the user to the presence of uninsulated "dangerous voltage" within the product's enclosure that may be of sufficient magnitude to constitute a risk of electric shock to persons.



The exclamation point within an equilateral triangle is intended to alert the user to the presence of important operating and maintenance (servicing) instructions in the literature accompanying the product.

Examples of Picture Symbols



denotes that care should be taken.
The example instructs the user to take care not to allow fingers to be trapped.



denotes a prohibited operation.
The example instructs that disassembly of the product is prohibited.



denotes an operation that should be carried out.
The example instructs the user to remove the power cord plug from the AC outlet.

Read all the instructions before using the product.

- 1) Read these instructions.
- 2) Keep these instructions.
- 3) Heed all warnings.
- 4) Follow all instructions.
- 5) Do not use this apparatus near water.
- 6) Clean only with dry cloth.
- 7) Do not block any ventilation openings. Install in accordance with the manufacturer's instructions.
- 8) Do not install near any heat sources such as radiators, heat registers, stoves, or other apparatus (including amplifiers) that produce heat.
- 9) Do not defeat the safety purpose of the polarized or grounding-type plug. A polarized plug has two blades with one wider than the other. A grounding type plug has two blades and a third grounding prong. The wide blade or the third prongs are provided for your safety. If the provided plug does not fit into your outlet, consult an electrician for replacement of the obsolete outlet.
- 10) Protect the power cord from being walked on or pinched particularly at plugs, convenience receptacles, and the point where they exit from the apparatus.
- 11) Only use attachments/accessories specified by the manufacturer.
- 12) Use only with the cart, stand, tripod, bracket, or table specified by the manufacturer, or sold with the apparatus. When a cart is used, use caution when moving the cart/apparatus combination to avoid injury from tip-over. 
- 13) Unplug this apparatus during lightning storms or when unused for long periods of time.
- 14) Refer all servicing to qualified service personnel. Servicing is required when the apparatus has been damaged in any way, such as power-supply cord or plug is damaged, liquid has been spilled or object have fallen into the apparatus, the apparatus has been exposed to rain or moisture, does not operate normally, or has been dropped.

WARNING - When using electric products, basic precautions should always be followed, including the following.



WARNING

Indicates a potential hazard that could result in death or serious injury if the product is handled incorrectly.

The product should be connected to an AC outlet of the specified voltage.



- If you are going to use an AC power cord, make sure that it has the correct plug shape and conforms to the specified power voltage.
- Failure to do so may result in fire.

Do not insert or disconnect the power cord plug with wet hands.



Doing so may cause electric shock.

The chair must be used properly (it must be used only when playing the product).

- Do not play with it or stand on it.
- Only one person is allowed to sit on it.
- Do not sit on it when opening the lid.
- Re-tighten the bolts occasionally.

Doing so may cause the chair to fall over or your fingers to be trapped, resulting in injury.

When using the headphones, do not listen for long periods of time at high volume levels.

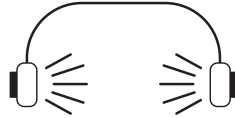

Doing so may result in hearing problems.

Do not lean against the keyboard.



Doing so may cause the product to fall over, resulting in injury.

Do not disassemble, repair or modify the product.

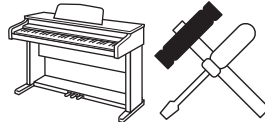

Doing so may result in product breakdown, electric shock or short-circuit.

When disconnecting the AC power cord's plug, always hold the plug and pull it to remove it.



- Pulling the AC power cord itself may damage the cord, causing a fire, electric shock or short-circuit.

The product is not completely disconnected from the power supply even when the power switch is turned off. If the product will not be used for a long time, unplug the AC power cord from the AC outlet.



- Failure to do so may cause fire in case of lightning.
- Failure to do so may over-heat the product, resulting in fire.

This product may be equipped with a polarized line plug (one blade wider than the other). This is a safety feature. If you are unable to insert the plug into the outlet, contact an electrician to replace your obsolete outlet. Do not defeat the safety purpose of the plug.

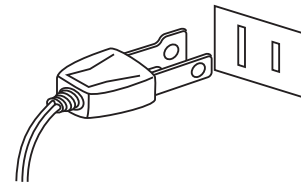

It is a good practice to have the instrument near the AC outlet and the power cord plug in a position so that it can readily be disconnected in an emergency because electricity is always charging while the plug is in the AC outlet even in a power switch off condition.



CAUTION

Indicates a potential hazard that could result in injury or damage to the product or other property if the product is handled incorrectly.

Do not use the product in the following areas.

- Areas, such as those near windows, where the product is exposed to direct sunlight
- Extremely hot areas, such as near a heater
- Extremely cold areas, such as outside
- Extremely humid areas
- Areas where a large amount of sand or dust is present
- Areas where the product is exposed to excessive vibrations

Using the product in such areas may result in product breakdown. Use the product only in moderate climates (not in tropical climates).

When you close the keyboard cover, close it gently.



Closing it roughly may trap your fingers, resulting in injury.

Before connecting cords, make sure that the power to this product and other devices is turned OFF.

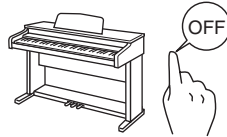

Failure to do so may cause breakdown of this product and other devices.

Take care not to allow any foreign matter to enter the product.

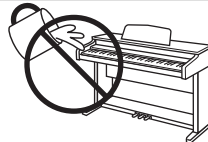

Entry of water, needles or hair pins may result in breakdown or short-circuit. The product shall not be exposed to dripping or splashing. No objects filled with liquids, such as vases, shall be placed on the product.

Do not drag the product on the floor. Take care not to drop the product.



Please lift up the product when moving it. Please note that the product is heavy and must be carried by more than two persons. Dropping the product may result in breakdown.

Do not place the product near electrical appliances such as TVs and radios.

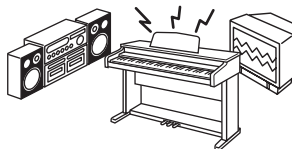

- Doing so may cause the product to generate noise.
- If the product generates noise, move the product sufficiently away from the electrical appliance or connect it to another AC outlet.

When connecting the AC power cord and other cords, take care not to get them tangled.



Failure to do so may damage them, resulting in fire, electric shock or short-circuit.

Do not wipe the product with benzene or thinner.



- Doing so may result in discoloration or deformation of the product.
- When cleaning the product, put a soft cloth in lukewarm water, squeeze it well, then wipe the product.

Do not stand on the product or exert excessive force.



- Doing so may cause the product to become deformed or fall over, resulting in breakdown or injury.

Do not place naked flame, such as lighted candles on the product.

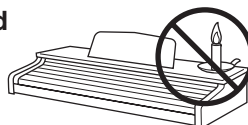

Doing so may cause the illumination to fall over, resulting in fire.

Ensure that the ventilation is not impeded by covering the ventilation openings with items, such as newspaper, table-cloths, curtains, etc.

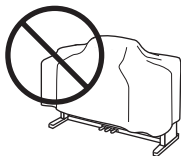

Failure to do so may over-heat the product, resulting in fire.

The product should be located so that its location or position does not interfere with its proper ventilation. Ensure a minimum distance of 5cm around the product for sufficient ventilation.

The product should be serviced by qualified service personnel when:

- The power supply cord or the plug has been damaged.
- Objects have fallen, or liquid has been spilled into the product.
- The product has been exposed to rain.
- The product does not appear to operate normally or exhibits a marked change in performance.
- The product has been dropped, or the enclosure damaged.

Notes on Repair

Should an abnormality occur in the product, immediately turn the power OFF, disconnect the power cord plug, and then contact the shop from which the product was purchased.

CAUTION:

To prevent electric shock, match wide blade of plug to wide slot, fully insert.

ATTENTION:

Pour éviter les chocs électriques, introduire la lame la plus large de la fiche dans la borne correspondante de la prise et pousser jusqu'au fond.

Instruction for AC power cord (U.K.)

Do not plug either terminal of the power cord to the ground of the AC outlet on the wall.

FCC Information

This equipment has been tested and found to comply with the limits for a Class B digital device, pursuant to Part 15 of the FCC Rules. These limits are designed to provide reasonable protection against harmful interference in a residential installation. This equipment generates, uses and can radiate radio frequency energy and, if not installed and used in accordance with the instructions, may cause harmful interference to radio communications.

If this equipment does cause harmful interference to radio or television reception, which can be determined by turning the equipment off and on, the user is encouraged to try to correct the interference by one or more of the following measures:

- Reorient or relocate the receiving antenna.
- Increase the separation between the equipment and receiver.
- Connect the equipment into an outlet on a different electrical circuit from the receiver.
- Consult the dealer or an experienced radio/TV technician for help.

Canadian Radio Interference Regulations

This instrument complies with the limits for a class B digital apparatus, pursuant to the Radio Interference Regulations, C.R.C., c. 1374.



An information on Disposal for users

If your product is marked with this recycling symbol it means that, at the end of its life, you must dispose of it separately by taking it to an appropriate collection point. You should not mix it with general household waste. Disposing of this product correctly will prevent potential negative effects on the environment and human health which could otherwise arise due to inappropriate waste handling.

For further details, please contact your local authority.
(European Union only)

1. PART NAMES AND FUNCTIONS

This section explains the locations and functions of the panel buttons and sliders.

◇ FRONT PANEL

● CONCERT MAGIC

Press the CONCERT MAGIC button to enjoy listening to or performing a collection of pre-programmed piano songs. Concert Magic will provide the correct melody and accompaniment notes, regardless of which keys are pressed. Anybody, young or old, can enjoy Concert Magic from the moment they sit down at the CN piano (page 21).

● LESSON

Press the LESSON button to access the etudes or Alfred lesson books (USA, Canada, UK, AU only), for an enjoyable piano lesson experience (page 28).

● LED DISPLAY

The LED display provides useful information such as the currently selected sound type. It also shows values or status when other functions are active.

● VALUE

These two buttons are used to change the value for various functions.

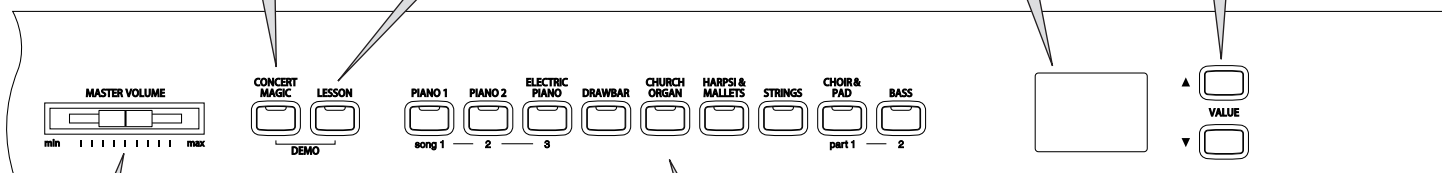

● MASTER VOLUME

This slider controls the piano's master volume level. Move this slider to the right to increase the volume and move it to the left to decrease the volume. This slider also controls the headphone volume and the LINE output level of the piano's sound.

● SOUND SELECT

Press the SOUND SELECT button below the name of the instrument to be played. When the button is pressed, an LED indicator will turn on, indicating that the sound has been selected (page 12).

◇ PEDALS

The CN piano has three pedals—just like a grand piano. They are Sustain, Sostenuto and Soft.

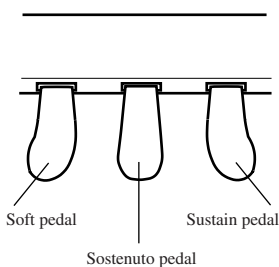

◆ Sustain pedal

Sustains the sound after hands are lifted from the keyboard. The sustain pedal is capable of responding to half pedaling.

◆ Sostenuto pedal

Depressing this pedal after playing the keyboard and before releasing the keys sustains the sound of only the keys just played. Any keys that are pressed after the Sostenuto pedal is depressed will not be sustained after the keys are released.

◆ Soft pedal

Depressing this pedal softens the sound and reduces its volume. When the rotary effect is active the soft pedal is used to change the speed of the rotor between slow and fast.

● EFFECTS

Use the EFFECTS button to add chorus, delay, tremolo and rotary speaker effects to the sound. (page 17).

● BALANCE

Use the balance slider to adjust the volume balance between the two sounds in Dual or Split mode. The balance slider also controls the volume of Left & Right-hand lesson/recorded parts.

● METRONOME

Use these buttons to turn on/off the metronome, and to set the tempo, beat, and volume (page 26).

● POWER SWITCH

Press this button to turn on/off the power. Be sure to turn off the instrument after playing.

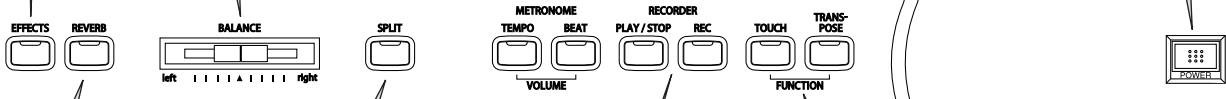

● REVERB

Use the REVERB button to add reverberation to the sound, simulating the acoustic environment of a recital room, stage, or concert hall (page 17).

● SPLIT

The split function divides the keyboard into two sections—upper and lower—allowing either part to be played with a different sound. (page 14).

● RECORDER

The REC button is used for recording performances and when using the lesson function, to record practices for comparison with the built in songs and etudes. The PLAY/STOP button is used to select a song and part to play, and to start/stop playback of the recorded songs. It is also used to start/stop playback when using the lesson function (page 31).

● TOUCH

The TOUCH function allows different touch sensitivities for the keyboard to be selected, other than the standard touch of an acoustic piano. When this function is turned off, the touch sensitivity returns to the standard touch of an acoustic piano (page 19).

● TRANSPOSE

The transpose function allows the piano's keys to be raised or lowered in half steps. This is particularly useful when accompanying instruments with different tones, or when a song learned in one key must be played in another key. The transpose feature allows the song to be played in the original key, but heard in another key (page 20).

● FUNCTION

Pressing the TOUCH and TRANSPOSE buttons simultaneously enters the FUNCTION modes, allowing various advanced parameters within the CN piano, such as tuning and MIDI operation, to be adjusted (page 36).

◇ HEADPHONES

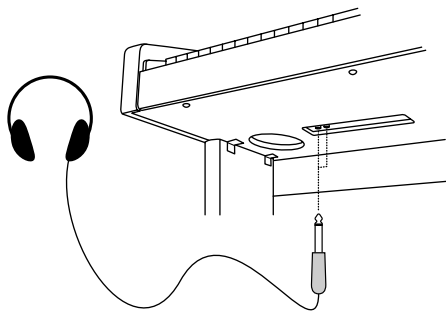

◆ Headphone jack (x 2)

There are two headphone jacks located on the left underside of the piano.

Up to two pairs of headphones can be connected simultaneously.

- See Page 52 for information on attaching the headphone hooks.

2. PLAYING THE PIANO

1) BASIC OPERATIONS

This section provides the basic procedures for turning the power on and playing the CN piano.

◇ SETTING UP THE PIANO

The CN piano is equipped with stereo speakers and an amplifier—no addition equipment is required to begin playing the instrument, provided AC power is available.

□ Step 1

Connect one end of the AC power cable to the piano's power jack and the other end of the cable to a wall AC outlet.

□ Step 2

Press the POWER SWITCH to turn on the power.

The POWER SWITCH is located at the right end of the front panel.

Press the POWER SWITCH again to turn off the power.

When the POWER button is pressed, the LED indicator for the PIANO1 button will turn on and the Concert Grand sound will automatically be selected.

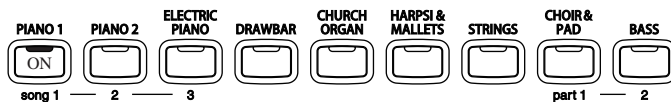
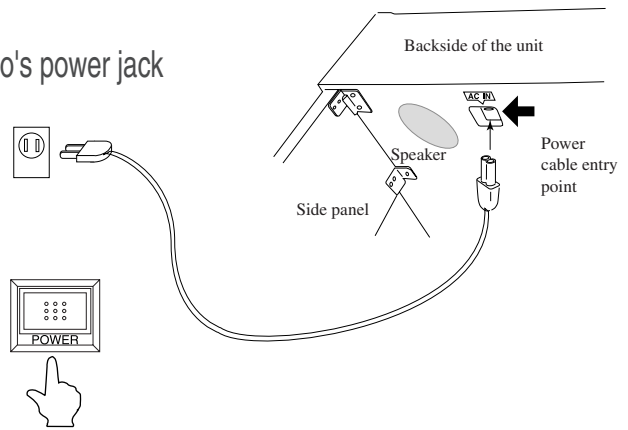

□ Step 3

Adjust the volume level using the MASTER VOLUME slider.

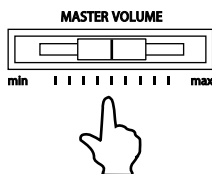

The MASTER VOLUME slider controls the volume level of the speakers and connected headphones.

Move this slider to the right to increase the volume and move it to the left to decrease the volume.

Use this slider to set the volume to a comfortable listening level—the middle is often a good starting point.

◇ DEMO SONGS

The CN31 includes 27 built-in sound demo songs. Each of the demo songs presents a musical piece to introduce the different preset sounds.

PIANO 1 Concert Grand : Valse Romantique / Debussy Studio Grand : KAWAI Mellow Grand : La Fille aux Cheveux de lin / Debussy	HARPSI & MALLETS Harpsichord : French Suite No.6 / Bach Vibraphone : KAWAI Clavi : KAWAI
PIANO 2 Modern Piano : KAWAI Rock Piano : KAWAI	STRINGS Slow Strings : KAWAI String Pad : KAWAI String Ensemble : Le quattro stagioni La primavera / Vivaldi
ELECTRIC PIANO Classic E.Piano : KAWAI Modern E.P. : KAWAI Modern E.P. 2 : KAWAI	CHOIR & PAD Choir : KAWAI Choir 2 : KAWAI New Age Pad : KAWAI Atmosphere : KAWAI
DRAWBER Jazz Organ : KAWAI Drawbar Organ : KAWAI Drawbar Organ 2 : KAWAI	BASS Wood Bass : KAWAI Fretless Bass : KAWAI W. Bass & Ride : KAWAI
CHURCH ORGAN Church Organ : Toccata / Eugene Gigout Diapason : Wohl mir, daß ich Jesum habe / Bach Full Ensemble : KAWAI	

KAWAI regret that sheet music for KAWAI original demo songs is not available.

□ Step1

Press the **CONCERT MAGIC** and **LESSON** buttons simultaneously.

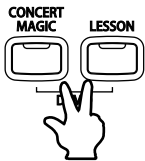

The LED indicators for the **CONCERT MAGIC** button and the **LESSON** button will turn on and the **SOUND SELECT** buttons will start to flash.

The demo song for the Piano 1 category will start. After the Piano 1 demo songs have finished playing, the demo songs for another sound category will be selected at random.

- There are 3 songs stored for the PIANO1 sound, which will be played in order. Pressing the PIANO1 button repeatedly will select the next piano song.

□ Step2

Press the other **SOUND SELECT** buttons while the demo is playing to listen to demos from each category.

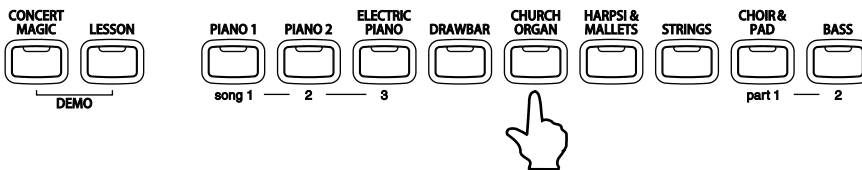

- When this button is pressed, demo songs for the newly selected category will be played. Demo songs from another category will then be selected at random.

□ Step3

Press the **CONCERT MAGIC** and **LESSON** buttons simultaneously again, or press the **PLAY/STOP** button to exit the demo mode.

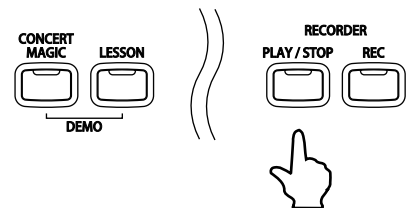

◇ SELECTING A PRESET SOUND

□ Step 1

Press the SOUND SELECT button below the name of the instrument to be played.

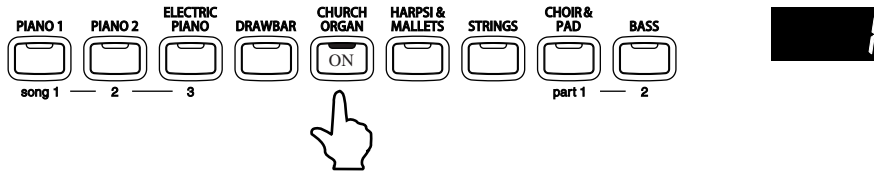

When the button is pressed, the LED indicator will turn on, indicating that this sound has been selected.

When a SOUND SELECT button is pressed, the variation number is briefly shown in the display. Multiple sounds are assigned to each button; pressing the same SOUND SELECT button again will select the next variation sound assigned to that SOUND SELECT button.

To select a Church Organ sound, press the CHURCH ORGAN button as shown above. The LED indicator for the CHURCH ORGAN button will turn on.

■ Preset sounds can also be selected by pressing the VALUE buttons.

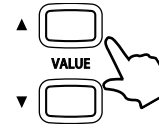

■ PRESET SOUNDS

■PIANO 1	Concert Grand	■HARPSI & MALLETS	Harpsichord
	Studio Grand		Harpsichord 2
	Mellow Grand		Vibraphone
	Jazz Grand		Clavi
■PIANO 2	Modern Piano	■STRINGS	Slow Strings
	Honky Tonk		String Pad
	Rock Piano		Warm Strings
	New Age Piano		String Ensemble
■ELECTRIC PIANO	Classic E.Piano	■CHOIR & PAD	Choir
	Modern E.P.		Choir 2
	60's E.P.		New Age Pad
	Modern E.P. 2		Atmosphere
■DRAWBAR	Jazz Organ	■BASS	Wood Bass
	Drawbar Organ		Finger Bass
	Drawbar Organ 2		Fretless Bass
	Be 3		W. Bass & Ride
■CHURCH ORGAN	Church Organ		
	Diapason		
	Full Ensemble		
	Diapason Oct		

□ Step 2

Play the keyboard.

The selected sound will be heard as the keys are pressed.

Use the MASTER VOLUME slider to adjust the volume if necessary.

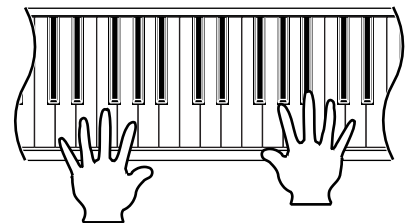
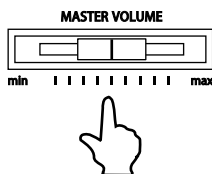

■ The CN piano is capable of playing up to 96 notes simultaneously (96-note polyphony). However, when playing in dual mode, or when playing a stereo piano sound, the polyphony will be reduced by half because the piano has to produce two sounds for each note.

2) DUAL

The DUAL function allows two preset sounds to be layered together, creating a more complex sound. For example, a piano can be layered with strings, or a church organ with a choir sound.

□ Step 1

Press and hold down a SOUND SELECT button to select the first desired sound. Then press another SOUND SELECT button to select the second desired sound.

The LED indicators for each button will turn on, indicating that the two sounds have been selected. The display will also briefly show the combination of the selected sound variation numbers. The left number represents the first sound and the right number represents the second sound.

For example, to layer a piano sound and a string sound, press the PIANO 1 and STRINGS buttons simultaneously as shown in the diagram.

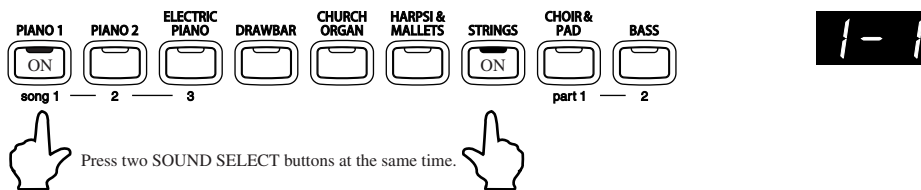

Pressing either of the SOUND SELECT buttons again will select the other sound variations assigned to that button. For example, to change the String Ensemble sound to Slow Strings, press and hold the PIANO 1 button and press the STRINGS button again.

If two sound variations assigned to the same SOUND SELECT button are to be layered, while pressing the desired SOUND SELECT button, use the VALUE buttons to select the desired sound variation. For example, to layer Concert Grand and Mellow Grand together, first press the PIANO 1 button to select Concert Grand, and then use the VALUE buttons to select Mellow Grand while still holding down the PIANO 1 button. Sound variations number 1 and 3 will be layered.

□ Step 2

Play the keyboard.

Two different sounds will be heard at the same time.

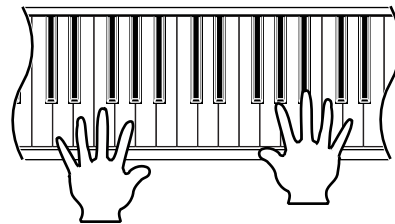

□ Step 3

Use the BALANCE slider to adjust the volume balance between the two sounds.

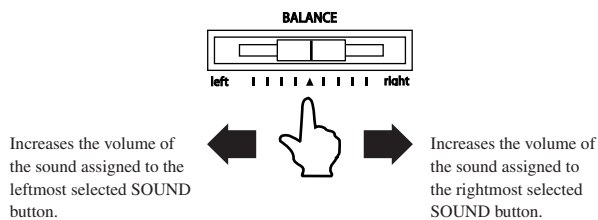

□ Step 4

Press any individual SOUND SELECT button to cancel DUAL mode.

3) SPLIT

The SPLIT function divides the keyboard into two sections—upper and lower—allowing each part to be played with a different sound.

□ Step 1

Press the SPLIT button.

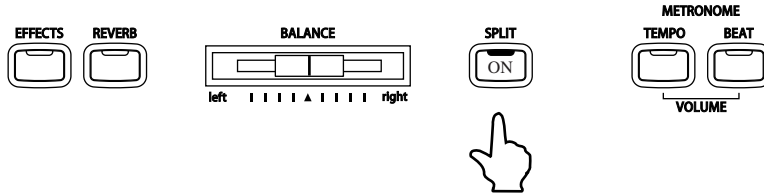

The LED indicator for the SPLIT button will turn on.

The LED indicator for the upper SOUND SELECT button will also be turned on, while the LED indicator for the lower SOUND SELECT button will start to flash.

When SPLIT mode is enabled, the display will show the combination of the selected sound variation numbers.

The left number represents the lower sound and the right number represents the upper sound.

The default split point is set between B2 and C3. This point can be moved to any key on the keyboard.

2-1

□ Step 2

Press and hold the SPLIT button, then press a key on the keyboard.

The pressed key will become the lowermost note for the upper section.

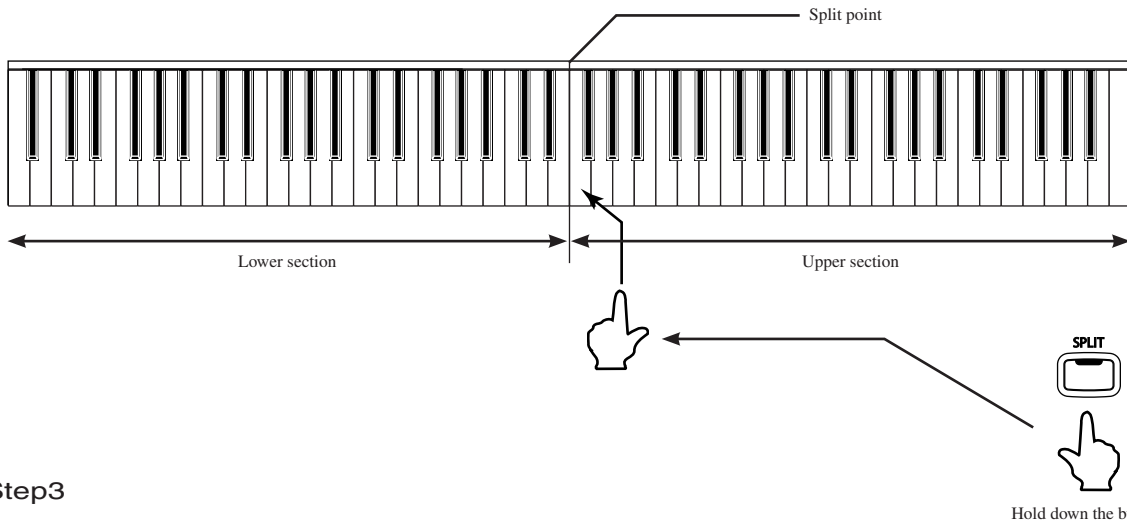

□ Step 3

Play the keyboard.

Different sounds will be produced in the upper and lower sections.

An ensemble performance can be enjoyed by playing the chords and the melody with the right hand, while playing a bass line with the left hand.

□ Step 4

To change the upper sound while SPLIT mode is enabled, press the desired SOUND SELECT button.

The LED indicator for the selected SOUND SELECT button will turn on.

Press the same button repeatedly to select another sound variation assigned to that button.

□ Step5

To change the lower sound while SPLIT mode is enabled, press and hold the SPLIT button, then press the desired SOUND SELECT button.

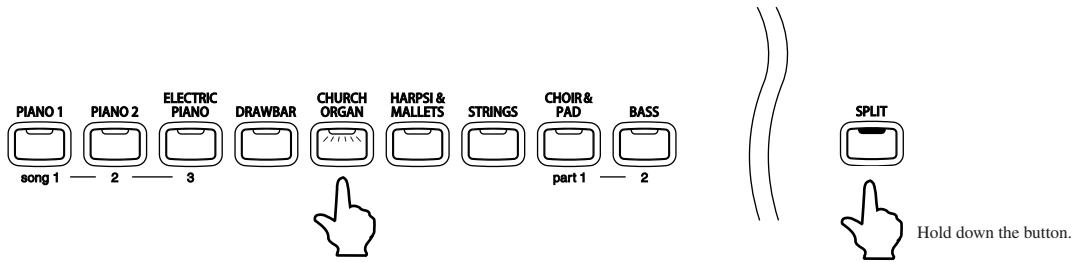

The LED indicator for the selected SOUND SELECT button will start to flash.
Press the same button repeatedly to select another sound variation assigned to that button.

□ Step6

Use the BALANCE slider to adjust the volume balance between the upper and lower sections.

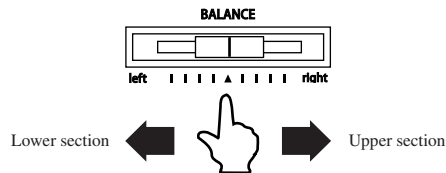

□ Step7

Press the SPLIT button to exit the split mode.

The LED indicator for the SPLIT button will turn off.



- When SPLIT mode is enabled, 'Lower Octave Shift' can be used to adjust the octave range for the lower section. (page 48).
- The Sustain pedal can also be turned ON / OFF for the lower section. (page 48).

4) 'FOUR HANDS' MODE

In 'FOUR HANDS' mode the CN piano keyboard is split into upper and lower sections, allowing two players to play the piano together. The sounds in the upper section are transposed two octaves down from the original pitch, while sounds from the lower section are transposed two octaves up from the original pitch, with both players playing in the same key range. The left pedal can also be used as a damper pedal for the player sitting on the left.

◇ ENTERING 'FOUR HANDS' MODE

□ Step 1

Press and hold the SPLIT button, then press the sustain (right) pedal and the soft (left) pedal together.

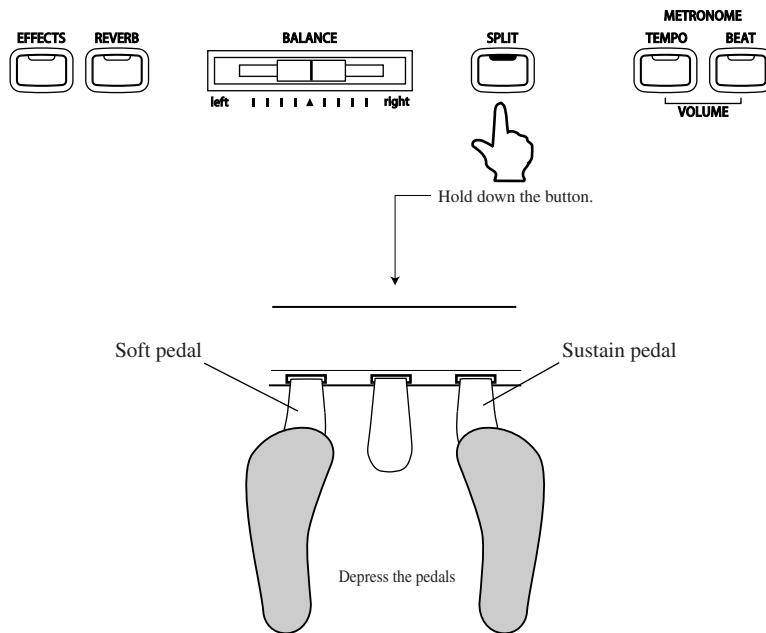

The LED indicator for the SPLIT button will start to flash, indicating that the piano is in 'FOUR HANDS' mode.

◆ Selecting Sounds in 'Four Hands' Mode

When in 'FOUR HANDS' mode, the method for selecting sounds is the same as in SPLIT mode. Press the desired SOUND SELECT button to change the sound for the upper section, or press and hold the SPLIT button, then press the desired SOUND SELECT button to change the sound for the lower section.

◆ Changing Split Point

When in 'FOUR HANDS' mode, the method for changing the SPLIT point is the same as in SPLIT mode. Press and hold the SPLIT button, then press a key on the keyboard. The pressed key becomes the lowermost note for the upper section. The default SPLIT point is set between E3 and F3.

Finally, when in 'FOUR HANDS' Mode, the OCTAVE SHIFT function can also be used to change the octave of the lower section. Please see page 48.

◇ EXITING 'FOUR HANDS' MODE

□ Step 1

To exit 'Four Hands' Mode, press the SPLIT button again.

The LED indicator for the SPLIT button will turn off.

5) EFFECTS/REVERB

When selecting some preset sounds, the LED indicator for the EFFECTS or REVERB buttons may turn on automatically. This is because certain preset sounds are prepared with an effect enabled as their default setting. Adding an effect to the sound enhances tonal quality and improves acoustic realism. This CN piano features two separate groups of effects. The first is reverb and the second contains chorus, delay, tremolo and rotary speaker.

◇ ADDING REVERB

◆ REVERB

Reverb adds reverberation to the sound, simulating the acoustic environment of a recital room, stage, or concert hall. There are five types of reverb available: Room 1, Room 2, Stage, Hall 1 and Hall 2.

□ Step1

Press the REVERB button.

The LED indicator will turn on to indicate that reverb is in use. Press and hold the REVERB button to show the currently selected reverb type in the display.

□ Step2

To change the reverb type, use the VALUE buttons while holding down the REVERB button.

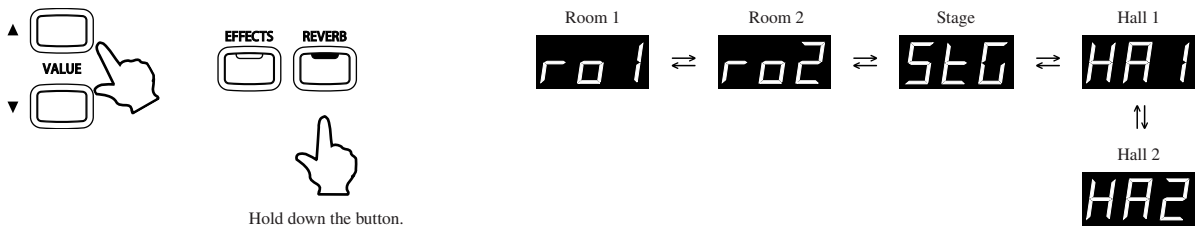

To turn off the reverb, press the REVERB button again.

Press the REVERB button once again to turn the reverb back on. The previously selected reverb type will be used.

Any changes made to the reverb type or on / off status will remain until the power is turned off.

When the power is turned off the reverb settings will return to the default settings.

◇ ADDING OTHER EFFECTS

◆ CHORUS

Chorus is an effect that simulates the rich character of a vocal choir or string ensemble, enriching the original voice by over-layering a slightly detuned version of the sound.

◆ DELAY

Delay is an effect that adds echoes to the sound. There are three types of delay available (delay 1, delay 2 and delay 3), each with a different length of delay between the echoes.

◆ TREMOLO

This is a vibrato type effect.

◆ ROTARY

This effect simulates the sound of the Rotary Speaker cabinet commonly used with electronic organs. Rotary 1 is normal rotary and Rotary 2 is with distortion effect. The soft pedal is used to change the speed of the rotor between SLOW and FAST.

□ Step 1

Press the EFFECTS button.

The LED indicator will turn on to indicate that the effect is in use. Press and hold the EFFECTS button to show the currently selected effect in the display.

□ Step 2

To change the effect type, press and hold the EFFECTS button and press the VALUE buttons.

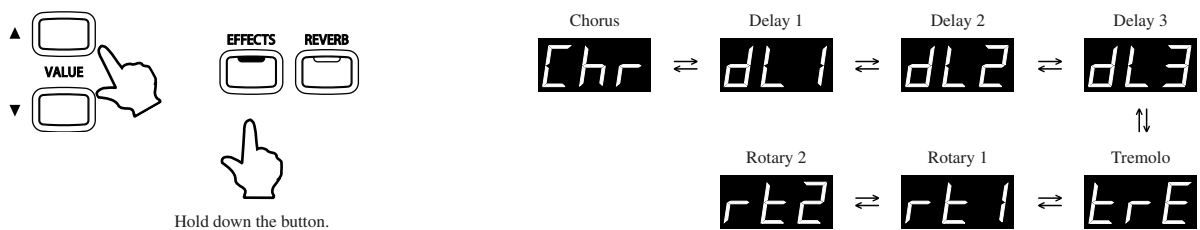

To turn off the effects, press the EFFECTS button again.

Press the EFFECTS button once again to turn the effects back on. The previously selected effect type will be used.

Any changes made to the effect type or on / off status will remain until the power is turned off.

When the power is turned off the effect settings will return to the default settings.

6) SELECTING THE TOUCH SENSITIVITY

The TOUCH function allows different touch sensitivities for the keyboard to be selected, other than the standard touch of an acoustic piano. The sensitivity can be changed to one of five different settings: Light 1, Light 2, Heavy 1, Heavy 2 or Off.

①Light 1	: For those still developing finger strength. A louder volume is produced even when playing with a soft touch.
②Light 2	: For players with a delicate touch. Requires less striking force to achieve a forte note.
③Normal	: Reproduces the standard touch sensitivity of an acoustic piano. This touch setting is selected when the LED indicator for the TOUCH button is off.
④Heavy 1	: Perfect for those with strong fingers. Requires a heavier touch to produce a loud volume.
⑤Heavy 2	: Requires more striking force to achieve a loud volume.
⑥Off	: A constant volume is produced regardless of how hard the keys are struck. This setting is suitable for sounds that have a fixed dynamic range such as Organ and Harpsichord.

□ Step1

Press the TOUCH button to change from the standard (Normal) touch setting.

The LED indicator for the TOUCH button will turn on, indicating that the piano is using a different touch setting.

□ Step2

To change the touch type, press and hold the TOUCH button and press the VALUE buttons.

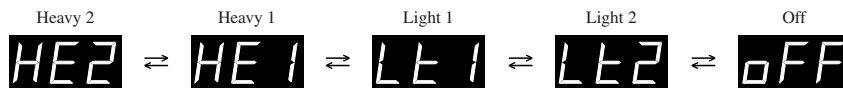
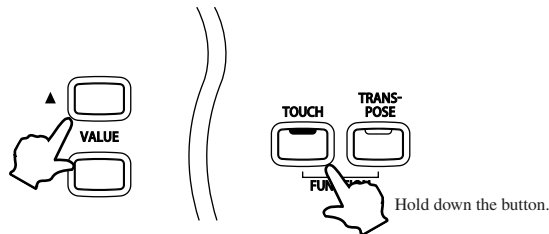

Press and hold the TOUCH button to show the currently selected touch curve in the display.

Press the TOUCH button again to return to the standard (Normal) touch setting.

The touch setting is global for all of the preset sounds. It is not possible to have individual touch settings for each preset sound.

When the power is turned off the touch settings will return to the default settings.

- LIGHT and HEAVY do not represent the physical weight of the keys. These are settings that affect the sensitivity of the keys, which determines the volume level in response to the key movement.

7) TRANSPOSING THE PIANO

The transpose function allows the piano's keys to be raised or lowered in half steps. This is particularly useful when accompanying instruments with different tones, or when a song learned in one key must be played in another key. The transpose feature allows the song to be played in the original key, but heard in another key.

□ Step 1

Press and hold the TRANSPOSE button. While holding the TRANSPOSE button, use the VALUE buttons or the keyboard keys from C2 to C4 to specify the transposition amount.

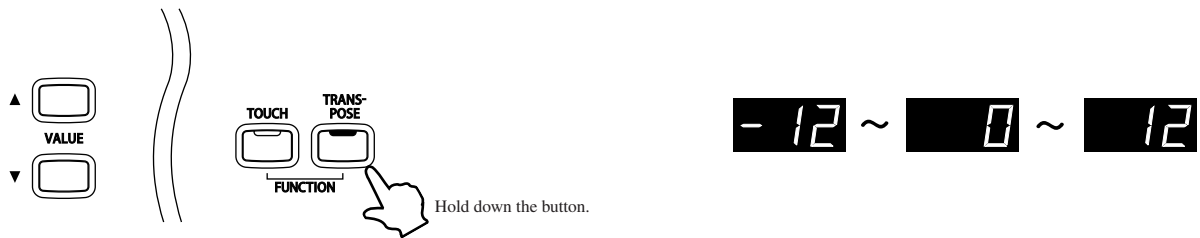

The display will show a number indicating how many half steps up or down the piano has been transposed.

'-5', for example, represents a transposition that is 5 half steps lower.

'0' indicates no transposition.

Each time the VALUE ▲ button is pressed, the transpose value is increased by one half step, while each time the VALUE ▼ button is pressed, the transpose value is decreased by one half step.

The piano can be transposed by up to 12 half steps higher or 12 half steps lower.

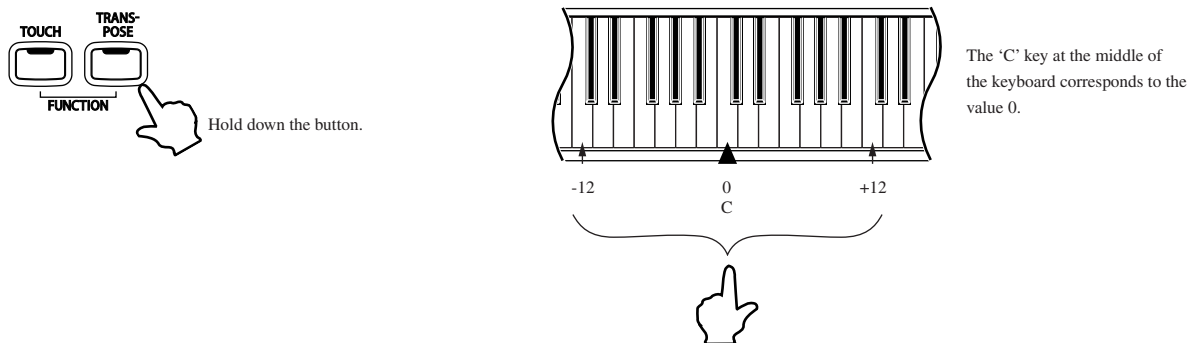

Pressing the TRANSPOSE button again turns the TRANSPOSE function off.

The TRANSPOSE function remembers the current setting as long as the power is on.

- Transpose is active when the LED indicator is on, and the notes are transposed according to the set transpose value. For example if the setting is '-3' and the LED indicator for the TRANSPOSE button is on, the notes will be transposed 3 half steps lower. When the LED indicator for the TRANSPOSE button is turned OFF, the transpose setting will automatically return to '0' (no transposition) with one touch.
- When the value is set to '0', the LED indicator will not turn on.
- The CN31 piano's transpose setting defaults to '0' each time the power is turned on.

8) PLAYING WITH CONCERT MAGIC

The great German composer Johann Sebastian Bach once said "Playing the keyboard is simple. Just strike the right keys at the right time". Many pianists wish it were quite that straightforward. Fortunately, KAWAI have devised a method of playing the keyboard that is very simple, without even needing to strike the right keys.

With CONCERT MAGIC, absolutely anyone can sit at the CN piano and make real music - even complete beginners who have never taken a piano lesson in their life. To enjoy performing with Concert Magic, simply select a favorite piece from the 88 pre-programmed songs and tap any key with a steady rhythm and tempo. Concert Magic will provide the correct melody and accompaniment notes, regardless of which keys are pressed. With Concert Magic anybody, young or old, can enjoy playing music from the moment they sit down at the CN piano.

◇ SELECTING A SONG

The 88 Concert Magic songs are assigned to each of the 88 keys, and classified by song category into eight groups, such as *Children's Songs*, *American Classics*, *Christmas Songs* etc. Please refer to the separate 'Internal Song List' booklet for a complete listing of available Concert Magic songs.

□ Step 1

To select a song, press and hold the CONCERT MAGIC button and press the key to which the desired song is assigned.

The song number will be briefly shown in the display.

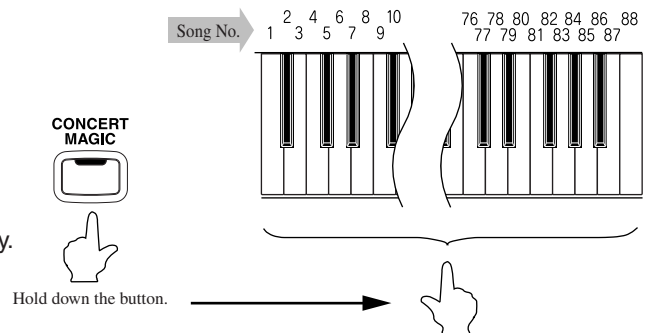

◇ LISTENING TO THE SONG

If the performer is already familiar with the selected Concert Magic song, he/she may wish to begin playing straight away. However, those unfamiliar with the piece may alternatively wish to listen to the song first, before attempting to play it.

□ Step 1

To listen, press the PLAY/STOP button.

The CN piano will start playing back the selected song.

The speed or tempo of the song can be adjusted by pressing and holding the TEMPO button and pressing the VALUE buttons.

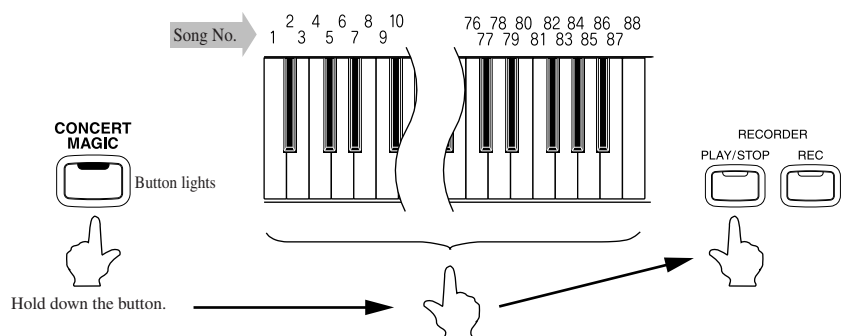

While listening, different Concert Magic songs can be selected by pressing the VALUE buttons.

□ Step 2

Press the PLAY/STOP button again to finish listening to the song.

◇ PERFORMING A SONG

□ Step 1

Tap out the rhythm of the selected song on any one of the piano's 88 black or white keys.

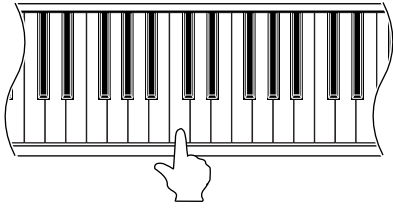

Concert Magic songs will respond to changes in playing style. As the keys are tapped harder, the music will grow louder; if the keys are tapped more softly, the music will become quieter. Tapping faster will cause the music to speed up, while tapping slower will make the music slow down accordingly. Using Concert Magic, even inexperienced pianists can sound like they have been playing for years, simply by pressing one key with one finger.

Concert Magic is a perfect method for small children to learn music, especially when developing a sense of rhythm. For older people who may believe it is too late to learn the piano, Concert Magic offers an enjoyable first step. With Concert Magic, the CN piano can be enjoyed by everyone in the family, even those who have never touched a musical instrument in their life.

◇ CONCERT MAGIC PART VOLUME BALANCE

When used with Concert Magic, the BALANCE slider adjusts the volume balance of the melody part and the accompaniment.

□ Step 1

Move the balance slider to the right or left to adjust the volume balance.

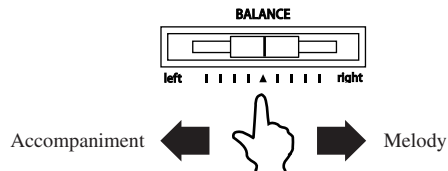

As the slider is moved to the right, the sound of the melody becomes louder and the accompaniment becomes softer. The balance changes in the opposite way when the slider is moved to the left.

◇ CONCERT MAGIC SONG ARRANGEMENT TYPES

After playing with Concert Magic for a while, performers may feel that such playing is too easy and that there is very little to learn. While it is true that some of the songs are very easy to play, even for beginners, there are also some songs which will prove challenging, and require practice to play proficiently.

Each of the 88 Concert Magic songs fall into one of three different arrangement types, depending on the skill level required to perform them.

■ EASY BEAT

These are the easiest songs to play. To perform them, simply tap out a constant steady beat on any key on the keyboard. Look at the following example, 'Für Elise'. Press the key with a steady sixteenth note rhythm.

Key on X X X X X X X X X X X X X X X X X X X X X X X X

The image shows a musical score for 'Für Elise' in 3/8 time. Above the staff, there are three groups of eight 'X' marks, each group representing a measure of a steady sixteenth note rhythm. The right hand part of the score consists of a series of sixteenth notes and eighth notes, while the left hand part consists of a bass line with some rests and eighth notes.

■ MELODY PLAY

These songs are also quite easy to play, especially if they are familiar to the player. To perform them, tap out the rhythm of the melody on any key on the keyboard. Singing along as the rhythm is tapped can be helpful. Play 'Twinkle, Twinkle, Little Star' for example. Follow the melody's rhythm as shown.

Key on X X X X X X X X X X X X X X

The image shows a musical score for 'Twinkle, Twinkle, Little Star' in common time (C). Above the staff, there are two groups of seven 'X' marks, each group representing a measure of the melody's rhythm. The right hand part of the score consists of a simple melody of quarter and eighth notes. The left hand part consists of a bass line with chords and single notes.

When performing fast songs with Concert Magic, it is sometimes easier to tap two different keys with two alternating fingers in order to play at greater speed.

■ SKILLFUL

These songs range in difficulty from moderately difficult to difficult. To perform them, tap out the rhythm of both the melody and the accompaniment notes on any key on the keyboard, such as 'Waltz of the Flowers' shown below.

Key on X X X X X X X X X X X X X

The image shows a musical score for 'Waltz of the Flowers' in 3/4 time. Above the staff, there are two groups of seven 'X' marks, each group representing a measure of the combined melody and accompaniment rhythm. The right hand part of the score consists of a melody with eighth and sixteenth notes. The left hand part consists of a bass line with chords and single notes.

It may take a little practice to perform the Concert Magic songs proficiently. A good way to learn is to listen to these pieces first, and then try to tap out the rhythms that are heard.

■ The separate 'Internal Song List' booklet lists the arrangement type next to each song title as 'EB' for Easy Beat, 'MP' for Melody Play and 'SK' for Skillful.

◇ STEADY BEAT

Steady Beat allows Concert Magic songs to be played by simply tapping any key with a constant steady beat, regardless of the song arrangement type.

□ Step 1

Press and hold the CONCERT MAGIC button.

The display will show the current Concert Magic mode (C-1).

□ Step 2

While still holding the CONCERT MAGIC button, use the VALUE button to change the Concert Magic mode to STEADY BEAT (C-2).

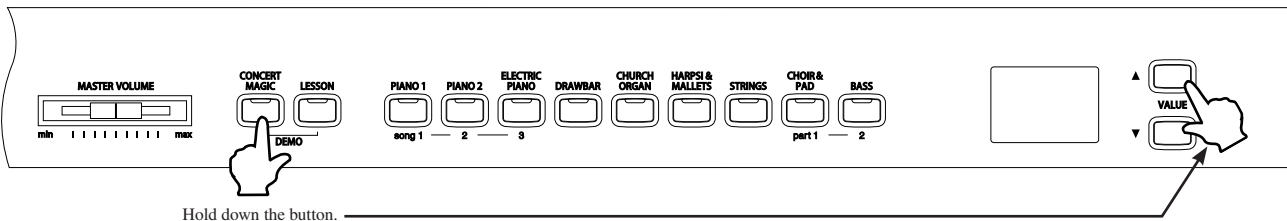

□ Step 3

Start by tapping any key with a constant steady beat.

The tapping speed will set the tempo for the song. Both the accompaniment and melody parts will be played automatically in time with the tapped tempo.

◇ CONCERT MAGIC DEMO MODES

There are three ways to listen to the Concert Magic songs in the DEMO mode.

◆ ALL PLAY

Press the CONCERT MAGIC button and then press the PLAY/STOP button without selecting a song. The CN piano will play back all of the Concert Magic songs in order.

◆ RANDOM PLAY

Press the CONCERT MAGIC button and then press the LESSON button. The CN piano will play back all of the Concert Magic songs in random order.

◆ CATEGORY PLAY

Press and hold the CONCERT MAGIC and LESSON buttons and press the piano key to which the desired song is assigned. The CN piano will play back the selected song and then continue to play the rest of the songs in the same category.

To stop the demo, press the PLAY/STOP button.

◇ CONCERT MAGIC PLAYBACK SPEED

The TEMPO button is also used to adjust the playback speed of Concert Magic songs.

□ Step1

After selecting a Concert Magic song to play back, press and hold the TEMPO button.

The tempo value will be shown in the display.

□ Step2

While holding down the TEMPO button, use the VALUE buttons to change the tempo.

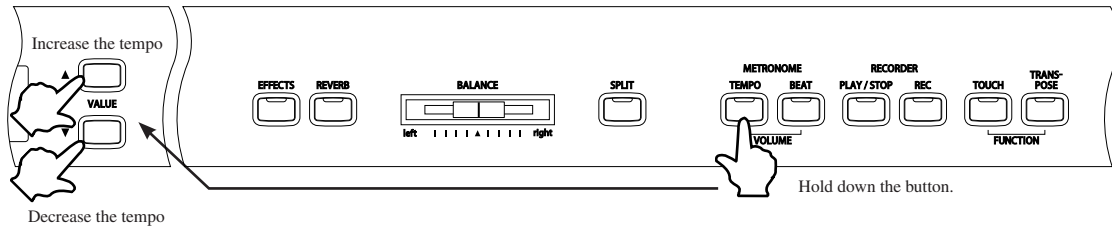

The tempo of the selected Concert Magic song can be adjusted either before play back, or while the song is playing.

9) METRONOME

Rhythm is one of the most important elements when learning music. It is important to practice playing the piano at the correct tempo and with a steady rhythm. The CN piano's metronome tool helps learners to achieve this by providing a steady beat to play along with.

◇ STARTING THE METRONOME

□ Step1

Press the TEMPO button.

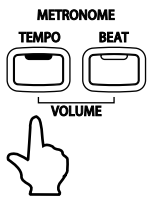

120

The LED indicator for the TEMPO button will turn on and the metronome will begin counting with a steady beat. The tempo in beats per minute will be shown in the display.

□ Step2

Press the VALUE buttons to increase or decrease the tempo within the range of 10 - 300 beats per minute. (20-600 BPM with eighth note rhythms).

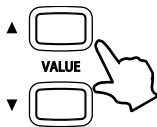

10 ~ 300

□ Step3

Press the TEMPO button again to stop the metronome.

◇ CHANGING THE TIME SIGNATURE

The metronome produces two types of click, with the louder click heard on every fourth beat - this is a 4-beat or 4/4 time signature.

The metronome is capable of providing a down beat to indicate the beginning of the measure.

It is possible to select a different signature where appropriate. There are seven different times signatures available on the CN piano: 1/4, 2/4, 3/4, 4/4, 5/4, 3/8 and 6/8.

□ Step1

Press the BEAT button.

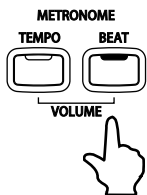

4-4

The LED indicator for the BEAT button will turn on and the metronome will begin counting. The time signature will be shown in the display.

□ Step2

Press the VALUE buttons to select the desired time signature.

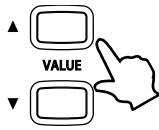

The currently selected time signature will be shown in the display.

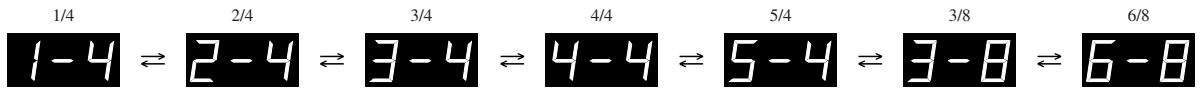

□ Step3

Press the BEAT button again to stop the metronome.

Both the TEMPO button and the BEAT button can be used to turn the metronome on and off, depending on whether the tempo or time signature is being adjusted.

◇ ADJUSTING THE METRONOME VOLUME

The volume level of the metronome can also be adjusted.

□ Step1

Press the TEMPO and BEAT buttons simultaneously.

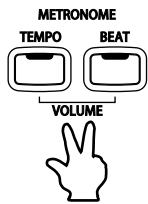

The volume level of the metronome will be shown in the display, represented by numbers ranging from 1 (soft) to 10 (loud). The default metronome volume level is 5.

□ Step2

Press the VALUE buttons to increase or decrease the volume level of the metronome.



□ Step3

Press the TEMPO and BEAT buttons simultaneously again to stop the metronome.

3. LESSON FUNCTION

The CN31's Lesson function helps performers to practice the piano with a collection of etudes from Czerny and Burgmüller, or songs from *Alfred's Basic Piano Library* and *Alfred's Premiere Piano Course* lesson books (USA, Canada, Australia and UK only). It is possible to listen to each etude or song at various tempos, practicing the left and right hand parts separately, before eventually recording a practice session for self-evaluation.

Alfred's Basic Piano Library and *Alfred's Premiere Piano Course* lesson books are sold separately. Please check with local dealers or contact Alfred's customer service by telephoning 818-892-2452 (USA & Canada), 0-95240033 (Australia), +44 (0)1279828960 (UK). Or alternatively, by e-mailing customerservice@alfred.com.

1) SELECTING A BOOK/SONG

□ Step 1

Press the LESSON button.

The LED indicator for the LESSON button will turn on to indicate that lesson mode is enabled.

An alphabet letter and a 2-digit number will be shown in the display. The alphabet letter refers to a song book and the 2-digit number refers to a song number.

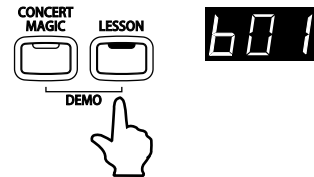

Lesson availability differs according to geographical location:

	Letter	Lesson Book Name
US, Canada, UK, Australia	A	Alfred's Premier Piano Course Lesson 1A
	B	Alfred's Premier Piano Course Lesson 1B
	C	Alfred's Basic Piano Library Lesson Book Level 1A
	D	Alfred's Basic Piano Library Lesson Book Level 1B
Rest of the World	B	Burgmüller: 25 Progressive Pieces, Opus 100
	C	Czerny: 30 Czerny Etudes de Mécanisme, Opus 849

□ Step 2

Press and hold the LESSON button and press the VALUE buttons to change the lesson book type.

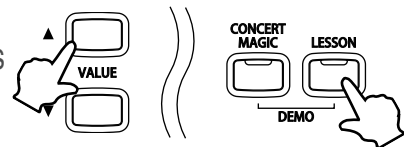

Hold down the button.

□ Step 3

Press the VALUE button (without holding the LESSON button) to change the lesson song.

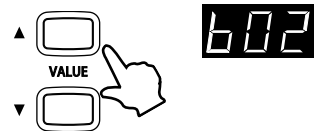

It is also possible to select a song directly by holding down the LESSON button and pressing a key on the keyboard. Please refer to the separate 'Internal Song List' booklet for a complete listing of available lesson songs.

2) LISTENING TO AND PLAYING A SONG

□ Step 1

Press the PLAY/STOP button to play the selected song.

There will be a one bar count-in before the song starts to play.

Press the PLAY/STOP button to stop and reset the song.

If the PLAY/STOP button is pressed again, the song will restart from the beginning.

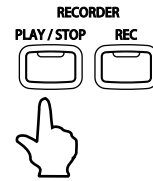

◇ EXITING THE LESSON FUNCTION

□ Step 1

Press the LESSON button.

The LED indicator of the LESSON button will turn off, and the unit returns to the normal operation mode.

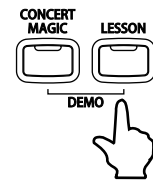

◇ PRACTICING THE LEFT AND RIGHT-HAND PARTS

The volume balance of the left and right-hand parts can be adjusted using the BALANCE slider.

□ Step 1

After selecting a song, move the BALANCE slider to the left or to the right.

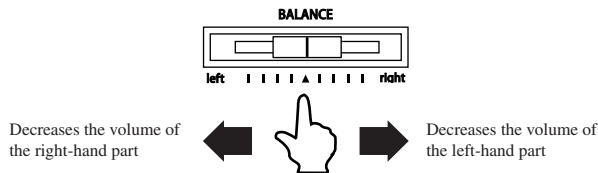

Moving the balance slider partially to the left will gradually decrease the volume of the right-hand part, allowing the right-hand part to be practiced while the pre-recorded part plays softly as a guide. When the balance slider is moved fully to the left, the pre-recorded right-hand part will be muted completely.

◇ ADJUSTING THE TEMPO OF A SONG

□ STEP 1

Press and hold the TEMPO button and press the VALUE ▲ or VALUE ▼ buttons to increase or decrease the tempo of the song.

To reset the tempo to the default speed, select another song.

3) RECORDING A SONG PRACTICE

While in Lesson mode, song practice can be recorded for playback and self-evaluation. The pre-recorded left and right-hand parts will be heard while the song practice is recorded. As noted previously, the BALANCE slider may be used to mute either pre-recorded left or right-hand parts.

□ Step 1

Adjust the BALANCE slider to set the left and right-hand playing volume for the piece to be practiced.

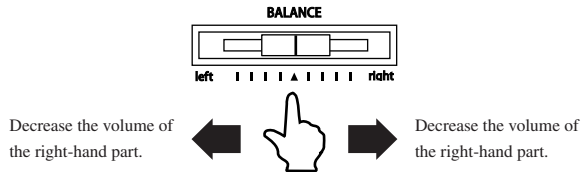

□ Step 2

Press the REC button (while the LESSON button is lit).

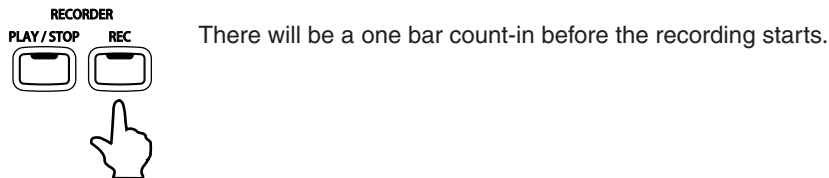

□ Step 3

Press the PLAY/STOP button again to stop the recording and reset the song to the beginning.

Recording will also stop automatically at the end of the lesson song.

◇ PLAYING BACK THE RECORDING

□ Step 1

Press the PLAY/STOP button to listen to the recording.

The performance that has been recorded will be played. The left and right-hand playing volume can be changed using the BALANCE slider.

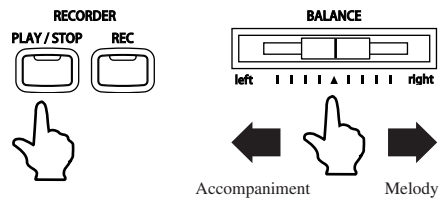

◇ ERASING THE RECORDING

□ Step 1

Press the PLAY/STOP and REC buttons simultaneously to erase the recording.

- Recordings made while using the Lesson Function cannot be saved and are intended for temporary reference only. When changing to another song, exiting the Lesson Function or turning off the CN31 power, Lesson recordings will be erased.
- Preset Lesson songs cannot be permanently overwritten or erased.

4. RECORDER

The RECORDER function records performances in a similar way to that of a tape recorder. However, the CN piano records songs as digital data, instead of audio data - storing the music inside the instrument. Because each song is stored digitally, it is possible to modify various aspects during playback, such as adjusting the tempo without changing the pitch, or selecting different sound types and effects settings. Once fully understood, the recorder function provides an easy to use tool for both practicing and playing the piano.

1) RECORDING (REC BUTTON)

The CN31 allows up to three different songs to be recorded, stored in memory, and played back at the touch of a button. Each song has two separate tracks called 'Parts' that can be recorded independently. This allows the left-hand part to be recorded first on one track, then the right-hand part to be recorded later on the other track, while listening to the first part.

When recording or playing back a song, each part (track) can be re-recorded or played back freely. Attempting to re-record a part will automatically erase all previously recorded performance information for that part, therefore when recording parts separately, it is most important to select the correct part carefully, in order to prevent accidentally overwriting a previously recorded part.

The REC button is used for recording.

The SONG buttons and PART buttons correspond to the SOUND SELECT buttons.

□ STEP 1

Press and hold the REC button, then select a SONG (1, 2 or 3) and PART number (1 or 2).

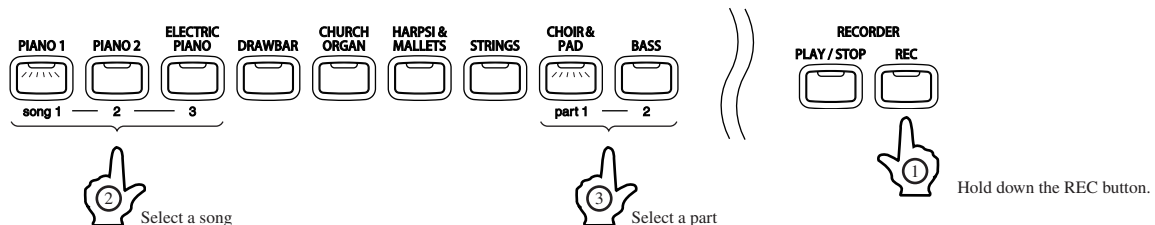

While pressing the REC button, the LED indicators for one SONG button and one PART button will start to flash, indicating the song and the part to be recorded.

During this time, the SONG and PART to be recorded can be changed freely by pressing the desired SONG or PART button.

If no PART is selected PART1 will be selected automatically.

When the REC button is released, the LED indicators for the selected SONG and PART buttons will stop flashing and the LED indicator for the REC button will turn on. This is the Standby state for recording. Furthermore, the LED indicator for the SOUND SELECT button will also turn on, allowing the sound for recording to be changed.

□ Step2

Start to play the piano.

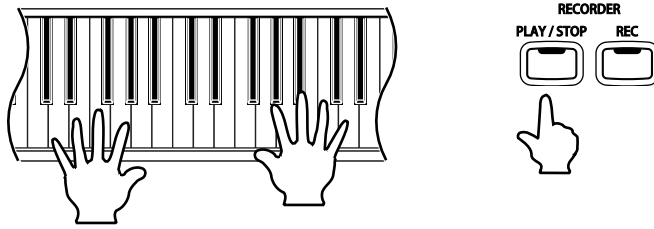

The recorder will automatically start recording with the first note played.

During this time, the LED indicators for the REC and PLAY/STOP buttons will be turned on.

Any changes made to the sound while recording will also be recorded.

The recording can be started by pressing the PLAY/STOP button instead of pressing a key, allowing a blank bar to be inserted at the beginning of a song.

□ Step3

Press the PLAY/STOP button to stop recording.

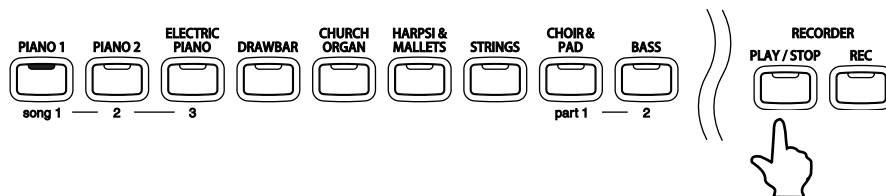

The LED indicators for the PLAY/STOP button and the REC button will turn off and the newly recorded part will be saved to memory automatically.

Saving may take a few moments and during this time the piano will not perform any other operations.

To record the piece again, simply repeat the above procedure. The new recording will completely erase the previous one.

◇ RECORDING A SECOND PART

A second part can be recorded in the second track of the same song. After recording the first part, select the other track and record the second part.

□ Step1

Press and hold the REC button again and press the BASS button to select to record PART2.

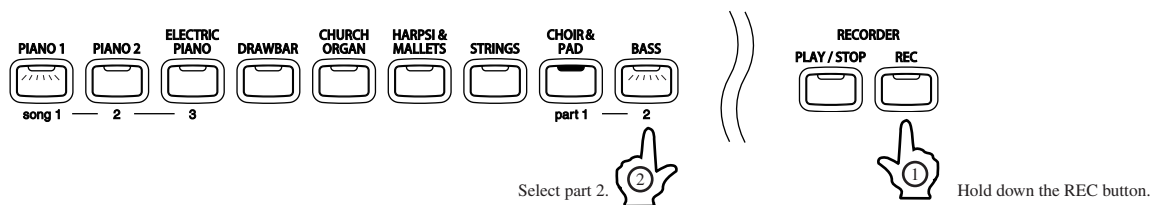

The LED indicators for the SONG1 button and PART2 button will start to flash, indicating that they are selected for recording.

Furthermore, the LED indicator for the PART1 button will now be turned on, indicating that PART1 has already been recorded.

□ Step2

Start to play the piano.

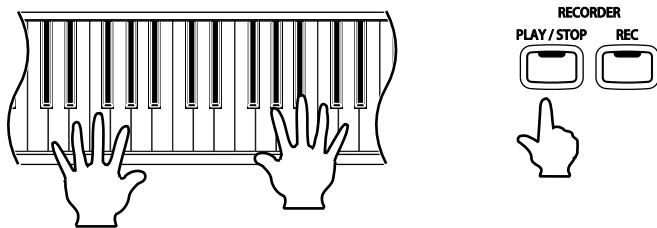

While recording the second part, the previously recorded first part will also play. During this time, the LED indicators for the REC button and PLAY/STOP button will be turned on.

To start playing back the first part and then recording the second part from a certain point, later in the song, press the PLAY/STOP button instead of playing the keyboard to start playback, then begin recording the second part when necessary.

□ Step3

Press the PLAY/STOP button to finish recording.

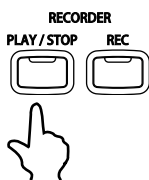

The LED indicators for the PLAY/STOP button and the REC button will turn off and the newly recorded part will be saved to memory automatically.

- The total recording capacity of the CN piano's memory is approximately 15,000 notes, with button and pedal presses also counted as one note.
When the maximum capacity is reached, recording will stop and all music recorded up until that point will be saved to memory automatically.
- Performance data stored inside the CN piano's memory will be saved even after turning off the power.
- It is possible to temporarily turn off (mute) a previously recorded part, for example PART1, before recording a new part, for example PART2. This function can be useful to avoid distraction while recording. To mute PART1, hold the PLAY/STOP button and press the PART1 button, the LED indicator for PART1 will turn off.
- Panel operations stored during recording:
 - Changes made to the sound type.
 - Shifts between DUAL and SPLIT modes.
- Panel operations NOT stored during recording:
 - Changes made to effect settings – the selected effect will be applied to the selected sound type.
 - Changes made to tempo.
 - Changes made using the BALANCE slider in DUAL or SPLIT modes – the volume balance set immediately before recording will be stored, however.
 - Turning the TOUCH CURVE or TRANSPOSE functions ON or OFF – regardless of the transpose settings the performance will be replayed at the pitch originally used for the recording.

2) PLAYING BACK A SONG

The PLAY/STOP button is used to start and stop playback of the recorded song, and to also select which song and part is played.

□ Step 1

Press the PLAY/STOP button to start playing the recorded song.

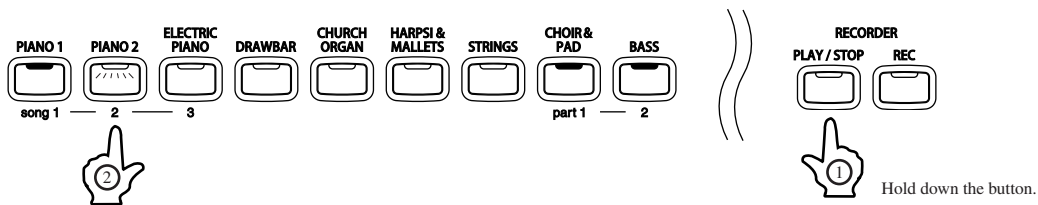

Press the PLAY/STOP button again to stop playback.

To select a different song for playback, hold the PLAY/STOP button and press the SOUND SELECT button that corresponds to the desired song. The song will begin playback when the two buttons are released.

- While the song is being played, performance information is also sent to supported devices as MIDI data (See page 40). PART1 is sent on 1ch and PART2 is sent on 2ch. When recording in DUAL mode, additional information for PART1 is sent on 9ch and additional information for PART2 is sent on 10ch.

◇ PLAYING BACK RECORDED PARTS SEPARATELY

When selecting a song recorded with two parts, it is possible to playback PART1 and PART2 separately.

First hold the PLAY/STOP button. If LED indicators corresponding to PART1 and PART2 turn on, both parts have been recorded successfully. Releasing the PLAY/STOP button will begin playing PART1 and PART2 simultaneously.

□ Step 1

Hold the PLAY/STOP button and press the SOUND SELECT button that corresponds to either PART1 or PART2.

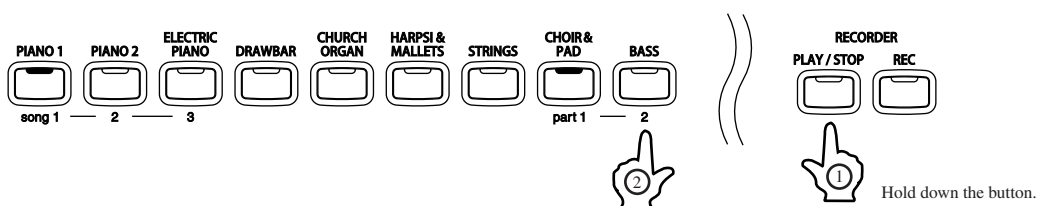

The LED indicator will turn off accordingly, indicating that the part will not be played back.

The song will begin playback when the PLAY/STOP button is released.

3) ERASING A SONG

This function allows any songs that are no longer listened to, to be cleared.

□ Step1

Hold down the REC and PLAY/STOP buttons.

The LED indicators will display which songs have been recorded.

□ Step2

While holding the REC and PLAY/STOP buttons, select the desired song to be erased by pressing the corresponding SOUND SELECT button.

The LED indicator of the selected song will start to flash.

□ Step3

While still holding the REC and PLAY/STOP buttons, select the desired PART to be erased by pressing the corresponding SOUND SELECT button.

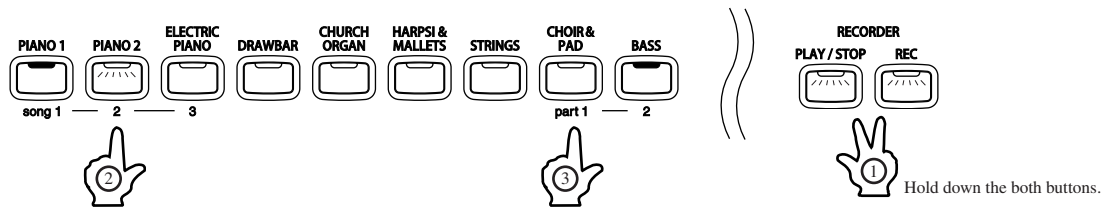

The LED indicator of the selected PART will turn off, indicating that the part has been erased.

In the diagram above, PART1 of Song 2 is erased.

When both PART1 and PART2 of a song are erased, the song becomes empty. Selecting the song only, without selecting PART1 and/or PART2, will not erase it.

- Repeat the steps above in order to erase a number of songs and parts.
- To erase all songs from memory at once, first turn off the power and then turn it on again, holding down both the REC button and the PLAY/STOP button.

5. FUNCTION BUTTONS

The function buttons are responsible for controlling advanced parameters within the CN31, including Tuning, Temperament, MIDI Channel, Transmit Program Change On/Off, Local On/Off, Multi-timbral Mode, Channel Mute, Program Change Number, Lower Octave Shift and Lower Pedal On/Off.

◇ ENTERING A FUNCTION MODE

□ Step 1

Hold down the TOUCH and TRANSPOSE buttons and press one of the SOUND SELECT or EFFECT buttons.

The functions are assigned as listed below.

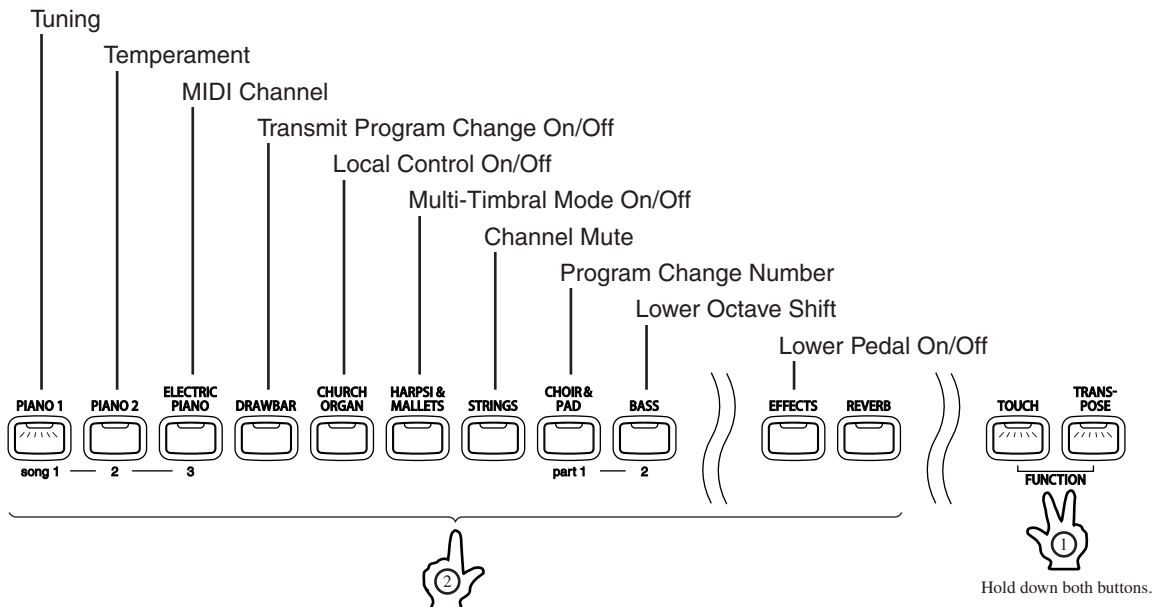

The LED indicator of the corresponding button will start to flash, indicating that the function is selected.

◇ EXITING A FUNCTION MODE

□ Step 1

Press any of the SOUND SELECT buttons or either the TOUCH or TRANSPOSE button.

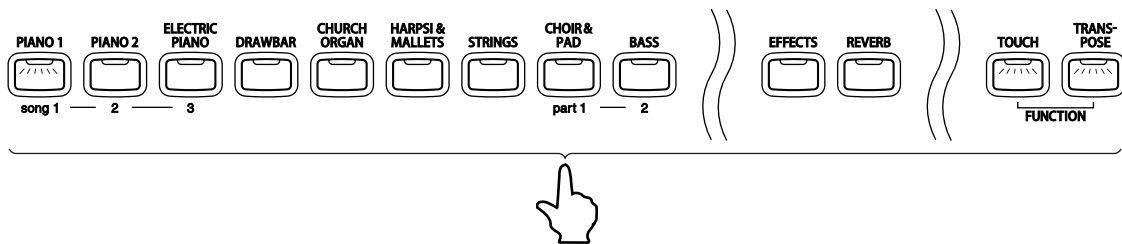

The LED indicator of the button will stop flashing and return to its normal state.

When the power is turned off, settings will be reset to the factory default value.

1) TUNING

The TUNING function allows the piano's pitch to be finely adjusted, and may prove useful when playing with other instruments.

□ Step 1

Hold down the TOUCH and TRANSPOSE buttons and press the PIANO 1 button.

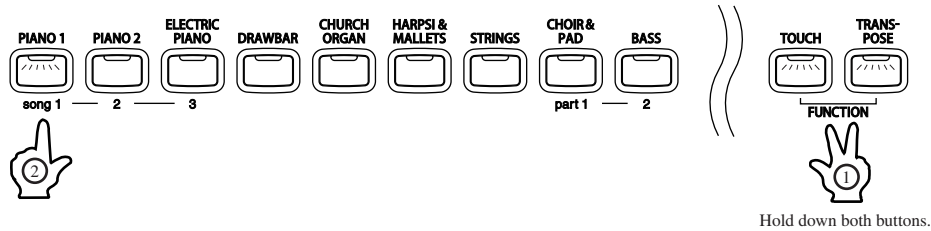

The display will alternate between showing 'tun' (Tuning) and a number representing the pitch for 'A' in Hz (Hertz).

□ Step 2

Use the VALUE buttons to raise or lower the pitch.

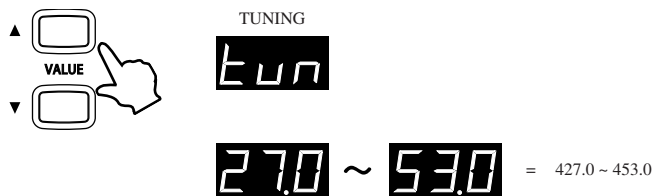

The pitch will increase or decrease by 0.5 Hz increments each time one of the VALUE buttons is pressed.

The range of adjustment is from 427.0 to 453.0 Hz (displayed as 27.0 – 53.0).

The factory default value is set to the modern standard A = 440.0 Hz (displayed as 40.0).

- When pressing a key while using tuning mode, the sound that was selected prior to entering tuning mode will be heard. To use a different sound whilst tuning, first exit the tuning mode, select the desired sound, then repeat 'Step 1' and 'Step 2' again.
- When the power is turned off, tuning settings will reset to the factory default value of 440.0 Hz (displayed as 40.0).

2) TEMPERAMENT

The CN piano offers immediate access to a variety of musical temperaments popular during the Renaissance and Baroque periods. It may prove interesting and educational to experiment with different temperaments, other than the modern 'equal temperament' standard this is dominant in music today.

BRIEF EXPLANATION OF TEMPERAMENTS

<p>EQUAL TEMPERAMENT (PIANO ONLY)</p>	<p>This is the default temperament. If a piano sound is selected the tuning is stretched like an acoustic piano (EQUAL TEMPERAMENT). If any other type of sound is selected the tuning will be EQUAL (FLAT). An explanation of EQUAL TEMPERAMENT and EQUAL TEMPERAMENT (FLAT) is provided later in this section.</p> <p>If a piano sound is used in a layer with any other sound, then both sounds will use the EQUAL TEMPERAMENT (stretched) tuning.</p>
<p>MERSENNE PURE TEMPERAMENT (MAJOR)</p> <p>MERSENNE PURE TEMPERAMENT (MINOR)</p>	<p>This temperament, which eliminates dissonances for thirds and fifths, is still popular for choral music because of its perfect harmony.</p> <p>Performers must be aware which key they are playing in when using this temperament.</p> <p>Any key modulation will result in dissonances. When playing music in a particular key, the key of the temperament must also be correctly matched.</p> <p>When playing in a major key select Pure (Major) and when playing in a minor key select Pure (minor).</p>
<p>PYTHAGOREAN TEMPERAMENT</p>	<p>This temperament, which uses mathematical ratios to eliminate dissonance for fifths, is very limited for use with chords, but it produces very characteristic melodic lines.</p>
<p>MEANTONE TEMPERAMENT</p>	<p>This temperament, which uses a mean between a major and minor whole tone to eliminate dissonance for thirds, was devised to eliminate the lack of consonances experienced with certain fifths for the Mersenne pure temperament. It produces chords that are more beautiful than those with the equal temperament.</p>
<p>WERCKMEISTER III TEMPERAMENT</p> <p>KIRNBERGER III TEMPERAMENT</p>	<p>These two temperaments are placed in between Meantone and Pythagorean. For music with few accidentals, this temperament produces the beautiful chords of the mean tone, but as accidentals increase, the temperament produces the characteristic melodies of the Pythagorean temperament. It is used primarily for classical music written in the Baroque era to revive the original characteristics.</p>
<p>EQUAL TEMPERAMENT (FLAT)</p>	<p>This is an 'unstretched' equal temperament that divides the scale into twelve equal semitones. This produces the same chordal intervals in all twelve keys, and has the advantage of limitless modulation of the key. However the tonality of each key becomes less characteristic and no chord is in pure consonance.</p>
<p>EQUAL TEMPERAMENT</p>	<p>This is the most popular piano temperament. The hearing ability of a human is uneven and is not as accurate with high frequency and low frequency as it is with the middle range. This temperament's tuning is stretched to compensate for this so the sound will be heard naturally to the ears. This 'stretched' equal temperament is a practical variation of the 'unstretched' equal temperament which was invented on a mathematical basis.</p>

□ Step 1

Hold down the TOUCH and TRANSPOSE buttons and press the PIANO 2 button.

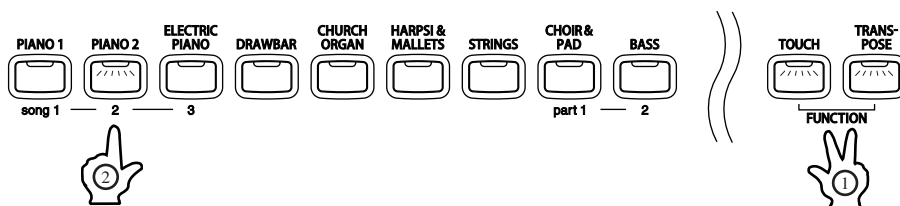

Hold down both buttons.

The display will alternate between showing 'tMP' (Temperament) and a symbol to indicate which type of temperament is in use.

□ Step2

Use the VALUE buttons to change the type of temperament.

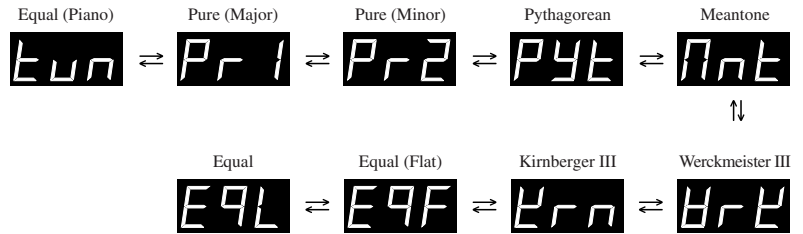
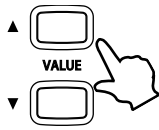

When the power is turned off, the temperament will reset to the factory default 'equal temperament (piano only)' type.

If a piano sound is selected when using the factory default 'equal temperament (piano only)' type, the tuning is stretched like an acoustic piano (EQUAL TEMPERAMENT). If any other type of sound is selected, the tuning will be EQUAL (FLAT).

- After selecting the desired temperament, please read the following section on selecting a key signature for the temperament before continuing.

◇ KEY SIGNATURE OF TEMPERAMENT

Limitless modulation of the key became available only after the invention of equal temperament. When using a temperament other than equal temperament, care must be taken to choose the key signature to play in. For example, if the song to be played is written in D major, 'D' would be chosen as the temperament key.

□ Step1

Press one of the 88 piano keys to select the key signature of the temperament.

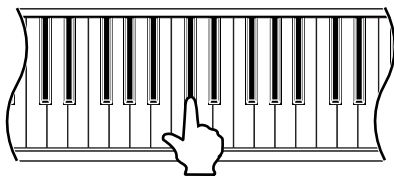

The note name of the key pressed will be shown in the display and chosen as the key of the temperament.

- Changing the key of the temperament will only change the 'balance' of the tuning, the pitch of the keyboard will remain unchanged. Use the TUNING or TRANSPOSE functions to change the pitch of the whole keyboard.
- The key of the temperament function will have no effect when equal temperament is selected.

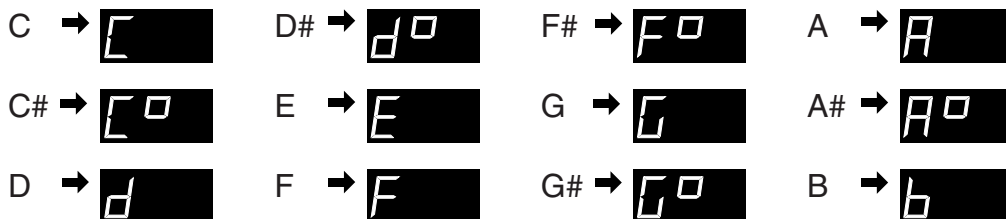

◇ MIDI OVERVIEW

The term MIDI is an acronym for Musical Instrument Digital Interface, an international standard for connecting synthesizers, sequencers (MIDI recorders) and other electronic instruments so that they can exchange performance data.

The CN31 is equipped with two MIDI jacks for exchanging data: MIDI IN and MIDI OUT. Each uses a special cable with a DIN connector.

- MIDI IN : For receiving note, program change and other data.
- MIDI OUT : For sending note, program change and other data.

MIDI uses channels to exchange data back and forth between MIDI devices. There are receive (MIDI IN) and transmit (MIDI OUT) channels. Most musical instruments or devices with MIDI functions are equipped with both MIDI IN and OUT jacks and are capable of transmitting and receiving data via MIDI.

The receive channels are used to receive data from another MIDI device and the transmit channels are used to transmit data to another MIDI device.

■ Connection to an external sequencer

When connected as shown in the illustration below, songs played on the CN31 can be recorded using a MIDI recorder, with preset sounds (such as piano, harpsichord and vibraphone, etc.) controlled by the CN31's MULTITIMBRAL MODE function to create a multi-layer MIDI recording.

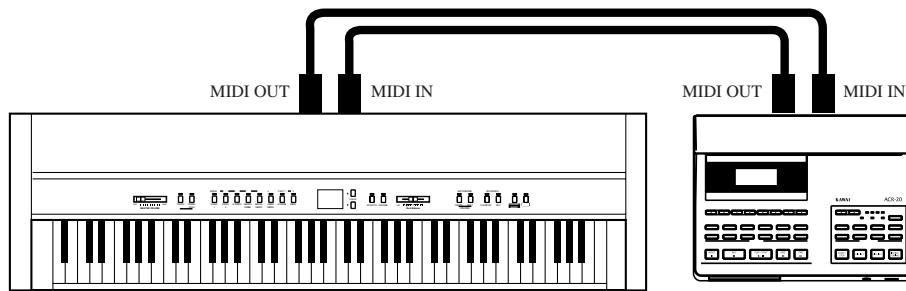

◇ CN31 MIDI functions

Transmit / receive keyboard note information	By transmitting MIDI data from the CN piano (MIDI out) a MIDI-connected keyboard can be played from the CN piano. Or alternatively, by receiving data (MIDI IN), the CN piano can be played from another MIDI-connected keyboard or device.
Transmit / receive channel setting	Specify transmit/receive channels within the range of 1 to 16.
Transmit / receive Program change (sound type) number	Transmit/receive program change data to/from a MIDI-connected musical instrument or device.
Transmit / receive pedal data	Transmit/receive sustain pedal and sustain pedal data from a MIDI-connected musical instrument or device. Sostenuto pedal data can also be transmitted.
Receive volume data	The CN piano will respond to MIDI volume data sent from a MIDI-connected musical instrument or device.
Multi-timbral setting	The CN piano is able to receive multiple channel MIDI data from a MIDI-connected musical instrument or device, when multi-timbral mode is turned on.
Transmit / receive exclusive data	Transmit/receive front panel or menu function settings as exclusive data.
Transmit recorder playback data	Songs recorded using the recorder can be played back from a MIDI-connected musical instrument or recorded by an external sequencer via the MIDI OUT jack.

Please refer to the 'MIDI implementation chart' (page 55) for further information regarding the CN31's MIDI functions.

3) MIDI CHANNEL

This function is used to determine on which MIDI channel the CN piano will exchange MIDI information with external MIDI devices and instruments or a personal computer.

The selected channel will function as both the transmit and receive channel.

□ Step1

Hold down the TOUCH and TRANSPOSE buttons and press the ELECTRIC PIANO button.

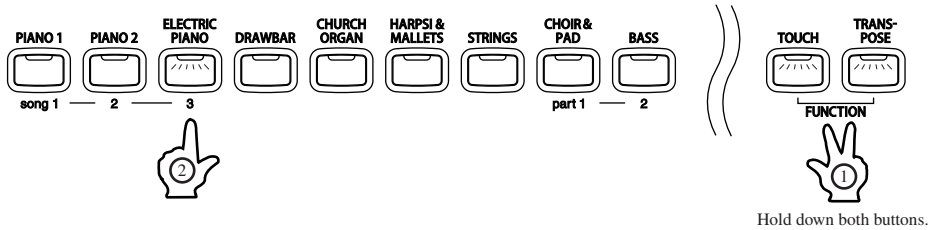

The display will alternate between showing 'Chn' (Channel) and the channel number. The default channel is 1.

□ Step2

Use the VALUE buttons to change the channel number.



The channel number can be set from 1 to 16.

- The CN piano's MIDI channel setting defaults to receiving MIDI channel information from all channels, 1 to 16. each time the power is turned on. This is called 'omni mode on'. The CN piano will switch to 'omni mode off' when a specific channel is selected using the MIDI channel function, and data will only be received on that specified channel. In order to specify channel 1 in the 'omni mode off' state, first select channel 2, then select channel 1.

4) TRANSMIT PROGRAM CHANGE ON/OFF

This function determines whether or not the CN piano will transmit program change information when pressing the SOUND SELECT buttons. When transmit program change is turned on, pressing the SOUND SELECT buttons will send the program change numbers as listed below.

Sound Button	Sound Name	Multi-Timbral mode			
		Off, On1	On2		
		Prog #	Bank MSB	Bank LSB	Prog #
PIANO 1	Concert Grand	1	121	0	1
	Studio Grand	2	121	1	1
	Mellow Grand	3	121	2	1
	Jazz Grand	4	95	8	1
PIANO 2	Modern Piano	5	121	0	2
	Honky Tonk	6	121	0	4
	Rock Piano	7	121	1	2
	New Age Piano	8	95	9	1
ELECTRIC PIANO	Classic E.Piano	9	121	0	5
	Modern E.P.	10	121	0	6
	60's E.P.	11	121	3	5
	Modern E.P. 2	12	121	1	6
DRAWBAR	Jazz Organ	13	121	0	18
	Drawbar Organ	14	121	0	17
	Drawbar Organ 2	15	121	1	17
	Be 3	16	95	2	17
CHURCH ORGAN	Church Organ	17	121	0	20
	Diapason	18	95	7	20
	Full Ensemble	19	95	1	21
	Diapason Oct	20	95	6	20
HARPSI & MALLETS	Harpsichord	21	121	0	7
	Harpsichord 2	22	121	3	7
	Vibraphone	23	121	0	12
	Clavi	24	121	0	8
STRINGS	Slow Strings	25	95	1	45
	String Pad	26	95	8	49
	Warm Strings	27	95	1	49
	String Ensemble	28	121	0	49
CHOIR & PAD	Choir	29	121	0	53
	Choir 2	30	95	53	54
	New Age Pad	31	121	0	89
	Atmosphere	32	121	0	100
BASS	Wood Bass	33	121	0	33
	Finger Bass	34	121	0	34
	Fretless Bass	35	121	0	36
	W. Bass & Ride	36	95	1	33

In addition to the SOUND SELECT buttons, other button operations such as touch curve, dual, digital effects and reverb settings can be transmitted as MIDI exclusive data when the corresponding buttons are pushed. When set to off, no program change or other panel information will be transmitted via MIDI.

□ Step 1

Hold down the TOUCH and TRANSPOSE buttons and press the DRAWBAR button.

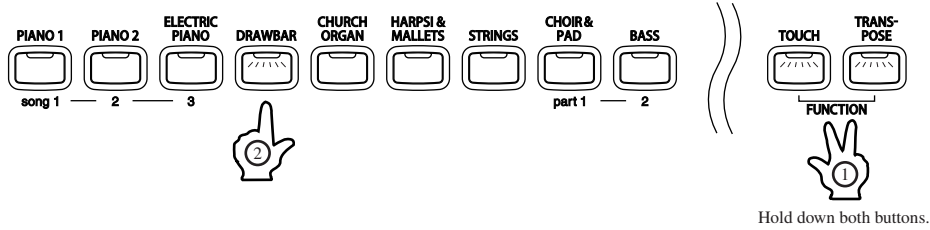

The display will alternate between showing 'PGM' (Program) and on/off status. The default is on.

□ Step 2

Use the VALUE buttons to toggle transmit program change on and off.

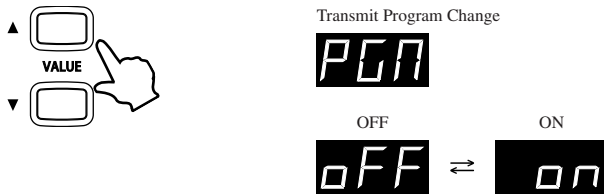

Program change numbers will also be transmitted when multi-timbral mode is on.

When using DUAL mode, on/off information and sound type settings are transmitted as exclusive data, but program change numbers will not be transmitted.

The CN piano's transmit program change setting defaults to 'ON' each time the power is turned on.

5) LOCAL CONTROL ON/OFF

This function determines whether the CN piano's sound will be played from the piano's keyboard ('ON') or only from an external MIDI instrument ('OFF'). Even with local control set to 'OFF' the piano's keyboard will still transmit to external MIDI devices and instruments or a personal computer.

□ Step1

Hold down the TOUCH and TRANSPOSE buttons and press the CHURCH ORGAN button.

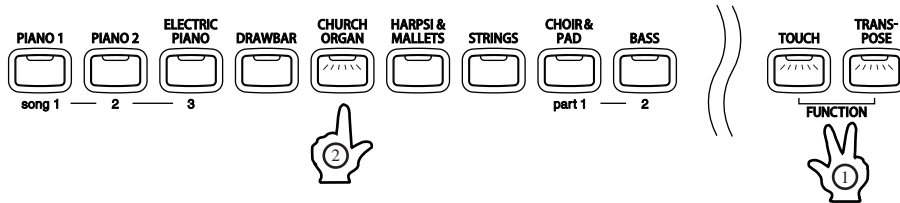

Hold down both buttons.

The display will alternate between showing 'Lcl' (Local) and on/off status. The default is on.

□ Step2

Use the VALUE buttons to toggle local control on and off.

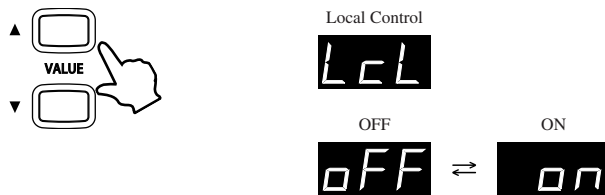

- When local control is set to 'OFF', there will be no sound heard when the keys are pressed.
- The CN piano's local control setting defaults to 'ON' each time the power is turned on.

6) MULTI-TIMBRAL MODE ON/OFF

This function allows the CN piano to receive data on more than one MIDI channel simultaneously. In this mode, the CN piano can play different musical parts with different sounds for each part.

With multi-timbral mode enabled, an external sequencer can be used to enjoy an ensemble performance playing multiple sound types (multi-timbral) on a single CN piano.

◆ Multi-Timbral On (On1 and On2)

This turns on the flexible 16 part multi-timbral capability. Individual MIDI channels can be turned on and off, and assigned any preset sound. The preset sound for each MIDI channel can be changed when the program change number for the desired sound is received from external MIDI device and instruments or a personal computer. The CN piano's normal program change numbers are assigned in On1 (Please see page 42 for a list of the program change numbers), and General MIDI program change numbers are assigned in On2.

◆ Multi-Timbral Off

This turns off the multi-timbral capability. Only one MIDI channel will be active and only the sound currently selected will be heard when a MIDI signal is received.

□ Step 1

Hold down the TOUCH and TRANSPOSE buttons and press the HARPSI & MALLETS button.

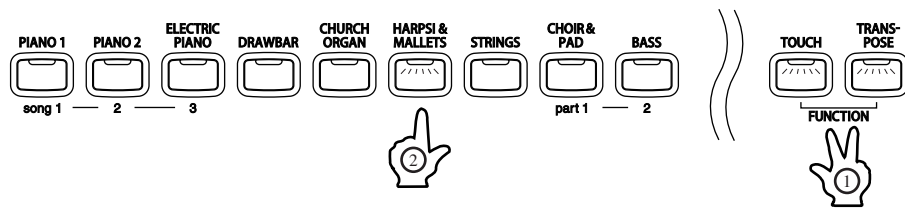

Hold down both buttons.

The display will alternate between showing 'MLt' (Multi) and on/off status. The default is off.

□ Step 2

Use the VALUE buttons to toggle multi-timbral on1, on2 and off.

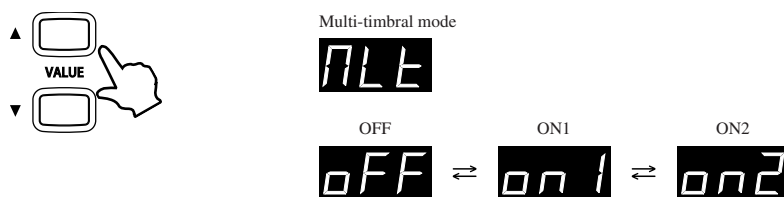

When the multi-timbral mode is OFF and MIDI information is received, only the currently selected preset sound will be heard.

When the multi timbral mode is ON, the preset sound that is heard corresponds to any program change number that was received from external MIDI devices and instruments or a personal computer. This sound may be different from the preset sound that is currently selected using the SOUND SELECT buttons on the panel.

When multi-timbral mode is ON, the ON/OFF setting for each individual MIDI receive channel can also be set (See page 46).

- The CN piano's multi-timbral mode defaults to 'OFF' each time the power is turned on.

7) CHANNEL MUTE

This function determines which MIDI channels are activated to receive MIDI information when multi-timbral mode is set to ON. Each of the 16 channels can be individually activated or deactivated.

□ Step1

Hold down the TOUCH and TRANSPOSE buttons and press the STRINGS button.

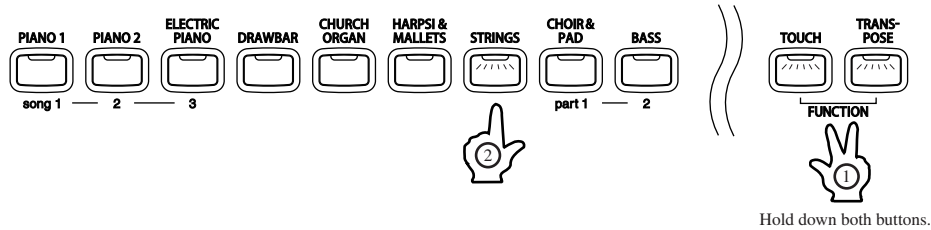

The display will alternate between showing 'P01' (Play 01) and 'On', indicating that the channel 1 is activated.

■ When multi-timbral mode is set to OFF, the 'channel mute' function can not be selected.

□ Step2

Use the VALUE buttons to toggle channel mute on and off.

To turn the other channels on and off, use the 16 left-most white keys to select a desired channel. The display will change to indicating the selected channel. Then use the value buttons to toggle channel mute on and off.

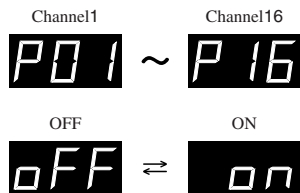
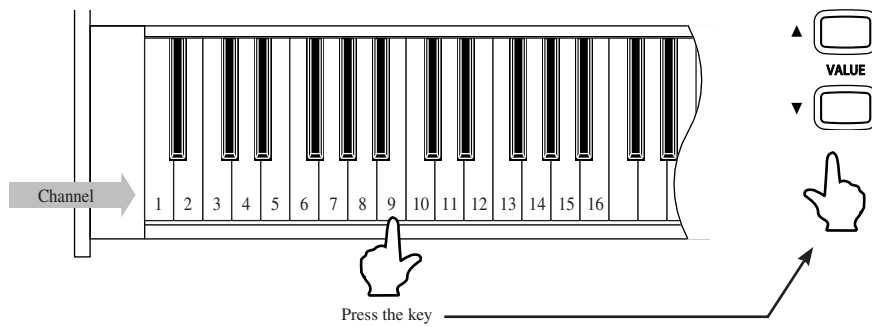

- When changing the channel mute settings, no sound will be heard when the keys are pressed to select the individual channels.
- When the multi-timbral mode is first turned ON after the power has been turned on, all MIDI receive channels 1-16 will be set to 'ON'. This is the default setting.

8) SENDING PROGRAM CHANGE NUMBERS

This function allows the CN piano to send program change numbers beyond the 32 pre-defined numbers transmitted by the SOUND SELECT buttons. Using this function, any number from 1 to 128 can be sent.

□ Step 1

Hold down the TOUCH and TRANSPOSE buttons and press the CHOIR & PAD button.

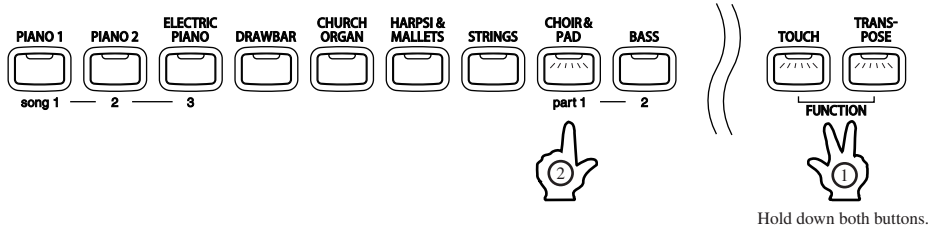

The display will alternate between showing 'PG#' (Program #) and a program change number.

□ Step 2

Use the VALUE buttons to change the program change number.



□ Step 3

Press both VALUE buttons simultaneously to send the program change number.

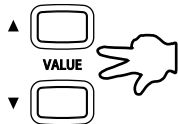

9) LOWER OCTAVE SHIFT

This function allows the lower part to be raised by one, two, or three octaves when using SPLIT mode.

□ Step 1

Hold down the TOUCH and TRANSPOSE buttons and press the BASS button.

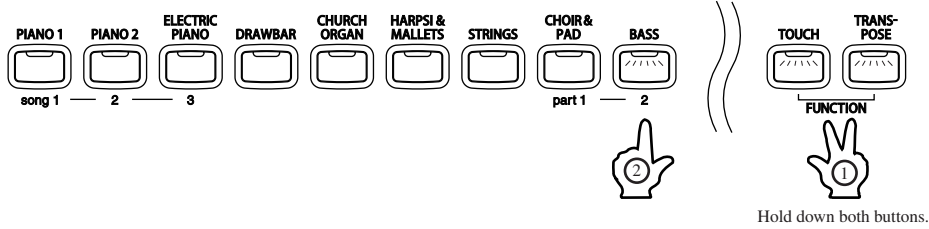

The display will alternate between showing 'Lot' (Lower Octave) and a number, representing how many octaves the lower part is shifted up.

□ Step 2

Use the VALUE buttons to set the desired lower octave shift range.

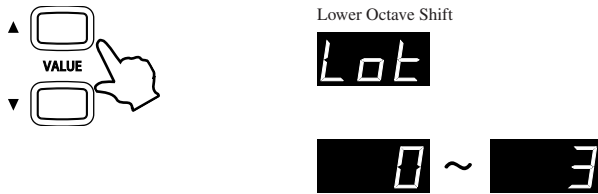

Lower Octave Shift can be set from 0 to 3.

- The CN piano's lower octave shift setting defaults to '0' each time the power is turned on.

10) LOWER PEDAL ON/OFF

This function determines if the sustain pedal will be active for lower part sound when in SPLIT mode. The default setting is off, which means the sustain pedal is not active for lower part sound.

The sustain pedal will still be active for the upper sound.

□ Step1

Hold down the TOUCH and TRANSPOSE buttons and press the EFFECTS button.

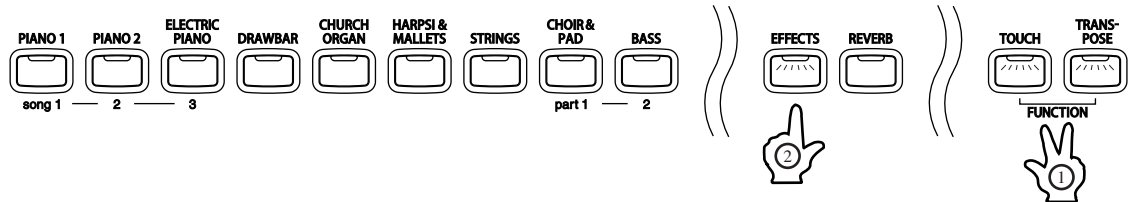

Hold down both buttons.

The display will alternate between showing 'LPd' (Lower Pedal) and on/off status. The default is off.

□ Step2

Use the VALUE buttons to toggle lower pedal on and off.

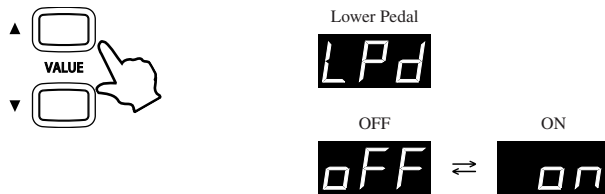

- The CN piano's lower pedal setting defaults to 'OFF' each time the power is turned on.

6. APPENDICES

◇ CONNECTING TO OTHER DEVICES

⚠ Caution • Do not directly connect the LINE IN and LINE OUT jacks of the CN31 together with a cable. An audio loop (oscillation sound) will occur, resulting in damage to the unit.

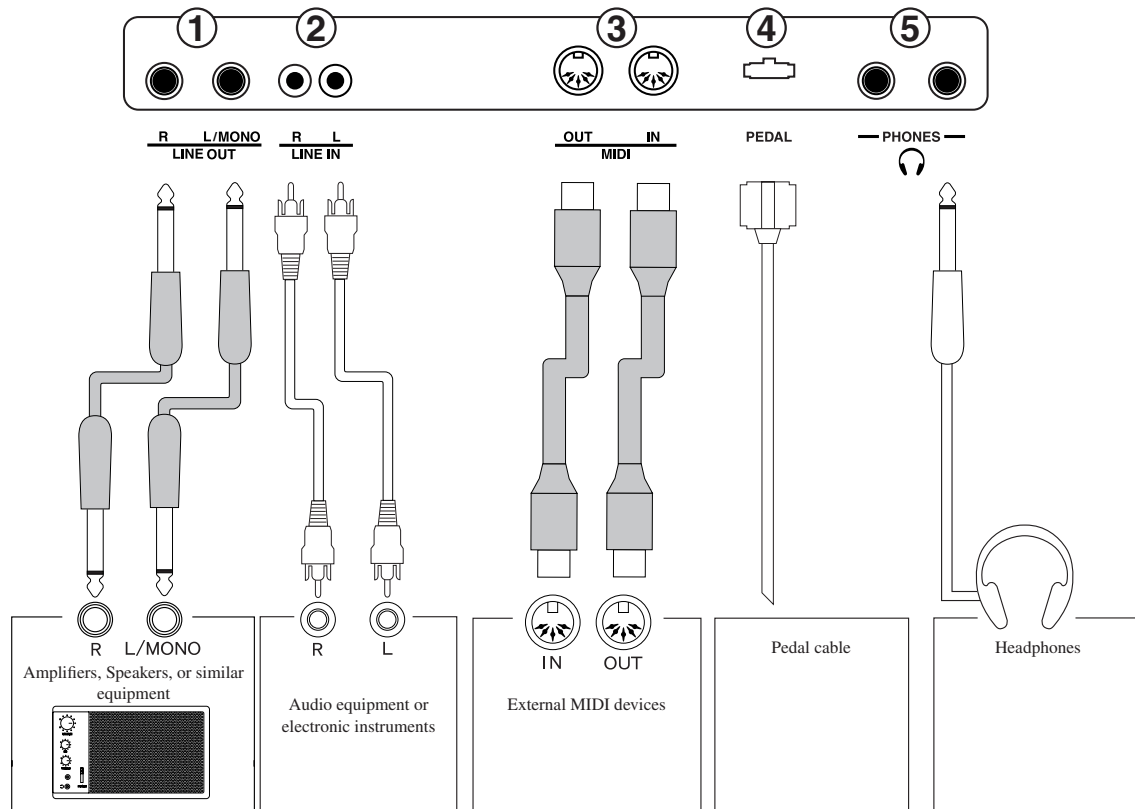

① LINE OUT JACKS

These jacks provide stereo output of the CN31 piano's sound to amplifiers, tape recorders or similar equipment. The audio signal coming through the LINE IN jacks is also routed to these jacks. The CN31 piano's sound is mixed with the LINE IN signals.

The CN31 piano's VOLUME slider controls the output level of its own sound without affecting the level of the LINE IN signal.

② LINE IN JACKS

These jacks are used to connect a pair of stereo outputs from other audio equipment or electronic instruments to the CN31 piano's speakers. The audio signal coming through these jacks bypasses the CN31 piano's volume control. To adjust the volume level, use the output control of the external device.

③ MIDI JACKS

These jacks are used to connect external MIDI devices with the CN piano. There are two terminals: MIDI IN and MIDI OUT.

④ PEDAL JACK

Connect the pedal cord from the pedal board to this jack.

⑤ HEADPHONE JACKS

There are two headphone jacks located on the left underside of the piano.

The piano's sound and any audio signal that is connected to the LINE IN jacks will be heard through the headphones.

◆ ASSEMBLY INSTRUCTIONS

- ⚠ Caution**
- Ensure that this instruction manual is read thoroughly before attempting to assemble the CN piano, and that two or more people work on assembly.
 - It may be necessary to tilt the unit by 90 degrees while assembling the CN piano. During this time, ensure that hands are not caught in the piano, keyboard lid, or score stand, and that the piano is not dropped on an individual's feet.

■ PARTS PROVIDED

Before attempting to assemble the CN piano unit, ensure that all parts are included. A Phillips-head screwdriver will also be required to assemble the unit (not included).

- (A) Piano (x 1)
- (B) Pedal board (x 1)
- (C) End panel (x 1 each for left and right)
- (D) Back panel (x 1)
- (E) Adjuster bolt (x 1)
- (F) Screw: $\phi 4 \times 16$ (x 4)
- (G) Screw: $\phi 4 \times 20$ (x 4)
- (H) Screw: $\phi 4 \times 30$ (x 2)
- (I) Screw: M6 x 25 (x 4)
- (J) Cord clamp (x 2)
- (K) Headphone hook and screws (x 1 set)
- (L) Power cord (x 1)

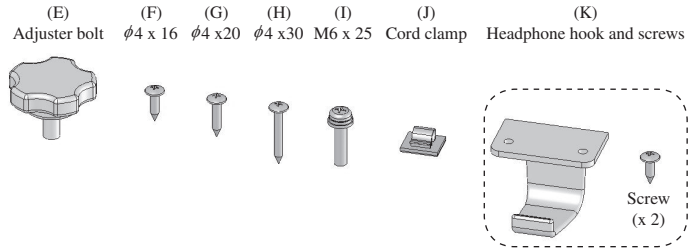

■ ASSEMBLY SEQUENCE

- ⚠ Caution**
- Be careful not to scratch or damage the floor, piano, or stand at the time of assembly.

1. Screw the adjuster bolt (E) into the threaded screw hole provided on the pedal.
2. From the side of the screw that is already on the backside of the pedal board (B), slide and insert the bracket of the end panel (C).
3. While pressing the end panel (C) against the pedal board (B), tighten the already-provided screws, one each on the left and right sides, and then tighten two screws (F) on each side.
4. Untie and pull out the pedal cable.
5. Set the back panel (D) and tighten the screws (G) (H) into the prepared holes. Loosely tighten the screws with the * symbol.

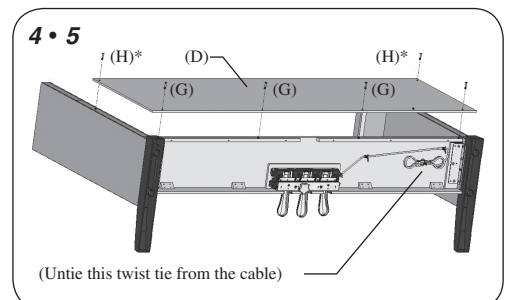
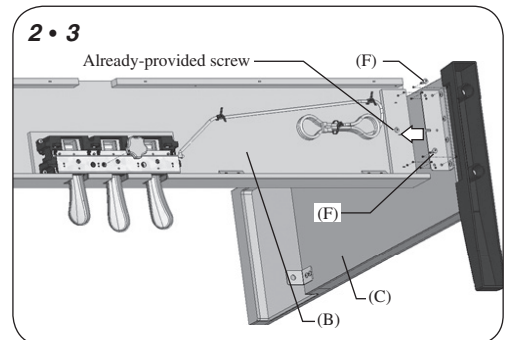
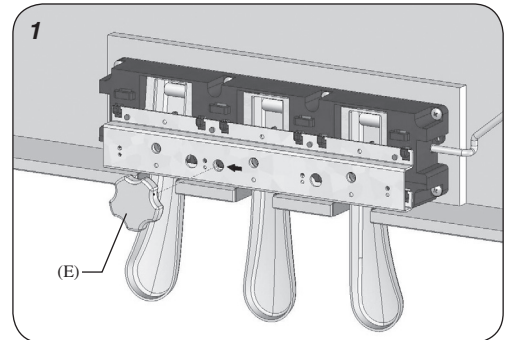

6. Place the stand so that the backside of the stand assembly rests against a wall, and then slowly and carefully insert the piano. Ensure that more than two people work on the assembly. If attempting to insert the piano without resting the stand against a wall, support the back of the stand using your foot or leg to prevent the stand from sliding backwards.

⚠ Caution • Ensure that the piano is not dropped on an individual's feet, and that fingers, hands and feet are not caught in the piano.

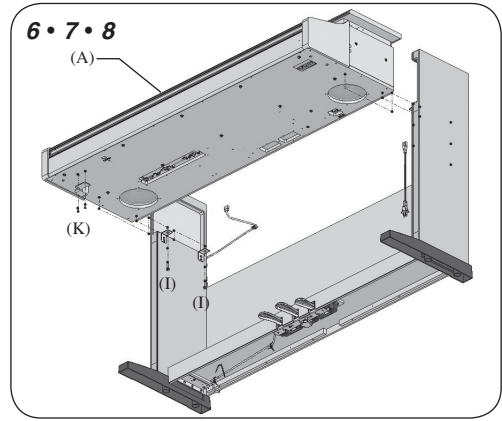

7. Press the end panel (C) of the stand to the piano (A), and then fasten the piano (A) to the stand with four screws (I).

⚠ Caution • Ensure that the piano and the stand are securely fastened together with the screws, preventing the possibility of the piano falling.

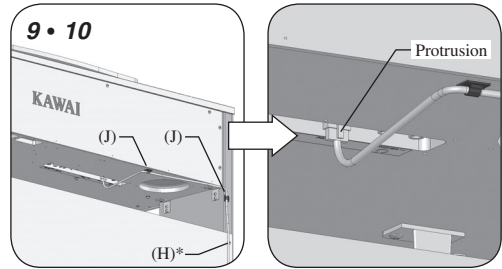

8. Fix the headphone hook and screws (K).
*If the headphone hook will not be required, it can be kept with the instruction manual.

9. Raise the unit and tightly fasten the loosely fastened screws (H) with the * symbol.

10. Insert the connector of the pedal cord into the receptacle, and fix the cord with the cord clamp (J) (make sure that the protrusion of the connector is facing the correct direction, and insert the connector straight).

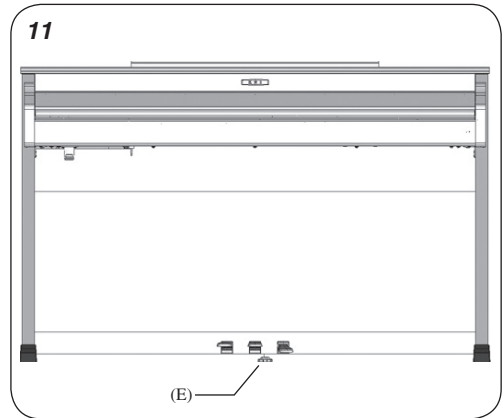

11. Turn the adjuster bolt (E) at the bottom of the pedal stand until the bolt firmly touches the floor and supports the pedal board.

⚠ Caution • Ensure that the adjuster bolt (E) firmly touches the floor, supporting the pedal board and preventing damage. When moving the piano, remove the adjuster bolt (E) and readjust after moving has been completed.

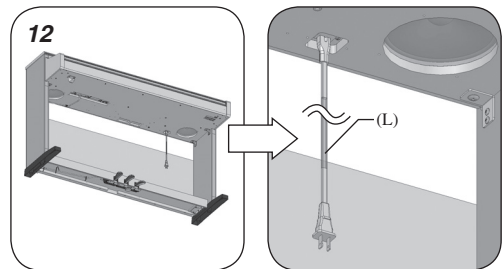

12. Insert the power cord (L) into the piano.

13. Remove the protective film from the display.

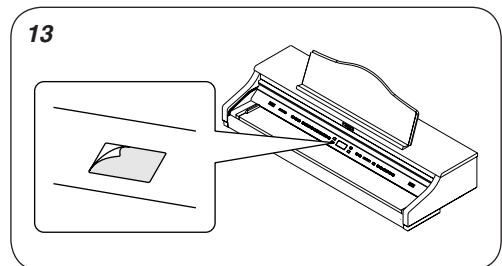

Assembly is now complete.

◇ SPECIFICATIONS

■ Keyboard	88 Weighted Keyboard with Advanced Hammer Action IV
■ Polyphony	Maximum 96
■ Number of Sound	36
■ Sound Categories	Piano 1, Piano 2, Electric Piano, Drawbar, Church Organ, Harpsi&Mallets, Strings, Choir&Pad, Bass
■ Effects	Reverb (Room1/2, Stage, Hall1/2), Chorus, Tremolo, Delay (1/2/3), Rotary (1/2)
■ Temperaments	Equal (Piano Only), Mersenne pure (Major), Mersenne pure (minor), Pythagorea, Meantone, Werckmeister III, Kirnberger III, Equal (flat), Equal
■ Other Features	Demo (27 Preset Songs), Concert Magic (88 Preset Songs), Volume, Dual, Split, Balance Slider, Transpose, Tune, Lower Octave Shift, Lower Pedal On/Off, Touch Curve (Light 1, Light 2, Normal, Heavy 1, Heavy 2, Off), MIDI (16 part multi-timbral capability)
■ Lesson Function	Right/left part balance adjustable, Tempo adjustable. Please refer to the separate 'Internal Song List' booklet for a complete listing of available lesson songs.
■ Recorder	2 Tracks, 3 Songs. The total memory capacity of the recorder is approximately 15,000 notes.
■ Metronome	Beat: 1/4, 2/4, 3/4, 4/4, 5/4, 3/8, 6/8
■ Pedals	Sustain, Sostenuto, Soft
■ Jacks	Headphones (2), LINE IN (L, R), LINE OUT (L/MONO, R), MIDI (IN, OUT)
■ Output Power	16 W x 2
■ Speakers	16 cm x 2
■ Key Cover	Slide type
■ Power Consumption	50 W
■ Dimensions WxDxH (with music rack flattened)	139cm x 48cm x 89cm
■ Weight	52 kg

◇ MIDI EXCLUSIVE DATA FORMAT

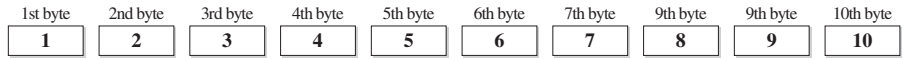

- 1 F0Start code
- 2 40.....KAWAI's ID number
- 3 00 - 0FMIDI channel
- 4 10, 30.....Function code (30 when setting MULTI TIMBRE ON/OFF)
- 5 04.....Indicates that the instrument is Electronic Piano
- 6 02.....Indicates that the piano is one of 'CA' or 'CN' series
- 7 data 1
- 8 data 2.....(See the table below.)
- 9 data 3
- 10 F7End code

data 1	data 2	data 3	Function
00	00	—	Multi Timbre Off
00	01	—	Multi Timbre On 1
00	02	—	Multi Timbre On 2
0D	00-07	—	00: Effect Off, 01: Chorus, 02: Delay 1, 03: Delay 2, 04: Delay 3, 05: Tremolo, 06: Rotary 1, 07: Rotary 2
0E	00-03, 06, 07	—	00: Reverb Off, 01: Room 2, 02: Stage, 03: Hall 1, 06: Room 1, 07: Hall 2
14	00-7F	—	Dual/Split balance
16	1F-60	—	Tune, 40: 440 Hz
17	00, 7F	—	00: Program Change Off, 7F: Program Change On
18	00-05	—	00: Light 1, 01: Normal, 02: Heavy 1, 03: Off, 04: Light 2, 05: Heavy 2
19	00-03	—	Lower Octave Shift
20	00-23	00-23	Dual, data 2: Right sound, data 3: Left sound
21	00-23	00-23	Split, data 2: Upper sound, data 3: Lower sound
25	00-08	00-0B	data 2: Temperament, data 3: Key
26	00, 7F	00-0F	Multi Timbre, data 2: 00 (On), 7F (Off), data 3: channel

◇ MIDI IMPLEMENTATION CHART

KAWAI DIGITATL PIANO
MODEL : CN31Date : November 2006
Version : 1. 0

Function		Transmit	Receive	Remarks
Basic channel	Default Changes	1 1 - 16	1 1 - 16	
Mode	Default Messages Altered	3 × *****	1 1, 3* ×	* The default for the OMNI mode is ON. Specifying MIDI channels automatically turns it OFF.
Note number	True voice	9 - 120** *****	0 - 127 0 - 127	** The value depends on the Transpose setting.
Velocity	Note ON Note OFF	○ 9nH v=1-127 × 9nH v=0	○ ×	
After touch	Key's Channel's	× ×	× ×	
Pitch bend		×	×	
Control change	0,32 7 11 64 66 67	○ × × ○ (Right pedal) ○ (Center pedal) ○ (Left pedal)	○ ○ ○ ○ ○ ○	Bank select Volume Expression pedal Sustain pedal Sostenute pedal Soft pedal
Program change	True #	○ 0 - 127 *****	○***	*** See the Program Change Number Mapping in page 42.
System exclusive		○	○	On / Off Selectable
Common	Song Position Song Select Tune	× × ×	× × ×	
System Real time	Clock Commands	× ×	× ×	
Aux	Local On / Off All notes Off Active Sense Reset	× × ○ ×	○ ○ (123 - 127) ○ ×	
Notes				

Mode 1: omni mode On, Poly, Mode 2: omni mode On, Mono
Mode 3: omni mode Off, Poly, Mode 4: omni mode Off, Mono○: Yes
×: No

KAWAI

THE FUTURE OF THE PIANO

CN31 Owner's Manual
OW1004E-S0701
Printed in Japan



Copyright © 2007 KAWAI Musical Instruments Mfg. Co.,Ltd. All Rights Reserved.