

# PocketProDVR User's Manual

English

English



## -Contents-

Overview-----	3~4
Accessories -----	5
Function Modes -----	6
Basic Operation-----	7~13
Turn ON / OFF MDVR-12-----	7
Select Functions-----	7
SETUP-----	7~9
Adjust Volume-----	9
REC Button-----	10
Basic Operation - Link with Other Equipments-----	11~13
Battery Charging Mode-----	13
Introduction to all the Functions-----	14~17
Video Playback-----	18~21
Video Editing-----	22
Supported Video File Format-----	23
Audio Playback-----	24~25
Audio Editing-----	26
Supported Audio File Format-----	26
Photo Browsing-----	27~28
Slide Show + Audio Playback-----	28~29
Photo Editing-----	29~30
Support Photo File Format-----	30
Record-----	31~34
Audio Line in Rec-----	31~32
Video Line in Rec-----	32~34
Specifications-----	35
Supported File Format-----	36~37
Precautions-----	38

## Overview

### MDVR-12 Main device

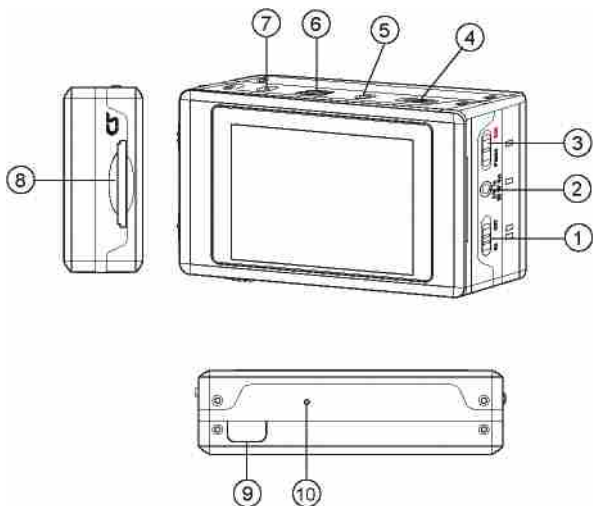

- |                        |                                    |                                 |
|------------------------|------------------------------------|---------------------------------|
| 1. Power ON/OFF Button | 2. AV Inputs Jack/CCD power supply | 3. Video/Audio Recording Button |
| 4. Exit Button         | 5. AV Output Jack                  | 6. USB Jack                     |
| 7. Power Supply Jack   | 8. SD Card Slot                    | 9. IR Transceiver               |
| 10. Reset Button       |                                    |                                 |

## Remote Control

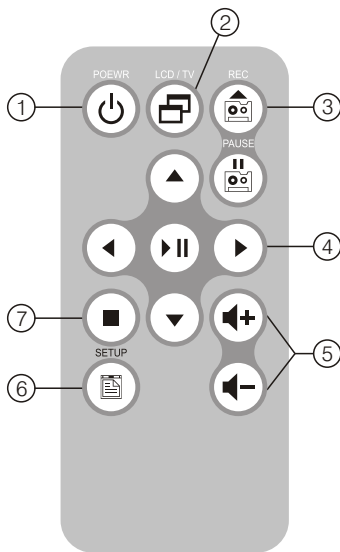

1. Power ON Button

2. LCD/TV Switch  
Button

3. Recording Button  
and Pause Button

4. Five-direction Key

5. Volume Buttons

6. Setup Button

7. ESC/STOP

## Accessories



Stereo Earphones



RAC Cable



USB Cable



Video Sensor (Optional)

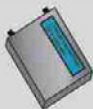

Battery



Remote Control



AC adaptor



User's Manual

## Function Modes



Movie



Audio



Photo



Record



Setting

Movie : MP4 video file playback

Audio : audio file Playback

Photo : browse images and pictures

Record : external audio source recording and external  
video source recording

Setting : set various functions

## Basic operation

### Turn on / off the player



**Turn On:** Push the On/Off button on MDVR-12 to turn on the power. The greeting screen will appear.

**Turn off:** Push the On/Off button on MDVR-12 or press the Power button on the remote control to immediately turn off MDVR-12.

### Select Functions

1. After the player is turned on, it will show the screen of Main Menu, press the arrow keys to select desired functions.
2. After selection, press play to enter the function that you've selected.



### SETUP

1. While you enter Video, Audio, Image modes, and various standby modes, press SETUP button to edit the settings.

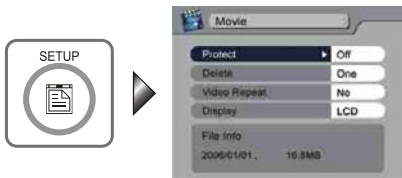

2. Select the item in the main menu: Press arrow keys to move the cursor.

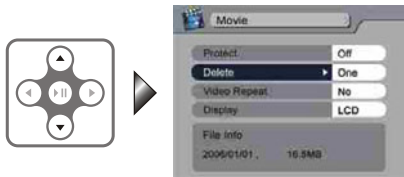

3. Enter the submenu: Press the right arrow key.

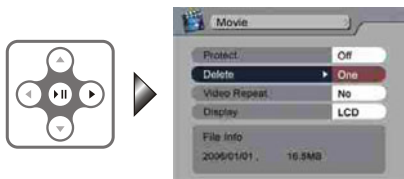

4. Select the item in the submenu: Press up or down to choose options.



5. Save the change: Press play to save the new setting.

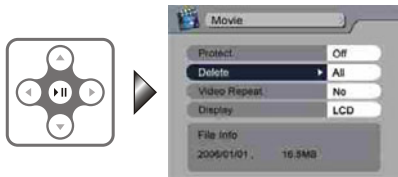



6. To not make any change and return to main menu: Press left.

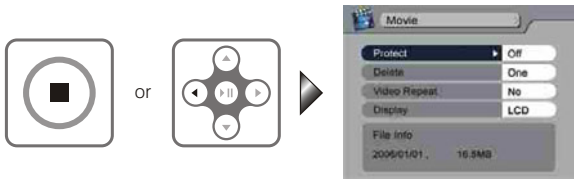

7. Exit SETUP: Press SETUP button or press stop to exit to the main menu screen.



## Adjust Volume

While playing Video, Audio or Slide + Audio, you adjust the sound volume by pressing the Volume buttons, volume varies in 10 steps

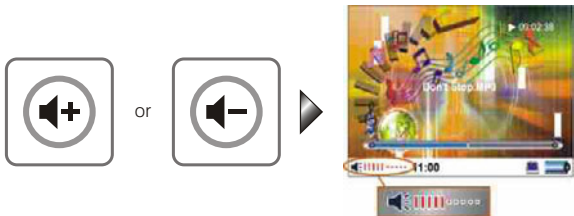

## REC Button

1. In the main menu: Pressing the REC button on the DVR or the REC button on the remote control to enter the AV function and start the video recording.



2. Pause the recording: Pressing the REC button on DVR or the PAUSE button on the remote control will suspend the video recording operation. If you want to continue recording, please press REC button again.



3. Stop Recording: Press STOP button to stop video recording and the screen will return to Preview Menu.



4. In other Modes: in the modes other than the above-mentioned mode, when you activate the REC button on DVR it will "lock" the access preventing accidentally turning off recording. (this function is not available on the remote control)

## Basic Operation - Link with Other Equipments

### External Video Source Recording

1. Use an external video camera, to record video using MPEG4 codec. (file format is AVI). Use the included RCA adapter cord if needed.

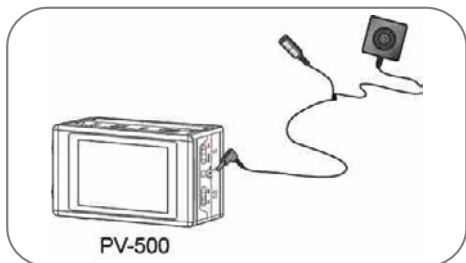

### Output to TV Screen

1. Output the image to the TV through the included RCA adapter cord.

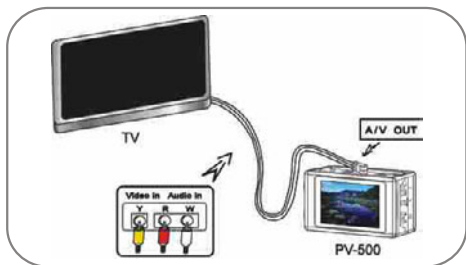

2. Enter the Setup Menu, change the setting of "Display" from "LCD" into "TV".

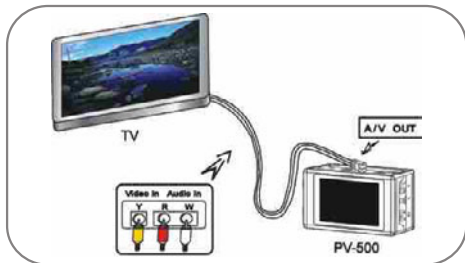

## Connect to PC

1. Connect the two ends of the USB cable to DVR and PC.

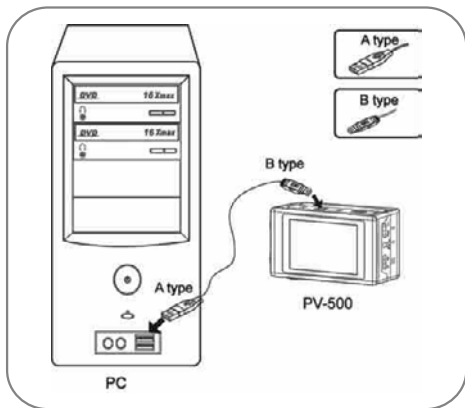

- "USB Mode" will appear on the screen and disappear 5 seconds later, and then it can be accessed via computer.



## Charging

When the power goes down, power LED indicator blinks (blue) and the meter with no bars displays on the bottom right corner of the screen, which indicates that the power of the host exhausts and please recharge it immediately

Connect the main device with the power supply and then plug the power supply into the electrical outlet. The LED light will always be on (orange light).

### Precautions:

The device will turn off the LED light to keep the life-span of the battery, please unplug the power supply promptly after finishing charging the battery.

## Introduction to all Setting Functions

- Operate in Main Menu: Press arrow keys to select functions, then press play to enter the Setup Menu



- Enter the Setup Menu



- Video playback repeat mode: allows you to repeat the playback of the selected single/all video files or stop after the playback of all video files.
- Audio playback repeat mode: for audio files in a similar way as that for video files.
- Slide show repeat Mode: make a slide show of all the image files once or repeatedly.
- Slide Show + Audio: make a slide show of the image files and meanwhile playback Audio files automatically (the image and audio files must be put in the same folder)
- Slide Show Time Delay: set the time delay between each image as 3, 5, 7, or 10 seconds.
- Backlight Off Timer: set the time delay to turn off the backlight during playback to 30 seconds, 1 minute, 3 minutes or never turn off.
- TV Format: select the format of the TV to be NTSC or PAL
- Display Selection: it can be switched between LCD and TV
- Language: choose the language of the operating interface

(10) Format: format SD card

(11) Reserved Recording:

Press arrow keys to select the items for the reserved recording, press play to confirm the setting.



→ External Audio Recording



→ External Video Recording

Time setting: please see "Basic Operation -SETUP" for the procedure of operating the buttons to set the start/end time and the quality for the two kinds of reserved recording modes.



Precautions:

It is needed to set the "Setup" item as "ON" to successfully book the reserved recording.

The reservation will be executed only when the device is in Power On State

The recorded files will be stored in the "MyRecord" folder in the Video/Audio folder

Recording Fail

When there are conflicts in the time setting or when the storage space is not enough: it will show a red forbidden sign to warn that the reserved recording will not be operated, so please set up again.



Interrupt by unknown reasons during recording (low battery, no signal, insufficient space,... etc.): it will show a red forbidden sign to warn that the reserved recording failed.



- (12) Time Setting: please see "Basic Operation - SETUP" for the procedure of operating the buttons.



- (13) Update Firmware: insert the memory card which contains updated software into the device and press Enter button, after the system is updated, it will reboot automatically; if the message "Update Error" is shown, it means that there are errors during updating, it might be that the software is incomplete or the memory card has some problem, please use other memory cards, or reboot the device after inserting the memory card; Toshiba, SanDisk or Panasonic memory cards are





(14) Reset to Default: select to reset default values.



(15) All Space: show the used space

(16) Residual Space: show the residual space

(17) Protection: activate the protection of the files to prevent the file from being deleted

(18) Delete: selectively delete selected file or all files

(19) File Information: show the size and duration of the current file

(20) Quality: set the quality of recording to be the best or standard

## Video Playback

### Operations in Main Menu

Press arrow keys to select the video playback function, then press play to enter



### Operations in File List Mode

Press arrow keys to choose the file you want to playback, push play to select the file for playback.



### Fast Playback

1. Double Speed Playback: pres the right key during playback, the video file will then be played with a speed two times faster; press play to return to the normal playback speed.

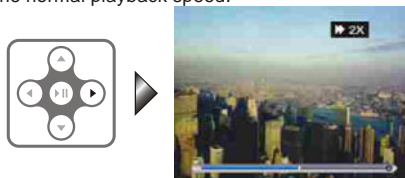

2. 4x Speed Playback: press right arrow twice or once during Double Speed Playback, the video file will be played with a speed four times quicker; press play to return to the normal playback speed.

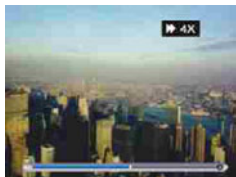

3. 8x Speed Playback: press right three times or press once during 4s Speed Playback, the video file will be played with a speed eight times faster; press play to return to the normal playback speed.

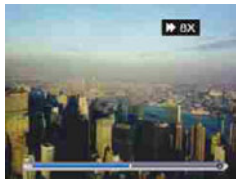

## Slow motion function

1. 1/2 Speed Slow Motion: press right after pausing the playback, the video file will be played in 1/2 Slow Motion; press PLAY button to return to the normal playback speed.

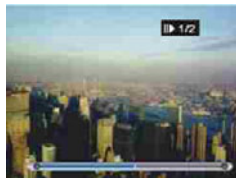
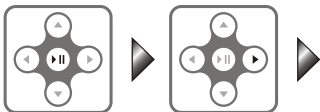

2. 1/4 Speed Slow Motion: press right twice after pausing the playback, the video file will be played in 1/4 Slow Motion; press PLAY button to return to the normal playback speed.

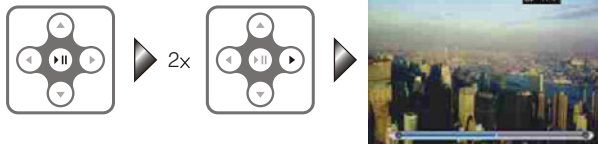

3. 1/8 Speed Slow Motion: press right three times after pausing the playback, the video file will be played in 1/8 Slow Motion; press PLAY button to return to the normal play back speed.

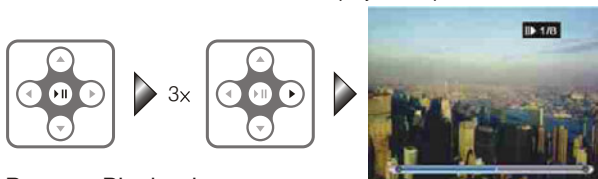

### Reverse Playback

The Index bar will go back as the video played in reverse; press PLAY to return to normal playback speed.

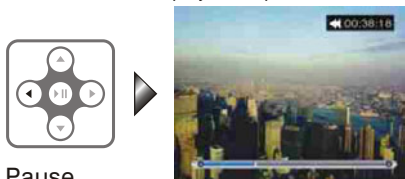

### Pause

Pause the Video, Index Bar and the playing time counting; Press pause once again to return to normal playback.

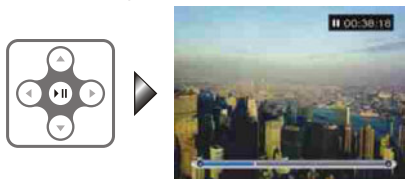

## Stop

Press stop to stop playing and return to File List Mode



## Video Capture

1. Capture Image while the Video is playing: Press PAUSE first and then press REC.

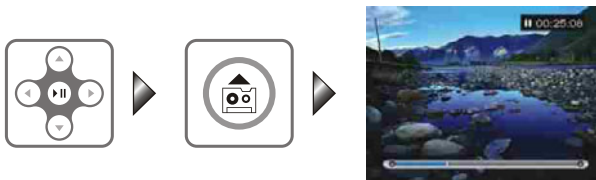

2. Return to normal Playback  
Press play to return to normal playback
3. The number of the captured pictures while the Video is playing is limited within 30, these files will be stored in "MyRecord" folder under photo mode with the filename: V0913001 (V-video, 0913 - MMDD, serial number 001-999 ); if the number of captured pictures exceeds 30, it will show the message "ABOVERECORDING LIMITED TO 30 FILES" or "ABOVE RECORDING LIMITED TO 999 FILES" if the serial number exceed 999 in one day, press  to exit the message and return to PAUSE state.

Precautions: This function works only after pressing PAUSE during normal playback.

## Video Editing

### During Video Playback

Press SETUP button, the video will be paused, and the setting items will appear, please see "Basic Operation - SETUP" for the procedure of operating the buttons.

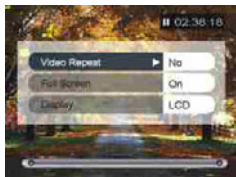

### In File List Mode

Press SETUP button, the setting items will appear, please see "Basic Operation - SETUP" for the procedure of operating the buttons.



## Supported Video File Format

File Format	Resolution	Bit rate	Frame rate
	Under 720*480	Under 4 Mbps	Under 30 fps
AVI(DivX 4/5.0)	●	●	●
AVI(DivX 2/3)	✘	✘	✘
MPEG1(DAT, M PG—VCD file format)	✘	✘	✘
ASF	✘	✘	✘
RM	✘	✘	✘
WMV	✘	✘	✘
VOB (DVD file format without copy protection)	✘	✘	✘
MJPEG(AVI)	a-law, u-law		

Notice: ● can be played in MDVR-12 directly

✘ can not be played directly, and is not able to be converted

## Audio Playback

### Operations in Main Menu

Use the arrow keys to select the file you want to play, after the file is selected, press play to enter Audio Playback function.



### Operations in File List Mode

Press up or down to select the file you want to play, after the file is selected, press play. If the filename is too long, use the arrow keys to view the name. Press stop to return to the upper level menu.



### Fast Playback

During Fast Playback, the Index bar and the playing time counting will become faster along with the file playback; press play to return to the normal playback.

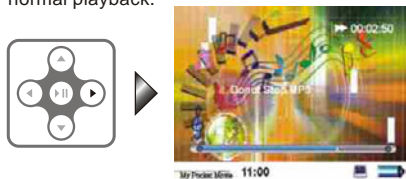



## Reverse Playback

During Reverse Playback, the Index bar and the playing time counting will become reversed along with the reverse playback; press play to return to the normal playback.



## Pause

By pressing PAUSE button, the Audio, the Index bar and the playing time counting will be paused; press play once again to return to normal playback.

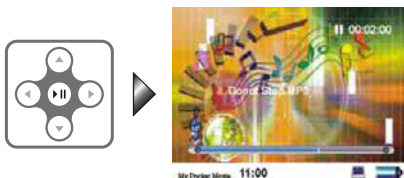

## Stop

Press  to stop the playback immediately and return to File List Mode.



## Audio File Editing

### Settings For Audio Playback

Press SETUP button, the audio playback goes on, the setting items appears, please see "Basic Operation - SETUP" for the procedure of operating the buttons.

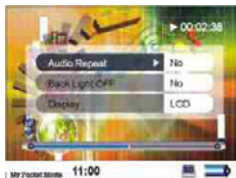

### In File List Mode

Press SETUP button, and the setting items will appear; please see "Basic Operation - SETUP" for the procedure of operating the buttons.



## Supported the form in audio frequency

File Format	
MPEG1 layer-3 version 1/2/2.5 stereo	●
MPEG1 layer-3 version 1/2/2.5 Joint-stereo	●
WMA(64 kbps~320 kbps)	●
WAV	●

## Photo Browsing

### Operations in Main Menu

Use the arrow keys to select Image Browsing Mode and press play.



### Operations in File List Mode

Use arrow keys to select the file, press play to view the image.



### Select the Photo for Browsing

Press up or down to select to browse the previous or next image.



## Zoom in the Photo by 2 times / 4 times

1. To zoom in, press play and the image will magnify 2x. Use the arrow keys to move the position of the screen.



2. Push the play button a second time to magnify 4x



Notice:

The screen will show the current magnification -- 2X/4X; if the image is displayed in full screen state and 4X is shown, and pressing play does not result in any changes, it means that the image has been magnified to its maximum extent and it is impossible to enlarge any more.

## Slide Show + Audio

File list In File List Mode or Image Browsing Mode, press SETUP button to show the setting items, select "Start Slide Show" and press play to start the Slide Show + Audio function ( the image files and the Audio files that you want to play need to be stored in the same folder.)

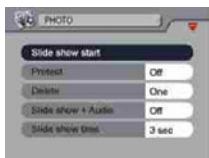

(In File List Mode)



(During Image Browsing)

## Pause

### 1. Pause Slide Show

Press pause to pause Slide Show

### 2. Cancel Pause

While Slide Show is paused, press pause again to resume.

## Stop the slide to broadcast

Press stop once, after pressing PAUSE button

## Photo Editing Mode

### During Photo Browsing

Press SETUP button, the setting items appear please see "Basic Operation - SETUP" for the procedure of operating the buttons.

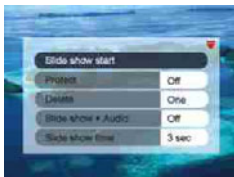

## In File List Mode

Press SETUP button, the setting items appear, please see "Basic Operation - SETUP" for the procedure of operating the buttons.



## Supported Photo File Format

Encoding File Format	Baseline	Progressive
JPG	Lower than 4096x4096	Lower than 1024x1024

## Record

### Audio Line in REC

#### 1. Select Record Function

Use the arrow keys in Main Menu to select Record function, then press play to enter.



#### 2. Select Audio Line in REC

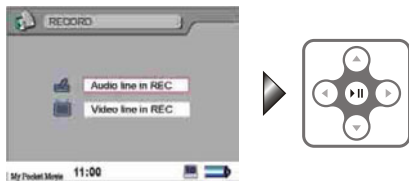

#### 3. Start Record

Press REC button to start recording, the file will be stored in "MyRecord" folder.

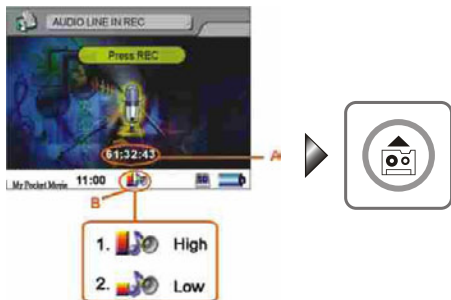

## 4. Pause

## (1) Pause Recording

Press the PAUSE button on the remote control or switch off the REC key on DVR to pause the recording and return to the standby mode.

## (2) Cancel Pause

Press the REC button on the remote control or switch the REC key on DVR to continue the recording & store it in the same file

## 5. Stop

During the recording, press stop button to stop the recording immediately and return to the standby mode.

## 6. The recorded Video file will be stored in the "MyRecord" folder in MOVIE and the recorded sound file will be stored in the "MyRecord" folder in MUSIC.

## Video Line in REC

- In Main Menu: Activate the REC switch to record immediately or use RED button on the remote control to enter the AV function, and start the recording.



- If using the remote control, use the arrow keys to select the the recording function, and press play to enter.





## 3. Select Video Line in REC

Select External Video Source Recording, press ENTER button to enter standby mode (make sure to connect the video camera to the AV IN jack. The DVR will record the video into a MPEG4 AVI file.

\*\*Using the REC switch on the DVR, starts recording immediately

Without need for the IR remote

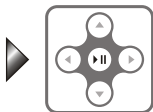

4. If the message "Press REC button" disappears: in Standby mode, if there is no operation within 5 seconds, the messages of recordable time, quality and "Press REC button" will disappear, you have to press REC button again to return to Standby Mode, and then press REC button in Standby Mode to start the recording.



## 5. Start Recording

Press REC button to start recording, the file is stored in "MyRecord" folder.



6. Pause

(1) Pause Recording

Press the PAUSE button on the remote control or decrease the REC key on DVR to pause the recording and return to the standby mode.

(2) Cancel Pause

Press the REC button on the remote control or increase the REC key on DVR to continue the recording and store it in the same file.

7. Stop Recording

During the recording, press stop or move the REC switch to stop the recording immediately and return to Standby Mode.

8. The recorded Video file will be stored in the "MyRecord" folder in MOVIE and the recorded sound file will be stored in the "MyRecord" folder in MUSIC.

## Specifications

Timer	Time
Display	Resolution 160 x R.G.B x 240 2.37 inch TFT-LCD with LED backlight NTSC/PAL composite output
AV IN/OUT	AV input/output through two $\varphi$ 2.5mm jacks
LED Indication Light	LED1 - Charging (orange) LED2 - Power (blue) LED3 - Signal Source Detection (green) LED4 - Audio/Video recording, file operation (red)
Storage Device	SD card
Computer Connection	USB 2.0 mini connector
Power System	Rechargeable/Exchangeable Lithium Ion Battery 3.6V 1250mAh. Power supply 100~240 V, 50~60 Hz
Dimension / Weight	79.90 x 51.90 x 22.30 mm 91g / 68 g, with/out the battery respectively.
System Requirements	Operating system: Window2000, Window XP CPU: Intel Pentium III 800MHz and beyond Relevant hardware accessories: USB port, Mouse, CD-ROM, Windows-compatible display with a required resolution of 1024 x 768

## Supported Video File Format

### Supported Video File Format

File Format	Resolution	Bit rate	Frame rate
	Under 720*480	Under 4 Mbps	Under 30 fps
AVI(DivX 4/5.0)	●	●	●
AVI(DivX 2/3)	✘	✘	✘
MPEG1(DAT, M PG—VCD file format)	✘	✘	✘
ASF	✘	✘	✘
RM	✘	✘	✘
WMV	✘	✘	✘
VOB (DVD file format without copy protection)	✘	✘	✘
MJPEG(AVI)	a-law, u-law		

Notice: ● can be played directly in the MDVR-12

✘ Can not be played in the MDVR-12 without converting with 3rd party application software

## Supported the form in audio frequency

File Format	
MPEG1 layer-3 version 1/2/2.5 stereo	●
MPEG1 layer-3 version 1/2/2.5 Joint-stereo	●
WMA(64 kbps~320 kbps)	●
WAV	●

## Supported Image File Format

Encoding File Format	Baseline	Progressive
JPG	Lower than 4096x4096	Lower than 1024x1024

## Precautions

Before using this product, please read this manual in detail to ensure you are using this product properly.

During the recording in various REC Modes, all button-pressing is disabled.

All the recorded files are stored in the "MyRecord" folder.

After the setting of Reserved Recording and Alarm functions, the setting will be executed only when the "SET" item is set to "ON".

Reserved Recording and Alarm functions will be executed after the device is turned off.

If the file is corrupted such that it cannot be played, the part of the file that is corrupted will be skipped. If the file is still unable to be played, it will jump to the next file.

Only the files with the extension of MP3, WMA, WAV, ASF, AVI, BMP and JPG can be played in this DVR.

The player can distinguish an unlimited number of files/folders. However, within a folder, a maximum of 999 files can be distinguished.

The maximum playing time of video files is limited to 2 hours and the maximum playing time of audio files is limited to 3 hours.

In the Video files, only the audio in MP3 and WMA format is supported, AC3, DTS, AAC and other formats are not supported.

All data in the device may be deleted due to excessive impact, lightning, power surge etc., the manufacturer does not bear responsibility for the losses caused in the above situations, please protect and back up the data in the device properly.

Please avoid serious vibration; hard vibrations may damage the LCD display.

Please do not apply heavy pressure on the player; the player may be damaged because of excessive weight applied to the housing.

When the memory card is removed from your DVR, the card may feel warm due to normal operation. This is nothing to be concerned about, it is normal.

If the memory card is inserted in the wrong direction, the card will not fit completely into the bottom of the slot, do not force the card in incorrectly doing so will damage the card and the device.

While connecting the device to a PC through USB, you can read/download directly from the SD card and run the files as a mass storage device.

If you connect the device to a PC through USB, and choose to use the computer to format the storage device, please use FAT32 format.

Please do not scrub the LCD with hard materials or chemicals. The screen is easily damaged. If you want to remove the dust on the LCD screen, please clean the case with a soft dry cloth, if dirt or stains are left, you can use a small qty of mild cleansing liquid; do not use volatile solutions because they will cause chemical reactions, thus the device might be deformed or discolored.

If the device is moved from a cold to a warm location, the screen may fog up; if this situation takes place, please turn off your DVR and wait for about one hour before use.

Please do not store or use your device in the following places:

1. Extremely humid or dusty places.
2. Places with direct sunlight or a high temperature, e.g.: The DVR will be damaged if left in an extremely hot car in the summer.
3. Avoid heavy vibration or strong magnetic fields, as such things may interfere with the normal operation of the device.