

TOSHIBA

Digital
High Definition Receiver

HD-S23

OWNER'S MANUAL

DVB[®]

DD DOLBY[®]
DIGITAL
DD DOLBY[®]
DIGITAL

Introduction	7
Connections	11
Menu Navigation	15
Quick Control	27
Appendices	31



Precautions

WARNING: TO PREVENT FIRE OR SHOCK HAZARD, DO NOT EXPOSE THIS APPLIANCE TO RAIN OR MOISTURE.

TO PREVENT ELECTRIC SHOCK, DO NOT OPEN THE COVER. REFER SERVICING TO QUALIFIED PERSONNEL ONLY.

This unit is not disconnected from the AC power source as long as it is connected to the wall outlet, even if the unit itself has been turned off.

NOTE

The rating label and the safety caution are on the rear of the unit.

Power cord cautions

- When plugging in or unplugging the power cord, hold it by the plug. Do not unplug it by pulling on the cord.
- Do not touch the cord with wet hands as this could cause electrical shock or shorting
- Do not place furniture, etc, on top of the power cord.
- Do not tie up the power cord, or connect a different power cord.
- Route the power cord so that it is not stepped on, or tripped over.
- Using a damaged power cord could result in fire or electric shock. Inspect the power cord for damage. If damaged, consult your nearest TOSHIBA service centre or have it replaced at a sales outlet.

Welcome to the world of high definition picture and sound created by the TOSHIBA HD-S23 Set-Top Box. In order to enjoy the many features this receiver has to offer, please read this owner's manual thoroughly before using.

Please record the serial number located on the back of the receiver. In the following spaces.

Serial No: _____

In order to continue to get the maximum performance from your receiver:

- Make sure that it is set up properly.
- Have it regularly inspected by qualified service personnel.
- Make sure that all family members learn to operate it properly.

In particular:

Prevent electric shock by making sure that children do not insert objects into the receiver's holes or slots.

Please do not use or place the receiver in the following environments.

1. Near heat sources.
 - ◆ Places subject to direct sunlight.
 - ◆ Near radiators or air ducts.
 - ◆ On top of an amplifier
2. Dusty places
3. Places subject to vibration or shock
4. Near strong magnetic fields such as a speaker or a cassette deck.
5. Places subject to moisture such as a kitchen or bathroom.

6. Places without adequate air circulation.
 - ♦ On top of a carpet or sofa.
 - ♦ In a bookcase.
 - ♦ Near materials such as curtains, etc.
7. Extremely hot or cold places
 - ♦ The operating temperature range of this unit is 5°C to 40°C
8. Do not place a flower vase or cloth on top of this unit.

Please pay attention to the following items when using this unit. Failure to do so may result in damage to the unit or electric shock.

1. Connect the power plug to AC 100-240V 50/60Hz
2. Unplug the power cord from the receiver before connecting any other equipment, especially the TV antenna. Connect all equipment to the receiver before plugging any power cords to the power source.
3. Be sure your TV antenna is not located near overhead power lines, or where it might fall into any power lines. Also be careful to avoid touching any such power lines when installing the TV antenna.
4. Be sure that antenna is grounded to provide protection from lightning and build-up of static electricity.
5. Do not attempt to modify the unit.
6. If you hear a strange sound or notice smoke coming from the unit, turn the power off immediately, unplug the power cord, and consult with your local sales outlet.
7. Do not drop metal objects, paper or liquids into the unit through the ventilation openings, etc.. This may result in damage. In the event something is dropped inside, turn the power off, unplug the power cord and consult with your local sales outlet.
8. When transporting, do not vibrate or shake the unit. This may result in damage or faulty operation.
9. If a three-prong power plug is provided with receiver. Be sure it is used with a properly grounded three-wise power socket.
10. Do not use insecticide sprays, etc, near the unit. Also, do not leave rubber or plastic objects in contact with the unit for long periods of time. This may cause discolouring of this unit's finish.
11. When transporting the unit, be sure to turn off the power and disconnect all cables.
12. When not using the unit for a long period of time (when on vacation, etc) unplug the power cord.
13. Keep the original packing that this unit came in and use it to re-pack the unit when moving or transporting.
14. Avoid overloading electrical outlets or extension cords, otherwise it could result in electric shock or fire.

MOISTURE CONDENSATION

Never operate this receiver immediately after moving it from a cold location to a warm location. In this case, connect the power cables of the receiver to an AC outlet, to turn the power on and leave it for TWO TO THREE hours without operating it.

Moisture condensation is most likely to occur in the following cases:

- ♦ When moved from a cold location to a warm location.
- ♦ In a room rapidly heated or in a place where the receiver is directly exposed to cool flow of air from an air-conditioner or other electrical appliance.
- ♦ In a room with excessive dampness or high humidity.

Types of Power Plug



	<p>Australia 3-prong power plug imagine to be paste here by Zinwell!</p>	<p>Power cord must be used in Australia only</p>
	<p>Singapore 3-prong power plug imagine to be paste here by Zinwell!</p>	<p>Power cord must be used in Singapore only</p>

TABLE OF CONTENTS

PRECAUTIONS	2
TYPES OF POWER PLUG	4
TABLE OF CONTENTS	5
INTRODUCTION	7
FEATURES	7
IDENTIFICATION OF CONTROLS.....	8
<i>Front Panel</i>	8
<i>Rear Panel</i>	8
REMOTE CONTROL	9
<i>Loading batteries</i>	10
<i>Operating with the remote control</i>	10
CONNECTIONS	11
CONNECTING TO AUDIO VIDEO DEVICES	12
CONNECTING TO SDTV (WITHOUT COMPONENT INPUTS)	13
CONNECTING TO SDTV (WITH COMPONENT INPUTS) AND VCR	13
CONNECTING TO HDTV	14
CONNECTING TO HDTV AND VCR.....	14
MENU	15
MENU MAP.....	16
INITIAL SETUP	17
MAIN MENU.....	17
INSTALLATION.....	18
<i>AUTO SCAN</i>	18
<i>QUICK SCAN</i>	18
<i>MANUAL SETUP</i>	19
<i>RESET DATA</i>	19
PROGRAM	20
ELECTRONIC PROGRAM GUIDE	20
SYSTEM	21
<i>PASSWORD</i>	21
<i>VIDEO SETUP</i>	21
<i>AUDIO SETUP</i>	22

<i>SOFTWARE UPDATE</i>	22
<i>TIME SETUP</i>	23
EDIT CHANNEL	24
<i>FAV & LOCK</i>	24
<i>PARENTAL GUIDANCE (RATING)</i>	24
PROFILE	25
<i>TRANSPARENCY</i>	25
<i>I-PLATE SETUP</i>	25
<i>INFORMATION</i>	26
QUICK CONTROL	27
I-PLATE (INFO)	28
AUX IN (EXTERNAL VIDEO/AUDIO INPUT)	29
PIP (PICTURE-IN-PICTURE)	29
TELETEXT / CLOSED CAPTION	30
FAVOURITE CHANNEL LIST	30
FREEZE	30
A.RATIO	30
APPENDICES	31
APPENDIX 1 DTV CHANNEL TABLE	32
APPENDIX 2 TROUBLESHOOTING	35
APPENDIX 3 PARENTAL GUIDANCE CODES	37
APPENDIX 4 GLOSSARY	38
APPENDIX 5 TECHNICAL SPECIFICATIONS	39
APPENDIX 6 ACCESSORIES	40

INTRODUCTION

The HD-S23 Digital Terrestrial HDTV Receiver opens up to a new world of free-to-air terrestrial HDTV and SDTV programmes. The receiver can receive channels from both VHF band and UHF band TV station's signals. All the major terrestrial free-to-air station numbers currently available in your area are listed in the on-screen menu. To watch a channel, simply select the channel number and you will be accessing a wide range of high quality digital programmes.

The receiver is fully MPEG 2 / DVB-T compliant, delivering High Definition crystal-sharp video and Dolby® Digital sound. As it supports a channel frequency range of 50-860 MHz, it can be easily programmed for all the channels within the VHF and UHF frequency bands. To find out the channel frequencies in your area, please contact your local service provider.

FEATURES

HD 1080i Capability

High Definition (HD) brings a wide-screen format to the home television as well as a sharper picture. This receiver corresponds with 1080i signal input and it fully recreates high definition screen quality.

Dolby® Digital

Dolby® Digital is the surround sound technology used in theatres showing the latest movies, and is now available to reproduce this realistic effect in the home. You can enjoy motion pictures and live concert TV programmes with this dynamic realistic sound by connecting HD-S23 receiver to a 6-channel amplifier equipped with a Dolby® Digital decoder.

Teletext/Fastext

PIP (Picture-in-Picture)

This feature gives you the ability to view 2 different channels at the same time. One program can be viewed on the main screen while another is simultaneously displayed in a smaller viewing window, often positioned in one corner of the screen. The basic PIP system requires you to use the tuner of an externally connected video component such as a VCR as the source for the second signal.

AUX Input

Allows you to select video input between Antenna and DVD/VCR.

Still Picture Display

Allows you to take a snapshot of a video at a particular instant as a still picture.

Wide-screen Picture Format

Wide-screen is the term given to picture displays that have a wider aspect ratio than normal. For example, the aspect ratio for conventional TVs is 4:3 and for wide-screen TVs is 16:9. This receiver supports broadcasts in both formats.

IDENTIFICATION OF CONTROLS

Front Panel

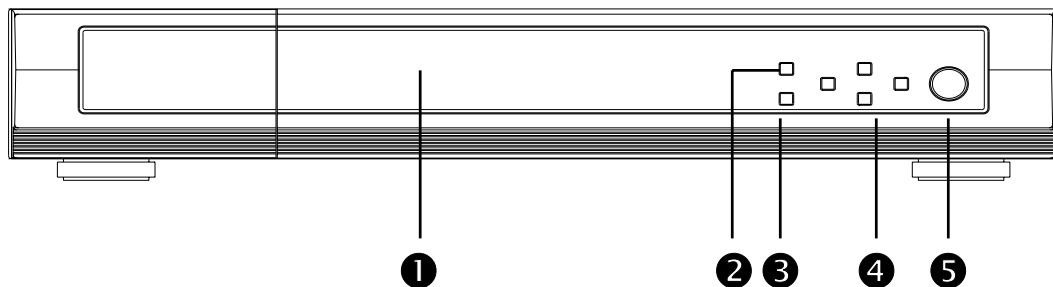

① LED Display

Four-digit channel number, time or video format

Two LEDs:

Green for power; Red for signal indication (OFF –signal captured, ON –no signal)

② MENU / ENTER (Please refer to pp. 17 for more details)

③ EXIT / V.OUTPUT → **OUT1 & OUT2 description (Zinwell)**

④ Direction Keys

⑤ Power on / off

Rear Panel

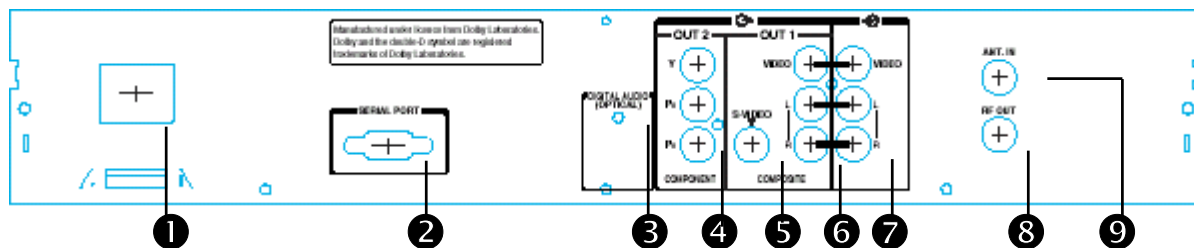

① AC MAINS SUPPLY

100~240 V_{AC}, 50/60 Hz

② SERIAL PORT

For connection to PC for software upgrade

③ DIGITAL AUDIO (OPTICAL)

For connection to an amplifier equipped with Dolby® Digital decoder

④ (OUT2) Component – Y/Pb/Pr

For connection to TV monitor's component video inputs

⑤ S-VIDEO (OUT1)

For connection to TV monitor's S-Video input

⑥ (OUT1) Composite- VIDEO / L / R

For connection to TV monitor's Video/L/R inputs

⑦

For connection to DVD or VCR Video/L/R output

⑧ RF OUT

For connection to analogue TV's ANT. IN

⑨ ANT.IN

For connection to UHF/VHF antenna

Remote Control

The buttons on the remote control are described as follows:

- **Numeric Buttons** For entering channel number or password
- **POWER** Switches the receiver between ON and STANDBY modes
- **INFO** Displays I-Plate providing information about the current channel
- **AUDIO** Toggles between multi-lingual Audio soundtracks
- **MENU** Activates the On-Screen Menu
- **LIST** Displays the complete channel/program list
- **FAV** Displays the Favourite channel list
- **Direction buttons** To move through menus or submenus
- **ENTER** Selects the highlighted menu or submenu item
- **CH+/CH-** Provides channel up and down functions
- **VOL+/VOL-** Increases or decreases audio volume
- **A.RATIO** Adjusts the aspect ratio between 16:9 and 4:3
 - Wide Vision: to display 16:9 program on 16:9 TV screen to display 4:3 program on 4:3 TV screen
 - Wideview Normal: to display 16:9 program on 4:3 TV screen in letterbox
 - Normal Vision: to display 16:9 program cropped on 4:3 TV screen
- **PIP** Shows the auxiliary input and multiple programs list in the same DTV Network the receiver is tuned to and allows displaying the second program on the TV screen
- **AUX** Selects between ANT.IN (DTV signal) and AUX (DVD or VCR) inputs
- **V.Format** Toggles between 576i, 576p, 720p and 1080i video formats through Y/Pb/Pr video connectors.
- **Freeze** To Freeze the picture on the main Screen.
- **V.Output** Switch between Composite (Out 1) and Component (Out 2)

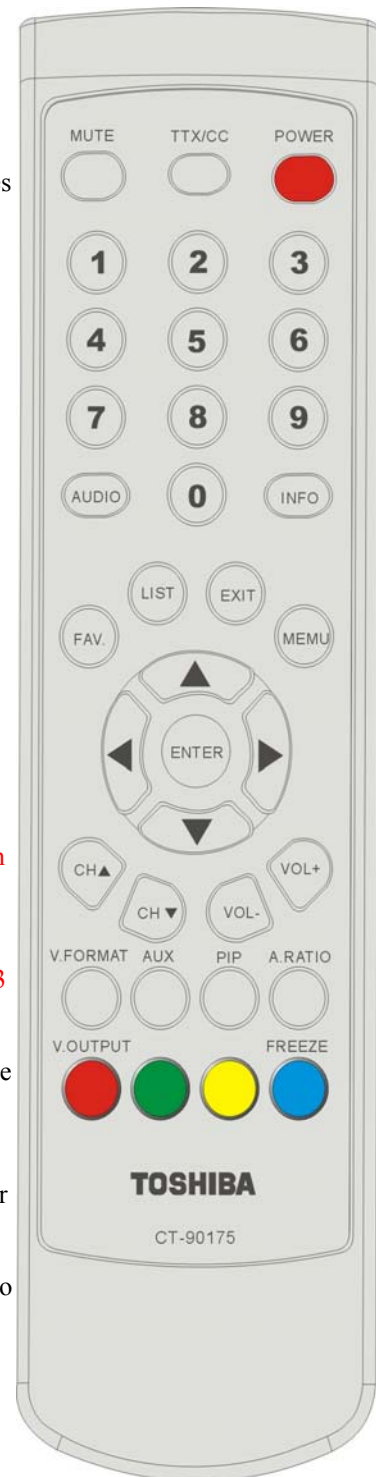

Loading batteries

Operating with the remote control

1. Open the Cover
2. Insert batteries (AAA size)

Make sure to match the + and – on the batteries to the marks inside the battery compartment.

3. Close the cover.

Notes on batteries

Improper use of batteries may cause battery leakage and corrosion. To operate the remote control correctly, follow the instructions below.

- Do not insert batteries into the remote control in the wrong direction.
- Do not charge, heat, open, or short-circuit the batteries. Do not throw batteries into a fire.
- Do not leave dead or exhausted batteries in the remote control.
- Do not use different types of batteries together, or mix old and new batteries.
- If you do not use the remote control for long period of time, remove the batteries to avoid possible damage from battery corrosion.
- If the remote control does not function correctly or if the operating range becomes reduced, replace all batteries with new ones.
- If battery leakage occurs, wipe the battery liquid from the battery compartment, then insert new batteries.

Operating with the remote control

Point the remote control at the remote sensor and press the buttons.

Distance: About 7 m (23 feet) from the front of the remote sensor.

Angle: About 30° in each direction of the front of the remote sensor.

- Do not expose the remote sensor of the DVD player to a strong light source such as direct sunlight or other illumination. If you do so, you may not be able to operate the DVD player via the remote control.

Notes on the remote control

- Direct the remote control at the remote sensor of the DVD player.
- Do not drop or give the remote control a shock.
- Do not leave the remote control near an extremely hot or humid place.
- Do not spill water or put anything wet on the remote control.
- Do not open the remote control

UConnections

Read this chapter first to make all necessary preparations

- **Connecting to Audio Video Devices**
- **Connecting to SDTV (without Component Inputs)**
- **Connecting to SDTV (with Component Inputs) and VCR**
- **Connecting to HDTV**
- **Connecting to HDTV and VCR**

CONNECTING TO AUDIO VIDEO DEVICES

For the best video/audio quality, use the higher quality Y/Pb/Pr or S-Video cables if available. Always remember to disconnect the receiver from the power source, when connecting or disconnecting the cable to the UHF/VHF antenna.

Notes:

- (a) If your TV supports 1080i / 720p / 576p / 576i video input formats, please use the receiver's OUT2 video connectors. You may use the V.FORMAT button on the remote control to switch between four video output formats 1080i/720p/576p/576i.
- (b) If your TV supports 576i video input format, please use the receiver's OUT1 connectors to connect to your TV.

For more details on the various ways of connection, please refer to pp. XX.



Before connecting or disconnecting the antenna cable, turn off the antenna booster, if any.

Connecting to SDTV (without Component Inputs)

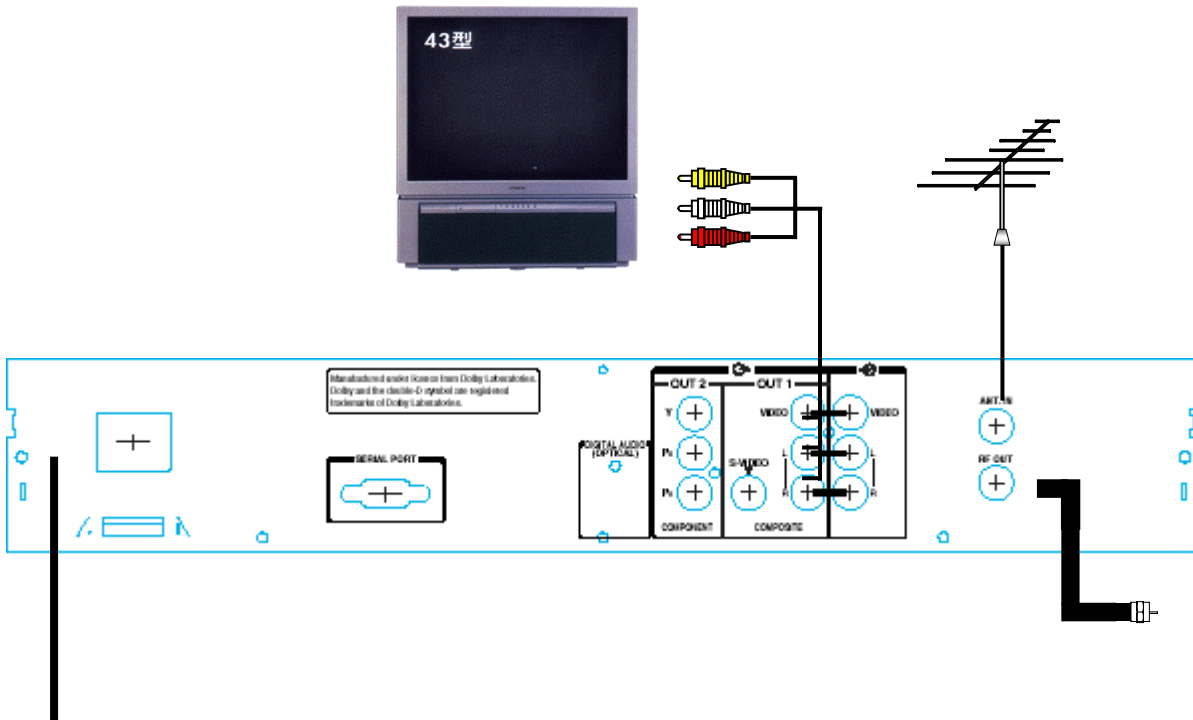

Connecting to SDTV (with Component Inputs) and VCR

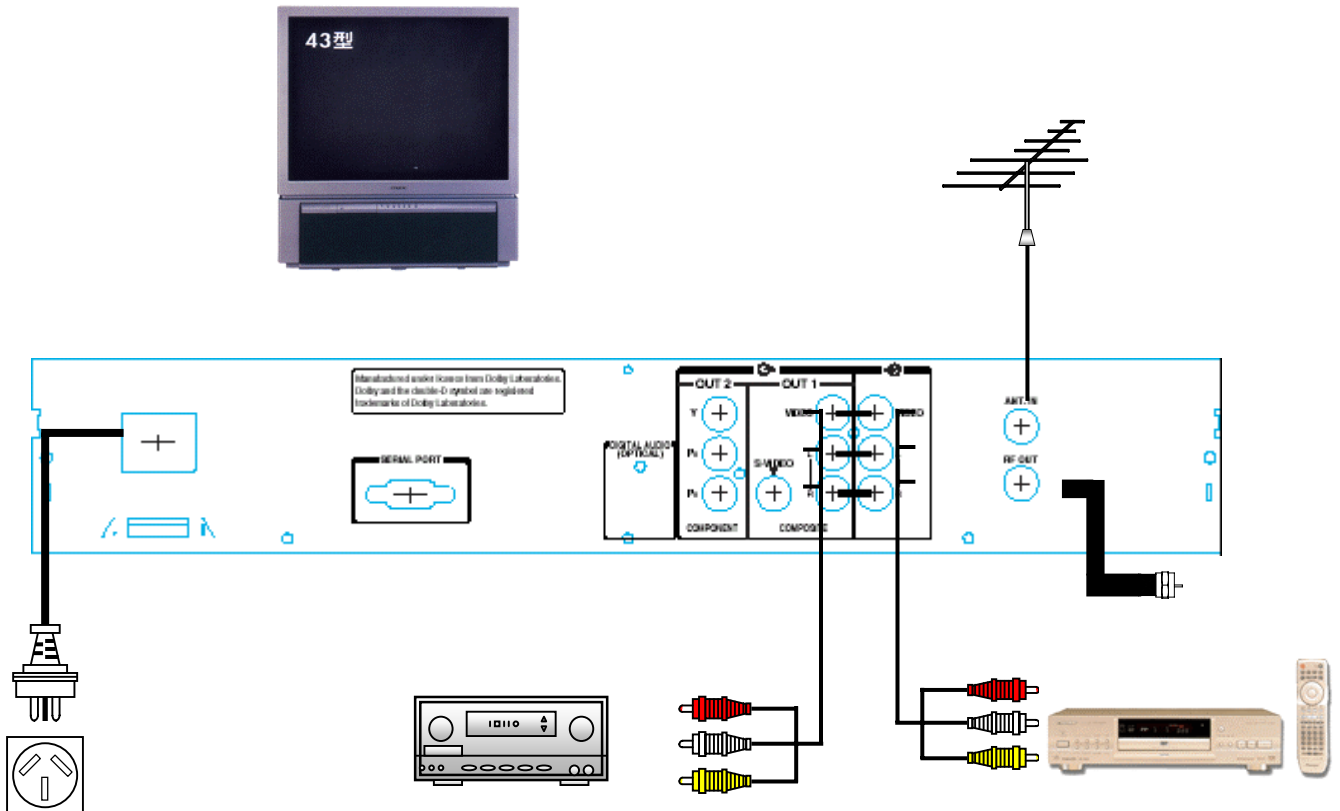

Connecting to HDTV

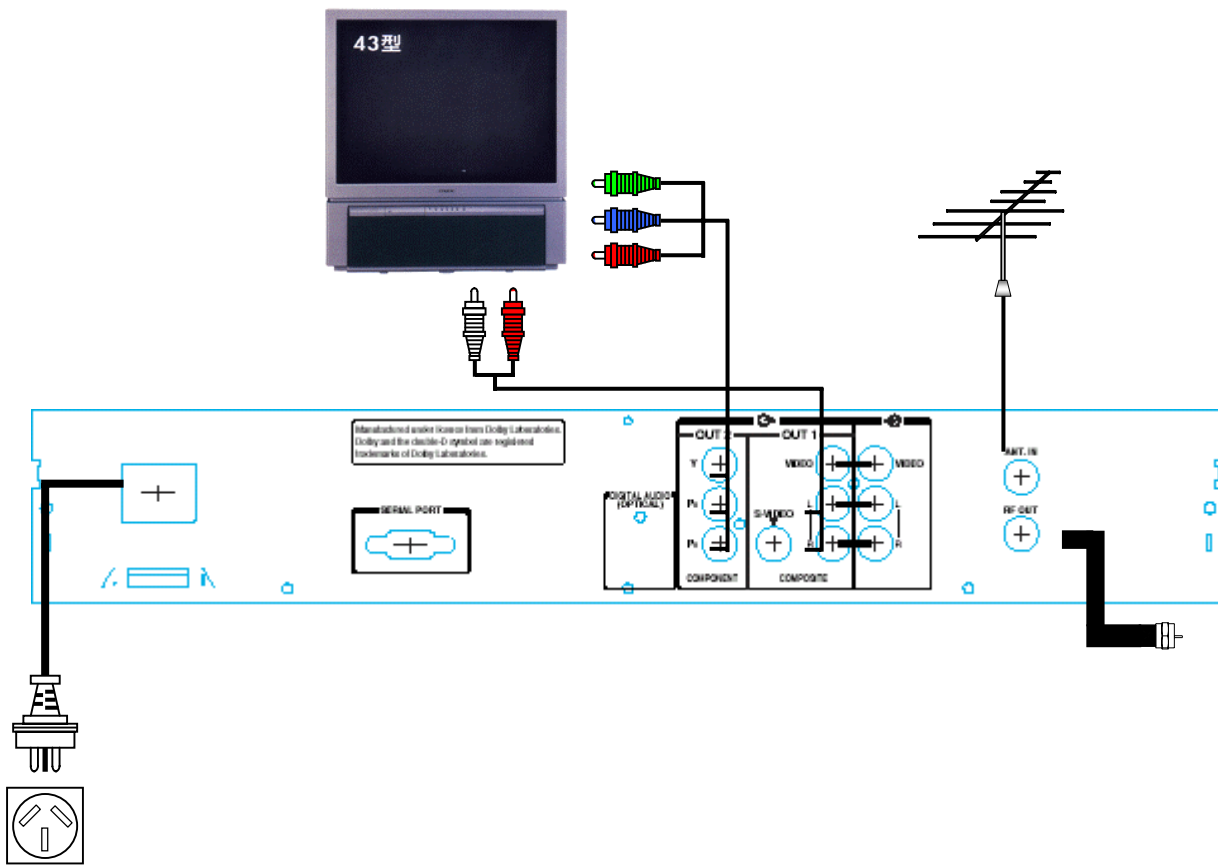

Connecting to HDTV and VCR

UMenu

Functions in the Menu.

- **Menu Map**
- **Initial Setup**
- **Main Menu**
- **Installation**
 - **Auto Scan**
 - **Quick Scan**
 - **Manual Setup**
 - **Reset Data**
- **Program**
- **Electronic Program Guide**
- **System**
 - **Password**
 - **Video Setup**
 - **Audio Setup**
 - **Software Update**
 - **Time Setup**
- **Edit channel**
 - **Fav. & Lock**
 - **Parental Guidance (Rating)**
- **Profile**
 - **Transparency**
 - **I-Plate Setup**
 - **Information**

MENI I M A D

MENÜ MAP

MAIN MENU



PROGRAM



EDIT CHANNEL

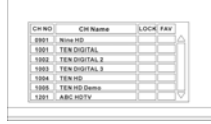

INSTALLATION

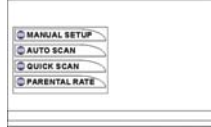

SYSTEM



PROFILE

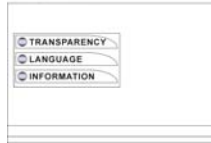

TRANSPARENCY

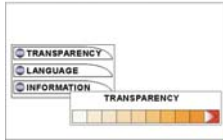

LANGUAGE

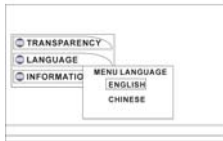

INFORMATION

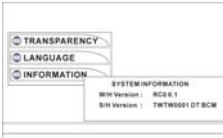

MANUAL SETUP

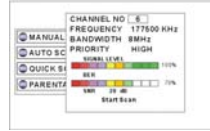

AUTO SCAN

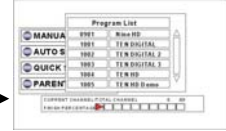

QUICK SCAN

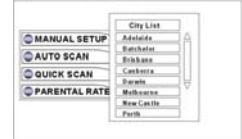

PARENTAL RATE

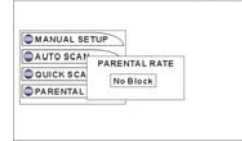

PASSWORD

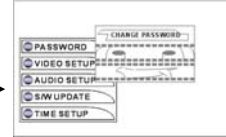

VIDEO SETUP

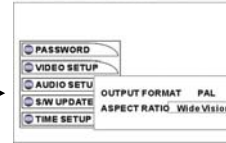

AUDIO SETUP

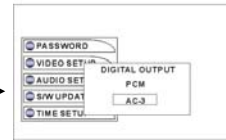

S/W UPDATE

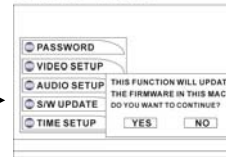

TIME SETUP

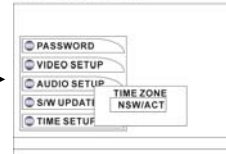

INITIAL SETUP

If your service provider or antenna installer has already installed your TV system to receive terrestrial TV programmes, do not change any connections of those devices or installation settings unless it is absolutely necessary. If your receiver has not been configured by your service provider or system installer, then it will not be set up for any specific channel or frequency when powered on for the first time.

- **Initial Screen –**
The first time the receiver is powered on, it will display a Country Selection menu.
- Use the arrow buttons “▲” and “▼” to highlight your country of residence and press the “ENTER” button to make your selection.
- If the Initial Screen does not appear, press the “MENU” button for configuration.

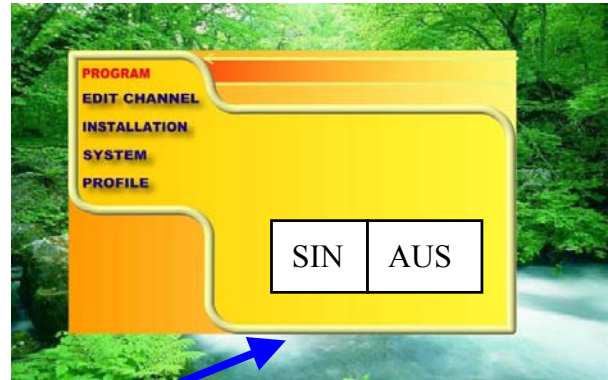

Zinwell to-do:

Above is tentative description.

Actual procedure to be confirmed by Zinwell.

Also Zinwell should provide an updated snapshot for country selection screen.

MAIN MENU

There are two ways to enter the Main Menu when the receiver is powered on:

- On the remote control, press the “MENU” button.
- Alternatively, press “MENU” button on the front panel.

Use the arrow buttons ▼▲ to navigate through the menu, “ENTER” button to choose specific items, and “EXIT” button to return to the main menu from submenu or to leave the main menu.



INSTALLATION

On the main menu, select “INSTALLATION” and key-in your password to enter the Installation page.

Note: The default password is 0000. Please refer to pp. XX to change the password.

AUTO SCAN

The steps required to automatically program the receiver are outlined as below:

- Highlight “AUTO SCAN” and press the “ENTER” button to start channel search.
- The receiver starts scanning from channel 2 to channel 69. The status bar shows the progress being made.
- Once the digital TV signal is scanned, the channel number and program name will be shown.

NOTE: Auto scan process may take about 18 minutes to complete.



QUICK SCAN

If you live in one of the cities listed on the Quick Scan menu, you may select your city and start scanning all predefined digital TV channel signals..

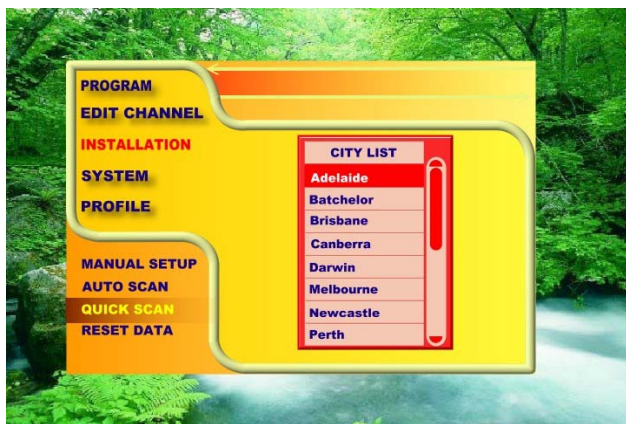

- On the installation page, highlight “QUICK SCAN” and press the “ENTER” button.
- Use the “▲” and “▼” buttons to highlight the city you live in and press the “ENTER” button to start scanning.
- For Australia, it will scan through five RF channels including “Seven”, “Nine”, “Ten”, “ABC” and “SBS”.

Note: The frequencies of these five channels are preset in the receiver’s database. In the case that the channel frequency is changed by the local TV station or a new channel comes up after July 2003 you have to scan these channels using “MANUAL SETUP”.

MANUAL SETUP

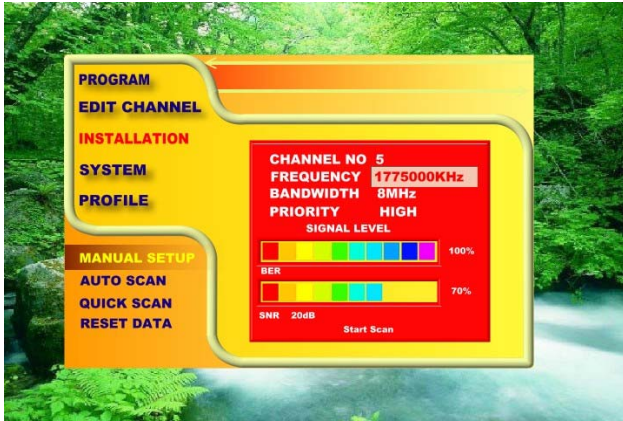

- On the Installation page, highlight “MANUAL SETUP” and press the “ENTER” button.
- Select channel number. Be sure you know the channel number and its RF frequency. You may refer to Digital TV channel table on Appendix 1.
- Press “▼” button to highlight “Frequency”, “Bandwidth” and “Priority” to make sure the parameters are correct, then press “▼” button to highlight “Start Scan” and press the “ENTER” button to start scanning.

Note:

- (1) If scanning is successful, “Start Scan” will change to “Get Channel Success” and signal quality will be shown. At this point you can press “EXIT” to leave “MANUAL SETUP” or continue scanning other channels.
- (2) If scanning is unsuccessful, “Start Scan” will change to “Time out error”. At this point you can rescan the signal or refer to the signal level bar “LVL” and bit error rate counter “BER” for aligning the direction of the antenna to get the signal. Please refer to your Antenna Installer if problem persists.
- (3) For Australia, the bandwidth should be 7MHz while for Singapore the bandwidth should be 8MHz.

RESET DATA

Zinwell to-do:

Add RESET DATA description here!

PROGRAM

- On the main menu, select “PROGRAM” to enter the program list.
- Use the “▲” and “▼” buttons to browse through the channel numbers and names

Note: Alternatively, when you are watching a Digital TV channel (without any menu on screen), you can press the “LIST” button on the remote control twice to call up the program list.



ELECTRONIC PROGRAM GUIDE

- To call out the program guide of the specific channel, highlight the channel from the program list and press the “ENTER” button.
- Alternatively, you may press the “INFO” button on the remote control twice to call up the program guide.
- Use “◀” and “▶” buttons for details on NOW and NEXT event, and “▲” and “▼” buttons for scrolling an event table that consists more than 1 page.
- The first row shows channel name, show times and parental rating. The second row shows program name and third row shows program genre.



EPG's OSD need to change to have three rows on the top of OSD.

SYSTEM



- On the main menu, select “SYSTEM”.
- Use the “▲” and “▼” buttons to highlight the options
 - PASSWORD
 - VIDEO SETUP
 - AUDIO SETUP
 - S/W UPDATE
 - TIME SETUP

PASSWORD



- Highlight “PASSWORD” and press the “ENTER” button. When prompted, enter your current password.
- You will then be prompted to enter the New Password.
- Enter the new password again to reconfirm.

Note: The default password is 0000.

VIDEO SETUP

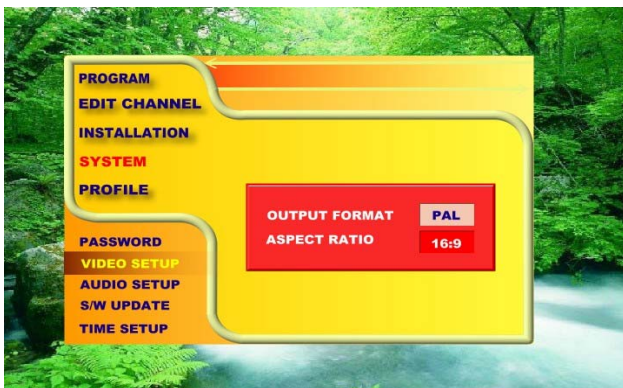

- Highlight “VIDEO SETUP” and press the “ENTER” button.
- Use the “◀” and “▶” buttons to switch between “4:3” and “16:9” picture formats.

AUDIO SETUP

- Highlight “AUDIO SETUP” and press the “ENTER” button.
- Use the “▲” and “▼” buttons to switch between “PCM” and “Dolby® Digital” .

Note: The digital audio output will automatically output in PCM format whenever switching to a channel without Dolby® Digital sound track.

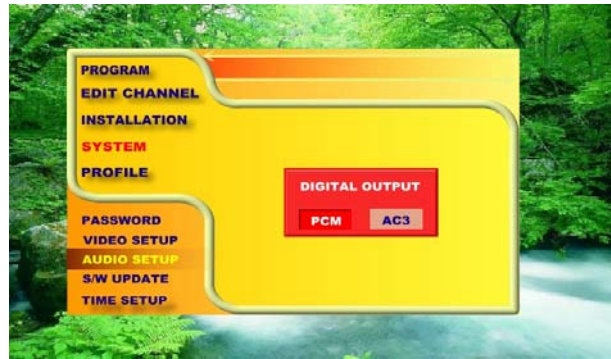

Digital output: PCM and Dolby digital (add description here)

Note: You need to connect to an amplifier with AC-3 decoding capability via Digital Audio (SPDIF) Output when Dolby Digital option is selected. Otherwise, you may encounter softer audio from TV output.

Audio Format English (MPEG1) & English (Dolby)

SOFTWARE UPDATE

This option in System page updates the software in the receiver. However, before you proceed to update the software, please consult your local dealer first and make sure you know how to operate Microsoft Windows HyperTerminal on your computer.

- Highlight “S/W UPDATE” and press the “ENTER” button.
- Use the “◀” and “▶” buttons to highlight between “YES” and “NO”.
- **Before you select “YES”, please follow the steps outlined below to configure your PC first:**
 - (a) Connect PC to your HD-S23 receiver with a cross-over RS232 cable (cable for null modem)
 - (b) On the PC side:
 - Launch the Windows HyperTerminal application.
 - Name the connection.
 - Select the correct COM port – usually COM1.
 - Use the following COM port settings:
 - baud rate: 115200
 - data: 8
 - parity: none
 - stop bit: 1
 - flow control: none
 - Select HyperTerminal’s basic function “Transfer”.
 - Select “Send File”.
 - Browse to select the updated software file.
 - Transfer protocol: “1K Xmodem”**DON’T click on the “Send” button at this time yet.**



- Now that your PC has been properly configured, you can highlight “YES” on the TV screen and press the “ENTER” button on the remote control.

- To be continued on the next page -



- After selecting “YES”, you will see the current software version and its size on the TV screen. Make sure this software version is different from the version of the new software file stored on your PC. Select “YES” again to proceed with the download.

- Now click on the “Send” button on your PC Hyperterminal to start uploading the new software.

- On the TV screen, you will see the window with a status bar indicating the download progress

- When download is completed, the receiver will reboot automatically.

- After the receiver is booted up, you will see a message window informing you that the receiver’s database is empty.

- Press the “MENU” button on the remote control, select “PROFILE” then select “INFORMATION” to confirm the current software is indeed changed to the new one. You can then proceed to scan digital TV channels by following instructions on pp. XX and XX.

TIME SETUP



- Highlight “ TIME SETUP” and press the “ENTER” button.

- Use the “◀” and “▶” buttons to select the local time zone you are located in.

EDIT CHANNEL

Zinwell to-do:

Add the screen snapshot for EDIT CHANNEL here.



Add two selections here.

FAV & LOCK

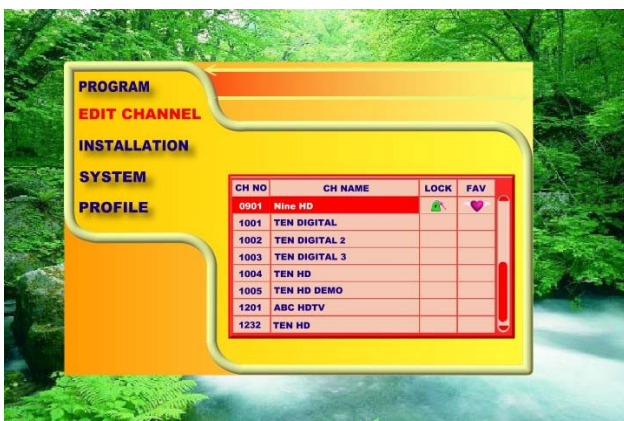

- On the main menu, select “EDIT CHANNEL”.

- Use the “▲” and “▼” buttons to highlight the options
 - FAV & LOCK
 - PARENTAL RATE

- Highlight “FAV & LOCK” and press the “ENTER” button.

- Use the “▲” and “▼” buttons to select the channel, use the “◀” and “▶” buttons to select “LOCK” or “FAV”.

- Highlight “LOCK” and press the “ENTER” button to lock the selected channel.

- Highlight “FAV” and press the “ENTER” button to add the selected channel into the favourite list.

PARENTAL GUIDANCE (RATING)



- On the “EDIT CHANNEL” page, highlight “PARENTAL RATING” and press the “ENTER” button to block programs.

- Use the “▲” and “▼” buttons to select the Rating and press the “EXIT” button to confirm the setting.

- When DTV programs broadcasted are accompanied by the ratings, the programs will be blocked based on your setting. You have to enter PASSWORD to resume watching the program.

- Please refer to Appendix 3 for details.

PROFILE

- On the main menu, select “PROFILE”.
- Use the “▲” and “▼” buttons to highlight the options
 - TRANSPARENCY
 - I-PLATE SETUP
 - INFORMATION



TRANSPARENCY

- Highlight “TRANSPARENCY” and press the “ENTER” button.
- Use the “◀” and “▶” buttons to change the degree of transparency of the on-screen-display.

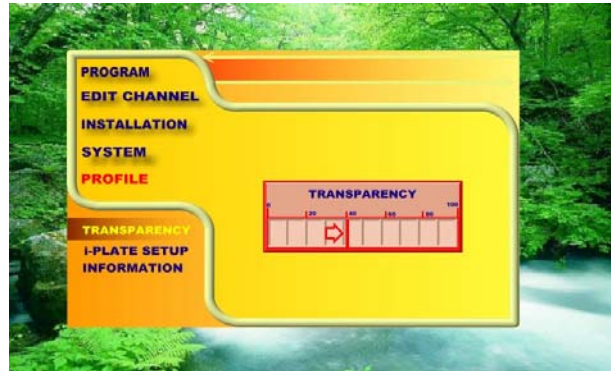

I-PLATE SETUP



- Highlight “I-PLATE SETUP” and press the “ENTER” button.
- Use the “▲” and “▼” buttons to highlight “Fading Mode”, “Display Time” and “Time Format”.
- Use the “◀” and “▶” buttons to change the values of the highlighted options.

INFORMATION

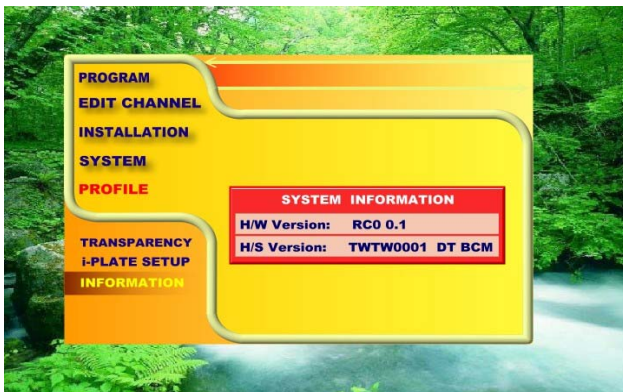

- Highlight “INFORMATION” and press the “ENTER” button to check hardware and software versions.

UQuick Control

Simple use of a single button enables access to some functions directly

- **I-Plate (Info)**
- **AUX In (External Video/Audio Input)**
- **PIP (Picture-in-Picture)**
- **Teletext / Closed Caption**
- **Favorite Channel List**
- **Freeze**
- **A.Ratio**

I-PLATE (INFO)



- When watching DTV channels (without any menu on the screen) , press the “INFO” button.
- I-PLATE will pop up with the following information:
 - Current Channel Number
 - Network Name
 - Program Name
 - Audio System (Dolby® Digital or MPEG)
 - Teletext
 - Current Local Time
 - Date and Month
 - Parental Guidance



- When I-PLATE is still on the TV screen, you can press the “INFO” button again to call up the extended program information (also known as electronic program guide) of the current TV channel.
- Please refer to pp. XX for details on electronic program guide.

AUX IN (External Video/Audio Input)

- Press the “AUX” button on the remote control to select the following options:
 - OFF-AIR
 - AUX
- Use the “▲” and “▼” buttons to highlight the options and press the “ENTER” button to select.

User can change to any other format by pressing the “V.Format” button. (Please refer to Pg 9). This feature is possible only through the use of “OUT2” connector (Y/Pb/Pr).



PIP (Picture-in-picture)

- When watching a TV program (not in the main menu), press the “PIP” button on the remote control to bring up the PIP menu with a list of different programs .
- Use the “▲” and “▼” buttons to browse through the program list.
- Highlight a program and press the “ENTER” button to show “picture-in-picture” – two programs playing on the TV screen at the same time.
- To close PIP window, press the “PIP” button and select “PIP OFF”.

NOTE: When playing VCR movie in PIP window through AUX IN connection, you may encounter poor picture quality if old video tape is used.



TELETEXT / CLOSED CAPTION



- When I-PLATE indicates the presence of Teletext, you can press the “TTX/CC” button on the remote control to display it on the TV screen.
- To show the close caption on TV screen, press “TTX/CC” button and go to page “801”.

Note: Close caption will be disabled when new OSD was displayed on screen.

FAVOURITE CHANNEL LIST



- Press the “FAV” button on the remote control to call up the Favourite List.
- Use the “▲” and “▼” buttons to browse through the favourite list and highlight the program you want to watch.
- Press the “ENTER” button to confirm your selection.

FREEZE

Zinwell to add description here for FREEZE button!

A.RATIO

Zinwell to add description here for A.RATIO button!

UAppendices

- **DTV Channel Table**
- **Troubleshooting**
- **Parental Guidance Codes**
- **Glossary**
- **Technical Specifications**
- **Accessories**

APPENDIX 1 DTV CHANNEL TABLE

The following is a list of DTV channels available in your area. You can use it for “MANUAL SETUP”: On the “MANUAL SETUP” page, select the VHF or UHF channel number and input the Middle Frequency based on “KHz”. For instance, if you are in Sydney and want to manually scan “Digital 7”, enter “MANUAL SETUP” page, select “Channel 6” and make sure the Frequency is “177500” KHz, then start scanning. Please refer to “MANUAL SETUP” on pp. XX for details.

For Australia:

City	Identifier	Channel & Middle Frequency	Transmitter Location	Start Date
Adelaide	Digital 7	VHF 6 - 177.5MHz	Mt Lofty	1/1/2001
	Digital 9	VHF 8 - 191.625MHz	Main Transmitter - Mt Lofty	1/1/2001
	Digital 10	VHF 11 - 219.5MHz	Main Transmitter - Mt Lofty	1/1/2001
	Digital ABC	VHF 12 - 226.5MHz	Main Transmitter - Crafers	1/1/2001
	Digital SBS	UHF 28- 564.5MHz	Main Transmitter - Mt Lofty	1/1/2001
Brisbane	Digital 7	VHF 6 - 177.5MHz	Main Transmitter - Mt Coot-tha	1/1/2001
	Digital 9	VHF 8 - 191.625MHz	Main Transmitter - Mt Coot-tha	1/1/2001
	Digital 10	VHF 11 - 219.5MHz	Main Transmitter - Mt Coot-tha	1/1/2001
	Digital ABC	VHF 12 - 226.5MHz	Main Transmitter - Mt Coot-tha	1/1/2001
	Digital SBS	UHF 36 - 585.5MHz	Main Transmitter - Mt Coot-tha	1/1/2001
Melbourne	Digital 7	VHF 6 - 177.5MHz	Main Transmitter - Mt Dandenong	1/1/2001
	Digital 9	VHF 8 - 191.625MHz	Main Transmitter - Mt Dandenong	1/1/2001
	Digital 10	VHF 11 - 219.5MHz	Main Transmitter - Mt Dandenong	1/1/2001
	Digital ABC	VHF 12 - 226.5MHz	Main Transmitter - Mt Dandenong	1/1/2001
	Digital SBS	UHF 29 - 536.625MHz	Main Transmitter - Mt Dandenong	1/1/2001
Perth	Digital 7	VHF 6 - 177.5MHz	Main Transmitter - Carmel	1/1/2001
	Digital 9	VHF 8 - 191.625MHz	Main Transmitter - Carmel	1/1/2001
	Digital 10	VHF 11 - 219.5MHz	Main Transmitter - Carmel	1/1/2001
	Digital ABC	VHF 12 - 226.5MHz	Main Transmitter - Carmel	1/1/2001
	Digital SBS	UHF 29 - 536.625MHz	Main Transmitter - Bickley	1/1/2001
Sydney	Digital 7	VHF 6 - 177.5MHz	Main Transmitter Artarmon	1/1/2001
	Digital 9	VHF 8 - 191.625MHz	Main Transmitter Artarmon	1/1/2001
	Digital 10	VHF 11 - 219.5MHz	Main Transmitter Artarmon	1/1/2001
	Digital ABC	VHF 12 - 226.5MHz	Main Transmitter Artarmon	1/1/2001
	Digital SBS	UHF 34 - 571.5MHz	Main Transmitter Gore Hill	1/1/2001

City	Identifier	Channel & Middle Frequency	Transmitter Location	Start Date
Batchelor	QQQ -51	UHF 50 - 683.5MHz		
	SBS -54	UHF 53 - 704.5MHz		
	ABD -69	UHF 56 - 725.5MHz		
	NTD -60	UHF 59 - 746.5MHz		
	TND -63	UHF 62 - 767.5MHz		
	IMP -66	UHF 65 - 788.5MHz		
Canberra	CTC -7	VHF 6 - 177.5MHz	Telstra Tower Black Mountain	6/30/2002
	ABC -9	VHF 9A - 205.5MHz	Telstra Tower Black Mountain	6/30/2002
	WIN -31	VHF 11 - 219.5MHz	Telstra Tower Black Mountain	6/30/2002
	CBN -34	VHF 12 -226.5MHz	Telstra Tower Black Mountain	6/30/2002
	SBS -28	UHF 30 -613.5MHz	Telstra Tower Black Mountain	6/30/2002
Darwin	SBS -28	UHF 29 - 536.5MHz	Deloraine Rd	6/30/2002
	ABC -6	UHF 30 - 543.5MHz	Deloraine Rd	6/30/2002
	NTD -8	UHF 31 - 550.5MHz	Deloraine Rd	6/30/2002
	TND -34	UHF 32 -557.5MHz	Deloraine Rd	6/30/2002
Newcastle	NBN -3	UHF 36 - 585.5MHz	Mt Sugarloaf	6/30/2001
	NEN -54	UHF 53 - 704.5MHz	Broadcast Site Mt Sugarloaf	6/30/2001
	NRN -57	UHF 51 - 690.5MHz	Broadcast Site Mt Sugarloaf	6/30/2001
	ABHN -5A/4B	UHF 37 - 592.5MHz	Mt Sugarloaf	6/30/2001
	SBS -45	UHF 38 - 599.5MHz	Mt Sugarloaf	6/30/2001
Wollongong	WIN -59	UHF 36 - 585.5MHz	WIN Tower Knights Hill	TBA
	CTC -62	UHF 37 - 592.5MHz	NTL Tower Knights Hill	TBA
	CBN -65	UHF 38 - 599.5MHz	WIN Tower Knights Hill	6/30/2002
	ABWN -56	UHF 51 - 690.5MHz	NTL Tower Knights Hill	6/30/2002
	SBS -53	UHF 54 - 711.5MHz	NTL Tower Knights Hill	6/30/2002

For Singapore:

City	Identifier	Channel & Middle Frequency	Transmitter Location	Start Date
Singapore	TV Mobile	VHF 602MHz	Singapore	3/1/2001

Note:

- (a) On the Channel Number Display of receiver's front panel you will find the logical channel number different from VHF/UHF channel number shown in the column "Channel & Middle Frequency" of this table.
- (b) If you have trouble getting DTV channel's signal, please contact your local antenna installer for help.
- (c) The channel table in this manual may not be up-to-date. To get the latest channel table, please contact your local dealer.

APPENDIX 2 TROUBLESHOOTING

Problem	Solution
(1) The receiver front panel power indicator doesn't light up, and no message on the front panel	<ul style="list-style-type: none"> (a) Check the AC mains supply and make sure the power plug is well plugged into a stable power outlet (b) Press the "Power" button on the front panel to see if the LED display is on. (c) Press the "Power" button on the remote control to see if the LED display is on.
(2) Message is shown on the front panel but no picture on TV screen	<ul style="list-style-type: none"> (a) Make sure the connection between the receiver and TV matches the mode your TV should be set to. For instance, if you use a RCA cable you may choose external video input mode in TV. (b) Check the brightness level of your TV. <p>Zinwell to-do: Add OUT1/OUT2 descriptions here.</p>
(3) Poor picture quality	<ul style="list-style-type: none"> (a) Check the antenna and make sure it is aligned to the correct direction. Use the receiver's "MANUAL SETUP" page to check the signal's BER and RF Level when aligning the antenna. (b) If you use any kind of amplifier to boost the signal level, please check whether it works well, and ask help from the antenna installer.
(4) No sound	<ul style="list-style-type: none"> (a) Check the receiver and your TV's volume are properly set and not in "Mute" mode. (b) Check the audio connectors are correctly and firmly connected. (c) Make sure the receiver is switched to the correct Audio mode: Dolby® Digital or PCM. (d) Rescan this channel by using "MANUAL SETUP". (e) Switch to other channels for confirmation on audio.
(5) No picture	<ul style="list-style-type: none"> (a) Check the video cables are correctly and firmly connected. (b) Rescan this channel by using "MANUAL SETUP". (c) Switch to other channels for confirmation on video.
(6) Not all channels are available after using "AUTO SCAN" when installing the receiver for the first time	<p>Try "MANUAL SETUP" to scan these missing channels. This problem is caused by unexpected frequency offset, for instance, in Sunshine Coast Australia, channels 47 and 65 are transmitted on 662.625 and 788.625 MHz by 125KHz offset to the legitimate frequencies 662.5 and 788.5 MHz. HD-S23 can receive them by "AUTO SCAN" most of the times, but we suggest that you use "MANAL SETUP" when installing the receiver for the first time. Once the signal is picked up by the receiver, all the transmission parameters will be stored in the receiver's memory.</p>
(7) Not all channels are available after using "QUICK SCAN"	<ul style="list-style-type: none"> (a) Try "AUTO SCAN" to scan all the channels. (b) If you still cannot get some channels please use "MANUAL SETUP" to scan them one by one.
(8) Cannot lock signal by using "MANUAL SETUP"	<ul style="list-style-type: none"> (a) Check the frequency you entered is exactly the centre frequency of the wanted channel. (b) Please refer to solutions in item (3) on pp. XX.
(9) No Teletext	<p>Make sure the channel you are watching carries Teletext information from I-PLATE.</p>
(10) Cannot receive channels after moving the receiver between cities (for instance from Melbourne to Sydney)	<p>Please refer to pp. XX for reinstallation.</p>
(11) RCU button pressed not responding.	<p>Replace remote control unit batteries.</p>

APPENDIX 2 TROUBLESHOOTING (CONTINUED)

* On Screen Message

Message	Solution
(1) Bad Signal	(a) Check the antenna is connected correctly and firmly to the tuner input (ANT IN) of the receiver. (b) Refer to solutions in Item (3) on pp. XX.
(2) Non Support HD Format	The HDTV digital channel cannot be shown on the small PIP window.
(3) Weak Signal	Make sure antenna or signal input cable is connected correctly.
(4) Database is Empty	No channel data available in the box. Please refer to pp. XX for reinstallation.
(5) Program is Under Guard	Please input the correct password or change lock setting in menu to view the program.
(6) Program is Locked by Guard Rate	Please input the correct password or change parental-rate (refer to pp. Error! Bookmark not defined.) to view the program.
(7) Program Rate is over Guard Rate [xxx]	Please input the correct password or change parental-rate (refer to pp. 24) to view the program.
(8) Incorrect Password	Please input the correct password.

APPENDIX 3 PARENTAL GUIDANCE CODES

AUSTRALIAN PARENTAL GUIDANCE CODES

(Normative)

Recommended on-screen-display for parental guidance codes transmitted within DVB-SI information using the DVB parental_rating_descriptor.

			Receiver Menu Set-up and Suggested OSD Wording for Setting Blocking (Restriction of access)							
			Block All	Block G and above (optional)	Block PG and above	Block M and above	Block MA and above	Block AV and above	Block R and above	No Block
Transmitted rating hex code	Australian parental guide code	On-screen display	Resultant receiver action to received hex code ✓ is show program — X is block until PIN entered							
0x00	Not Classified	-	X	✓	✓	✓	✓	✓	✓	✓
0x01		-	X	✓	✓	✓	✓	✓	✓	✓
0x02	P Preschool	P	X	✓	✓	✓	✓	✓	✓	✓
0x03		P	X	✓	✓	✓	✓	✓	✓	✓
0x04	C Children's	C	X	✓	✓	✓	✓	✓	✓	✓
0x05		C	X	✓	✓	✓	✓	✓	✓	✓
0x06	G General	G	X	X	✓	✓	✓	✓	✓	✓
0x07		G	X	X	✓	✓	✓	✓	✓	✓
0x08	PG Parental Guidance Recommended	PG	X	X	X	✓	✓	✓	✓	✓
0x09		PG	X	X	X	✓	✓	✓	✓	✓
0x0A	M Mature Audience 15+	M	X	X	X	X	✓	✓	✓	✓
0x0B		M	X	X	X	X	✓	✓	✓	✓
0x0C	MA Mature Adult Audience 15+	MA	X	X	X	X	X	✓	✓	✓
0x0D		MA	X	X	X	X	X	✓	✓	✓
0x0E	AV Adult Audience, Strong Violence 15+	AV	X	X	X	X	X	X	✓	✓
0x0F	R Restricted 18+	R	X	X	X	X	X	X	X	✓

APPENDIX 4 GLOSSARY

- * **Aspect Ratio:** It is the ratio of the width of the screen to the height. The two relevant digital TV formats are 16:9 (widescreen) or 4:3 (the traditional screen ratio). 16:9 is more ergonomically suitable for the human eye.
- * **Bandwidth:** Frequency range allows for carrying a certain radio signal. The speed of data transmission depends on the available bandwidth of the transmission channel.
- * **Coaxial Cable:** A type of cable used to transmit high frequency signals e.g. from the VHF/UHF antenna to the terrestrial Digital TV receiver.
- * **Composite Video:** There are three elements of the video system: First - the " active video" which means the picture to be displayed on the screen and its associated colors. Second - the " sync" decides where to place each pixel on the screen. Third - the " blanking" tells the display when to turn off the electron beam so no retrace across the screen. These three elements combined together is called " composite video" when connecting to a display through connectors.
- * **Dolby® Digital:** Dolby® Digital is a method of transmitting and storing multi-channel soundtracks via newer digital media such as DVD, digital cable, digital broadcast TV (DTV), and satellite transmissions.
- * **DVB:** Abbreviation for "Digital Video Broadcasting". An international organization created in October 1993, whose primary objective is to achieve a common framework for all technical platforms of digital broadcasting systems including DVB-C (cable), DVB-S (satellite), DVB-T (terrestrial), DVB-MC (MMDS), DVB-CS(SMATV).
- * **EPG:** Abbreviation for "Electronic Program Guide". A software that enable viewers to navigate through the large number of channels offered by digital TV broadcaster and select the desired services.
- * **Frequency:** The property of a signal which is measured in cycles per second(=Hertz).
- * **Letterbox :** The picture with aspect ratio 16:9 in a 4:3 TV screen with blank lines on top and bottom. It is the means to watch a wide screen TV program on a 4:3 TV screen.
- * **Megahertz (MHz):** Millions of cycles per second, which describes frequencies of radio wave or electric current.
- * **OSD:** Abbreviation of "On Screen Display", used in digital set top box. OSD is comprised of a main menu and many sub-menus with lots of options of functions inside.
- * **PAL:** Stands for "Phase Alternating Line", the European video standard which has the image format of 4 by 3, 625 horizontal lines, 50 Hz and a total 8 MHz of video channel width.
- * **PID :** Stands for "Packet Identifier". It is a code used for identifying video, audio PCR and other elements that form a particular service in the transport stream.
- * **RF Channel:** Radiated Frequency Channel, for instance channel 28 for SBS Network in analog TV transmission. However in digital TV, one RF channel may carry 4 to 6 sub-channels like SBS HD, SBS Digital.
- * **S-Video (also called Y/C):** The standard for the way a video signal is carried on the cable. Y represents brightness and C represents color. S-Video cables have separate wires for the color and brightness so it offers a better picture quality than the composite video.
- * **VHF:** Stands for "Very High Frequency", starts from 30 to 300 MHz corresponding to channels 2-12, including Bands I, II and III.
- * **UHF:** Stands for "Ultra High Frequency", starts from 300 to 3000 MHz corresponding to channels 13-69, including Bands IV and V.
- * **Y/Pb/Pr:** Component Video Output. It is better than S-Video and Composite Video output in terms of picture quality. Y/Pb/Pr is the standard HDTV connector.

System

Compliant Standard	DVB-T
Video Decoding	MP @ ML & MP @ HL
Audio Decoding	Dolby® Digital, MPEG (I & II)
Audio Sampling Rate	32, 44.1, 48 KHz

Terrestrial Tuner / Demodulator

Frequency	51~858 MHz
Loop Through	51~858 MHz
Bandwidth	6, 7, 8 MHz
Demodulator	COFDM
FFT Mode	2K, 8K
Constellation	QPSK, 16QAM, 64 QAM
Guard Interval	1/4, 1/8, 1/16, 1/32
Inner Coding Rate	1/2, 2/3, 3/4, 5/6, 7/8

Video Output

Format	1920 × 1080i, 1280 × 720p, 720 × 576p, PAL: 720 × 576i
Aspect Ratio	4:3, 16:9

Video Input

Format	Composite Video
--------	-----------------

Digital Audio Output

Mode	Decompressed PCM, Compressed Dolby Digital
------	--

Audio Input

Format	Stereo
--------	--------

Front Panel

IR Receiver	Yes
Function Control	7 Keys
Channel Display	4 Digits / 7-segment display

Rear Panel

Tuner Input	1 × IEC-Female
Video Input Port	1 × RCA
Stereo Audio Input Port	2 × RCA
S-Video Output Port	1
Video Output Port	1 × RCA
Y/Pb/Pr Video Output Port	3 × RCA
Stereo Audio Output Port	2 × RCA
Digital Audio Output Port	1 × S/PDIF Optical

Power Supply

Input Voltage	100~240 V _{AC} , 50/60 Hz
Consumption (max.)	30 W

Dimension

Size (W × D × H)	430 × 80 × 290 mm
Weight	3.5 Kg (Unpacked)

Environmental Data

Operating Temperature	5°~ 40°C
Storage Temperature	-40°~ 65°C

*Specifications are subject to change without notice.

P/N:

APPENDIX 6 ACCESSORIES

- Remote Control (CT-90175)
- Audio/Video cable with RCA jacks
- Component Video cable (Y/Pb/Pr)
- Power cord (Singapore/Australia)
- Two AAA batteries