

TOSHIBA DVD VIDEO RECORDER D-RW2SU / D-RW2SC

TOSHIBA



DVD VIDEO RECORDER

D-RW2SU / D-RW2SC

OWNER'S MANUAL



**OPERATIONS
GUIDE**



Introduction

Connections

Basic Setup

Recording

Playback

Editing

Function Setup

Others

TOSHIBA

Printed in China

1VMN22115 / E7A70UD ★★★★★

© 2006 Toshiba Corporation

Precautions

WARNING: TO REDUCE THE RISK OF FIRE OR ELECTRIC SHOCK, DO NOT EXPOSE THIS APPLIANCE TO RAIN OR MOISTURE.



CAUTION
RISK OF ELECTRIC SHOCK
DO NOT OPEN



The lightning flash with arrowhead symbol, within an equilateral triangle, is intended to alert the user to the presence of uninsulated "dangerous voltage" within the product's enclosure that may be of sufficient magnitude to constitute a risk of electric shock to persons.



The exclamation point within an equilateral triangle is intended to alert the user to the presence of important operating and maintenance (servicing) instructions in the literature accompanying the appliance.

CAUTION:

TO REDUCE THE RISK OF ELECTRIC SHOCK, DO NOT REMOVE COVER (OR BACK). NO USER SERVICEABLE PARTS INSIDE. REFER SERVICING TO QUALIFIED SERVICE PERSONNEL.

Laser Safety

This unit employs a laser. Only a qualified service person should remove the cover or attempt to service this device, due to possible eye injury.

CAUTION: USE OF CONTROLS OR ADJUSTMENTS OR PERFORMANCE OF PROCEDURES OTHER THAN THOSE SPECIFIED HEREIN MAY RESULT IN HAZARDOUS RADIATION EXPOSURE.

CAUTION: VISIBLE AND INVISIBLE LASER RADIATION WHEN OPEN AND INTERLOCK DEFEATED. DO NOT STARE INTO BEAM.

Location of Required Label: Back Cover

FCC WARNING- This equipment may generate or use radio frequency energy. Changes or modifications to this equipment may cause harmful interference unless the modifications are expressly approved in the manual. The user could lose the authority to operate this equipment if an unauthorized change or modification is made.

RADIO-TV INTERFERENCE

This equipment has been tested and found to comply with the limits for a Class B digital device, pursuant to Part 15 of the FCC Rules. These limits are designed to provide reasonable protection against harmful interference in a residential installation. This equipment generates, uses, and can radiate radio frequency energy and, if not installed and used in accordance with the instructions, may cause harmful interference to radio communications. However, there is no guarantee that interference will not occur in a particular installation. If this equipment does cause harmful interference to radio or television reception, which can be determined by turning the equipment off and on, the user is encouraged to try to correct the interference by one or more of the following measures:

- 1) Reorient or relocate the receiving antenna.
- 2) Increase the separation between the equipment and receiver.
- 3) Connect the equipment into an outlet on a circuit different from that to which the receiver is connected.
- 4) Consult the dealer or an experienced radio/TV technician for help.

This Class B digital apparatus complies with Canadian ICES-003.

Cet appareil numérique de la classe B est conforme à la norme NMB-003 du Canada.

CAUTION: TO PREVENT ELECTRIC SHOCK, MATCH WIDE BLADE OF PLUG TO WIDE SLOT, FULLY INSERT.

ATTENTION: POUR ÉVITER LES CHOC ÉLECTRIQUES, INTRODUIRE LA LAME LA PLUS LARGE DE LA FICHE DANS LA BORNE CORRESPONDANTE DE LA PRISE ET POUSSER JUSQU'AU FOND.

A NOTE ABOUT RECYCLING

This product's packaging materials are recyclable and can be reused. Please dispose of any materials in accordance with your local recycling regulations.

Batteries should never be thrown away or incinerated but disposed of in accordance with your local regulations concerning chemical wastes.

Make your contribution to the environment!!!

- Used up batteries do not belong in the dust bin.
- You can dispose of them at a collection point for used up batteries or special waste. Contact your council for details.



For Customer Use:

Read carefully the information located at the back of this unit and enter below the Model No. and Serial No. Retain this information for future reference.

Model No. _____

Serial No. _____

IMPORTANT SAFEGUARDS

1. Read Instructions - All the safety and operating instructions should be read before the appliance is operated.
2. Retain Instructions- The safety and operating instructions should be retained for future reference.
3. Heed Warnings - All warnings on the appliance and in the operating instructions should be adhered to.
4. Follow Instructions - All operating and use instructions should be followed.
5. Cleaning - Unplug this product from the wall outlet before cleaning. Do not use liquid cleaners or aerosol cleaners. Use a damp cloth for cleaning.
EXCEPTION: A product that is meant for uninterrupted service and, that for some specific reason, such as the possibility of the loss of an authorization code for a CATV converter, is not intended to be unplugged by the user for cleaning or any other purpose, may exclude the reference to unplugging the appliance in the cleaning description otherwise required in item 5.
6. Attachments - Do not use attachments not recommended by the product manufacturer as they may cause hazards.
7. Water and Moisture- Do not use this product near water, for example, near a bath tub, wash bowl, kitchen sink, or laundry tub, in a wet basement, or near a swimming pool, and the like.
8. Accessories - Do not place this product on an unstable cart, stand, tripod, bracket, or table. The product may fall, causing serious injury to a child or adult, and serious damage to the appliance. Use only with a cart, stand, tripod, bracket, or table recommended by the manufacturer, or sold with the product. Any mounting of the appliance should follow the manufacturer's instructions and should use a mounting accessory recommended by the manufacturer. An appliance and cart combination should be moved with care. Quick stops, excessive force, and uneven surfaces may cause the appliance and cart combination to overturn.
9. Ventilation - Slots and openings in the cabinet are provided for ventilation and to ensure reliable operation of the product and to protect it from overheating, and these openings must not be blocked or covered. The openings should never be blocked by placing the product on a bed, sofa, rug, or other similar surface. This product should not be placed in a built-in installation such as a bookcase or rack unless proper ventilation is provided or the manufacturer's instructions have been adhered to.
10. Power Sources - This product should be operated only from the type of power source indicated on the marking label. If you are not sure of the type of power supply to your home, consult your appliance dealer or local power company. For products intended to operate from battery power, or other sources, refer to the operating instructions.
11. Grounding or Polarization - This product is equipped with a polarized alternating-current line plug (a plug having one blade wider than the other). This plug will fit into the power outlet only one way. This is a safety feature. If you are unable to insert the plug fully into the outlet, try reversing the plug. If the plug should still fail to fit, contact your electrician to replace your obsolete outlet. Do not defeat the safety purpose of the polarized plug.
12. Power Cord Protection - Power supply cords should be routed so that they are not likely to be walked on or pinched by items placed upon or against them, paying particular attention to cords at plugs, convenience receptacles, and the point where they exit from the appliance.
13. Outdoor Antenna Grounding - If an outside antenna or cable system is connected to the product, be sure the antenna or cable system is grounded so as to provide some protection against voltage surges and built-up static charges. Article 810 of the

National Electrical Code, ANSI/NFPA No. 70, provides information with regard to proper grounding of the mast and supporting structure, grounding of the lead-in wire to an antenna discharge unit, size of grounding conductors, location of antenna-discharge unit, connection to grounding electrodes, and requirements for the grounding electrode. (Fig. A)

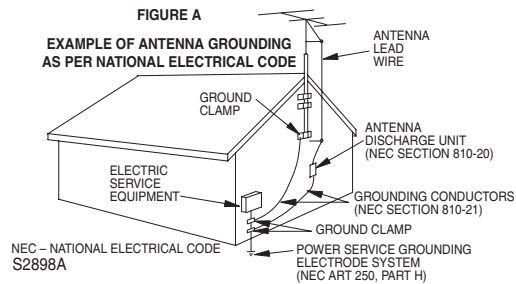

14. Lightning - For added protection for this product during a lightning storm, or when it is left unattended and unused for long periods of time, unplug it from the wall outlet and disconnect the antenna or cable system. This will prevent damage to the product due to lightning and power-line surges.
15. Power Lines - An outside antenna system should not be located in the vicinity of overhead power lines or other electric light or power circuits, or where it can fall into such power lines or circuits. When installing an outside antenna system, extreme care should be taken to keep from touching such power lines or circuits as contact with them might be fatal.
16. Overloading - Do not overload wall outlets and extension cords as this can result in a risk of fire or electric shock.
17. Object and Liquid Entry - Never push objects of any kind into this product through any openings as they may touch dangerous voltage points or short-out parts that could result in a fire or electric shock. Never spill liquid of any kind on the product.
18. Servicing - Do not attempt to service this product yourself as opening or removing covers may expose you to dangerous voltage or other hazards. Refer all servicing to qualified service personnel.
19. Damage Requiring Service - Unplug this product from the wall outlet and refer servicing to qualified service personnel under the following conditions:
 - a. When the power-supply cord or plug is damaged.
 - b. If liquid has been spilled, or objects have fallen into the product.
 - c. If the product has been exposed to rain or water.
 - d. If the product does not operate normally by following the operating instructions. Adjust only those controls that are covered by the operating instructions as an improper adjustment of other controls may result in damage and will often require extensive work by a qualified technician to restore the product to its normal operation.
 - e. If the product has been dropped or damaged in any way.
 - f. When the product exhibits a distinct change in performance this indicates a need for service.
20. Replacement Parts - When replacement parts are required, be sure the service technician has used replacement parts specified by the manufacturer or have the same characteristics as the original part. Unauthorized substitutions may result in fire, electric shock or other hazards.
21. Safety Check - Upon completion of any service or repairs to this product, ask the service technician to perform safety checks to determine that the product is in proper operating condition.
22. Heat - This product should be situated away from heat sources such as radiators, heat registers, stoves, or other products (including amplifiers) that produce heat.

PORTABLE CART WARNING
(Symbol provided by RETAC)



Installation Location

For safety and optimum performance of this unit:

- Install the unit in a horizontal and stable position. Do not place anything directly on top of the unit. Do not place the unit directly on top of the TV.
- Shield it from direct sunlight and keep it away from sources of intense heat. Avoid dusty or humid places. Avoid places with insufficient ventilation for proper heat dissipation. Do not block the ventilation holes on the sides of the unit. Avoid locations subject to strong vibration or strong magnetic fields.

Avoid the Hazards of Electrical Shock and Fire

- Do not handle the power cord with wet hands.
- Do not pull on the power cord when disconnecting it from AC wall outlet. Grasp it by the plug.
- If, by accident, water is spilled on this unit, unplug the power cord immediately and take the unit to authorized service centers for servicing. (For questions regarding authorized service centers, call TACP's Consumer Solution Center mentioned on page 155 or, for Canada, call TCL customer support line mentioned on page 156.)

Moisture Condensation Warning

Moisture condensation may occur inside the unit when it is moved from a cold place to a warm place or after heating a cold room or under conditions of high humidity. Do not use this unit at least for 2 hours until its inside gets dry.

About Copyright

The unauthorized recording, use, distribution, or revision of television programs, videotapes, DVDs and other materials, is prohibited under the Copyright Laws of the United States and other countries, and may subject you to civil and/or criminal liability.

This product incorporates copyright protection technology that is protected by U.S. patents and other intellectual property rights. Use of this copyright protection technology must be authorized by Macrovision, and is intended for home and other limited viewing uses only unless otherwise authorized by Macrovision. Reverse engineering or disassembly is prohibited.

Notice for Progressive Scan Outputs

Consumers should note that not all high definition television sets are fully compatible with this product and may cause artifacts to be displayed in the

picture. In case of picture problems with 525 progressive scan output, it is recommended that the user switch the connection to the 'standard definition' output. If there are questions regarding your TV set compatibility with this 525p DVD recorder, please contact TACP's Consumer Solution Center or ,for Canada, TCL customer support line.

Supplied Accessory

- Remote control (NB306UD) with two AA batteries



- RF cable (WPZ0901TM002)



- Audio/Video cables (WPZ0152TM014)

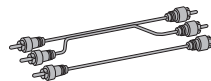

- OWNER'S MANUAL (1VMN22115)

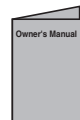

- Quick Guide (1VMN22370)



- Quick Guide - Español (1VMN22574)



- Return Stop Sheet (1VMN22116)



- Registration card (1VMN22393)



Maintenance

SERVICING

- Please refer to relevant topics on “Troubleshooting” on pages 146-150 before returning the product.
- If this unit becomes inoperative, do not try to correct the problem by yourself. There are no user-serviceable parts inside. Turn off, unplug the power plug and please call TACP’s Consumer Solution Center mentioned on page 155. (For Canada, call TCL customer support line mentioned on page 156.)

CLEANING THE CABINET

- Use a soft cloth slightly moistened with mild detergent solution. Do not use any solution containing alcohol, spirits, ammonia or abrasive.

CLEANING DISCS

- When a disc becomes dirty, clean it with a cleaning cloth. Wipe the disc from the center to out. Do not wipe in a circular motion.
- Do not use solvents such as benzene, thinner, commercially available cleaners, detergent, abrasive cleaning agents or antistatic spray intended for analogue records.

CLEANING THE DISC LENS

- If this unit still does not perform properly although you refer to the relevant sections and to “Troubleshooting” in this Owner’s Manual, the laser optical pickup unit may be dirty. Consult an Authorized Service Center, TACP’s Consumer Solution Center or, for Canada, TCL customer support line for inspection and cleaning of the laser optical pickup unit.

DISC HANDLING

- Handle the discs so that fingerprints and dust do not adhere to the surfaces of the discs.
- Always store the disc in its protective case when it is not used.

“WMA” (Windows Media Audio) is a new audio codec developed by Microsoft® in the United States of America.

Manufactured under license from Dolby Laboratories. “Dolby” and the double-D symbol are trademarks of Dolby Laboratories.

“DTS” and “DTS Digital Out” are trademarks of Digital Theater Systems, Inc.

Dolby Digital Recording

“Dolby® Digital Recording enables consumers to record high-quality video with stereo sound on recordable DVD discs. The technology, when utilized instead of PCM recording, also saves recordable disc space, allowing for higher video resolution or extended recording time on each DVD. DVDs created using Dolby Digital Recording will play back on all DVD-Video players.”

Note:

This is true when the players are compatible with actual recordable DVD discs.

Table of contents

Introduction

■ Precautions	2
■ Table of contents	6
■ Features	8
■ Choosing a disc	9
■ Index to parts and controls	14
■ Preparation of the remote control	19
■ On Screen menu	20

Connections

■ Connection to a TV	24
■ RF modulator Connection	26
■ Connection to a cable box or satellite box ..	27
■ Connection to an Audio System	28

Basic Setup

■ Initial setting	30
■ Channel setting	32
Setting channels automatically	32
Adding/deleting channels	34
■ Selecting TV stereo or SAP	36
■ Setting the clock	38
Auto Clock Setting	38
Manual Clock Setting	41
Setting the Daylight Saving Time	44
■ Selecting the TV aspect ratio	46

Recording

■ Information on DVD recording	50
Information	50
Restrictions on recording	51
Information on copy control	51
Making discs playable in other DVD players (Finalize)	51
■ Selecting the Recording format	52
Choosing the recording format of a brand-new disc	52
Reformatting a disc	54
Setting for Auto Chapter	54
Recording Audio Select (XP)	55
■ Basic recording	56
■ One-touch Timer Recording	59
■ Timer Recording	61
Checking, canceling, or correcting the timer programming information	66
Hints for Timer Recording	67
■ Settings for an external source	68
Connection to an external source	68
Recording from an external source	70
■ Setting disc protection	72
■ Finalizing the discs	74
Auto finalize	76

Playback

■ Basic playback	80
Playback	80
Playing back a DVD-VIDEO / CD	83
Playing MP3, WMA, JPEG disc	84
Playing discs using the Disc menu	86
Playing discs using the Title menu	86
Pause	86
Step by step playback	86
■ Further playback	87
Resume Play	87
Rapid Play	87
Skipping TV commercials during play	87
Fast forward / Fast reverse	88
Slow forward / Slow reverse	88
■ Special playback	89
Zoom	89
Marker Setup	89
Searching by Title, Chapter or Track	90
Searching by Time	90
Repeat Play	91
Random Play	91
Program Play	92
Slide Show	92
■ Selecting the format of audio and video	93
Switching subtitles	93
Switching audio soundtrack	93
Switching virtual surround system	94
Switching camera angles	95
Reducing block noise	95
Adjusting Black Level	96

Editing

■ Information on disc editing	98
Guide to a title list	98
Edit the recorded disc	98
Editing discs	99
Notes for deleting titles	99
■ Editing discs	100
Deleting titles	100
Editing title names	103
Guide to edit title name	105
Adding or deleting chapter marks	106
Setting pictures for thumbnails	108
Deleting parts of titles	110
Dividing a title	114
Combining titles	116
Adding titles to a Playlist	118
Erasing all Playlist	120
Setting or releasing the title protection	122
Setting or clearing all the chapter marks in one title	124

Function Setup

■ Tour of the Setup menu	128
■ Language setting	130
■ Display setting	133
■ Audio setting	135
■ Settings for Parental lock level	138
■ Settings for Progressive Scan Mode	141
■ Settings for Still Mode	144

Others

■ Troubleshooting	146
■ Language code	151
■ Glossary	152
■ Specifications	154
■ Limited United States Warranty	155
■ CANADIAN WARRANTY INFORMATION	156

Features

This DVD unit not only plays DVDs and CDs but also offers features for you to record to DVD discs and edit them after that.

The following features are offered with this unit.

Recording

This unit is compatible with both DVD-RW which is rewritable repeatedly, and DVD-R which is available for recording once. You can choose either one for your convenience.

■ Up to 8 program recording:

You can program the unit to record up to 8 programs, within a month in advance. Daily or weekly program recordings are also available.

■ One-touch Timer Recording:

You can easily set a recording time as you prefer. Every time [REC ●] is pressed during recording, the recording time will be increased by 30 minutes up to 8 hours. The unit will automatically turn off when the recording time you set is reached.

■ Automatic Chapter marks setting:

Chapter marks will be put on recordings as you set in the Setup menu before attempting to record.

■ Automatic Title menu making:

The unit makes title menus automatically when finalizing the disc which are recorded in Video mode.

■ Automatic Playlist making (VR mode):

A Playlist will be prepared from Original titles, so that you can edit titles in a Playlist as you prefer. An Original title is kept as it is.

■ Automatic finalizing (Video mode):

You can finalize discs after finishing all Timer Recordings or at the end of the disc space automatically as you set in the Setup menu.

■ Left channel stereo recording:

This unit can record the sound of the Left channel monaural input as Left and Right channels automatically (the input from the LINE 2 only).

Play

■ Theater surround sound in your home:

When connecting the unit to an amplifier or a decoder which is compatible with Dolby Digital or DTS, you are allowed to experience the theater surround sound from discs with surround sound system.

■ Quick search for what you want to watch:

You can easily find the part you want to watch using the search function. Search for a desired point on a disc by title, chapter, track, or time.

■ Start to play from Original and Playlist:

Title playing is available from either Original titles or Playlist.

■ Virtual Surround System:

You can enjoy stereophonic space through your exciting 2 channel stereo system.

■ Playing back MP3 and WMA disc:

You can enjoy MP3 and WMA files which are recorded on CD-R/RW.

■ JPEG Picture Viewer:

JPEG files formatted on CD-R/RW can be played.

Editing

■ Deleting titles:

You can delete titles which you do not need anymore.

■ Making your own Playlist:

With the original remains as it is, you can edit titles on various Playlist as you prefer.

Editing title names

Setting pictures for thumbnails

Adding or deleting chapter marks

Dividing a title/ combining titles

Deleting parts of titles etc.

■ Protecting titles:

To avoid editing or erasing titles, the protect function is useful when it is ON in the Original titles.

Compatibility

■ Available for playing discs recorded in Video mode on a regular DVD player (Video mode):

Discs recorded in Video mode can be played on regular DVD players, including computer DVD drives compatible with DVD-Video playback*. You will need to finalize the discs recorded in Video mode to play in other DVD players.

* *DVD-Video Format (Video mode) is a new format for recording on DVD-R/RW discs that was approved by the DVD Forum in 2000. Adoption of this format is optional for manufactures of DVD playback devices and there are DVD-Video players, DVD-ROM drives or other DVD playback devices that do not play DVD-R/RW discs recorded in the DVD-Video Format.*

Others

■ Progressive Scan system

Unlike conventional interlace scanning, the progressive scan system provides less flickering and images in higher resolution than that of traditional television signals.

Choosing a disc

When you want to play DVD or CD software, load an appropriate disc into the recorder. There are many types and formats of discs. Please use the following information to select an appropriate disc.

Notes

- Handle the disc according to the disc instruction manual.
- Toshiba cannot guarantee that all discs bearing the DVD or CD logos will operate as expected. Additionally, Toshiba cannot guarantee that discs recorded in this device will operate properly in other DVD players, recorders and/or personal computer drives.

DVD disc types

★★★ : Most suitable ★★ : Can be used ★ : Some functions are limited — : Cannot be used

You want to	DVD-RW VR	DVD-RW Video	DVD-R
Record TV programs	★★★	★★★	★★★
Reuse by deleting unwanted contents	★★★	★★	—
Edit recorded contents	★★★	★	★
Edit/Record from connected equipment	★★★	★★★	★★★
Copy discs for distribution	★★ ^{*1}	★★★	★★★
Play on other DVD equipment	★★ ^{*1}	★★★	★★★

Features	DVD-RW VR	DVD-RW Video	DVD-R
Recording			
Rewritable?	Yes	Yes	No
Can create chapters at fixed intervals (auto.)	Yes	Yes	Yes
Can create chapters wherever you like (manual)	Yes	No	No
Can record 16:9 size pictures	Yes	Yes	Yes
Can record Copy-Once programs	Yes ^{*2}	No	No
Editing			
Can perform basic edit functions	Yes	Yes	Yes
Can perform advanced edit functions (Playlist edit)	Yes	No	No



*1 DVD-RW (VR mode) can only be played on DVD equipment that is VR compatible.

*2 The disc must be labeled as CPRM compatible.

Note:

For details of the above functions and implied restrictions, see the explanations in this manual.

For recording /playback

Disc	Mark	Specification	Remarks
DVD-R		• 4.7GB for General Ver.2.0 (8cm (3 ¹ / ₄ in.)) (12cm (4 ³ / ₄ in.))	Read carefully the section "On DVD-R discs" (page 11). Depending on the disc status or the recording equipment, playback of the disc may not be possible on this recorder.
DVD-RW		• Ver. 1.1 and 1.2 (12cm (4 ³ / ₄ in.))	Read carefully the section "On DVD-RW discs" (page 11). Depending on the disc status or the recording equipment, playback of the disc may not be possible on this recorder.

Using different disc types for different purposes

DVD-R/RW discs when creating your own original discs for distribution







DVD-R discs are designed to comply with the global standard DVD-Video format, and can be recorded only once. DVD-R discs are convenient when you edit your original content (recorded personal events such as a wedding party) with this recorder, transfer them to the recorder and make copies to send to your friends or relatives. The discs can be played on other compatible DVD players. DVD-RW discs, which are rewritable, can be used as well.

We cannot guarantee that DVD-R/RW discs recorded on this recorder will be playable on all DVD recorders/players. Similarly, there is no guarantee that all DVD-R/RW discs recorded on other recorders will be playable on this recorder.

Introduction

Choosing a disc (cont'd)

For playback only

Disc	Mark	Specification	Remarks
DVD video disc	 	<ul style="list-style-type: none"> • 12cm (4³/₄ in.) / 8cm (3¹/₄ in.) • Region number <div style="display: flex; align-items: center; justify-content: center;">  or  </div> • Color system: NTSC 	The region number of this DVD recorder is 1. If region numbers, corresponding to a specific playable area, are printed on your DVD video disc and you do not find Region 1 or ALL regions, or the disc is encoded to permit playback only in regions other than Region 1, disc playback will not be allowed by the recorder.
Audio CD (CD-DA)		<ul style="list-style-type: none"> • 12cm (4³/₄ in.) / 8cm (3¹/₄ in.) 	
CD-R		<ul style="list-style-type: none"> • 12cm (4³/₄ in.) • CD-DA FORMAT, MP3, WMA*, JPEG files 	Depending on the disc status, playback may not be possible.
CD-RW			

DVD is a trademark of DVD Format/Logo Licensing Corporation.

*This DVD/CD player cannot playback the disc contents protected by Windows Media Digital Rights Management (DRM).



Microsoft, Windows Media, and the Windows logo are either registered trademarks or trademarks of Microsoft Corporation in the United States and/or other countries.

- You cannot play discs other than those listed above.
- You cannot play non-standardized discs even if they may be labeled as above.
- You cannot play discs with specialized encoding (such as SACD discs) or the DVD audio portions of DVD Audio discs.
- This recorder uses the NTSC color system, and cannot play DVD video discs recorded in any other color system (PAL, SECAM, etc.), even if they have region marks Region 1 or ALL regions.
- Toshiba cannot guarantee that all discs bearing the DVD or CD logos will operate as expected. Please see the discussion of compatibility on page 11.

- Toshiba is not liable for any damage or loss caused directly or indirectly by the malfunction of this recorder, including, without limitation, any one of the following:
 - Failure to record contents intended to be recorded by the consumer.
 - Failure to edit contents as intended by the consumer.
 - When a DVD-R/RW disc created on this recorder is used (e.g., insertion, playback, recording or editing) in another DVD player, recorder or personal computer drive.
 - When a DVD-R/RW disc that is used in the manner described in the immediately preceding bullet point is used again in this recorder.
 - When a DVD-R/RW disc that was recorded in another DVD recorder, or in a personal computer drive is used in this recorder.
- Some functions may not work with personal computer discs.
- Discs recorded in this recorder may not operate as expected on other DVD players, recorders or personal computer drives.

Because of problems and errors that can occur during the creation of DVD and CD software and/or the manufacture of DVD and CD discs, Toshiba cannot guarantee that product will play every feature of every DVD bearing the DVD logo and/or every CD bearing the CD logo. As one of the creators of DVD technology, Toshiba DVD players are manufactured using the highest standards of quality, and as a result, such incompatibilities are rare. If you happen to experience any difficulty playing a DVD or a CD on product, please feel free to contact us via the method listed in the "How to Obtain Warranty Services" section on page 155.

DVD players with **RW** COMPATIBLE are capable of playing DVD-RW recorded in VR mode.

On DVD-R discs

■ Standards

- DVD-R for General Ver.2.0 discs can be used for recording and playback.
- Discs compatible with the following recording speed can also be used:
Ver. 2.0/2x
Ver. 2.0/4x
Ver. 2.0/8x
- Select discs labeled "for video", "for recording", "120 min." etc.

■ Recording conditions

- Images for which copying is prohibited or restricted (copy once or copy prohibited) cannot be recorded.
- We strongly recommend using any DVD-R 2x, and MAXELL DVD-R 16x to assure good recording quality.

■ Discs that have been tested and are proven to be compatible with this recorder:

VERBATIM DVD-R 8x
MAXELL DVD-R 16x

On DVD-RW discs

■ Standards

- Discs labeled DVD-RW Ver.1.1 or 1.2 can be used.
- Discs compatible with the following recording speed can also be used
Ver. 1.1/2x
Ver. 1.2/4x
- Select discs labeled "for video", "for recording", "120 min." etc.

■ Recording conditions

- Images for which copying is prohibited (copy prohibited) cannot be recorded. If the disc is labeled as CPRM compatible, images for which copying is restricted (copy once) can be recorded in VR mode.
- We strongly recommend using any DVD-RW 4x disc to assure good recording quality.

■ Discs that have been tested and are proven to be compatible with this recorder:

VERBATIM DVD-RW 2x
JVC DVD-RW 4x

Marks on DVD video discs

The following are examples of marks and the meanings.

Mark	Meanings
	Number of audio streams recorded in the disc. (2 streams such as English and Japanese in this example.)
	Number of subtitle languages recorded in the disc. (2 subtitle languages are recorded in this example.)
	Number of camera angles recorded in the disc. (3 camera angles are recorded in this example.)
	Pictures are recorded in the standard picture shape (4:3 aspect ratio).
	Pictures are recorded in the letter box picture shape (4:3 aspect ratio with horizontal black bars in the top and bottom of pictures).
	Pictures are recorded in the 16:9 wide picture shape. TVs with 4:3 aspect ratio will display them in the letter box style.
	Pictures are recorded in the 16:9 wide picture shape. TVs with 4:3 aspect ratio will display them in the pan scan style (one or both sides of pictures are cut).
	Actual picture shape may vary depending on the aspect ratio or mode selection of the TV.

Structure of disc contents

Normally, DVD video discs are divided into titles, and the titles are subdivided into chapters. Audio CDs are divided into tracks.

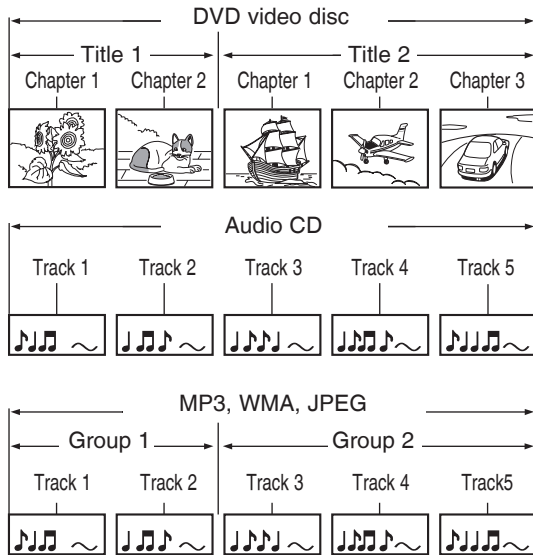

- Title: Divided contents of a DVD video disc. Roughly corresponds to a story title in short stories.
- Chapter: Divided contents of a title. This corresponds to a chapter in a story.
- Track: Divided contents of an Audio CD.
- Group: Divided contents of a MP3, WMA or JPEG data disc. Consists of number of tracks.

Each title, chapter, or track is assigned a number, which is called "title number", "chapter number", or "track number" respectively. Some discs may not have these numbers.

On handling discs

- Do not touch the playback side of the disc.

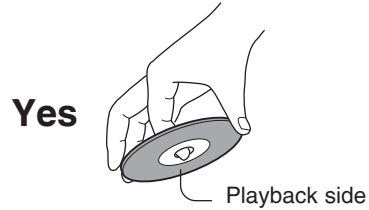

- Do not stick paper or tape to discs.



On cleaning discs

- Fingerprints and dust on the disc cause picture and sound deterioration. Wipe the disc from the center outwards with a soft cloth. Always keep the disc clean.



- Do not use any type of solvent such as thinner, benzene, commercially available cleaners or antistatic spray for vinyl LPs. It may damage the disc.

On storing discs

- Do not store discs in a place subject to direct sunlight or near heat sources.
- Do not store discs in places subject to moisture and dust such as a bathroom or near a humidifier.
- Store discs vertically in a case. Stacking or placing objects on discs outside of their case may cause warping.

Discs and purposes

The table shows main functions which are available on this recorder per disc category. This will help you choose discs.

	DVD-RW disc Video mode	DVD-RW disc VR mode	DVD-R disc Video mode
Characteristics on this recorder	Suitable for saving data in Video mode format to play on compatible devices. You can erase recorded contents to use the disc repeatedly.	Suitable for saving data in VR mode format to play on compatible devices. You can erase recorded contents to use the disc repeatedly.	Suitable for saving data in DVD-Video format to play on compatible devices. Once you execute Video mode finalizing process on a recorded disc so that it can be played on other players. You cannot make additions, corrections and deletions of contents on the disc.
For the first use	Initialize the disc.	Initialize the disc.	No preparatory steps required.
Recording a TV program	Yes	Yes	Yes
Erasing recorded contents	Yes If the disc has been executed Video mode finalizing process, first cancel the process then delete contents.	Yes You can erase recorded contents without canceling the finalizing process.	Yes Deleting contents cannot restore the disc space. <u>After you execute Video mode finalizing process on a recorded disc, you cannot delete contents of the disc.</u>
Recording additional content on a recorded disc	Yes If the disc has been executed Video mode finalizing process, first cancel the process then delete contents.	Yes You can add contents without canceling the finalizing process.	Yes <u>After you execute Video mode finalizing process on a recorded disc, you cannot add contents to the disc.</u>
Indexing recorded contents Naming a title Creating a thumbnail	Yes Yes Yes <u>After you execute Video mode finalizing process on a recorded disc, you cannot name a title or create a thumbnail.</u>	Yes Yes Yes <u>After you execute VR mode finalizing process on a recorded disc, you can name a title or create a thumbnail.</u>	Yes Yes Yes <u>After you execute Video mode finalizing process on a recorded disc, you cannot name a title or create a thumbnail.</u>
Collecting favorite scenes (Playlist Editing) Making a new title from a Playlist containing favorite scenes (Copy within the same disc)	No No	Yes Yes	No No
Playing contents recorded on this recorder, on other devices	Execute Video mode finalizing process on this recorder. This process makes the disc playable on other compatible devices. (Some models excepted.)	Execute VR mode finalizing process on this recorder. This process makes the disc playable on other compatible devices. (Some models excepted.)	Execute Video mode finalizing process on this recorder. This process makes the disc playable on other compatible devices. (Some models excepted.)
When a message appears and the loaded disc cannot be used:	Initialize the disc.	Initialize the disc.	—

Index to parts and controls

Front Panel

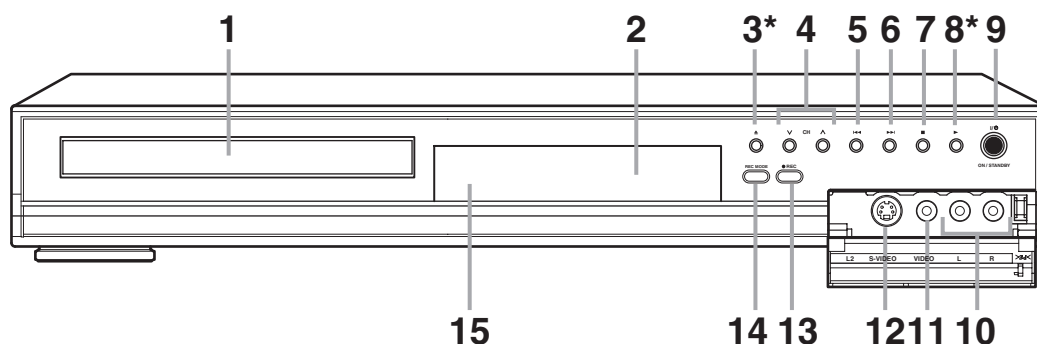

1. **Disc tray**
Place a disc when open.
2. **Display**
Refer to "Front Panel Display Guide" on page 18.
3. **▲ (OPEN/CLOSE) button***
Press to open or close the disc tray.
4. **CH ∇/▲ button**
Press to change the channel up and down.
5. **◀◀ (REV) button**
During playback, press once midway through a chapter or track to go back to the beginning of the current chapter or track. When pressed twice in quick succession, playback will start from the preceding chapter or track.
During playback, press and hold for 1.5 seconds to fast reverse.
When playback is paused, press to play reverse step by step.
When playback is paused, press and hold for 1.5 seconds to slow reverse.
6. **▶▶ (FWD) button**
During playback, press to skip to the next chapter or track.
During playback, press and hold for 1.5 seconds to fast forward.
When playback is paused, press to play advance step by step.
When playback is paused, press and hold for 1.5 seconds to slow forward.
7. **■ (STOP) button**
Press to stop play or recording.
8. **▶ (PLAY) button***
Press to start or resume play.
9. **I/O (ON/STANDBY) button**
Press to turn the unit on and off.
If timer programmings have been set, press to set the unit in timer-standby mode.
10. **AUDIO input jacks (LINE2)**
Use to connect external equipment with a standard audio cable.
11. **VIDEO input jack (LINE2)**
Use to connect external equipment with a standard video cable.
12. **S-VIDEO input jack (LINE2)**
Use to connect the S-Video output of external equipment with an S-Video cable.
13. **● REC button**
Press once to start a recording. Press repeatedly to start a One-touch Timer Recording.
14. **REC MODE button**
Press to switch the recording mode.
15. **Remote control sensor**
Receive signals from your remote control so that you can control the unit from a distance.

* The unit can also be turned on by pressing these buttons.

Rear Panel

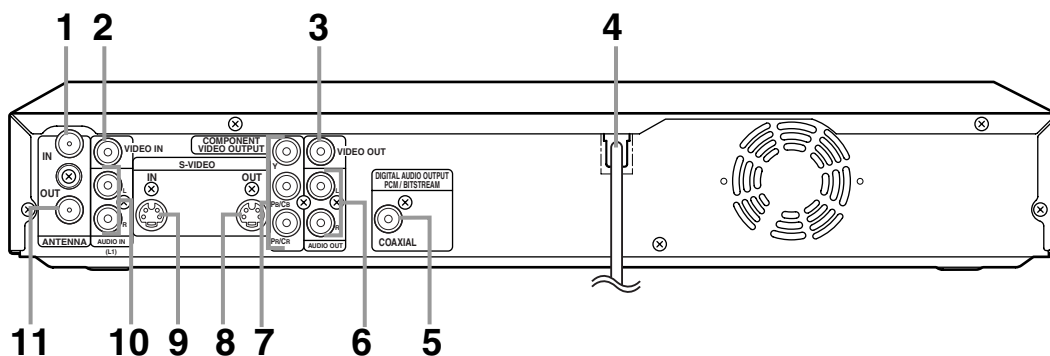

1. **ANTENNA IN jack**
Use to connect an antenna.
2. **VIDEO IN jack (LINE1)**
Use to connect external equipment with a standard video cable.
3. **VIDEO OUT jack**
Use to connect a TV monitor, AV receiver or other equipment with a standard video cable.
4. **AC Power Cord**
Connect to a standard AC outlet to supply power to this unit.
5. **COAXIAL DIGITAL AUDIO OUTPUT jack**
Use to connect an AV receiver, Dolby Digital decoder, DTS decoder or other equipment with a coaxial digital input jack with a digital coaxial cable.
6. **AUDIO OUT jacks**
Use to connect a TV monitor, AV receiver or other equipment with a standard audio cable.
7. **COMPONENT VIDEO OUTPUT jacks**
Use to connect a TV monitor with component video inputs with a component video cable.
8. **S-VIDEO OUT jack**
Use to connect the S-Video input of a TV monitor, AV receiver or other equipment with an S-Video cable.
9. **S-VIDEO IN jack (LINE1)**
Use to connect the S-Video output of external equipment with an S-Video cable.
10. **AUDIO IN jacks (LINE1)**
Use to connect external equipment with a standard audio cable.
11. **ANTENNA OUT jack**
Use to connect an antenna cable to pass the signal from the TV ANTENNA IN to your TV monitor.

Notes

- Do not touch the inner pins of the jacks on the rear panel. Electrostatic discharge may cause permanent damage to the unit.
- This unit does not have the RF modulator.

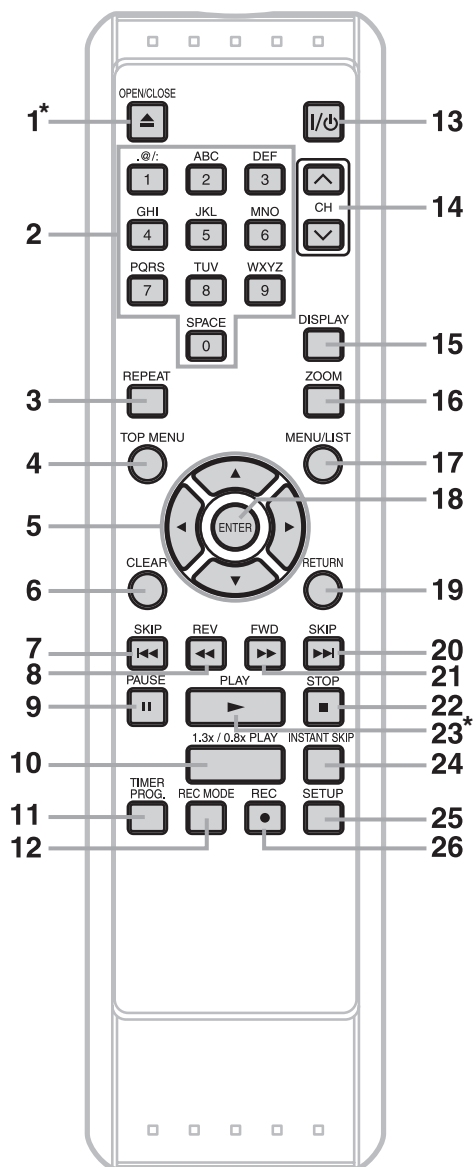

1. **OPEN/CLOSE \blacktriangle button***
Press to open or close the disc tray.
2. **Number buttons**
Press to select channel numbers. Press to select a title/chapter/track on display. Or press to enter values for the settings in the Setup menu.
3. **REPEAT button**
Press to display the Repeat menu.
4. **TOP MENU button**
Press to display the Title menu/list.
5. **Direction buttons (\blacktriangle / \blacktriangledown / \blacktriangleleft / \blacktriangleright)**
Press to select items or settings.
6. **CLEAR button**
Press to clear the password once entered or to cancel the programming for CD or to clear the selecting marker number in the marker setup mode or to clear the program once entered in the Timer Recording setting mode, etc.
7. **SKIP $\blacktriangleleft\blacktriangleleft$ button**
During playback, press once midway through a chapter or track to go back to the beginning of the current chapter or track. When pressed twice in quick succession, playback will start from the preceding chapter or track. Or when playback is paused, press to play reverse step by step.
8. **REV $\blacktriangleleft\blacktriangleleft$ button**
During playback, press to fast reverse. Or when playback is paused, press to play slow reverse.
9. **PAUSE \parallel button**
Press to pause play or recording.
10. **1.3x / 0.8x PLAY button**
During playback, press to playback in a slightly faster/slower speed with keeping the audio quality.
11. **TIMER PROG. button**
Press to display the Timer Programming list.
12. **REC MODE button**
Press to switch the recording mode.
13. **I/O ON/STANDBY button**
Press to turn the unit on and off. If timer programmings have been set, press to set the unit in timer-standby mode.
14. **CH \blacktriangledown / \blacktriangle buttons**
Press to change the channel up and down.
15. **DISPLAY button**
Press to display the On Screen menu on or off.
16. **ZOOM button**
During playback, press to enlarge the picture on the screen.
17. **MENU/LIST button**
Press to display the Disc menu. To change Original and Playlist on the TV screen.
(VR mode only)
18. **ENTER button**
Press to confirm or select menu items.
19. **RETURN button**
Press to return to the previously displayed menu screen.
20. **SKIP $\blacktriangleright\blacktriangleright$ button**
During playback, press to skip to the next chapter or track.
Or when playback is paused, press to play forward step by step.
21. **FWD $\blacktriangleright\blacktriangleright$ button**
During playback, press to play fast forward. Or when playback is paused, press to play slow forward.
22. **STOP \blacksquare button**
Press to stop play or recording.
23. **PLAY \blacktriangleright button***
Press to start or resume play.
24. **INSTANT SKIP button**
During playback, press to skip 30 seconds.
25. **SETUP button**
Press to display the Setup menu. During DVD playback, press and hold for more than 3 seconds to switch the progressive scanning mode to the interlace mode.
26. **REC \bullet button**
Press once to start a recording. Press repeatedly to start a One-touch Timer Recording.

* The unit can also be turned on by pressing these buttons.

Front Panel Display Guide

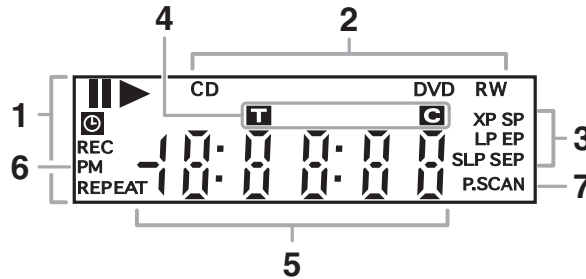

1. Current Status of the unit

- :Appears when disc playback is paused.
- :Appears when playing a disc.
- :Appears when the timer programming has been set or in progress. Flashes when all Timer Recordings have been finished, or when a program cannot be performed for some reason.

REC :Appears during recording process.

REPEAT

:Appears during repeat play.

2. Disc type

CD :Appears when an Audio CD or a disc with MP3, WMA or JPEG files is inserted in the disc tray.

DVD :Appears when a DVD disc is inserted in the disc tray.

DVD R

:Appears when a DVD-R disc is inserted in the disc tray.

DVD RW

:Appears when a DVD-RW disc is inserted in the disc tray.

3. Recording mode

:Indicates the recording mode of the disc.

4. Title / Track and Chapter mark

:Appears when indicating a title/track number.

:Appears when indicating a chapter number.

5. Displays the following

- Playing time
- Current title / chapter / track number
- Recording time/ remaining time
- Clock
- Channel number
- OTR (One-touch Timer Recording) remaining time

6. PM

:Appears in the afternoon with the clock displaying.

7. P.SCAN

:Appears when the progressive scan system is activated.

■ Display message



Appears when the unit is turned on.



Appears when the unit is turned off.



Appears when the disc tray is opening.



Appears when the disc tray is closing.



Appears when a disc is loaded on the disc tray.



Appears when date is being recorded on a disc.

Preparation of the remote control

Installing batteries in the remote control

- Install two “AA” size batteries (supplied) matching the polarity indicated inside battery compartment of the remote control.

1 Open the cover.

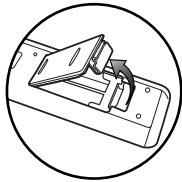

2 Insert batteries.

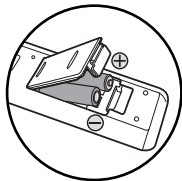

Make sure to match the + and - on the batteries to the marks inside the battery compartment.

3 Close the cover.

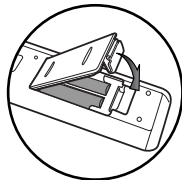

Caution:

Never throw batteries into a fire.

Notes:

- Be sure to use AA size batteries.
- Dispose of batteries in a designated disposal area.
- Batteries should always be disposed of with the environment in mind. Always dispose of batteries in accordance with applicable laws and regulations.
- If the remote control does not operate correctly, or if the operating range becomes reduced, replace batteries with new ones.
- When necessary to replace batteries in the remote control, always replace both batteries with new ones. Never mix battery types or use new and used batteries in combination.
- Always remove batteries from remote control if they are dead or if the remote control is not to be used for an extended period of time. This will prevent battery acid from leaking into the battery compartment.

Using a remote control

- Keep in mind the following when using the remote control:

- Make sure that there is no obstacle between the remote control and the remote sensor on the unit.
- Remote operation may become unreliable if strong sunlight or fluorescent light is shining on the remote sensor of the unit.
- Remote control for different devices can interfere with each other. Avoid using remote control for other equipment located close to the unit.
- Replace the batteries when you notice a fall off in the operating range of the remote control.
- The maximum operable ranges from the unit are as follows.
 - **Line of sight:** approx. 23 feet (7m)
 - **Either side of the center:** approx. 23 feet (7m) within 30°

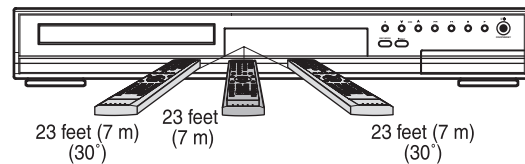

On Screen menu

This unit uses following On Screen menu for most operations: Setup menu, Title list, Playlist, Original and Display menu. They allow you to change the playing status of disc during playback.

The Display menu also gives you information on the status of the disc.

Display menu

Press [DISPLAY] to call up the Display menu. This menu will give you the information on the playing disc. Some operations are available while disc is playing.

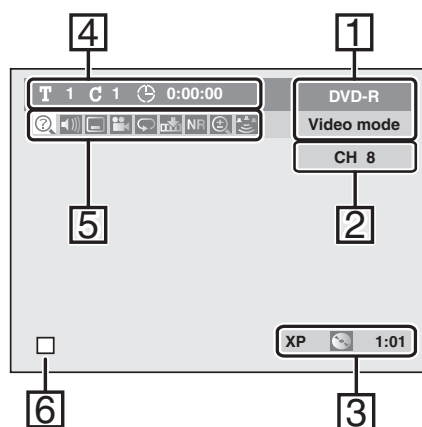

1. Indicates a disc type and a format mode.
NOTE:
In some descriptions on this manual, only one disc type is indicated as an example.
2. Indicates a channel number.
3. Indicates a recording mode and possible recording time left.
4. Indicates a title number, chapter number and the elapsed time of disc played.
5. Each icon means:

- : Search
- : Audio
- : Subtitle
- : Angle (except VR mode)
- : Repeat
- : Marker
- : Noise Reduction
- : Zoom
- : Surround

6. Indicates current disc status.

Setup menu

Press [SETUP] to display the Setup menu, then use [▲ / ▼] and press [ENTER] to display each menu.

These menus provide entries to all main functions of the unit.

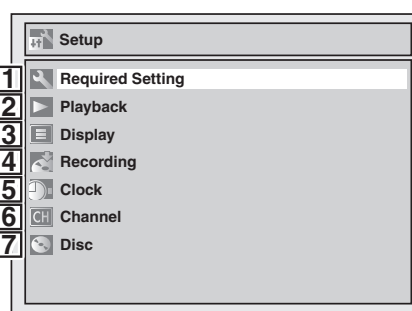

- 1. Required Setting:**
To set up the required setting.
- 2. Playback:**
To set up the unit to play discs as you prefer.
- 3. Display:**
To set up the TV screen and the front panel display of the unit as you prefer.
- 4. Recording:**
To set up the unit to record to discs as you prefer.
- 5. Clock:**
To set up the clock of the unit.
- 6. Channel:**
To adjust the channel setting of the unit as you prefer.
- 7. Disc / CD Playback Mode:**
When a DVD-Video disc (commercially available), a new DVD-R disc is inserted into the unit, you cannot select "Disc".
"CD Playback Mode" is available only when an Audio CD, a CD-R/RW disc with MP3, WMA or JPEG files is inserted into the unit.

<DVD-R,DVD-RW (Video mode)>

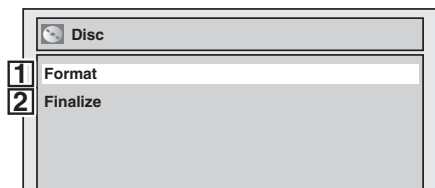

<DVD-RW (VR mode)>

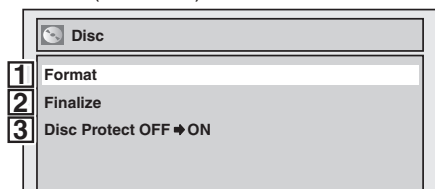

<Audio CD, MP3, WMA, JPEG>

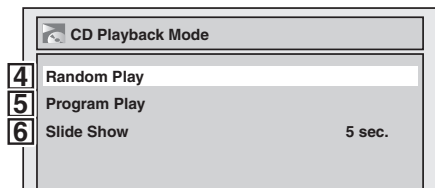

1. Format (DVD-RW only):

Allows you to erase all of the recorded content on the disc.

The disc will be completely blank.

- Erased content cannot be called back.
- A DVD-RW disc formatted with this unit cannot be used in other DVD recorders without any recording using this unit.
- If you want to use a disc only formatted with this unit on another DVD recorder, you have to re-format the disc on that recorder.

2. Finalize:

Allows you to finalize a disc containing recorded titles.

3. Disc Protect (VR mode only):

Allows you to protect a disc from accidental editing or recording.

4. Random Play:

To activate the random playback feature.

5. Program Play (Audio CD only):

To activate the programmed playback feature.

6. Slide Show (JPEG only):

Select the display time.

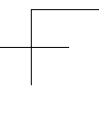
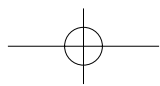
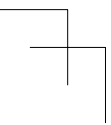
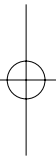
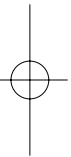
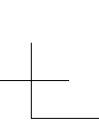
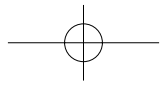
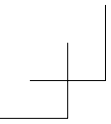

Connections

Connect your recorder to your TV or stereo system.

- **Connection to a TV**
- **RF modulator Connection**
- **Connection to a cable box or satellite box**
- **Connection to an Audio System**

Connection to a TV

Connect your TV and the antenna to this recorder for recording and to view broadcast signals on the TV.

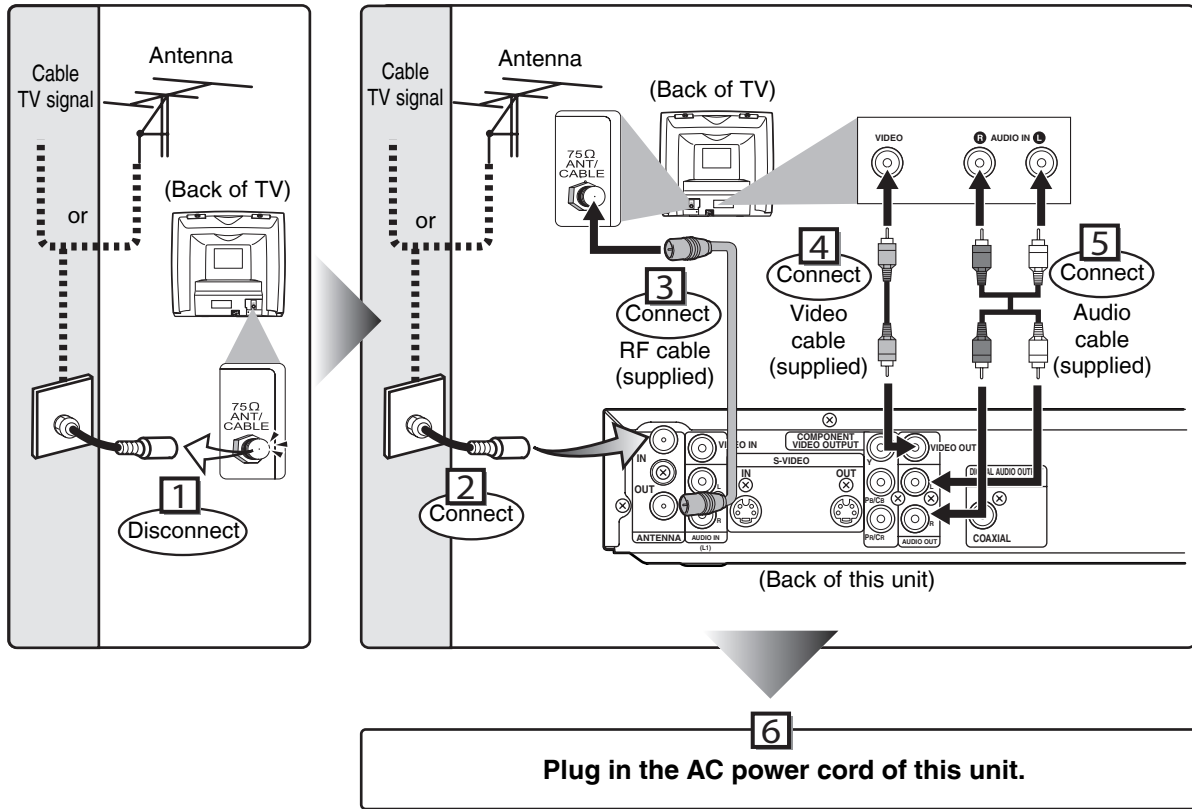

Note

- RF output is for tuner pass through only. DVD Playback through the RF is not possible. Please see the next page for connection options.

Make one of the following connections, depending on the capabilities of your existing equipment.

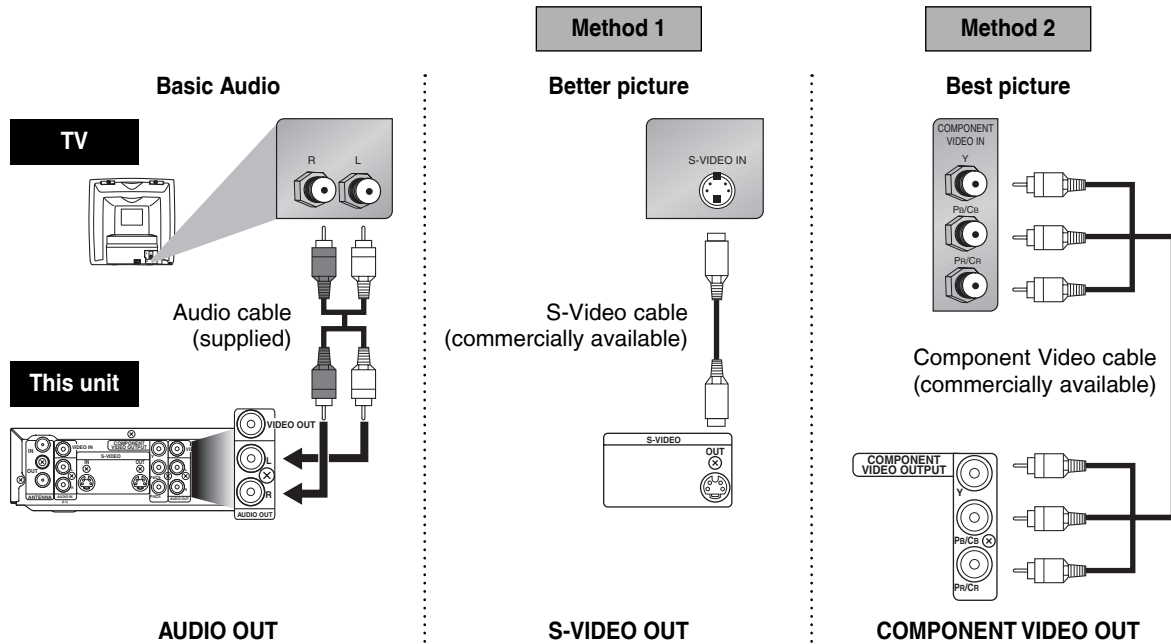

After you have completed the connections

- Switch the input selector on your TV to an appropriate external input channel (usually near channel 0). Press a button on the TV's original remote control that selects an external input channel until the DVD recorder's picture appears. Check your TV owner's manual for details.

Notes

- Connect this unit directly to the TV. If the A/V cables are connected to a VCR, pictures may be distorted due to the copy protection system.
- **When Progressive Scan mode is selected, no video signal will be output from the VIDEO OUT or S-VIDEO OUT jack.**

- This unit is compatible with the Progressive Scan System. The feature provides you with the higher definition images than the traditional output system does. To utilize this feature, you must set Progressive Scan mode to "ON".

To set progressive scan mode, refer to page 141.

RF modulator Connection

If your TV has Antenna in jack only, it is still possible to connect this unit to your TV by using a Stereo Audio/Video RF modulator. In this case, follow the instructions below.

- 1) The antenna input jack of your TV may have been already occupied. If so, disconnect the RF cable from your TV, and then connect the RF cable to the ANTENNA IN jack of this unit.
- 2) Connect the ANTENNA OUT jack of this unit to your RF modulator (usually marked "ANT IN") by the RF cable.
- 3) Connect your RF modulator to your TV by another RF cable.
- 4) Connect the AUDIO/VIDEO output jacks of this unit to the AUDIO/VIDEO input jacks of your RF modulator by Audio/Video cables.
- 5) Set your RF modulator's channel 3/4 switch to either 3 or 4, whichever the TV channel is least used in your area. If your RF modulator has a Modulator/Antenna switch, set it according to your RF modulator's manual.
- 6) Turn on your TV and choose the same channel as you set the RF modulator's channel 3/4 switch to.

For more details, follow the instructions supplied with the RF modulator.

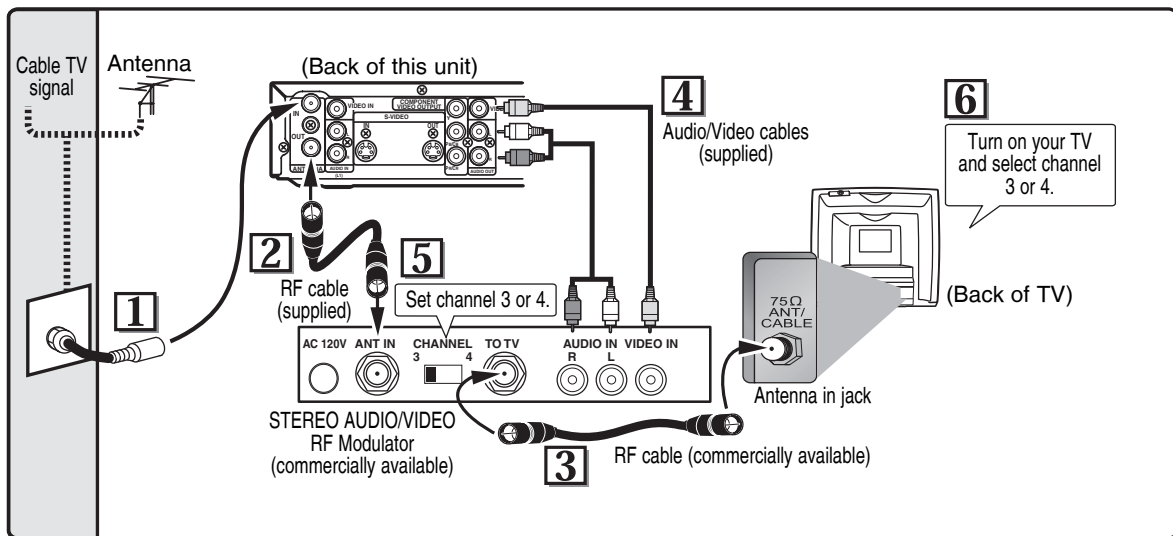

Note

- The quality of picture may become poor if this unit is connected to an RF modulator.

Connection to a cable box or satellite box

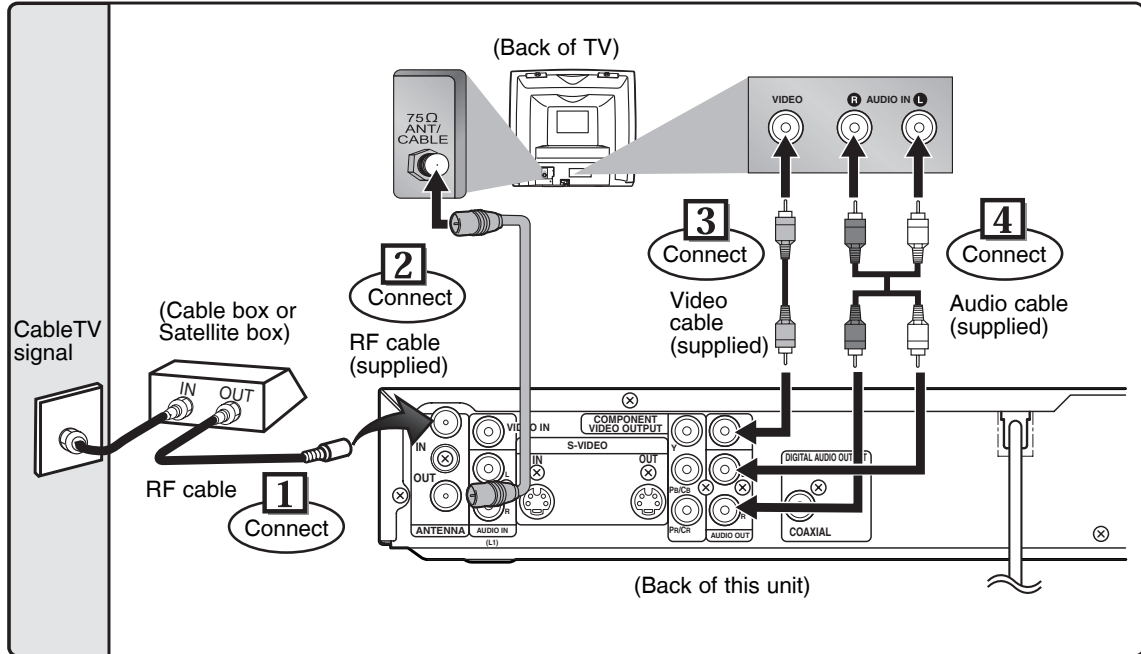

■ With this setup:

- You can record any unscrambled channel by selecting the channel on the cable box or satellite box. Be sure that the cable box or satellite box is turned on.
- You cannot record one channel while watching another channel.

Note to the Cable TV System Installer :

This reminder is provided to call the Cable TV system installer's attention to Article 820-40 of the National Electrical Code, which provides guidelines for proper grounding - in particular, specifying that the cable ground shall be connected to the grounding system of the building, as close to the point of cable entry as possible.

Connection to an Audio System

- When you change the connections, all devices should be turned off.
- Refer to the operation manual accompanying external devices for more information.

Method 1

Stereo system

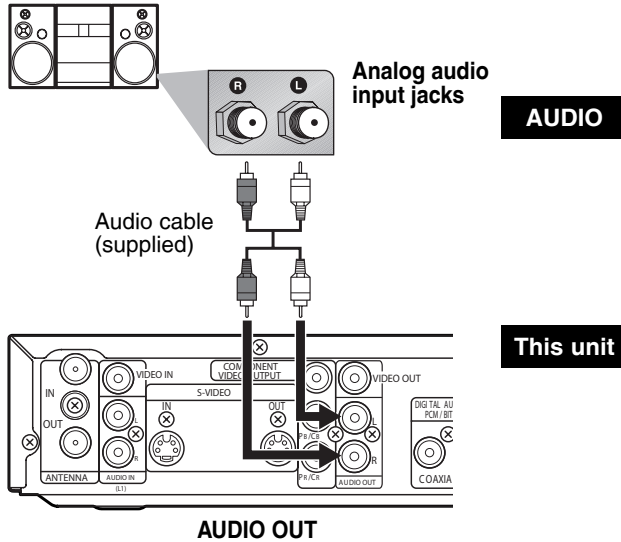

Method 2

Dolby Digital decoder, DTS decoder, MD deck or DAT deck

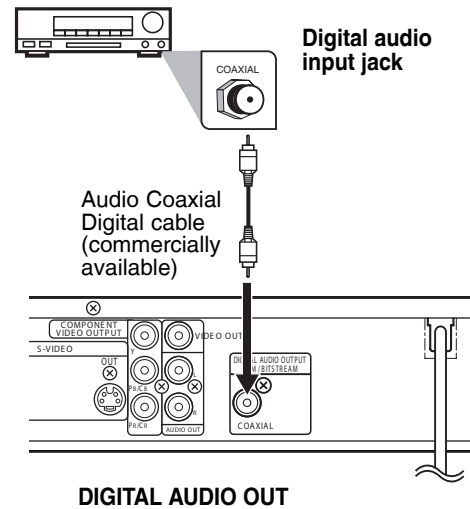

Note

- Playing a DVD using incorrect settings may generate noise distortion and may also damage the speakers.

Connection	Setting		
	Setup >Playback >Audio >Digital Out > PCM	Dolby Digital	DTS
If output is Dolby Digital encoded audio, connect to a Dolby Digital decoder.	—	STREAM	OFF
If output is DTS encoded audio, connect to a DTS decoder.	—	PCM	ON
If output is encoded audio for both Dolby Digital and DTS, connect to the decoder which encodes multiple audio sources.	—	STREAM	ON
Connecting to an MD deck or DAT deck.	—	PCM	OFF
If not connected to any external devices.	—	PCM	OFF

* To complete these settings, refer to pages 135-137.

Notes

- The audio source on a disc in a Dolby Digital Multi-channel surround format cannot be recorded as digital sound by an MD or DAT deck.
- By connecting this unit to a Multi-channel Dolby Digital decoder, you can enjoy high-quality Dolby Digital Multi-channel surround sound as heard in the movie theaters.
- Playing a DVD using incorrect settings may generate noise distortion and may also damage the speakers.
- By connecting this unit to the DTS decoder, you can enjoy Multi-channel Surround System which reproduces the original sound as truthfully as possible. Multi-channel Surround System is developed by the Digital Theater System Inc.

Basic Setup

Read this chapter for necessary settings to get started.

- **Initial setting**
- **Channel setting**
- **Selecting TV stereo or SAP**
- **Setting the clock**
- **Selecting TV aspect ratio**

Initial setting



Turn on this unit for the first time, you need to follow these steps.

1 Press [I/O ON/STANDBY].



2 Turn the TV on. Select the input to which the unit is connected.
"Initial Setting" will automatically appear.

3 Using [▲ / ▼], select your desired language for the on screen menu. Then press [ENTER] to go to next step.

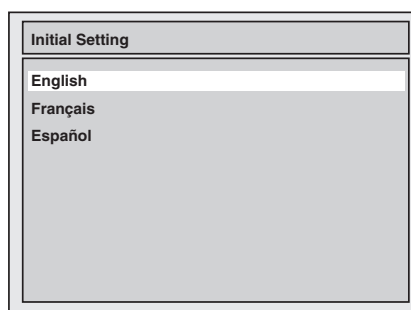
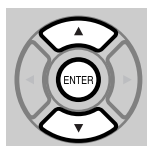



4 Press [ENTER] to start Channel Preset.

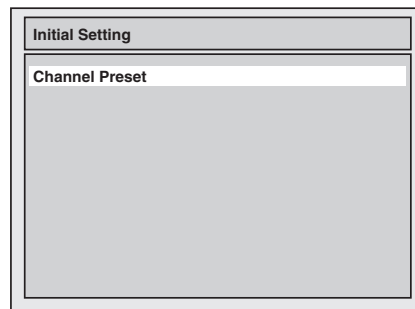
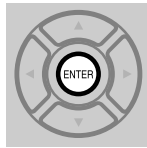

The unit will start getting channels available in your area.

5 After channel setting is finished, "Clock Setting" will appear. Then press [ENTER].

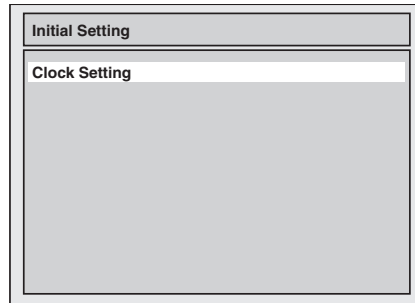
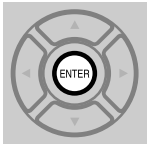

6 Follow the steps 3 to 7 on pages 41-43 for "Manual Clock Setting".

Channel setting

Setting channels automatically



If you have changed antenna connection, we recommend you to program channels which are available in your area with the following procedures.

1 Press [SETUP].

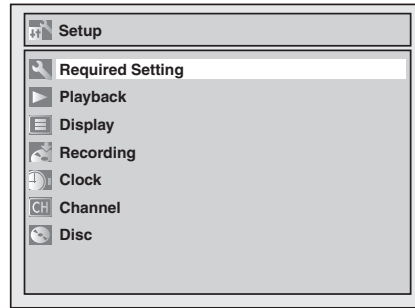
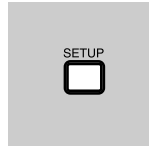

2 Using [▲ / ▼], select “Channel”. Press [ENTER].

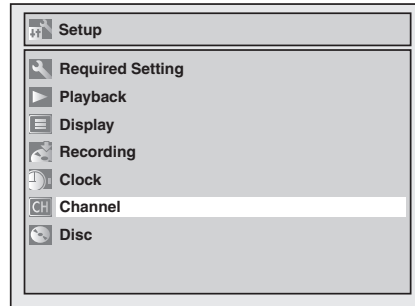
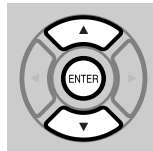

Channel menu will appear.

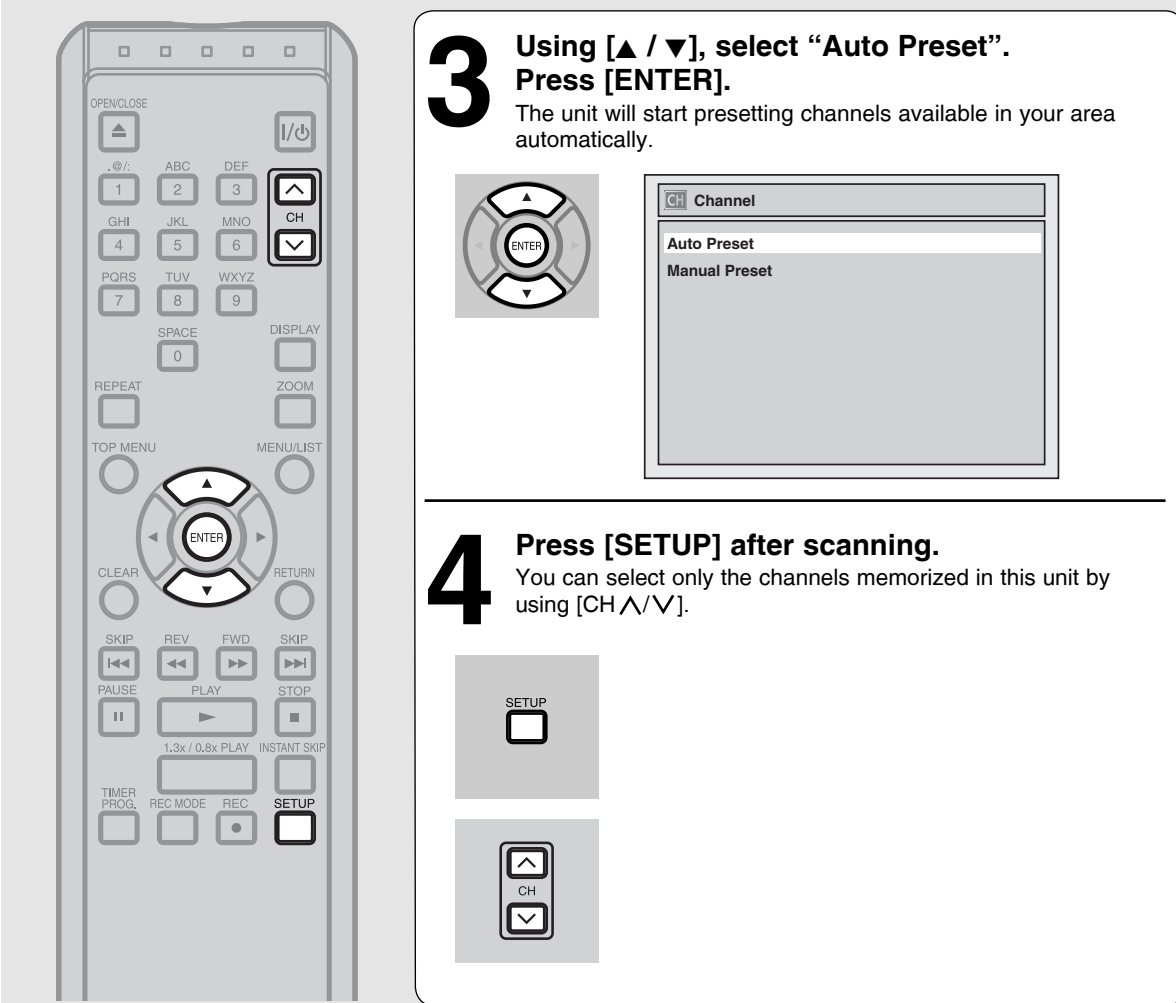

3 Using [▲ / ▼], select “Auto Preset”. Press [ENTER].
The unit will start presetting channels available in your area automatically.

4 Press [SETUP] after scanning.
You can select only the channels memorized in this unit by using [CH▲/▼].

■ To select a channel

You can select a channel by directly entering channel with **the Number buttons** on the remote control.

Notes for using the Number buttons:

- When selecting cable channels which are higher than 99, enter channel numbers as a three-digit number. (For example: 117, press [1], [1], [7])
- You must precede single-digit channel numbers with a zero (For example: 02, 03, 04 and so on).
- You can select the line input mode (“L1” or “L2”). To select “L1” by pressing [0], [0], [1]. To select “L2” by pressing [0], [0], [2]. Details are on pages 68-69.

Notes

- If the auto presetting is cancelled during presetting, some channels not yet preset may not be received.
- The selection will depend on the number of stations that it has found.

Press [RETURN] or [SETUP] to cancel the auto presetting during scanning.

Adding/deleting channels



The channels you no longer receive or seldom watch can be deleted from the memory. You also may add channels into the memory.

1 Press [SETUP].

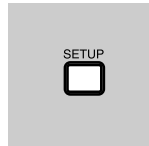

2 Using [▲ / ▼], select “Channel”. Press [ENTER].
Channel menu will appear.

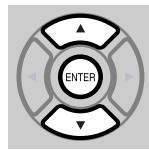

3 Using [▲ / ▼], select “Manual Preset”. Press [ENTER].

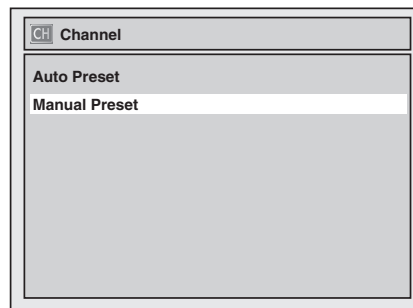
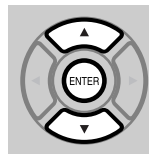

Manual Preset menu will appear.



4 Select the channel number to add or delete.

Press [◀] or [CH▼] to move to a lower channel number.
Press [▶] or [CH▲] to move to a higher channel number.
Press the **Number buttons** to select a channel number directly.

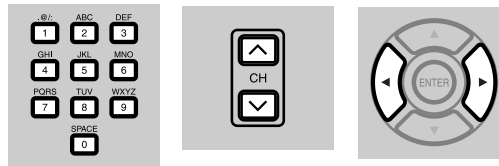

[CH▲/▼] works on the memorized channel in this unit.
[◀/▶] works on all channel numbers.

5 Using [▲ / ▼], select “Add” or “Delete”.

Press [ENTER].

The channel number will be added or deleted from the channel memory. Then the next channel number will appear so that you can continue adding or deleting channels.

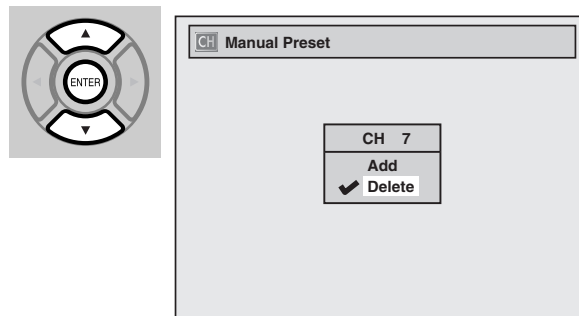

6 Press [SETUP] to exit.

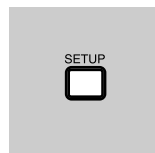

Selecting TV stereo or SAP



You can select a sound channel to output from TV. "Stereo" has been selected as the default.

1 Press [SETUP].

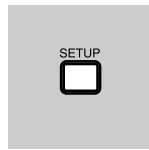

2 Using [▲ / ▼], select "Required Setting". Press [ENTER].

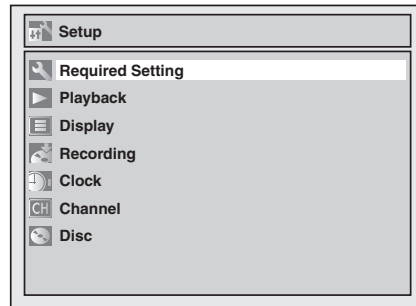
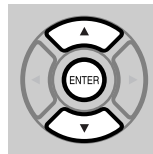

Required Setting menu will appear.

3 Using [▲ / ▼], select "TV Audio Select". Press [ENTER].

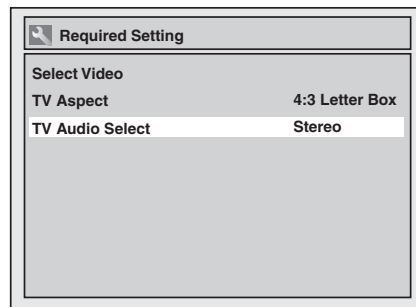
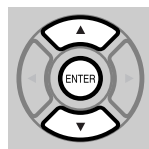

Option window will appear.

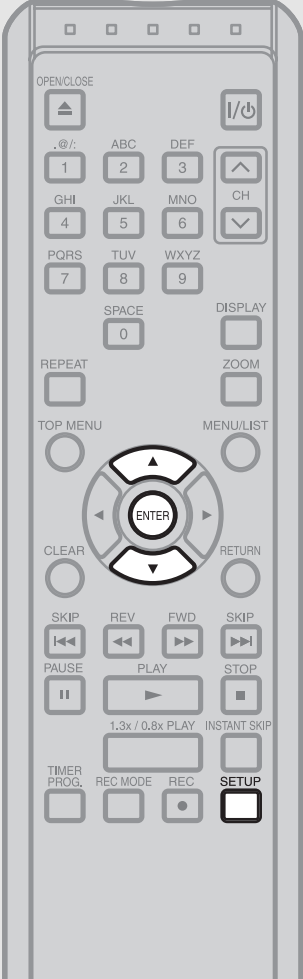

4 Using [**▲** / **▼**], select “Stereo” or “SAP”. Press [**ENTER**].

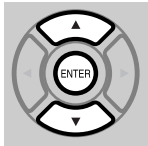
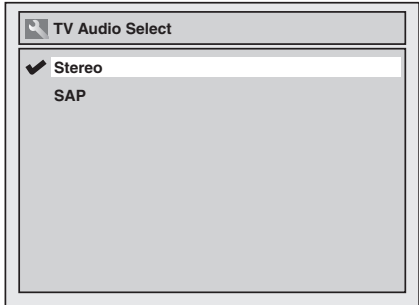
Stereo:
Outputs main audio.

SAP (Secondary Audio Program):
Outputs sub audio.

5 Press [**SETUP**] to exit.

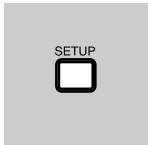

Notes on TV channel audio

- This unit CANNOT record in both Stereo (main) and SAP (sub) at the same time.
- If you want to record a TV program available in second audio or stereo on a DVD-RW/R, you have to select either Stereo or SAP in the “TV Audio Select” beforehand. Refer to the following table to check an appropriate setting.
- You can only play the disc in second audio if a TV program is available in second audio and you set “TV Audio Select” to “SAP”.

Selected audio	Broadcast audio		Disc Recording
	Main-audio channel	Sub-audio channel	
Stereo	STEREO	SAP	STEREO
	STEREO	NONE	STEREO
	MONO	SAP	MONO
	MONO	NONE	MONO
SAP	STEREO	SAP	SAP
	STEREO	NONE	STEREO
	MONO	SAP	SAP
	MONO	NONE	MONO

Setting the clock

Auto Clock Setting



Set the clock before you try the Timer Recording. If a Public Broadcasting Station (PBS) is available in your area, follow “Auto Clock Setting” below. If not, follow “Manual Clock Setting” on page 41.

Make sure

- The antenna/Cable TV connections are correct.
- If this unit is connected to a Cable Box or Satellite Box, select the local PBS station on them to set the clock automatically.

1 Press [SETUP].

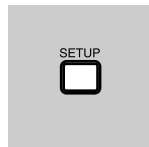

2 Using [▲ / ▼], select “Clock”. Press [ENTER].

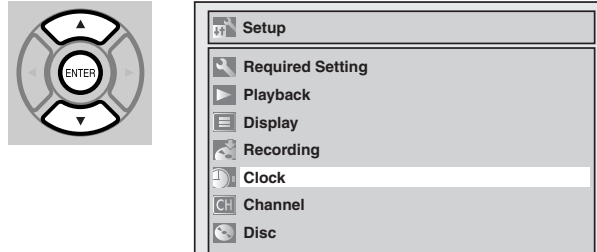

Clock menu will appear.

3 Using [▲ / ▼], select “Auto Clock Setting”. Press [ENTER].

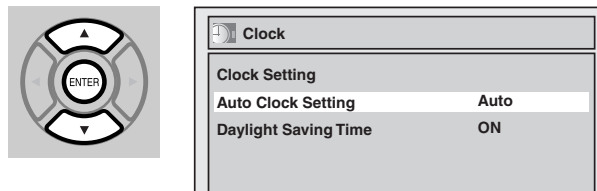

Option window will appear.



4 If you do not know your PBS channel number: Using [▲ / ▼], select “Auto”. Press [ENTER].

The setting will be activated.

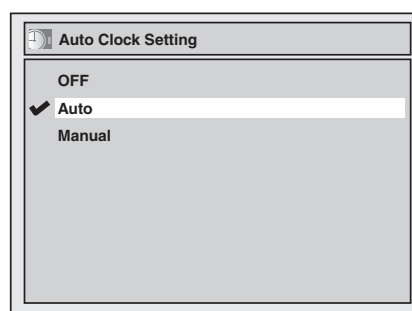
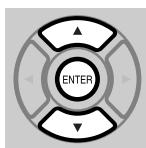

If you know your PBS channel number: Using [▲ / ▼], select “Manual”. Press [ENTER].

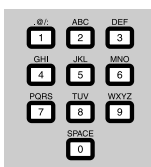
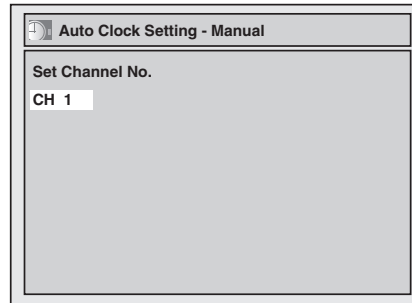
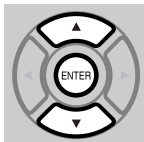

Using the Number buttons or [▲ / ▼], enter your PBS channel number. Press [ENTER].

The setting will be activated.

If you want to set the clock manually and cancel the Auto Clock Setting function: Using [▲ / ▼], select “OFF” at the step 4. Press [ENTER].

The Auto Clock Setting function will be canceled.

(Continued)

Basic Setup

Setting the clock (cont'd)

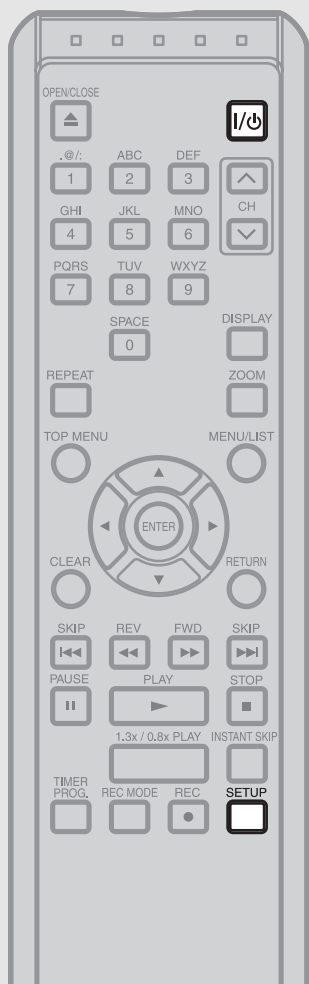

5 Press [SETUP] to exit.



6 Press [I/O ON/STANDBY] to turn off the unit.



This unit will search for the time only when the power is off. Leave it off for several minutes to give this unit time to set the clock on the front panel display.

Notes

- The clock may set itself automatically after you connect the antenna/cable signal to this unit and plug in the power cord. In this case, the current time will appear on the front panel display.
- If the current time is not displayed or the displayed clock is not correct, set the clock manually.

Manual Clock Setting



1 Press [SETUP].



2 Using [▲ / ▼], select “Clock”. Press [ENTER].

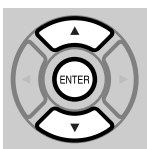

3 Using [▲ / ▼], select “Clock Setting”. Press [ENTER].

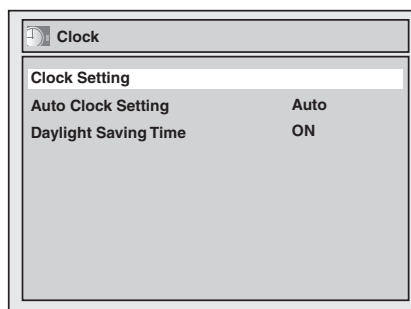
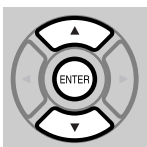

Clock Setting menu will appear.

Press [ENTER] again.

Default date will appear.

(Continued)

Introduction

Connections

Basic Setup

Recording

Playback

Editing

Function Setup

Others

Basic Setup

Setting the clock (cont'd)



4 Using [▲ / ▼], enter the date (month / day / year).
Press [◀ / ▶] to move the cursor.

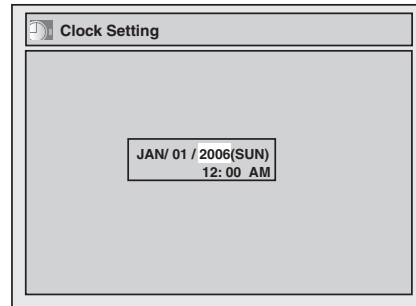
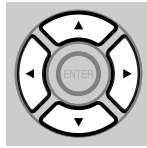

5 Using [▲ / ▼], enter the time (hour / minute).
Press [◀ / ▶].

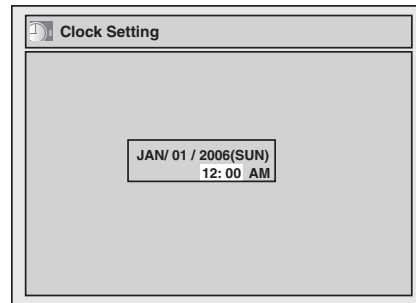
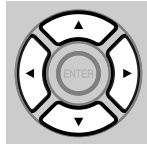

The cursor will move on to AM.

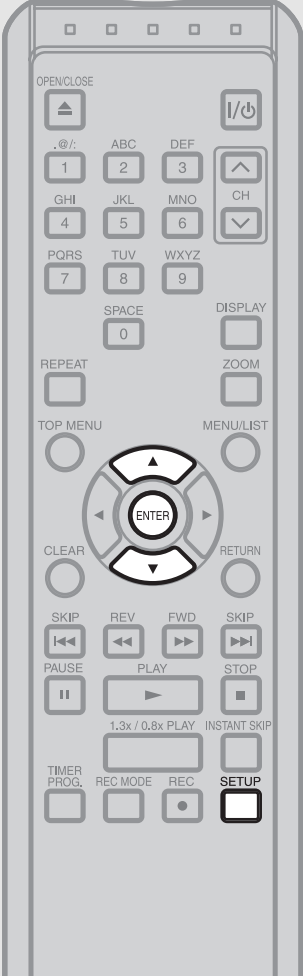

6 Press [**▲** / **▼**] to select “AM” or “PM”.
Press [**ENTER**].
The settings will be activated.
Although seconds are not displayed, they begin counting from zero.

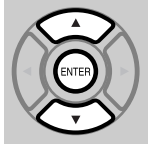
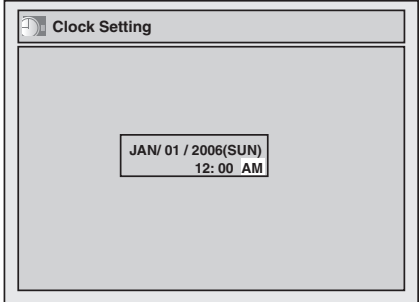
7 Press [**SETUP**] to exit, if Clock menu appears.

Note

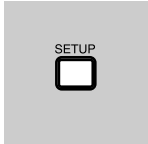
- Your clock setting will be lost if there is a power failure or this unit has been unplugged for more than 30 seconds, set the clock manually.

Setting the Daylight Saving Time



When “Daylight Saving Time” is “ON”, the unit clock will automatically move forward one hour at 2:00a.m. on the first Sunday in April and move back one hour at 2:00a.m. on the last Sunday in October. “ON” has been selected as the default.

1 Press [SETUP].

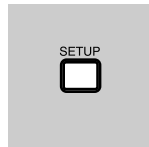

2 Using [▲ / ▼], select “Clock”. Press [ENTER].
Clock menu will appear.

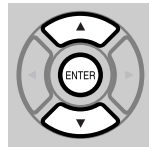

3 Using [▲ / ▼], select “Daylight Saving Time”. Press [ENTER].

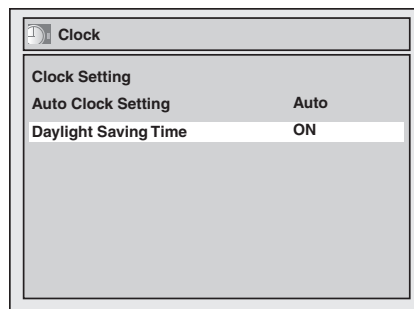
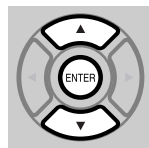

Option window will appear.



- 4** Using [▲ / ▼], select “ON” or “OFF”.
Press [ENTER].
Choose “ON” when currently observing the daylight saving time.

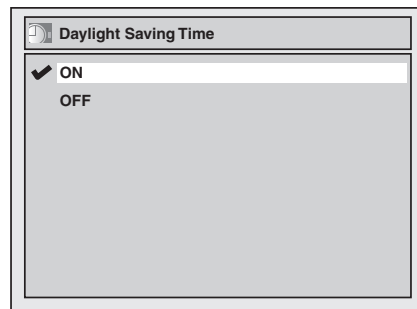
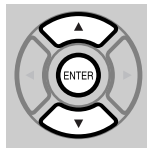

- 5** Press [SETUP] to exit.



Selecting the TV aspect ratio



You can select the TV aspect ratio to match the formats of what you are playing with the unit and your TV screen (4:3 standard or 16:9 widescreen TV).
“4:3 Letter Box” has been selected as the default.

1 Press [SETUP].

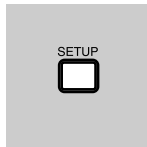

2 Using [▲ / ▼], select “Required Setting”. Press [ENTER].

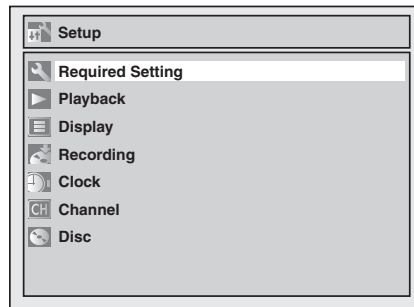
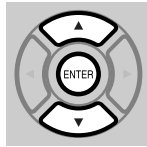

Required Setting menu will appear.

3 Using [▲ / ▼], select “TV Aspect”. Press [ENTER].

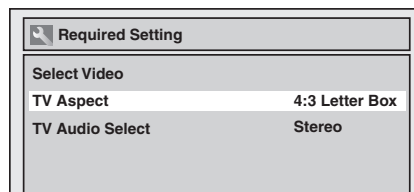
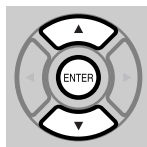

Option window will appear.

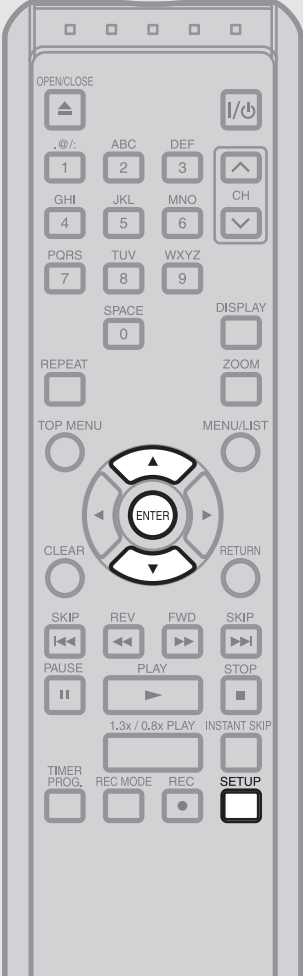

4 Using [**▲** / **▼**], select a desired format. Press [**ENTER**].

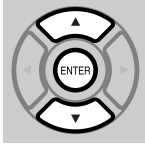
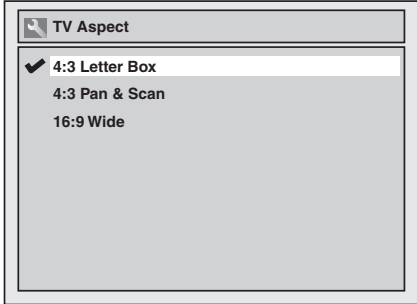
5 Press [**SETUP**] to exit.

Note**If you have a standard TV:**

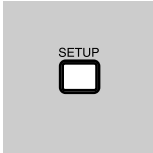
Select “4:3 Letter Box”, so that black bars appear on the top and bottom of the screen. Select “4:3 Pan & Scan” for a full height picture with both sides trimmed.

If you have a widescreen TV:

Select “16:9 Wide”.

