

# Getting Started With The Explorer<sup>®</sup> 8000<sup>™</sup> and 8000HD<sup>™</sup> DVR



**Record** your favorite programs when you're busy

**Record** one program and watch another

**Record** two live programs while watching a third program you recorded earlier

**Record and store** up to 90 hours of standard-definition programming or 20 hours of high-definition programming (with a 160 GB hard drive)

**Watch and record** high-definition programs on the 8000HD DVR (the actual high-definition storage capacity depends on the model)

**Pause** live TV for up to 1 hour without missing a minute

**Use instant replay** any time you want

**Watch** two programs at the same time with the Picture-in-Picture feature on any TV you have

# Welcome!

With the Explorer® 8000™ Digital Video Recorder (DVR), you can easily record your favorite programs and then play them back anytime. The built-in DVR and Picture-In-Picture (PIP) features give you complete control, convenience, and choice when watching TV. Use your DVR to control the following features...



## Control live TV

The telephone is ringing and you do not want to miss any scenes of your favorite live TV program. DVR lets you **PAUSE** the live program, or **REWIND** and **PLAY** a portion of it again, or **FAST-FORWARD** it to catch up to live TV.

Sports fans can enjoy complete control by using **INSTANT REPLAY**, **SLOW MOTION**, and **FRAME ADVANCE AND REWIND** to watch their favorite play again.

## Record TV programs without a VCR

**RECORD** and save your favorite TV programs to the DVR to watch later.

When two of your favorite TV programs are scheduled at the same time, **RECORD** one program to the built-in recorder while watching the other!

Never miss your favorite programs that are scheduled at the same time. Simply **RECORD** both programs at the same time. While recording both programs, you can play back a third program you have already recorded.

**RECORD** a single episode or all episodes of your favorite TV programs.

**RECORD** one of your favorite TV programs and at the same time, access any advanced application, such as video-on-demand (VOD).

Not sure if you have room to **RECORD** new programs? Checking your available recording space is easy with the recording space used feature.

## Watch two TV programs at the same time

PIP is built into the Explorer 8000 DVR, so you can watch two live programs at the same time on any make or model TV that is connected to your DVR.

When something exciting occurs in the PIP program, you can easily swap the PIP into the Main screen. Once that program is in the Main screen, you can pause or record it.

When the PIP screen is covering a “must see” moment on the Main screen, simply **MOVE** the PIP screen to a different corner of your TV screen.

**Let's Get Started!**

# Using Your Remote Control

Use the keys on the AllTouch Remote Control to access the DVR and PIP features of your DVR.

This guide describes the keys used to access the DVR and PIP features. For descriptions of the other key functions, refer to the user's guide for your remote control model:

- AT8400™ AllTouch Remote Control User's Guide, part number 749219
- AT8550™ AllTouch Remote Control User's Guide, part number 4006383

**Important:** Your remote control must be set to Cable Mode (CBL) to access the DVR features.

## AllTouch AT8400 Remote Control

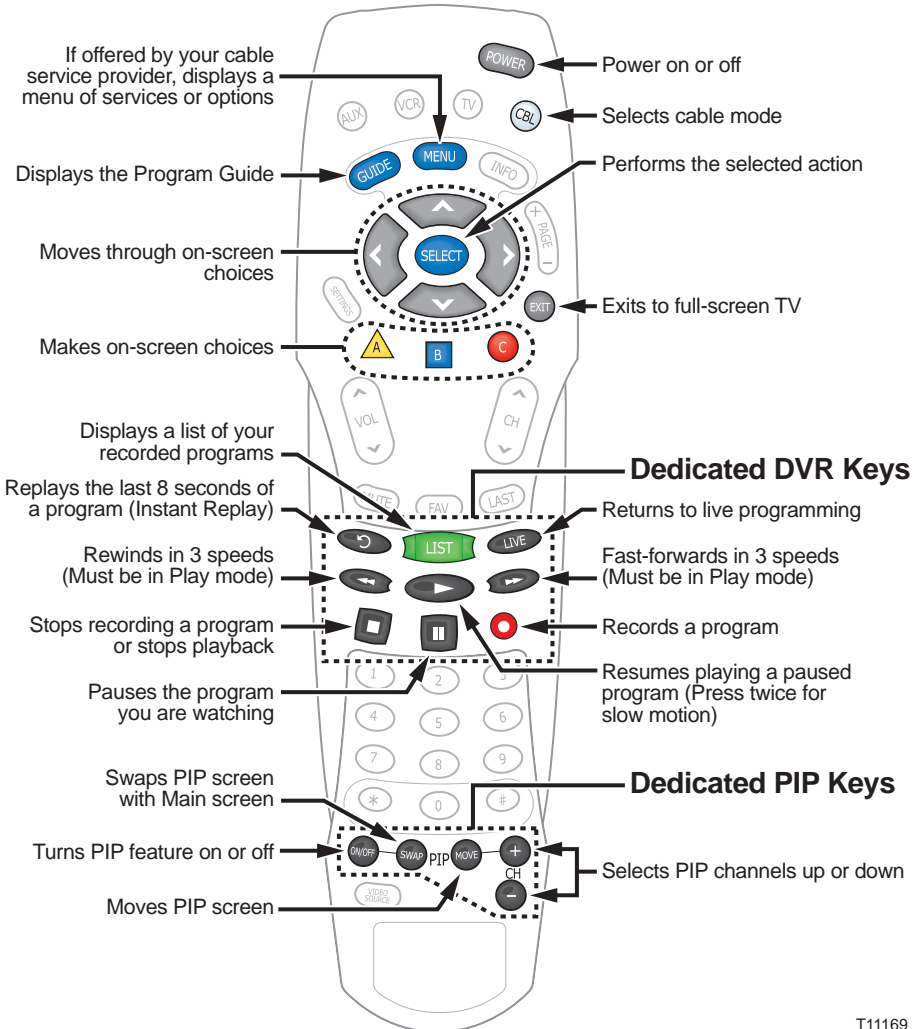

# Preparing the Explorer 8000HD DVR to Work With Your High-Definition TV

If you have an Explorer 8000HD DVR and an HDTV, and you are not using a Digital Visual Interface (DVI) connection, you may need to set up the DVR so that it provides video to your HDTV in picture formats that your HDTV supports. Otherwise, your picture quality may be less than optimal.

During installation, your cable service provider may have already selected an appropriate picture format for you, or the factory setting of the DVR may be compatible with your HDTV. In either of these instances, you should see a picture when you turn on your HDTV and DVR.

## If your HDTV supports:

## The HDTV displays this when ON:

## Follow these steps to setup the DVR:

A 1080i picture format



or



There are no steps to follow. (Your HDTV uses the picture format that the DVR is set to when it leaves the factory.)

**Optional:** Although the DVR uses a format that your HDTV supports, you may find the picture quality less than optimal when viewing certain picture formats. To enhance the display of certain formats, select additional picture format settings. For details, see “Selecting Picture Formats With the Setup Wizard” on page 5.

These picture formats:

- 480i (standard or wide)
- 480p (standard or wide)
- 720p (wide only)

A black screen



Use the keys on the front of the DVR to select these formats. See the instructions for “Selecting Compatible Picture Formats” on page 7.

## Selecting Picture Formats With the Setup Wizard

Setting up the DVR to support a variety of picture formats allows you to toggle among the settings you have chosen while watching TV. You can also select the setting that provides the best picture quality for the format currently being broadcast.

**Note:** If your HDTV displays a black screen when you turn on the HDTV and the DVR, you may need to select a compatible picture format for your HDTV. Go to **Selecting Compatible Picture Formats** on page 7.

There are three ways you can select picture formats for your HDTV. The 8000HD Setup Wizard guides you through each one:

- The **Quick Setup** method, which automatically selects a setting according to the screen type:
  - For a standard-screen (4:3) HDTV, the Wizard selects 480i.
  - For a wide-screen (16:9) HDTV, the Wizard selects 1080i.
- The **Standard Setup** method, which selects the settings 480i and 1080i. You can then toggle between these two settings while watching TV.
- The **Custom Setup** method, which allows you to select any combination of the following picture formats that the DVR supports:
  - 480p (wide and standard)
  - 480i (wide and standard)
  - 720p (wide only)
  - 1080i (wide only)

## Setting Up Your Explorer 8000HD DVR With an HDTV

If you have an HDTV, use the component outputs to connect the DVR to your HDTV. Refer to the *Explorer 8000 Home Entertainment Server User's Installation Guide* (part number 4002771) for connection information.



Follow these steps to start the Setup Wizard.

1. Make sure that the Explorer DVR is **Off** and the HDTV is **On**.
2. On the Explorer DVR, press **Guide** and **Info** at the same time. The **TV Connection Set-up** screen appears, and the front panel LED displays either **HD-1** or **SD-1**. This LED changes between HD-1 and SD-1 every few seconds.
3. When the front panel LED displays **HD-1**, press **A**. The **Output Selection** screen appears.









*Press the **Guide** and **Info** keys at the same time*



4. Choose one of the following options:

- If you have a standard-screen (4:3) HDTV, press .
- If you have a wide-screen (16:9) HDTV, press .

5. Choose one of the following options:

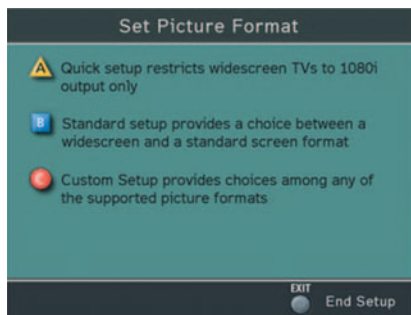

- To choose the **Quick Setup** option press . Press  to begin watching television.
- To choose the **Standard Setup** option press ; then follow the on-screen instructions. When you finish, press  to exit the setup. Then press  to begin watching television.
- To choose the **Custom Setup** option, press ; then follow the on-screen instructions. When you finish, press  to exit the setup. Then press  to begin watching television.



## Setting Up Your Explorer 8000HD DVR With an SDTV

If you have a standard-definition TV (SDTV), use the composite outputs to connect the DVR to your TV. Refer to the *Explorer 8000 Home Entertainment Server User's Installation Guide* (part number 4002771) for connection information.





Follow these steps to start the Setup Wizard.

1. Make sure that the Explorer DVR is **Off** and the TV is **On**.
2. On the Explorer DVR, press **Guide** and **Info** at the same time. The **TV Connection Set-up** screen appears, and the front panel LED displays either **HD-1** or **SD-1**. This LED changes between HD-1 and SD-1 every few seconds.
3. When the front panel LED displays **SD-1**, press . Press  to begin watching television.

## Selecting Compatible Picture Formats

If your HDTV displays a black screen when you turn it on, the DVR may not be sending your HDTV a picture format that your HDTV supports. Follow these steps to select picture format settings that your HDTV supports.

**Note:** Rather than selecting a single picture format setting, you may want to select all settings that your HDTV supports. Setting up the DVR to support a variety of picture formats allows you to toggle among the different settings while viewing TV and select the setting that provides the best picture quality for the format being broadcast.

1. Find the picture formats that your HDTV supports. (If necessary, refer to the user's manual that came with your HDTV.)
2. If the DVR is off, press **Cable**  and then **Power**  on the remote control to turn it on.
3. On the front of the DVR, press and hold **Select**  until the **Message Light**  blinks.
4. On the front of the DVR, press **Vol -**  to indicate that you want to select a picture format setting. The LED displays **HdSr** to indicate that you are in the Picture Format mode for HDTV screens.
5. Use the following table to select settings that your HDTV supports.

**Important:** You have 20 seconds to begin selecting picture format settings. After 20 seconds, **HdSr** disappears to indicate that the DVR is no longer in the Picture Format mode. If this occurs, repeat this process by starting at step 3.







To Select This Picture Format:	On the DVR Press:	The DVR Briefly Displays:	And Then Briefly Displays:
480i	<b>CH+</b>	480i	SEt
720p	<b>VOL-</b>	720p	SEt
480p	<b>CH-</b>	480p	SEt
1080i	<b>VOL+</b>	1080i	SEt







**Note:** The default picture format setting is 1080i.



6. To start watching TV, make sure the remote control is in Cable mode and press **Power** .

# Controlling Live TV





## Control a Live Program You Are Watching

The **Pause** , **Rewind** , **Fast-Forward** , **Play** , **Instant Replay** , and **Live**  keys on the remote control are used to control the live program in the Main screen.

For example, when you are watching your favorite live TV program and the telephone rings, press **Pause**  to pause the program for up to 1 hour. To reverse or advance one frame at a time, press **Pause**  and then repeatedly press **Rewind**  or **Fast-Forward** . For example, to advance three frames, press **Pause**  and then press **Fast-Forward**  three times.

To resume watching your favorite program, press **Play** , and then press **Rewind**  or **Fast-Forward**  to cycle through three different speeds of rewind or fast-forward.

To replay the last 8 seconds of a live or recorded program, press **Instant Replay** .

To see the action in slow motion, press **Play**  from normal play mode. Press **Play**  again to resume normal play mode. From **Pause** mode, press **Pause**  or **Play**  to resume the normal play mode.

If you have rewound or paused a live program, press **Live**  at anytime to catch up to the live TV program.

**Note:** You can use these same dedicated DVR keys to control the reduced screen (also known as the quarter screen) in the Program Guide and in all DVR screens.



T11170

## Pause a Live Program



The paused status bar appears when you press **Pause** .

**Note:** All of the features for controlling live TV (such as Pause, Fast-Forward, and Rewind) are also available when playing back recorded programs.







# Using the Program Guide

## Find a Program to Watch





1. Press **Guide** . The Program Guide appears and lists the next 7 days of programs.
2. Press the **directional keys**  to move through the program listings and highlight the program you want to watch.
3. Press **Select** . If the program is currently on, the Program Guide closes and the program you selected appears in full-screen TV. If the program is on in the future, a future program option screen appears.



## Search for a Program by Channel, Title, or Theme



1. Press **Guide** . The Program Guide appears and lists the next 7 days of programs.
2. Press **Browse By** . The Browse By area of the Program Guide displays the options Title, Channel, and Theme.
3. Press **Move Up**  or **Move Down**  to highlight one of the following options:
  - **Channel**, which lists programs numerically by channel number
  - **Title**, which lists programs alphabetically by program title
  - **Theme**, which lists programs by theme, such as adventure, comedy, sports, or news
4. Press **Select** . The Browse By area of the Program Guide displays the programs according to the option you selected.

## Search for a Program by Date

1. Press **Guide** . The Program Guide appears and lists the next 7 days of programs.
2. Press **Date** . The Browse By area of the Program Guide displays the next 7 dates.
3. Press **Move Up**  or **Move Down**  to highlight a date.
4. Press **Select** . The Program Guide displays the programs that will be broadcast on that date.



# Recording TV Programs

## Record a TV Program You Are Watching

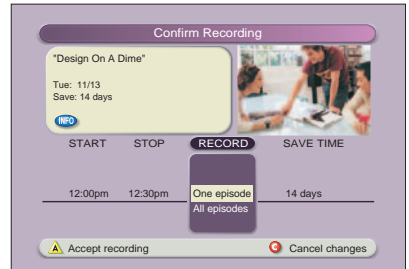
1. Press **Record** .
2. While in the **Confirm Recording** screen, choose your recording options and press . The **Record Indicator** is lit on the front panel of the DVR.
3. To manually stop recording before the scheduled time, press **Stop**  and then follow the on-screen choices.





## Record a TV Program From the Program Guide

1. Press **Guide** .
2. Press the arrow keys to highlight a TV program, and then press **Record** .
3. In the **Confirm Recording** screen, choose your recording options and press . The recording program is highlighted in red in the Program Guide.



## Record Multiple Episodes of a TV Program

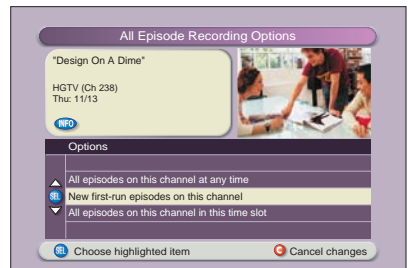
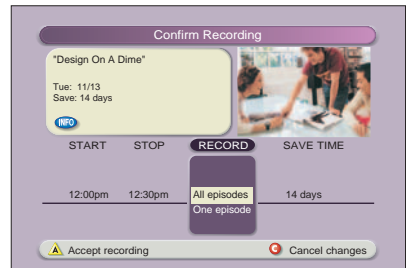

If you want to record all the episodes of a program you are watching, follow these steps:

1. Press **Record** .
2. Choose **One Episode** or **All Episodes**. Notice the information in the fourth column changes, based on your selection. Press . If you selected **All Episodes** from the third column, the **All Episode Recording Options** screen appears.
3. Choose one of the options on the screen.
4. Press **Select**  to save your settings. **Note:** The "New first-run episodes on this channel" option is subject to availability in your area.





# Watching Your Recordings

## Access and Play Back Your Recorded Programs Anytime

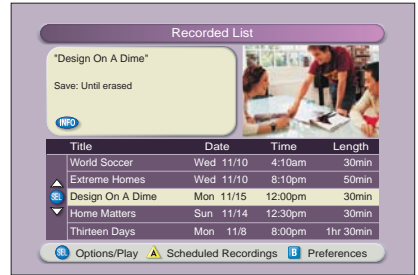
1. Press **List** .
2. Use the arrow keys to choose the program you want to play back.
3. Press **Select**  to display your options.



## Access and Play Back Your Recorded Programs From the Program Guide

1. Press **Guide** .
2. Use the arrow keys to choose the **DVR** channel.  
**Note:** The DVR channel is a dedicated channel that allows you to play back your recorded programs.
3. Press **Select**  to play back the program.



# Managing Recording Space

## How Much Recording Space Do I Have?

1. Press **List** .
2. Press **B** to display the Preferences screen, which displays the percentage of recording space used.

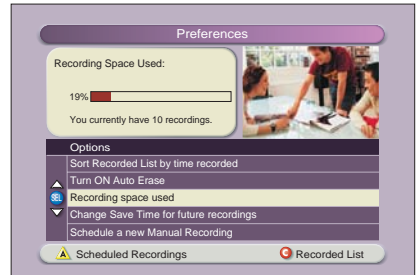

## Automatically Erasing Oldest Recordings If Space Is Needed

Turning Auto Erase on will automatically erase just enough of your oldest recordings so there is enough space to record your new programs.

**Note:** Any recordings that have a Save Time of "Until I Erase" will not be automatically erased.

1. Press **List** .
2. Press **B** to display the Preferences screen.
3. Choose **Turn ON Auto Erase**.



# Copy Recordings to a VCR Tape

The Copy to VCR feature lets you use your VCR as a back-up storage device for the hard drive in your DVR. In other words, you can archive your recordings to a VCR tape.

Verify that the **OUT 2 (VCR)** outputs are connected to your VCR. When you want to archive a TV program to VCR tape, first record the program to your DVR. Then, copy the program from the DVR to your VCR.

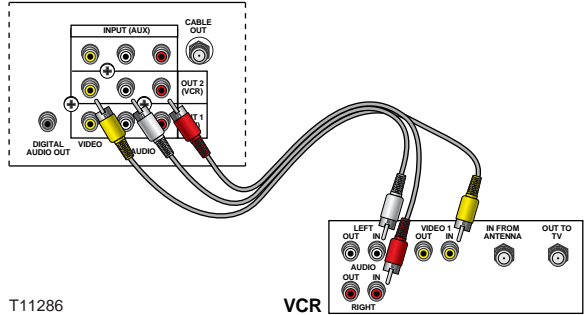









The program that you are copying appears in the *PIP window*. You can watch or record another program or even change channels in the Main screen without affecting the copy in progress.



**Warning: Avoid electric shock. Unplug all electronic devices before connecting or disconnecting any device cables to the DVR.**

## Copy a Recording

1. Connect the VCR to the **OUT 2 (VCR)** connection on the back of the Explorer DVR. See **Set Up Connections** on page 12 for more information.
2. Make sure that a tape is in your VCR and that the VCR is set to record.
3. Press **List** . The Recorded List screen appears.
4. Press **Move Up**  or **Move Down**  to highlight the recording you want to copy to the VCR. Make sure to select a program that is not currently being recorded.
5. Press **Select** . The Recorded Program Options screen appears.
6. Press **Move Up**  to highlight "Copy to VCR."
7. Press **Select** . The Copy to VCR screen appears.
8. Make sure your VCR is properly connected to your DVR outputs, and press **Record** on your VCR.
9. Press **Start copy** . The recording begins copying to VCR tape, and the Recorded List displays and shows the VCR symbol .

**Note:** You can watch the copying in progress through the PIP.

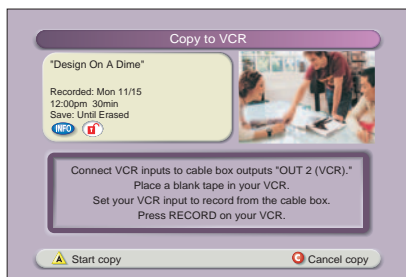
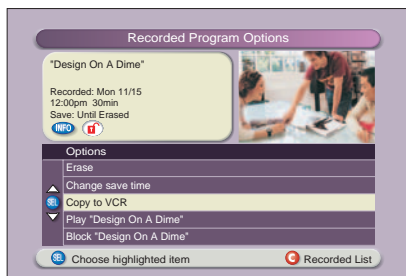
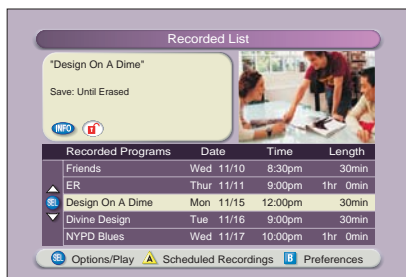



# Using Picture-In-Picture

## Activate PIP on Your TV



While watching a program, press **PIP On/Off**  to activate the PIP screen.

### Notes:

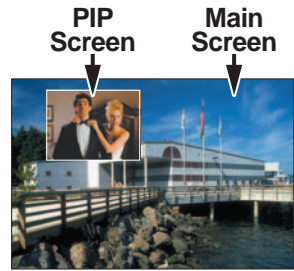
- To pause or record the video in the PIP screen, you must first swap it to the Main screen.
- You can only use the dedicated DVR keys (**Pause, Rewind, Fast-Forward**) to control the program shown in the Main screen.
- To change the channel in the PIP screen, use **PIP CH+**  and **PIP CH-** .



## Activate PIP From the Program Guide

From the Program Guide, press **Exit**  or **Guide**  to close the Program Guide, and then press **PIP On/Off**  to activate PIP. You can only activate PIP from full-screen video.

## Swap the Main and PIP Screens

To swap the TV program that is in the PIP screen to the Main screen, press **PIP Swap** .

**Note:** You will only hear the audio for the program shown in the Main screen.

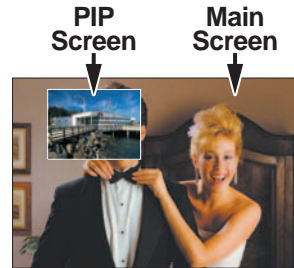

## Move the PIP Screen

To move the PIP screen clockwise to a different corner of the Main screen, press **PIP Move** . You can move the PIP screen to any of the four corners of the Main screen.

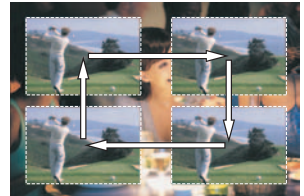

# Use Power-Save Mode

To maximize the life of your DVR, you should power-down the DVR when it is not in use. Simply press **CBL** and then press **Power** on your remote control, or press **Power** on the front panel of the DVR. The Power light turns off, but because the DVR still is plugged in, your scheduled recordings still occur.

Between 1:00 a.m. and 6:00 a.m. every day, your DVR will automatically enter Power-Save mode. In Power-Save mode, the set-top is powered-down, but all scheduled recordings still occur. When the DVR enters Power-Save mode, your TV displays a black screen.

At approximately 1:10 a.m., the DVR displays a 5-minute warning banner, which states that the DVR is about to enter Power-Save mode. When the banner appears, do one of the following:

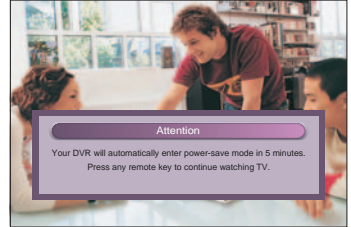

- To allow the DVR to enter Power-Save mode, do nothing when the warning banner appears. The DVR will automatically power-down. After your DVR powers down, you must press **CBL** and then press **Power** on your remote control, or press **Power** on the front panel of your DVR to start watching TV again.
- To stop the DVR from entering Power-Save mode, simply press any key on your remote control when the warning banner appears.

From 1:10 a.m. through 6:00 a.m., the DVR displays the warning banner if you do not press a key on the remote control or the front panel within 2 hours.





# Frequently Asked Questions



**How far back can I rewind live TV?** The length of time you can rewind live TV depends on how long you have been tuned to a single channel. Each time you change channels, a new copy is automatically stored to the built-in recorder. This copy saves up to the last 1 hour of programming. For example, if you have been watching the same channel for 15 minutes, you can rewind that 15 minutes of the program.

**Can I record the quarter screen in the Program Guide or the DVR Recorded List?** Yes, you can record the quarter screen on all DVR screens by pressing **Record** . You can also record the quarter screen in the Program Guide. Press **Exit**  to display the video in full screen, and then press **Record** .

**Note:** Pressing **Record**  while in the Program Guide will record the highlighted program in the grid.

**Can I record or pause the video in the PIP screen?** Yes, but you must swap it to the Main screen first. After pressing **Record**  and confirming the recording, you can swap it back to the PIP screen and it will continue recording. You can also press **PIP On/Off** , and the video will continue to record.

**If I've been tuned to a program since it started, do I have to rewind to the beginning to record the entire program?** No, if you have been tuned to the program since its beginning, just press **Record**  from any point in the program to record the entire program. Recording will automatically stop when the program ends.

**How will I know the DVR is almost out of recording space?** When you try to schedule the next recording, a warning appears on the Confirm Recording screen. Also, you can see what percentage of recording space you have used. Press **List**  and then press  for preferences.

**Can you play back more than one recording?** No, you cannot play back more than one recording at a time.

**What happens if my DVR loses power temporarily?** Everything you have recorded is saved, based on the save time you selected in the Confirm Recording screen. Your scheduled recordings during the time the DVR lost power are the only recordings you may miss.

**Do my Parental Controls in the Program Guide carry over to DVR recordings?** Yes. If you block programs by channel or rating in the General Settings menu, those settings are carried over to DVR recordings. For example, if you decide to block all R-rated programs in the General Settings menu, the R-rated programs will still be recorded, but you cannot play them back until you enter the correct PIN.

**How do I block or erase individual recordings in my recorded list or change the save time for the recording?** Highlight the recording on the Recorded List screen, and press **Select**  on the remote control. An Options screen appears for the program you selected.



© 2004 Scientific-Atlanta, Inc. All rights reserved.

AllTouch, Explorer, Scientific-Atlanta, and the Scientific-Atlanta logo are registered trademarks of Scientific-Atlanta, Inc. 8000, 8000HD, AT8400, and AT8550 are trademarks of Scientific-Atlanta, Inc. All other trademarks shown are trademarks of their respective owners. Product and service availability subject to change without notice.

Scientific-Atlanta, Inc., 5030 Sugarloaf Parkway, Box 465447, Lawrenceville, GA 30042  
[www.scientificatlanta.com](http://www.scientificatlanta.com)

June 2004 Printed in USA.

740246 Rev E

For questions or comments, call your cable service provider.