



**DVR-4TH**

**DVR-8TH**

**DVR-16TH**

**Digital Video Recorder Family  
With Network/DDNS Video Server**

**User's Manual**

1-800-645-5516  
200 New Highway  
Amityville, NY 11701  
[www.specotech.com](http://www.specotech.com)



## Caution and Preventive Tips

- Take care not to drop the unit or subject the unit to major shocks or jolts.
- Do not place this unit on an unstable stand, bracket or mount.
- This unit is designed for indoor use only. Do not place the unit near water or in other extremely humid conditions.
- This unit should not be placed in a built-in installation unless proper ventilation is provided.
- Please check the type of power source available before you plug and operate the unit.
- If the clearing is necessary, note to plug the unit from the outlet before uncovering the top cover. Do not use liquid cleaners or aerosol cleaners. Use only a damp cloth for cleaning.
- Always power down the system prior to connecting and disconnecting accessories, with the exception of USB devices.
- **Lithium battery: Danger of explosion if battery is incorrectly replaced.** Replace with the same type of battery or equivalent type recommended by the battery manufacturer. Dispose of used batteries according to the battery manufacturer's instructions.

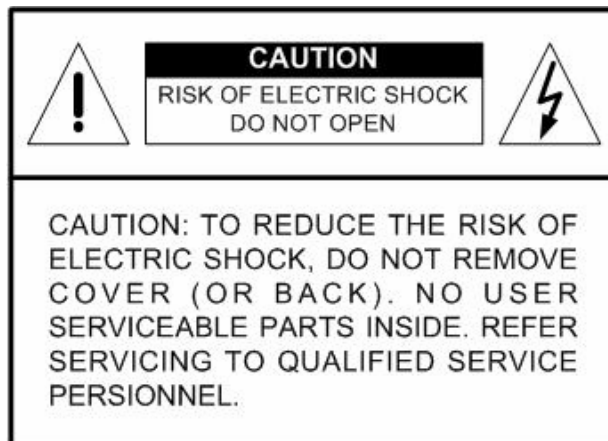

This symbol intends to alert the user to the presence of important operating and maintenance (servicing) instructions in the literature accompanying the appliance.



This symbol intends to alert the user to the presence of unprotected "Dangerous Voltage" within the product's enclosure that may be strong enough to cause a risk of electric shock.

## Important Information

**Before proceeding, please read and observe all instructions and warnings in this manual.** Retain this manual with the original bill of sale for future reference and, if necessary, warranty service. When unpacking your unit, check for missing or damaged items. If any item is missing, or if damage is evident, DO NOT INSTALL OR OPERATE THIS PRODUCT. Contact your dealer for assistance.

## Rack Mounting

Consult with the supplier or manufacturer of your equipment rack for the proper procedure and hardware for mounting this product in a safe fashion. Avoid uneven loading or mechanical instability when rack-mounting units. Make sure the units are installed to get enough airflow for safe operation. The maximum temperature for rack-mounted units is 104 °F/40 °C. Check product label for power supply requirements to assure that no overloading of supply circuits or over current protection occurs. Main grounding must be reliable and uncompromised by any connections.

## Table of Contents

<b>1. Overview .....</b>	<b>13</b>
1.1 Product Key Features .....	14
1.2 Product Application Diagram.....	15
<b>2. System Setup.....</b>	<b>16</b>
2.1 Position the Unit.....	16
2.2 Selecting Video Format.....	16
2.3 Connecting Devices to the Unit.....	16
2.4 Rear Panel Connections .....	17
<b>3. General System Setup .....</b>	<b>20</b>
3.1 Front Panel Introduction .....	20
3.1.1 LED Definition .....	20
3.1.2 Functional Keys .....	21
3.2 Entering OSD Setup Menu .....	24
3.2.1 User Management .....	25
3.3 Configuring the HDD in the unit .....	26
3.4 Power On/ Off the Unit.....	26
3.5 System Date/ Time Setting .....	28
3.5.1 Set Date/ Time .....	28
3.5.2 Daylight Saving Time Setup .....	29
3.5.3 Network Time Protocol Setup.....	30
3.6 IP Camera Setting .....	30
3.6.1 IP Camera Information .....	31
3.6.2 Connection Setup .....	32
3.6.3 Device Setup.....	33
3.6.4 Activated .....	33
3.6.5 Status .....	33
3.7 Record Schedule/ Quality Setting .....	34
3.7.1 Record Mode Setup .....	34
3.7.2 Schedule Setup.....	34
3.7.3 Preset Record Configuration.....	35
3.7.4 Per Camera Configuration .....	36
3.7.5 Record Event Video Only.....	36
<b>4. Basic Operation.....</b>	<b>37</b>
4.1 Viewing Live/ Playback Video .....	37
4.1.1 Viewing Modes.....	37
4.1.2 Digital Zoom.....	38
4.1.3 Viewing Live Cameras .....	38

To Freeze Live Image.....	38
4.1.4 Viewing Recorded Video.....	38
Key Usage in Playback.....	39
Pause Playback and Single Step Forward/ Backward.....	39
4.2 Sequence Setup.....	40
4.2.1 Sequence on Main Monitor.....	40
4.2.2 Call Monitor Control.....	40
4.3 Searching Recorded Video.....	41
4.3.1 Searching by Time.....	41
4.3.2 Calendar Search.....	42
4.3.3 Smart Search.....	43
4.3.4 Searching by Event.....	44
4.3.5 Search by Text.....	45
4.4 Video Export.....	46
4.4.1 Export from OSD Setup Menu.....	46
4.4.1.1 Select the External Device.....	47
4.4.1.2 Select Video for Exporting.....	47
4.4.1.3 Digital Signature.....	48
4.4.1.4 Erase Disc.....	49
4.4.2 Quick Video Export through Front Panel.....	49
4.4.2.1 ezBurn Introduction.....	49
4.4.2.2 Export Normal Video.....	50
4.4.2.3 Export Event Video.....	50
4.5 Deleting Recorded Video.....	51
4.6 Dome Control.....	52
4.6.1 Dome Connection.....	52
4.6.2 Dome Protocol Setup.....	52
4.6.3 RS485 Setup.....	53
4.6.4 Dome Controlling Key.....	54
4.6.5 Setting Preset Points.....	55
4.6.6 Calling Preset Points.....	56
4.7 Manual Digital Deterrent.....	57
4.8 2-Way Audio Talk Function.....	57
4.9 UPnP Function.....	58
4.9.1 Setting Up the DVR and the PC.....	58
4.9.2 UPnP NAT Traversal Function.....	58
4.10 Boot Log Exportation.....	59
<b>5. Advanced System Configuration.....</b>	<b>60</b>
Account and Password.....	60
Key Usage in OSD setup menu.....	60

Key Usage in Virtual Keyboard .....	61
5.1 System Setup .....	62
5.1.1 System/Version Info .....	62
5.1.1.1 DVR System Information & Version Numbers .....	62
5.1.1.2 Software Upgrade via Local Device .....	63
5.1.1.3 Software Upgrade via Internet .....	63
5.1.2 Language .....	64
5.1.3 Date / Time .....	64
5.1.3.1 Date / Time .....	64
5.1.3.2 Time Zone .....	65
5.1.3.3 Date / Time Display .....	65
5.1.3.4 Date Display Mode .....	65
5.1.3.5 Time Display Mode .....	66
5.1.3.6 Daylight Saving Time Setup .....	66
Daylight Saving Time .....	66
DST Start / End .....	66
DST Bias .....	66
5.1.3.7 Network Time Protocol Setup .....	66
NTP Server .....	66
Automatically Time Sync .....	67
Manually Time Sync .....	67
5.1.4 Unit Name .....	67
5.1.5 Show Unit Name .....	67
5.1.6 User Management .....	68
5.1.6.1 Password Protection .....	68
5.1.6.2 Account Setup .....	68
5.1.6.3 Authority Setup .....	68
5.1.6.4 Load Default Setting .....	69
5.1.7 Network Setup .....	69
5.1.7.1 LAN Select .....	70
5.1.7.2 LAN Setup .....	70
DHCP .....	71
IP .....	71
Netmask .....	71
Gateway .....	71
DNS .....	72
PPPoE Account .....	72
PPPoE Password .....	73
PPPoE Max Idle .....	73
Connect At Booting .....	73

	Network Restart .....	73
5.1.7.3	Modem Setup.....	74
	Dial-in Setup .....	74
	Dial-out Setup .....	76
	Dial Port Selection .....	79
5.1.7.4	Trigger Port .....	79
5.1.7.5	Email Address .....	80
5.1.7.6	SMTP Setup.....	80
	Email via SMTP .....	80
	SMTP Server .....	81
	SMTP Port .....	81
	SMTP Account .....	81
	SMTP Password .....	82
5.1.7.7	DDNS Setup .....	82
	Enable DDNS.....	82
	Host Name.....	82
	DDNS Port.....	83
	Submit/ Update .....	83
	ezDDNS .....	83
5.1.7.8	UPnP Setup.....	84
	UPnP .....	84
	UPnP NAT Traversal .....	84
5.1.8	RS485 Setup.....	84
5.1.8.1	Unit ID.....	84
5.1.8.2	Baud Rate .....	85
5.1.8.3	Bits.....	85
5.1.8.4	Stop.....	85
5.1.8.5	Parity.....	85
5.1.9	Audio Output/ Key Beep.....	85
5.1.9.1	Audio Output .....	85
5.1.9.2	Key Beep .....	86
5.1.10	User Graphic Interface .....	86
5.1.11	IP Camera Support.....	86
5.2	Monitor Setup .....	87
5.2.1	Show Camera Title.....	87
5.2.2	Title Position.....	87
5.2.3	Monitor Brightness .....	88
5.2.4	Monitor Contrast .....	88
5.2.5	Monitor Chrominance.....	88
5.2.6	VGA Resolution.....	88



5.2.7	VGA Frequency.....	89
5.2.8	Show Color Bar.....	89
5.3	Camera Setup.....	90
5.3.1	Analog Camera.....	90
5.3.1.1	Camera Select.....	90
5.3.1.2	Dome Protocol.....	90
5.3.1.3	Dome ID.....	90
5.3.1.4	Camera Title.....	91
5.3.1.5	Covert/Privacy Mask.....	91
	Covert.....	91
	Privacy Mask.....	92
	Privacy Mask Select.....	92
5.3.1.6	Termination.....	92
5.3.1.7	Brightness.....	92
5.3.1.8	Contrast.....	92
5.3.1.9	Saturation.....	93
5.3.1.10	Hue.....	93
5.3.1.11	Audio Association.....	93
5.3.1.12	Copy Settings.....	93
5.3.2	IP Camera.....	93
5.3.2.1	IP Camera Select.....	94
5.3.2.2	IP Camera Title.....	94
5.3.2.3	Search Via UPnP.....	94
5.3.2.4	Hostname/IP.....	94
5.3.2.5	Model.....	95
5.3.2.6	Connection Setup.....	95
	Account.....	95
	Password.....	95
	Management Port.....	95
	Streaming Format.....	95
	Advance Streaming Option.....	95
	Streaming Port.....	95
	Streaming Protocol.....	96
	IP Dome Protocol.....	96
5.3.2.7	Device Setup.....	96
	Product ID.....	97
	Image Resolution/ FPS/ Compression/ Quality.....	97
	Sharpness/ Brightness/ Contrast/ Saturation/Hue.....	97
	Apply.....	97
5.3.2.8	Activated.....	98

5.3.2.9	Status .....	98
5.3.2.10	Copy Settings.....	98
5.4	Record Setup.....	99
5.4.1	Record Mode Setup .....	99
5.4.1.1	Record Resolution .....	99
5.4.1.2	Record Format .....	100
5.4.1.3	Max Rec. PPS.....	100
5.4.2	Schedule Setup.....	100
5.4.2.1	Day / Night Time Start / End .....	100
5.4.2.2	Weekend Schedule .....	100
5.4.2.3	Weekend Start / End .....	101
5.4.3	Preset Record Configuration.....	101
5.4.4	Per Camera Configuration .....	101
5.4.4.1	Camera Select .....	102
5.4.4.2	Normal PPS .....	102
5.4.4.3	Normal Qlty .....	102
5.4.4.4	Event Max PPS.....	102
5.4.4.5	Event Qlty .....	102
5.4.4.6	Event Active .....	102
5.4.5	ezRecord Setup .....	103
5.4.6	Data Lifetime Setup.....	104
5.4.6.1	Data Lifetime Mode .....	104
5.4.6.2	Data Lifetime .....	104
5.4.6.3	Data Lifetime By Day .....	104
5.4.6.4	Data Lifetime By Channel .....	105
5.4.7	Pre-Alarm Recording .....	105
5.4.8	Circular Recording .....	105
5.4.9	Audio Recording .....	105
5.4.10	Purge Data.....	106
5.4.10.1	Purge All Data .....	106
5.4.10.2	Purge All Event Data .....	106
5.4.10.3	Purge Event Before.....	106
5.4.10.4	Start To Purge .....	106
5.5	Sequence Setup .....	107
5.5.1	Main / Call Monitor Dwell .....	107
5.5.2	Main / Call Monitor Schedule .....	107
5.6	Event Setup .....	108
5.6.1	Internal Buzzer .....	108
5.6.2	Event Icon .....	108
5.6.3	Email Notice.....	108

5.6.4	Email Attachment .....	109
5.6.5	Alert Notification Setup.....	109
5.6.5.1	Alert Configuration Set.....	109
5.6.5.2	Alert Notification.....	109
5.6.5.3	Alert IP .....	110
5.6.5.4	Alert Port.....	110
5.6.5.5	Alert Interval.....	110
5.6.6	Event Full Screen.....	110
5.6.7	Event Duration .....	110
5.6.8	Per Channel Config.....	110
5.6.8.1	Channel Select.....	111
5.6.8.2	Video Loss Detect.....	111
5.6.8.3	Motion Detect.....	111
5.6.8.4	Detection Config .....	111
	Detected Area Setup.....	111
	Sensitivity.....	112
	Area Threshold .....	112
5.6.8.5	Alarm In .....	112
5.6.8.6	Alarm Out.....	112
5.6.8.7	Digital Deterrent – Day/ Night/ Weekend .....	113
5.7	Database Setup.....	115
5.7.1	Total / Free Size of HDD .....	115
5.7.2	Avail. Rec Time .....	115
5.7.3	Est. Rec Period .....	115
5.7.4	Internal / External Disks .....	116
5.7.5	NAS Device.....	117
5.8	Configuration .....	117
5.8.1	Load Factory Default.....	118
5.8.2	Import Configuration .....	118
5.8.3	Export Configuration .....	118
5.8.3.1	Copy Destination.....	119
5.8.3.2	Configuration Name .....	119
5.8.3.3	Begin Export .....	119
5.8.4	Import Deterrent.....	119
5.8.5	Export Deterrent.....	120
5.8.6	Boot Log.....	120
5.8.7	Operation Log .....	120
5.9	Video Export .....	120
5.9.1	Select Device .....	121
5.9.2	Select Channel.....	122

5.9.3	From / To Time .....	122
5.9.4	Select Events .....	122
5.9.5	Data Type .....	122
5.9.6	Export Format .....	123
5.9.7	Digital Signature .....	123
5.9.8	Erase Disc .....	123
5.9.9	Begin Export .....	123
5.10	POS Setup .....	124
5.10.1	POS Function .....	124
5.10.2	POS Overlay .....	124
5.10.3	Exception POS Setup .....	125
5.10.3.1	Exception No .....	125
5.10.3.2	Trigger .....	125
5.10.3.3	Exception String .....	125
5.10.3.4	By Numerals .....	125
5.10.4	Input Setup .....	126
5.10.4.1	Port Selection .....	127
5.10.4.2	Input source .....	127
5.10.4.3	Camera Selection .....	127
5.10.4.4	Text Filter .....	127
5.10.4.5	Manual Filter Setup .....	128
5.10.4.6	Input Process .....	128
5.10.4.7	Text Baud Rate .....	128
5.10.4.8	Text Bit .....	128
5.10.4.9	Text Stop .....	128
5.10.4.10	Text Parity .....	128
5.11	Shutdown .....	129
5.11.1	Power Off .....	129
5.11.2	Reboot .....	129
5.11.3	Auto Rebooting .....	129
5.11.4	Rebooting Time .....	129
<b>6.</b>	<b>Remote Monitoring Software .....</b>	<b>130</b>
6.1	Remote Monitoring System Requirements .....	130
6.2	Software Installation .....	131
6.2.1	Change Internet Settings .....	131
6.2.2	Install Remote Monitoring Software .....	133
6.2.2.1	Login / Logout .....	134
6.2.2.2	Software Upgrades .....	135
6.3	Basic Operation for Remote Monitor .....	135
6.3.1	View Live Video .....	135

6.3.1.1	Select Display Mode .....	136
6.3.1.2	Operate Cameras with Dome Control .....	136
6.3.2	Instant Recording .....	137
6.3.2.1	Record Video Instantly .....	137
6.3.2.2	Playback Instant Recorded Video .....	137
6.3.3	Playback Video .....	138
6.3.3.1	Playback Remote Video .....	138
6.3.3.2	Playback Local *.drv Files .....	139
6.3.3.3	Playback Controls .....	139
6.3.4	Verify Digital Signature .....	140
6.3.5	Search from Event List .....	140
6.3.6	Take a Snapshot .....	140
6.3.7	Health Status of HDD .....	141
6.3.8	Normal and Dual Streaming .....	141
6.3.9	Remote Monitoring Software Trouble Shooting Guide .....	142
<b>Appendix A:</b>	<b>Technical Specifications .....</b>	<b>143</b>
<b>Appendix B:</b>	<b>Preset Record Configuration .....</b>	<b>145</b>
<b>Appendix C:</b>	<b>Record Duration .....</b>	<b>147</b>
<b>Appendix D:</b>	<b>Dial-up Connections via Modem .....</b>	<b>149</b>
Establishing	Dial-in Connection .....	149
Establishing	Dial-out Connection .....	153
<b>Appendix E:</b>	<b>Verifying Digital Signature .....</b>	<b>158</b>
<b>Appendix F:</b>	<b>Alarm I/O Pin Definition .....</b>	<b>161</b>
<b>Appendix G:</b>	<b>HDD PC Player Tool Introduction .....</b>	<b>163</b>
Using EXT2IFS	on Your PC .....	163
Start Playing	the *.drv file .....	165
<b>Appendix H:</b>	<b>IR Remote .....</b>	<b>167</b>
<b>Appendix I:</b>	<b>USB Mouse Operation .....</b>	<b>169</b>
Special	Operations .....	169
<b>Appendix J:</b>	<b>ezRecord Diagram Sample .....</b>	<b>171</b>
<b>Appendix K:</b>	<b>Connect to External Storage Device .....</b>	<b>174</b>

# 1. Overview

The **DVR-4TH/ 8TH/ 16TH** series unit is an integrated digital video recorder that combines the features of a time-lapse audio / video recorder, a multiplexer, and a video server to create a single security CCTV solution.

Its outstanding variable operation enables users to view live or playback recorded video, have remote access through network simultaneously while recording other video, and to view previously recorded video instantly by entering the time and date or selecting recorded video from the event list.

The **DVR-4TH/ 8TH/ 16TH** series unit is enhanced to provide Multi-Codec including H.264, MPEG-4, and MJPEG compression mode. Moreover, its distinctive hybrid solution supports the coexistence of network compatible IP devices and convenient analog connections.

The **DVR-4TH/ 8TH/ 16TH** series includes SpecoRemote™, the remote viewing and configuration software that is a Web-browser plug-in, which allows users to view live, or recorded video images, and enables remote configuration. The remote software is stored in the **DVR-4TH/ 8TH/ 16TH** series unit and deployed over a LAN, WAN or Internet connection to remote Windows-based computers. This simplifies the installation and maintenance of the software components so all remote users are kept up to date.

Please refer to the following for the front panel design of the three models.

## DVR-4TH

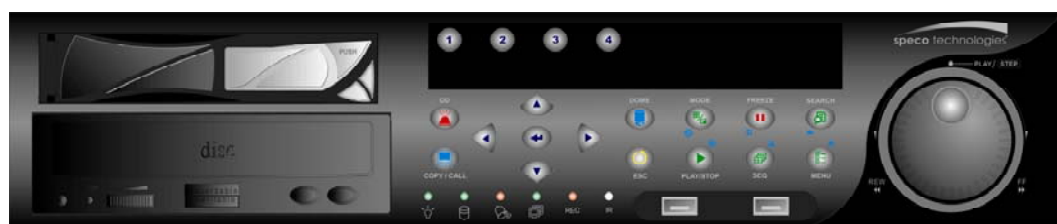

## DVR-8TH

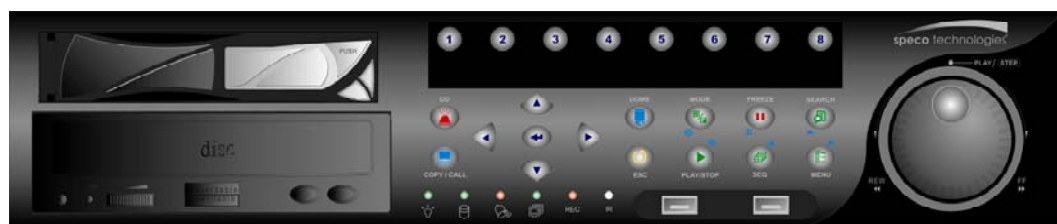

**DVR-16TH**

## 1.1 Product Key Features

The **DVR-4TH/ 8TH/ 16TH** series offers advanced features not typically found in standard multiplexers. It integrates the full features of a DVR, a multiplexer and a video server (by using the software **SpecoRemote™**). The key features of the **DVR-4TH/ 8TH/ 16TH** series are listed as follows.

### Advanced Functions

- H.264 high quality compression
- 4/8/16 channels for video input
- Simultaneous Live/ Playback monitor and remote access via network, while recording without interruption
- **SpecoRemote™** web-based software for remote monitoring and control via LAN or Internet including CMS
- Embedded Linux operating system
- Real-time “live display” for each channel
- Recording frame rate up to 240 pps(NTSC)/ 200 pps(PAL)
- 16 Channels of audio recording/ playback
- Digital Deterrent
- Two-way audio
- 4 USB2.0 ports for video clip export and/or backup
- Easy software upgrade via USB ThumbDrive®, DVD+RW or Internet Remote Application
- Up to 4 internal hard drives (4<sup>th</sup> drive requires removal of the DVD-RW)
- Supports SATA HDDs up to 1TB
- POS Support
- Gigabit LAN (RJ45) for external storage and NAS for **TH** series models
- 2X Digital Zoom available in Live and Playback mode
- Automatic camera detection (Plug & Play)

- Covert camera operation provides enhanced security and administrator control
- Per camera configuration for camera settings, frame rate, picture bit rate, alarms, motion detection.
- Programmable day/ night/ weekend scheduling
- Programmable main monitor/ call-monitor switching sequence
- Powerful alarm processor allows flexible alarm trigger and responses, including alarm, motion, and camera failure
- Dome control protocols: Speco, Pelco D, Pelco P, Fastrax 2, AD422, Panasonic\_C, Panasonic\_N, DSCP and JVC
- 8 levels of password security

## 1.2 Product Application Diagram

According to system demand, connect the unit with selective devices as shown in the system diagram below to complete a video surveillance solution. The figure also displays the expandability and flexibility of this digital recording system.

### System Configuration

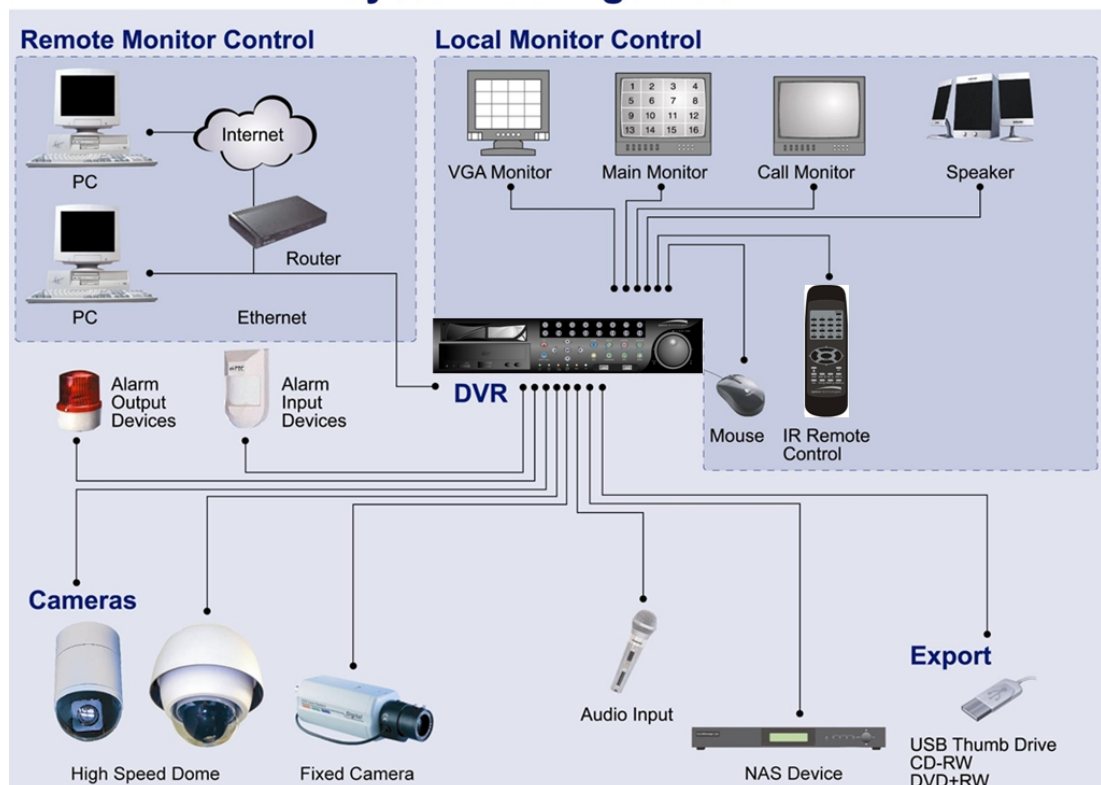



## 2. System Setup

Prior notices and an introduction on system installation will be described in this chapter. Please follow the instructions to operate the unit.

In order to prevent the unit from data loss or system damage that might result from a sudden power fluctuation, the use of an Uninterruptible Power Supply (UPS) is highly recommended.

### 2.1 Position the Unit

Position/ mount the **DVR-4TH/ 8TH/ 16TH** series unit in an appropriate, steady location and make sure the power is off before making any connections. The area should avoid hindering or blocking the unit from airflow. **Sufficient airflow is required to protect the unit from overheating.** The tolerable high temperature of the operating environment is 104°F/ 40°C.

The unit utilizes heat-conducting techniques to transfer internal heat to the case, especially to the bottom side of the unit.



**NOTE: Be sure not to remove the rubber feet, and always leave a space for air ventilation on the bottom side of the unit.**

### 2.2 Selecting Video Format

The **DVR-4TH/ 8TH/ 16TH** series unit is designed to operate under either NTSC or PAL video formats. Please contact a qualified service person to perform the installation procedure.

### 2.3 Connecting Devices to the Unit

This section lists some **important notices that should be read BEFORE making any connections** to the **DVR-4TH/ 8TH/ 16TH** series unit.



**NOTE: Be sure to connect short-term external devices, such as USB ThumbDrive<sup>®</sup>, USB DVD+RW, USB Hard Disk Drive, etc., ONLY AFTER the unit is successfully powered on.**

## Connecting Required Devices

**Before powering up**, you should connect cameras and a main monitor to the unit for basic operation. If needed, connect a call monitor for displaying full screen video of all installed cameras in sequence.

## Connecting Short-term Device

If you plan to install any short-term external devices, such as USB DVD+RW, USB Hard Disk Drive, etc, to the **DVR-4TH/ 8TH/ 16TH** series and want to use them as part of the unit system, **make sure those devices are connected only after the DVR-4TH/ 8TH/ 16TH is powered up**. The **DVR-4TH/ 8TH/ 16TH** series unit can only recognize the external devices after the power-up process is completed.

## 2.4 Rear Panel Connections

There are several connectors on the rear panel of the **DVR-4TH/ 8TH/ 16TH** series unit available for installations. The following figure shows the connectors by name and a detailed description of each connector follows.

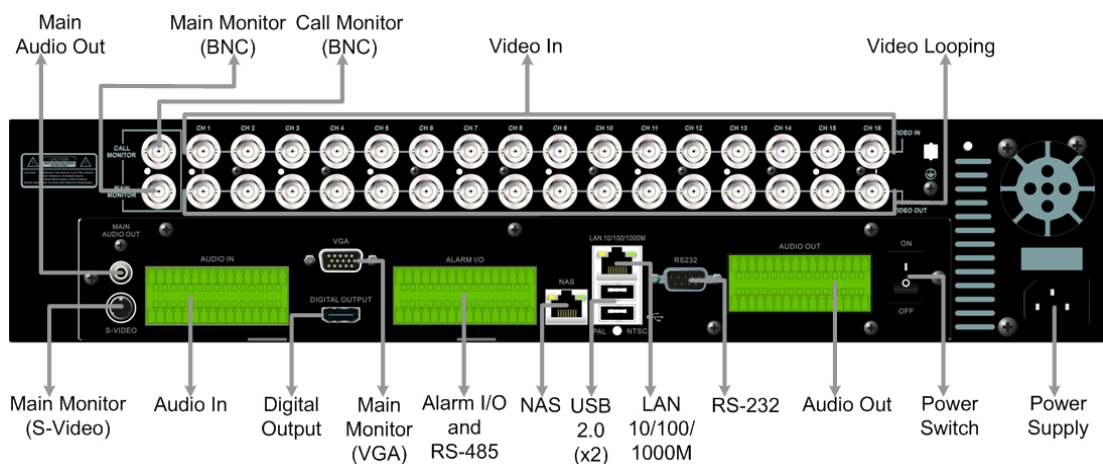

There are two differences on the rear panels of different models:

1. The BNC channel connectors are provided according to the supported number of channels, respectively 4-ch, 8-ch, and 16-ch.
2. The terminal blocks of audio in/out and alarm I/O for **DVR-4TH/ 8TH** is smaller whereas the terminal blocks of audio in/out and alarm I/O for **DVR-16TH** is larger.

The detail description of each connector is as the followings.

### **Main Monitor (S-Video/ BNC/ VGA)**

S-Video, BNC, and VGA output connectors are available for connecting to a main monitor. The main monitor displays live image and playback recorded video in full-screen or multiple window format.

### **Digital Output (Main Monitor)**

A digital output connector is provided for connection to a displaying device that transfers data digitally to show the best video quality.

### **Call Monitor (BNC)**

The call monitor is used to display full screen video of all installed cameras in sequence. The BNC call monitor connector allows the user to connect an optional call monitor to the **DVR-4TH/ 8TH/ 16TH** series unit. Reference to dual monitor support in section **Dual Main Output**.

### **Video Input**

A group of BNC connectors is provided for video input streams from installed cameras. The number of connectors equals to the number of channels. The **DVR-4TH/ 8TH/ 16TH** series unit has 4/ 8/ 16 BNC connectors on the rear panel, respectively.

### **Video Looping**

The other group of BNC connectors positioned on the rear panel is for looping out video input.

### **RS-232C**

The unit provides a RS-232C communication port for sending and receiving signals.

### **Alarm I/O & RS-485 Ports**

The unit provides Alarm I/O and RS-485 ports that offer users the flexibility required to connect the unit to other devices.

Refer to appendix **Alarm I/O Pin Definition** for detailed pin definition on the Alarm I/O for the **DVR-4TH/ 8TH/ 16TH** series unit.

### **NAS**

The **DVR-4TH/ 8TH/ 16TH** series unit can connect to a Network Attached Storage (NAS) device through this connector to increase storage space and allow vast recording.

### **Audio In**

The **DVR-4TH/ 8TH/ 16TH** series unit provides 4/ 8/ 16 channels of audio recording accordingly. The Audio In connectors are offered for connecting audio source devices (e.g. external amplified microphone) to the unit. The PIN of upper row is for input of each channel while the lower row is for ground.

### **Main Audio Out**

One RCA connector is provided for audio output of main monitor.

### **Audio Out**

In addition to the RCA connector, the **DVR-4TH/ 8TH/ 16TH** series unit provides 4/ 8/ 16 channels of audio exporting accordingly. The Audio Out connectors are provided for connecting audio output devices (e.g. amplified speakers) to the unit. The PIN of upper row is for output of each channel while the lower row is for ground.

### **USB 2.0 (x4)**

There are two USB 2.0 ports on the rear panel and two on the front panel to allow users to connect external USB devices to the unit, such as a ThumbDrive<sup>®</sup>, DVD+RW, or a USB mouse.

The **DVR-4TH/ 8TH/ 16TH** series unit allows users to preset the OSD settings using a USB mouse or a USB keyboard.

### **LAN (RJ-45)**

The **DVR-4TH/ 8TH/ 16TH** series unit is capable of networking. Once the unit is connected to the LAN network, the users can remotely access the unit through SpecoRemote™ on a PC.

### **Power Switch**

The power switch is used to power up or shut down the unit.

### **Power Supply**

Connect the power supply cord shipped with the unit to the power supply jack to provide power to operate the **DVR-4TH/ 8TH/ 16TH** series unit.



**NOTE:** Use of other power supply cord may cause overloading.

### 3. General System Setup

Before operating the **DVR-4TH/ 8TH/ 16TH** series unit, some general configuration should be setup in advance. The following subsections will introduce functional keys on the front panel and general configuration of the **DVR-4TH/ 8TH/ 16TH** series unit.

The regularly displayed OSD information and its positions are shown in the following figure. The title of the channel is displayed on the upper left-hand corner of the window, either in full screen mode or in multiple-channel mode. The current operating mode, including Call mode, Dome Control mode, Playback mode, Freeze mode and Sequence mode, is displayed in the status bar located on the lower left-hand corner of the screen. The date/ time information is displayed on the lower right-hand corner of the screen.

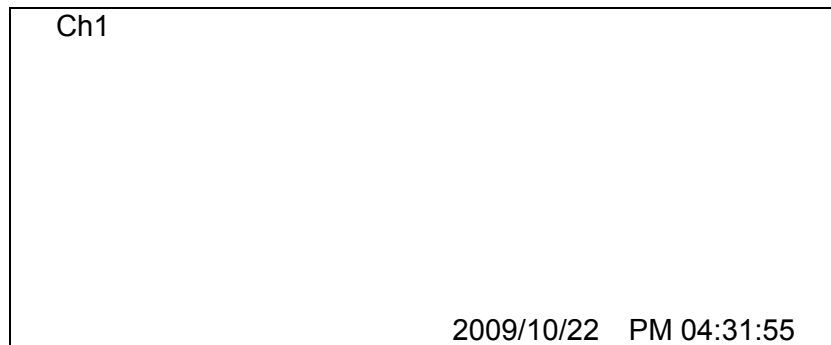

### 3.1 Front Panel Introduction

The functional keys on the unit's front panel enable users to control the unit and preset programmable settings.

#### 3.1.1 LED Definition

The LED indication lights of the **DVR-4TH/ 8TH/ 16TH** series unit on the front panel are described as follows.

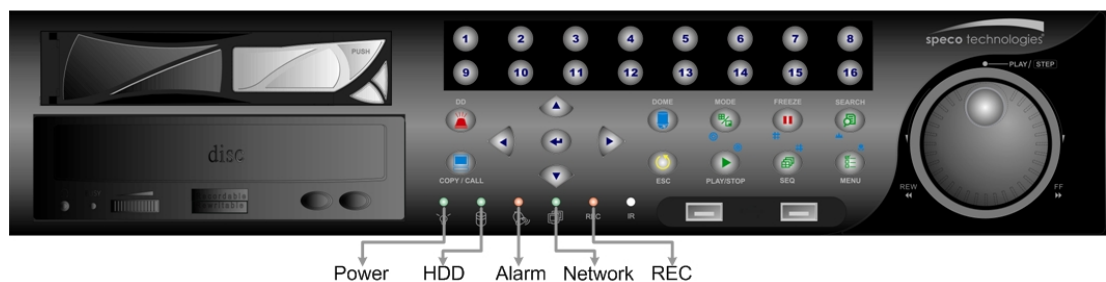

**Power LED**

The LED should be lit when the power is connected.

**HDD LED**

The LED will be lit while the HDD is processing data to or from the connected HDD(s).

**Alarm LED**

The LED should be lit when an alarm is triggered.

**Network LED**

The LED should be lit when the **DVR-4TH/ 8TH/ 16TH** series unit is connected to a network and it should blink when any data is being transferred.

**REC LED**

The LED should blink while the **DVR-4TH/ 8TH/ 16TH** series unit is recording.

### 3.1.2 Functional Keys

The **DVR-4TH/ 8TH/ 16TH** series unit's function keys on the front panel are described below for normal operation.

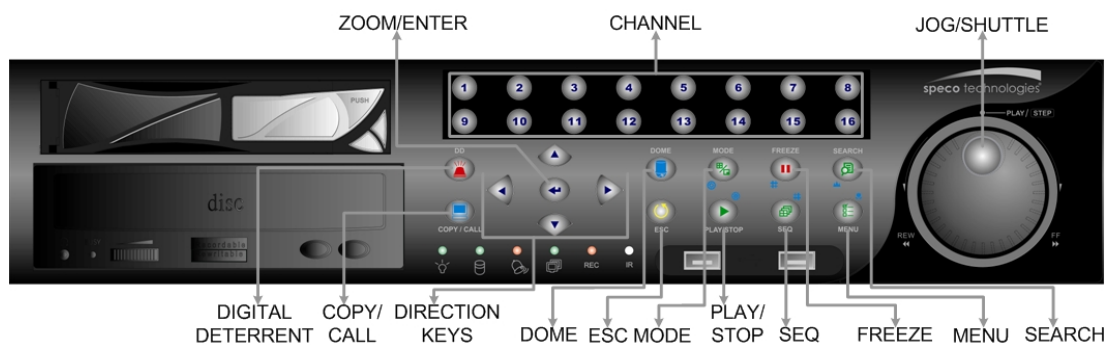
**CHANNEL**

- In both Live and Playback modes, press any CHANNEL key to view the corresponding video in full screen. The number of the CHANNEL keys corresponds to the number of cameras supported by the unit.
- In Dome Control mode, the key "1" is used to access the Set/ Go Preset menu while the key "2" is used to hide or display the dome camera setting parameters.
- In OSD virtual keyboard, press keys 1~9 to input number 1~9, and press key 10 to input number 0.

### **Digital Deterrent**

Users can trigger warning announcement at certain camera site by pressing the digital deterrent key and the specific camera key. Refer to section **Manual Digital Deterrent** for more detail about manually triggering the digital deterrent function.

### **COPY/ CALL**

- In Live mode, press this button to enter call monitor control mode.
- In Dome Control mode, press CALL in association with ENTER to enter the OSD setup menu of the dome camera.
- This is used to quick export video to an external device, such as USB DVD+RW, USB ThumbDrive®, etc. For more detailed operating instructions, refer to section **Quick Video Export through Front Panel**.
- In OSD virtual keyboard, press this key to input a period mark “.”.

### **Direction Keys**

- In Zoom mode, these keys function as normal Direction Keys.
- In the OSD setup menu, the Direction Keys are used to move the cursor to previous or next fields. To change the value in the selected field, press UP / DOWN keys.

### **ZOOM/ ENTER**

- In OSD setup menu or selection interface, press this key to make selection or to save settings.
- In live full screen viewing mode, press this key to view a 2× zoom image. Press it again to return.

### **ESC**

- Press to cancel or exit from certain mode or OSD setup menu without changing the settings made previously.
- If the password protection has been enabled, press ESC for five seconds to lock up the function of certain keys, including **PLAY**, **MENU**, **SEARCH**, and **DOM**E. Once users lock up the function of these keys, enter proper username and password to gain access of the functions of these keys.



**NOTE:** Please go to the <System Setup> → <User Management> menu to enable or disable the password protection.

## **DOME**

- Press this key to enter Dome Control mode. Please refer to section **Dome Control** for more details about dome camera controlling operation.
- In OSD virtual keyboard, press this key to go backspace.

## **MODE**

Press repeatedly to select desired main monitor display format. There are four viewing modes available: full screen, 4-window (2×2), 9-window (3×3), and 16-window (4×4). Refer to section **Viewing Modes** for more detailed information.

## **PLAY/ STOP**

Press this key to switch between live image and playback video.



**NOTE:** Video taken within the latest 5 ~ 10 minutes cannot be played back because the video is still saved in the buffer.

## **SEQ (Sequence)**

Press to start automatic sequencing of the video coming in from the installed cameras.

## **FREEZE**

- Press FREEZE while viewing live image, the live image will be frozen, but the date/ time information shown on the monitor will continue updating. The recording of the video will continue as well. Press FREEZE again to return to live mode.
- Press FREEZE while playing recorded video, the playback video will be paused. Press LEFT/ RIGHT to move the recorded video reverse/ forward by a single step. Press FREEZE again to continue playing video.

## **MENU**

Press this key to access the OSD setup menu.

## **SEARCH**

In both Playback and Live mode, press SEARCH to access the Search menu to search and playback recorded video by date/ time, events, or text.



### **JOG/ SHUTTLE**

- The jog/ shuttle knob is a dual function knob, including a shuttle ring and an embedded jog disk, that provides wide range in playback control. Note that the jog/ shuttle knob is active only when the unit is in Playback mode.
- When playing back videos, the shuttle ring can control playback speed in either forward or backward directions. Rotate the shuttle ring clockwise/ counterclockwise to fast forward/ reverse playing speed. According to the angle of rotation, the playing speed changes to 1×, 2×, 4×, 8×, 16×, or 32×, in both forward and reverse playback.
- When the video is paused, the embedded jog disk can control single-step playback. Clockwise rotation moves the video image one-step forward, whereas counterclockwise rotation moves the video image one-step backward. Note that single-step playback is for JPEG recoding only.

## **3.2 Entering OSD Setup Menu**

The configuration of the **DVR-4TH/ 8TH/ 16TH** series unit can be customized through the intuitive Graphical User Interface (GUI) OSD setup menu. Collaborating with a USB mouse, setting up the DVR can be easy as operating on a PC. Press MENU and select an account to login.

The next step is to enter a corresponding password. The preset password for the administrator account “admin” is “1234”.



**NOTE:** It is strongly suggested to change the preset password to prevent unauthorized access to the unit.

An icon displayed at the status bar will show the authority level of the account. Under logout condition, the icon will show “Guest”. When an account is logged in, its authority level number (1~8) will be shown.

Before completely logout, other functions can also be accessed without having to login again. There are two ways to logout: manually logout by pressing ESC key at Live mode, or auto logout when keys are not pressed for 5 minutes at Live/ Menu mode.

### 3.2.1 User Management

The **DVR-4TH/ 8TH/ 16TH** series unit provides the option to create up to seven sets of usernames and passwords with customized authority, excluding the preset “admin” account. From the Main Menu, select <System Setup> → <User Management> and the menu is as the following:

User Management	
Password Protection	ON
Account Setup	
Authority Setup	
Load Default Setting	No

#### **Password Protection**

Select <ON> to request for username and password for accessing functions listed in Authority Setup menu, or select <OFF> to allow free access.

#### **Account Setup**

Setup customized username, password, and authority level in this menu. The username is case sensitive. The authority level rank from level 1~8, and level 8 has highest authority. Alternatively, select <Disable> to stop using the account.



**NOTE:** The username and authority level of the preset “admin” account cannot be changed.

#### **Authority Setup**

Setup the allowed authority level for accessing the functions listed in this menu. The functions include: Playback/Search, Dome Control, Call Control, Export Data, Menu Access, System Setup, Monitor Setup, Camera Setup, Record Setup, Sequence Setup, Event Setup, Database Setup, Configuration, POS Setup, and Shutdown. The authority level rank from level 1~8, and level 8 has highest authority. Alternatively, select <Disable> to allow free access.



**NOTE:** The “Menu Access” cannot be set to <Disable>.

If the account does not have authority to access certain functions, an error message will be displayed on the screen.

#### **Load Default Setting**

Select <Yes> to load the default setting.

### 3.3 Configuring the HDD in the unit

There is an empty cartridge positioned on the front panel where users can install a swappable HDD. There are two possible situations after a HDD is installed into the unit.

- If a brand new HDD is installed, the unit will automatically format it and add it into the database.
- If a used HDD that has a different data format is installed, the screen will show “1 disk(s) with wrong data format! Please format then add to the database manually”. Please follow the steps described below:
  - Enter the OSD setup menu using account with appropriate privilege and access <Database Setup>.
  - Access <External Disks>.
  - Find the HDD that was just installed, and select <Format> to format it.
  - After the HDD is formatted, select <Add> to add it into the database.

**Some recommended HDDs are listed as below:**

<b>Seagate</b>	SV35.2	160G / 320G
	Barracuda ES.2	500G
	Barracuda 7200.11	1000G
<b>Hitachi</b>	DeskStar	320G
<b>Maxtor</b>	DiamondMax 22	500G
<b>Western Digital</b>	WD AV	160G / 320G / 500G

### 3.4 Power On/ Off the Unit

If the **DVR-4TH/ 8TH/ 16TH** series unit must be shutdown for any reason, always remember to follow proper shutdown and power on procedures in order to avoid damage to the unit.

#### **To Power On the Unit**

First check if the type of power source available is compatible before plugging into the unit. Then turn on the unit using the power switch on the rear panel.

The system checking information and color bar will be shown on the monitor. It will disappear when the unit has been properly powered on.

**To Restart/ Shutdown the Unit**

Press MENU and input the username and password that has sufficient authority to access the OSD setup menu. Select <Shutdown> in Main menu and press ENTER to enter the Shutdown menu, which displays as follows.

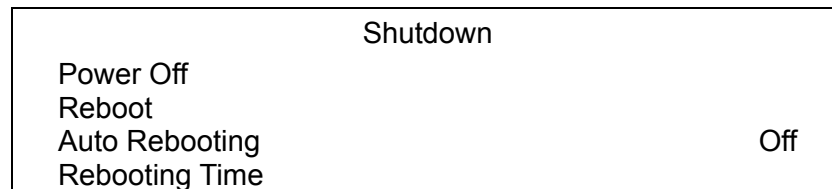
**<Power Off>**

Select this item to shutdown the unit. **DO NOT** disconnect the power during shutdown until the message “You can safely turn off DVR now!” displays.

**<Reboot>**

Select this item to restart the unit. The system checking information and color bar will be displayed on the monitor until the unit is properly restarted.



**NOTE:** While the **DVR-4TH/ 8TH/ 16TH** series unit is shutting down or rebooting, the recoding and playback of videos will stop to avoid abnormal images.

**<Auto Rebooting>**

The **DVR-4TH/ 8TH/ 16TH** series unit can be set to reboot automatically once a day/week at predetermined time in order to keep the DVR system more stable. Select <Off> to disable the auto rebooting function.

**<Rebooting Time>**

If the auto rebooting function is enabled, select a desired time to perform the auto rebooting function.

## 3.5 System Date/ Time Setting

The user can set the current date, time and other OSD parameters in the Date/ Time menu. The login account should have authority to access the System Setup menu. In the OSD Main menu, select <System Setup> and press ENTER, then select <Date/ Time> to access the Date/ Time menu; the menu displays as follows.

Date/Time	
Date	2009/02/21
Time	PM10:39:26
Time Zone	OFF
Date/Time Display	1 Row
Date Display Mode	Y/M/D
Time Display Mode	24 HR
Daylight Saving Time Setup	
Network Time Protocol Setup	

### 3.5.1 Set Date/ Time

#### Set Date/ Time

Select <Date>/ <Time> and press ENTER to adjust the settings. LEFT/ RIGHT keys are used to move the cursor to previous or next field, ENTER is for selecting, and UP/ DOWN are used to change the value in the selected field.



**NOTE:** The reset date/ time setting applies for recording new video, the date and time of previously recorded video will not be changed.



**NOTE:** To avoid record database corruption, after changing the date/ time setting, it is recommended to clear the database.

#### Date/ Time Display

Users are allowed to choose to set the date/ time OSD displays in 1 or 2 rows. Use the UP/ DOWN keys to change the setting. The default is to display the date/ time OSD in one row.

#### Date Display Mode

This function allows user to set the OSD display type of the date/ time. There are three options to select from: <Y/M/D>, <M/D/Y> or <D/M/Y>. “Y” represents “Year”, “M” represents “Month” and “D” represents “Day”.

Move to the desired item and press ENTER, the option starts blinking. Use UP / DOWN keys to change the setting. The default setting is <Y/M/D> in both NTSC/ PAL formats.

### **Time Display Mode**

The user can choose to set the time format to <12 hour> or <24 hour>. Use the UP/ DOWN keys to change the format. The default setting is <12 hour>.

## **3.5.2 Daylight Saving Time Setup**

The items in this sub-menu are for those people whom live in certain regions to observe Daylight Saving Time.

### **Daylight Saving Time**

Select <ON> to enable, or <OFF> to disable the function.

If the function is disabled, the DST Start/ End time and DST Bias will be grayed out and cannot be accessed.



**NOTE:** If this function is enabled, the date/ time information will be shown on the screen with a DST icon when playing back recorded video or searching video in the event list. “S” indicates summer time and “W” indicates wintertime.

### **DST Start/ End**

This is used to program the daylight saving duration. Use Direction keys to move the cursor to the next or previous field, use UP/ DOWN to change the settings in the selected field.

### **DST Bias**

<DST Bias> allows the user to set the amount of time to move forward from the standard time for daylight saving time. The available options are <30>, <60>, <90> and <120> minutes.

### 3.5.3 Network Time Protocol Setup

This section guides you to synchronize your unit to fit the local time.

Go the <System Setup> → <Date/ Time> → <Time Zone>. Refer to below figure and select your time zone from the options.

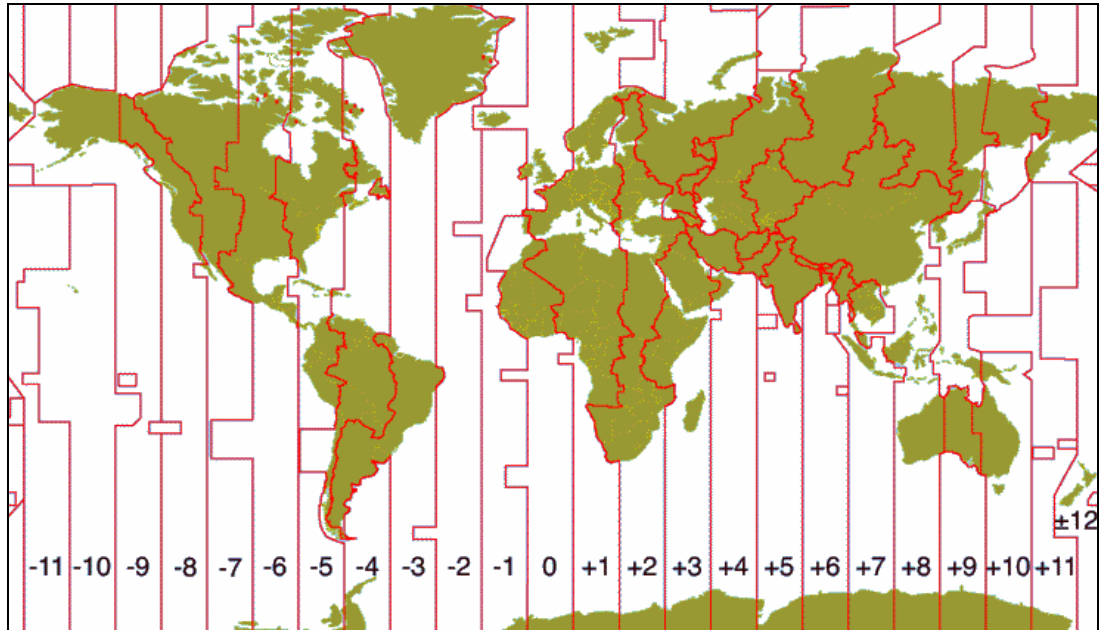

Then go to <System Setup> → <Date/ Time> → <Network Time Protocol Setup> and select <ON> for the item <Automatically Time Sync>. When this function is ON, time sync will be performed every hour in order to observe correct time of your local zone.



**NOTE:** If you want the unit to automatically synchronize the local time, the <Time Zone> item **MUST NOT** be set to <OFF>, or the function cannot be activated.

### 3.6 IP Camera Setting

The distinctive hybrid solution of the DVR enables users to connect IP camera(s) while others are analog cameras. First enter the OSD setup menu with a proper account and access <System Setup> → <IP Camera Support> to select the number of IP cameras to be connected. The supported channels of IP cameras will be from the largest numbers, for example CH16 for 16ch models.



**NOTE:** The DVR must be rebooted in order to apply the change of IP Camera Support option.

To configure setting of an IP camera, access <Camera Setup> and select the channel with the largest number. The menu will be shown as follows.

IP Camera	
IP Camera Select	CH16
IP Camera Title	CH16
Search Via UPnP	
Hostname/IP	X.X.X.X
Model	NH Series
Connection Setup	
Device Setup	
Activated	No
Status	
Copy Settings	



**NOTE:** If the IP camera is already activated, menu items 3 to 5 will be grayed out and cannot be accessed.

### 3.6.1 IP Camera Information

#### **IP Camera Title**

Access this item to enter the name of the IP camera to be shown on the monitor.

#### **Search Via UPnP**

If the IP camera is UPnP compatible and is in the local area network, select this item and press ENTER to automatically search for the IP camera attached to the DVR.

#### **Hostname/IP**

Access this item to enter the hostname or IP address of the IP camera, for example 192.168.1.123.

#### **Model**

Access this item to select the model of the connected IP camera.



## 3.6.2 Connection Setup

Enter <Connection Setup> to configure the connection and data transmission setting of the connected IP Camera. The menu will be shown as below.

Connection Setup	
Account	****
Password	****
Management Port	80
Streaming Format	MPEG4
Advance Streaming Option	OFF
Streaming Port	554
Streaming Protocol	RTP+RTSP
IP Dome Protocol	NONE

### **Account / Password**

Access these two items to enter a valid account name and password of the connected IP camera.

### **Management Port**

Access this item to enter the default port of the IP camera.

### **Streaming Format**

Access this item to select the streaming format, <MPEG4>, <MJPEG> or <H264>, of the IP camera.

### **Advance Streaming Option**

Select <OFF> and the Streaming Port and Streaming Protocol will be set automatically according to the camera model selected. Alternatively, select <ON> to manually set the Streaming Port and Streaming Protocol.

### **Streaming Port**

Access this item to enter the streaming port, for transmitting video and related commands, of the IP camera.

### **Streaming Protocol**

Access this item to select the streaming protocol of the IP camera. The option includes <RTP+RTSP>, <RTP/RTSP>, <RTP/RTSP/HTTP>, and <HTTP>.



**NOTE:** Please contact manufacturer of the IP camera for assistance if the IP camera's Management Port / Streaming Port / Streaming Format / Streaming Protocol are unknown.

### **IP Dome Protocol**

If the connected device is an IP Dome Camera, then select an appropriate IP Dome Protocol from the provided options.

## **3.6.3 Device Setup**

Enter <Device Setup> to configure the basic settings of the IP camera. The basic settings include the IP camera's product name, image quality, image adjustment, etc. Set the item <Apply> to <Yes> to apply the changes.



**NOTE:** The <Device Setup> menu may have fewer or more menu items according to different IP camera models.

## **3.6.4 Activated**

Access this item and select <Yes> to activate the connection to the IP camera. To deactivate the connection, select <No>.



**NOTE:** Once the connection to the IP camera is activated, menu items <Hostname/IP>, <Model>, and <Connection Setup> will be grayed out and cannot be accessed.

## **3.6.5 Status**

After the connection to the IP camera is activated, users can check the connection status. The menu will be shown as below.

	Status
Model	****
Streaming Format	MPEG4
Resolution	640x480
PPS	10
Bandwidth	20 KB/Sec
Pkg. lost rate	0.1%

The information shown on the monitor is “read only”.

## 3.7 Record Schedule/ Quality Setting

The Record Setup menu allows users to set recording quality, recording schedules, and other recording parameters. Login with a proper account to access Record Setup menu. In the Main menu, move the cursor to <Record Setup> and press ENTER; the following menu is displayed.

Record Setup	
Record Mode Setup	
Schedule Setup	
Preset Config	Best Quality
Per Camera Config	
ezRecord Setup	
Data Lifetime Setup	
Pre-Alarm Recording	15 Sec
Circular Recording	ON
Audio Recording	ON
Purge Data	

### 3.7.1 Record Mode Setup

The Record Mode Setup menu is for selecting resolution and recording format. The relative record settings, such as preset configuration, will follow the record mode setting. In normal circumstance, it is recommended to select half-D1 resolution and H.264 recording format.

Move the cursor to <Record Mode Setup> and press ENTER, then select desired record resolution and format.

### 3.7.2 Schedule Setup

This submenu is used to set the day and night time, or weekend recording schedule. The Night and Day schedules are used to define daytime and nighttime; the Weekend schedule is tailored for weekends and holidays. Select <Schedule Setup> from the Record Setup menu and press ENTER.

Schedule Setup	
Day Time Start	AM 06:00
Day Time End	PM 18:00
Night Time Start	PM 18:00
Night Time End	AM 06:00
Weekend Schedule	On
Weekend Start	Fri 18:00
Weekend End	Mon 06:00

- Make appropriate changes for the start time of the Day Time and Night Time schedule using the Direction keys.
- Press ENTER to confirm the settings or ESC to cancel.
- If you want to record over the weekend, choose <YES> to enable the Weekend Schedule in advance and then set the Weekend Start/ End time.
- Press ESC to back to previous page.

### **Day/ Night Time Start**

The Day/ Night Start Time determines the beginning of day/ night recording time. The time is indicated in 1-minute increments. The time display format in this menu is based on the setting of Time Display Mode.

### **Day/ Night Time End**

The Day/ Night End Time determines the end point of day/ night recording time. The time is indicated in 1-minute increments. The time display format in this menu is based on the setting of Time Display Mode.

### **Weekend Schedule**

The Weekend Schedule determines whether a weekend schedule is in effect. Choose <YES> to take effect the related weekend settings.

### **Weekend Start/ End**

The Weekend Start Time indicates the specific day and time that a weekend begins, for example, FRI 18:00. The Weekend End Time indicates the specific time and day that a weekend ends, for example, MON 06:00. Time is indicated in 1-minute increments.

Note that the value you have set indicates when the regular Day and Night scheduling ends, and when the Weekend recording begins.

## **3.7.3 Preset Record Configuration**

The <Preset Config> is used to preset recording quality and frame rate for normal video and event video. In normal circumstances, it is strongly suggested to set the item to <Best Quality>, the default. Please refer to appendix **Record Configuration** for tables showing the PPS and picture size under various setting. For further information about setting up the configuration, please refer to section **Preset Record Configuration**.

### 3.7.4 Per Camera Configuration

This function is used to set the Day/ Night/ Weekend PPS (Picture per Second) and Quality for each channel. The Preset Configuration must be set to <OFF> for accessing these schedules. The menu displays as follows: (Record Mode: 352×240@240PPS in NTSC/ 352×288@200PPS in PAL).

Per Camera Config			
Camera Select	Day	Night	CH1 Weekend
Normal PPS	7.5	7.5	7.5
Normal Qlty	Best	Best	Best
Event Max PPS	30	30	30
Event Qlty	Best	Best	Best
Event Act	Both	Both	Both

- First, select a Camera to set its record configuration. The image and record settings from the selected camera will be displayed on the screen.
- Move the cursor using the Direction keys and press ENTER to select an item.
- Change the value using UP/ DOWN keys.
- Press ENTER to confirm the settings or ESC to abort.
- Press ESC to return to Record Setup menu.

Please note that the total normal pps for all channels cannot exceed 240 NTSC (352×240@240PPS)/ 200 PAL (352×288@200PPS). To increase one channel's pps, you may have to reduce other's first. Event pps is not restricted to this rule, since a smart event schedule will correct the total pps automatically..

### 3.7.5 Record Event Video Only

If you want your DVR unit to start recording only under the alarm is triggered, follow the steps:

- Enter the OSD setup menu with a proper account.
- In the OSD setup menu, select <Record Setup> menu. Move the cursor to the item <Preset Config>, and select <Event only>.

Refer to section **Preset Record Configuration** for more detailed information.

## 4. Basic Operation

The **DVR-4TH/ 8TH/ 16TH** series unit allows the user to easily access some general operations through the front panel. The following sections introduce the general operation of the unit.

### 4.1 Viewing Live/ Playback Video

The general functions in live and playback mode are described in the sections that follow.

#### 4.1.1 Viewing Modes

The **DVR-4TH/ 8TH/ 16TH** series unit provides several ways of viewing both live and recorded video. The following descriptions explain the view formats that are available.

##### Viewing in Full Screen

Press any CHANNEL key directly to view the corresponding camera image in full screen format.

##### Viewing in Multi-Window

Various multi-window viewing formats are available for selection. To switch between these viewing formats, press MODE repeatedly.

The available viewing formats are illustrated in the following figure. Note that 3x3 viewing mode is only available in **DVR-8TH/16TH** models, whereas 4x4 viewing mode is only available in **DVR-16TH** models.

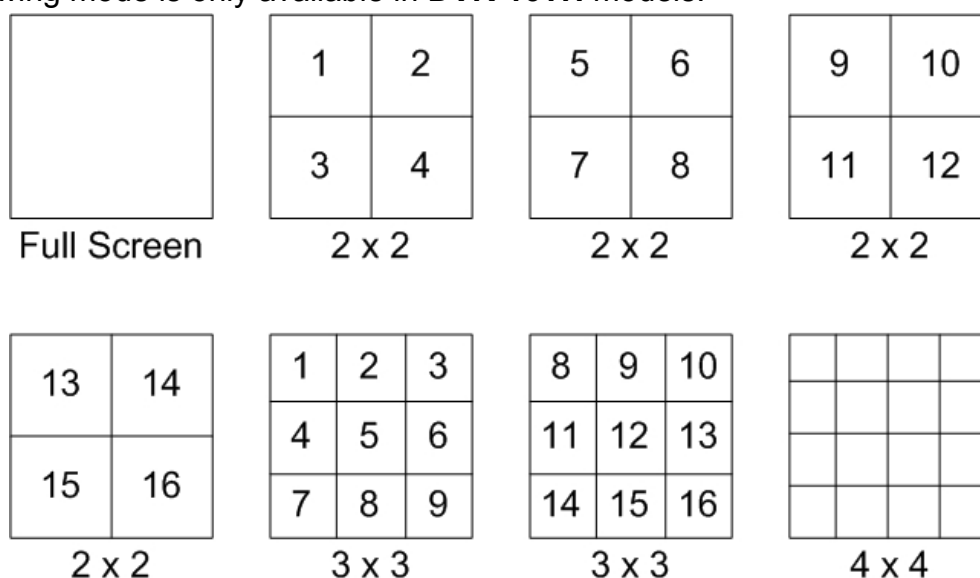

## 4.1.2 Digital Zoom

Users are able to view a 2× full screen in live and playback mode. To view the 2× full screen, follow these steps:

- Press the CHANNEL key to view the corresponding camera in full screen.
- Press ZOOM to enter a 2× full screen zoom mode of the selected camera.
- If you need to view a specific area of the 2× zoomed screen, use Direction keys to pan/ tilt the zoomed area around the original image.
- Either press ZOOM again or ESC to leave the zoom mode.

## 4.1.3 Viewing Live Cameras

Users are allowed to view live cameras in several viewing modes, including full-screen, 2×2, 3×3 and 4×4. General operation under live mode is described as follows.

### To Freeze Live Image

Press FREEZE while viewing a live image, the image then pauses, but the date/ time information does not, and the system clock continues running.

Press FREEZE to pause the live image; press FREEZE again to resume the live camera view.

## 4.1.4 Viewing Recorded Video

To view recorded video, the user can press the PLAY/ STOP key directly. When the PLAY/ STOP key is pressed, the unit starts to continue playing back the recorded video from the suspended point of record. If the PLAY/ STOP key is being used for the first time, the unit will playback from the very beginning of the record. Alternatively, a user can select records from the Search menu to play specific video. Refer to section **Searching Recorded Video** for more information.

The Forward or Backward playing speed indicator will be shown on the bottom-left of the screen in Playback mode.

General operation for Playback mode is described as follows.

### Key Usage in Playback

Key usage changes slightly in Playback mode as follows.

#### **<LEFT>** (Backward Playback)

This key is used to play recorded video fast backward. Press the key repeatedly to increase the speed of backward playback by 1×, 2×, 4×, 8×, 16×, or 32×.

#### **<RIGHT>** (Forward Playback)

This key is used to play recorded video fast forward. Press the key repeatedly to increase the speed of forward playback by 1×, 2×, 4×, 8×, 16×, or 32×.

#### **<FREEZE>**

Press FREEZE to pause the playback video. When the recorded video is paused, press LEFT/ RIGHT to move playback video a single step backward/ forward, respectively. Press FREEZE again to continue playing video.

#### **<PLAY/ STOP>**

Press to start playing back video, or to stop playing back video and return to live mode.

### Pause Playback and Single Step Forward/ Backward

To pause and move recorded video single step forward/ backward, follow these steps.

- Press one of the CHANNEL keys to display the corresponding camera in full screen.
- Press FREEZE to pause the current playback image.
- Press LEFT/ RIGHT keys to move the recorded video a single step backward/ forward. Press and hold LEFT/ RIGHT keys to move backward/ forward the video single steps continuously.
- Press FREEZE again to resume the playback operation.



**NOTE:** Single step backward is available in JPEG recording only.



## 4.2 Sequence Setup

This section introduces how to view in sequence mode with both Main Monitor and Call Monitor, if connected. Sequence function can avoid manually backtracking and give more flexibility in surveillance.

### 4.2.1 Sequence on Main Monitor

The automatic sequence function can be displayed in any viewing mode. Select certain viewing format and press SEQ to start the automatic sequence. Press ESC to stop and return to live mode. The figure below shows the example of displaying sequence in 4-channel viewing mode.

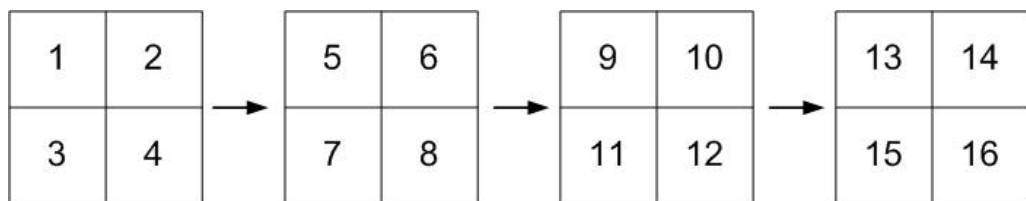

### 4.2.2 Call Monitor Control

Users can use front panel of the **DVR-4TH/ 8TH/ 16TH** series unit to control a call monitor display without having to access the Main menu. Two viewing modes can be displayed on call monitor: Sequence display and Single camera display. To program the call monitor sequence, refer to section **Sequence Setup**.

Follow the steps below to control the call monitor.

- Press the CALL key on the front panel to enter call monitor control mode, the message “Call Mode” will then be shown on the bottom-left of the screen.

Press 1-16 Key To Select Channel  
Press SEQ To Enable Sequence

- Press any CHANNEL key to display the image of the corresponding camera on the call monitor.
- Alternatively, press SEQ repeatedly to display the sequence of cameras previously programmed in Call Monitor Schedule menu.
- Press ESC to return the front panel to Main Monitor Control mode.

## 4.3 Searching Recorded Video

The **DVR-4TH/ 8TH/ 16TH** series unit is capable of searching and playing back recorded video by date/ time, events, or text. To search by time, select a specific date and time of the wanted video or enter Calendar Search. To search by event, select channels to display the event list.

In live or playback mode, press SEARCH to enter the Search menu, which is shown as follows.

Search	
-----Search By Time-----	
From:	1 Nov 2009 16:45:36
End:	11 Nov 2009 08:15:12
Select:	10 Nov 2009 04:19:03
Begin Playback	
Calendar Search	
Smart Search	
-----Search By Event-----	
Select Channel:	CH1 CH2 CH3 CH4 <input type="checkbox"/> All
Event List	<input type="checkbox"/> None
-----Search By Text-----	
Text Query Page	



**NOTE:** “Search By Text” only functions when a POS machine is connected and text data is stored.

### 4.3.1 Searching by Time

Follow the steps to search video by date and time.

- Press SEARCH to enter the Search menu.
- Move the cursor to “From” and press ENTER will start playing recorded video from the specified “From” time.
- Move the cursor to “End” and press ENTER will start playing recorded video from the specified “End” time.
- Move the cursor to “Select” and press LEFT/RIGHT keys to choose date/ time. Press ENTER and adjust the values by UP/DOWN keys.
- Press ENTER to confirm the settings or ESC to abort.
- Move the cursor to <Begin Playback> and press ENTER to start playing back the selected video.
- Press PLAY again to return to live video.



**NOTE:** If there is no available recorded video that matches the specified time and date, the unit starts playback from the next available video.



**NOTE:** The date/time information will be shown on the screen with a DST icon if the Daylight Saving Time function is enabled. "S" indicates summer time and "W" indicates winter time.

### 4.3.2 Calendar Search

Follow the steps below to search recorded video via Calendar Search.

- Press SEARCH button to enter the Search menu.
- Move the cursor to <Calendar Search> and press ENTER. A calendar will be shown as below.

Calendar Search

----- Date/Time -----

←		November 2009						→
	Sun	Mon	Tue	Wed	Thu	Fri	Sat	
44	25	26	27	28	29	30	31	
45	<b><u>1</u></b>	<b><u>2</u></b>	<b><u>3</u></b>	<b><u>4</u></b>	<b><u>5</u></b>	6	7	
46	8	9	10	11	12	13	14	
47	15	16	17	18	19	20	21	
48	22	23	24	25	26	27	28	
49	29	30	1	2	3	4	5	

----- Search By Time -----

From/End From End

Select 4 Nov 2009 06:19:45

Begin Playback

- Move the cursor to year/ month and press ENTER. Then press UP/DOWN keys to adjust the value and press ENTER again to confirm.
- Move the cursor and press ENTER to select any date shown in bold and underlined font. The bar below the calendar will change according to the recorded data of the selected date.
- Then select preferred time from the time bar. Alternatively, move the cursor to the time shown at the bottom. Press ENTER and adjust the values of hour/ minute/ second via UP/DOWN keys.
- The <From> and <End> buttons allows users to playback video from the beginning or end of the database.
- Note that the time blocks highlighted in red represent events occurred.
- Select <Begin Playback> and press ENTER to start playing back selected video.

### 4.3.3 Smart Search

Smart Search allows users to search for recorded videos according to specific date/time, channel, and monitoring area. Follow the steps below to search recorded video via Smart Search.

- Press SEARCH button to enter the Search menu.
- Move the cursor to <Smart Search> and press ENTER. The Smart Search menu will be displayed as below.

Smart Search	
From:	2009/01/01 AM00:00:00
End:	2009/05/01 AM00:00:00
Select Channel	CH1
Select Search Area	
Search Sensitivity	77%
Search Threshold	50%
Interval	60 Sec
Smart Search List	

- Specify the From/End time to search for recorded video within the period.
- Choose a channel for smart search.
- Setup the monitoring area following the special operation described in appendix **USB Mouse Operation**.
- Specify detection sensitivity and threshold according to environment and required application.
- The time interval specified here will be time segment of smart search. That means, if the total time period is 10 minutes, and the time interval is 60 seconds, then there will be 10 time segments. Therefore, if video satisfied the smart search criteria is found in the 4th segment, only the 4th segment video will be reported on the Smart Search List.
- When the criteria are all set, select <Smart Search List> and press ENTER to start the smart search.

When the Smart Search List is displayed, use Direction keys to scan through the list. Press ENTER to playback any desired item, or press ESC to exit the list.

### 4.3.4 Searching by Event

“Event List” will be displayed, as shown below, when users searched recorded video by event. Users can scroll down the Event List to look for interested event video.

Event List			
Date	Time	Ch.	Type
2009/03/17	11:26:50	2	Motion
2009/03/17	09:53:03	5	Alarm
2009/03/16	16:14:42	3	Alarm
2009/03/15	03:45:31	1	Motion
2009/03/12	22:27:56	1	Alarm
2009/03/12	10:09:29	7	Motion
2009/03/11	12:18:20	6	Motion
2009/03/10	05:16:00	4	Alarm
2009/03/08	17:11:37	2	Motion
2009/03/08	16:29:10	8	Motion
2009/03/08	03:22:17	2	Alarm

The list displays the first 9999 events by date, time, triggered camera, and alarm type. As some events are deleted, event items beyond 9999 will be displayed. The latest recorded event video will be listed on the top.

Follow these steps to search event video through the Event List:

- Press SEARCH to enter the Search menu.
- To search event video recorded on a specific channel, press LEFT/ RIGHT to move the cursor and press ENTER to select or de-select a channel.
- Move the cursor to <Event List> and press ENTER to list the event video from the selected channels.
- To exit the event list, press ESC.

Follow these steps to playback selected event video from the Event List.

- Press and hold UP/ DOWN to scroll through the Event List.
- Press ENTER to playback the selected event video.
- Press PLAY/ STOP to return to live mode.

### 4.3.5 Search by Text

When a POS device is connected to the DVR, users can search for videos with text data. The “Text Query Page” is displayed as below:

Text Query Page		
By Text		OFF
Item		
Item		
By Numerals		OFF
Value		
Value (Upper Limit)		
By Date/Time		OFF
From:	2009/01/01 AM00:00:00	
To:	2009/05/01 AM00:00:00	
By Channel		OFF
Text Query List		

There are three ways to search: by text, by numerals, or by text and numerals. In the mean time, date/time and/or channel can be specified to narrow down range, thus the search will be faster. Refer to below for search options.

#### **By Text:**

- **Exception:** Search for video with data containing the exception string set in the OSD setup menu.
- **OR:** Enter two sets of word strings. Search for videos with data containing EITHER ONE of the word strings.
- **AND:** Enter two sets of word strings. Search for videos with data containing BOTH of the word strings.
- **Specific:** Specify one set of word string. Search for videos with data containing the specific word string.

#### **By Numerals:**

- **Outside The Range:** Enter two numbers to specify a range. Search for videos with data containing number(s) out of the range.
- **Inside The Range:** Enter two numbers to specify a range. Search for videos with data containing number(s) within the range.
- **Less Equal Than:** Enter one number. Search for videos with data containing number(s) less than or equal to the specific number.
- **Greater Equal Than:** Enter one number. Search for videos with data containing number(s) greater than or equal to the specific number.
- **Specific:** Specify a number. Search for videos with data containing the specific number.

## 4.4 Video Export

The following sections are instructions for video export via OSD setup menu and via hot keys on the front panel.



**NOTE:** The **Central Management System (CMS)** software can also remotely execute video export function. Please refer to the CMS user's manual for more details.

### 4.4.1 Export from OSD Setup Menu

The Video Export menu enables only the accounts with proper authority to export recorded video with digital signature to a USB ThumbDrive® or a DVD+RW drive. Login with a proper account to export video.

The exported video will be identified by the exporting date/ time, and classified by event type. The exportation of each recorded video consist of four files if digital signature is necessary, including \*.gpg, \*.drv, \*.sig and readme.txt.

If an external storage device will be the destination of the exporting video, make sure it is available and connected to the appropriate port.

From the Main menu, select <Video Export> and press ENTER. The menu is displayed below.

Video Export				
Select Device				
Select Ch:	CH1	CH2	CH3	CH4
From:	2009/03/19	AM07:50:05		
To:	2009/03/28	PM03:09:18		
Select Events				
Data Type				Normal
Export Format				DRV
Digital Signature				No
Erase Disc				No
Begin Export				No

#### 4.4.1.1 Select the External Device

The available external devices for exporting video will be listed by name and free size in Select Device menu. The Select Device menu displays as follows.

Select Device		
Device Name	Available	Sel
XXX-XXX-X-X-XX	256 MB	No
XX-XXX-XX-XXXX	1.5 GB	No

The **DVR-4TH/ 8TH/ 16TH** series unit only supports EXT3 file system. If an external HDD will be connected to the unit, ensure the format of the HDD is EXT3. If not, please format this HDD to EXT3 first.

##### Device Name

The item shows the name of the available device.

##### Available

The item shows the free space of the available device.

##### Select

Set to <Yes> to select it as the exporting destination, or <No> to deselect.

#### 4.4.1.2 Select Video for Exporting

Select video from desired channel(s) with specific date / time and/or event(s), and set the item <Begin Export> to <Yes> to start exporting. Following are the items for selecting video.

##### Select Channel

Select the channel to export. Move the cursor to the desired channel using LEFT / RIGHT keys, select or de-select a channel by pressing ENTER.

##### From / To Time

The items are used to set the time which data export begins and ends. Move the cursor using LEFT / RIGHT keys, and press ENTER to select the date/ time items; adjust the selected date and time value by UP / DOWN keys.



**NOTE:** The exported data between the Start Time and End Time includes both normal and event video.



### **Select Events**

Select this item to display the event list. Move the cursor to scroll through the event list and press ENTER to select event(s) to be exported.

### **Data Type**

The item is used to select exporting video type. The options are <Normal> (export normal video only), <Event> (export event video only) and <Both> (export both normal and event video).



**NOTE:** To export event video only, set the “From” and “To” items at the same date and time. Otherwise, not only the event video but also the normal video included between the “From” date/ time and “To” date/ time will be exported.

### **Export Format**

This item is for selecting exporting video format. The options are <DRV>, <AVI>, and <Original>.

The \*.drv file can only be played back with **SpecoRemote™** and **SpecoPlayer™**, and multiple camera video can be played from one file. The \*.avi file can be played back with media players. Note that if multiple channels are exported, each channel is exported to a separate file.

#### **4.4.1.3 Digital Signature**

The user can export a video clip with or without a digital signature. Set the item to <YES> to export with the signature file, or <NO> to export without the signature file.

Each recorded video with a digital signature will be exported automatically into four files, including \*.gpg, \*.drv, \*.sig and readme.txt. The \*.gpg file name is the same as the last eight digits of MAC (Media Access Control) address of the unit.

Make sure that an external storage device, such as a USB Hard Drive or USB ThumbDrive®, is available and connected to the appropriate port for export.

For more information about verifying a digital signature, see appendix **Verifying Digital Signature**.

#### 4.4.1.4 Erase Disc

This function is used to remove information found on a DVD+RW disk prior to exporting new information to the drive. Select <Yes> and press ENTER to start deleting data.

### 4.4.2 Quick Video Export through Front Panel

The unit provides an easy and quick way, called ezBurn, to export video files to the built-in DVD+RW or an external device, such as a USB ThumbDrive®. The video exported via ezBurn is saved as \*.drv file.

If an external device will be the destination of the video, make sure it has been connected to the unit and the port has been set appropriately.

**NOTE:** Once an external device has been connected to the unit, the device has priority over the built-in DVD+RW. That means the video will be exported to the external device instead of the built-in DVD+RW.

Exporting process may take about 10 minutes to 1 hour depending on the file size of the video.

#### 4.4.2.1 ezBurn Introduction

The ezBurn function provides users a convenient way to export video with built-in DVD-RW or to external storage devices, such as USB ThumbDrive®.

TWO keys (SEARCH and COPY) and THREE touches are all that will be needed to complete the export. The whole exporting process is done through the front panel operation, but no need to access the OSD setup menu.



The ezBurn export process is illustrated as the following:

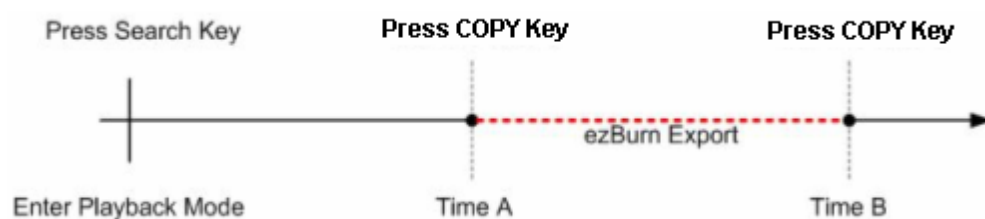

The process is described step by step in the following sections.

### 4.4.2.2 Export Normal Video

To export normal video to an external device, follow these steps:

- Press SEARCH and play desired normal video by entering date and time.
- When the playback starts, press COPY once to mark the starting point of the export video. The playback continues.
- Press COPY again to mark the ending point of the export video. Then the “ezBurn” window will be displayed as shown below. The information shown on the window is “read only”.

```

ezBurn confirmation
Selected Device: Built-in-DVD+RW
All data on the disc will be erased.
Exported Required Size = 11 MB
Real Export Range:
From: 2009/11/07 AM10:41:13
To: 2009/11/07 AM10:41:21
Enter: YES ESC: NO
or
Press CH N to assign
Digital Deterrent File Sound_N

```



**NOTE:** For more information about setting of Digital Deterrent function, please refer to section **Digital Deterrent**.

- Press ENTER to start the export, or press ESC to abort.
- If there is no exportable external device connected to the unit, then a warning message will be displayed on the screen, as shown below:

```

No exportable device detected.
Please install the target device/mediato the DVR.
Enter: Retry ESC: Exit
or
Press CH N to assign
Digital Deterrent File Sound_N

```

### 4.4.2.3 Export Event Video

To export event video, follow these steps:

- Press SEARCH and playback desired event video. For details on how to playback event video, refer to section **Searching by Event**.
- When the playback starts, press COPY. The “ezBurn” window will be displayed as follows. The information shown on the window is “read only”.

```

ezBurn confirmation
Selected Device: Built-in-DVD+RW
All data on the disc will be erased.
Exported Required Size = 11 MB
Export Event Info:
  Data      Time      Ch      Type
2009/11/07 AM10:42:35 13      Motion
Enter: YES  ESC: NO

```

- Press ENTER to start the export, or press ESC to abort.
- If there is no exportable external device connected to the unit, then a warning message will be displayed as shown in the previous section.



**NOTE:** The DVD will be ejected when its capacity is 99% full.

## 4.5 Deleting Recorded Video

The account with appropriate privilege can delete recorded video in the Purge Data menu. Select <Record Setup> from Main menu and press ENTER, then move the cursor to <Purge Data> and press ENTER. The Purge Data menu will be displayed.

```

Purge Data
Purge All Data          No
Purge All Event Data   No
Purge Event Before     2009/01/01
Start to Purge         No

```

The first three items are used to select the data to be purged. After the data is selected for deletion, set the fourth item <Start to Purge> to <Yes> and press ENTER to start the deleting process. The menu items are described below.

### **Purge All Data**

Select this item to delete all normal and event videos from the database.

### **Purge All Event Data**

Select this item to delete all event videos from the database.

### **Purge Event Before**

This item is for deleting event videos that are recorded before a specific date.

## 4.6 Dome Control

The **DVR-4TH/ 8TH/ 16TH** series unit allows the user to control a dome camera via the front panel.

In Live mode, users can press a CHANNEL key to display the corresponding dome camera in full screen. To enter Dome Control mode, press the DOME key and the hint screen will be displayed. Press ESC or DOME to exit Dome Control mode and return to live mode. To configure settings regarding dome camera control, see the following sections.

### 4.6.1 Dome Connection

Follow the steps below to install a dome camera.

- Refer to appendix **Alarm I/O Pin Definition** for RS-485 port pin definition.
- Using a RS-485 cable, connect the R+, R- terminals from the dome camera to the D+, D- terminals on the RS-485 port respectively. Refer to the following illustration.

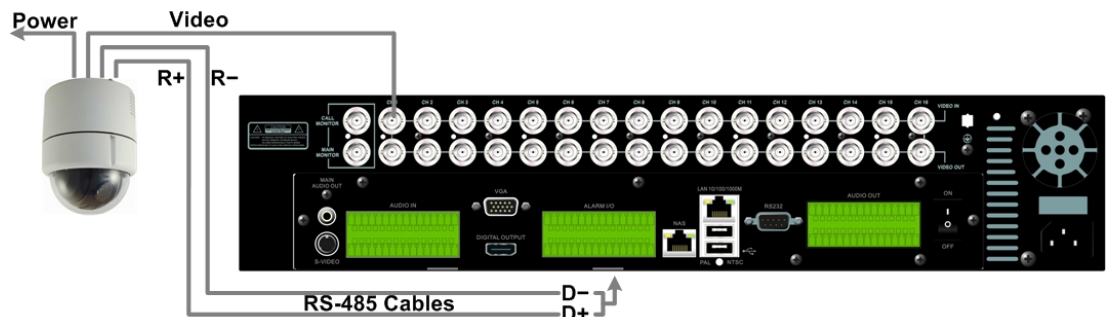

### 4.6.2 Dome Protocol Setup

The Dome Protocol item lists the dome protocols available for communicating with dome cameras connected to the **DVR-4TH/ 8TH/ 16TH** series unit. From the Main menu, select <Camera Setup> and press ENTER. The following menu is displayed.

Analog Camera	
Analog Camera Select	CH01
Dome Protocol	None
Dome ID	0
Camera Title	Ch1
Covert/ Privacy Mask	
Termination	On
Brightness	0
Contrast	0
Saturation	0
Hue	0
Audio Association	Yes
Copy Settings	

To configure dome protocol, first select a camera then set the communication protocol associated with that dome camera using the direction keys and press ENTER.



**NOTE:** The settings only become effective after saving the changes and exiting from the menu.

### 4.6.3 RS485 Setup

The **DVR-4TH/ 8TH/ 16TH** series unit controls the dome cameras via RS-485 communication protocol. The RS-485 parameters for the **DVR-4TH/ 8TH/ 16TH** series unit must be set to the same parameters set in the dome camera.

Users are allowed to change the RS-485 settings for the **DVR-4TH/ 8TH/ 16TH** series unit. Select <System Setup> in the Main menu, then select <RS485 Setup> from the System Setup menu and press ENTER. The following menu is displayed.

RS485 Setup	
Unit ID	224
Baud Rate	9600
Bits	8
Stop	1
Parity	None

The Unit ID number must match the ID address of the dome camera. The range of the Unit ID is from 1 to 255 while the default is 224. Note that no two devices on the same bus should be given the same ID address, or a conflict may occur.

The default RS-485 settings of the **DVR-4TH/ 8TH/ 16TH** series unit are 9600 Baud, 8 Data Bits, 1 Stop Bit, and No Parity.

 **NOTE:** The settings only become effective after saving the changes and exiting from the menu.

## 4.6.4 Dome Controlling Key

The function keys used for Dome Control are illustrated below.

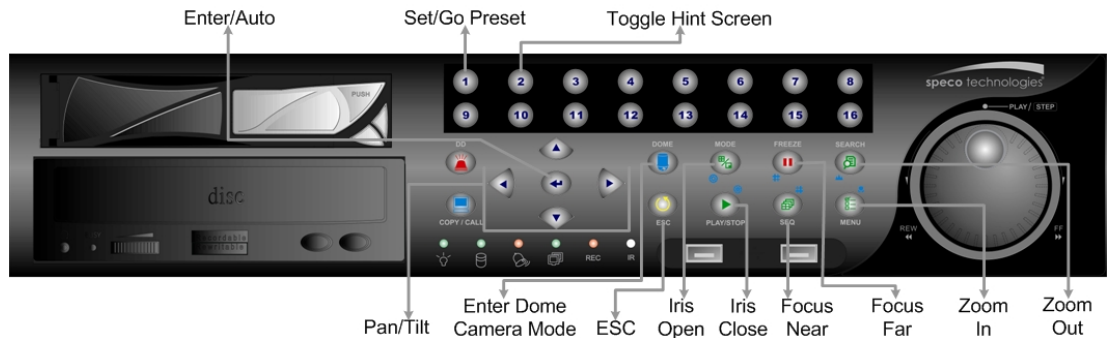

### Enter / Auto

- In OSD setup menu, press this key to make selection.
- In dome control mode, press this key to activate automatic adjustment of focus and iris.

### Set / Go Preset

This key is used to enter the Dome Preset menu to enable the set up of a specific position as a preset and to go to the predetermined preset positions.

### Toggle Hint Screen

This function is used to avoid showing the dome parameter information while controlling the dome camera. Press this key to hide the information. Press the key again to recover it.

### Pan / Tilt

- In OSD setup menu, these keys function as direction keys.
- In dome control mode, press these keys to pan and tilt the lens of dome camera.

### ESC

Press this key to leave dome control mode and return to live mode.

**Iris Open**

Press this key to open the Iris and let in more light to the dome camera.

**Iris Close**

Press this key to close the Iris and let in less light to the dome camera.

**Focus Near**

Press this key to focus the lens of the dome camera at a near position.

**Focus Far**

Press this key to focus the lens of the dome camera at a far position.

**Zoom In**

Press this key to zoom in the lens of the dome camera. This enables the user to enlarge the designated viewing area.

**Zoom Out**

Press this key to zoom out the lens of the dome camera. This allows the user to get a wider range of viewing area.

## 4.6.5 Setting Preset Points

The **DVR-4TH/ 8TH/ 16TH** series unit allows users to set preset positions. The maximum amount of preset points allowed depends on the brand and model of the dome camera. Follow steps below to set preset points.

- Press a Channel key to view the corresponding camera in full screen.
- Then press DOME to enter dome control mode. Then a Hint Screen, shown as below figure, will display on the screen.
- Press 2 to hide the dome control Hint Screen; press 2 again to toggle the Hint Screen.
- Use Direction keys to position the dome camera to desired position.

Hint Screen
DOME / ESC: Exit
MODE / PLAY: Iris Open / Close
SEQ / FREEZE: Focus Near / Far
MENU / SEARCH: Zoom In / Out
ENTER: Auto Focus / Iris
←↑↓→: Pan / Tilt
CH1: Set / Go Preset
CH2: Hint Screen On / Off
CH3 / CH4: Move Speed 000%



- Press 1 to access the Set/Go Preset function. A virtual keyboard will be displayed as below.

[Empty Input Field]			
1	2	3	BS
4	5	6	Set Preset
7	8	9	Go Preset
	0	Clear	Exit

- Input a desired preset number.
- Click on the <Set Preset> button to save the position. Now the preset position is set and ready to be called.

### 4.6.6 Calling Preset Points

Follow these steps to call preset points.

- Press a Channel key to view the corresponding camera in full screen.
- Then press DOME to enter dome control mode. Then a Hint Screen, shown as blow figure, will display on the screen.
- Press 2 to hide the dome control Hint Screen; press 2 again to toggle the Hint Screen.
- Press 1 to access the Set/Go Preset function.

[Empty Input Field]			
1	2	3	BS
4	5	6	Set Preset
7	8	9	Go Preset
	0	Clear	Exit

- Input a desired preset number.
- Click on the <Go Preset> button to call the preset point.
- Now the selected dome camera will rotate to the preset position automatically.

## 4.7 Manual Digital Deterrent

Besides presetting the digital deterrent function in OSD setup menu, users can also manually trigger digital deterrent function via front panel control. To do so, press the Digital Deterrent (D.D.) key and the menu will be displayed:

Manual Digital Deterrent  
 PRESS THE DESIRED CHANNEL TO  
 TRIGGER DIGITAL DETERRENT.  
 ← DD Source: Follow Event Setup →  
 ENTER: SEND TO ALL CHANNEL  
 ESC: Exit

Use LEFT/RIGHT keys to select source files from <Follow Event Setup>, <Default Sound>, or <Sound\_N>, where N can be chosen from 1 to 50. Press any channel key to manually trigger digital deterrent at that specific channel site. Alternatively, press ENTER to trigger digital deterrent at ALL channel sites.

## 4.8 2-Way Audio Talk Function

2-way audio talk function enables the DVR site to communicate with the camera site. To initiate communication, press and hold any channel key for 2 seconds. When the communication starts, below message will be shown on the screen:

2-WAY AUDIO  
 YOU ARE NOW COMMUNICATING WITH CHANNEL  
 02

At this time, users will be able to hear audio from the camera site, even if the audio output setting is disabled in the OSD setup menu. To start speaking to the camera site, press and hold the D.D. key. Once the D.D. key is released, the audio from the camera site will be heard again.

To terminate 2-way audio talk, press the same channel key or press ESC.



**NOTE:** 2-way audio talk function is not available for channel 1.

## 4.9 UPnP Function

UPnP is the abbreviation for Universal Plug and Play, which is a relatively new technology that integrates a universal protocol for widespread plug-and-play devices to ease the network implementation. When a PC and a DVR both installed the UPnP function, the PC can automatically recognize the DVR in the same local area network.

The advantage of this function is that PCs can connect to the DVR via the remote control software by directly clicking on the icon representing the DVR in **<My Network Places>** folder.

### 4.9.1 Setting Up the DVR and the PC

#### Enable the UPnP function in the DVR:

Enter the OSD menu with a proper account and access **<System Setup>** → **<Network Setup>** → **<UPnP Setup>**. The menu is as the following:

UPnP Setup	
UPnP	ON
UPnP NAT Traversal	No

Set the first item UPnP to **<ON>** and the DVR is ready.

#### Install the UPnP interface components in a PC:

- Click **<Start>** → **<Control Panel>** → **<Add or Remove Programs>**.
- Then click **<Add/Remove Windows Components>** on the left.
- In Windows Components Wizard, double click on **<Networking Services>**, then check the box in front of **<Universal Plug and Play>**.
- Click **<OK>**, then **<Next>** and the installation process will begin.
- When the installation is completed, the icon representing the DVR can be found in **<My Network Places>** folder.
- Double click on the icon will open an internet browser that connects to the DVR via the remote control software.

### 4.9.2 UPnP NAT Traversal Function

The UPnP NAT traversal function will help to automatically setup a router if the DVR connects to the internet via a router.

When a PC connects to a DVR not in the same local area network, a real IP address and corresponding port number is required. However if the DVR is behind a router, the communication between the PC and the DVR will be transmitted back and forth by the router. The router will need to setup port mapping (forwarding) before images from the DVR can be remotely viewed on the PC. For each individual DVR, the setting needs to be done individually. Imagine if there is tens or hundreds of DVRs. The setting will take a long time.

Fortunately, if the DVR has UPnP NAT traversal function, the setting of the router will be done automatically when it is enabled. Just select <Yes> for the menu item UPnP NAT Traversal in the UPnP setup menu and it will take care of everything.

## 4.10 Boot Log Exportation

The **DVR-4TH/ 8TH/ 16TH** series unit will keep records of important system logs. Users can also choose whether or not to keep records of operation logs. Login using an account with proper authority and enter the OSD menu. Then access the Configuration menu, as displayed below.

Configuration	
Load Factory Default	No
Import Config	
Export Config	
Import Deterrent	
Export Deterrent	
Boot Log	
Operation Log	On

Set <Operation Log> to <On> and operation logs will start to be recorded in the system log. Alternatively, set to <Off> and operation logs will not be part of the system log.

Select <Boot Log> and a list of system logs will be displayed on the screen. Users can export the system log as a data file to an external storage device. Connect a USB storage device and press COPY to export the system log file to the USB storage device. In the mean time, a digital signature file will also be exported.

## 5. Advanced System Configuration

The detailed functions and settings of the **DVR-4TH/ 8TH/ 16TH** series unit can be set through the intuitive Graphical User Interface (GUI) OSD setup menu. Collaborating with a USB mouse, setting up the DVR can be easy as operating on a PC. This chapter describes the menu items and options in the OSD setup menu.

### Account and Password

Press MENU and select an account to login. There are two preset accounts: "admin" and "user". The next step is to enter a corresponding password. The preset password for the administrator account "admin" is "1234", while the preset password for the account "user" is "4321".



**NOTE:** It is strongly suggested to change the preset password to prevent unauthorized access to the unit.

An icon displayed at the status bar will show the authority level of the account. Under logout condition, the icon will show "Guest". When an account is logged in, its authority level number (1~8) will be shown.

Before completely logout, other functions can also be accessed without having to login again. There are two ways to logout: manually logout by pressing ESC key at Live mode, or auto logout when keys are not pressed for 5 minutes at Live/ Menu mode.

### Key Usage in OSD setup menu

#### **<Direction Keys>**

In the OSD setup menu, Direction keys are used to move the cursor to select menu items. UP / DOWN are used to change the value in the selected field.

#### **<ENTER>**

In OSD setup menu or selection interface, press this key to select or save settings.

#### **<ESC>**

Press to cancel or exit from certain OSD setup menu without saving any changes.

### Key Usage in Virtual Keyboard

A virtual keyboard shows in some setting items, such as camera title, e-mail address, etc. The virtual keyboard displays as follows.

!	@	#	*	-	_	+	=	,	.	/	Back	
1	2	3	4	5	6	7	8	9	0	Del		
A	B	C	D	E	F	G	H	I	J	K	L	M
N	O	P	Q	R	S	T	U	V	W	X	Y	Z
a	b	c	d	e	f	g	h	i	j	k	l	m
n	o	p	q	r	s	t	u	v	w	x	y	z
<<		>>			Space			Cancel		OK		

#### <To input characters>

Move the cursor by pressing Direction keys and press ENTER to select characters. Alternatively, press channel keys 1~9 to directly enter number 1~9, press channel key 10 to directly enter number 0, or press "CALL" key to directly enter a period mark ".". The hot keys are for speeding up inputs of IP addresses or etc.

#### <To move the cursor in title entry>

Select "<<" / ">>" and press ENTER, or press MODE and "<<" / ">>" simultaneously to move the cursor to left / right in the title entry field.

#### <To delete previous character>

Select "Back" and press ENTER, or press DOME.

#### <To delete current character>

Select "Delete" and press ENTER.

#### <To exit the virtual keyboard>

Select "OK" and press ENTER to save the settings and exit, or press ESC to exit without saving changes.



**NOTE:** If a USB keyboard is connected and when any key on the keyboard is pressed, the cursor on the virtual keyboard will be automatically moved to "OK".

## 5.1 System Setup

Select <System Setup> from the Main Menu and press ENTER to enter the System Setup menu.

System Setup	
System/Version Info	
Language	English
Date/Time	
Unit Name	DVR
Show Camera Title	Yes
User Management	
Network Setup	
RS485 Setup	
Audio Output/Key Beep	
User Graphic Interface	Graphic
IP Camera Support	0

The items found in the System Setup menu are described in the following sections.

### 5.1.1 System/Version Info

The System/Version Info menu allows the user to view system information such as hardware and software versions. From the System Setup menu, select <System/Version Info> and press ENTER. The following menu is displayed.

System/Version Info	
Model Name	xxxxxxx
Video System	NTSC
Hardware	xx-xx-xx
Software	xxxx-xxxx-xxxx-xxxx
DSP	xxxx-xxxx-xxxx-xxxx
Mac Address1	xx-xx-xx-xx-xx-xx
Mac Address2	xx-xx-xx-xx-xx-xx
Software Upgrade via Local Device	
Software Upgrade via Internet	

The items in this menu are described in the following subsections.

#### 5.1.1.1 DVR System Information & Version Numbers

The first seven items listed DVR system information and version numbers of hardware and software. These information is “read only”.

### 5.1.1.2 Software Upgrade via Local Device

This item is used for updating the **DVR-4TH/ 8TH/ 16TH** series unit software by local device. The menu is displayed as follows.

Software Upgrade via Local Device	
Upgrade Version	Select
XXXX-XXXX-XXXX-XXXX	No

Connect a USB drive that contains the upgrade software to the unit; the upgrade files that are available will then be listed in the menu. To update the system, select a file and use UP / DOWN keys to choose <Yes>. Press ENTER to confirm the selection and start the upgrade process. The **DVR-4TH/ 8TH/ 16TH** series unit uploads the software, updates the system files, and reboots automatically.

The upgrade process may take several minutes to complete. After rebooting the unit, please check the software version again.



**NOTE:** If you want to upgrade your unit with a USB ThumbDrive® contains the newest software, make sure the software you want to use to update the unit should be fold into a folder named “upd\_200s”, otherwise, the unit cannot recognize it.



**NOTE:** Power interruption cannot occur during the software upgrade process. Ensure that no power interruption can happen until the unit is completely rebooted.



**NOTE:** Do not remove the external USB ThumbDrive®/DVD+RW before the unit has completely shut down (hard drive and fan are off). Removing the external USB ThumbDrive®/DVD+RW before shut down can cause the system to update improperly.

### 5.1.1.3 Software Upgrade via Internet

This item is used to upgrade the unit's software via the internet. Select one of the listed software versions and choose <Yes>. The **DVR-4TH/ 8TH/ 16TH** series unit uploads the software, updates the system files and reboots automatically.



## 5.1.2 Language

The Language item allows the user to select the language for the OSD menu and screen messages. Language selection takes effect immediately when the selection is done. Press UP / DOWN to select from languages listed and press ENTER to confirm.

## 5.1.3 Date / Time

The user can set the current date, time and other OSD parameters in this menu. The login account should have authority to access the System Setup menu. In the System Setup menu, select <Date/Time> and press ENTER; the Date/Time menu displays as follows.

Date/Time	
Date	2008/02/21
Time	10:39:26
Time Zone	Off
Date/Time Display	1 Row
Date Display Mode	Y/M/D
Time Display Mode	24 HR
Daylight Saving Time Setup	
Network Time Protocol Setup	



**NOTE:** The reset date/ time setting applies only to future recorded video, the date and time of previously recorded video will not be changed.



**NOTE:** After the Date/Time setting is changed, clearing the database is recommended for avoiding record database corruption.

### 5.1.3.1 Date / Time

Select <Date> or <Time> and press ENTER to adjust the settings. LEFT / RIGHT keys are used to move the cursor to previous or next field, ENTER is for selecting, and UP / DOWN are used to change the value in the selected field.

### 5.1.3.2 Time Zone

You can adjust the unit to the local time either by manually setting the date/time and daylight saving time, or by setting this item and let unit automatically adjusts the two items mentioned above according to the time zone you select.

Please refer to the figure below and select you local time zone.

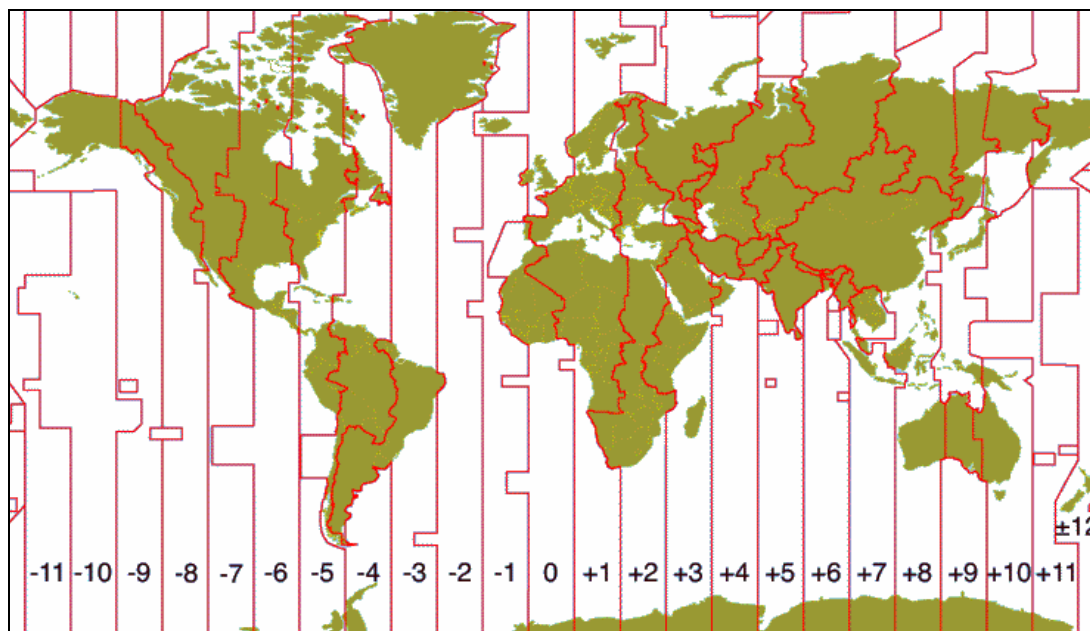

**NOTE:** After selecting the time zone, you MUST go to <Network Time Protocol Setup> → <Manually Time Sync> and synchronize the local time once, or the time zone setting will not be activated.

### 5.1.3.3 Date / Time Display

Users are allowed to choose to set the Date / Time OSD displays in 1 or 2 rows. Use the UP / DOWN keys to change the setting. The default is to display the date / time OSD in one row.

### 5.1.3.4 Date Display Mode

This function allows the user to set the OSD display type for the date / time. There are three options to select from: <Y/M/D>, <M/D/Y> or <D/M/Y>. “Y” represents “Year”, “M” represents “Month” and “D” represents “Day”.

Use UP / DOWN keys to change the setting. The default setting is <Y/M/D> in both NTSC / PAL formats.

### 5.1.3.5 Time Display Mode

The user can choose to set the time format to <12 hour> or <24 hour>. Use the UP / DOWN keys to change the format. The default setting is <12 hour>.

### 5.1.3.6 Daylight Saving Time Setup

This menu is for people who live in certain regions to observe Daylight Saving Time (DST).

#### Daylight Saving Time

Select <On> to enable, or <Off> to disable the function.

If the function is disabled, the DST Start/ End time and DST Bias will be grayed out and cannot be accessed. If this function is enabled, the date/time information will be shown on the screen with a DST icon when playing back recorded video or searching video in the event list. "S" indicates summer time and "W" indicates wintertime.

#### DST Start / End

These items are used to set the daylight saving duration. Use LEFT / RIGHT to move the cursor to the next or previous field, UP / DOWN to change the settings.

#### DST Bias

This item allows the user to set the amount of time to move forward from the standard time for daylight saving time. Available options are <30>, <60>, <90> and <120> minutes.

### 5.1.3.7 Network Time Protocol Setup

The submenu allows you to setup the Network Time Protocol (NTP) server, to automatically synchronize your unit to fit the local time per hour, and to manually synchronize the local time.

Network Time Protocol Setup	
NTP Server	time.nist.gov
Automatically Time Sync	Off
Manually Time Sync	No

#### NTP Server

The item shows IP address of the NTP server. If you want to change to another NTP server, press ENTER and fix it through a virtual keyboard.

### Automatically Time Sync

Select <On> to synchronize the local time automatically every hour.



**NOTE:** If you want the unit to automatically synchronize the local time, the <Time Zone> item **MUST NOT** be set to <Off>, or the function cannot be activated.

### Manually Time Sync

Select <Yes> to instantly synchronize the local time.

## 5.1.4 Unit Name

Users are allowed to assign a name, up to 11 characters, to the **DVR-4TH/ 8TH/ 16TH** series unit.

Follow the steps below to edit the unit name.

- Select <Unit Name> from System Setup menu and press ENTER. A virtual keyboard displays.

Unit Name												
!	@	#	*	-	_	+	=	,	.	/	Back	
1	2	3	4	5	6	7	8	9	0	Del		
A	B	C	D	E	F	G	H	I	J	K	L	M
N	O	P	Q	R	S	T	U	V	W	X	Y	Z
a	b	c	d	e	f	g	h	i	j	k	l	m
n	o	p	q	r	s	t	u	v	w	x	y	z
<<			>>			Space		Cancel		OK		

- Use Direction keys to move the cursor to the desired character.
- Press ENTER to add the character to the entry field (up to 11 characters).
- When done, move the cursor to <OK> and press ENTER to save the settings and exit.

## 5.1.5 Show Unit Name

Select <Yes> to show the **DVR-4TH/ 8TH/ 16TH** series unit name on the monitor or <No> hide the unit name.

## 5.1.6 User Management

The DVR provides the option to create up to seven sets of usernames and passwords with customized authority, excluding the preset “admin” account. The menu is as the following.

User Management	
Password Protection	On
Account Setup	
Authority Setup	
Load Default Setting	No

### 5.1.6.1 Password Protection

Select <On> to request for username and password for accessing functions listed in Authority Setup menu, or select <Off> to allow free access.

### 5.1.6.2 Account Setup

Setup customized username, password, and privilege level in this menu. Press Direction keys and ENTER to select items. The account is case sensitive. The authority level rank from level 1~8, and level 8 has the highest privilege. Alternatively, select <Disable> to stop using the chosen account.

Account Setup		
Account:	admin	Mod
Password:	****	Mod
Privilege:	Level 8	
2nd PWD:	OFF	
2nd PWD:		Mod



**NOTE:** The account and privilege level of the preset “admin” account cannot be changed.

### 5.1.6.3 Authority Setup

Setup permitted authority level for accessing the functions listed in this menu. The functions include: Playback/Search, Dome Control, Live Operation, Call Control, Export Data, Menu Access, System Setup, Monitor Setup, Camera Setup, Record Setup, Sequence Setup, Event Setup, Database Setup, Configuration, POS Setup, and Shutdown. Press Direction keys and ENTER to select items. The privilege level rank from level 1~8, and level 8 has highest authority. Alternatively, select <Disable> to allow free access.

Authority Setup	
Item	Authority
Playback/Search	Level 4
Dome Control	Level 4
Live Operation	Level 4
Call Control	Level 4
Export Data	Level 4
Menu Access	Level 4
System Setup	Level 4
Monitor Setup	Level 4
Camera Setup	Level 4



**NOTE:** The “Menu Access” cannot be set to <Disable>.

When the account does not have authority to access certain functions, an error message will be displayed on the screen.

#### 5.1.6.4 Load Default Setting

This item is for restoring the default settings. Select <Yes> to load default setting or select <No> to exit.

#### 5.1.7 Network Setup

The Network Setup menu allows the account with appropriate privilege to configure the network by specifying the network related settings, such as IP address and Netmask, etc.

See your network administrator and/or network service provider for more specific information.

Some settings under the Network Setup menu, such as IP and PPPoE Account, need to be configured through the virtual keyboard. The function key usage pattern is slightly modified, please refer to section **Key Usage in Virtual Keyboard**.

From the System Setup menu, select <Network Setup> and press ENTER. The following menu displays. Items in this menu are described in the following sections.

Network Setup	
LAN Select	LAN
LAN Setup	
Modem Setup	
Trigger Port	100
Email Address	
SMTP Setup	
DDNS Setup	
UPnP Setup	

### 5.1.7.1 LAN Select

PPPoE stands for Point-to-Point Protocol over Ethernet, which is a specification for connecting the users by Ethernet to the Internet through a common broadband medium.

This item allows you to select your service type between <LAN>, <PPPoE> or <None>; if you are using an intranet for communication, please select <LAN>, if you are using a broadband medium, such as DSL Line or cable modem, please select <PPPoE>.

If <None> is selected, then there is no need to set further LAN setting, therefore, the second item <LAN Setup> will not be accessible.

### 5.1.7.2 LAN Setup

The network related settings in the LAN Setup menu should be associated with the network service type. If you select <LAN> for <LAN Select>, then 6<sup>th</sup> to 8<sup>th</sup> item will not be available. Select <LAN Setup> in Network Setup menu and press ENTER for setting the parameters; the menu displays as follows.

LAN Setup	
DHCP	OFF
IP	192.168.1.150
Netmask	255.255.255.0
Gateway	192.168.1.1
DNS	0.0.0.0
PPPoE Account	
PPPoE Password	
PPPoE Max Idle	35min
Connect At Booting	Yes
Network Restart	No

## DHCP

This item allows the user to obtain a dynamic IP address from a DHCP (Dynamic Host Configuration Protocol) server while the unit boots up. When using DHCP, the settings are dynamic and they will change every time you power up and power off the unit, depending on your network's setup.

If the DHCP is enabled (ON), a dynamic IP will be assigned to the **DVR-4TH/ 8TH/ 16TH** series unit. In this case, the user does not need to configure a static IP or the Ethernet settings including IP address, Netmask, Gateway, and DNS settings will be "read only". The default setting is <ON>.

If you are using permanent addressing, set DHCP to <OFF> for setting the IP Address, Netmask, Gateway, and DNS. See your network system administrator or IT personnel for appropriate values for these setting.

## IP

This item is used to configure the IP (Internet Protocol) address of the unit. The IP address is the identifier for your computer or device on a TCP/IP LAN or WAN. Please note that to set a static IP address, DHCP must be set to <OFF>.

## Netmask

A netmask is a 32-bit mask used to divide an IP address into subnets and specify the networks available hosts. Its value is defined by your network administrator. It takes the form as **\*\*\*.\*\*\*.\*\*\*.\*\*\***, for example, 255.255.255.255.

This item allows the user to enter the value of the Netmask for the unit. Please note that to configure the item, DHCP must be set to <OFF>.

## Gateway

A Gateway is a node on a network that serves as an entrance to another network.

Users are allowed to specify the IP address of the gateway or router associated with this unit. To configure this item, DHCP must be set to <OFF>.



## DNS

DNS is the abbreviation for “Domain Name System”, which is an Internet service that translates domain names into IP addresses because domain names are easier to remember.

This item allows the user to specify the IP address of the Domain Name System associated with the unit. To configure this item, DHCP must be set to <OFF>.

If the network server is unavailable when using DHCP, the unit searches for the network server and boots up more slowly. This network search continues until it times out.

## PPPoE Account

This item allows the user to setup the PPPoE login username.



**NOTE:** For accessing the PPPoE settings, select <PPPoE> as the Network Type in Network Setup menu.

To setup the login username, follow the steps below:

- Select <PPPoE Account> from the LAN Setup menu and press ENTER. A virtual keyboard displays.

PPPoE Account												
!	@	#	*	-	_	+	=	,	.	/	Back	
1	2	3	4	5	6	7	8	9	0	Del		
A	B	C	D	E	F	G	H	I	J	K	L	M
N	O	P	Q	R	S	T	U	V	W	X	Y	Z
a	b	c	d	e	f	g	h	i	j	k	l	m
n	o	p	q	r	s	t	u	v	w	x	y	z
<<		>>			Space			Cancel		OK		

- Use Direction keys to move the cursor to the desired character.
- Press ENTER to add the character to the entry field.
- When done, move the cursor to <OK> and press ENTER to save the settings and exit.

### PPPoE Password

This item allows the user to setup the PPPoE password. Follow these steps to setup the login password.

- Select <PPPoE Password> from LAN Setup menu and press ENTER. A virtual keyboard displays.
- Use Direction keys to select character.
- Press ENTER to add the selected character to the entry field.
- When done, move the cursor to <OK> and press ENTER to save the settings and exit.

### PPPoE Max Idle

This item indicates the time that the modem connection remains active if there is no acknowledgement from the remote PC. You can select the idle time from 0 to 600 minutes. The default is 35 minutes.

### Connect At Booting

The unit can connect to the Internet automatically when powered up. Select <YES> to connect at booting, otherwise select <NO>.

### Network Restart

**Network restart is required after changing network settings.** Select <Yes> to restart the network connection. After pressing ENTER, a message "Network restarting Please stand by" will be shown on the screen. A message box will be displayed within 30 seconds.

Network restart.....	√
UPnP NAT setting.....	X
DDNS submitted.....	√
WAN connection.....	√

The "√" symbol indicates that the device is working properly whereas the "X" symbol indicates that the device is NOT working properly. The definitions of the items on the message box are described below.

### 5.1.7.3 Modem Setup

The **DVR-4TH/ 8TH/ 16TH** series unit can connect to the internet via an external installed modem.

Modem Setup	
Dial-in Setup	
Dial-out Setup	
Dial Port Selection	NONE

#### Dial-in Setup

The Dial-in function enables the user to establish dial-up modem communication to and from the **DVR-4TH/ 8TH/ 16TH** series unit for remote software use. The user is allowed to connect only one modem to a **DVR-4TH/ 8TH/ 16TH** series unit.

For more information on dial-up setting on PC, see appendix *Dial-up Connections via Modem.*



**NOTE:** The Dial-in Service is not available if there is no modem connected to the unit.

In Network Setup menu, select <Dial-in Setup> and press ENTER to enter the Dial-in menu. The menu displays as follows.

Dial-in Setup	
Dial-in Service	OFF
Dial-in Account	User
Dial-in Password	XXXX
Server IP	192.168. 0. 1
Client IP	192.168. 0. 2
Dial-in Idle Time	0 Min
Dial-in Max Time	0 Min

#### **Dial-in Service**

If the **DVR-4TH/ 8TH/ 16TH** series unit does not connect to the Internet, the user can communicate to the unit from a remote PC through a modem as well. Select <ON> to enable the Dial-in function, or <OFF> to disable.

#### **Dial-in Account**

This item enables user to protect access to the unit by establishing or changing a dial-in user name for modem connection.

To setup the Dial-in Account, follow these steps.

- Select <Dial-in Account> from Dial-in Setup menu and press ENTER. A virtual keyboard displays.

Dial-in Account												
!	@	#	*	-	_	+	=	,	.	/	Back	
1	2	3	4	5	6	7	8	9	0	Del		
A	B	C	D	E	F	G	H	I	J	K	L	M
N	O	P	Q	R	S	T	U	V	W	X	Y	Z
a	b	c	d	e	f	g	h	i	j	k	l	m
n	o	p	q	r	s	t	u	v	w	x	y	z
<<		>>		Space			Cancel		OK			

- Use Direction keys to move the cursor to the desired character.
- Press ENTER to add the selected character to the entry field.
- When done, move the cursor to <OK> and press ENTER to save the settings and exit.



**NOTE:** The Server IP and the Client IP must not be identified as the same IP address; but they have to be set in the same domain.

For example: Server IP= 192.168.0.1 ; Client IP= 192.168.0.2

### Dial-in Password

This item allows the user to setup the Dial-in password. Follow these steps to setup the login password.

- Select <Dial-in password> from Dial-in Setup menu and press ENTER. A virtual keyboard displays.
- Use Direction keys to select character.
- Press ENTER to add the selected character to the entry field.
- When done, move the cursor to <OK> and press ENTER to save the settings and exit.

### Server IP

This item is for setting the IP address that identifies the **DVR-4TH/ 8TH/ 16TH** series unit over a modem connection. To set the server IP, follow these steps:

- Select <Server IP>.
- Using LEFT/ RIGHT to move the cursor over the IP, and stop where you want to make the change.
- Press ENTER, and then use UP/ DOWN to change the value.
- When done, press ENTER again to exit.
- Repeat the procedure until the IP is completely set.

**Client IP**

This item determines the remote PC's IP address for connecting with the **DVR-4TH/ 8TH/ 16TH** series unit. To set the Client IP, follow these steps:

- Select <Client IP> and use LEFT/ RIGHT to move the cursor over the IP, and stop where you want to make the change.
- Press ENTER, then use UP/ DOWN to change the value.
- When done, press ENTER again to exit.
- Repeat the procedure until the IP is set completely.

**Dial-in Idle Time**

This item indicates the longest amount of time that the modem connection remains active if there is no acknowledgement from the remote pc. The value can be set from 0 min to 600 min.

**Dial-in Max Time**

The item indicates the longest amount of time that the connection via modem remains active. The value can be set from 0 min to 600 min.

**Dial-out Setup**

The Dial-out function enables the user to establish dial-up modem communication to and from the **DVR-4TH/ 8TH/ 16TH** series unit for remote notification use. The user can connect one modem to the **DVR-4TH/ 8TH/ 16TH** series unit. For more information for dial-up setting on PC, see appendix **Dial-up Connections via Modem**.



**NOTE:** The Dial-out Service is not available if there is no modem connected to the unit.

In the Network Setup menu, select <Dial-out Setup> and press ENTER to enter the Dial-out menu. The menu displays as follows.

Dial-out Setup			
Dial-out DHCP			OFF
Dial-out IP	0.	0.	0
Dial-out Netmask	0.	0.	0
Dial-out Gateway	0.	0.	0
Dial-out DNS	0.	0.	0
Phone Number			
Dial-out Account			
Dial-out Password			
Dial-out Idle Time			0 Min
Dial-out Max Time			0 Min
Connect			No

### **Dial-out DHCP**

This item allows the user to obtain a dynamic IP address from a DHCP (Dynamic Host Configuration Protocol) server over a modem connection. If the item is enabled (ON), a dynamic IP will be assigned to the **DVR-4TH/ 8TH/ 16TH** series unit. In this case, the user does not need to configure a static IP and the following settings will be “read only.”

Select <ON> to enable the DHCP function, or <OFF> to set the dial-out IP address, Netmask, Gateway and DNS manually. The default setting is <ON>.

### **Dial-out IP**

This item is for setting a static IP address that identifies the **DVR-4TH/ 8TH/ 16TH** series unit over a modem connection. Set the <Dial-out DHCP> to <OFF> for accessing this item.

Move the cursor over <Dial-out IP> and press ENTER, then press UP / DOWN keys to change the values in the selected field.

### **Dial-out Netmask**

This item is for setting the Netmask that identifies the **DVR-4TH/ 8TH/ 16TH** series unit over a modem connection. To configure the item, DHCP must be set to <OFF>.

Move the cursor over <Dial-out Netmask> and press ENTER, and then press UP / DOWN keys to change the values in the selected field.

### **Dial-out Gateway**

Users are allowed to specify the IP address of the gateway or router associated with this unit. To configure this item, DHCP must be set to <OFF>.

Move the cursor over <Dial-out Gateway> and press ENTER, and then press UP / DOWN keys to change the values in the selected field.

### **Dial-out DNS**

This item allows the user to specify the IP address of the Domain Name System (DNS) associated with the unit. To configure this item, DHCP must be set to <OFF>.

Move the cursor over <Dial-out DNS> and press ENTER, and then press UP / DOWN keys to change the values in the selected field.

### Phone Number

This item is used to set the dial-out phone number. Follow these steps to setup the phone number.

- Select <Phone Number> from Dial-out Setup menu and press ENTER. A virtual keyboard displays.
- Use Direction keys to move the cursor for selecting a number.
- Press ENTER to add the selected number to the entry field.
- When done, press ENTER to save the settings and exit.

### Dial-out Account

This item enables the user to set the Dial-out user name, which is needed for dialing out to Internet Service Provider server. Contact your network service provider for more specific information.

To setup the Dial-out Account, follow these steps.

- Select <Dial-out Account> from the Dial-out Setup menu and press ENTER. A virtual keyboard displays.

Dial-out Account												
!	@	#	*	-	_	+	=	,	.	/	Back	
1	2	3	4	5	6	7	8	9	0	Del		
A	B	C	D	E	F	G	H	I	J	K	L	M
N	O	P	Q	R	S	T	U	V	W	X	Y	Z
a	b	c	d	e	f	g	h	i	j	k	l	m
n	o	p	q	r	s	t	u	v	w	x	y	z
<<		>>		Space			Cancel		OK			

- Use the Direction keys to move the cursor to the desired character.
- Press ENTER to add the selected character to the entry field.
- When done, move the cursor to <OK> and press ENTER to save the settings and exit..

### Dial-out Password

This item allows user to setup the Dial-out password. Follow these steps to setup the login password.

- Select <Dial-out password> from Dial-out Setup menu and press ENTER. A virtual keyboard displays.
- Use Direction keys to move the cursor for selecting a character.
- Press ENTER to add the selected character to the entry field.
- When done, move the cursor to <OK> and press ENTER to save the settings and exit.

**Dial-out Idle Time**

This item indicates the longest amount of time that the modem connection remains active if there is no acknowledgement from the remote pc. The value can be set from 1 min to 600 min. If selecting <0>, the modem connection keeps active continuously.

**Dial-out Max Time**

This item indicates the longest amount of time that the connection via modem remains active. The value can be set from 1 min to 600 min, or <0> to keep the connection indefinitely.

**Connect**

When the Dial-out related settings are configured, set this item to <YES> to starting dial-out or select <NO> to disconnect.

**Dial Port Selection**

The Dial Port Selection enables users to assign the Dial-In/Out or Text to the designated port of the DVR. For instance, when the cable of a modem is inserted to the Serial Port of the DVR, enter the Dial Port Selection menu and assign Dial-In/Out to the Serial Port, the **DVR-4TH/ 8TH/ 16TH** series unit will now be able to use the modem to connect to the internet.

Dial Port Selection	
Serial Port	Dial-In/Out
USB Port-Front	NONE
USB Port-Rear Top	NONE
USB Port-Rear Bottom	NONE

**5.1.7.4 Trigger Port**

To avoid the possibility of the default service port (port 100)being blocked, this item enables the user to change port 100 into another port. To change the trigger port, move the cursor over <Trigger Port> and press ENTER, then adjust the setting by UP / DOWN keys. After you have entered a different port and pressed ENTER, a message "Network restarting Please stand by" will be shown on the screen. A message box will be displayed in approximately 30 seconds.

Port allocated.....	√
UPnP NAT setting.....	X
DDNS submitted.....	√
WAN connection.....	X



When the trigger port that you have just modified can be allocated, the 1<sup>st</sup> item "Port allocated" will be followed by a "√" symbol indicating that the designated port is allocated. "X" indicates that the port cannot be allocated. Note that the DDNS port will be automatically changed to the same port as the trigger port. For instance, when you have set the trigger to 123, the DDNS port will be automatically changed to port 123. Therefore, when the ports are allocated, "Port allocated" and "DDNS submitted" will both be followed by the "√" symbol. The 2<sup>nd</sup> to 4<sup>th</sup> item will be discussed in section **Network Restart**.

### 5.1.7.5 Email Address

This item is used to edit the e-mail address where alarm event information will be sent. Follow these steps to setup the e-mail address.

- Select <Email Address> from Network Setup menu and press ENTER. A virtual keyboard displays.
- Use Direction keys to move the cursor for selecting character.
- Press ENTER to add the selected character to the entry field.
- When done, move the cursor to <OK> and press ENTER to save the settings and exit.

### 5.1.7.6 SMTP Setup

Simple Mail Transfer Protocol (SMTP) is a protocol for sending e-mail messages between servers. SMTP is a relatively simple, text-based protocol, where one or more recipients of a message are specified and the message text is transferred.

Select < SMTP Setup> from Network Setup menu and press ENTER; the menu displays as follows.

SMTP Setup	
Email via SMTP	On
SMTP Server	
SMTP Port	
SMTP Account	
SMTP Password	

#### **Email via SMTP**

This item enables the user to determine if the unit sends e-mail via SMTP. Select <On> to send e-mail via SMTP using direction keys; if not, select <Off>.

### **SMTP Server**

This item enables the user to set the SMTP server. Contact your network service provider for more specific information.

Follow these steps to setup the SMTP Server.

- Select <SMTP Server> from SMTP Setup menu and press ENTER. A virtual keyboard displays.

SMTP Server												
!	@	#	*	-	_	+	=	,	.	/	Back	
1	2	3	4	5	6	7	8	9	0	Del		
A	B	C	D	E	F	G	H	I	J	K	L	M
N	O	P	Q	R	S	T	U	V	W	X	Y	Z
a	b	c	d	e	f	g	h	i	j	k	l	m
n	o	p	q	r	s	t	u	v	w	x	y	z
<<			>>			Space		Cancel		OK		

- Use Direction keys to move the cursor to the desired character.
- Press ENTER to add the selected character to the entry field.
- When done, move the cursor to <OK> and press ENTER to save the settings and exit.

### **SMTP Port**

This item is used to change the SMTP port to another port, if necessary. SMTP is usually assigned to operate over Internet port 25.

To change the SMTP port, move the cursor to <SMTP Port> in SMTP Setup menu and press ENTER. Use UP / DOWN keys to change the values in the selected field.

### **SMTP Account**

This item allows user to setup the SMTP username. Follow these steps to setup the login password.

- Select <SMTP Account> from SMTP Setup menu and press ENTER. A virtual keyboard displays.
- Use Direction keys to move the cursor for selecting character.
- Press ENTER to add the selected character to the entry field.
- When done, move the cursor to <OK> and press ENTER to save the settings and exit.

### **SMTP Password**

This item allows the user to setup the SMTP password. Follow these steps to setup the password.

- Select <SMTP password> from SMTP Setup menu and press ENTER. A virtual keyboard displays.
- Use Direction keys to move the cursor for selecting a character.
- Press ENTER to add the selected character to the entry field.
- When done, move the cursor to <OK> and press ENTER to save the settings and exit.

### **5.1.7.7 DDNS Setup**

Dynamic Domain Name System (DDNS) allows a DNS name to be constantly synchronized with a dynamic IP address. In other words, it allows those using a dynamic IP address to be associated with a static domain name so others can connect to it by the static name.

Once the setting is completed, the DDNS address will be:

<http://yourhostname.ddns.specoddns.net>

Fore example, if the chosen Host name is "SPEC0", then the address will be:

<http://speco.ddns.specoddns.net>

Select <DDNS Setup> from Network Setup and press ENTER. The menu displays as below figure.

DDNS Setup	
Enable DDNS	On
Host Name	XXXXXX
DDNS Port	80
Submit/Update	No
ezDDNS	No

### **Enable DDNS**

This item is used to enable or disable the Dynamic Domain Name Service. Select <On> to enable the service, or <Off> to disable.

### **Host Name**

This item allows the user to setup a domain name, which is used when entering the **DVR-4TH/ 8TH/ 16TH** series unit through the Internet on your remote PC.

To setup the Host Name of the unit, follow the steps.

- Select <Host Name> from DDNS Setup menu and press ENTER. A virtual keyboard displays as shown.

Host Name												
!	@	#	*	-	_	+	=	,	.	/	Back	
1	2	3	4	5	6	7	8	9	0	Del		
A	B	C	D	E	F	G	H	I	J	K	L	M
N	O	P	Q	R	S	T	U	V	W	X	Y	Z
a	b	c	d	e	f	g	h	i	j	k	l	m
n	o	p	q	r	s	t	u	v	w	x	y	z
<<		>>			Space			Cancel		OK		

- Use Direction keys to select a character.
- Press ENTER to add the selected character to the entry field.
- When done, move the cursor to <OK> and press ENTER to save the settings and exit.



**NOTE:** No any two **DVR-4TH/ 8TH/ 16TH** series units should be set to the same Host Name.

**DDNS Port**

This item allows the user to setup the port for DDNS. Press UP / DOWN Direction keys to change the port.

**Submit/ Update**

When done, move the cursor to this item and press ENTER to submit the settings.



**NOTE:** If there are two **DVR-4TH/ 8TH/ 16TH** series units set with the same domain name, the later setting will not be submit successfully.

**ezDDNS**

**ezDDNS** enables the users to register for the host name automatically. Press ENTER and select YES. The following screen will be displayed:

ezDDNS Submit/update ok!  
 Host name is XXXX\_XXXXXX  
 Press any key to return



**NOTE:** The DVR must be connected to the \*Real IP address, or be assigned a specific port using \*\*Port Forwarding technique.

\*A "**Real IP**" is the IP address that is assigned to you by your ISP.

\*\*A "Virtual IP" is the IP address assigned either manually or through DHCP. When the user is assigned a Virtual IP, the user must use **Port Forwarding** technique to assign a specific port to the DVR.

### 5.1.7.8 UPnP Setup

Universal Plug and Play (UPnP) integrates a universal protocol for widespread plug-and-play devices to ease the network implementation. When a PC and the **DVR-4TH/ 8TH/ 16TH** series unit both installed the UPnP function, the PC can automatically recognize the **DVR-4TH/ 8TH/ 16TH** series unit in the same local area network.

UPnP Setup	
UPnP	ON
UPnP NAT Traversal	No

#### UPnP

Select <ON> to enable the UPnP function, or select <OFF> to disable UPnP.

#### UPnP NAT Traversal

The UPnP NAT traversal function will help to automatically setup a router if the **DVR-4TH/ 8TH/ 16TH** series unit connects to the internet via a router. Select <Yes> to enable, or else select <No> to disable.

## 5.1.8 RS485 Setup

This menu allows the user to setup the parameters of the unit's RS-485 communications port. From the Main menu, select <RS485 Setup> and press ENTER. The following menu is displayed.

RS485 Setup	
Unit ID	224
Baud Rate	9600
Bits	8
Stop	1
Parity	None

### 5.1.8.1 Unit ID

This item is used to change the RS-485 ID address of the unit. The ID is with the range of <1> to <255>. The default is <224>.

### 5.1.8.2 Baud Rate

The Baud rate options for association with the protocol are <2400>, <4800>, <9600>, <19200>, <38400> and <57600>. The default is <9600> baud.

### 5.1.8.3 Bits

The user can specify the bits in a word that are associated with this protocol. The available options are <6>, <7> and <8> bits. The default is <8> bits.

### 5.1.8.4 Stop

The user can specify the stop bit associated with this protocol. Options are <1> and <2> stop bits. The default is <1> stop bit.

### 5.1.8.5 Parity

This item is used to specify the parity associated with this protocol. Options are <ODD>, <EVEN>, and <NONE>. The default is <NONE>.

## 5.1.9 Audio Output/ Key Beep

Enter this menu to setup the audio output or key beep.

Audio Output/ Key Beep	
Audio Output	Live/PB
Key Beep	ON

### 5.1.9.1 Audio Output

The item is used to set the audio output mode. The available options are as listed as follows.

#### <Live/PB>

Select this item to play the recording sounds of live image in live mode, and sounds of recorded video in playback mode respectively.

#### <Always Live>

Select this item to play live sounds in both live mode and playback mode.

#### <OFF>

Select this item to disable the audio output function.

### 5.1.9.2 Key Beep

This item is used to enable or disable the key tone. Select <ON> to enable the key tone, or <OFF> to disable.

### 5.1.10 User Graphic Interface

The OSD system can be displayed in graphic mode or text mode according to users' preference. Set this menu to <Graphic> and the OSD system will be displayed in GUI mode. Alternatively, set this menu to <Text> and the OSD system will be displayed in text mode.

### 5.1.11 IP Camera Support

Enter this item to add IP cameras to the DVR. The DVR supports up to 4 IP cameras. Select <0> will make the DVR act as a traditional analog DVR. Select <1> to <4> allows users to add 1 to 4 IP cameras to the DVR.

After the <IP Camera Support> is set to <1> to <4>, the following message will be displayed. Press ENTER to apply the changes, or ESC to exit.

Notice!!  
DVR must reboot to apply the change  
ENTER: Yes    ESC: No



**NOTE:**

1. The existing database will NOT be re-formatted after switching to this function.
2. Alarm I/O, Motion detection function, and audio of the IP camera are NOT currently supported

## 5.2 Monitor Setup

The Monitor Setup menu allows user to set the quality of the displayed image. Select <Monitor Setup> from the Main menu and press ENTER. The following menu is displayed.

Monitor Setup	
Show Camera Title	Yes
Title Position	Fit VGA
Monitor Brightness	0
Monitor Contrast	0
Monitor Chrominance	0
VGA Resolution	800x600
VGA Frequency	60Hz
Show Color Bar	

The following sections describe the items found in the Monitor Setup menu.

### 5.2.1 Show Camera Title

This item allows the user to choose whether to display the camera title on the screen or not. The default is <Yes>, which displays the camera titles with the video.

### 5.2.2 Title Position

This item sets the DVR to display the proper screen size either on a PC Monitor (VGA) or a CRT CCTV Monitor (BNC). For instance, if you are using a CRT CCTV monitor, set this item to <Fit BNC>; or set this item to <Fit VGA> for PC monitor.

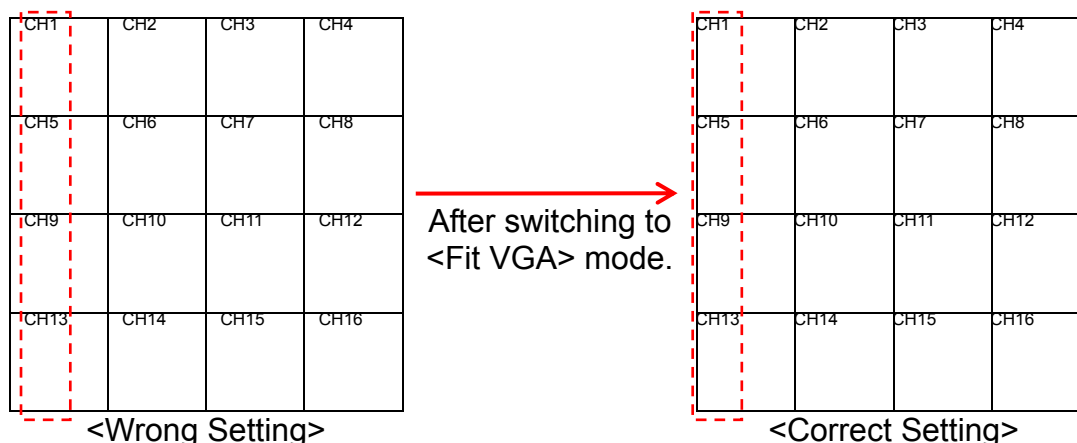



PC Monitor was used in the example above. In the <Wrong Setting>, the Title Position was set to <Fit BNC>, which was supposed to be set to <Fit VGA>. Since it was not the right setting, the titles of CH1, CH5, CH9, and CH13 were shifted slightly toward the middle of each channel. After switching to <Fit VGA>, the titles have been shifted back to the proper position as shown in the <Correct Setting>.

### 5.2.3 Monitor Brightness

This function allows the user to adjust the brightness of the image displayed on the monitor. Move the cursor to the item then press ENTER, and use UP / DOWN keys to adjust the numeric value. The range of brightness values is <-32> to <31>. The default setting is <0>.

### 5.2.4 Monitor Contrast

This item is used to adjust the color contrast of image. The range of contrast values is <-32> to <31>; the default setting is <0>.

### 5.2.5 Monitor Chrominance

Move the cursor over this item and press ENTER for adjusting the chrominance of the image displayed on the monitor. Use UP / DOWN keys to adjust the numeric value. The range of chrominance values is <-32> to <31>; the default setting is <0>.

### 5.2.6 VGA Resolution

This item allows the user to select appropriate VGA resolution for the VGA monitor connected to the unit. The options are <800x600> (default), <1024x768>, <1280x1024>, and <720p>. When the resolution is set to <1024x768>, <1280x1024>, and <720p>, the BNC and S-Video monitors will be unavailable.



**NOTE:** if the selected VGA resolution is too high for the monitor, the message “No Signal” will be shown on the screen. Then please press ESC on the front panel to restore the original setting.

### **5.2.7 VGA Frequency**

This item allows the user to select appropriate VGA frequency for the VGA monitor connected to the unit. The options are <60Hz> and <70Hz>.

### **5.2.8 Show Color Bar**

Choose this item to display a color bar pattern on the screen. The color bar helps to adjust the monitor hue, saturation, text color, and display options. Press ESC to exit the color bar pattern and return to the OSD menu.

## 5.3 Camera Setup

The items in the Camera Setup menu enable the user to set camera parameters, including camera title, dome protocol and ID for each connected camera. Note that there will be separated menus for analog camera and IP camera. Please refer to <Analog Camera> section if you are using an analog camera, or refer to <IP Camera> when you are using an IP camera.

### 5.3.1 Analog Camera

If you are using an analog camera, please continue with this section. Items in this menu are described in the following subsections.

Analog Camera	
Analog Camera Select	CH01
Dome Protocol	None
Dome ID	0
Camera Title	Ch1
Covert/Privacy Mask	
Termination	On
Brightness	0
Contrast	0
Saturation	0
Hue	0
Audio Association	Yes
Copy Settings	

#### 5.3.1.1 Camera Select

This item is used to select a camera for setting its parameters. The settings can be set for the selected camera are dome protocol, camera title, and etc.

Move the cursor to <Camera Select> and press ENTER, then select a channel using UP / DOWN keys.

#### 5.3.1.2 Dome Protocol

Select the communications protocol associated with your dome camera using the ENTER and Direction keys.

#### 5.3.1.3 Dome ID

This item is used to assign an ID number to the selected dome camera. Note that ID number must match the ID address set by the dome.

### 5.3.1.4 Camera Title

This item allows the user to change the title of each camera connected to the unit. By default, the titles of cameras are numbered from 1 through 16 respectively. The title is displayed on screen after the title changes are set.

Follow these steps to enter a new title for a camera.

- In the Camera setup Menu, move the cursor to Camera Title and press ENTER. A virtual keyboard with alphanumeric characters is displayed.

Camera Title												
!	@	#	*	-	_	+	=	,	.	/	Back	
1	2	3	4	5	6	7	8	9	0	Del		
A	B	C	D	E	F	G	H	I	J	K	L	M
N	O	P	Q	R	S	T	U	V	W	X	Y	Z
a	b	c	d	e	f	g	h	i	j	k	l	m
n	o	p	q	r	s	t	u	v	w	x	y	z
<<			>>			Space		Cancel		OK		

- Use Direction keys to position the cursor in the entry field above the virtual keyboard.
- Use Direction keys to move the cursor through the lists of characters to the one you need. Press ENTER to select a character. Continue until the name is established. Each title can contain up to 11 characters in it.
- After the title entry is finished, move the cursor to <OK> and press ENTER; otherwise, either press ESC, or move the cursor to <Cancel> and press ENTER to abort.

### 5.3.1.5 Covert/Privacy Mask

Enter this menu to configure settings of covert and privacy mask functions.

Covert/Privacy Mask	
Covert	No
Privacy Mask	Off
Privacy Mask Select	

#### Covert

This function allows the user to set the selected camera to be covert when the unit still continues to record video. Choose <Yes> to covert the selected camera. Alternatively, select <No> to allow the selected camera remains non-covert.

### **Privacy Mask**

The privacy mask function allows the user to block selected regions that might involve privacy issue. Select <On> to enable the function, or select <Off> to disable the function.

### **Privacy Mask Select**

Enter this menu to setup privacy mask regions. Use Direction keys to select any grid and press ENTER to select or deselect the grid. If a mouse is connected, follow the special operation described in appendix **USB Mouse Operation** for faster setup steps.

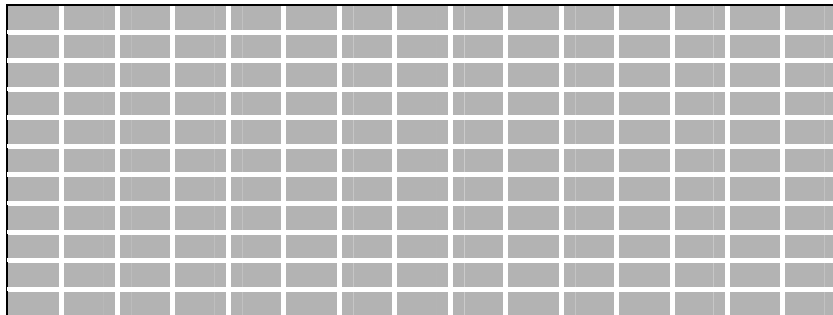

### **5.3.1.6 Termination**

This item is used to enable / disable the 75-termination resistor inside the unit that adjusts the image quality of each camera. <Yes> = termination resistor enabled (default), <No> = termination resistor disabled.



**NOTE:** If the camera loop-out connectors have not been used, the termination resistor should be enabled for appropriate signal termination.

### **5.3.1.7 Brightness**

Move the cursor to this item and press ENTER to adjust the brightness of the camera. Use UP / DOWN keys to adjust the numeric value. The range of brightness values is <-128> to <127>. The default setting is <0>.

### **5.3.1.8 Contrast**

Move the cursor to this item and press ENTER to adjust the contrast of the camera. Use UP / DOWN keys to adjust the value.

### 5.3.1.9 Saturation

Move the cursor to this item and press ENTER to adjust the color saturation of the camera using UP / DOWN keys. This value will be ignored on monochrome monitors. The range of saturation values is <-128> to <127>. The default setting is <0>.

### 5.3.1.10 Hue

Move the cursor to this item and press ENTER to adjust the hue of the camera. Use UP / DOWN keys to adjust the value.

### 5.3.1.11 Audio Association

This item is used to establish the connection between the selected camera and the its audio-in channel. Move the cursor to <Audio Association> and press ENTER, then select <Yes> to set up the connection. Alternatively, select <No> to disable the connection.

### 5.3.1.12 Copy Settings

This item allows the user to copy the settings set on the current selected camera to any other connected cameras. Enter this menu and select one or more cameras to copy the settings. Then select <CONFIRM> to apply the settings.

Copy Settings							
COPY TO:							
01	02	03	04	05	06	07	
SELECT ALL	DESELECT ALL	CONFIRM	CANCEL				

## 5.3.2 IP Camera

If you are using an IP camera, please continue with this section. Items in this menu are described in the following subsections.

IP Camera	
IP Camera Select	CH16
IP Camera Title	CH16
Search Via UPnP	
Hostname/IP	
Model	
Connection Setup	
Device Setup	
Activated	No
Status	
Copy Settings	

### 5.3.2.1 IP Camera Select

Select the corresponding channel. If <IP Camera Support> is set to <1>, then the last channel will be the corresponding channel for the IP camera. When <IP Camera Support> is set to <2>, the last two channels can be used to setup the IP cameras.

### 5.3.2.2 IP Camera Title

This item allows the users to change the title of each connected camera. By default, the titles of cameras are numbered from 1 through 16 respectively. The title will be displayed on screen after the changes of the titles are set.

Follow these steps to enter a new title for a camera.

- Move the cursor to <Camera Title> and press ENTER. A virtual keyboard with alphanumeric characters is displayed as below.

IP Camera Title												
!	@	#	*	-	_	+	=	,	.	/	Back	
1	2	3	4	5	6	7	8	9	0	Del		
A	B	C	D	E	F	G	H	I	J	K	L	M
N	O	P	Q	R	S	T	U	V	W	X	Y	Z
a	b	c	d	e	f	g	h	i	j	k	l	m
n	o	p	q	r	s	t	u	v	w	x	y	z
<<			>>			Space		Cancel		OK		

- Use Direction keys to select character.
- Press ENTER to add the selected character to the entry field.
- When it's done, move the cursor to <OK> and press ENTER to save the settings and exit.

### 5.3.2.3 Search Via UPnP

If the IP camera is UPnP compatible and is in the local area network, select this item and press ENTER to automatically search for the IP camera attached to the DVR.

### 5.3.2.4 Hostname/IP

This item allows users to enter the hostname or IP address of the IP camera (e.g. 192.168.1.123).

### 5.3.2.5 Model

Enter this item to select matching model of the IP camera. The DVR supports the following IP camera models: <Speco SIP Cameras>, <NH Series>, <ACTi Series>, <SONY SNC>, <AXIS 200>, <ViVoTek 7000>, <D7521>, <HUNT>, <SANYO>, and <LUXON>.

### 5.3.2.6 Connection Setup

This item allows users to setup the connection of the IP camera. Enter this item and the following menu will be displayed.

Connection Setup	
Account	****
Password	****
Management Port	80
Streaming Format	MPEG4
Advance Streaming Option	OFF
Streaming Port	554
Streaming Protocol	RTP+RTSP
IP Dome Protocol	NONE

#### Account

Enter the login account name of the IP camera.

#### Password

Enter the login password of the IP camera.

#### Management Port

The management port is the default port of the IP camera. Different IP cameras may have different management ports.

#### Streaming Format

Enter this item to select the streaming format of the IP camera. The DVR supports three types of streaming format: <MPEG4>, <MJPEG> and <H264>.

#### Advance Streaming Option

Select <OFF> and the Streaming Port and Streaming Protocol will be set automatically according to the camera model selected. Alternatively, select <ON> to manually set the Streaming Port and Streaming Protocol.

#### Streaming Port

Streaming port is used for transmitting video and related commands.



**Streaming Protocol**

Enter this item to select the streaming protocol of the IP camera. The DVR supports the following streaming protocols: <RTP+RTSP>, <RTP/RTSP>, <RTP/RTSP/HTTP>, and <HTTP>.



**NOTE:** Please contact manufacturer of the IP camera for assistance if the IP camera's Management Port/ Streaming Port/ Streaming Format/ Streaming Protocol are unknown.

**IP Dome Protocol**

If the connected device is an IP Dome Camera, then select an appropriate IP Dome Protocol from the provided options.

**5.3.2.7 Device Setup**

Enter this item to setup the basic settings of the IP camera. Upon entering this item, the following message will be displayed.

Collecting data  
Please wait!

If the connection cannot be detected, the following message will be displayed. Please check the <Hostname/IP>, <Model>, and <Connection Setup> again to make sure the settings are correct.

Cannot get config from the IP device

When the connection is detected, the following menu will be displayed.

Device Setup	
Product ID	****
Image Resolution	CIF
FPS	15
Compression	40
Quality	Best
Quality	0
Sharpness	20
Brightness	50
Contrast	30
Hue	40
Apply	No



**NOTE:** The contents of the Device Setup menu differ from camera model to camera model. For instance, when IP Camera Brand A is connected, all items may be available. However, when IP Camera Brand B is connected, the menu may contain only 8 items. Refer to the following comparing table for example.

<IP Camera Brand A>			<IP Camera Brand B>		
Device Setup			Device Setup		
1. Product ID	****		1. Product ID	****	
2. Image Resolution	CIF		2. Image Resolution	CIF	
3. FPS	15		3. FPS	15	
4. Compression	40		4. Quality	Best	
5. Quality	Best		5. Sharpness	0	
6. Sharpness	0		6. Contrast	20	
7. Brightness	20		7. Saturation	50	
8. Contrast	50		8. Apply	No	
9. Saturation	30				
10. Hue	40				
11. Apply	No				

### Product ID

This item will display the product name of the IP camera.

### Image Resolution/ FPS/ Compression/ Quality

These can be used to setup the Image Resolution/ FPS (Frames Per Second)/ Compression/ Quality of the IP camera.

### Sharpness/ Brightness/ Contrast/ Saturation/Hue

Move the cursor to the items and press ENTER to adjust the Sharpness/ Brightness/ Contrast/ Saturation/ Hue of the camera. Use UP / DOWN keys to adjust the numeric value.

### Apply

Select <Yes> to apply the above settings, and the following message will be displayed.

<p>Re-collecting data Please wait!</p>
--

When the settings cannot be applied, the following message will be displayed. Try to reduce the resolution or FPS of the IP camera. Note that the login account of the IP camera should have appropriate privilege.

<p>Cannot set the IP device</p>
---------------------------------

Otherwise, the <Device Setup> setting is completed.



**NOTE:** After changing any item under Device Setup menu, users MUST set <Apply> to <Yes> to apply the changes, or the settings will remain unchanged.

### 5.3.2.8 Activated

Access this item and select <Yes> to activate the connection to the IP camera. To deactivate the connection, select <No>



**NOTE:** Once the connection to the IP camera is activated, menu items <Hostname/IP>, <Model>, <Connection Setup> will be grayed out and cannot be accessed.

### 5.3.2.9 Status

After the connection to the IP camera is activated, users can check the connection status. The menu will be shown as below

Status	
Model	****
Resolution	720*480
PPS	10
Bandwidth	20 KB/Sec
Pkg. lost rate	0.1%

The information shown on the monitor is “ready only”.

### 5.3.2.10 Copy Settings

This item allows the user to copy the settings set on the current selected camera to any other connected cameras. Enter this menu and select one or more cameras to copy the settings. Then select <CONFIRM> to apply the settings.

Copy Settings						
COPY TO:						
10	11	12	13	14	15	16
SELECT ALL	DESELECT ALL	CONFIRM	CANCEL			

## 5.4 Record Setup

The following three factors will effect the total record time of the **DVR-4TH/ 8TH/ 16TH** series unit:

- HDD capacity
- Recording rate (Picture per Second)
- Image quality settings

The greater the recording rate and the higher the quality setting, the shorter the recording time. Most of the related factors can be set here in this submenu.

The Record Setup menu allows user to set recording quality, recording schedules, and other recording parameters. The account with appropriate privilege is required to access Record Setup menu. In the Main menu, move the cursor to <Record Setup> and press ENTER. The following menu is displayed.

Record Setup	
Record Mode Setup	
Schedule Setup	
Preset Config	Best Quality
Per Camera Config	
ezRecord Setup	
Data Lifetime Setup	
Pre-Alarm Recording	15 Sec
Circular Recording	On
Audio Recording	On
Purge Data	

### 5.4.1 Record Mode Setup

The Record Mode Setup menu is for selecting resolution and recording format. The relative record settings, such as preset configuration, will follow the record mode setting. The menu displayed as the following.

Record Mode Setup	
Record Resolution	352*240
Record Format	H264
Max Rec. PPS	60

#### 5.4.1.1 Record Resolution

Select resolution of the recorded video. If the recording is set to NTSC system, the selections are 720\*480, 720\*240, and 352\*240. If the recording is set to PAL system, the selections are 720\*576, 720\*288, and 352\*288.

### 5.4.1.2 Record Format

Select the format of the recorded video from <H264>, <MP4>, or <MJPG>.

### 5.4.1.3 Max Rec. PPS

This item will be automatically changed according to the setting of the previous two items.

## 5.4.2 Schedule Setup

This submenu is used to set the day and night time, or weekend recording schedule. The Night and Day schedules are used to define daytime and nighttime; the Weekend schedule is tailored for weekends and holidays. Select <Schedule Setup> from the Record Setup menu and press ENTER; the following menu is displayed.

Schedule Setup	
Day Time Start	AM 06:00
Day Time End	PM 06:00
Night Time Start	PM 06:00
Night Time End	AM 06:00
Weekend Schedule	On
Weekend Start	Fri 18:00
Weekend End	Mon 06:00

- Make appropriate changes for the start time of the Day Time and Night Time schedule using the Direction keys.
- Press ENTER to confirm the settings or ESC to cancel.
- If you want to record over the weekend, choose <On> to enable the Weekend Schedule in advance and then set the Weekend Start/End time.
- Press ESC to back to previous page.

### 5.4.2.1 Day / Night Time Start / End

The Day/Night Start/End Time determines the duration of day/ night recording time. Time is indicated in 1-minute increments. The time display format in this menu is based on the setting of Time Display Mode.

### 5.4.2.2 Weekend Schedule

The Weekend Schedule determines whether a weekend schedule is in effect. Choose <On> to take effect the related weekend settings.

### 5.4.2.3 Weekend Start / End

The Weekend Start Time indicates the specific day and time that a weekend begins, for example, Fri 18:00. The Weekend End Time indicates the specific time and day that a weekend ends, for example, Mon 06:00. Time is indicated in 1-minute increments.

Note that the value you have set indicates when the regular Day and Night scheduling ends, and Weekend recording begins.

### 5.4.3 Preset Record Configuration

The <Preset Config> is used to select the preset recording quality and frame rate. Different default recording quality levels are offered for the user to choose: <Best Quality>, <Standard>, <Extended Record>, <Event Only>, <ezRecord> and <OFF>.

According to various Record modes, the preset configuration options for normal and event status are described in terms of relative recording rate (Picture per Second; PPS) and recording size for each channel in the table below.

These preset conditions override any other quality and rate settings. The default Preset Configuration setting is <Best Quality>. Refer to appendix **Preset Record Configuration** for detailed information.

### 5.4.4 Per Camera Configuration

This submenu is used to set the Day / Night / Weekend PPS (Picture per Second) and recording quality for each channel. The <Preset Configuration> must be set to <OFF> for accessing these schedules.

The menu is displayed below is in Record mode: 352×240@240PPS in NTSC / 352×288@200PPS in PAL).

Per Camera Config			
Cameral Select	Day	Night	CH1 Weekend
Normal PPS	7.5	7.5	7.5
Normal Qlty	Mid	Mid	Mid
Event Max PPS	30	30	30
Event Qlty	Best	Best	Best
Event Act	Both	Both	Both

#### 5.4.4.1 **Camera Select**

This item is used to select a desired channel for setting the associated parameters. Move the cursor to <Camera Select> and press ENTER, then select a channel using UP / DOWN keys. Press ENTER again to confirm the setting.

#### 5.4.4.2 **Normal PPS**

Normal PPS (Picture per Second) is used to set the recording rate for normal status.

Please note that the total normal pps for all channels is limited under the maximum PPS for each Record mode. To increase one channel's pps, you may have to reduce other's first. Event pps is not restricted to this rule, since a smart event scheduler will handle the total pps automatically.

#### 5.4.4.3 **Normal Qlty**

This item is used to set the picture size for normal status recording. The available options are listed as follow: <Low>, <Fair>, <Mid>, <High> and <Best>.

#### 5.4.4.4 **Event Max PPS**

Event Max PPS is used to set the event recording rate for Event status. Normally, the Event PPS is set to be equal to or greater than Normal PPS; the setting depends on your application. If the Event PPS is set to <0>, the **DVR-4TH/ 8TH/ 16TH** series unit stops recording event video during alarms.

#### 5.4.4.5 **Event Qlty**

This item is used to set the picture size for event status recording. Refer to previous section **Normal Qlty** for the available options.

#### 5.4.4.6 **Event Active**

Users are allowed to choose which alarm type needs to be recorded. The available options are <Alarm> (alarm events), <Motion> (motion detection events), <Both> (alarm event + motion detection), and <None> (no events active). The default setting is <Both>, which includes Alarm and Motion event recording.

## 5.4.5 ezRecord Setup

This item aims to avoid the complicated record settings and to make the setup much easier. Note that this item can be reached only when you select <ezRecord> as the option for <Preset Config>. For more information, please refer to the appendix [ezRecord Diagram Sample](#).

Select <ezRecord Setup> from <Record Setup> and press ENTER, the sub-menu appears as shown below:

ezRecord Setup	
How Many Days To Record	2 Days
Daytime Record	Yes
Night Record	Yes
Weekend Record	Yes
Record Info	
Average Normal PPS	3.75
Average Normal Quality	Best

Follow these steps to Setup ezRecord:

- Select <How Many Days To Record> and press ENTER, then press UP/DOWN to choose an option. The average normal PPS & Quality will be adjusted automatically. The maximum of days depends of the size of your HDD, in the other words, the larger the HDD installed, the more days the unit can record.
- Move to <Daytime Record> and press ENTER. This item is for you to select whether you want the DVR to record during daytime. If so, use UP/DOWN to select <Yes> as an option; or, select <No> for not recording during daytime.
- Repeat the same procedures through the 3rd and 4th item, respectively. Note that <Weekend Record> will be not accessible if you select <NO> for the item <Weekend Schedule> in <Schedule Setup>.
- Select <Average Normal PPS> and press ENTER, then press UP/DOWN to choose an option. The <How Many Days To Record> will be computed automatically.
- Select <Average Normal Quality> and press ENTER, then press UP/DOWN to choose an option. The <How Many Days To Record> will be computed automatically.





**NOTE:** The current number of connected cameras will affect the recording quality which will be automatically calculated through the <ezRecord Setup>. Therefore, once you disconnect cameras or connect more cameras to the unit, you should reset the <ezRecord Setup>.

## 5.4.6 Data Lifetime Setup

Data Lifetime indicates the duration that a video is saved and recallable in the HDD. Only those video recorded within Data Lifetime can be displayed on the screen and played back. The video exceeded Data Lifetime will be hidden and cannot be retrieved for playback.

Data Lifetime Setup	
Data Lifetime Mode	General
Data Lifetime	0 Days
Data Lifetime By Day	
Data Lifetime By Channel	



**NOTE:** To playback a video exceeding the data lifetime, please extend the duration until the recording data / time of the video is included.

### 5.4.6.1 Data Lifetime Mode

This item allows the user to choose preferred data lifetime mode. There are three types of data lifetime mode: General, By Day, and By Channel. When a specific mode is selected, the other two will be grayed out and cannot be accessed.

### 5.4.6.2 Data Lifetime

When data lifetime mode is set as <General>, this item will be accessible. Press ENTER to select this item and press UP / DOWN keys to set the data lifetime. The value ranges from <1> to <365> days. Alternatively, select <0> to disable this function.

### 5.4.6.3 Data Lifetime By Day

When data lifetime mode is set as <By Day>, this item will be accessible. Enter this menu and the user can setup data lifetime of each weekday independently. The value ranges from <1> to <365> days. Alternatively, select <0> to disable this function.

#### 5.4.6.4 Data Lifetime By Channel

When data lifetime mode is set as <By Channel>, this item will be accessible. Enter this menu and the user can setup data lifetime of each channel independently. The value ranges from <1> to <365> days. Alternatively, select <0> to disable this function.

#### 5.4.7 Pre-Alarm Recording

This item is used to set the duration time of pre-alarm recording video. The pre-alarm recording function aims to give the user the opportunity to view a more complete event video. The user can see the video recorded after the alarm is triggered, and the video recorded ahead the alarm.

When an event is triggered while normal recording is in effect, the unit will start copying the pre-alarm and the post-alarm video to the event video. The pre-alarm duration can be set from 0~30 seconds. The default setting is 15 seconds.

The quality of the pre-alarm video is the same as the quality setting for normal record video; and the quality of the post-alarm video is the same as the quality setting for event record video.

#### 5.4.8 Circular Recording

The user can choose to record video in circular mode or in linear mode. If you choose to record in circular mode, then the unit begins to overwrite the oldest recorded video and stores new video over the HDD spaces. If you choose to record in linear mode instead, the unit stops recording when the HDD is full.

From the Record Setup menu, move the cursor to <Circular Recording> and press ENTER, then select <ON> / <OFF> using UP / DOWN keys.

#### 5.4.9 Audio Recording

This item allows the user to enable / disable the Audio recording function of the unit. When set to <ON>, audio input is recorded and saved with the video. When set to <OFF>, audio is ignored. The default setting is <ON>.

## 5.4.10 Purge Data

This item is used to delete the Normal or Event recording video. In Record Setup menu, move the cursor to <Purge Data> and press ENTER; the Purge Data menu is displayed.

Purge Data	
Purge All Data	No
Purge All Event Data	No
Purge Event Before	2009/01/01
Start To Purge	No

### 5.4.10.1 Purge All Data

This item is used to delete all video from database(s). Using UP / DOWN buttons to select <Yes> and start the deleting by setting the <Start to Purge> to <Yes>.

### 5.4.10.2 Purge All Event Data

This item is used to delete all event video from database(s). Using UP / DOWN keys to select <Yes> and start the deleting by setting the <Start to Purge> to <Yes>.

### 5.4.10.3 Purge Event Before

This item is used to delete event video before a specific date. Use LEFT / RIGHT keys to move the cursor to next or previous field, ENTER to select the item and UP / DOWN to adjust the value.

### 5.4.10.4 Start To Purge

After selecting the video you want to delete, or setting the date for deletion, set this item to <Yes> to start the deleting process or choose <No> to cancel.

## 5.5 Sequence Setup

The Sequence Setup menu allows the user to set the camera sequence schedule and dwell time for main and call monitor. Select <Sequence Setup> in Main menu and press ENTER; the menu displays as follows. Items in the Sequence Setup menu are described in the following subsections.

Sequence Setup	
Main Monitor Dwell	5 Sec
Main Monitor Schedule	
Call Monitor Dwell	5 Sec
Call Monitor Schedule	

### 5.5.1 Main / Call Monitor Dwell

The Main / Call Monitor can be set to display full screen video for all installed cameras in sequence. This item is used to set the Main / Call Monitor dwell time, which is the amount of time elapsed between switching images. The dwell time has an available range of 1 to 120 seconds.

### 5.5.2 Main / Call Monitor Schedule

This item is used to set the Main / Call Monitor camera sequence in full screen format. Move the cursor to <Main Monitor Schedule> and press ENTER; the menu is displayed as follows.

Main Monitor Schedule															
01	▶	02	▶	03	▶	04	▶	05	▶	06	▶	07	▶	08	▶
09	▶	10	▶	11	▶	12	▶	13	▶	14	▶	15	▶	16	
01	02	03	04	05	06	07	08	09	10	11	12	13	14	15	16
Back				OK				Cancel							

Follow these steps to set a sequence:

- Press LEFT direction key to delete the original setting.
- Press the desired Channel keys to assign a camera to that location in the sequence.
- Continue the steps until the sequence is completed.

A sequence can have up to 16 entries. The user can select fewer than 16 entries for a camera sequence and leave the remaining entries blank. The sequence can include a specific camera or cameras multiple times.

## 5.6 Event Setup

This menu allows the user to determine **DVR-4TH/ 8TH/ 16TH** series behavior in response to an alarm event. In the Main menu, move the cursor to <Event Setup> and press ENTER. The following menu is displayed.

Event Setup	
Internal Buzzer	ON
Event Icon	ON
Email Notice	OFF
Email Attachment	OFF
Alert Notification Setup	
Event Full Screen	None
Event Duration	20 Sec
Per Channel Config	

### 5.6.1 Internal Buzzer

This item allows user to enable / disable the **DVR-4TH/ 8TH/ 16TH** series internal buzzer. If set to <ON>, the buzzer is activated in response to an alarm. If set to <OFF>, the buzzer is not activated. The default setting is <ON>.

### 5.6.2 Event Icon

This item enables (ON) / disables (OFF) the display of an Event Icon on the main monitor when an alarm event occurs. The default setting is <ON> (enable). The event types are represented by a character respectively; the descriptions are listed in the following table.

Event type	Description
<b>A</b>	Alarm in event
<b>M</b>	Motion detection event
<b>L</b>	Video loss event

### 5.6.3 Email Notice

The item enables (ON) / disables (OFF) the Email notification of an event. When an alarm event is triggered and <Email Notice> is enabled, an e-mail concerning the alarm event will be sent. The default setting is <OFF>.



**NOTE:** In order to send an event notification e-mail successfully, ensure that the unit connects to the Internet.

## 5.6.4 Email Attachment

The function allows the unit to send out brief AVI video regarding the event. The number of the attached AVI video will be equal to the number of cameras you connect to the unit. For example, if the unit has been connected with 8 cameras, then 8 video will be attached with the notice email. The total size of the video will be about 1 Megabyte. Select <ON> to enable this function; and <OFF> to disable it. The default is <OFF>.



**NOTE:** The video clips of the Email Attachment will ONLY be in \*.avi format. Please download the Divx Player from [www.divx.com](http://www.divx.com) to play the \*.avi files.

## 5.6.5 Alert Notification Setup

This function allows the user to send alert notifications to the CMS program which had been installed to your computer. For detailed setup instruction, please refer to the CMS user's manual.

Alert Notification Setup	
Alert Configuration Set	1
Alert Notification	OFF
Alert IP	0. 0. 0. 0
Alert Port	9999
Alive Interval	120 Sec

### 5.6.5.1 Alert Configuration Set

<Alert Configuration Set> provides 3 combinations of Alert Notification, IP, and Port.

### 5.6.5.2 Alert Notification

4 options are included in this item; <OFF>, <Event>, <Alive>, and <Both>.

<OFF>: The Alert Notification is turned off.

<Event>: When the alarm is triggered, the DVR will send an alert message to the CMS.

<Alive>: The DVR will send an alive message to the CMS every *N* second just to show that the connections between the DVR and CMS are in effect. The time interval *N* can be adjusted in <Alive Interval>.

<Both>: This enables the DVR to send both Event and Alive alert package to the CMS.

### 5.6.5.3 Alert IP

The Alert IP must match the IP address of the computer.

### 5.6.5.4 Alert Port

The ports for both DVR and the CMS Alert **must be the same**.

### 5.6.5.5 Alert Interval

To define the time interval (1 to 255 seconds) between each alive message.

## 5.6.6 Event Full Screen

This function allows the unit to display the alarm channel in full screen size when an alarm is triggered.

Select <None> to enable this function; select <Main> to display the alarm channel on Main Monitor when an alarm is triggered; select <Call> to display the alarm channel on Call Monitor; and select <Both> to display the alarm channel on both Main Monitor and Call Monitor.

## 5.6.7 Event Duration

This item determines the duration of the buzzer and Alarm Out relay function after an alarm is triggered. The available event duration range is from 5 second to 999 seconds.

## 5.6.8 Per Channel Config

This menu is used to set the Video Loss Detect, Motion Detect and Alarm In / Out function for each channel. The menu is displayed as below.

Per Channel Config	
Channel Select	CH01
Video Loss Detect	OFF
Motion Detect	OFF
Detection Config	
Alarm In	OFF
Alarm Out	None
Digital Deterrent-Day	OFF
Digital Deterrent-Night	OFF
Digital Deterrent-Weekend	OFF

### 5.6.8.1 Channel Select

This item is used to select a desired channel for setting the parameters. Move the cursor to <Channel Select> and press ENTER, then select a channel using UP / DOWN keys. Press ENTER again to confirm the setting.

### 5.6.8.2 Video Loss Detect

This item allows the user to enable / disable Video Loss as an alarm event. Select <ON> to enable Video Loss alarm events, <OFF> to disable. The default setting is <OFF>.

### 5.6.8.3 Motion Detect

To detect motions, the users can choose from these options: <OFF>, <ALL>, <Night & Weekend>, <Day & Weekend>, <Weekend>, <Day & Night>, <Night>, and <Day>. The Day, Night, and Weekend is defined in section **Schedule Setup**.

If motion detection function is enabled, it is required to define the motion detection parameters such as detection area and sensitivity settings.

### 5.6.8.4 Detection Config

If motion detection function is enabled, it is required to define the motion detection parameters such as detection area and sensitivity settings. Select a channel for setting the parameters, move the cursor to <Detection Config>, and press ENTER. The Detection Configuration menu displays as follows.

Detection Config	
Detected Area Setup	
Sensitivity	92%
Area Threshold	4%

#### **Detected Area Setup**

The Detect Area is displayed as follows after selecting this item. The detection area consists of 165 (15×11) detection grids.

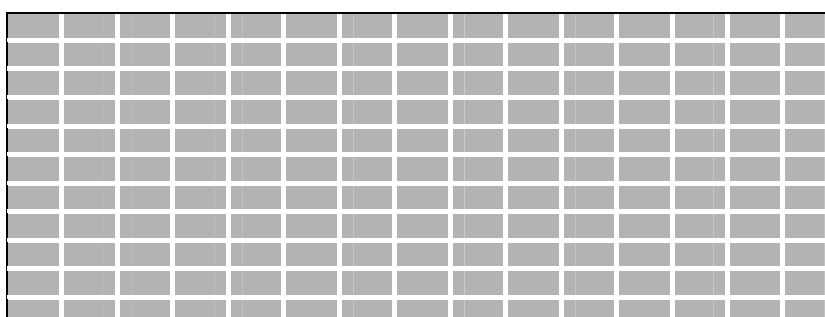



Use the Direction keys to move the cursor and press ENTER to enable or disable a grid. Press MODE to select all of the grids for detection; press MODE again to de-select all of the grids.

### **Sensitivity**

This item is used to set the sensitivity of detection grids for the camera. A greater value indicates more sensitive motion detection. A motion alarm will be triggered, once the amount of motion detected exceeds the Threshold value

Move the cursor to <Sensitivity> and press ENTER, and then use UP / DOWN keys to adjust the value. The value is indicated in 4% increment.

### **Area Threshold**

<Area Threshold> means the motion alarm triggered level; if the percentage of triggered grids to total detection area is greater than the set value, the motion alarm will be triggered.

For example, if 10 grids are selected and the < Area Threshold > value is 70%, the motion alarm will be triggered when 7 grids are motion detected.

Move the cursor to < Area Threshold > and press ENTER, then use UP / DOWN keys to adjust the value. The value is indicated in 1% increments.

## **5.6.8.5 Alarm In**

This item allows the user to enable / disable alarm input detection. According to your application, select <N/O> (Normal Open) or <N/C> (Normal Close) to enable the alarm input detection or select <OFF> to disable detection. The default setting is <OFF>.

NOTE: If you set this item to <N/C> but did not install any device to the unit, the alarm will be triggered and the Event Icon will be displayed continually until this item is changed to <N/O>, <OFF> or, install a device to the unit.

## **5.6.8.6 Alarm Out**

This item allows the user to assign an alarm on a certain channel to activate the relays. These signals can be used to drive a light or siren to caution an alarm event.

Select from the options: <A Only> indicates “Alarm Out A”, <B Only> indicates “Alarm Out B”, <A+B> indicates “A and B Alarm Out” and <None> indicates “No Alarm Out”. The default setting is <None>.

### 5.6.8.7 Digital Deterrent – Day/ Night/ Weekend

If an alarm is triggered while Digital Deterrent is enabled, a pre-recorded audio warning will be sent to the speaker installed nearby the location where the alarm was triggered. For instance, if the alarm of Channel 2 is triggered and there is a speaker installed to the DVR nearby, the speaker will play the audio warning.

The available options are <OFF>, <Default>, and <Sound\_1> ~ <Sound\_50>. Select <OFF> to disable this function. Selecting <Default> will apply audio warning pre-stored in the DVR. <Sound\_1> ~ <Sound\_50> allows the user to apply user-defined audio warning from 1 to 50. Note that the user-defined audio has to be set before choosing <Sound\_1> ~ <Sound\_50> option, or the following message will be shown.

Warning!!  
 No user-defined file is in the DVR!  
 Please create customized file first!  
 The steps are similar to ezBurn  
 Note: Cannot exceed 10 seconds  
 Press any key to return

Only sound files 1 to 16 can be recorded via the following steps. The other way to define sound files 1 to 50 is to import manually. Refer to the section **Import Deterrent** for more details about importing sound files.

- Use any camera to record the preferred audio. Please note that <Audio Recording> under <Record Setting> menu should be set to <ON>.
- Press SEARCH and play the normal video of the recorded date and time.
- View full screen of the channel that the preferred audio was recorded.
- Press COPY at the point you want to set as the start point of the audio. The playback continues.
- Press COPY again at the point you want to set the end point of the audio. Now, the “ezBurn Confirmation” window displays as follows. The information shown on the window is “read only”.

ezBurn Confirmation  
Selected Device: Built-in-DVD+RW  
All data on the disc will be erased.  
Exported Required Size = 11 MB  
Real Export Range:  
From: 2008/11/07 AM10:41:13  
To: 2008/11/07 AM10:41:21  
Enter: YES ESC: NO  
or  
Press CHN to assign  
Digital Deterrent File Sound\_N

- If there is no exportable external device connected to the DVR unit, then a warning message will be shown on the screen, as the following.

No exportable device detected.  
Please install the target device/media  
to the DVR.  
Enter: Retry ESC: Exit  
or  
Press CHN to assign  
Digital Deterrent File Sound\_N

- Press channel keys 1 to 16 to set the audio of the selected time as the Digital Deterrent files 1 to 16.
- If the duration exceeds 10 seconds, the following warning message will be shown:

Warning!!  
Exceed the limitation (10 seconds)!  
Only the first 10 seconds data is  
used to create sound file  
ENTER: Yes ESC: No

- Press ENTER to set the first 10 seconds audio as the Digital Deterrent file; or press ESC to abort.

## 5.7 Database Setup

The menu displays information regarding internal and external disks. In the Main menu, move the cursor to <Database Setup> and press ENTER. The following menu is displayed.

Database Setup	
Total Size	xxx GB
Free Size	xxx GB
Avail. Rec Time	3Days 7Hrs
Est. Rec Period	5Days 7Hrs
Internal Disks	
External Disks	
NAS Device	



**NOTE:** If the hard disk detected has failed, the message “HDD fail” will be displayed.



**NOTE:** The information of the internal / external HDD can be retrieved with the <Health> function when the DVR is monitored via the **Central Management System (CMS)** software. Please refer to the CMS user's manual for more details.

### 5.7.1 Total / Free Size of HDD

The Total Size of HDD shows the total capacity of the HDD that has been added into database. The Free Size of HDD indicates the free space left for recording onto the HDD in database. The information is “read-only”.

### 5.7.2 Avail. Rec Time

The Avail Rec Time indicates the available duration for recording. If the unit is set to record in circular mode, the item will show “Circular”. The information is “read-only”.

### 5.7.3 Est. Rec Period

This item displays the estimated total recording duration, according to the current recording settings. The information is “read-only”.

## 5.7.4 Internal / External Disks

Select <Internal Disks> or <External Disks> to see information about the storage devices connected to the unit. The submenu is displayed as below.

Internal Disks		
Name	Active	Action
xxx xxxxxxxx-xxxxxx	Yes	None

The information about any built-in HDD and external storage devices will be listed by model name and status. If no storage device connects to the unit, the message "No Available Items!" will show on screen.



**NOTE:** If the file system of the internal HDD is not compatible for the DVR, the system will format the internal HDD automatically without notice.

### <Active>

This item indicates if a storage device is added into the database or not. <Yes> means the device has been added into database.

### <Action>

This item allows the user to add a storage device to the database or to remove a device from the database.

The options are <None> (no action), <Add> (add the selected device into database), <Remove> (remove the selected device from database), <Format> (format the selected device), and <Repair> (renovate the selected device).



**NOTE:** Before removing external devices from the unit, remember to remove the device from database.

## 5.7.5 NAS Device

The DVR can connect Network Attached Storage (NAS) devices to expand the size of the database. Before connecting the NAS device, the DVR has to be shut down. After the NAS device is connected and the DVR is rebooted, access <Database Setup> → <NAS Devices> and the menu will be displayed as below. The items <Active> and <Action> is the same as in Internal / External Disks menu.

NAS Devices			
Device Name	Active	Detail	Action
xxxxxxxxxxx	Yes	Yes	None

### Detail

Set this item to <Yes> and the detailed information of the NAS device will be shown on the monitor. Refer to the following for an example. The information is “read only”.

NAS Detailed Info			
Device Name: xxxxxxxxxxxx			
IP: 192.168.50.2			
Port: 8080			
Netmask: 255.255.255.0			
Storage Status			
Index	Status	Free Size	Total Size

## 5.8 Configuration

The Configuration menu can be used to restore the default factory settings, import and export configurations. Select <Configuration> from the Main menu and press ENTER. The following menu is displayed. Items in this menu are described in the following subsections.

Configuration	
Load Factory Default	No
Import Config	
Export Config	
Import Deterrent	
Export Deterrent	
Boot Log	
Operation Log	On

## 5.8.1 Load Factory Default

This item is used to load the factory default setting. Select <Yes> to recall the factory default setup configuration from the “read-only” memory, or select <No> to cancel.

## 5.8.2 Import Configuration

This item allows the user to load a unit configuration that was saved on an external drive. To import a configuration that was previously exported, make sure the device that saved the configuration is connected to the unit. Select <Import Config> from the Configuration menu and press ENTER. The following menu is displayed.

Import Config	
Config Name	Select
xxxx-xxxx	No
xxx-xx	No

Press UP / DOWN to select one of the available listed configuration files, and choose <Yes> to start importing.



**NOTE:** If the imported configuration has a different record mode from the unit's, the warning message “This config has different record mode. This will FORMAT ALL HARDDISKS.” will show.



**NOTE:** Remove the ThumbDrive® used for importing configuration after the unit restarts, or it will be formatted as well.

## 5.8.3 Export Configuration

The account with appropriate privilege can save a unit configuration by exporting it to an external drive, such as a USB Flash Drive. Before exporting the configuration, make sure the device in which the configuration will be saved is attached to the unit properly. Select <Export Config> from the Configuration menu and press ENTER. The following menu is displayed. Items in this menu are described in the following sections.

Export Config	
Copy Destination	
Config Name	
Begin Export	No

### 5.8.3.1 Copy Destination

Select this item to list available destinations (external memory devices) to which the configuration can be exported. Press UP / DOWN to set a destination. Please note that saving a different configuration to the same copy destination with the same file name will overwrite the previous configuration file without warning.



**NOTE:** Users are not allowed to select DVD+RW as a copy destination.

### 5.8.3.2 Configuration Name

This item allows the user to assign the exported configuration file a name. Use the virtual keyboard to enter the configuration file name.

Note that the file name can contain up to 15 characters, with no spaces.

### 5.8.3.3 Begin Export

Select <Yes> to begin exporting the configuration file, or <No> to abort the export.



**NOTE:** We strongly recommend users to export configurations before upgrading your system, and back it up routinely, just in case an unexpected situation occurs.

## 5.8.4 Import Deterrent

This item allows the user to import predetermined sound files saved in an external drive. The files should be ADPCM format and has to be named in the format as "Sound\_N", where N represents numbers 1 to 50. To import sound files, make sure the device that saved the sound files is connected to the unit. Select <Import Deterrent> from the Configuration menu and press ENTER. The following menu is displayed.

Import Deterrent	
Device Name	Select
xxxx-xxxx	No
xxx-xx	No

Press UP / DOWN to select the device containing the sound files, and choose <Yes> to start importing sound files.



## 5.8.5 Export Deterrent

The sound files stored in the DVR can also be exported. Select Export Deterrent menu and the following will be displayed.

Export Deterrent	
Config Name	Select
xxxx-xxxx	No
xxx-xx	No

Press UP / DOWN to select one of the available devices, and choose <Yes> to start importing sound files to the designated device.

## 5.8.6 Boot Log

Select <Boot Log> and a list of system logs will be displayed on the screen. Users can export the system log as a data file to an external storage device. Connect a USB storage device and press COPY to export the system log file to the USB storage device. In the mean time, a digital signature file will also be exported.

## 5.8.7 Operation Log

Set <Operation Log> to <On> and operation logs will start to be recorded in the system log. Alternatively, set to <Off> and operation logs will not be part of the system log.

## 5.9 Video Export

The Video Export menu enables only the accounts with proper authority to export recorded video with digital signature to a USB ThumbDrive® or a DVD+RW drive. Login with a proper account to export video.

If the <Pre-Alarm Recording> function is enabled, the event video will be exported into two files, including pre-alarm video and video recorded after the alarm is triggered.

Each recorded video will be exported automatically into four files when exporting with a digital signature, including \*.gpg, \*.drv, \*.sig and readme.txt. To export a 1GB file with a digital signature, it may take you about 30 minutes.

From the Main menu, select <Video Export> and press ENTER. The following menu is displayed.



**NOTE:** The inserted DVD will be ejected when its capacity is 99% full.

Video Export			
Select Device			
Select Ch:	CH1	CH2	CH3 CH4
From	2008/03/19 AM 07:50:05		
To	2008/03/28 PM 03:09:18		
Select Events			
Data Type			Normal
Export Format			DRV
Digital Signature			No
Erase Disc			No
Begin Export			No

Items in the menu will be described in the following section.

## 5.9.1 Select Device

The external devices that are available for exporting video will be listed by name and free space size in Select Device menu. The Select Device menu displays as follows.

Select Device			
Device Name	Available	Sel	
xxx-xxx-x-x-xx	256 MB	No	
xx-xxx-xx-xxxx	1.5 GB	No	

The **DVR-4TH/ 8TH/ 16TH** series unit only supports EXT3 file system. If you connect an external HDD to the unit, ensure that the format of HDD is EXT3.

### <Device Name>

This item shows the name of the available device.

### <Available>

This item shows how much free space is available on the device.

### <Sel>

Set this item to <Yes> to set it as an exporting destination; or <No> to cancel.



**NOTE:** This last menu item <Erase Disk> will be grayed out when selected device is not a DVD recorder or not select yet.

## 5.9.2 Select Channel

The item is used to select channels for export. Move the cursor to the desired channel using LEFT / RIGHT keys, then select or de-select a channel by pressing ENTER.

## 5.9.3 From / To Time

The items are used to set the time which data export begins and ends. Move the cursor using Direction keys, and press ENTER to select the date / time items; adjust the selected date and time value by UP / DOWN keys.



**NOTE:** When the Start / End Time are set, remember to select the exporting Data Type.

## 5.9.4 Select Events

Select this item to display the available event video list for exporting. Move the cursor to scroll down the event list and press ENTER to select the event you want to export.

## 5.9.5 Data Type

The item is used to select export video type. The options are <Normal> (export normal video only), <Event> (export event video only) and <Both> (export both normal and event video).



**NOTE:** If you want to export selected event video using the item <Select Event>, you have to set <From> and <To> for the same day and time; otherwise, not only the selected event video will be exported to the selected destination, but also any other event video recorded during the period between <From> and <To>.



**NOTE:** You will not be allowed to access the <Select Events> if the Data Type is set to <Normal>.

## 5.9.6 Export Format

This item is for selecting exporting video format. The options are <DRV> and <AVI>.

The \*.drv file can only be played back with **SpecoRemote** and **SpecoPlayer**, and multiple camera video can be played from one file. The \*.avi file can be played back with Windows Media Player. Note that if multiple channels are exported, each channel is exported to a separate file.

## 5.9.7 Digital Signature

The Digital Signature function enables the user to export a video clip with the unit's unique signature key. It aims to authenticate a video clip exported from the unit and prove it has not been modified. The user can export a video clip with or without a digital signature file (\*.sig). Set the item to <Yes> to export with the signature file, or <NO> to export without the signature file.

Make sure that you have an external storage device, such as a USB Hard Drive or USB ThumbDrive<sup>®</sup>, available and connected to the appropriate port for export.

For more information on verifying digital signature, see appendix [\*\*Verifying Digital Signature\*\*](#).

## 5.9.8 Erase Disc

This function is used to remove information found on a DVD+RW disk prior to exporting new information to the drive. Select <Yes> and press ENTER to start deleting data.



**NOTE:** This menu item will be grayed out when selected device is not a DVD recorder or not select yet.

## 5.9.9 Begin Export

Select <Yes> and press ENTER to start exporting.

## 5.10 POS Setup

The <POS Setup> function provides a connection between the DVR and one Point-of-Sale device such as cash registers. With this function, the financial transaction data can be linked to specific camera images and recorded to your DVR.

If there is need to connect two or more Point-of-Sale devices, Data Converter is required. For detailed information about how Data Converter works, please refer to “**POS Solution Guide**” provided within the Data Converter package.

To enable this function, enter OSD Setup menu using account name and password with appropriate privilege, and then select <POS Setup>. Press Enter and the following OSD setup menu will show up.

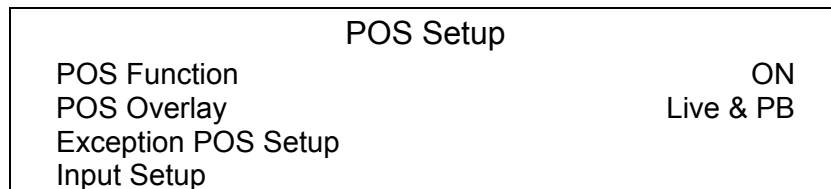

Items in this menu are described in the following subsections.

### 5.10.1 POS Function

This item is used to enable/ disable this function. Select <ON>, the text database will be created on the hard disk.

### 5.10.2 POS Overlay

This item is for you to choose which mode you want to display the POS overlay on the monitor. Select <Live> to display the POS overlay in Live mode; select <PB> to display the POS overlay in Playback mode; and select <Live & PB> to display in both Live and Playback modes.



**NOTE:** POS overlay only shown in full screen mode.



**NOTE:** PB overlay is available only under x1 PB speed.

### 5.10.3 Exception POS Setup

This sub-menu is used to define the conditions that are to be treated as an “Exception” and thus trigger an action (the function will be implemented later).

Exception POS Setup	
Exception No.	1
Trigger	ON
Exception String	NO SALE
By Numerals	OFF
Value	
Value (Upper Limit)	

#### 5.10.3.1 Exception No.

Select an exception for further settings; you can select from <1> to <16>.

#### 5.10.3.2 Trigger

Select <ON>, those transactions which contain “Exception Strings” and which meet the “Numerals” conditions will be marked as exceptions in the text database and will trigger preset actions such as alarm output.

#### 5.10.3.3 Exception String

The user can enter this item to define Exception String. The “Exception String” is case-sensitive. Only exactly matched ones will be marked as exceptions.

#### 5.10.3.4 By Numerals

“Exception String” must be defined before “By Numerals” takes effect. If “By Numerals” is enabled, only transactions that meet both “Exception String” and “By Numerals” condition will be marked as exceptions and trigger an action.

You can select from below options:

**<OFF>**: The function is disabled.

**<Specific>**: That the value of transaction meets a specific value will be marked as an exception. That specific value need to be configured through the following sub-setting <Value>,

**<Greater Equal Than>**: That the value of transaction is greater than or equal to certain value will be marked as an exception. That specific value need to be configured through the following sub-setting <Value>,

**<Less Equal Than>**: That the value of transaction is less than or equal to certain value will be marked as an exception. That specific value need to be configured through the following sub-setting <Value>.

**<Inside The Range>**: That the price of transaction is within certain range will be marked as an exception. The range need to be configured through the following sub-settings <Value> and <Value (Upper Limit)>.

**<Outside the Range>**: That the price of transaction is outside certain range, will be marked as an exception. The range need to be configured through the following sub-settings <Value> and <Value (Upper Limit)>.



**NOTE:** Only transactions (1) after “Exception Strings” and “By Numerals” are set and (2) after “Trigger” is <ON> will be marked as exceptions in text database. The data stored before won't be marked as exceptions.

## 5.10.4 Input Setup

This item is used to choose the connection method that is between your Text Device and DVR, and setup some relative settings of the connection method.

Input Setup	
Port Selection	Serial Port
Input Source	Direct Connected
Camera Selection	1
Text Filter	ASCII
Manual Filter Setup	
Input Process	Canonical
Text Baud Rate	9600
Text Bits	8
Text Stop	1
Text Parity	None

### 5.10.4.1 Port Selection

It is essential to select a port for either the POS/cash register or modem when the POS function is set on. Meanwhile, also check whether the device is connected to the port selected.

Port Selection	
Serial Port	Text
USB Port-Front	None
USB Port-Rear Top	None
USB Port-Rear Bottom	None

### 5.10.4.2 Input source

Select whether the input source is direct connected or connected with the Data Converter. If the input source is direct connected, users may need to go to the next item: Camera Selection to select a corresponding camera number.

### 5.10.4.3 Camera Selection

Select a camera to display the POS overlay.

### 5.10.4.4 Text Filter

This item is used to choose the text filter. The supported models for pole display and printer are listed below.

Pole Display	Printer	POS Machine
Cache Technology VFD-202T	Citizen CBM-1000 II	Acula AQ-812
Citizen C2202	Citizen CT-S300	IBM SurePOS 700
Digipos CD5220	Dell T200	Samsung ER-380M
Emax Pole Display	Epson TM-T88II/ TM-T88III/ TM-T88IV	Samsung ER-655
Epson DM-D Series	Epson TM-T90	Senor POS
Logic Controls LD9000	Epson TM-930 II	
Logic Controls PD3000	Epson RP-U420	
Logic Controls PD6000	IBM SureMark TF6	
Logic Controls TD3000	IBM SureMark TM6	
Magellan	Ithaca iTherm 280	
Partnertech CD5220	Ithaca POSJet 1000	
Posiflex ICD-2002	POS-X Xr500	
Posiflex PD 302	Samsung SRP350	
Posiflex PD 303	Sensor TP-288	
Posiflex PD-2100	Star TSP100 futurePRNT	
Posiflex PD-2200	Star TSP600	
POS-X Xp8000	Star TSP700	
Scales	Star TSP800	
Sibnet	TPG (Axiohm) A794	
STAR SCD400-PD	WP-520(ESC/POS)	
Soteke VFD2025		
Soteke VFD2029		
TEC		
Toledo 8217		
TYSSO VFD Series		
Ultimate Technology PD1100XL		
Wedderburn DS-770		



#### **5.10.4.5 Manual Filter Setup**

Once enter the Manual Filter Setup menu, users should key in hexadecimal digits. The menu of the item is shown as follows.

Manual Filter Setup	
Header 1	30
Header 2	30

#### **5.10.4.6 Input Process**

If you will be using a Pole Display from a PC based POS, select <Canonical>. <Non-Canonical> is to be selected when using a Pole Display from a Standalone POS.

#### **5.10.4.7 Text Baud Rate**

To setup the baud rate of RS232 via which to connect your Text Device and DVR.

#### **5.10.4.8 Text Bit**

Setup the bits of RS232.

#### **5.10.4.9 Text Stop**

Setup the stop of RS232.

#### **5.10.4.10 Text Parity**

Setup the parity of RS232

## 5.11 Shutdown

This item is used to shut down or reboot the unit. If you must shut down the **DVR-4TH/ 8TH/ 16TH** series unit for any reason, please use the proper shut down and power up procedures to avoid damage to your unit.

Select <Shutdown> in Main menu and press ENTER to access the Shutdown menu, which displays as follows.

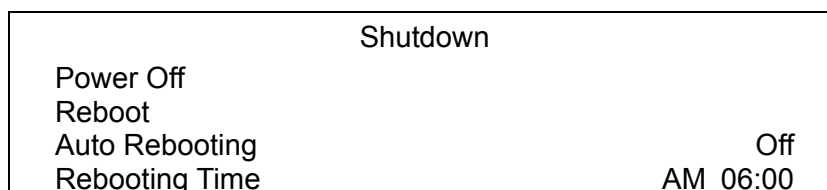

### 5.11.1 Power Off

Select this item to shut down the unit. **Do not remove the power** during shut down until the message “You can safely turn off DVR now!” displays.

### 5.11.2 Reboot

Select this item to reboot the unit. The color bar and system checking information are displayed on the monitor until the unit is completely restarted.



**NOTE:** While the **DVR-4TH/ 8TH/ 16TH** series unit is shutting down or rebooting, the recoding and playback of videos will stop to avoid abnormal images.

### 5.11.3 Auto Rebooting

The **DVR-4TH/ 8TH/ 16TH** series unit can be set to reboot automatically once a day/week at predetermined time in order to keep the DVR system more stable. Select <Off> to disable the auto rebooting function.

### 5.11.4 Rebooting Time

If the auto rebooting function is enabled, select a desired time to perform the auto rebooting function.

## 6. Remote Monitoring Software

The remote monitoring software is a remote browser-based software application designed to operate with the DVR products. Using the software, users are allowed to view live and recorded video, and configure the DVRs remotely via a LAN, WAN or Internet on a personal computer.

The connected PC will automatically download the remote monitoring software plug-ins from the DVR when the DVR is connected by entering its IP address in the address bar on the browser.

Due to the setting items are similar to those listed in the DVR's OSD setup menu, please refer to the sections above for setting configuration of the remote monitoring software.

The tasks can be performed with the remote monitoring software are listed below:

- Remote viewing of live/ recorded video
- Remote setup of the DVR
- Remote control of dome cameras
- Alarm notification from the DVR
- Up to five connections to one DVR using the remote monitoring software, including the preset "admin" and four other accounts

### 6.1 Remote Monitoring System Requirements

Items	Requirements
<b>Personal Computer</b>	<b>Minimum:</b> Intel® Pentium® M CPU 1.40GHz RAM 512 MB
	<b>Recommended:</b> Intel® Core™2 Quad CPU Q6600 @ 2.4GHZ RAM 2 GB
<b>Hard Disk Drive</b>	Requires 20 MB for software installation
<b>Operating System</b>	Windows XP, Windows Vista
<b>Web Browser</b>	Microsoft Internet Explorer version 6.0 or above
<b>Monitor Resolution</b>	Minimum 1024 x 768 with 16-bit color
<b>Network Card</b>	10Base-T (10 Mbps) or 100Base-TX (100 Mbps) operation; must match the network configuration

## 6.2 Software Installation

Refer to the following description to install the remote monitoring software.

### 6.2.1 Change Internet Settings

The PC operating with the remote monitoring software should be set to accept ActiveX plug-ins. Please follow the steps to set the Internet security settings appropriately.

- Before operating the remote monitoring software, please check the IP address of the DVR. To check the IP address, press MENU key on the unit and enter username and password to access OSD setup menu. Select <System Setup>, <Network Setup>, then <LAN Setup> to check the IP.
- Start the IE; it can be started either by clicking on the desktop icon, or by using the Start menu to access it.



**NOTE:** Windows IE provides the ActiveX component that is required when using the remote monitoring software.

- Select <Tools> from the main menu of the browser, then <Internet Options>, and then click the <Security> tab.
- Select <Trusted sites> and click <Sites> to specify its security setting.

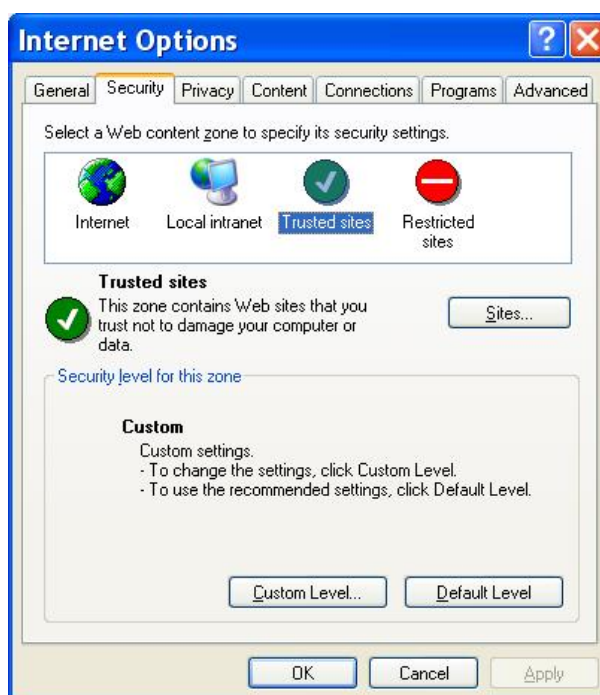

- Uncheck “Require server verification (https:) for all sites in this zone”. Type the IP address of the unit in field and click <Add> to add this web site to the zone.

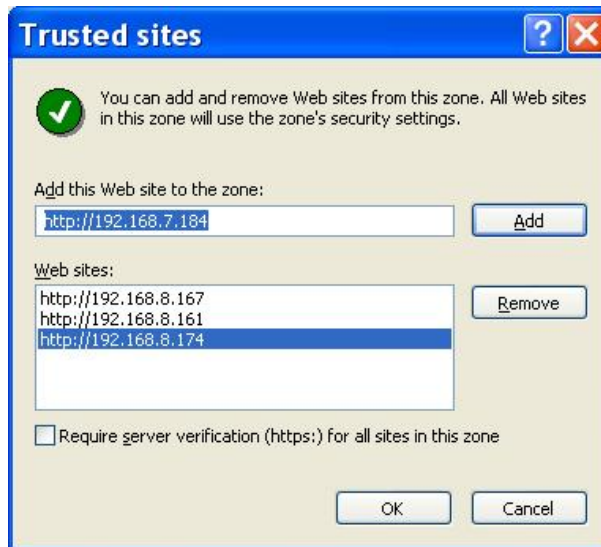

- Click <OK> to confirm the setting and close Trusted sites dialog.
- In the Security Level area, click <Custom Level>. The Security Settings screen is displayed.



- Under <ActiveX controls and plug-ins>, set all items to <Enable> or <Prompt>.
- Click <OK> to apply the setting and close the <Security Settings> screen.
- Click <OK> to close Internet Options dialog.

Now the installation can continue to the next step.

## 6.2.2 Install Remote Monitoring Software

Start the browser to initiate the installation of the remote monitoring software on the PC. The IP address of the DVR can be saved as a Favorites item in the web browser to enable easy access in the future.

- Start the IE; it can be started either by clicking on the desktop icon, or by using the Start menu to access it.
- Enter the IP address of the DVR in the address bar at the top of the browser.
- The ActiveX controls and plug-ins dialog will show twice for confirmation; click <Yes> to accept ActiveX plug-ins. The remote monitoring software plug-ins will be downloaded and installed on the PC automatically when the connection is successfully made.



**NOTE:** Do not enter any leading “0” characters in the address, for example, “192.068.080.006” should be entered as “192.68.80.6”. If the default trigger port 100 is changed into another one, take port 81 for example, the IP address should be entered as “192.68.80.6:81”.



- A version check starts to verify whether the remote monitoring software was installed already, and also check if the version is the same as that stored in that particular DVR. This process may take up to 30 seconds.
- When the software is completely downloaded and installed, the Login Screen is now displayed.



### 6.2.2.1 Login / Logout

Login using the same accounts setup in the DVR. The authority is also the same as setup in the DVR.

One preset account “admin” and up to four other accounts can access a DVR at the same time. Nevertheless, if the “admin” account is currently accessing the unit’s OSD setup menu via front panel of the unit, then the “admin” account at the remote monitoring site cannot change the settings at the same time. The “admin” account of the DVR has priority.



The following steps demonstrate procedures to view video from remote unit:

- Start the remote monitoring software by entering the IP Address of the DVR in the Address bar of the browser. Alternatively, click on the Favorite entry for the unit (if the IP address of the unit has been set).
- Enter the Username and password. The login username and password can be saved to ease future login. The default username and password is **admin / 1234**.
- Click <OK> to log in to the DVR. The process may take a few seconds.
- If the connection is made successfully, the main window will display live video of the attached cameras.

If the IE browser is closed, the remote system is logout and disconnected from the DVR at the same time.

### 6.2.2.2 Software Upgrades

If a new version of the remote monitoring software is available on the DVR, upgrade will be prompted while accessing the unit. Follow the steps to upgrade the software.

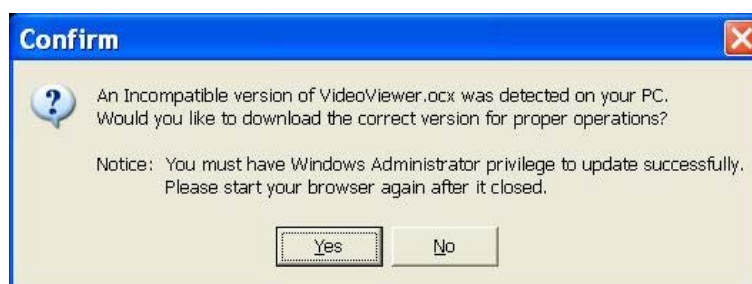

- The message as the above figure will be prompted. Click <Yes> to accept version upgrade.
- Start the IE again and enter the IP address of the DVR in the Address bar of the browser; or if the unit address is set as a Favorite site, click the Favorites entry for the unit.
- When the software is completely downloaded and installed, the Login Screen will be displayed.

## 6.3 Basic Operation for Remote Monitor

When a DVR is successfully connected, the main window of the remote monitoring software will be displayed. Please refer to the **Setup Guide** for the graphical illustration of functional items.

The functions on the remote monitoring software will be described in the following sections.

### 6.3.1 View Live Video

View live video from the cameras attached to the DVR by clicking <Live> button on the main window toolbar. Choose desired display mode – full-screen, 2x2 windows, 3x3 windows, and 4x4 windows – after the live images of the DVR are displayed on the main window. When a dome camera is connected and viewed in single channel full-screen mode, the dome camera control operation can be accessed. To choose desired display mode and to operate dome camera control, refer to the following sections.



### 6.3.1.1 **Select Display Mode**

Choose the number of windows to be displayed on the main window. Click one of the display buttons in MODE section. Available selections are 4, 9 and 16 camera displays. To view certain window in full screen, either double-click on the wanted window, or click on the corresponding CAMERA button.

### 6.3.1.2 **Operate Cameras with Dome Control**

The remote monitoring software allows users to control and configure a dome camera remotely.

Click on any CAMERA button displayed with a dome icon to view the camera in full screen. The Dome Control Panel will be displayed on the main window. The items on the Dome Control Panel are described as follows.

#### **Set Preset (•)**

Set Preset is used to set up preset positions. The remote monitoring software allows its user to set up to 255 preset positions with DynaColor, American Dynamics, Fastrax, JVC, Panasonic (C & N), and Pelco (Pelco P & Pelco D) domes.

Use Direction buttons to move dome camera to an appropriate position, and then click the button and choose wanted number from the pull-down list. The preset position is named as the selected number.

#### **Go Preset (•←)**

Go Preset is used to call the camera preset point, which was set up with the set preset point function. Click and choose a number to call the preset point for viewing.

#### **Auto Focus (A.F.)**

Click on it and the focus of the camera will be automatically adjusted to show a clearer image.

#### **Dome ID (ID)**

Click for changing the dome ID and protocol. Proper authority is required to access this function.

**Focus +/-**

Use to adjust the camera lens to focus on objects for a clear view. Click on <Focus +> to focus near or <Focus -> to focus far.

**Iris +/-**

This item is used to open and close the iris to let more or less light into the camera. Click on <Iris +> to open iris or <Iris -> to close iris.

**Zoom +/-**

Users are allowed to zoom-in or zoom-out using the adjusting buttons. Zoom-in to enlarge a certain area and zoom-out to view more area.

**Direction Button**

This button is used to pan and/or tilt the dome camera. Click the arrows in the directions to be viewed.

## 6.3.2 Instant Recording

The Instant Recording function allows users to record video quickly to the PC.



**NOTE:** The Audio function is set to OFF as the default setting.

### 6.3.2.1 Record Video Instantly

Follow the steps to start recording instantly:

- Click on the <Instant Recording> button.
- Select the destination folder to save the video.
- Click on the button again to stop recording.



**NOTE:** The instant recording video will be saved as \*.drv file.

### 6.3.2.2 Playback Instant Recorded Video

Follow the steps to playback a video recorded by “Instant Recording”.

- Click <Play> on main window toolbar and click <Local Playback> tab.
- Click <Open> to choose a recorded file.
- Click <OK> to start playing the recorded video.

### 6.3.3 Playback Video

The remote monitoring software allows users to either view recorded video from the DVR, or from the hard disk drive of the PC.

To access the Playback screen, click <Play> button on the main window toolbar. There are three tabs in the Playback screen: <Remote Playback>, <Local Playback>, and <Verify> tabs. <Remote Playback> allows users to play back from the DVR. <Local Playback> enables users to playback a recorded video file stored on the hard disk drive of the PC. <Verify> is provided for users to authenticate if the exported video is altered.

The DVR continues recording while playing back recorded video on the PC, either remote playback or local playback.

#### 6.3.3.1 Playback Remote Video

To view remote video, click <Play> on the main window toolbar, and then <Remote Playback> tab. The <Remote Playback> screen will be displayed.

The <From> and <To> in the <Available Record Video> display the date and time from which recorded video is available for playback.

To playback remote video segments, follow these steps:

- Choose <Playback> in <Select> field for playback recorded video.
- In <Start> field, users can change the date and time either by typing desired numbers directly or by using the arrow buttons.

**To type directly:**

Click on day, month and year of date field respectively, and type the desired numbers directly. Follow above steps to adjust the hour, minute and second of time field.

**To use the arrow buttons:**

Click on the arrow button next to the date field to display the calendar; then click the left and right arrow at the top of the calendar to change the date. Use up and down arrow next to the time field to change to the wanted time.

- The other way to select date and time is by moving the blue sliding bar.
- Click <OK> to start the playback, or click <Close> to abort.

- The other option <Download (.DRV)> in <Select> field enables users to download the video segment of selected date and time to the PC. The selection of time duration is the same as described above. Files downloaded will be in \*.drv format.

### 6.3.3.2 Playback Local \*.drv Files



The <Local Playback> tab allows users to playback \*.drv video files stored in the PC's hard drive.

Follow below steps to playback a downloaded \*.drv file with the remote monitoring software.

- Click <Open> and the file selection screen is displayed.
- Select the \*.drv video file for playback and click <OK>.
- Click <OK> in the <Local Playback> Screen to start the playback, or click <Cancel> to abort.
- View the video playback using the Playback controls.
- To end the playback, click <Live> to return to live video.

### 6.3.3.3 Playback Controls

When the local or remote video is being played, the remote monitoring software is in Playback Mode. The playback controls toolbar will emerge on the main window toolbar. The Playback controls and indicators are described as below.

Icon	Name	Description
	<b>Fast Backward</b> / <b>Step Backward</b>	1. Click to play the recorded video in backward direction. Click repeatedly to select the backward playback speed: 1x, 2x, 4x, 8x, 16x, or 32x. 2. When playback is paused, click repeatedly to move backward step-by-step.
	<b>Play / Pause</b>	1. While playing, click to pause the playback. 2. When paused, click to resume the playback.
	<b>Fast Forward</b> / <b>Step Forward</b>	1. Click to play the recorded video in forward direction. Click repeatedly to select the forward playback speed: 1x, 2x, 4x, 8x, 16x, or 32x. 2. When playback is paused, click repeatedly to move forward step-by-step.

### 6.3.4 Verify Digital Signature

The digital signature aims to authenticate a video file exported from the unit. Follow the description to verify the digital signature.

- Click <Play> on the main window toolbar.
- Click <Verify> tab to display the Verify window.
- Click <Browse> to select the \*.gpg, \*.avi, \*.sig files respectively, which belong to the exported video to be authenticated.
- Click <Verify> to start verifying digital signature.
- The result of verify shows in the <Status Log> field. It returns a GOOD or BAD signature result. A GOOD signature indicates the exported clip has not been altered.

### 6.3.5 Search from Event List

Click SEARCH, the Event List appears. The List contains information about the alarm events that the unit recorded and saved. Up to 1024 events can be listed in the Event List.

The Event List displays each event by its number, the date and time of the event, the type of the event (including Alarm In, Motion Detection, and Video Loss), and the camera channel where the event occurred.

To view an event video, follow these steps:

- Click SEARCH button positioned in the main window toolbar. The Event List appears.
- Scroll through the Event List and highlight the interested events.
- Double-click on the desired event to view the event video.

### 6.3.6 Take a Snapshot

Snapshot is a simple screen capture tool. When users click on the SNAPSHOT button, it will capture the screenshot of the window that is currently showing on the screen. Each click captures one screenshot to be saved as a JPEG file on the desktop. The snapshot file will be named as "Snapshot-\*".

### 6.3.7 Health Status of HDD

This function verifies HDD status of the DVR. The information items shown in the chart are described as below:

#### **Device Name**

This item shows the model name of the HDD.

#### **Int./Ext.**

This item indicates whether the HDD is an internal or external device.

#### **Total Size**

This item indicates the total size of the HDD.

#### **State**

This item indicates whether the HDD is active or non-active.

#### **Temperature**

This item indicates the current temperature of the HDD in Celsius degree.

### 6.3.8 Normal and Dual Streaming

For different networks with different bandwidths, two streaming options are provided – normal and dual streaming. The preset is normal streaming.

Users who are using high-speed networks, normal streaming will be a recommended choice. Depending on the HDD capacity and network usage, set the remote monitoring software to occupy high or low bandwidths.

For networks with limited bandwidth, dual streaming will be a better choice. It enables coexistence of high quality streaming at local DVR site and lower quality streaming but faster transmission for the remote monitoring site. To select dual streaming, click on the bandwidth icon and the icon will change color. Then users can furthermore choose different bit rates to adjust for the best displaying quality.



**NOTE:** for S models, dual streaming function is available only for H.264 and MJPEG recording mode. for all other models, there is no limitation.

## 6.3.9 Remote Monitoring Software Trouble Shooting Guide

What happened if the server requests to upgrade the software every time the DVR is connected? If the following screen displays repeatedly, please follow the steps to delete the temporary internet files.



- Select <Tools> from the main menu of the web browser, then <Internet Options>, and then click the <General> tab.

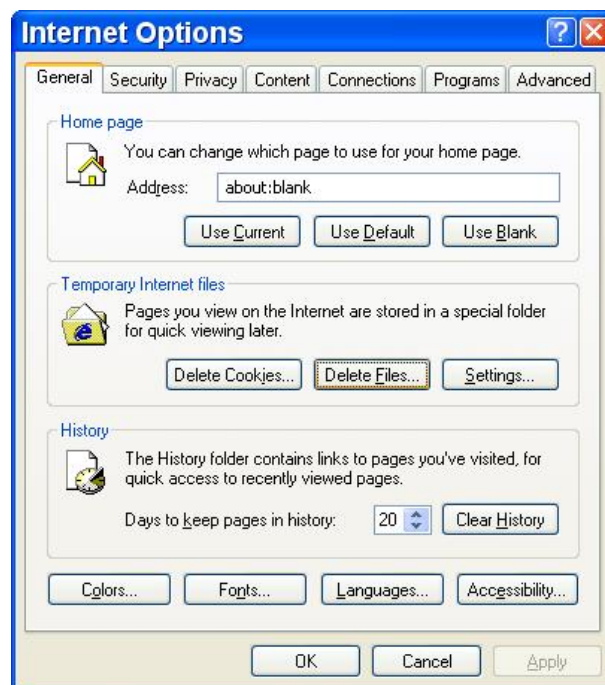

- Click the <Delete Files> button in the <Temporary Internet Files> field; the <Delete Files> screen displays as below.

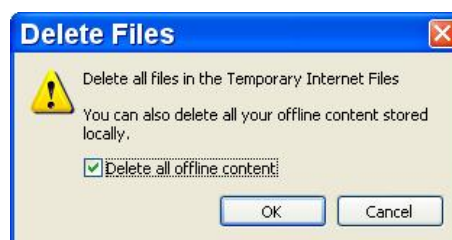

- Check the <Delete all offline content> box and click <OK>.
- Now, enter the IP address of the DVR to make the connection again.

## Appendix A: Technical Specifications

Speco Technologies is constantly developing product improvements. We reserve the right to modify product design and specifications without notice and without incurring any obligation.

Function		4CH	8CH	16CH		
Video	Operation System		Embedded ( Linux )			
	Video Standard		NTSC/PAL switch selectable			
	Video Operation		(Live, Record, Playback , Remote, and Internet access			
	Resolution – Live Video		NTSC: 720 x 480 pixels PAL: 720 x 576 pixels			
	Input		BNC x 4, 1.0Vp-p/75 ohm	BNC x 8, 1.0Vp-p/75 ohm	BNC x 16, 1.0Vp-p/75 ohm	
	Outputs	Main Monitor	BNC x 1, S-Video x 1, 1.0Vp-p/75 ohm			
		Call monitor	BNC x 1, 1.0Vp-p/75 ohm			
		Loop	BNC x 4, 1.0Vp-p/75 ohm	BNC x 8, 1.0Vp-p/75 ohm	BNC x 16, 1.0Vp-p/75 ohm	
	Digital Display Output		800 x 600, 1024 x 768, 1280 x 1024, 720p pixels			
	VGA Output		800 x 600, 1024 x 768, 1280 x 1024, 720p pixels			
	Picture Refresh Rate		NTSC: 480 PPS(16CH) PAL: 400 PPS(16CH)			
Digital Zoom		2 x 2				
Camera Installation		Plug & Play				
Audio	Input		16, Line-In			
	Main Output		RCA x 1, Line-Out			
	Output		16, Line-Out			
	Recording Mode		Always Real Time Record, Synchronized w/ Video			
	Compression Method		ADPCM, G.726			
	File Size		8KB/Sec			
	Operation		Remote + VCR mode			
	Playback		Only for Video Original Speed			
Recording	Compression Method		H.264, MPEG-4, and MJPEG			
	Recording Mode		Schedule, Alarm, Motion Detection			
	Pre-Alarm		0~30 sec			
	Resolution & Rate	NTSC	720x480:	H.264= 60 pps,	MPEG4=120 pps,	MJPEG=120 pps
			720x240:	H.264=120 pps,	MPEG4=240 pps,	MJPEG=240 pps
			352x240:	H.264=240 pps,	MPEG4=480 pps,	MJPEG=480 pps
		PAL	720x576:	H.264= 50 pps,	MPEG4=100 pps,	MJPEG=100 pps
			720x288:	H.264=100 pps,	MPEG4=200 pps,	MJPEG=200 pps
			352x288:	H.264=200 pps,	MPEG4=400 pps,	MJPEG=400 pps
	Recording Quality		8 levels presets, adjustable			
Image Size		2K to 20K Byte/picture				
Storage Mode		Linear/Circular				
Playback	Playback		Play, Stop, Pause, Rewind, Forward, Search			
	Playback Speed Adjustment		Yes: 1X, 2X, 4X, 8X, 16X, 32X			
	Retrieve		Date/Time, Event			
	Data Life Time		Yes(Programmable)			
Storage	Build-in Storage		X4 SATA, HDD/DVD+RW			
	Built-in HDD		Up to 3 built-in HDDs			
	External Storage		NAS via GB and NIC			
	Export		X4 USB2.0 ports, support ThumbDrive <sup>®</sup> , or DVD+RW			



Alarm	Alarm Input	X4, Terminal Block	X8, Terminal Block	X16, Terminal Block
	Alarm Detection	N.C./N.O., Programmable		
	Auditory Alert	Built-in Buzzer		
	Motion Detection	15 X 11 Grid Array, Sensitivity, Trig Level Adjustable		
	Video Loss Detection	Programmable		
	Alarm Relay Output	X2, Terminal Block, 1.0A/24V (Programmable)		
Communication	Network Connectivity	Ethernet RJ-45 connector, 10/100/1000Mbps, supports DHCP/PPPoE/DDNS		
	Remote Control Software	<b>SpecoRemote™</b>		
	Access Control	8 Level Password		
	Remote Operation	Monitoring, Playback, Recording, System Setup, Dome Camera Control		
	RS232C	D-sub 9 pin female		
	RS485	Terminal Block		
	Dome Control Protocol	Speco, Pelco P, Pelco D, Fastrax2, AD422, Panasonic_C, Panasonic_N, DSCP, and JVC		

## Appendix B: Preset Record Configuration

1. The following table shows PPS per channel and picture size of normal and event mode in Full-D1 resolution for **DVR-4TH/ 8TH/ 16TH** series models.

Record Mode: Full-D1 mode (NTSC: 720×480@30PPS) (PAL: 720×576@25PPS)						
Preset Configuration	Normal PPS		Normal Quality	Event Max PPS	Event Quality	Event Active
Best Quality	4CH	NTSC: 7.5 PAL: 6.25	24 KB	NTSC: 15 PAL: 12.5	24 KB	Both (Alarm+Motion)
	8CH	NTSC: 3.75 PAL: 3.125				
	16CH	1~8CH NTSC: 2.75 PAL: 2.12				
		9~16CH NTSC: 1 PAL: 1				
Standard	4CH	NTSC: 7.5 PAL: 6.25	16 KB	NTSC: 15 PAL: 12.5	24 KB	Both
	8CH	NTSC: 3.75 PAL: 3.125				
	16CH	1~8CH NTSC: 2.75 PAL: 2.12				
		9~16CH NTSC: 1 PAL: 1				
Extended Record	4CH	NTSC: 7.5 PAL: 6.25	8 KB	NTSC: 15 PAL: 12.5	24 KB	Both
	8CH	NTSC: 3.75 PAL: 3.125				
	16CH	1~8CH NTSC: 2.75 PAL: 2.12				
		9~16CH NTSC: 1 PAL: 1				
Event Only	0 NTSC (0 PAL)		NA	NTSC: 30 PAL: 25	24 KB	Both
ezRecord	Auto		Auto	NTSC: 30 PAL: 25	24 KB	Both

2. The following table shows PPS per channel and picture size of normal and event mode in Half-D1 resolution for **DVR-4TH/ 8TH/ 16TH** series models.

Record Mode: Half-D1 mode (NTSC: 720×240@60PPS) (PAL: 720×288@50PPS)						
Preset Configuration	Normal PPS		Normal Quality	Event Max PPS	Event Quality	Event Active
Best Quality	4CH	NTSC: 15 PAL: 12.5	12 KB	NTSC: 30 PAL: 25	12 KB	Both (Alarm+Motion)
	8CH	NTSC: 7.5 PAL: 6.25				
	16CH	NTSC: 3.75 PAL: 3.125				
Standard	4CH	NTSC: 15 PAL: 12.5	8 KB	NTSC: 30 PAL: 25	12 KB	Both
	8CH	NTSC: 7.5 PAL: 6.25				
	16CH	NTSC: 3.75 PAL: 3.125				
Extended Record	4CH	NTSC: 15 PAL: 12.5	4 KB	NTSC: 30 PAL: 25	12 KB	Both
	8CH	NTSC: 7.5 PAL: 6.25				
	16CH	NTSC: 3.75 PAL: 3.125				
Event Only	0 NTSC (0 PAL)		NA	NTSC: 30 PAL: 25	12 KB	Both
ezRecord	Auto		Auto	NTSC: 30 PAL: 25	12 KB	Both

3. The following table shows PPS per channel and picture size of normal and event mode in CIF resolution for **DVR-4TH/ 8TH/ 16TH** models.

Record Mode: CIF mode (NTSC: 352×240@120PPS) (PAL: 352×288@100PPS)						
Preset Configuration	Normal PPS		Normal Quality	Event Max PPS	Event Quality	Event Active
Best Quality	4CH	NTSC: 30 PAL: 25	6 KB	NTSC: 30 PAL: 25	6 KB	Both (Alarm+Motion)
	8CH	NTSC: 15 PAL: 12.5				
	16CH	NTSC: 7.5 PAL: 6.25				
Standard	4CH	NTSC: 30 PAL: 25	4 KB	NTSC: 30 PAL: 25	6 KB	Both
	8CH	NTSC: 15 PAL: 12.5				
	16CH	NTSC: 7.5 PAL: 6.25				
Extended Record	4CH	NTSC: 30 PAL: 25	2 KB	NTSC: 30 PAL: 25	6 KB	Both
	8CH	NTSC: 15 PAL: 12.5				
	16CH	NTSC: 7.5 PAL: 6.25				
Event Only	0 NTSC (0 PAL)		NA	NTSC: 30 PAL: 25	6 KB	Both
ezRecord	Auto		Auto	NTSC: 30 PAL: 25	6 KB	Both

## Appendix C: Record Duration

The record duration relates to recording rate, image quality, HDD capacity, and event settings. The following tables give sample calculation of record duration according to different recording rate, image quality, and HDD capacity, excluding consideration of events, for different models with different recording mode. The recording quality refers to the **Normal Qlty** setting of <Per Camera Config> in <Record Setting>, assuming all channel are set to the same quality at all times.

Per Camera Config			
Camera Select	CH1		
	Day	Night	Weekend
Normal PPS	7.5	7.5	7.5
<b>Normal Qlty</b>	<b>Mid</b>	<b>Mid</b>	<b>Mid</b>
Event Max PPS	30	30	30
Event Qlty	Best	Best	Best
Event Act	Both	Both	Both



**NOTE:** Record duration times are based on actual tests and represent average file sizes. Performance may vary depending on specific installations and use. Audio recording requires 8 KB per second (or 0.7 GB per day) for data storage.

Please refer to our recording time calculator on the Speco website for other possible calculations. <http://www.Specotech.com> → Support → Tools

Refer to the following tables for some samples of estimated recording duration of different record modes in H.264 compression.

### Record Duration (Days): Full-D1, Global [Day, Night, Weekend] (without Audio)

Recording Rate		Recording Quality Mode									
Total PPS of all Channels		Low		Fair		Mid		High		Best	
NTSC	PAL	NTSC (8 KB)	PAL (8 KB)	NTSC (12 KB)	PAL (12 KB)	NTSC (16 KB)	PAL (16 KB)	NTSC (20 KB)	PAL (20 KB)	NTSC (24 KB)	PAL (24 KB)
<b>160 GB Internal Storage</b>											
30	25	10.52	12.63	4.79	5.74	276	3.31	1.81	2.17	1.29	1.55
15	12.5	21.04	25.25	9.57	11.49	5.52	6.62	3.62	4.34	2.58	3.09
7.5	6.25	42.09	50.50	19.15	22.98	11.03	13.24	7.24	8.69	5.16	6.19
<b>320 GB Internal Storage</b>											
30	25	21.56	25.87	9.81	11.77	5.65	6.78	3.71	4.45	2.64	3.17
15	12.5	43.12	51.75	19.62	23.55	11.31	13.57	7.42	8.90	5.28	6.34
7.5	6.25	86.25	103.49	39.24	47.09	22.61	27.14	14.83	17.80	10.57	12.68

**Record Duration (Days): Half-D1, Global [Day, Night, Weekend] (without Audio)**

Recording Rate		Recording Quality Mode									
Total PPS of all Channels		Low		Fair		Mid		High		Best	
NTSC	PAL	NTSC (4 KB)	PAL (4 KB)	NTSC (6 KB)	PAL (6 KB)	NTSC (8 KB)	PAL (8 KB)	NTSC (10 KB)	PAL (10 KB)	NTSC (12 KB)	PAL (12 KB)
<b>160 GB Internal Storage</b>											
60	50	20.56	24.68	9.24	11.09	5.26	6.31	3.41	4.09	2.39	2.87
30	25	41.13	49.35	18.49	22.19	10.52	12.63	6.81	8.18	4.79	5.74
15	12.5	82.26	98.71	36.98	44.38	21.04	25.25	13.63	16.35	9.57	11.49
7.5	6.25	164.52	197.42	73.96	88.75	42.09	50.50	27.25	32.70	19.15	22.98
<b>320 GB Internal Storage</b>											
60	50	42.14	50.57	18.95	22.73	10.78	12.94	6.98	8.38	4.91	5.89
30	25	84.29	101.14	37.89	45.47	21.56	25.87	13.96	16.75	9.81	11.77
15	12.5	168.57	202.28	75.78	90.94	43.12	51.75	27.92	33.51	19.62	23.55
7.5	6.25	337.14	404.57	151.56	181.87	86.25	103.49	55.85	67.02	39.24	47.09

**Record Duration (Days): CIF, Global [Day, Night, Weekend] (without Audio)**

Recording Rate		Recording Quality Mode									
Total PPS of all Channels		Low		Fair		Mid		High		Best	
NTSC	PAL	NTSC (2 KB)	PAL (2 KB)	NTSC (3 KB)	PAL (3 KB)	NTSC (4 KB)	PAL (4 KB)	NTSC (5 KB)	PAL (5 KB)	NTSC (6 KB)	PAL (6 KB)
<b>160 GB Internal Storage</b>											
120	100	40.67	48.80	18.18	21.81	10.28	12.34	6.62	7.94	4.62	5.55
60	50	81.33	97.60	36.35	43.62	20.56	24.68	13.24	15.88	9.24	11.09
30	25	162.67	195.20	72.70	87.25	41.13	49.35	26.47	31.77	18.49	22.19
15	12.5	325.33	390.40	145.41	174.49	82.26	98.71	52.95	63.53	36.98	44.38
7.5	6.25	650.67	780.80	290.82	348.98	164.52	197.42	105.89	127.07	73.96	88.75
<b>320 GB Internal Storage</b>											
120	100	83.34	100.01	37.25	44.70	21.07	25.29	13.56	16.28	9.47	11.37
60	50	166.68	200.01	74.50	89.40	42.14	50.57	27.13	32.55	18.95	22.73
30	25	333.35	400.02	148.99	178.79	84.29	101.14	54.25	65.10	37.89	45.47
15	12.5	666.70	800.04	297.99	357.58	168.57	202.28	108.50	130.20	75.78	90.94
7.5	6.25	1333.41	1600.09	595.97	715.17	337.14	404.57	217.00	260.40	151.56	181.87

## Appendix D: Dial-up Connections via Modem

A dial-up modem connection allows the user to use the remote software and receive alarm notice without a direct Internet connection. Following are the steps for establishing the connection between a **DVR-4TH/ 8TH/ 16TH** series unit and a PC.

### Establishing Dial-in Connection

The Dial-in function enables the user to establish dial-up modem communication to and from the **DVR-4TH/ 8TH/ 16TH** series unit for the remote software use. Follow the description to set up your DVR and PC.

#### DVR Configuration:

- Connect a USB modem to the USB socket and connect a working phone line to the modem.
- Press MENU and input username and password with appropriate privilege to access the OSD Main menu. Select <Network Setup> and then <Dial-in Setup> to set up the Dial-In settings, including Dial-in Account and password, etc.
- For more information on dial-in settings, see section **Dial-in Setup**.

#### PC Configuration:

- Click <Start>, <My Network Places>, <View Network Connections> and then select <Create New Connection>. The New Connection Wizard is displayed. Click <Next> to continue.



- Set up the network connection type. Select <Connect to the Internet> and click <Next> to continue.

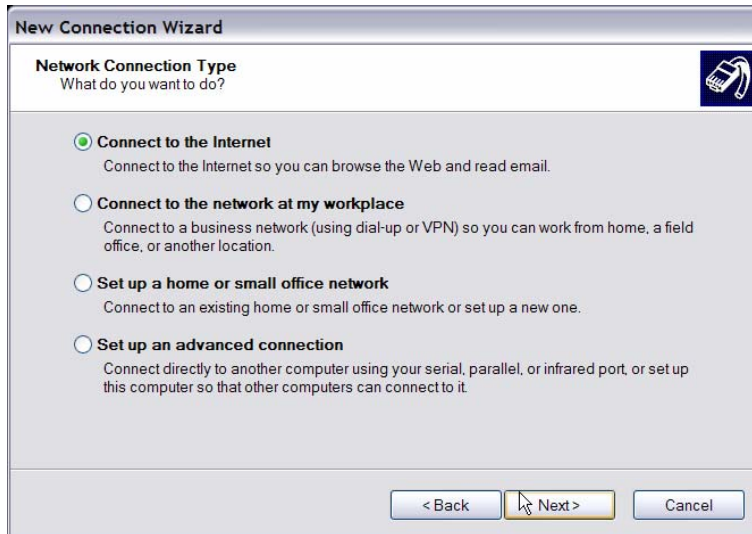

- Select <Set up my connection manually> and click <Next> to continue.



- Select <Connect using a dial-up modem> to connect to the Internet through a phone line and a modem. Click <Next> to continue.

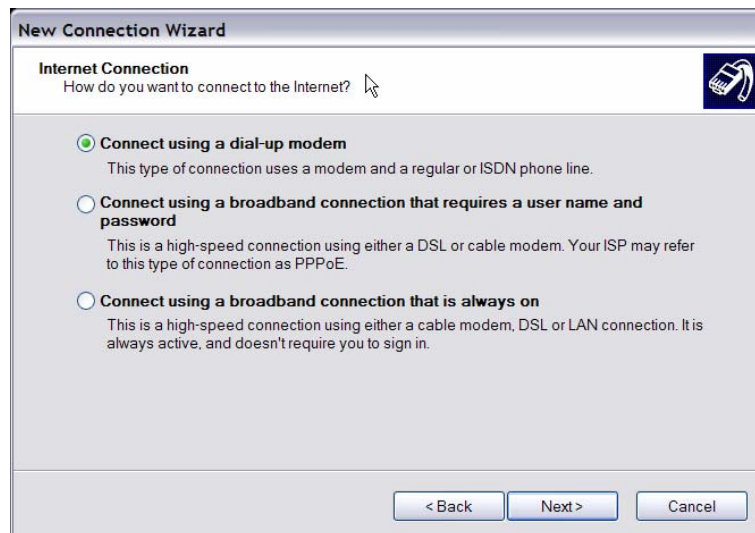

The screenshot shows the 'New Connection Wizard' dialog box with the title 'Internet Connection'. The question is 'How do you want to connect to the Internet?'. There are three radio button options: 'Connect using a dial-up modem' (selected), 'Connect using a broadband connection that requires a user name and password', and 'Connect using a broadband connection that is always on'. Each option has a brief description. At the bottom, there are three buttons: '< Back', 'Next >', and 'Cancel'.

- Type the name of the connection you are creating.



The screenshot shows the 'New Connection Wizard' dialog box with the title 'Connection Name'. The question is 'What is the name of the service that provides your Internet connection?'. Below the question, it says 'Type the name of your ISP in the following box.' and 'ISP Name'. There is a text input field containing 'DVR Dial-In'. Below the field, it says 'The name you type here will be the name of the connection you are creating.' At the bottom, there are three buttons: '< Back', 'Next >', and 'Cancel'.

- Enter the phone number of the modem that is connected to the unit.

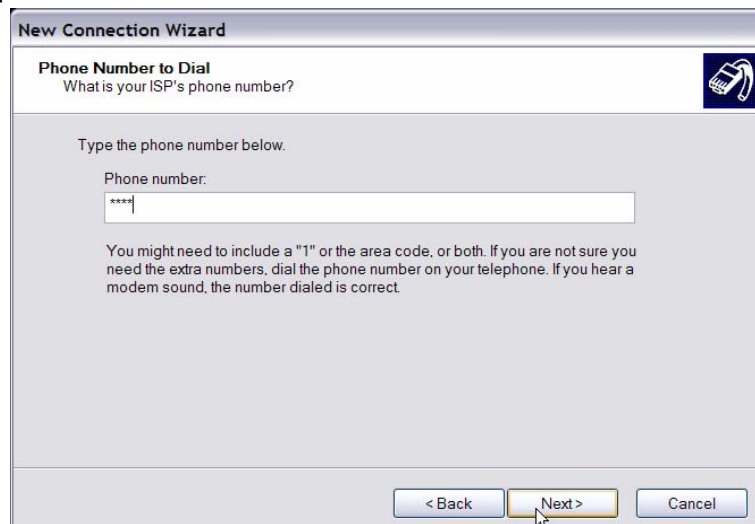

The screenshot shows the 'New Connection Wizard' dialog box with the title 'Phone Number to Dial'. The question is 'What is your ISP's phone number?'. Below the question, it says 'Type the phone number below.' and 'Phone number:'. There is a text input field containing '\*\*\*\*'. Below the field, it says 'You might need to include a "1" or the area code, or both. If you are not sure you need the extra numbers, dial the phone number on your telephone. If you hear a modem sound, the number dialed is correct.' At the bottom, there are three buttons: '< Back', 'Next >', and 'Cancel'.



- Enter the Username and Password that is set up in the Dial-in Setup menu.



- Click <Finish> to complete the dial-in connection..



- Now the dial-in connection is established.

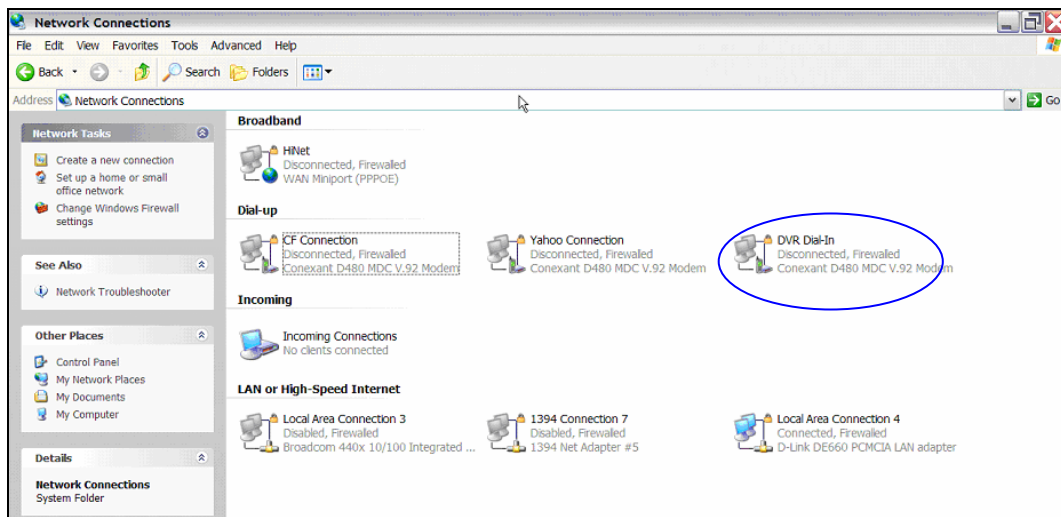

## Establishing Dial-out Connection

The Dial-out function enables the user to establish dial-up modem communication to and from the **DVR-4TH/ 8TH/ 16TH** series unit for remote notification use. Follow the instructions that follow to set up your DVR and PC.

### DVR Configuration:

- Connect a USB modem to the USB port and connect a working phone line to the modem.
- Press MENU and input username and password with appropriate privilege to access the OSD Main menu. Select <Network Setup> and then <Dial-out Setup> to set up the Dial-out settings.
- Select the <Email Address> in the Network Setup menu to edit an e-mail address for alarm notification.
- Select <Event Setup> in the Main menu and set the Email Notice function to <ON> (enabled).
- Exit the OSD menu and save the configuration.
- For more information on dial-out settings, see section **Dial-out Setup**.

### PC Configuration:

- Click <Start>, <My Network Places>, <View Network Connections> and then select <Create New Connection>. The New Connection Wizard is displayed. Click <Next> to continue.



- Set up the network connection type. Select <Set up an advanced connection> and then <Accept incoming connections>. Click <Next> to continue.

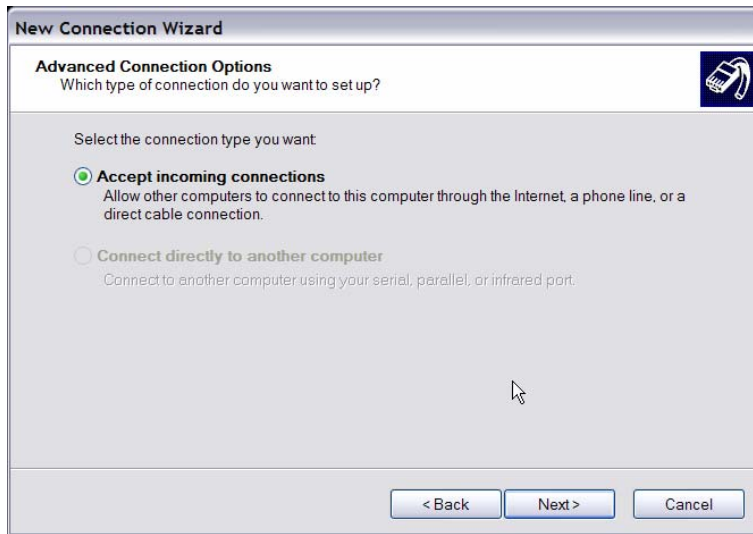

- Choose the modem device that will be used by the PC and click <Next>.

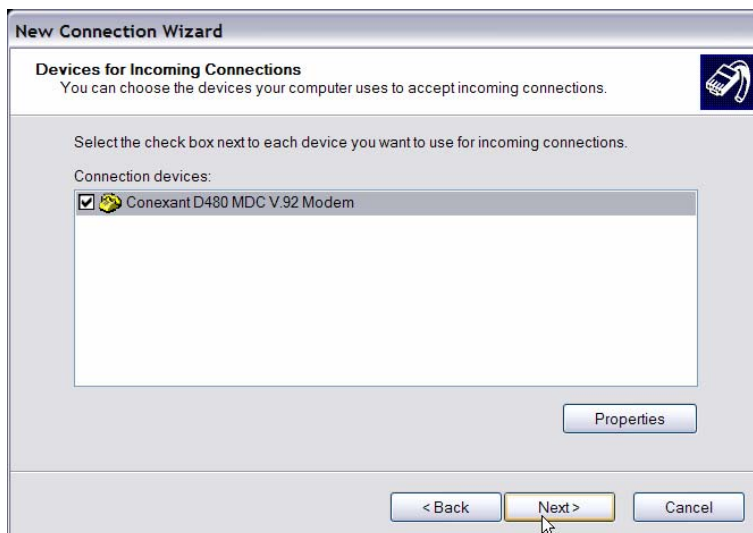

- In Incoming VPN Connection menu, choose <Do Not allow virtual private connections> and click on <Next>.



- In User Permission menu, select the users that will be using this connection. If needed, add a new user with the same user password that is set up in the Dial-out Setup menu in local DVR. When done, click <Next> to continue.

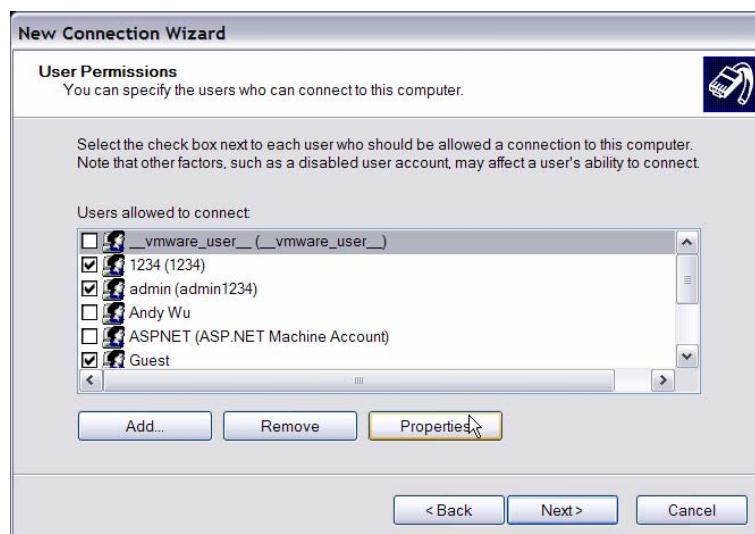

- In Networking Software menu, select <TCP/IP> and click on <Properties>.

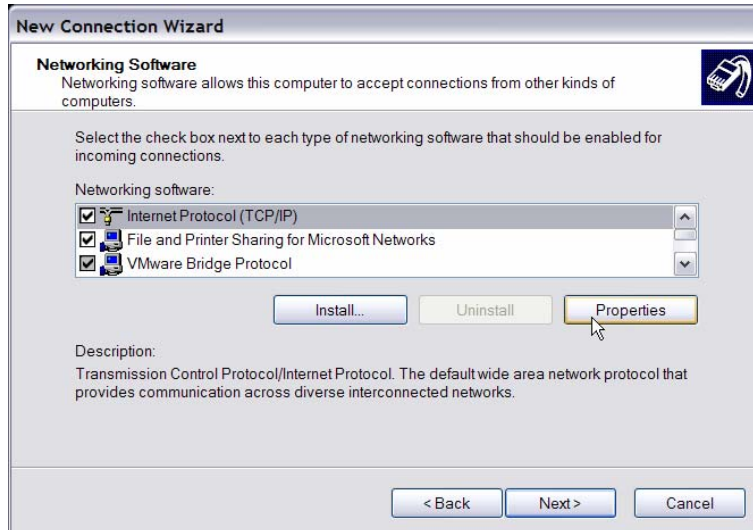

- In TCP/IP address assignment, if the PC has DHCP server, then choose <Assign TCP/IP addresses automatically using DHCP>, or choose <Specify TCP/IP addresses> and enter the range of IP addresses that you wish to use. Once done, click <OK> to confirm then back to Networking Software menu. Click on <Next> to continue.

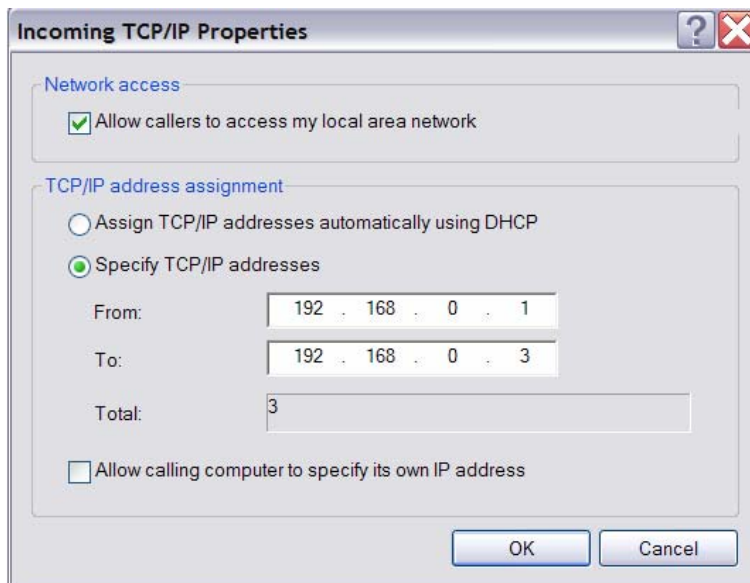

- Click <Finish> to complete the process.



- The Incoming connection is established.

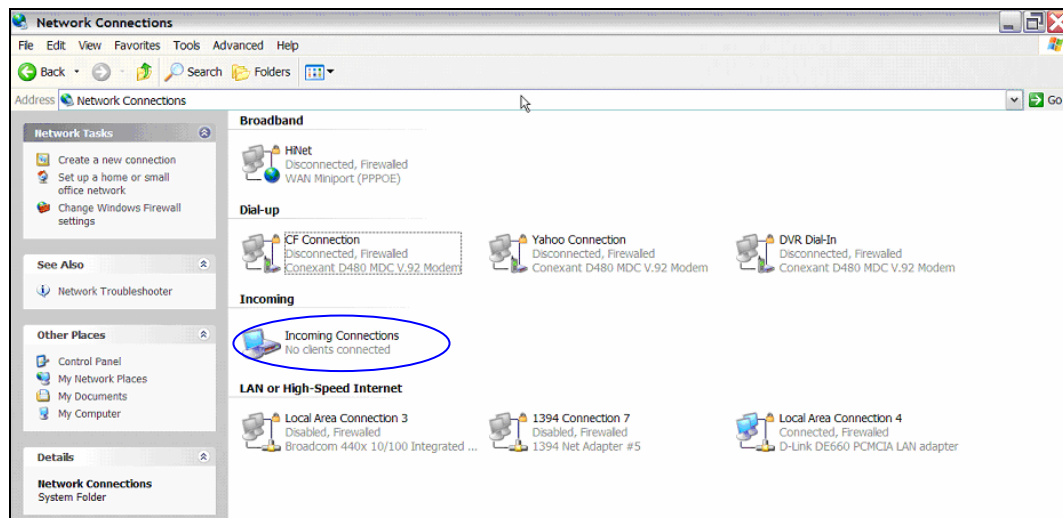

## Appendix E: Verifying Digital Signature

The digital signature aims to authenticate a video file exported from the unit. Follow the instructions to export video with a digital signature and to verify the digital signature.

### To export recorded video with digital signature:

To export recorded video with a digital signature to a USB hard drive or DVD+RW drive, follow these steps.

- In <Video Export> menu, select copy device, data type, expected channel and start/end time, or event video clips.
- Set the <Digital Signature> function to <Yes>.
- Start the exporting process by setting <Begin Export> to <Yes>.

Video Export	
Select Device	
Select Ch:	CH1 CH2 CH3 CH4
From	2008/03/19 AM 07:50:05
To	2008/03/28 PM 03:09:18
Select Events	
Data Type	Normal
Export Format	DRV
Digital Signature	No
Erase Disc	No
Begin Export	No

Each recorded video will be exported into four files with different filenames, including \*.gpg, \*.drv, \*.sig and readme.txt.

### To verify the exported recorded video:

Following are the procedures for digital signature verification.

- Start your **SpecoRemote™** and click <Play> on the main window tool bar.
- Click <Verify> tab to display the Verify window.

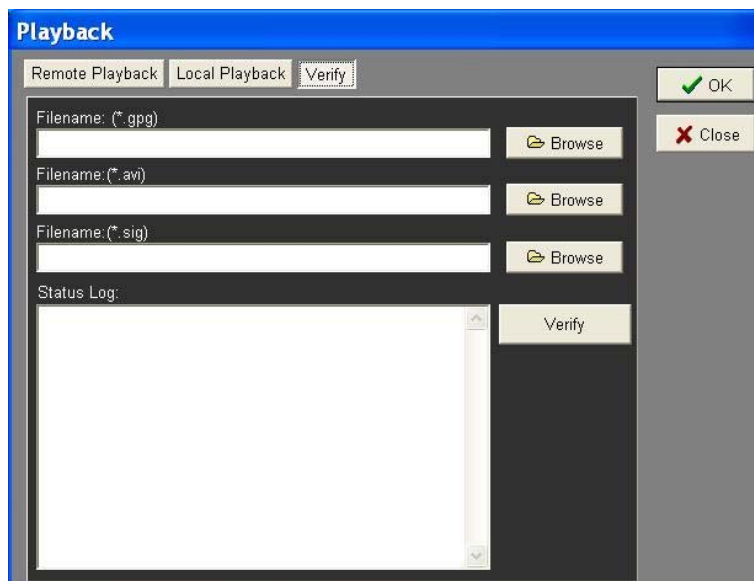

- Click <Browse> to select the \*.gpg, \*.drv, \*.sig files respectively, which belong to the exported video you want to authenticate.

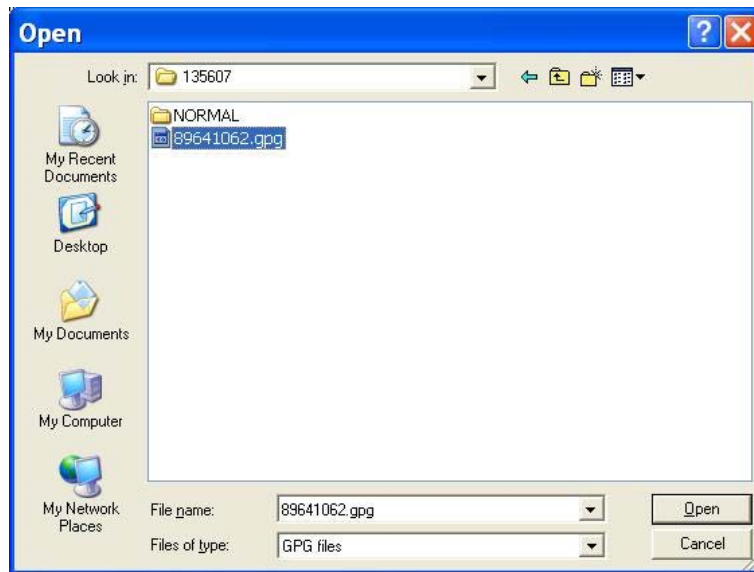

- Click <Verify> to start verifying the digital signature.

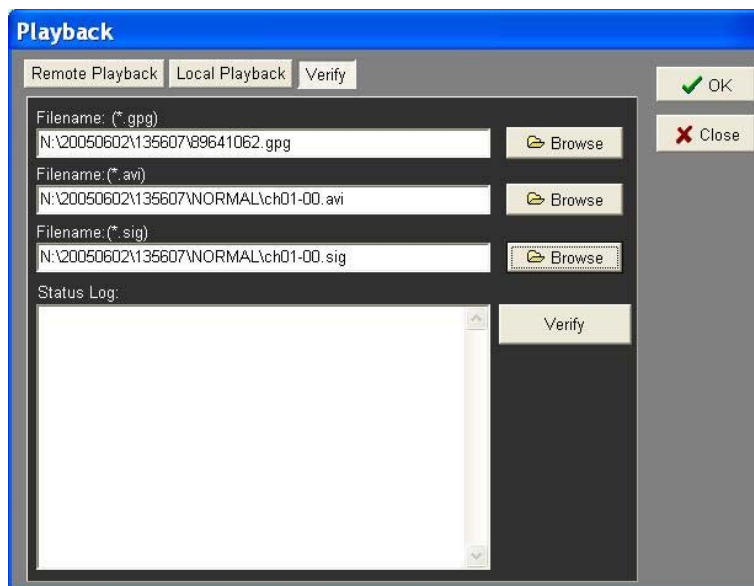



- The result of verification shows in the <Status Log> field. It returns a GOOD or BAD signature result. A GOOD signature indicates the exported clip has not been altered.

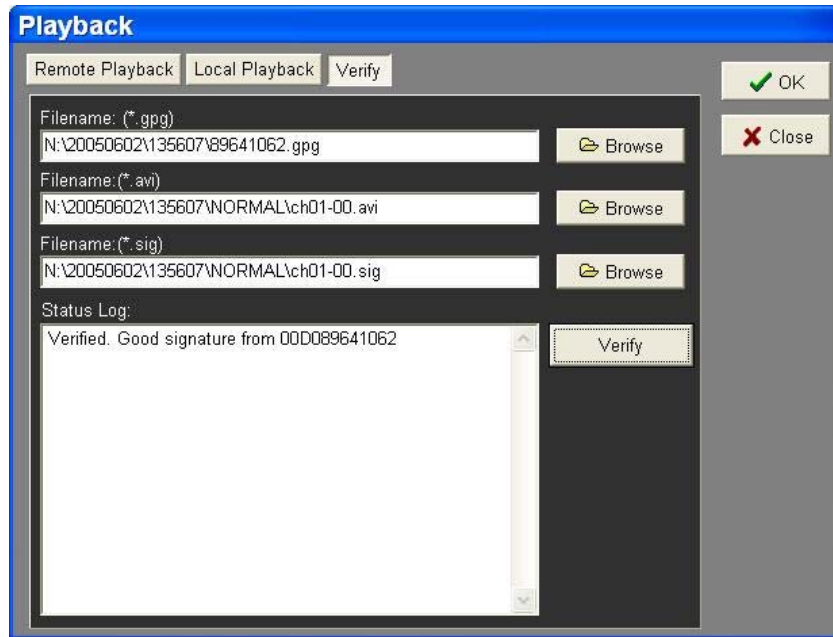

<GOOD> Signature

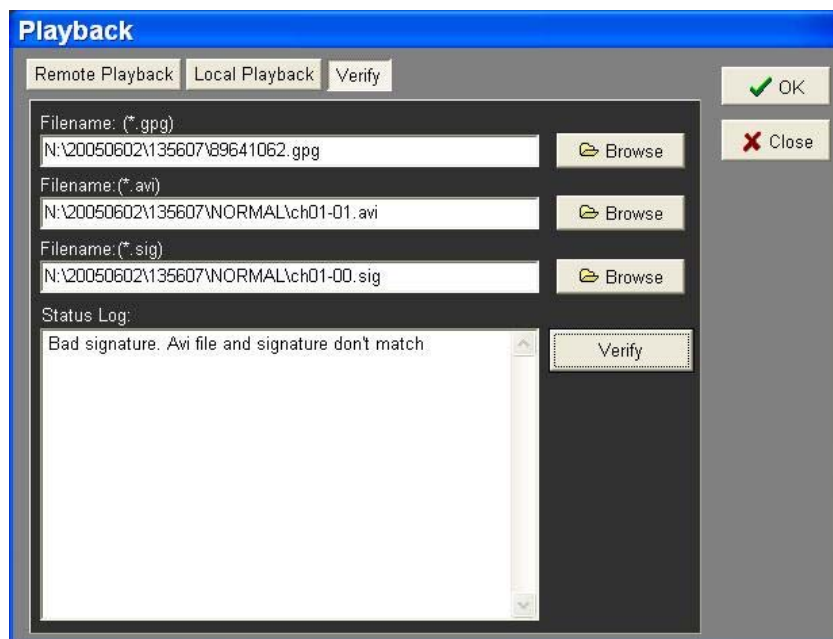

<BAD> Signature

## Appendix F: Alarm I/O Pin Definition

The tables below list the pin definitions of alarm I/O located on the rear panel of the **DVR-4TH/ 8TH/ 16TH** series unit.

### DVR-4TH Alarm I/O

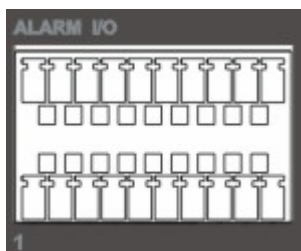

Pin	Definition	Pin	Definition	Pin	Definition
1	RS485 D+	8	Normal Close B	15	Reserved
2	RS485 D-	9	Common Node B	16	Reserved
3	Ground	10	Normal Open B	17	Reserved
4	Normal Close A	11	Alarm In 1	18	Reserved
5	Common Node A	12	Alarm In 2	19	Reserved
6	Normal Open A	13	Alarm In 3	20	Reserved
7	Ground	14	Alarm In 4		

### DVR-8TH Alarm I/O

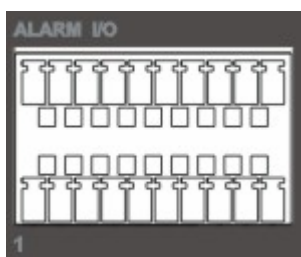

Pin	Definition	Pin	Definition	Pin	Definition
1	RS485 D+	8	Normal Close B	15	Alarm In 5
2	RS485 D-	9	Common Node B	16	Alarm In 6
3	Ground	10	Normal Open B	17	Alarm In 7
4	Normal Close A	11	Alarm In 1	18	Alarm In 8
5	Common Node A	12	Alarm In 2	19	Reserved
6	Normal Open A	13	Alarm In 3	20	Reserved
7	Ground	14	Alarm In 4		

### DVR-16TH Alarm I/O

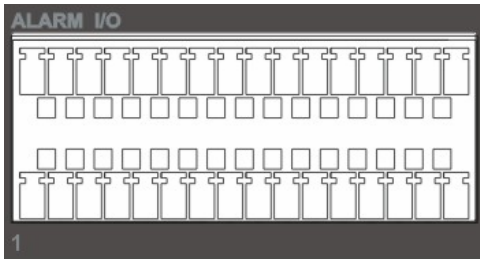

Pin	Definition	Pin	Definition	Pin	Definition
1	RS485 D+	12	N/A	23	Alarm In 7
2	RS485 D-	13	N/A	24	Alarm In 8
3	Ground	14	N/A	25	Alarm In 9
4	Normal Close A	15	N/A	26	Alarm In 10
5	Common Node A	16	N/A	27	Alarm In 11
6	Normal Open A	17	Alarm In 1	28	Alarm In 12
7	Ground	18	Alarm In 2	29	Alarm In 13
8	Normal Close B	19	Alarm In 3	30	Alarm In 14
9	Common Node B	20	Alarm In 4	31	Alarm In 15
10	Normal Open B	21	Alarm In 5	32	Alarm In 16
11	Ground	22	Alarm In 6		

## Appendix G: HDD PC Player Tool Introduction

For some specific reasons, users may need to view the stored data in the HDD on Personal Computer; this document guides you how to do that step by step.

### Using EXT2IFS on Your PC

EXT2IFS, an installed File System Driver, allows you to run a Linux System on Windows System. If you are a Windows user, then you need to install EXT2IFS to your PC before you start using SpecoPlayer to see the \*drv file . To get the software EXT2IFS, you can visit <http://uranus.it.swin.edu.au/~jn/linux/ext2ifs.htm> and download EXT2IFS. A detailed description about the software also can be found on the website.

The following steps guide you how to use the EXT2IFS software.

**Step 1.** Download EXT2IFS to your PC through above website address.

**Step 2.** Remove the HDD from your **DVR-4TH/ 8TH/ 16TH** series and install the removed HDD into **your** PC. When done, reboot the PC.

**Step 3.** Extract and Launch EXT2IFS Setup Wizard.

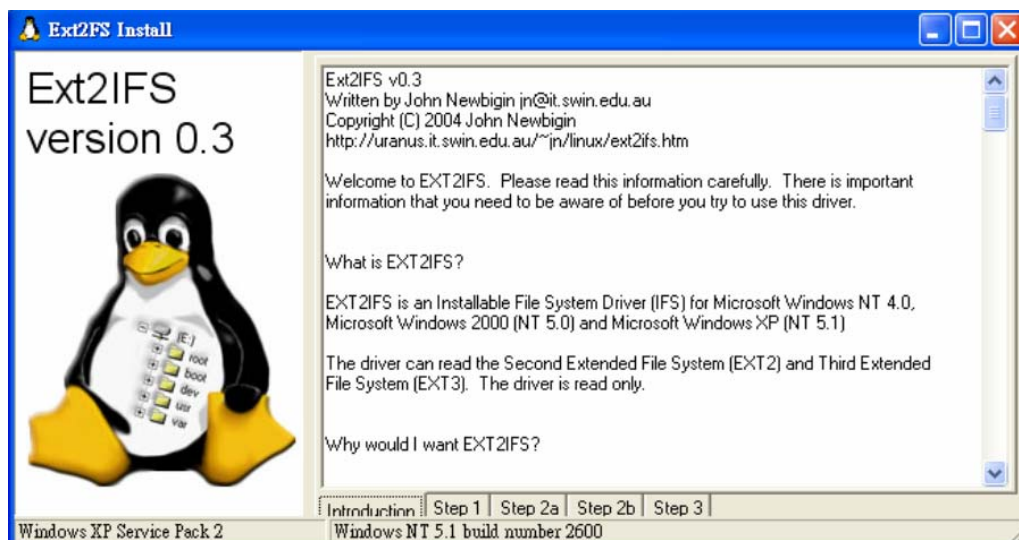

**Step 4.** Click <Step1> sheet, and then choose <Install to System Root> and <Start drive on boot> options. When done, click <Install Drive> button.

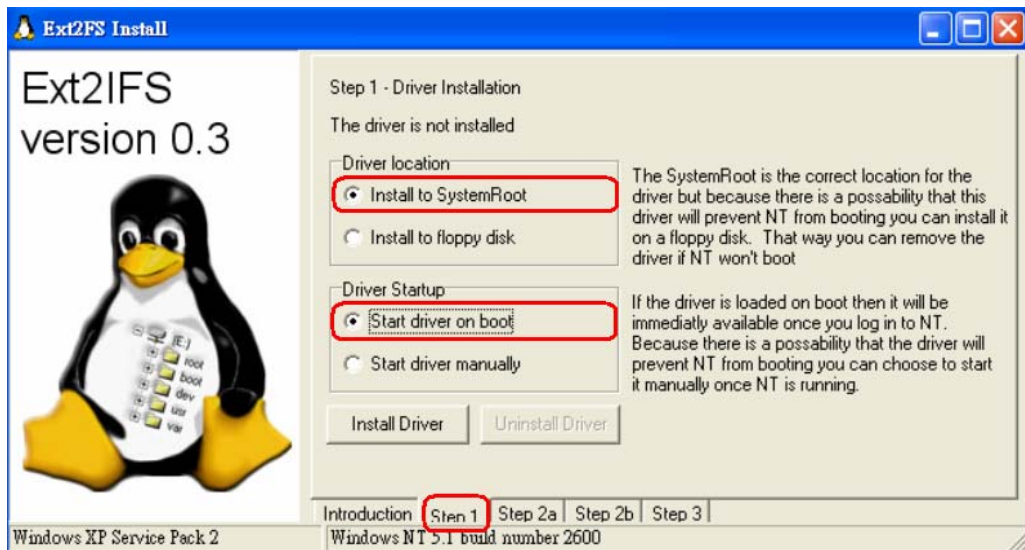

**Step 5.** Click <Step2b> sheet. Click <Drive> to assign each partition a drive.

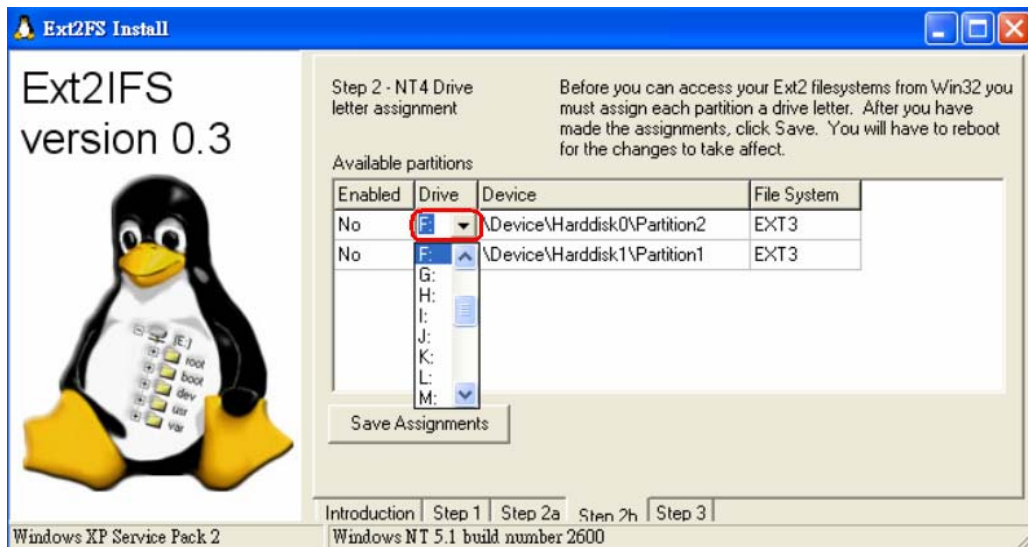

**Step 6.** Click <Step1> sheet, and then choose <Install to System Root> and <Start drive on boot> options. When done, click <Install Drive> button. After the assignments are made, click <Save Assignments> button.

**Step 7.** Click <Step1> sheet, and then choose <Install to System Root> and <Start drive on boot> options. When done, click <Install Drive> button. Click <Step3> sheet. Then click <Start Drive> button.

**Step 8.** Click <Step1> sheet, and then choose <Install to System Root> and <Start drive on boot> options. When done, click <Install Drive> button. After last step is done, reboot the PC for the changes to take effect. The HDD will be added into your PC's database after rebooting.

## **Start Playing the \*.drv file**

After the HDD being added into your PC's database , you can now use the SpecoPlayer to play the \*.drv file in your HDD. Please referring to the steps below:

**Step 1.** You can find the SpecoPlayer in the CD that ship with the package, start it and push the "PLAY" button on the upside of the frame.

**Step 2.** Click the "Open Device" button (as below picture), then choose the HDD Drive that you just assigned.

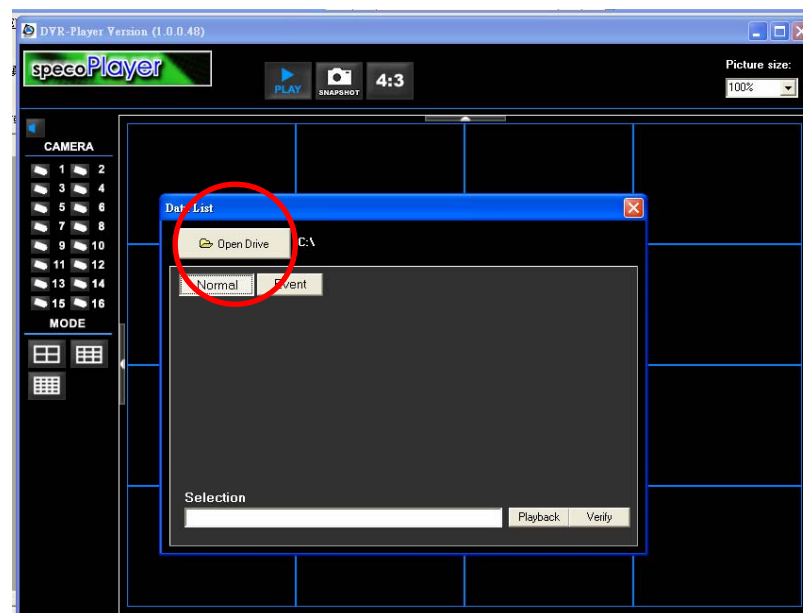

**Figure 1: Select the Drive**

**Step 3.** After choosing the HDD Drive , choose the video file that you want to use.

**Step 4.** Click the “Playback” to play the video directly or “Export” if you want to save the \*.drv file into your PC.

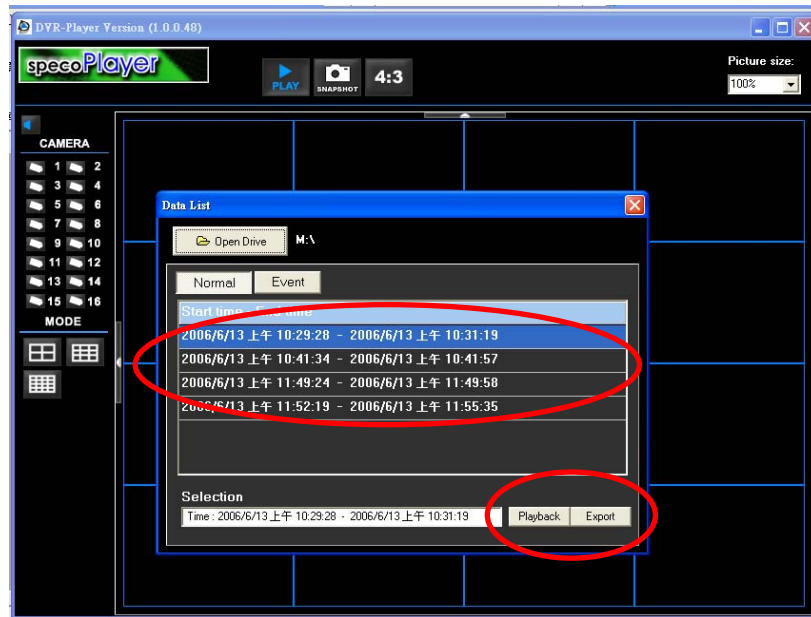

**Figure 2: Select the file you want to use**

## Appendix H: IR Remote

An IR Remote will be included in the content box and deliver to you with your **DVR-4TH/ 8TH/ 16TH** series unit. The keys on the IR Remote are listed as below figure:

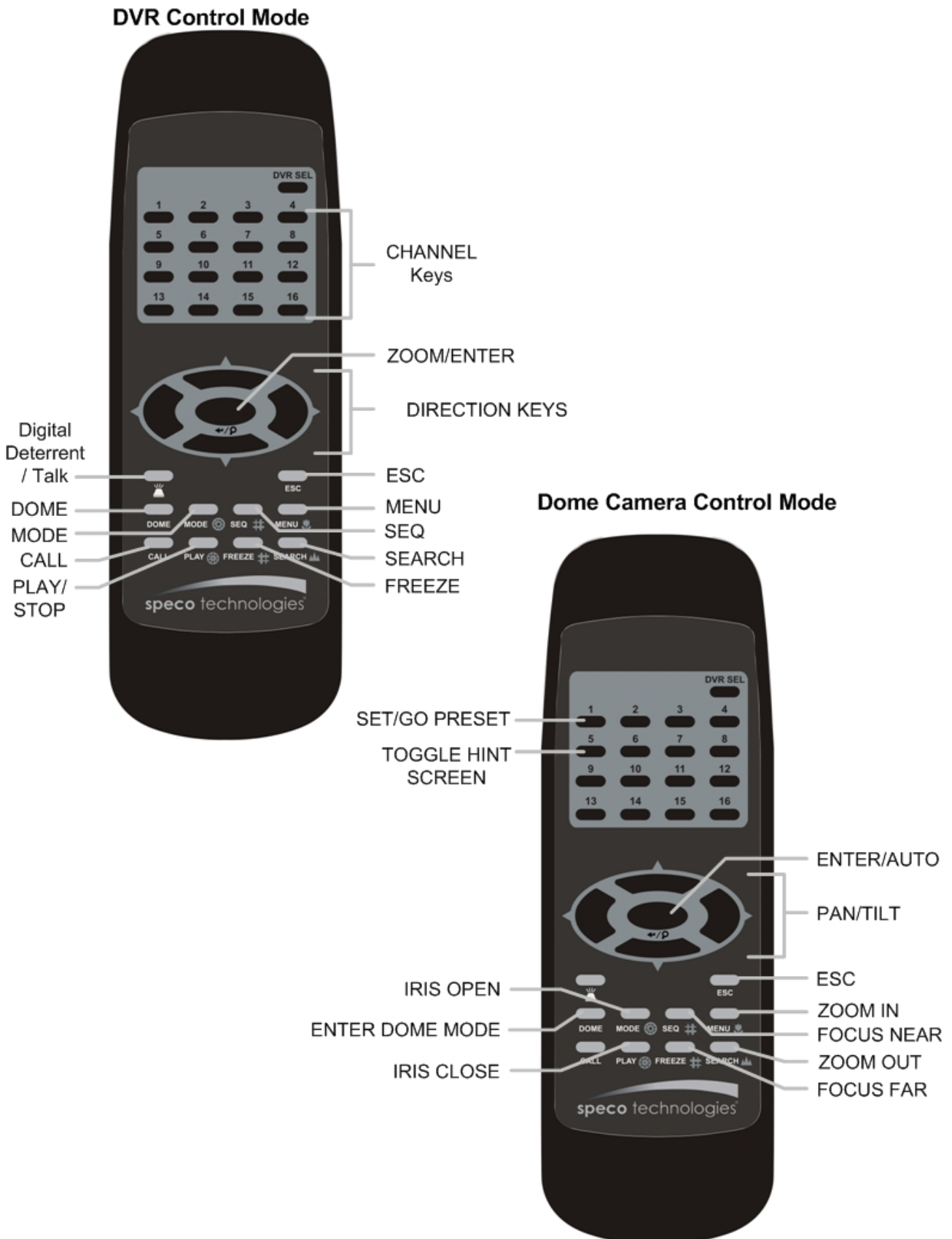



The keys of the remote control function as the keys of the front panel of the DVR. The only difference between the remote control and the front panel keys is the “DVR SEL” key. The DVR Selection key is used to switch control between each DVR.

The remote control can be used to control up to 16 DVRs. To setup the remote control, the first thing you need to do is to assign a unique DVR Unit ID to each DVR.

Use the front panel of the DVR, and follow this path to change the DVR Unit ID, <Main Menu> → <System Setup> → <RS485 Setup> → <Unit ID>

Change the DVR Unit ID to any number between 224 and 239, and exit the menu.

After the DVR Unit ID is changed, you will need to setup the “DVR SEL” of the remote control. Press “DVR SEL”, and then press the Remote Control # immediately to select the DVR. For example, assuming that you have set the DVR Unit ID to 225, then you should press “DVR SEL”, and then press “2” immediately. Now, the remote control will only be able to control the specified DVR. Press “DVR SEL”, and then press the Remote control # to switch between DVRs.

The ID Table is listed below for your reference.

DVR Unit ID	224	225	226	227	228	229	230	231
Remote Control #	1	2	3	4	5	6	7	8

DVR Unit ID	232	233	234	235	236	237	238	239
Remote Control #	9	10	11	12	13	14	15	16

However, if you would like to escape the single DVR control mode, press “DVR SEL”, and then press “ESC” to do so.

## Appendix I: USB Mouse Operation

Users can use an USB mouse to operate the DVR. To use the USB mouse, please read through the following descriptions.

Plug in an USB mouse to any USB port of the DVR. Move the USB mouse, and the cursor should appear. Move the cursor to the right side of the screen and a Live Panel will be displayed. The icons on the Live Panel are the same as the functional keys on the front panel of the DVR.

Clicking the left button functions the same as pressing the "ENTER" key. Clicking the right button functions the same as pressing the "ESC" key. The scroll wheel is used to change values.

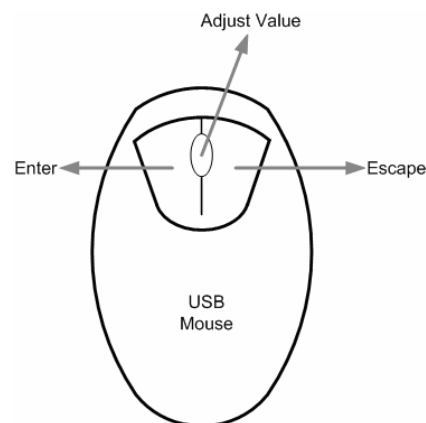

For example, if users want to change dome camera ID, enter the OSD setup menu and go to the following path: <Main Menu> → <Camera Setup> → <Dome ID>.

Left click on <Dome ID> and scroll the wheel up or down, the ID number will change as the scroll wheel moves. Stop moving the scroll wheel when the preferred ID number appears, then left click on the <Dome ID> and the ID number will be changed.

## Special Operations

There are two special operations provided when an USB mouse is connected. One is camera title alignment and the other is motion detection area setup.

### Camera Title Alignment

Users are allowed to change the display position of camera titles of all channels. To change the camera title position of any single channel, left click on the camera title and drag to any preferred position. If users want to set all of the camera titles to the same position that is set for a specific channel, right click on the specific camera title and select <ALIGN HERE> from the pull-down menu. The other options allow users to quickly set all camera titles to the preset positions at once.

ALIGN HERE
TOP-LEFT TOP-MIDDLE TOP-RIGHT
MIDDLE-LEFT CENTER MIDDLE-RIGHT
BOTTOM-LEFT BOTTOM-MIDDLE BOTTOM-RIGHT

### **Motion Detection Area Setup**

When users are setting the motion detection area, a USB mouse can help to speedily complete the setup. Enter the OSD setup menu and go to the following path: <Main Menu> → <Event Setup> → <Per Channel Config> → <Detection Config> → <Detected Area Setup>. The screen is split into 16x12 grids, where the grids can be selected or deselected as motion detection area.

Left click once on any grid to select or deselect the specific grid. Moreover, left click and drag to choose multiple grids, then a pull-down menu will be displayed when the mouse button is released. Choose <BLOCK SELECT> to set the grids as motion detection area, or choose <BLOCK DESELECT> to deactivate the grids. Otherwise, choose <CANCEL> to do nothing.

Right clicking the USB mouse will display a different pull-down menu, which includes: <Select All>, <Deselect All>, and <Confirm>. Choose <Select All> to set all grids as motion detection area, or choose <Deselect All> deactivate all grids. When the setup is completed, choose <Confirm> to save the setting and return to the previous page.



**NOTE:** This special USB mouse operation is also available to the privacy mask setup and smart search area setup.

# Appendix J: ezRecord Diagram Sample

## Diagram Sample( Full-D1 )

NTSC:720x480@30PPS

PAL:720x576@25PPS

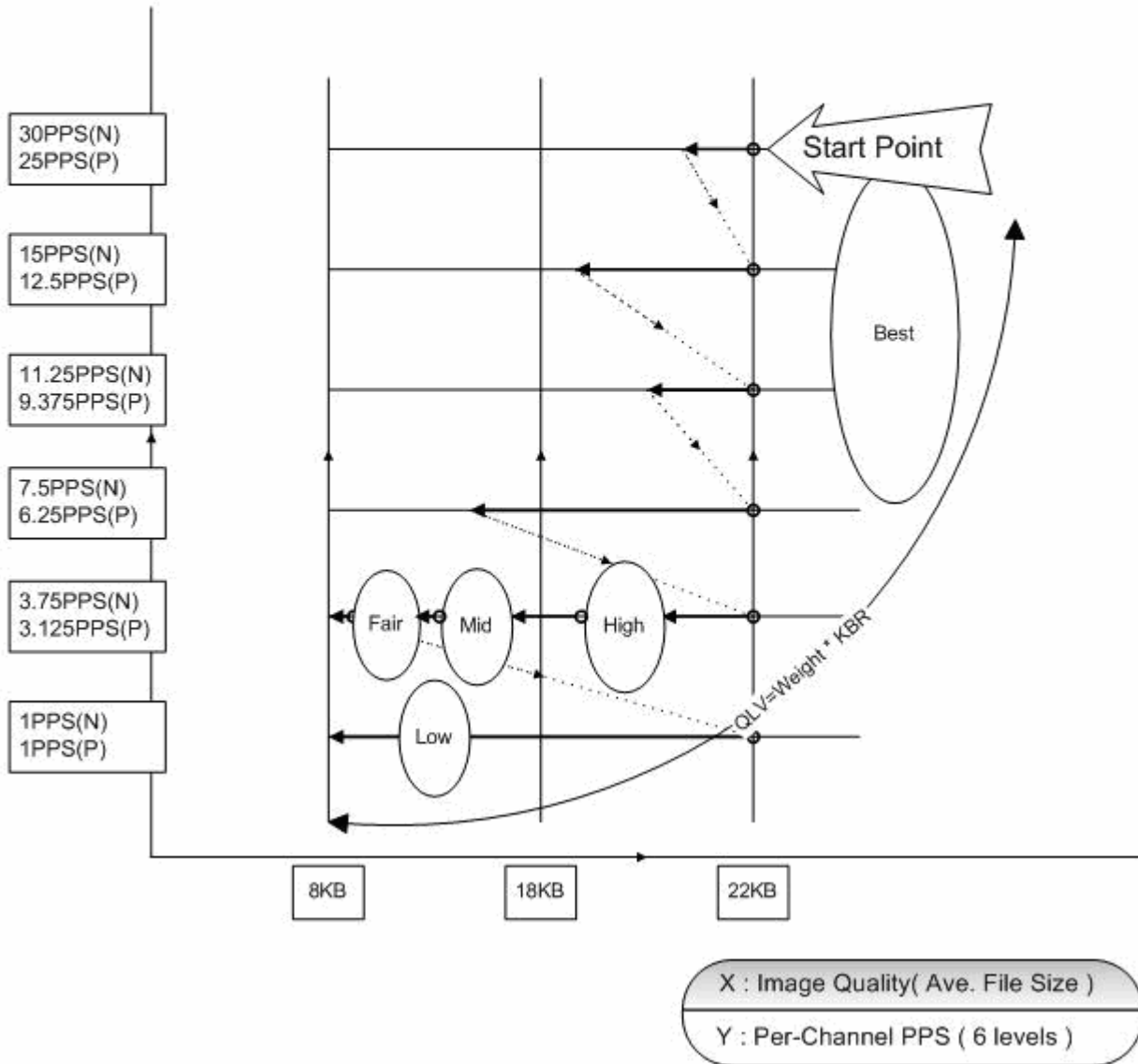

# Diagram Sample( Half-D1 )

NTSC:720x240@60PPS

PAL:720x288@50PPS

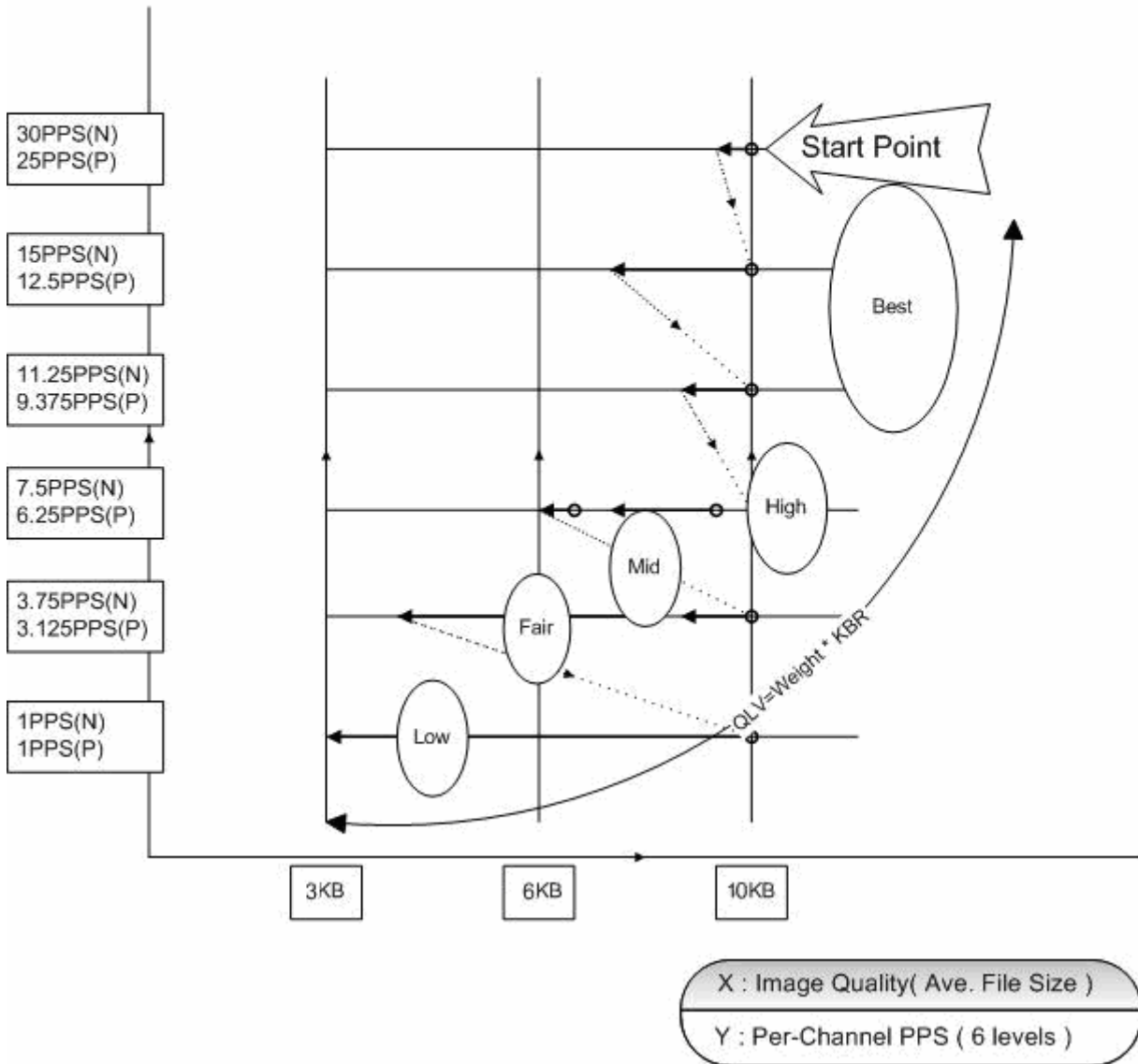

# Diagram Sample( CIF )

NTSC:360x240@120PPS

PAL:360x288@100PPS

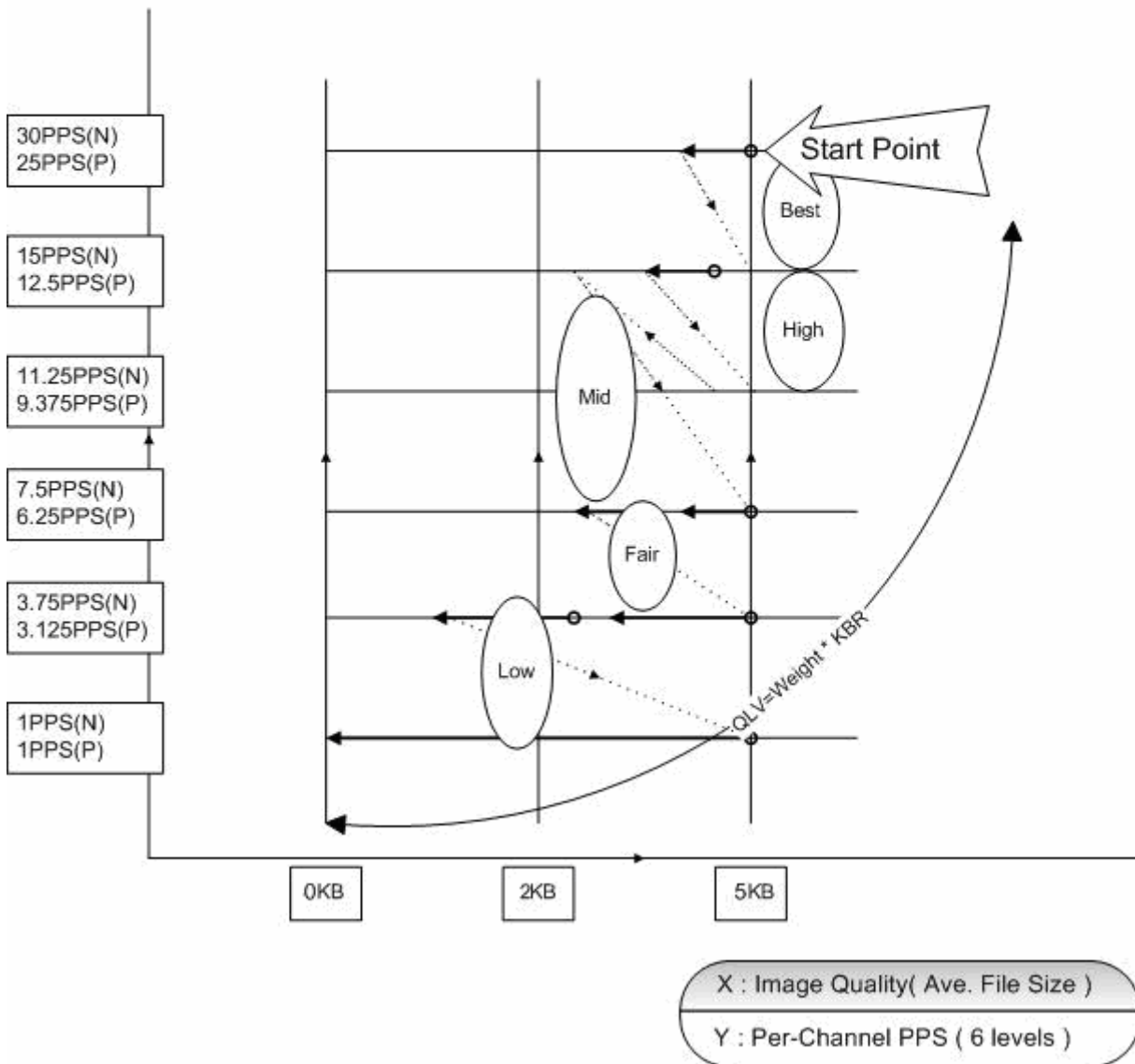

## Appendix K: Connect to External Storage Device

**DVR-DS4TST**, with the JBOD (Linear) functionality built-in, is a Network Attached Storage System (NAS) which is specially designed for the **DVR-4TH/ 8TH/ 16TH** series DVR.

You **SHOULD NOT** remove DVR's internal HDD or shut down the **DVR-DS4TST** while the connection is working. Below lists situations that may happen and the consequences if you do so.

- Situation:** Remove the DVR's internal HDD while the DVR is currently saving image data to the **DVR-DS4TST**.

**Result:** Disk error happens, and the DVR will not reboot. If you reboot the unit, the DVR keeps saving image data to the **DVR-DS4TST**.
- Situation:** Remove the DVR's internal HDD while the DVR is currently saving image data to the internal HDD.

**Result:** Disk error happens. The recording stops. After rebooting, the DVR starts saving image data to the **DVR-DS4TST**.