

Panasonic

DVCPRO 50

Digital Video Cassette Recorder

AJ-D95 DCP

Operating Instructions

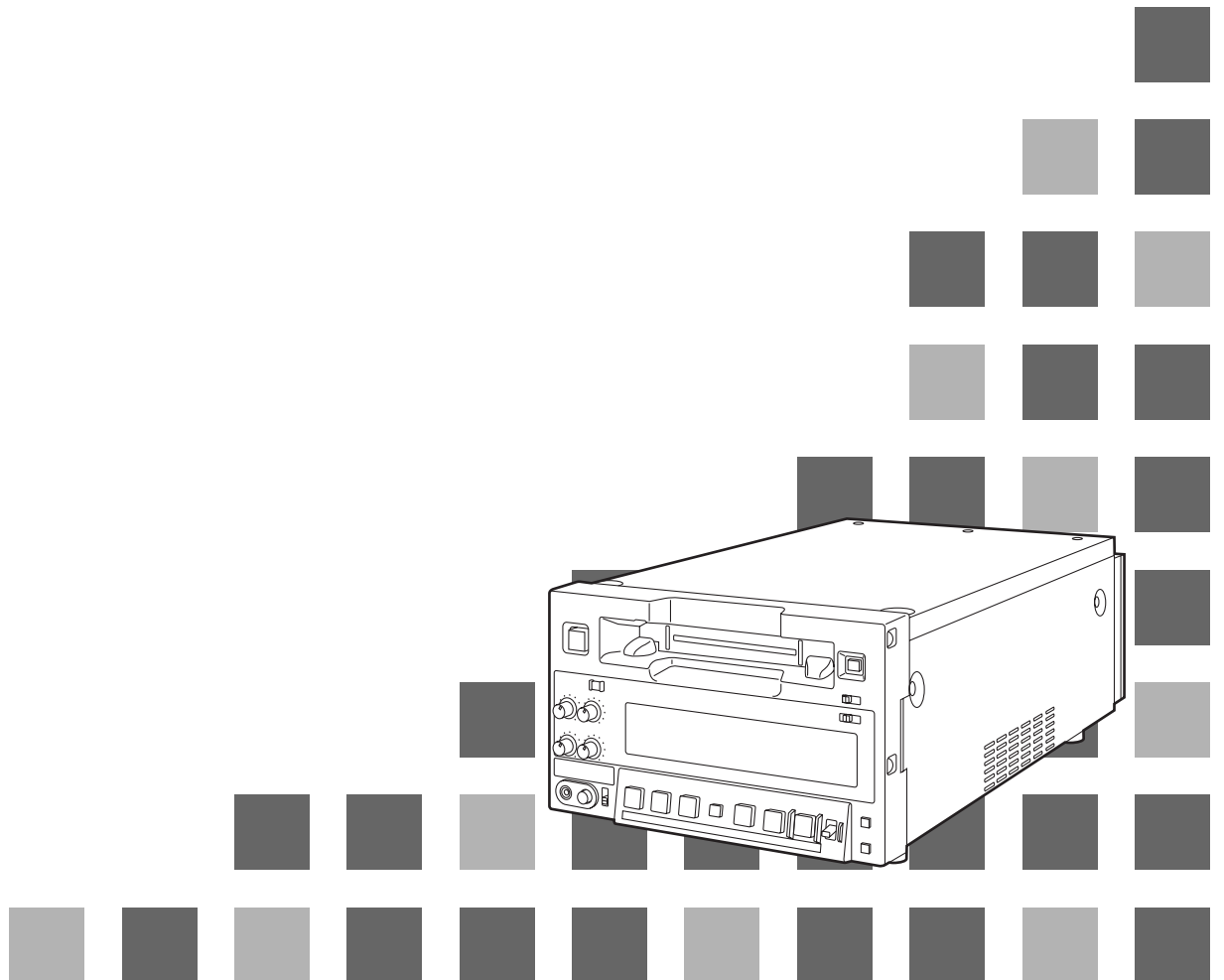

IMPORTANT

“Unauthorized recording of copyrighted television programs, video tapes and other materials may infringe the right of copyright owners and be contrary to copyright laws.”



CAUTION

**RISK OF ELECTRIC SHOCK
DO NOT OPEN**



CAUTION: TO REDUCE THE RISK OF ELECTRIC SHOCK,
DO NOT REMOVE COVER (OR BACK).
NO USER SERVICEABLE PARTS INSIDE.
REFER TO SERVICING TO QUALIFIED SERVICE PERSONNEL.



The lightning flash with arrowhead symbol, within an equilateral triangle, is intended to alert the user to the presence of uninsulated “dangerous voltage” within the product’s enclosure that may be of sufficient magnitude to constitute a risk of electric shock to persons.



The exclamation point within an equilateral triangle is intended to alert the user to the presence of important operating and maintenance (service) instructions in the literature accompanying the appliance.

CAUTION:

Do not install or place this unit in a bookcase, built-in cabinet or in another confined space in order to keep well ventilated condition. Ensure that curtains and any other materials do not obstruct the ventilation condition to prevent risk of electric shock or fire hazard due to overheating.

WARNING:

TO REDUCE THE RISK OF FIRE OR SHOCK HAZARD, DO NOT EXPOSE THIS EQUIPMENT TO RAIN OR MOISTURE.

検磁 3883A160

CAUTION:

TO REDUCE THE RISK OF FIRE OR SHOCK HAZARD AND ANNOYING INTERFERENCE, USE THE RECOMMENDED ACCESSORIES ONLY.

CAUTION:

TO REDUCE THE RISK OF FIRE OR SHOCK HAZARD, REFER CHANGE OF SWITCH SETTING INSIDE THE UNIT TO QUALIFIED SERVICE PERSONNEL.

CAUTION:

TO REDUCE THE RISK OF FIRE OR SHOCK HAZARD, REFER MOUNTING OF THE OPTIONAL INTERFACE BOARD TO QUALIFIED SERVICE PERSONNEL.

FCC Note:

This device complies with Part 15 of the FCC Rules. To assure continued compliance follow the attached installation instructions and do not make any unauthorized modifications.

This equipment has been tested and found to comply with the limits for a class A digital device, pursuant to Part 15 of the FCC Rules. These limits are designed to provide reasonable protection against harmful interference when the equipment is operated in a commercial environment. This equipment generates, uses, and can radiate radio frequency energy and, if not installed and used in accordance with the instruction manual, may cause harmful interference to radio communications. Operation of this equipment in a residential area is likely to cause harmful interference in which case the user will be required to correct the interference at his own expense.

 indicates safety information.

- Do not insert fingers or any objects into the video cassette holder.
- Avoid operating or leaving the unit near strong magnetic fields. Be especially careful of large audio speakers.
- Avoid operating or storing the unit in an excessively hot, cold, or damp environment as this may result in damage both to the recorder and to the tape.
- Do not spray any cleaner or wax directly on the unit.
- If the unit is not going to be used for a length of time, protect it from dirt and dust.
- Do not leave a cassette in the recorder when not in use.
- Do not block the ventilation slots of the unit.
- Use this unit horizontally and do not place anything on the top panel.
- Cassette tape can be used only for one-side, one direction recording. Two-way or two-track recordings cannot be made.
- Cassette tape can be used for either Color or Black & White recording.
- Do not attempt to disassemble the recorder. There are no user serviceable parts inside.
- If any liquid spills inside the recorder, have the recorder examined for possible damage.
- Refer any needed servicing to authorized service personnel.

Contents

Introduction	4	Superimposed Screens	21
Features	4	Setup (Initial Settings)	23
Parts and Their Functions	5	Setting method using on-screen menus	23
Front panel	5	How to return to the factory settings	23
Connector areas	9	How to set the user defaults	24
Example of Connections	11	How to load the user defaults	25
Tapes	12	How to protect the menus	25
Types of tapes and their recording times	12	How to release the menu protection	26
Operations	13	How to display the DIAG menu	26
Turning on the power/inserting a cassette	13	Setup Menu	27
Stop mode	13	SYSTEM menu	27
Recording	14	BASIC menu	29
Pause/recording		OPERATION menu	30
(back-space assemble recording)	14	INTERFACE menu	31
Playback	15	TAPE PROTECT menu	32
Cue/review	15	TIME CODE menu	33
Still-picture playback	15	VIDEO menu	35
Linear 0.3× speed playback	16	AUDIO menu	36
Variable speed playback	16	Error Messages	38
Audio channels	17	Emergency Eject	39
Time Codes/User's Bit	19	Video Head Cleaning	40
Time codes	19	Condensation	40
User's bit	19	Maintenance	40
Setting the time code	19	Specifications	41
Setting the user's bit	20		
Time code/user's bit playback	20		

Introduction

The AJ-D95DCP is a multi-purpose digital VTR which is capable not only of 525i/50 Mbps recording and playback using 1/4-inch wide compact cassette tapes but of recording and playback onto existing DVCPRO (25 Mbps) cassette tapes as well.

This VTR with its high picture quality, which is due to the use of digital compression technology, significantly reduces the deterioration in the quality of both sound and picture accompanying dubbing operations.

Its compact size and light-weight design makes it easy for the unit to be carried around and installed in a rack.

A dialogue system enables the unit's settings to be performed while monitoring the on-screen menus that appear on the TV monitor.

Features

Compact size and lightweight

The unit is 8-⁷/₁₆" (214 mm) wide, 5-¹/₄" (132 mm) high and 16-¹⁵/₁₆" (430 mm) deep, weighing 17.16 lb (7.8 kg).

It comes equipped with grips, which come in handy when the unit is to be carried.

Efficient installation in a rack

The unit's width is less than one-half of the standard 19 inches, while its height is equivalent to 3U.

This means that the unit can be installed in a rack with twice the efficiency of previous units, a feature which makes it economical as well.

Long-time recording and playback

When an L size cassette is used, the maximum recording and playback time is 92 minutes in the 50 Mbps mode and 184 minutes in the 25 Mbps mode. (using AJ-5P92LP *)

*For AJ-5P92LP cassette tapes recorded using the DVCPRO (25 Mbps) mode, use a VTR supporting DVCPRO (25 Mbps) 184 minute tapes.

Both L and M size cassettes supported

This unit employs a front loading mechanism to support the recording or playback of DVCPRO or DVCPRO 50 format size L and M cassette tapes.

AC or DC operation

This unit supports power supplied from both AC 120V and DC 12V sources.

Back-space assemble recording function

By using the REC button and PAUSE button together— a combination which activates the auto back function— pictures can be joined smoothly with no disturbances.

On-screen menu settings

Detailed function settings tailored to the individual user can be performed on-screen.

Audio level controls featured

The level of the signals for the two audio channels can be adjusted for recording and playback applications.

Time codes

Incorporated inside the unit is a TCG/TCR (time code generator/time code reader). It is also possible to input time codes from an external source to enable regeneration with an external time code.

Installation of SDI connector enabled

An optional SDI input/output board (model AJ-YA95P) for deriving the maximum from the digital VTR's features can be installed.

9-pin remote control

This unit comes with a 9-pin remote control connector so that the unit can be operated using an optional external remote controller (model AJ-A95P).

Encoder remote control

The unit's 15-pin encoder remote control connector enables adjustments to be made to the analog video output section using an optional external encoder remote controller (model AU-ER65B).

Parts and Their Functions

Front panel

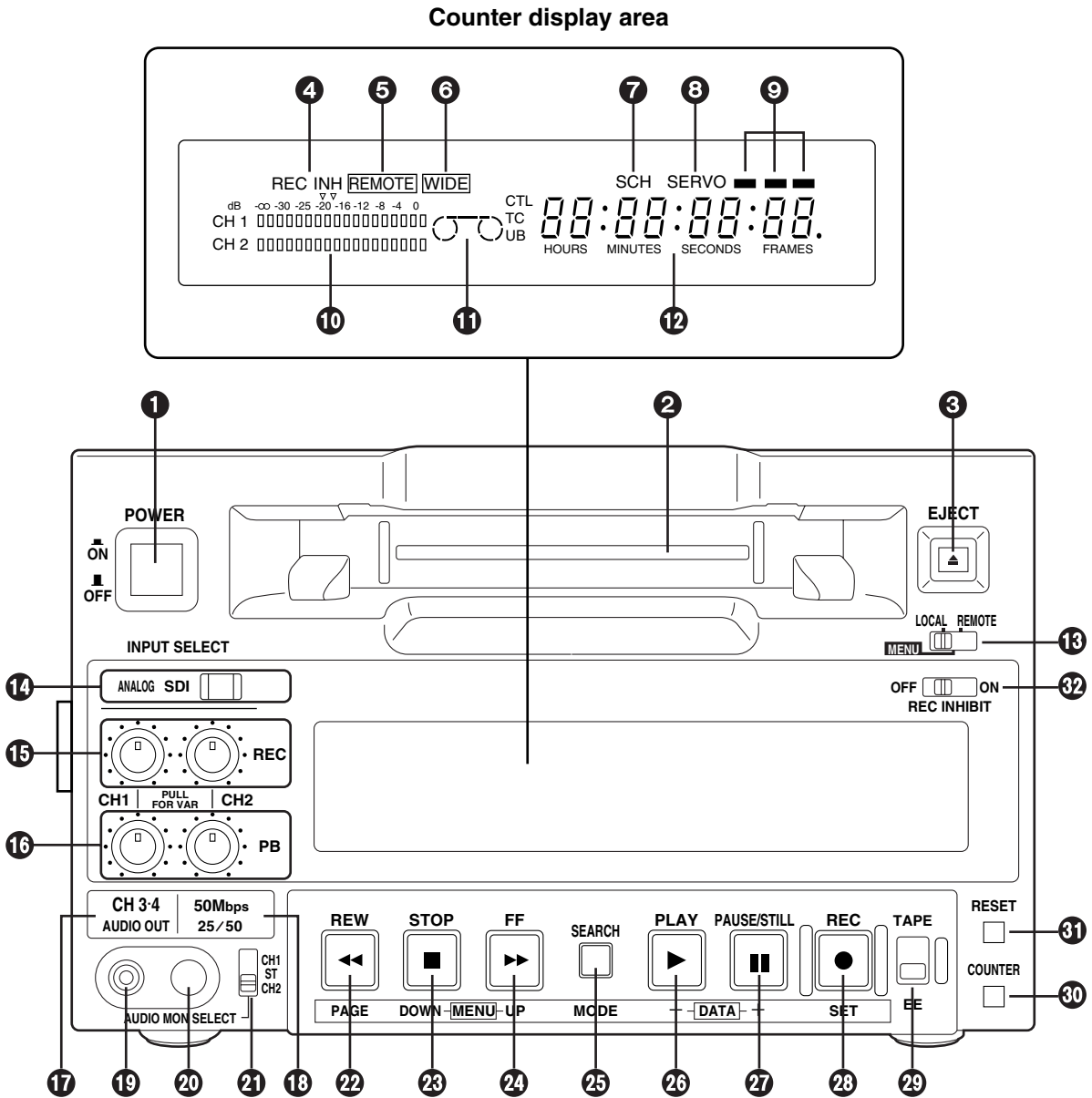

Parts and Their Functions

Front panel

① POWER switch

When this switch is pressed, the power is turned on and the counter display area lights; when it is pressed again, the power is turned off.

② Cassette insertion slot

Newsgathering cassettes and general-purpose cassettes are inserted into this slot.

<Note>

Do not insert DV cassettes, which are designed for general consumer applications.

③ EJECT button

When this button is pressed, the tape inside is unloaded and several seconds later it is automatically ejected.

If the counter display area is set to the CTL display, the display will be reset.

④ REC and REC INH lamps

REC: This lamp lights during recording.

REC INH: This lamp lights when the cassette is set to the accidental erasure prevention status. It also lights when the REC INHIBIT switch ⑫ is at the ON setting. In this status, recording is not possible.

⑤ REMOTE lamp

This lamp lights when the REMOTE setting has been selected by the LOCAL/MENU/REMOTE switch ⑬.

⑥ WIDE lamp

This lamp lights when the WIDE mode has been selected.

⑦ SCH lamp

This lamp lights when the external sync signal subcarrier phase is within the specified range.

⑧ SERVO lamp

This lamp lights when the drum servo and capstan servo lock.

⑨ Channel condition lamps

One of these lamps lights in accordance with the error rate statuses. (Green → Blue → Red)

Green: This lamp lights when both the error rates for the video and audio playback signals are at an acceptable level.

Blue: This lamp lights when the error rate for either the video and audio playback signals has deteriorated. A normal playback picture will appear even when this lamp is lighted.

Red: This lamp lights when either the video or audio playback signals are subject to correction or interpolation.

⑩ Level meter

This displays the levels of the audio signals.

The level of the input audio signals is displayed during recording and E-E selection; the level of the output audio signals is displayed during playback.

⑪ Cassette insertion and tape travel display lamp

This lamp lights when a cassette has been inserted into the unit.

 : When a tape has been inserted and the STANDBY ON status has been established

 : When a tape has been inserted and the STANDBY OFF (HALF LOADING) status has been established

 : While the tape is traveling, the segment display moves as the tape travels.

 : The “○” symbol at the stopped side flashes when the fan has shut down.

⑫ Counter display area

The TC and CTL counts, the on-screen information and other messages are displayed in this area.

If DC power is supplied to the unit, the whole display will flash as a warning when the voltage has dropped.

When the voltage drops to 10.6V or so, the power will automatically be turned off.

⑬ LOCAL/MENU/REMOTE switch

This switch is set when menu settings are to be performed or when the unit is to be controlled from an external source.

LOCAL: Set here when the unit is to be controlled using the controls on its operation panel.

MENU: Set here when on-screen menu settings are to be performed.

REMOTE: Set here when the unit is to be controlled using an external remote controller (model AJ-A95P).

Parts and Their Functions

14 INPUT SELECT button and lamp

This button is used to select the input signals. Each time it is pressed, ANALOG and SDI signals are selected alternately.

<Note>

It is not possible to select ANALOG for the video signals and SDI for the audio signals or vice versa: the same setting must be used for both sets of signals.

ANALOG: This is selected when analog composite video signals and analog audio signals are input. When it is selected, the ANALOG lamp lights.

The ANALOG lamp flashes when this setting is selected but no analog composite video signals are input.

SDI: SDI input signals can be selected when the optional SDI input/output board has been installed. When it is selected, the SDI lamp lights. The SDI lamp flashes when this setting is selected but no SDI signals are input.

15 Audio signal CH1 and CH2 recording level controls

These controls are used to adjust the recording levels of the CH1 and CH2 audio signals.

They use a “pull to vary level” system which means that the levels can be adjusted after they have been pulled up. The default signal levels apply when they are pushed down.

16 Audio signal CH1 and CH2 playback level controls

These controls are used to adjust the playback levels of the CH1 and CH2 audio signals.

They use a “pull to vary level” system which means that the levels can be adjusted after they have been pulled up. The default signal levels apply when they are pushed down.

<Note>

The cue audio signal level cannot be adjusted.

17 CH3 and CH4 lamp

This lamp lights when TR3/4 is selected as the setup menu item No.711 setting in the 50 Mbps mode. It also lights in the E-E mode when the optional SDI input/output board has been installed, SDI input is selected, and CH3/4 is selected as the setup menu item No.712 setting. (During playback, the lamp is lighted by the No.712 setting.)

(See page 37)

18 50 Mbps lamp

This lamp lights when the 50 Mbps mode has been established.

19 Headphones jack

When a pair of stereo headphones are connected to this jack, the sound of the recording or playback can be monitored through the headphones.

20 Volume control

This control is used to adjust the headphone volume.

21 Audio monitor selector switch

This switch is used to select the audio monitor output and headphone output channels.

CH1: The CH1 sound is output through both the left and right channels.

ST: The sound selected by the settings of setup menu items No.708 and No.709 is output.

CH2: The CH2 sound is output through both the left and right channels.

22 REW button

This button is pressed to rewind the tape. The playback pictures can be monitored when the TAPE/EE switch 29 is set to TAPE.

Pressing the REW button while in the search mode (search still, forward search, forward search still, reverse search still) causes operation to switch to reverse search, and reverse playback occurs at the speed selected using setting No. 100 on the setup menu. (See pages 15 and 30.)

Pressing the REW button while in the slow mode (slow still, forward slow, forward slow still) causes operation to switch to reverse linear 0.3× playback. (See page 16.)

Noise will appear during linear 0.3× playback: this is normal and not indicative of malfunctioning.

23 STOP button

This button is pressed to stop the tape travel. The playback pictures can be monitored when the TAPE/EE switch 29 is set to TAPE.

The tape drum continues to rotate even in the stop mode, and the tape remains in close contact with the drum.

When the stop mode continues beyond the prescribed period of time, the unit is automatically set to the STANDBY OFF (HALF LOADING) mode in order to protect the tape.

The stop mode is established immediately after a cassette has been inserted into the unit.

Parts and Their Functions

24 FF button

This button is pressed to fast forward the tape. The playback pictures can be monitored when the TAPE/EE switch 29 is set to TAPE.

Pressing the FF button while in the search mode (search still, reverse search, reverse search still, forward search still) causes operation to switch to forward search, and fast forward playback occurs at the speed selected using setting No. 100 on the setup menu. (See pages 15 and 30.)

Pressing the FF button while in the slow mode (slow still, reverse slow, reverse slow still) causes operation to switch to forward linear 0.3× playback. (See page 16.)

Noise will appear during linear 0.3× playback: this is normal and not indicative of malfunctioning.

25 SEARCH button

This button is pressed to switch to the search mode or the slow mode. (See pages 15 and 16.)

26 PLAY button

This button is pressed to commence playback. Recording is commenced when it is pressed together with the REC button.

27 PAUSE/STILL button

When this button is pressed during recording, the tape is temporarily stopped.

Recording is resumed when it is pressed again.

When this button is pressed during playback, the still picture mode is established. Playback is resumed when it is pressed again.

Pressing the PAUSE/STILL button during forward or reverse search operation causes the tape to pause (forward or reverse search still). Pressing the button a second time causes forward or reverse search operation to resume.

Pressing the PAUSE/STILL button during forward or reverse slow operation causes the tape to pause (forward or reverse slow still). Pressing the button a second time causes forward or reverse slow operation to resume.

Linear 0.3× playback takes place during forward or reverse slow operation. Noise will appear during still and linear 0.3× playback: this is normal and not indicative of malfunctioning. (See page 16.)

28 REC button

Recording is commenced when this button is pressed together with the PLAY button. When it is pressed in the stop or eject mode, the input video signals and audio signals can be monitored even when the TAPE/EE switch is set to TAPE.

It is also possible to use the button to check the time code generator's value. (REC CHECK mode) When the STOP button or any other function button is pressed, the REC CHECK mode will be released.

29 TAPE/EE switch

This switch is used to select the signals to be output in the stop, fast forward or rewind mode.

TAPE: The signals which are played back from the tape are output.

EE: The input signals which were selected by the INPUT SELECT button are output.

<Notes>

- When REC has been set for setup menu item No.105, the E-E mode will be established in the stop mode regardless of the position of the TAPE/EE switch. (See page 30)
- The picture and sound may break up when the position of the switch is changed.

30 COUNTER button

This button is used to switch the counter display area. Each time it is pressed, the setting is changed in the following sequence: CTL → TC → UB → r → CTL, etc.

CTL: The tape timer (control signal) appears on the display.

TC: The time code appears on the display.

UB: The user bit appears on the display.

r: The amount of tape remaining is displayed in 1-minute increments.

(Example)

"r102" = 102 minutes of tape are remaining.

31 RESET button

When this button is pressed in the CTL mode, the counter display is reset to 00:00:00:00.

32 REC INHIBIT button

This button is used to allow or inhibit recording onto the cassette tape.

ON: Recording on the cassette tape is inhibited. The REC INHIBIT lamp on the display lights.

OFF: Provided that the accidental erasure prevention mechanism on the cassette tape is set to the recording enable position, a recording can be made on the cassette tape.

Parts and Their Functions

Connector areas

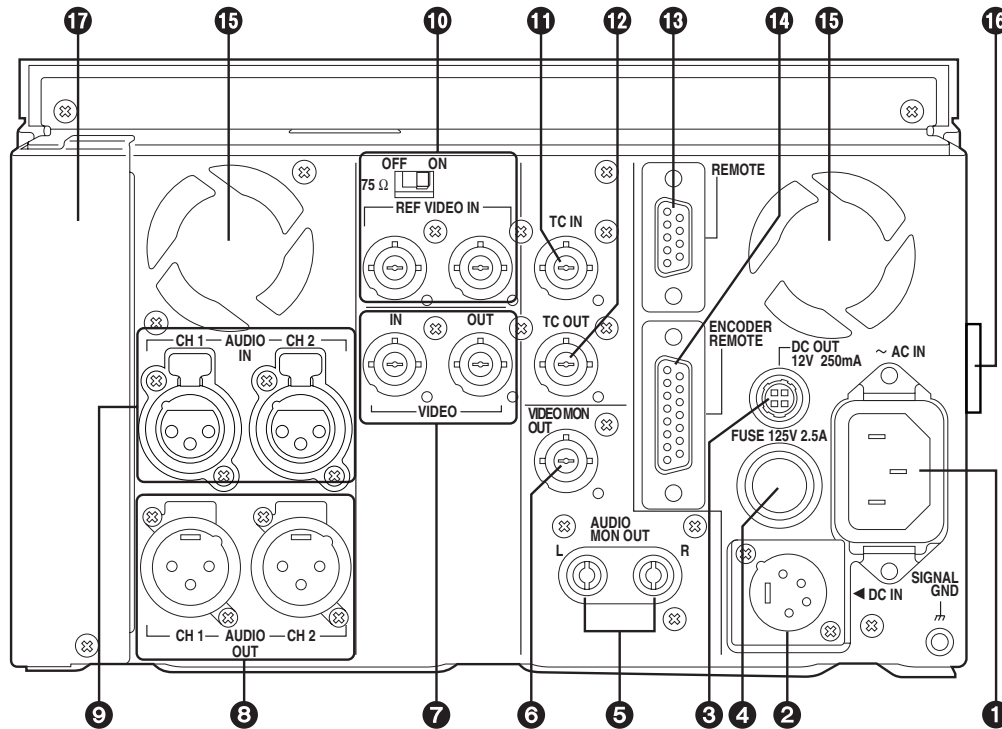

1 AC IN socket

This is the AC power inlet. The accessory power cord is connected here. Use an AC 120V ($\pm 10\%$) power supply to operate this unit. When the voltage has dropped to an extremely low level, the unit's power is automatically switched off. It will take several minutes for the unit to be reset even after the supply voltage is restored. In a case like this, set the POWER switch to OFF, wait several minutes, and start up the unit again. AC power takes precedence when both AC and DC power supplies have been connected.

2 DC IN socket

This is the input connector for the DC 12V power. Use the optional AC adaptor (model AJ-B75). When the voltage has dropped to around 10.6V, the unit's power is automatically switched off. It will take several minutes for the unit to be reset even after the supply voltage is restored. AC power takes precedence when both AC and DC power supplies have been connected.

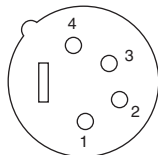

Pin No.	Signal
1	Ground
2	—
3	—
4	+12 V

3 DC OUT socket

This is the DC 12V output connector. It is used to supply power to the external remote controller (model AJ-A95P). The DC power cable is packed with the model AJ-A95P controller.



Pin No.	Signal
1	Ground
2	—
3	—
4	+12 V

4 Fuse holder

This contains a 2.5A fuse.

5 AUDIO MONITOR OUT (Lch/Rch) connectors

These are the output connectors for the audio monitor signals. It is possible to select the channel through which the audio monitor signals are to be output using the audio monitor selector switch on the front panel and setup menu item No.708. (See page 36)

Parts and Their Functions

Connector area

⑥ VIDEO MONITOR OUT connector

This is the output connector for the video monitor signals. Superimposed video signals can be output to this connector.

Superimposing can be set to ON or OFF by setup menu item No.002. (See page 29)

⑦ VIDEO IN and OUT connectors

These are the input connector and output connectors for the analog composite video signals.

⑧ AUDIO OUT (CH1/CH2) connectors

These are the output connectors for the analog audio signals.

⑨ AUDIO IN (CH1/CH2) connectors

These are the input connectors for the analog audio signals.

⑩ REF VIDEO IN connectors and 75 Ω termination switch

These are the input connectors for the reference video signals.

Input black burst signals or composite video signals which comply with the RS-170A standard.

Set the switch to ON for termination.

⑪ TC IN connector

This is the connector for recording the external time codes on the tape.

⑫ TC OUT connector

During playback, the playback time code is output to this connector. During recording, the time code generated by the internal time code generator is output.

⑬ REMOTE CONTROL connector

This unit can be operated from an external source by connecting an optional external remote controller (model AJ-A95P) to this connector.

<Notes>

- Set the LOCAL/MENU/REMOTE switch to the REMOTE position.
- This complies with the RS-422A interface standard but the functions associated with editing do not work.

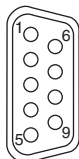

Pin No.	Signal
1	Frame Ground
2	Transmit A
3	Receive B
4	Receive Common
5	—
6	Transmit Common
7	Transmit B
8	Receive A
9	Frame Ground

⑭ ENCODER REMOTE connector

An optional external encoder remote controller (model AU-ER65B) is connected to this connector when the video output signal settings are to be adjusted from an external source.

<Note>

Set setup menu item No.00 to REMOTE. (See page 27)

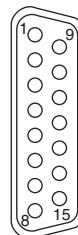

Pin No.	Signal
1	—
2	Set Up
3	C Level
4	Ground
5	+9 V
6	System H
7	SYS. SC. Coarse (2)
8	-9 V
9	Hue
10	Video Level
11	Ret Ground
12	—
13	—
14	SYS. SC. Fine
15	SYS. SC. Coarse (1)

⑮ Fan motor

This motor drives the fan to cool down the unit.

⑯ Grip

Grips are provided on the side panels. However, when the unit is to be operated, lay it flat.

⑰ Slot for SDI card (option)

This is the slot for the optional component serial interface board (SDI input/output board: model AJ-YA95P).

Example of Connections

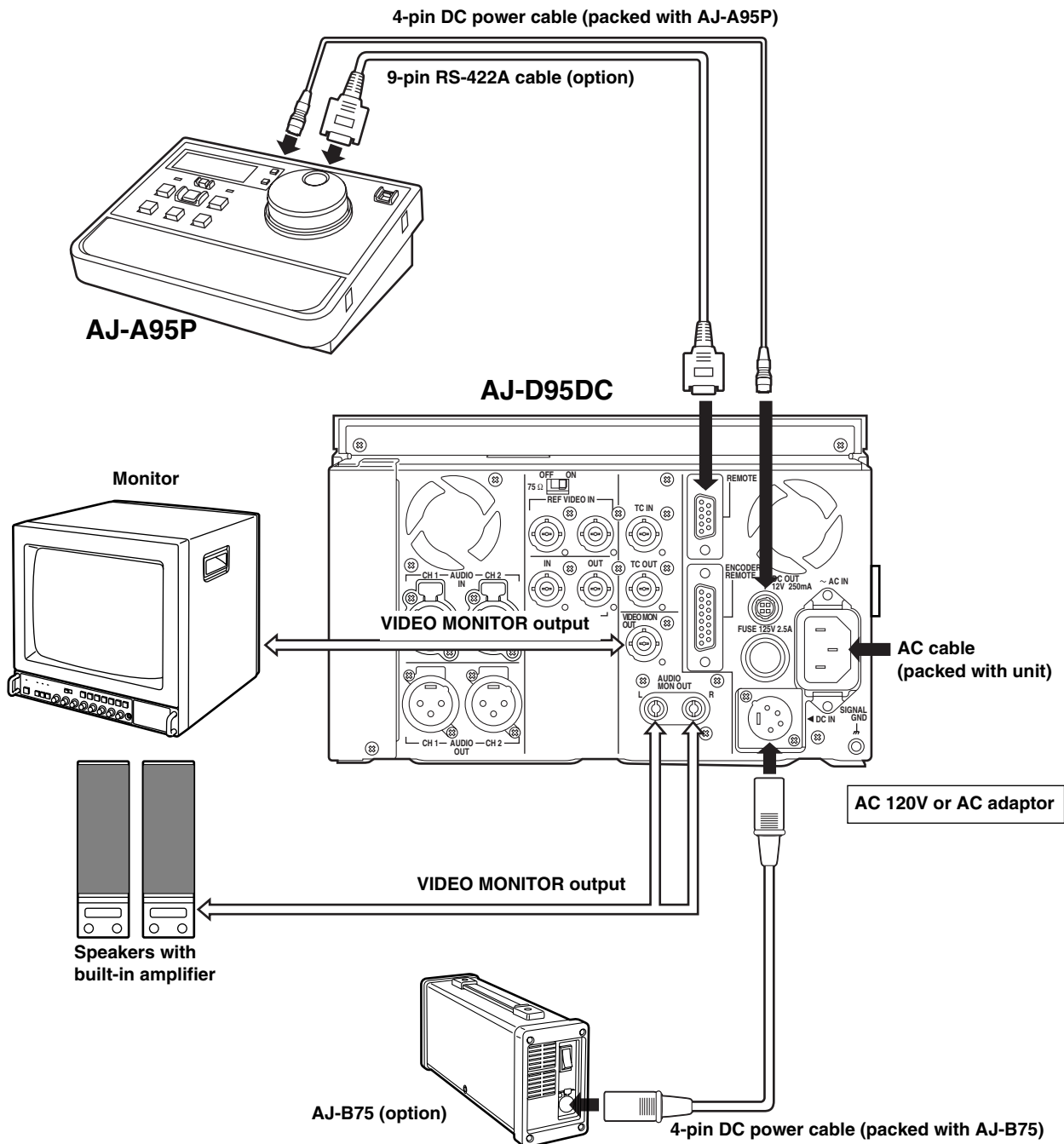

Video input signals and reference video input signals

When signals are to be input simultaneously to the VIDEO IN connectors and REF VIDEO IN connectors, make sure that the respective signals are synchronized.

If these signals are not synchronized, the E-E picture may dance, the advance of the time code display may slow down, the response to operations may slow down or some other phenomenon may occur (although the signals will be recorded normally).

In a case like this, a normal picture display can be restored by setting setup menu item No.600 to VF. (See page 35)

Tapes

<Notes>

DV tapes bearing either the “DV” or “MiniDV” logo for regular consumer applications cannot be used. Do not insert them into the unit.

Align the cassette with the center of the insertion slot, and push it in gently.

Once inserted, the cassette tape is loaded automatically.

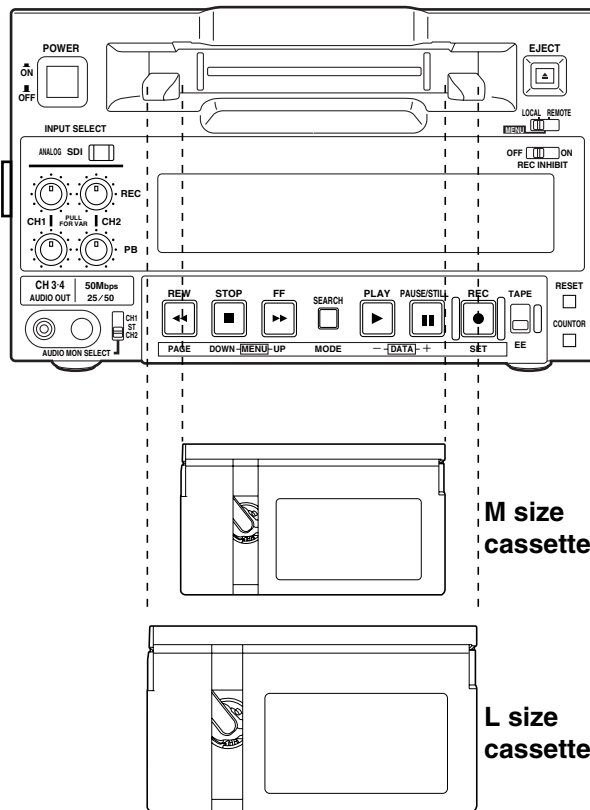

Types of tapes and their recording times

M size cassettes

- 50 Mbps mode

Tapes with a recording/playback length of up to 33 minutes:

- 25 Mbps mode

Tapes with a recording/playback length of up to 66 minutes:

AJ-P12MP, AJ-P24MP, AJ-P33MP, AJ-P46MP, AJ-P66MP

L size cassettes

- 50 Mbps mode

Tapes with a recording/playback length of up to 92 minutes:

- 25 Mbps mode

Tapes with a recording/playback length of up to 184 minutes:

AJ-P34LP, AJ-P66LP, AJ-P94LP, AJ-P126LP, AJ-5P92LP *

*For AJ-5P92LP cassette tapes recorded using the DVCPRO (25 Mbps) mode, use a VTR supporting DVCPRO (25 Mbps) 184 minute tapes.

Operations

Turning on the power/inserting the cassette

Before proceeding to operate the unit, check that it has been connected properly.

This unit must be placed on a level surface before any attempt is made to operate it.

1 Turn on the power.

2 Insert the cassette tape.

Insert the cassette tape at the designated position without forcing it in any way.

3 Check that the STOP lamp has lighted.

When the tape is inserted, the cylinder starts rotating automatically, the tape is loaded, and the stop mode is established.

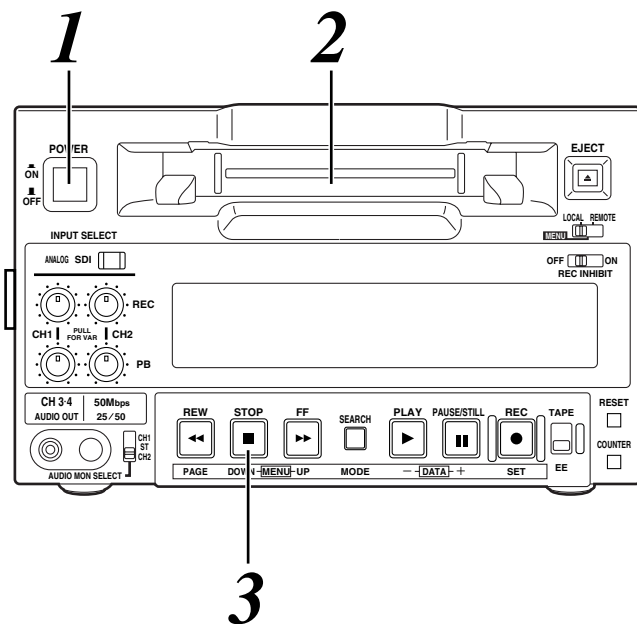

Stop mode

1 The stop mode is established when the STOP button is pressed.

The stop lamp lights, and the tape stops traveling.

- In order to protect the tape, the tape protection mode is established after the time set in setup menu item No.400 "STILL TIMER" has elapsed. (See page 32)

When the STOP, REW, FF or PLAY button is pressed, the corresponding mode is established.

<Precaution for setting STILL TIMER>

- At times when, for instance, the same part of the same tape is repeatedly used, the cumulative standby time in the same position will be increased. In order to protect the tape, make the standby time in the same position as short as possible.

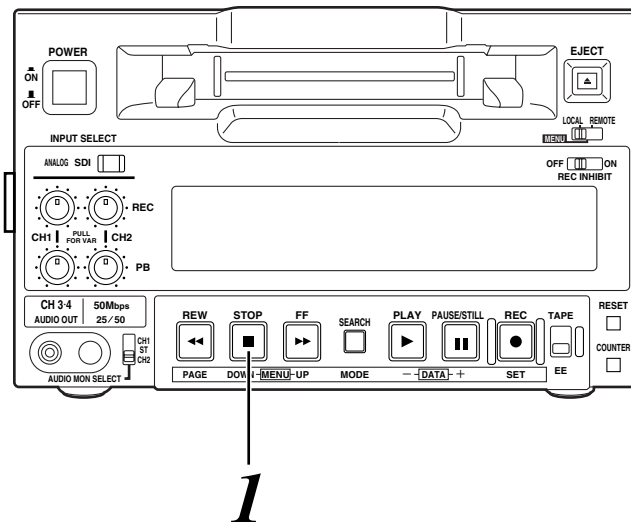

<Note>

The STOP button flashes when no reference video input signals are supplied if ON has been selected as the setup menu item No.104 setting. (See page 30)

Operations

Recording

1 Use the setup menu item No.007 to select recording in either the 50 Mbps mode or 25 Mbps mode.

(See page 29)

2 Set the accidental erasure prevention tab on the cassette to the “recording enable” position, and insert the tape.

3 Press the STOP button to set the unit to the stop mode.

4 1. **Selecting the input video and audio signals**
1) Connect the signals that are to be recorded.
2) Select the video and audio input signals using the INPUT SELECT button on the front panel.

2. Adjusting the audio levels

- Adjust the audio input signal levels.
The audio signals are recorded at the appropriate level when the audio recording level controls are in the pushed-in position.

5 Press the PLAY button while holding down the REC button.

The REC and PLAY lamps light, and recording commences.

If the setup menu item No. 110 “AUTO BACK” is set to “ALL,” the tape is first rewound two to three seconds from the position at which the REC and PLAY buttons were pressed, advanced, and then recording starts from the point at which the REC and PLAY buttons were pressed. This ensures that there are no gaps between recorded sections.

(See page 31.)

6 To stop recording, press the STOP button.

Recording now stops and the unit is set to the stop mode.

<Notes>

- It is not possible to select ANALOG for the video input signals and SDI for the audio input signals or vice versa— the same setting must be used for both sets of signals.
- The input signals cannot be recorded properly if a recording inhibit signal is recorded with them.
- Check that the SERVO lamp remains lighted during recording. The pictures played back will be disturbed if the lamp is flashing or off.

- When PB has been selected as the setup menu item No.105 setting, it will take two to three seconds for recording to commence after the REC and PLAY buttons have been pressed. (See page 30)

Set this menu item to REC to start the recording faster. However, with REC set for this item, it takes longer for the image to appear during playback after the PLAY button is pressed.

Pause/recording

(with back-space assemble recording)

1 Press the PAUSE/STILL button while the cassette tape is being played.

2 Press the REC button to set the unit to the REC PAUSE mode.

The monitor screen display now switches to the E-E picture.

If the setup menu item No. 110 “AUTO BACK” is set to “REC-P” or “ALL,” the tape is rewound two to three seconds from the position at which the PAUSE/STILL button was pressed.

(See page 31.)

3 Press the PAUSE/STILL button to start recording.

The tape travels to the position where the PAUSE/STILL button was pressed in step **1**, and recording commences.

<Notes>

- The E-E picture now appears on the screen.
- Recording with back-space assemble recording from the 50 Mbps mode to the 25 Mbps mode and vice versa is not possible.

4 Press the PAUSE/STILL button to pause recording.

If the setup menu item No. 110 “AUTO BACK” is set to “REC-P” or “ALL,” the tape is rewound two to three seconds from the position at which the PAUSE/STILL button was pressed and then pauses.

5 Repeat steps **3** and **4** above to add recorded sections with no gaps in between.

Operations

Playback

1 Insert the cassette tape.

2 Press the **PLAY** button.
Regular playback now commences.

3 To end playback, press the **STOP** button.
The unit is now set to the stop mode.

<Notes>

- Check that the SERVO lamp remains lighted during playback. The playback pictures will be disturbed if the lamp is flashing or off.
- Select the 50 Mbps mode or 25 Mbps mode— whichever corresponds to the recording mode of the tape— for the setup menu item No.007 setting. The recording mode can be identified and the playback mode can be switched automatically by selecting AUTO as the setup menu item No.008 setting. (See page 29)
However, in this case, it may take some moments for the mode to be identified.
- The pictures may be disturbed when playback starts.

Cue/review

Pressing the FF button or REW button while in the search mode (search still, forward search, reverse search, forward search still, reverse search still) causes fast forward or reverse playback to occur at the speed selected using setting No. 100 on the setup menu. (See page 30.)

Also, pressing the SEARCH button while in the fast forward or reverse rewind causes the speed to be reduced to the speed selected using setting No. 100 on the setup menu and fast forward or reverse playback to occur.

Pressing the PAUSE/STILL button during fast forward or reverse playback causes the tape to pause. Pressing the button a second time causes fast forward or reverse playback to resume.

VTR operating mode	Button pressed	Next VTR operation
Play or stop	SEARCH	Search still
	FF or REW	Fast forward or rewind
Fast forward	PLAY or STOP	Play or stop
	SEARCH	Forward search (fast forward playback)
Rewind	PLAY or STOP	Play or stop
	SEARCH	Reverse search (reverse playback)
Search still	PLAY or STOP	Play or stop
	FF	Forward search (fast forward playback)
	REW	Reverse search (reverse playback)
Forward search (fast forward playback)	SEARCH	Fast forward
	REW	Reverse search (reverse playback)
	PAUSE/STILL	Forward search still
Reverse search (reverse playback)	SEARCH	Rewind
	FF	Forward search (fast forward playback)
	PAUSE/STILL	Reverse search still
Forward search still	PAUSE/STILL, SEARCH or FF	Forward search (fast forward playback)
	REW	Reverse search (reverse playback)
Reverse search still	PAUSE/STILL, SEARCH or REW	Reverse search (reverse playback)
	FF	Forward search (fast forward playback)
All modes	PLAY	Play
	STOP	Stop

Still-picture playback

Press the PAUSE/STILL button during playback. To restore regular playback, press the PAUSE/STILL button again.

<Notes>

- No sound can be heard during still-picture playback.
- Noise may appear on the still picture.

Operations

Linear 0.3× speed playback

Pressing the SEARCH button when in play pause status causes the mode to switch to slow still. In this status, pressing the FF button or REW button causes operation to switch to linear 0.3× playback. Pressing the PAUSE/STILL button during linear 0.3× playback causes the tape to pause. Pressing the PAUSE/STILL button a second time causes linear 0.3× playback to resume.

<Note>

- Noise appears during linear 0.3× speed playback.

Variable speed playback

(When AJ-A95P is connected)

When the optional AJ-A95P remote controller is connected to the REMOTE connector, variable speed playback is enabled by operating the search dial on the AJ-A95P.

<Notes>

- Noise appears on the screen during playback at any tape speed except the normal tape speed (1×).
- During variable speed playback, the sound recorded on the analog cue track is played back.

VTR operating mode	Button pressed	Next VTR operation
Play	PAUSE/STILL	Play pause
Play pause	PAUSE/STILL or PLAY	Play
	SEARCH	Slow still
Slow still	PLAY	Play
	FF	Forward slow
	REW	Reverse slow
Forward slow	REW	Reverse slow
	SEARCH or PAUSE/STILL	Forward slow still
Reverse slow	FF	Forward slow
	SEARCH or PAUSE/STILL	Reverse slow still
Forward slow still	PAUSE/STILL, SEARCH or FF	Forward slow
	REW	Reverse slow
Reverse slow still	PAUSE/STILL, SEARCH or REW	Reverse slow
	FF	Forward slow
All modes	PLAY	Play
	STOP	Stop
All modes	STOP → FF	Fast forward
	STOP → REW	Rewind

Operations

Audio channels

The DVCPRO (25 Mbps) format has 2 audio channels whereas the DVCPRO 50 (50 Mbps) format has 4 audio channels.

However, this unit uses only two of the channels provided with the DVCPRO 50 (50 Mbps) format.

The settings for setup menu items No.711 and 712 are used to select recording or playback in the 50 Mbps or 25 Mbps mode. (See page 37)

<During recording> 50 Mbps mode

■ Analog signal input

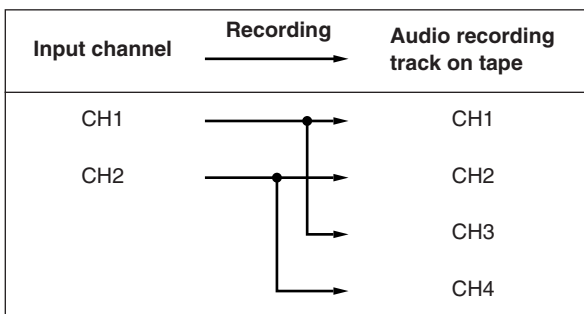

■ Serial digital multiplex signal input (SDI: option) (Setup menu item No.712 setting: CH1/CH2)

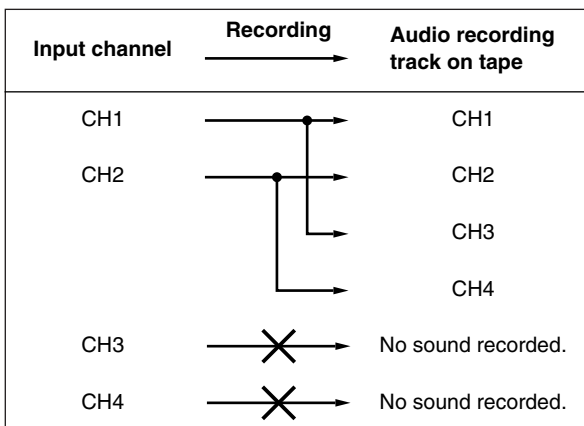

(Setup menu item No.712 setting: CH3/CH4)

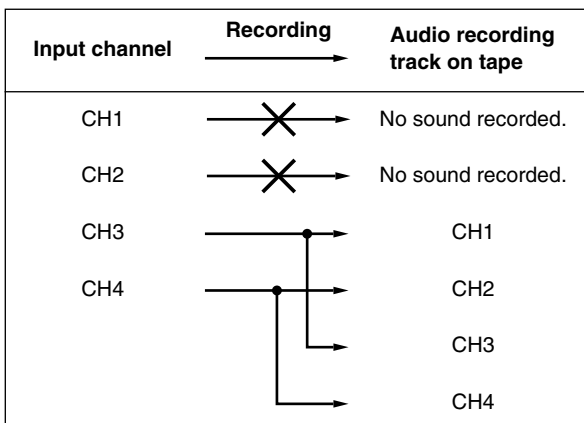

<During recording> 25 Mbps mode

■ Analog signal input

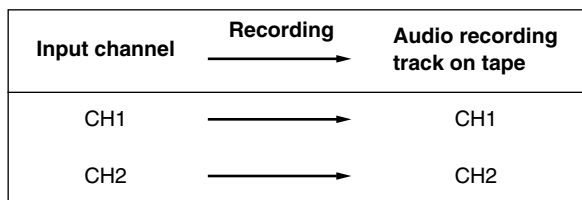

■ Serial digital multiplex signal input (SDI: option) (Setup menu item No.712 setting: CH1/CH2)

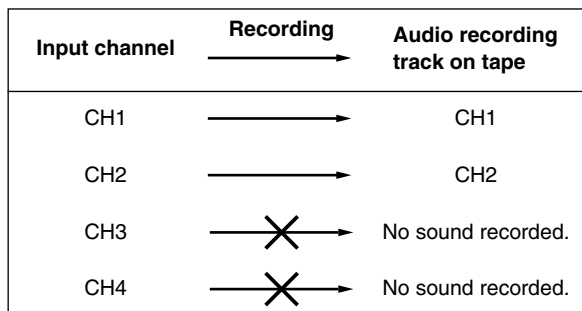

(Setup menu item No.712 setting: CH3/CH4)

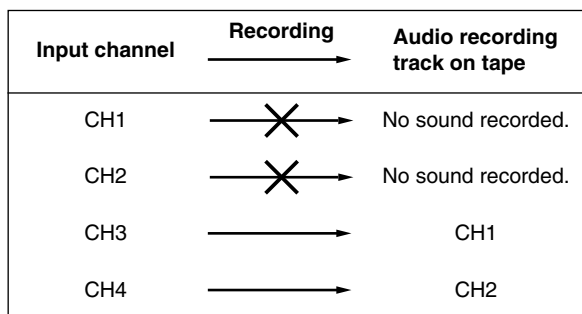

Operations

<During playback> 50 Mbps mode

■ Analog signal output

(Setup menu item No.711 setting: TR1/TR2)

Audio recording track on tape	Playback	Output channel
CH1	→	CH1
CH2	→	CH2
CH3	→ X	No sound played back.
CH4	→ X	No sound played back.

(Setup menu item No.711 setting: TR3/TR4)

Audio recording track on tape	Playback	Output channel
CH1	→ X	No sound played back.
CH2	→ X	No sound played back.
CH3	→	CH1
CH4	→	CH2

■ Serial digital multiplex signal output (SDI: option)

(Setup menu item No.711 setting: TR1/TR2)

Audio recording track on tape	Playback	Output channel
CH1	→	CH1
CH2	→	CH2
		CH3
		CH4
CH3	→ X	No sound played back.
CH4	→ X	No sound played back.

(Setup menu item No.711 setting: TR3/TR4)

Audio recording track on tape	Playback	Output channel
CH1	→ X	No sound played back.
CH2	→ X	No sound played back.
CH3	→	CH1
CH4	→	CH2
		CH3
		CH4

<During playback> 25 Mbps mode

■ Analog signal output

Audio recording track on tape	Playback	Output channel
CH1	→	CH1
CH2	→	CH2

■ Serial digital multiplex signal output (SDI: option)

Audio recording track on tape	Playback	Output channel
CH1	→	CH1
CH2	→	CH2
		CH3
		CH4

Time Codes/User's Bit

Time codes

Time codes are used to indicate the absolute position of the tape in hour, minute, second and frame increments: the time code signals generated by the time code generator (time code signal generator) are recorded on the tape and read by the time code reader (time code signal reader).

Time codes are written into the sub-code area (data area) on the helical track.

This enables the VTR's playback to be read out from the stop mode through slow-motion playback to high-speed playback.

The time code value appears on the display or is superimposed onto the screen.

TCR 00 : 07 : 04 : 24
 ↑ ↑ ↑ ↑
 Hours Minutes Seconds Frames

User's bit

Among the time code signals, the user's bit refers to the 32-bit (8-digit) information frame that is released to the user. It can be used to record the operator number or any other information.

The alphanumeric characters which can be used for the user's bit are numbers 0 through 9 and letters A, B, C, D, E and F.

Setting the time code

- 1 Set the VTR to the menu mode.**
(Set the LOCAL/MENU/REMOTE switch to the MENU position.)
- 2 Select setup menu item No.505 "TC PRESET."**
(See page 33)
- 3 The first digit flashes when the DATA+ button (PAUSE/STILL button) or DATA- button (PLAY button) is pressed.**
- 4 The digit whose value is to be changed is moved and flashes when the MENU-UP button (FF button) or MENU-DOWN button (STOP button) is pressed.**
- 5 Change the value using the DATA+ button (PAUSE/STILL button) or DATA- button (PLAY button).**
- 6 Upon completion of the settings, press the SET button (REC button).**
Operation now returns to the regular menu screen.
- 7 Set the LOCAL/MENU/REMOTE switch to the LOCAL or REMOTE position.**

<Notes>

- The current time code value is displayed as the default.
- The display is reset to 00:00:00:00 if the RESET button is pressed when TC PRESET is set.
- The time code cannot be used unless setup menu item No.504 "TC MODE" is set to "P-REC" or "P-FREE." (See page 33)
- When the MODE button (SEARCH button) is pressed without the SET button having been pressed upon completion of the settings, the time code setting is canceled, and operation returns to the regular menu screen.

Time Codes/User's Bit

Setting the user's bit

1 Set the VTR to the menu mode.
(Set the LOCAL/MENU/REMOTE switch to the MENU position.)

2 Select setup menu item No.506 "UB PRESET." (See page 33)

Now follow the same procedure as for setting the time code.

Time code/user's bit playback

1 Set the VTR to the stop mode.

2 Set to TC or UB using the COUNTER button.

TC: The time code appears on the display.

UB: The user's bit appears on the display.

- If the time code cannot be read, it is interpolated using the CTL signal.

3 Press the PLAY button.

Playback is now commenced, and the time code appears on the display.

When "ON" has been selected as the setup menu item No.002 setting, the time code will be superimposed onto the video signals from the MONITOR OUT connector. (See page 29)

<Notes>

- The colon between the seconds and frames changes to a period when a drop frame time code has been read.
- When the time code signal is missing, it is automatically interpolated by the CTL signal. The following appears on the display.

T * R 00 : 07 : 04 : 24

The colon between the seconds and frames changes to a period when a drop frame is read.

An asterisk (*) appears when the time code signal is missing.

(For superimposing only)

Superimposed Screens

When the unit's MONITOR OUT connectors have been connected to a TV monitor, the control signals, time codes, etc. can be displayed as abbreviations on the TV monitor screen.

This display can be set to ON or OFF by setting setup menu item No.002. (See page 29)

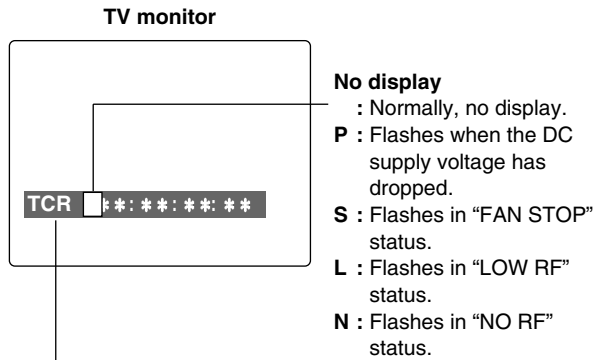

Abbreviations

- CTL** (control signal)
- TCR** (playback value of time code)
- UBR** (playback value of user's bit)
- REMAIN** (remaining tape)

Display position

The position of the superimposed display characters can be changed by setting setup menu items No.004 "CHARA H-POS" and No.005 "CHARA V-POS." (See page 29)

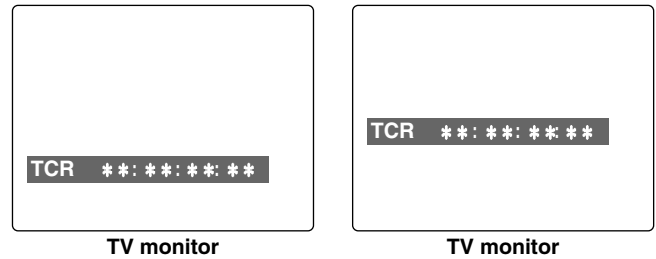

<Notes>

When the PAGE button and DATA+ button or DATA- button are pressed, the counter display appears temporarily on the TV monitor while these buttons are held down to enable the setting to be checked. Even while the PAGE button is pressed, the settings can be performed using the DATA+ button or DATA- button while the actual status is checked.

Display characters

The background of the superimposed display characters can be changed by setting setup menu item No.006 "CHARA TYPE." (See page 29)

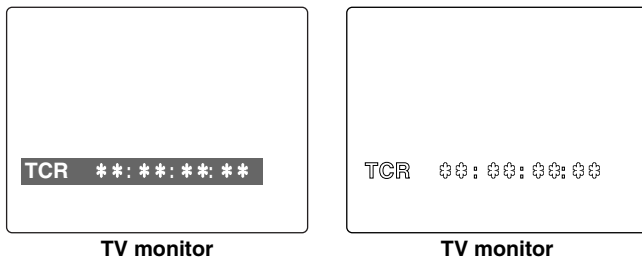

Superimposed Screens

Operation modes

The details to be displayed on the screen can be selected by setting setup menu item No.003 "DISPLAY SEL." (See page 29)

"TIME": Counter value

"T&STA": Counter value, VTR operation mode

"T&R": Counter value, amount of remaining tape

"T&S&R": Counter value, VTR operation mode, amount of remaining tape

TIME mode

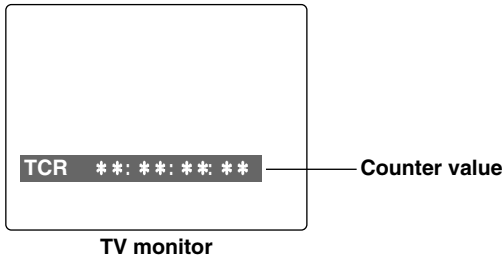

T&STA mode

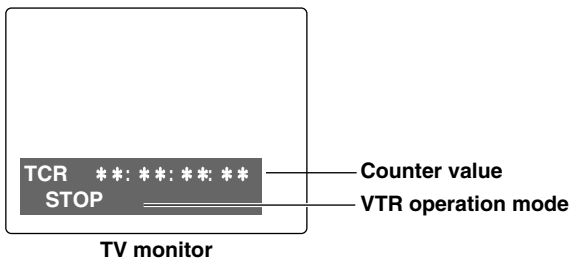

T&R mode

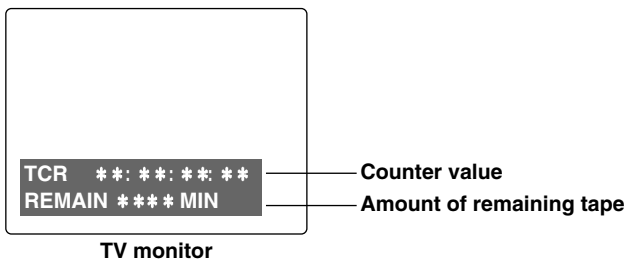

T&S&R mode

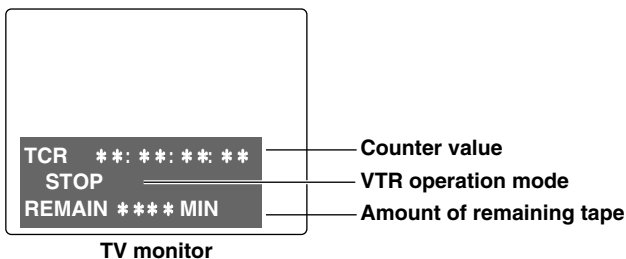

<Notes>

- When the beginning or end of the tape has been detected in the VTR operation mode, "BOT (beginning of tape)" or "EOT (end of tape)" is displayed at the beginning of the line.

Examples of what is displayed:

EOT STOP

(stop mode at end of tape)

BOT STANDBY OFF

(standby mode at beginning of tape)

- In the T&S&R mode, one of the following error displays appears on the third line (line with the amount of remaining tape).

[FAN STOP]:

This appears when the cooling fan has stopped.

When this happens, "E-10" and the counter value appear alternately on the front panel's counter display area.

[NO RF]:

This appears when a blank section has been detected on the tape.

"E-09" appears on the front panel's counter display area.

[SERVO NOT LOCKED]:

This appears when the servo is not locked.

"E-00" appears on the front panel's counter display area.

[LOW RF]:

This appears when there is no head output.

"E-01" appears on the front panel's counter display area.

[HIGH ERROR RATE]:

This appears when the error rate has deteriorated (when the channel condition appears in red).

"E-02" appears on the front panel's counter display area.

Setup (Initial Settings)

The unit's main settings can be performed and checked using the on-screen menus which are displayed on the video monitor connected to the unit. It is also possible to perform and check the settings using the item numbers and setting numbers which appear on the front panel's display area. A user setting memory is provided. The desired settings can be stored in this memory in advance for use during operation.

Setting method using on-screen menus

1 Set the LOCAL/MENU/REMOTE switch to the MENU position.

The unit is now set to the menu setting mode, and the menu screen appears on the video monitor.

SET-UP MENU	MAIN
	NO.00
* 00 SYSTEM	
000 BASIC	
100 OPERATION	
200 INTERFACE	
400 TAPE PROTECT	
500 TIME CODE	
600 VIDEO	
700 AUDIO	

In the menu setting mode, the REW, STOP, FF, SEARCH, PLAY, PAUSE/STILL and REC function buttons serve as the PAGE, MENU DOWN, MENU UP, MODE, DATA-, DATA+ and SET buttons.

2 Press the MENU-UP button or MENU-DOWN button to move the cursor (*) to the menu whose settings are to be changed.

3 Press the MODE button to set each item in turn.

To return to the menu screen, press the MODE button while holding down the PAGE button.

4 Press the MENU-UP button or MENU-DOWN button to move the cursor (*) to the menu item whose setting is to be changed.

The page can be scrolled up or down by pressing the MENU-UP button or MENU-DOWN button while holding down the PAGE button.

<Note>

Pressing the MODE button while setup menu item No. 622 (SET UP 25) or setup menu item No. 623 (SET UP 50) is selected displays a submenu.

While in this status, steps 4, 5 and 6 can be performed.

To return to the item menu, press the MODE button while holding down the PAGE button.

5 Press the DATA+ button or DATA- button to change the setting.

6 Press the SET button to enter the setting.

To change more than one menu item, repeat steps 4, 5 and 6 for each item.

<Note>

The setting can be canceled by pressing the MODE button.

When other items are to be changed without the setting having been entered, press the MODE button and then proceed with steps 4, 5 and 6.

7 Set the LOCAL/MENU/REMOTE switch to the LOCAL or REMOTE position.

This completes the menu settings.

How to return to the factory settings

1 Set the LOCAL/MENU/REMOTE switch to the MENU position.

The unit is now set to the menu setting mode, and the menu screen appears on the video monitor.

2 Press the RESET button.

The unit is set to the default setting mode, and the default setting screen appears on the video monitor.

Setup (Initial Settings)

SELECT	MODE
	* 0 ESCAPE
	1 LOAD
	2 SAVE
	3 PROTECT

- 3** Press the **MENU-UP** button or **MENU-DOWN** button to move the cursor to the **LOAD** position, and press the **SET** button.

The unit is set to the LOAD mode, and the load screen appears on the video monitor.

SET-UP MENU	<LOAD>
	* NO
	FACTORY (ALL)
	FACTORY (NOT SYSTEM)
	USER (ALL)
	USER (NOT SYSTEM)

- 4** Press the **MENU-UP** button or **MENU-DOWN** button to move the cursor to **FACTORY (ALL)**, and press the **SET** button.

- If this operation is performed with the cursor moved to **FACTORY (NOT SYSTEM)** instead, all the factory settings except for the **SYSTEM** menu settings will be restored.
- If this operation is performed with the cursor moved to **NO**, the factory settings are not restored, and operation is returned to the menu screen.

- 5** Set the **LOCAL/MENU/REMOTE** switch to the **LOCAL** or **REMOTE** position.

This completes the menu settings.

- 3** Press the **RESET** button.

The unit is set to the default setting mode, and the default setting screen appears on the video monitor.

SELECT	MODE
	* 0 ESCAPE
	1 LOAD
	2 SAVE
	3 PROTECT

- 4** Press the **MENU-UP** button or **MENU-DOWN** button to move the cursor to the **SAVE** position, and press the **SET** button.

The unit is set to the SAVE mode, and the save screen appears on the video monitor.

SET-UP MENU	<SAVE>
	* NO
	USER (ALL)
	USER (NOT SYSTEM)

- 5** Press the **MENU-UP** button or **MENU-DOWN** button to move the cursor to **USER (ALL)**, and press the **SET** button.

- If this operation is performed with the cursor moved to **USER (NOT SYSTEM)** instead, all the settings except for the **SYSTEM** menu settings will be updated.
- If this operation is performed with the cursor moved to **NO**, the settings are not updated, and operation is returned to the menu screen.

- 6** The screen for checking the **SAVE** operation appears. Press the **MENU-UP** button or **MENU-DOWN** button to move the cursor to the **YES** position, and press the **SET** button.

The settings are now saved in the memory.

SAVE OK?
* NO
YES

- 7** Set the **LOCAL/MENU/REMOTE** switch to the **LOCAL** or **REMOTE** position.

This completes the menu settings.

How to set the user defaults

- 1** Set the **LOCAL/MENU/REMOTE** switch to the **MENU** position.

The unit is now set to the menu setting mode, and the menu screen appears on the video monitor.

- 2** Perform steps **2** through **6** of “Setting method using on-screen menus,” and change the items to the desired settings.

(See page 23)

Setup (Initial Settings)

How to load the user defaults

- 1 Set the LOCAL/MENU/REMOTE switch to the MENU position.**

The unit is now set to the menu setting mode, and the menu screen appears on the video monitor.

- 2 Press the RESET button.**

The unit is set to the default setting mode, and the default setting screen appears on the video monitor.

SELECT	MODE
* 0	ESCAPE
1	LOAD
2	SAVE
3	PROTECT

- 3 Press the MENU-UP button or MENU-DOWN button to move the cursor to the LOAD position, and press the SET button.**

The unit is set to the LOAD mode, and the load screen appears on the video monitor.

SET-UP MENU	<LOAD>
* NO	
	FACTORY (ALL)
	FACTORY (NOT SYSTEM)
	USER (ALL)
	USER (NOT SYSTEM)

- 4 Press the MENU-UP button or MENU-DOWN button to move the cursor to USER (ALL), and press the SET button.**

- If this operation is performed with the cursor moved to USER (NOT SYSTEM) instead, operation will be performed on the basis of all the user settings saved in the memory except for the SYSTEM menu settings.
- If this operation is performed with the cursor moved to NO, no change is made to the user settings saved in the memory, and operation is returned to the menu screen.

- 5 Set the LOCAL/MENU/REMOTE switch to the LOCAL or REMOTE position.**

This completes the menu settings.

How to protect the menus

Opening the setup menu can be prevented even when the LOCAL/MENU/REMOTE switch on the front panel is set to the MENU position by setting the unit to the menu protect mode.

- 1 Set the LOCAL/MENU/REMOTE switch to the MENU position.**

The unit is now set to the menu setting mode, and the menu screen appears on the video monitor.

- 2 Press the RESET button.**

The unit is set to the default setting mode, and the default setting screen appears on the video monitor.

SELECT	MODE
* 0	ESCAPE
1	LOAD
2	SAVE
3	PROTECT

- 3 Press the MENU-UP button or MENU-DOWN button to move the cursor to the PROTECT position, and press the SET button.**

The unit is set to the menu protect setting mode, and a screen for checking whether to protect the menus appears on the video monitor.

MENU PROTECT OK?
* NO
YES

- 4 Press the MENU-UP button or MENU-DOWN button to move the cursor to the YES position, and press the SET button.**

The menu screen is now displayed.

Setup (Initial Settings)

5 Set the LOCAL/MENU/REMOTE switch to the LOCAL or REMOTE position.

The unit is set to the menu protect mode. When the LOCAL/MENU/REMOTE switch is set to the MENU position, the menu setting mode is not established, and "MENU PROTECTED" appears on the video monitor screen.

<Note>

If the LOCAL/MENU/REMOTE switch is set to the MENU position while holding down the COUNTER button on the front panel, the menu setting mode will be established and the regular menu settings can be performed even in the menu protect mode.

Perform steps 2 through 7 of "Setting method using on-screen menus." (See page 23)

How to release the menu protection

1 Set the LOCAL/MENU/REMOTE switch to the MENU position while holding down the COUNTER button on the front panel.

The unit is set to the menu setting mode, and the menu screen appears on the video monitor.

2 Perform steps 2 and 3 of "How to protect the menus." and a screen for checking whether to protect the menus appears on the video monitor.

<p>MENU PROTECT OK? * NO YES</p>
--

3 Press the MENU-UP button or MENU-DOWN button to move the cursor to the NO position, and press the SET button.

The menu protection is now released.

How to display the DIAG menu

This unit has a function for displaying hour meters, software version and the deck's serial number on the video monitor.

1 Set the LOCAL/MENU/REMOTE switch to the MENU position while holding down the EJECT button.

The unit is set to the diagnosis display mode, and "HOURS METER" appears on the video monitor.

DIAG-MENU	HOURS METER
Ser *****	
H00 OPERATION	00000H
H01 DRUM RUN	00000H
H02 TAPE RUN	00000H
H03 THREADING	00000T
H11 DRUM RUN r	00000H
H12 TAPE RUN r	00000H
H13 THREADING r	00000T

Any item with "r" can be reset when servicing is performed.

2 While the hour meters are displayed, press the MENU-UP button or MENU-DOWN button while holding down the PAGE button.

The deck's serial number and software version are displayed on the video monitor.

DIAG-MENU	VERSION
<NTSC>	
FRONT	1.**-**
IF	1.**-**-**.
AV-SYSCON	1.**-**-**.
DV	1.**-**-**.
CYLINDER	1.**-**-**.
REEL	1.**-**-**.

When the MENU-UP button or MENU-DOWN button is pressed again while holding down the PAGE button, operation returns to the hour meter display.

3 Set the LOCAL/MENU/REMOTE switch to the LOCAL or REMOTE position.

Operation now returns to the normal mode.

Setup Menus

SYSTEM menu

Item		Setting		Description of setting
No.	Superimposed display	No.	Superimposed display	
00	ENCODER SEL	0000 <u>0001</u>	REMOTE LOCAL	For setting whether the encoder adjustments (for the analog video output signals) are to be performed by the external encoder remote controller or the unit. 0: Adjustments are performed by the external encoder remote controller. 1: Adjustments are performed by the unit.
01	VIDEO LEVEL	0000 : <u>0128</u> : 0255	-128 : 0 : 127	For setting the video level as part of the encoder adjustments performed by the unit. Maximum variation range: ± 3 dB
02	SET UP	0000 : <u>0128</u> : 0255	-128 : 0 : 127	For setting the setup amount as part of the encoder adjustments performed by the unit. Maximum variation range: 10 IRE
03	HUE	0000 : <u>0128</u> : 0255	-128 : 0 : 127	For setting the hue as part of the encoder adjustments performed by the unit. Maximum variation range: ± 25 degrees
04	CHROMA LEVEL	0000 : <u>0128</u> : 0255	-128 : 0 : 127	For setting the chroma level as part of the encoder adjustments performed by the unit. Maximum variation range: ± 3 dB
05	SYSTEM H	0000 : : : : 0255	-128 : : : : 127	For setting the horizontal phase as part of the encoder adjustments performed by the unit. Maximum variation range: ± 8 μ s
06	SC COARSE	0000 0001 0002 0003	0 90 180 270	For coarsely adjusting SC COARSE as part of the encoder adjustments performed by the unit. Variation range: 4 positions of 90 degrees each
07	SC FINE	0000 : : : 0255	-128 : : : 127	For finely adjusting SC PHASE as part of the encoder adjustments performed by the unit. Maximum variation range: ± 45 degrees Together with the SC COARSE adjustment, 360 degrees are covered.
08	SCH COARSE	0000 0001 0002 0003	0 90 180 270	For coarsely adjusting SCH. Variation range: 4 positions of 90 degrees each

The underlining indicates the factory setting.

<Notes>

- Item No. 01, 02, 03 and 04 are initialized only when "ALL" is selected for the initialization operation.
- The () setting items are not initialized by the regular menu resetting operation.

Setup Menus

BASIC menu

Item		Setting		Description of setting
No.	Superimposed display	No.	Superimposed display	
000	LOCAL ENA	0000 <u>0001</u> 0002	DIS ST&EJ ENA	For setting the switches which can be operated on the front panel when the REMOTE/LOCAL switch has been set to REMOTE. 0: None of the switches can be operated. 1: Only the STOP and EJECT switches can be operated. 2: All operations are possible except for the COUNTER button and RESET button.
001	TAPE TIMER	<u>0000</u> 0001	<u>±12h</u> 24h	For setting the CTL counter to the 12-hour or 24-hour display system. 0: 12-hour display system 1: 24-hour display system
002	SUPER	0000 <u>0001</u>	OFF ON	For setting whether to display the time code, etc. onto the video monitor output by superimposing it. 0: Superimposed data is not displayed. 1: Superimposed data is displayed.
003	DISPLAY SEL	0000 0001 0002 <u>0003</u>	TIME T&STA T&R T&S&R	For setting what is to be displayed by superimposing onto the video monitor output. 0: Only the time is displayed. 1: The time and operation status are displayed. 2: The time and amount of remaining tape are displayed. 3: The time, operation status and amount of remaining tape are displayed.
004	CHARA H-POS	0000 : <u>0004</u> : : 0008	0 : 4 : : 8	For setting the character position in the horizontal direction for the superimposed display.
005	CHARA V-POS	0000 : : <u>0022</u>	0 : : 22	For setting the character position in the vertical direction for the superimposed display. : : A setting from 0 to 18 is valid in the T&S&R mode (3-line display). 22 A setting from 0 to 20 is valid in the T&STA mode or T&R mode (2-line display).
006	CHARA TYPE	<u>0000</u> 0001	WHITE W/OUT	For setting the type of superimposed display and menu display. 0: White characters are displayed on a black background. 1: White characters with black borders are displayed.
007	SYS FORMAT	<u>0000</u> 0001	50M 25M	For setting the unit's recording and playback format. 0: 50 Mbps mode 1: 25 Mbps mode
008	PB FORMAT	0000 <u>0001</u>	MANUAL AUTO	For setting the format during tape playback. 0: Setting is based on the setting selected for menu item No.007 (SYS FORMAT). 1: Setting is based on the format recorded on the tape.

The underlining indicates the factory setting.

<Notes>

- If the PAGE button and DATA+ button or DATA- button are pressed when the CHARA H-POS or CHARA V-POS item has been set, the counter display appears temporarily while this button is held down to enable the setting to be checked.
Even while the PAGE button is pressed, the settings can be performed using the DATA+ button or DATA- button while the actual status is checked.

Setup Menus

OPERATION menu

Item		Setting		Description of setting
No.	Superimposed display	No.	Superimposed display	
100	SEARCH SPEED	<u>0000</u> 0001	<u>X4.1</u> X8.4	For setting the speed at which the tape is to be decelerated when the search switch on the front panel has been pressed. 0: 4.1 × normal tape speed 1: 8.4 × normal tape speed
101	SHTL MAX	0000 0001 <u>0002</u>	X8.4 X16 <u>X32</u>	For setting the maximum speed in the shuttle mode when the external controller connected to the 9-pin remote connector is used. 0: 8.4 × normal tape speed 1: 16 × normal tape speed 2: 32 × normal tape speed
102	FF. REW MAX	0000 0001 <u>0002</u>	X16 X32 <u>X60</u>	For setting the maximum fast forward and rewind speed. 0: 16 × normal tape speed 1: 32 × normal tape speed 2: 60 × normal tape speed <Note> When the 50M mode has been selected as the menu item No.007 (SYS FORMAT) setting, the tape will run at 32 × the normal tape speed even if 60 × has been selected.
103	AUDIO MUTE	<u>0000</u> 0001	OFF ON	For setting the status until the audio signals are output when the unit has been transferred from the stop mode or search mode to play mode. (This item functions only with PCM audio signals.) 0: It takes a shorter time until the audio signals are output. 1: The audio signals are stabilized before they are output.
104	REF ALARM	0000 <u>0001</u>	OFF ON	For setting whether a warning is to be displayed when the reference video signal has not been connected. 0: No warning is displayed. 1: A warning is displayed (the stop button flashes when there is a warning).
105	STOP MODE	0000 <u>0001</u>	REC <u>PB</u>	For setting the mode of the digital circuit in the stop mode. 0: The digital circuit is set to the REC system. It takes a shorter time for operation to transfer to the REC mode. In this case, the E-E mode is established regardless of the position of the TAPE/EE switch. 1: The digital circuit is set to the PB system. It takes a shorter time for operation to transfer to the playback mode.
106	HUMID OPE	<u>0000</u> 0001	OFF ON	For setting whether to ignore condensation when it has formed and continue with operation. 0: Unit does not continue to operate when condensation has formed. 1: Unit continues to operate when condensation has formed in which case it cannot be guaranteed that the unit will operate normally. <Note> Due to the possibility that the tape may be damaged, this item should normally be set to 0 (no operation).
107	WIDE MODE	0000 <u>0001</u>	WIDE <u>NORMAL</u>	For setting whether to perform recording in the wide mode. 0: Recording is performed in the wide mode. 1: Recording is performed in the 4:3 normal mode.
108	AUTO REW	<u>0000</u> 0001	OFF ON	For setting whether to automatically rewind the tape to the beginning when the tape end has been detected by a recording, playback or search operation. 0: The tape is not rewind. 1: The tape is rewind to its beginning.

The underlining indicates the factory setting.

Setup Menus

OPERATION menu

Item		Setting		Description of setting
No.	Superimposed display	No.	Superimposed display	
109	MEMORY STOP	<u>0000</u> 0001	OFF ON	For setting whether to stop the tape when the CTL counter reading becomes zero during fast forwarding or rewinding. (This item functions only in the CTL mode.) 0: The tape is not stopped. 1: The tape is stopped.
110	AUTO BACK	0000 <u>0001</u> 0002	OFF <u>REC-P</u> ALL	For setting the operating method in the no-gap mode. (Specifies whether or not to use the AUTO BACK function, which rewinds the tape for a few seconds to eliminate gaps and distortion between segments.) 0: No AUTO BACK function. 1: Auto back is performed when switching to the REC PAUSE mode, after which the unit remains in REC PAUSE status. (When PAUSE is cancelled, the tape is advanced and then recording starts.) 2: In addition to the functions of setting 0001 "REC-P," AUTO BACK is performed when switching to the REC PLAY mode, immediately after which the tape is advanced and recording starts.
111	AFTER CUE-UP	<u>0000</u> 0001	STOP STILL	For setting the status after cue-up. 0: For stopping the tape in the stop mode. 1: For stopping the tape in the still mode.
112	CAP LOCK	<u>0000</u> 0001	2F 4F	For setting the capstan lock mode. 0: Capstan locks at 2F. 1: Capstan locks at 4F.
113	BATTERY SEL	<u>0000</u> 0001 0002	<u>NiCd-12</u> NiCd-13 NiCd-14	For setting the type of battery. 0: 12V battery 1: 13V battery 2: 14V battery
114	FRZ MODE SEL	<u>0000</u> 0001	<u>DIS</u> STBOFF	For selecting the output picture in the STANDBY OFF (HALF LOADING) mode when the TAPE/EE switch has been set to TAPE. 0: The output picture is muted. 1: The playback picture is frozen for output as soon as the STANDBY OFF (HALF LOADING) mode is established.
115	EJECT EE SEL	0000 <u>0001</u>	EE <u>BLACK</u>	For selecting the video output and audio output while the tape was being ejected when the TAPE/EE switch has been set to TAPE. 0: The E-E picture and E-E sound are output. 1: The E-E picture and E-E sound are muted.

The underlining indicates the factory setting.

INTERFACE menu

Item		Setting		Description of setting
No.	Superimposed display	No.	Superimposed display	
200	ID SEL	<u>0000</u> 0001	<u>OTHER</u> DVCPRO	For setting the ID information to be returned to the controller. 0: 20 25H is returned. 1: The DVCPRO unit's own ID (F0 33H) is returned.

The underlining indicates the factory setting.

Setup Menus

TAPE PROTECT menu

Item		Setting		Description of setting
No.	Superimposed display	No.	Superimposed display	
400	STILL TIMER	0000 0001 0002 0003 0004 0005 0006 0007 <u>0008</u>	0.5S 5S 10S 20S 30S 40S 50S 1min <u>2min</u>	For setting the time taken until the tape protection mode is established when the unit has been left standing in the stop or still mode. (Unit: S = seconds, min = minutes)
401	SRC PROTECT	<u>0000</u> 0001	STEP HALF	For setting the tape protection mode operation when the unit has been left standing in the still mode. 0: STEP FWD 1: STANDBY OFF (HALF LOADING) <Note> When STEP FWD has been selected, the unit is automatically transferred to the STANDBY OFF (HALF LOADING) mode when the total length of time it has been left standing in the still mode reaches 30 minutes.
402	DRUM STDBY	0000 <u>0001</u>	OFF <u>ON</u>	For setting the drum operation in the STANDBY OFF (HALF LOADING) mode. 0: The drum rotation is stopped. 1: The drum rotation is continued.
403	STOP PROTECT	0000 <u>0001</u>	STEP HALF	For setting the tape protection mode operation when the unit has been left standing in the stop mode. 0: STEP FWD 1: STANDBY OFF (HALF LOADING) <Note> When STEP FWD has been selected, the unit is automatically transferred to the STANDBY OFF (HALF LOADING) mode when the total length of time it has been left standing in the stop mode reaches 30 minutes.

The underlining indicates the factory setting.

Setup Menus

TIME CODE menu

Item		Setting		Description of setting
No.	Superimposed display	No.	Superimposed display	
500	VITC BLANK	<u>0000</u> 0001	BLANK THRU	For setting whether the VITC signal is to be output to the composite video output. 0: VITC signal is not output. 1: VITC signal is output.
501	VITC POS-1	0000 : <u>0006</u> : 0010	10L : <u>16L</u> : 20L	For setting the position where the VITC signal is to be inserted. (The same line as the one used for VITC POS-2 cannot be set.)
502	VITC POS-2	0000 : <u>0008</u> : 0010	10L : <u>18L</u> : 20L	For setting the position where the VITC signal is to be inserted. (The same line as the one used for VITC POS-1 cannot be set.)
503	TCG REGEN	<u>0000</u> 0001 0002	TC&UB TC UB	For setting the signal which is to be regenerated when the time code generator (TCG) is in the regeneration mode. 0: Both the time code and user's bit are regenerated. 1: Only the time code is regenerated. 2: Only the user's bit is regenerated.
504	TC MODE	0000 0001 <u>0002</u> 0003 0004	P-REC P-FREE I-REG E-VITC E-LTC	For setting the TCG mode. 0: The time code is counted up simultaneously with the recording. 1: The time code is counted up irrespective of the VTR mode. 2: The time code is counted up in such a way that it follows on the tape. 3: The mode is synchronized with VITC which is superimposed onto the video input. 4: The mode is synchronized with LTC in the TC input.
505	TC PRESET			For setting the time code value when P-REC or P-FREE has been selected as the TCG mode setting by the menu item No.504 (TC MODE). After the + or - button is pressed, select the digit to be changed using the UP or DOWN button, and then change the value using the + or - button again.
506	UB PRESET			For setting the user's bit value when P-REC or P-FREE has been selected as the TCG mode setting by the menu item No.504 (TC MODE). After the + or - button is pressed, select the digit to be changed using the UP or DOWN button, and then change the value using the + or - button again.
507	BINARY GP	<u>0000</u> 0001 0002 0003 0004 0005 0006 0007	<u>000</u> 001 010 011 100 101 110 111	For setting the usage status of the user's bit which is generated by the TCG. 0: NOT SPECIFIED (character set is not specified) 1: ISO CHARACTER (8-bit character set complying with the ISO-646 or ISO-2022 standard) 2: (Undefined) 3: (Undefined) 4: (Undefined) 5: PAGE/LINE (page/line multiplexing system complying with SMPTE262M standard) 6: (Undefined) 7: (Undefined)
508	PHASE CORR	<u>0000</u> 0001	OFF ON	For setting whether to control the phase compensation of the linear time code which is generated by the TCG. 0: No phase correction control is exercised. (LTC phase correction bit: 0) 1: Phase correction control is exercised. (LTC phase correction bit: 1)

The underlining indicates the factory setting.

Setup Menus

TIME CODE menu

Item		Setting		Description of setting
No.	Superimposed display	No.	Superimposed display	
509	TCG CF FLAG	<u>0000</u> 0001	<u>OFF</u> ON	For setting whether to add the CF flag of the TCG to the CF bit (color frame bit) when P-REC or P-FREE has been selected as the TCG mode setting by the menu item No.504 (TC MODE). 0: CF flag is not added. (LTC CF bit: 0) 1: CF flag is added. (LTC CF bit: 1)
510	DF MODE	<u>0000</u> 0001	<u>DF</u> NDF	For setting the CTL and TCG drop frame mode. 0: Used in the drop frame mode. 1: Used in the non-drop frame mode.

The underlining indicates the factory setting.

Setup Menus

VIDEO menu

Item		Setting		Description of setting	
No.	Superimposed display	No.	Superimposed display		
600	OUT VSYNC	<u>0000</u> 0001	<u>N-VF</u> VF	For setting whether to float the vertical sync position of the video output in order to input the video output phase during E-E mode recording. 0: Vertical sync position is not floated. 1: Vertical sync position is floated.	
601	V-MUTE SEL	0000 <u>0001</u>	N-MUTE <u>LOW RF</u>	For setting whether to mute the video signals when LOW RF or NO RF has occurred during playback. 0: The video signals are not muted (the picture is frozen). 1: The video signal picture is muted (the screen goes blank).	
602	CC (F1) BLANK	0000 <u>0001</u>	BLANK <u>THRU</u>	For setting ON or OFF for the closed caption signals in field No.1. 0: Signals are forcibly blanked. 1: Signals are not blanked.	
603	CC (F2) BLANK	0000 <u>0001</u>	BLANK <u>THRU</u>	For setting ON or OFF for the closed caption signals in field No.2. 0: Signals are forcibly blanked. 1: Signals are not blanked.	
604	FREEZE SEL	<u>0000</u> 0001 0002	<u>FIELD1</u> FIELD2 FRAME	For setting the freeze mode of still pictures. 0: Field freeze (field No.1) 1: Field freeze (field No.2) 2: Frame freeze	
605	EDH	0000 <u>0001</u>	OFF <u>ON</u>	For setting whether to superimpose EDH onto the serial output. (This function works when the optional SDI input/output board has been installed. When it has not been installed, "N/A" is displayed, and the function does not work.) 0: EDH is not superimposed. 1: EDH is superimposed.	
606	INPUT C KILL	0000 <u>0001</u>	B/W <u>AUTO</u>	For setting the color killer processing for the video input signals. 0: The video signals are forcibly set to the black-and-white mode. 1: The video signals are processed automatically.	
607	IN FRM DET	0000 <u>0001</u>	FORCED <u>AUTO</u>	For setting frame detection processing during input. 0: Frame detection is performed all the time. 1: Frame detection is prohibited when non-standard color signals are input.	
622	SETUP 25			For setting 7.5% setup processing to be performed on input and output signals in the 25 Mbps mode. (The 00 and 01 settings on the submenu can be displayed by pressing the MODE button.)	
	00	CMPST IN	0000 <u>0001</u>	THRU <u>CUT</u>	This selects the 7.5% setup processing for the input composite signal. 0: The signal is recorded in its original form. 1: The signal is recorded with the 7.5% setup removed.
	01	CMPST OUT	0000 <u>0001</u>	THRU <u>ADD</u>	This selects the 7.5% setup processing for the output composite signal. 0: The signal is output in its original form. 1: The signal is output with the 7.5% setup added.
623	SETUP 50			For setting 7.5% setup processing to be performed on input and output signals in the 50 Mbps mode. (The 00 and 01 settings on the submenu can be displayed by pressing the MODE button.)	
	00	CMPST IN	0000 <u>0001</u>	THRU <u>CUT</u>	This selects the 7.5% setup processing for the input composite signal. 0: The signal is recorded in its original form. 1: The signal is recorded with the 7.5% setup removed.
	01	CMPST OUT	0000 <u>0001</u>	THRU <u>ADD</u>	This selects the 7.5% setup processing for the output composite signal. 0: The signal is output in its original form. 1: The signal is output with the 7.5% setup added.

The underlining indicates the factory setting.

Setup Menus

AUDIO menu

Item		Setting		Description of setting
No.	Superimposed display	No.	Superimposed display	
700	CH1 IN LV	0000 <u>0001</u> 0002 0003	4dB <u>0dB</u> -3dB -20dB	For setting the audio input (CH1) reference level.
701	CH2 IN LV	0000 <u>0001</u> 0002 0003	4dB <u>0dB</u> -3dB -20dB	For setting the audio input (CH2) reference level.
702	CH1 OUT LV	0000 <u>0001</u> 0002 0003	4dB <u>0dB</u> -3dB -20dB	For setting the audio output (CH1) reference level.
703	CH2 OUT LV	0000 <u>0001</u> 0002 0003	4dB <u>0dB</u> -3dB -20dB	For setting the audio output (CH2) reference level.
704	EMPHASIS	0000 <u>0001</u>	OFF ON	For setting emphasis ON or OFF.
705	MONI SEL	0000 <u>0001</u>	PLY PCM PLY CUE	For setting the audio signals during playback. 0: PCM audio signals are output. 1: CUE audio signals are output.
706	REC CUE	0000 <u>0001</u> 0002	CH1 CH2 <u>CH1+2</u>	For setting the audio input signals which are to be recorded on the cue track. 0: CH1 input signals are recorded. 1: CH2 input signals are recorded. 2: CH1 and CH2 input signals are mixed and recorded.
707	PB FADE	0000 <u>0001</u> 0002	AUTO CUT FADE	For setting the monitor output and headphone output sound during playback. 0: The sound complies with the status during recording. 1: The sound is forcibly cut. 2: The sound is forcibly faded.
708	MONITOR MIX	0000 <u>0001</u>	STEREO CH1+2	For setting the audio monitor output method. (This function works when the audio monitor selector switch on the front panel is set to the ST position.) 0: The sound is output in stereo (with the left channel sound from the L connector and right channel sound from the R connector). 1: The sound is mixed (and mixed sound is output at both connectors).
709	H.PHONE MIX	0000 <u>0001</u>	STEREO CH1+2	For setting the headphone output. (This function works when the audio monitor selector switch on the front panel is set to the ST position.) 0: The sound is output in stereo. 1: The sound is mixed (when monaural headphones are used).
710	CUE OUT SEL	0000 <u>0001</u>	OFF ON	For setting whether the analog cue signals are to be output to the audio output (main line system). 0: The analog cue signals are not output. PCM audio signals are output during playback; no sound is output in all other modes. 1: The analog cue signals are output. PCM audio signals are output during playback; analog cue signals are output in all other modes.

The underlining indicates the factory setting.

Setup Menus

AUDIO menu

Item		Setting		Description of setting
No.	Superimposed display	No.	Superimposed display	
711	PB AUDIO SEL	<u>0000</u> 0001	<u>TR1/2</u> TR3/4	For setting the audio tracks to be played back. (This function works in the 50 Mbps mode.) 0: The sound recorded on tracks 1 and 2 is played back. 1: The sound recorded on tracks 3 and 4 is played back.
712	SDI IN SEL	<u>0000</u> 0001	<u>CH1/2</u> CH3/4	For setting the audio SDI input channels for recording. (This function works when the optional SDI input/output board has been installed. When it has not been installed, "N/A" is displayed, and the function does not work.) 0: The SDI input CH1 and CH2 sound is recorded. 1: The SDI input CH3 and CH4 sound is recorded.
713	AUD REC IN	0000 <u>0001</u>	CUT <u>FADE</u>	For setting the audio processing method at the point when digital audio recording is commenced. 0: Cut processing 1: V fade processing
714	EMBEDDED AUD	0000 <u>0001</u>	OFF <u>ON</u>	For setting sound multiplexing. (This function works when the optional SDI input/output board has been installed. When it has not been installed, "N/A" is displayed, and the function does not work.) 0: The sound is not multiplexed. 1: The sound is multiplexed.
715	AUDIO IN SEL	<u>0000</u> 0001 0002	<u>SW</u> ANALOG SDI	This sets the audio signal input. (This function works when the optional SDI input/output board has been installed. When it has not been installed, "N/A" is displayed, and the function does not work.) 0: Interlocks with the settings of the INPUT SELECT button. 1: Fixes the analog signal input setting. 2: Fixes the SDI signal input setting.

The underlining indicates the factory setting.

Error Messages

When trouble has occurred in the unit, one of the following error messages will be displayed on the tape counter.

Error No.	Description	Error No.	Description
- d -	Condensation (dew) has formed.	E — 31	This appears when the loading operations fails to be completed within 4 seconds.
E — 00	This appears when the servo has failed to lock for more than 3 seconds. If "T&S&R" has been selected as the setup menu item No.003 setting, "SERVO NOT LOCKED" is displayed on the third line (amount of remaining tape line) of the monitor screen.	E — 32	This appears when the unloading operations fails to be completed within 4 seconds.
E — 01	This appears when there is no head output (due to clogging, etc.) for more than 3 seconds. "L" is displayed on the first line (counter line) of the monitor screen. If "T&S&R" has been selected as the setup menu item No.003 setting, "LOW RF" is displayed on the third line (amount of remaining tape line) of the monitor screen.	E — 41	This appears when the FG signal (rotational speed signal) fails to be output from the cylinder motor.
E — 02	This appears when the error rate has deteriorated (when the channel condition lamps have turned red). If "T&S&R" has been selected as the setup menu item No.003 setting, "HIGH ERROR RATE" is displayed on the third line (amount of remaining tape line) of the monitor screen.	E — 42	This appears when the PG signal (phase signal) fails to be output from the cylinder motor.
E — 09	This appears when a blank portion on the tape has been detected. "N" is displayed on the first line (counter line) of the monitor screen. If "T&S&R" has been selected as the setup menu item No.003 setting, "NO RF" is displayed on the third line (amount of remaining tape line) of the monitor screen. When all the following conditions are satisfied, the part of the tape concerned is recognized as a blank part. <ul style="list-style-type: none"> ● When there is no output from any of the heads ● When the playback data cannot be read ● When there is no CTL signal 	E — 43	This appears when the cylinder motor speed is abnormally high.
E — 10	This appears when the fan motor has stopped. "S" is displayed on the first line (counter line) of the monitor screen. If "T&S&R" has been selected as the setup menu item No.003 setting, "FAN STOP" is displayed on the third line (amount of remaining tape line) of the monitor screen. The power will be automatically turned off if the fan remains stopped for more than 5 minutes or so.	E — 44	This appears when the cylinder motor speed is abnormally low.
E — 11	This appears when the reel base which operates in accordance with the size of the tape has locked up for more than 2.5 seconds.	E — 51	This appears when the FG signal (rotational speed signal) fails to be output from the capstan motor.
E — 21	This appears when the cassette down operation fails to take place even when 4 seconds have elapsed after the cassette was inserted. Alternatively, it appears when the cassette fails to be ejected even when 4 seconds have elapsed after its ejection operation was performed.	E — 52	This appears when the capstan motor speed is abnormally high.
		E — 53	This appears when the capstan motor speed is abnormally low.
		E — 61	This appears when the supply reel motor has locked up.
		E — 62	This appears when the take-up reel motor has locked up.
		E — 63	This appears when the supply reel motor speed is abnormally high.
		E — 64	This appears when the take-up reel motor speed is abnormally high.
		E — 65	This appears when abnormal tension has been detected.
		E — 66	This appears when the start or end processing operation fails to be completed within 7 seconds.
		E — 67	This appears when there is a communication error between SERVO and AVSYS. There is a problem with the data.
		E — 68	This appears when there is a communication error between SERVO and AVSYS. The data is fixed to high or low.
		E — 69	This appears when there is a problem in communication between SERVO and AVSYS when the power is turned on.
		E — 6A	This appears when there is a communication error between IF and FRONT.
		E — 6B	This appears when there is a communication error between IF and AVSYS. There is a problem with the internal reference or external reference.
		E — 80	This appears when there is a problem with the supply voltage.
		E — bA	This appears when the input DC voltage has dropped below the undercut voltage (approx. 10.6V).

Emergency Eject

Procedure for removing the tape manually in an emergency

Use the procedure below to remove the cassette tape if it can not be removed even when the EJECT button is pressed.

- Before proceeding to eject the tape manually, you must first turn off the power to the unit.

- 1 Remove the top panel.
- 2 Use a Phillips head screwdriver to push in and turn the red plastic screw part counterclockwise. (This screw needs to be rotated about 30 turns before unloading can be started.)
- 3 Insert the take-up jig (packed with the unit) into the tape ejection slot (on the mechanism side of the VTR), and rotate the flange part (white gear) of the supply reel in the take-up direction to take up the tape slack using the rubber part of the take-up jig.
- 4 Once more use the Phillips head screwdriver to push in and turn the red plastic screw part counterclockwise. Again rotate the flange part of the supply reel in the take-up direction to take up the tape slack. This two-step procedure needs to be repeated until the tape is completely housed in the cassette case (about 90 turns of the red plastic screw part).
- 5 Use the Phillips head screwdriver to turn the red plastic screw part at the slot-in side clockwise to eject the cassette tape. (This screw needs to be rotated through about 140 turns until the tape is ejected.)

<Note>

Take care not to damage the tape in any way.

<Note>

Take care not to sandwich or catch the tape when closing the cassette cover.

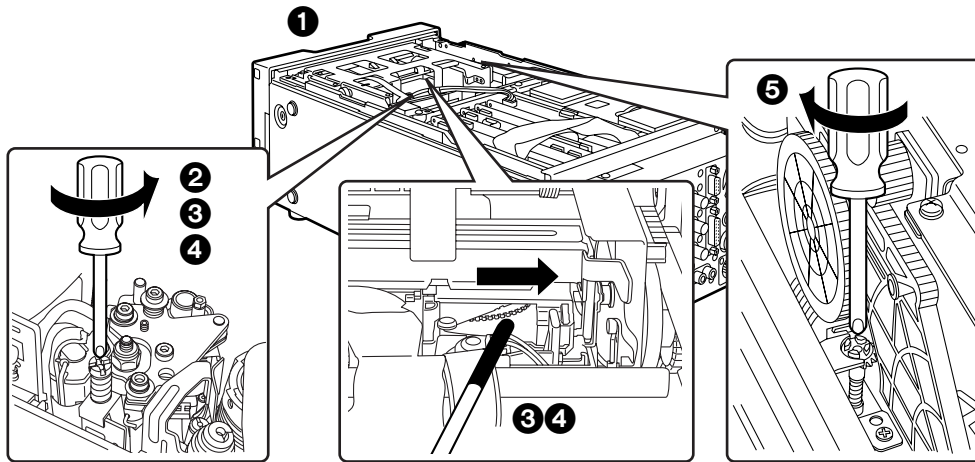

Video Head Cleaning

This unit is equipped with an auto head cleaning function, which automatically reduces the amount of dirt on the video heads. However, in order to enhance the unit's reliability, it is recommended that the video heads be cleaned every day. Use a cleaning fluid designated by the unit's manufacturer.

Condensation

The same principle by which droplets of water form on a window pane of a heated room is responsible for the formation of condensation inside the unit.

Condensation occurs in the unit or tape when it is moved from one location to another where there is a significant difference in temperature and humidity.

More specifically, it forms:

- When the unit (or tape) is moved to a very humid location where the air is full of steam, or to a room immediately after it has been heated
- When the unit (or tape) is abruptly moved from an air-conditioned location to a very warm or very humid location

When moving the unit to the kind of location described above, do not turn on its power immediately but leave it standing for about 10 minutes. If condensation has formed inside the unit, an error message (- d -) will light up on the counter display, and the cassette tape will be automatically ejected.

Leave the power on, and wait until the error message is cleared.

Maintenance

Before proceeding with maintenance, set the power switch to the OFF position, and disconnect the power cord from the power outlet. Make absolutely sure that you grasp the power plug when disconnecting the power cord.

Use a soft cloth to clean the cabinet. To remove stubborn dirt, dilute some kitchen detergent, soak a rag in the solution, wring it out well, and use it to wipe away the dirt. Wipe up any remaining moisture using a dry cloth. Do not use paint thinners or benzine.

Specifications

[GENERAL]

Supply voltage: AC 120V \pm 10%, 50/60 Hz
Power consumption: 93 W
DC supply voltage: 12 V
DC power input current: 6.2 A

Ambient operating temperature

41°F to 104°F (5°C to 40°C)

Ambient operating humidity

10% to 85% (no condensation)

Weight

17.16 lb (7.8 kg)

Dimensions (W×H×D)

8 ⁷/₁₆"×5 ¹/₄"×16 ¹⁵/₁₆" (214×132×430 mm)

Recording format

DVCPRO50 format/DVCPRO format switchable

Recording video signals

525i

Recording audio signals

- DVCPRO50: 48 kHz, 16 bits, 4 channels
- DVCPRO: 48 kHz, 16 bits, 2 channels

Recording tracks

- Digital video/audio: helical track
- Time code: helical track (sub-code area)
- Cue signal: 1 track
- Control (CTL) signal: 1 track

Tape speed

- DVCPRO50: 67.640 mm/sec.
- DVCPRO: 33.820 mm/sec.

Recording time

- 92 min. (using AJ-5P92LP, DVCPRO50)
- 33 min. (using AJ-P66MP, DVCPRO50)
- 184 min. (using AJ-5P92LP *, DVCPRO)
- 66 min. (using AJ-P66MP, DVCPRO)

*For AJ-5P92LP cassette tapes recorded using the DVCPRO (25 Mbps) mode, use a VTR supporting DVCPRO (25 Mbps) 184 minute tapes.

Tape used

1/4" thin magnetic layer metal tape

FF/REW time

Less than 5 minutes (using AJ-5P92LP)

[VIDEO]

■ Digital video

Sampling frequency

(DVCPRO50)

Y: 13.5 MHz, P_B/P_R: 6.75 MHz

(DVCPRO)

Y: 13.5 MHz, P_B/P_R: 3.375 MHz

Quantizing

8 bits

Video compression system

DCT + variable length code

Error correction

Reed-Solomon product code

■ Analog composite IN/OUT

Video band

Y: 30 Hz to 4.5 MHz (\pm 1 dB)

Differential gain

Less than 6%

Differential phase

Less than 4.5 degrees

Y/C delay

Less than 20 ns

K factor

Less than 2%

■ Adjustments (video output signals)

Video gain

More than \pm 3 dB

Chroma gain

More than \pm 3 dB

Hue

More than \pm 25 degrees

Setup

\pm 10 IRE

Horizontal (H) phase

More than \pm 1.5 μ s

SC phase (COARSE)

360 degrees

SC phase (FINE)

90 degrees

Specifications

[AUDIO]

■ Digital audio

Sampling frequency

48 kHz

Quantizing

16 bits

Frequency response

20 Hz to 20 kHz ± 1 dB

Dynamic range

More than 85 dB

(1 kHz, emphasis OFF, "A" weighted)

Distortion

Less than 0.1%

(1 kHz, emphasis OFF, reference level)

Crosstalk

Less than -80 dB

(1 kHz, between 2 channels)

Wow & flutter

Below measurable limits

Headroom

20 dB

Emphasis

T1 = 50 μ s/T2 = 15 μ s

(ON/OFF switchable)

[INPUT/OUTPUT CONNECTORS]

■ Video input connectors

Analog composite input

BNC $\times 1$, 75 Ω

Reference input

Analog composite, BNC $\times 2$ (loop-through),

75 Ω ON/OFF switchable

■ Video output connectors

Analog composite output

BNC $\times 1$, 75 Ω

Monitor output

BNC $\times 1$, 75 Ω , superimpose ON/OFF

■ Audio input connectors

Analog input

XLR $\times 2$ (CH1, CH2), high impedance,

+4/0/-3/-20 dBu

■ Audio output connectors

Analog output

XLR $\times 2$ (CH1, CH2), low impedance,

+4/0/-3/-20 dBu

Monitor output

PHONO $\times 2$ (L, R), low impedance, 0 dBu,

CH1/MIX/CH2 switchable

Headphones output

M3 $\times 1$, stereo, variable level (maximum -20 dBu),

8 Ω , CH1/MIX/STEREO/CH2 switchable

[INPUT/OUTPUT CONNECTORS]

■ Other input/output connectors

Time code input

BNC $\times 1$, 0.5 to 8 V_{P-P}, 8 k Ω

Time code output

BNC $\times 1$, 2.0 V_{P-P}, low impedance

Remote

D-sub, 9 pins (female) $\times 1$, for AJ-A95P

RS-422A interface standard complied with (no editing function)

Encoder remote

D-sub, 15 pins (female) $\times 1$, for AU-ER65B

DC power output

4 pins $\times 1$, DC 12 V, 250 mA, for AJ-A95P

[DISPLAY TUBE]

Counter

8 digits

(CTL/TC/UB/amount of remaining tape switchable)

Audio level meter

17 steps + excessive level display

Other

Servo lock, tape travel status, recording enabled/prohibited, SCH, REMOTE, WIDE, channel condition

[OPTIONS]

● 9-pin remote controller

AJ-A95P

● Encoder remote controller

AU-ER65B

● 9-pin remote cables

AU-C5 (5 meters), AU-C10 (10 meters)

● Component serial interface board

(SDI input/output board)

AJ-YA95P

Panasonic

PANASONIC BROADCAST & DIGITAL SYSTEMS COMPANY
DIVISION OF MATSUSHITA ELECTRIC CORPORATION OF AMERICA

Executive Office:

3330 Cahuenga Blvd W., Los Angeles, CA 90068 (323) 436-3500

EASTERN ZONE:

One Panasonic Way 4E-7, Secaucus, NJ 07094 (201) 348-7621

Mid-Atlantic/New England:

One Panasonic Way 4E-7, Secaucus, NJ 07094 (201) 348-7621

Southeast Region:

1225 Northbrook Parkway, Ste 1-160, Suwanee, GA 30024 (770) 338-6835

Central Region:

1707 N Randall Road E1-C-1, Elgin, IL 60123 (847) 468-5200

WESTERN ZONE:

3330 Cahuenga Blvd W., Los Angeles, CA 90068 (323) 436-3500

Dallas Region:

6226 Abington Way, Houston, TX 77008 (713) 802-2726

No. CA/Northwest Region:

5870 Stoneridge, #3, Pleasanton, CA 94588 (925) 416-5108

Government Marketing Department:

52 West Gude Drive, Rockville, MD 20850 (301) 738-3840

Panasonic Canada Inc.

5770 Ambler Drive, Mississauga, Ontario L4W 2T3 (905) 624-5010

Panasonic Sales Company

Division of Matsushita Electric of Puerto Rico Inc.

San Gabriel Industrial Park, 65th Infantry Ave., Km. 9.5, Carolina, Puerto Rico 00630 (787) 750-4300