

4CH STANDALONE DVR

USER MANUAL

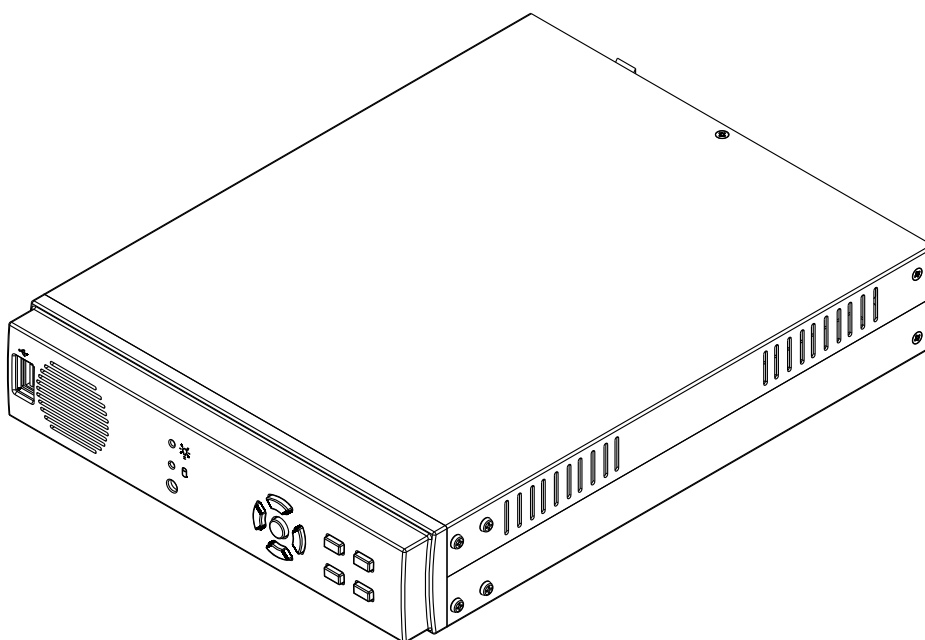

2008 JAN. Ver 1.1

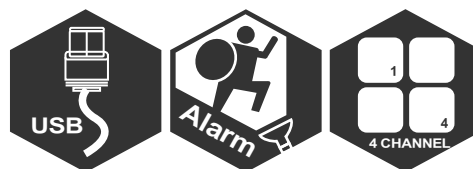

HDD SUPPORT LIST



Warning :

Should you wish to install a new hard drive in this unit, a list of tested hard drives shown to be compatible can be found below.

★ Brand	Capacity
<i>IDE- Samsung</i>	80GB/ 160GB
<i>IDE- Seagate</i>	80GB/ 160GB/ 320GB/ 400GB
<i>IDE- Maxtor</i>	80GB/ 160GB/ 320GB/ 400GB
<hr/>	
<i>SATA- Maxtor</i>	160GB/ 250GB/ 320GB
<i>SATA- Seagate</i>	160GB/ 250GB/ 320GB/ 500GB/ 750GB
<i>SATA- HITACHI</i>	160GB/ 250GB/ 320GB/ 500GB/ 750GB
<i>SATA- WD</i>	320GB/ 500GB



Warning :

The hard drive below is not recommended for this unit

★ Brand	Capacity
<i>IDE- WD</i>	All Series
<hr/>	
<i>SATA- WD</i>	160GB/ 250GB/ 750GB/ 1TB
<i>SATA- Maxtor</i>	500GB
<i>SATA- HITACHI</i>	1TB

CONTENT

1、FEATURE	2
2、SPECIFICATIONS	3
3、INSTALLATION	4
4、FRONT PANEL	5
5、OPERATING MANUAL	6
6、VIEW CONTROL	8
7、PLAYBACK CONTROL	9
8、RECORD CONTROL	9
9、4 CHANNEL RECORDING HOURS	10
10、DVR Viewer User Guide	11
11、SATA TO PATA CONVERT BOARD(Option)	18

1、FEATURE

- 1、Definitely Standalone.
- 2、Real Time Refresh Rate.
- 3、Display While Recording.
- 4、Frame Recording & Quad Recording.
- 5、Compatible of NTSC/PAL format.
- 6、Advanced MJPEG.
- 7、Manual / Motion / Programmed
- 8、Systems records automatically while alarming.
- 9、Search by Time / Date.
- 10、Watch dog feature.
- 11、HDD Volume Indicator.
- 12、Can use USB to link PC, Player can search Time to Play、
saving and take photos functions.
- 13、Internal motion detect feature.
- 14、Remote Control.
- 15、Support Audio Recording.

2、SPECIFICATIONS

OPERATION SYSTEM	Embedded RTOS		
Video Input	NTSC/PAL		
VGA Output	D-SUB 15P VGA		
Video Input Channel	4CH Composite		
Video Output Channel	1CH Composite		
Display Frame	NTSC	120 fps (4x30 fps)	
	PAL	100 fps (4x25 fps)	
Recording Frame Rate(QUAD)	NTSC	Max. 30 fps	
	PAL	Max. 25 fps	
Recording Frame Rate(EACH)	NTSC	Max. 7.5fps(30 fps/4)	
	PAL	Max. 6.25fps(25 fps/4)	
Recording Mode	Continuous / Motion / Programmed		
Resolution	Display	NTSC	720x480
		PAL	720 x 576
	Recording	NTSC	640x224
		PAL	640x272
Compression Format	Advanced MJPEG	Low	12K Bytes / Frame
		Normal	15K Bytes / Frame
		High	20K Bytes / Frame
HDD	400G X 1 (Max)		
Search	Mode	Time / Date / Event	
	Full screen	YES	
MOTION DETECT	YES		
LOSS DETECT	YES		
BUZZER OUTPUT	YES		
Brightness adjust	YES		
Contrast adjust	YES		
USB Output	YES		
VGA Output	YES		
System a monitor	Power recover auto restore record mode		
Power supply	DC 12V / 4A(AC110V-240V 50/60HZ)		
Dimension	220mm x 288mm x 48mm (W x D x H)		
Weight	1.5KG		
Audio Function	Audio Input/Output Real Line Recording And Playing		

3、INSTALLATION

REAR PANEL

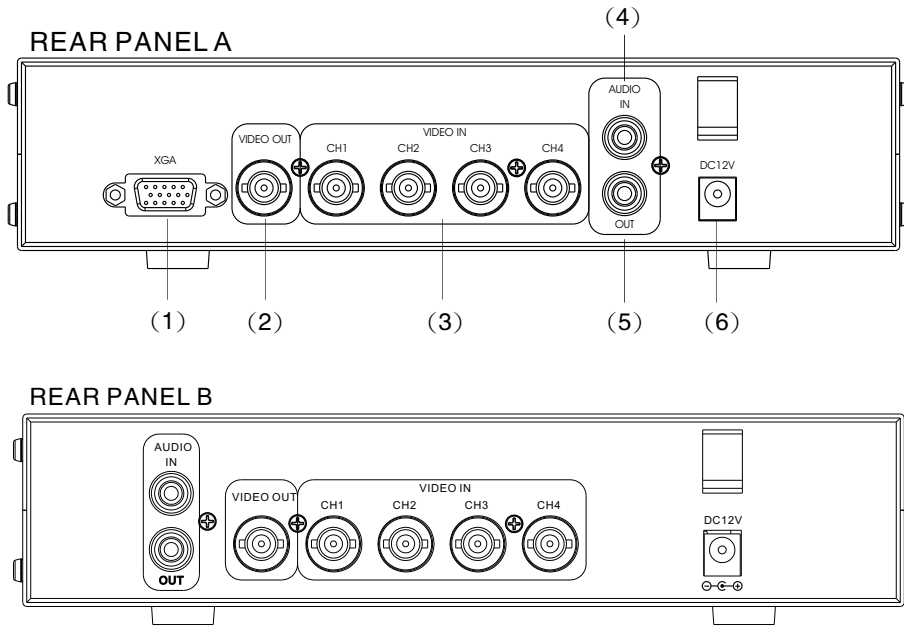

- (1) XGA Output(Only REAR PANEL A)
- (2) Video Output : Corresponding to Video Input.
- (3) Video IN : Cameras to Video Input.
- (4) Audio Input.
- (5) Audio Output.
- (6) Power Input : Please use the power supply attached
Adaptor : DC-12V / 4A

4、FRONT PANEL

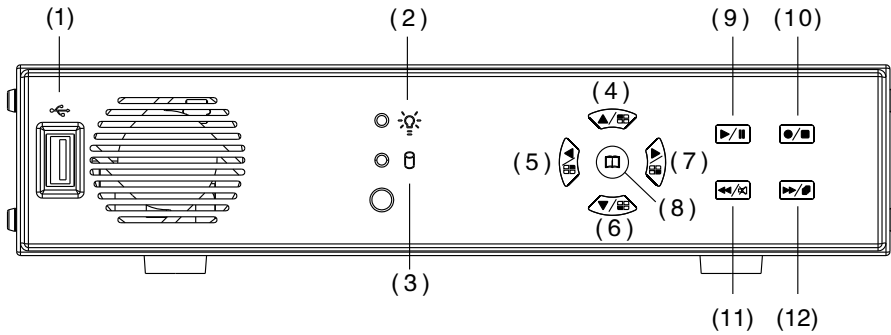

(1) USB PORT

(2) Record Indicator

(3) HDD Indicator

(4) Move Up / Camera 1 Display

(5) Move Left / Camera 2 Display

(6) Move Down / Camera 3 Display

(7) Move Right / Camera 4 Display / Select

(8) Menu / Show Percentage of the hard Drive recorded

(9) Play / Pause

(10) Record / Stop

(11) Fast Reverse / Mute

(12) Fast Forward / Sequence Switch

5、 OPERATING MANUAL (MAIN MENU)

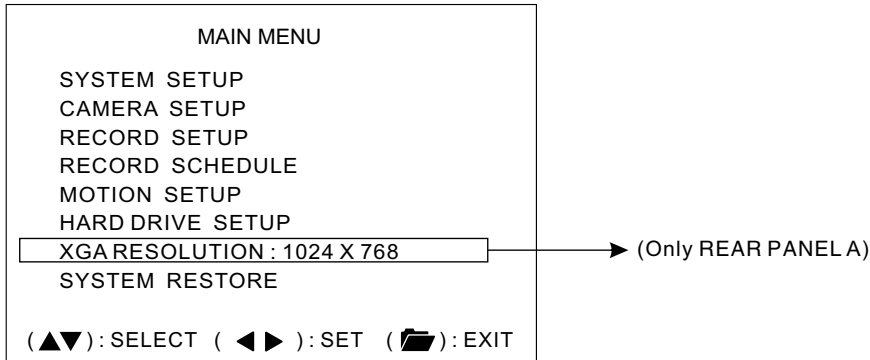

XGA RESOLUTION : 640X480, 800X600, 1024X768 (default setting), 1280X1024. (Only REAR PANEL A)

Press ▲▼ to select items, use ◀▶ to enter.

Press 🗑️ to exit

SYSTEM SETUP

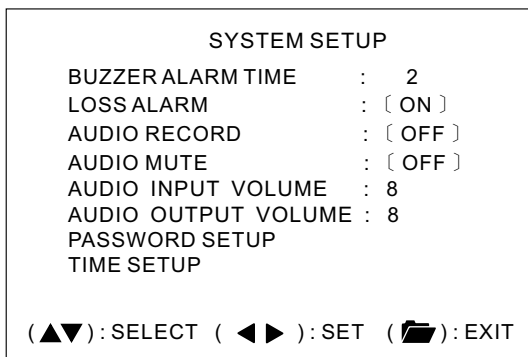

Press ▲▼ to select items, use ◀▶ to enter.

Press 🗑️ to exit

PASSWORD SETUP

Select this item to change password :

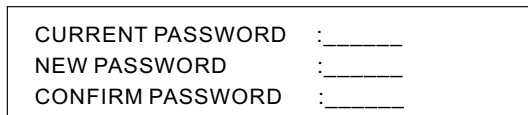

(1) When the new password is accepted, you will receive a message that inform you. PASSWORD CHANGED

(2) If the password was not accepted, you will receive a message that inform you. NO PASSWORD CHANGED

*Use the view control button on the front panel to input the number.

4CH STANDALONE DVR

is:"1" is:"2" is:"3" is:"4"

TIME SETUP

Select this item to set up current time.

```
TIME SET
2004/12/17 18:00:30
(◀▶):SELECT (▲▼):SET (🗑):EXIT
```

Press ◀▶ to select items, use ▲▼ to enter.

Press 🗑 to exit

CAMERA SETUP

```
CAMERA SETUP
CAMERA           : CH1
LIVE ON/OFF      : ON
RECORD ON/OFF    : ON
BRIGHT SETUP     : 5
CONTRAST SETUP   : 5
COLORS SETUP     : 5
AUTO SWITCHING   : 2
(▲▼):SELECT (◀▶):SET (🗑):EXIT
```

Press ▲▼ to select items, use ◀▶ to enter.

Press 🗑 to exit

RECORD SETUP

```
RECORD SETUP
RECORD MODE      :EACH
VIDEO QUALITY    :NORMAL
RECORD FRAME RATE :30
(▲▼):SELECT (◀▶):SET (🗑):EXIT
```

Press ▲▼ to select items, use ◀▶ to enter.

Press 🗑 to exit

(1) Record Setup:EACH MODE (frame recording),

Each Mode frame rate alternatives as follows:

Maximum : 7.5 fps each camera Totally :30 fps = 7.5 x 4 CH

QUAD MODE (quad recording).

In this mode is: "1" 、 is: "2" 、 is: "3" 、 is: "4" invalid.

(2) Video Quality: video quality selection: High, Normal, Low

(3) Record Frame Rate: QUAD MODE frame rate alternatives as follows:

Enable Audio Record → 30 、 15 、 10 、 7 、 5 、 4 fps.

Disable Audio Record → 30 、 15 、 10 、 7 、 5 、 4 、 3 、 2 、 1 fps.

RECORD SCHEDULE

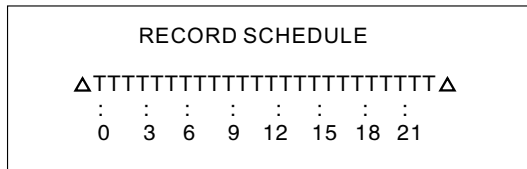

Press ◀▶ to select items, use ▲▼ to enter.

Press ⏏ to exit

- (1)Range: 0-24 hrs.
- (2)Set "T" for continuous recording.
- (3)Set "M" for motion recording.
- (4)Set up "-" to disable the recording.

MOTION SETUP

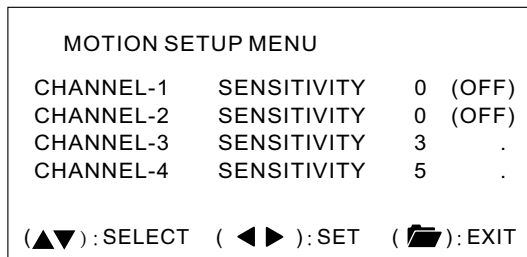

Press ▲▼ to select items, use ◀▶ to enter.

Press ⏏ to exit

★ If you want to enable Motion Recording, Please finish the setup procedure a. and b.

- a. Set SENSITIVITY in the menu option "MOTION SETUP MENU"
- b. Set "PROGRAMMED RECORD" --- "M" in the menu option "RECORD SCHEDULE".



6. VIEW CONTROL

(1)You can use the following view control buttons to monitor the video from the cameras.





- Camera #1 (Ch1), return to Quad Mode by press again.
- Camera #2 (Ch2),return to Quad Mode by press again.
- Camera #3 (Ch3),return to Quad Mode by press again.
- Camera #4 (Ch4),return to Quad Mode by press again.

(2)View Control is only valid while the RECORD MODE is in the EACH MODE. QUAD Display, Enable / Disable theAuto switching function.

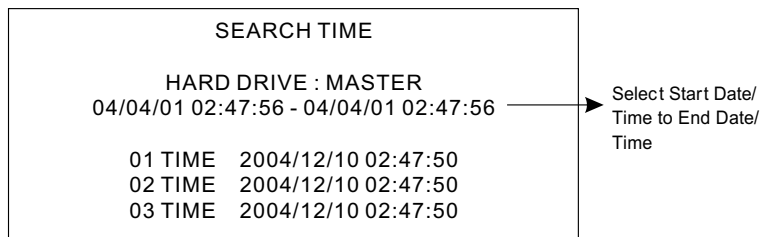
7、PLAYBACK CONTROL

- (1) Press , and the system will play the latest event which you haven't seen before.
- (2) Press , and the system will enter the PLAYBACK EVENTS SEARCH MODE.
- (3) Each period is as four hour.



Press  to select items, use  to enter.
 Press  to exit,  select event / time.



Press  to switch between the TIME SEARCH MODE and the PLAYBACK EVENTS SEARCH MODE,

Press  to exit.





(1)EVENTS SEARCH MODE :

Press  choose one period, then press  to play.

(2)TIME SEARCH MODE :

The signal > goes up to the HARD DRIVER: MASTER. Press  to select items. Use  select to change data, Then press  to play.

(3)PLAYBACK :

*Press  to speed forward. Continue to press  and show X2, X4, X8 , playing.

*Press  to rewind the playback.

*Press  to pause.

*Press  to stop.

8、RECORD CONTROL

(1) Press  to start recording.

(2) During recording, the mark * appears in status of overwriting

9、4CH RECORDING HOURS ON 80GB HARD DRIVE

*Thereinafter a rough estimate a table for reference only, recording data quantity can follow an image a variation a rate somewhat different.

Recording Results in NTSC Format			30 fps	15 fps	7 fps	1 fps
Video Signal	Display Format	Video Quality				
NTSC	QUAD MODE	High	36Hours	72 Hours	144 Hours	1,080 Hours
		Normal	48 Hours	96 Hours	192 Hours	1,440 Hours
		Basic	58 Hours	116 Hours	232 Hours	1,740 Hours
	EACH MODE (Full Screen)	High	64 Hours	128 Hours	256 Hours	1,920 Hours
		Normal	90 Hours	180 Hours	360 Hours	2,700 Hours
		Basic	112 Hours	224 Hours	448 Hours	3,360 Hours
Recording Results in PAL Format			25 fps	12 fps	6 fps	1 fps
Video Signal	Display Format	Video Quality				
PAL	QUAD MODE	High	38 Hours	76 Hours	152 Hours	950 Hours
		Normal	48 Hours	96 Hours	192 Hours	1,200 Hours
		Basic	60 Hours	120 Hours	240 Hours	1,500 Hours
	EACH MODE (Full Screen)	High	62 Hours	124 Hours	248 Hours	1,550 Hours
		Normal	90 Hours	180 Hours	360 Hours	2,250 Hours
		Basic	118 Hours	236 Hours	472 Hours	2,950 Hours

10、DVR PC Viewer User Guide

Introduction

This document is the Operation Manual for the 4 CH Stand Alone DVR PCViewer.

The application will show you stream image stored in the Storage Device (HDD, CF card, USB Memory Stick, etc.), which was previously formatted and recorded by the DVR.

If any DVR-formatted Storage Device is connected to your PC, the application will automatically detect the Storage Device and show the recorded stream. You can also save the current screen to a JPEG file, and save the video/audio stream to a file [MYS file, the Vineyard's proprietary video/audio stream file format.

The application consists of two functional modules:

- ▶ DVR PC Viewer Shows stream stored in the DVR Storage Device.
- ▶ MYS File Player Plays captured stream file.

Terms in This Document

Storage Device	Hard Disk, CF Card, USB Memory Stick
The Application	DVR Storage Device PC Viewer
DVR Storage Device	Storage Device which was previously formatted and recorded by the DVR base on Vineyard Technologies' DVR chip.
OS	Operating System
CPU	Central Processing Unit
RAM	Random Access Memory
GUI	Graphic User Interface

Requirement

OS	OS of your PC should be Windows 2000(SP4) / XP(SP2) or later.
DirectX	Your PC should be equipped with DirectX 7.0 or later.

Recommendation

Operating System (OS)	The application runs only on Windows 2000 (SP4) / XP (SP2) or later
CPU	1.0 GHz or Higher.
RAM	256 MByte or greater.

■ Installation

A. Hardware Installation

Before executing the application, connect the DVR Storage Device to the IDE cable of your PC directly, or via USB adaptor

B. Software Installation

Run Setup.exe in the CD-ROM and follow the instruction to finish the installation.

[Make sure that the OS of your PC is Windows 2000 SP4/Windows XP SP2 or later.

■ Execution

Just double click the icon of PC Viewer. The application will try to detect physical storage devices installed at your PC and search for DVR storage device(s) among them.

If there is DVR Storage Device, the application will automatically start playing. However, If the application fails to detect DVR Storage Device, which means that there is no DVR Storage Device installed to your system, it will show following error message and set the default working mode to MYS PLayer (See Section. 4).



Fig.1. No DVR Storage Device Message

■ Shortcut to play the video files on your PC via the attached USB cable:

- a. Connect USB cable both ends to the USB port of the DVR and your PC.
- b. Supply 12VDC power to the DVR.
- c. Wait until the message of USB detected pops up on the VGA monitor.
- d. Run the PC Viewer software accordingly.
- e. Wait until the very first image comes up to the PC Viewer.
- f. Click "Play" icon on the control panel of the PC Viewer to start viewing the video files.

■ DVR PC Viewer

A. User Interface

The default page of the application is DVR Storage Device PC Viewer. The user interface is shown in Fig.2.

4CH STANDALONE DVR

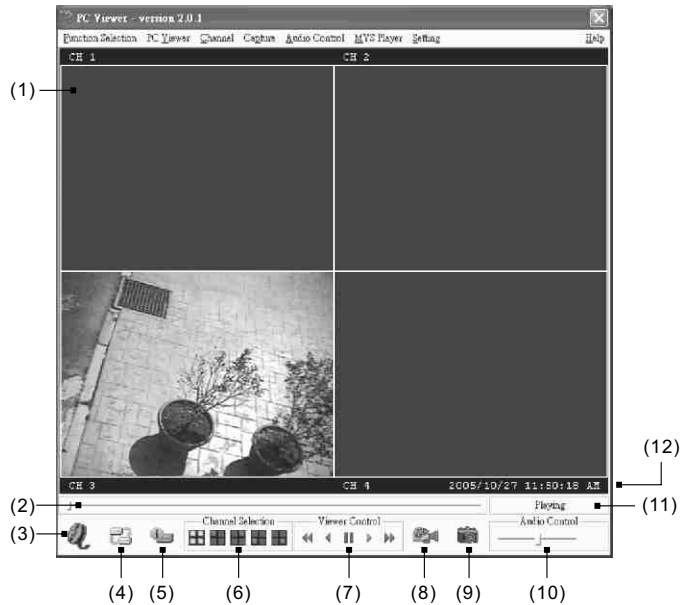

(1) Screen	(7) PC Viewer Playback Control
(2) Positioning Slider Bar	(8) Capture Stream Button [MYS]
(3) MYS Player Button	(9) Screen Capture Button [JPEG]
(4) DVR Storage Device Change Button	(10) Audio Control
(5) DVR Storage Device Information	(11) Viewer Playback Mode
(6) Channel Selection	(12) Stream Time Display

Fig.2. DVR Storage Device PC Viewer User Interface

B. Functions

i. MYS Player Button

If you want to see MYS file which was stored in your PC, press this button or press [F2] key.

ii. DVR Storage Device Change Button

When there are more than one DVR storage devices, this button will be activated. Press this button when you want to see video/audio stream stored in other DVR storage device. Fig.3 shows DVR storage device selection window.

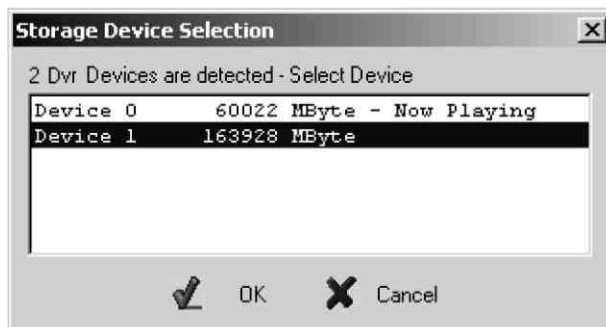

Fig.3. DVR Storage Device Selection Window

iii. DVR Storage Device Information Button

If you want to know how big is the DVR storage device is, or how much stream data is stored in the device, press this button. Fig.4 shows the DVR storage device information window.



Fig.4. DVR Storage Device Information Window

iv. Channel Selection Buttons

According to the record channel setting of the stream, each channel buttons will be enabled. Select any channel you want to see enlarged.





Fig.5. Channel Selection Buttons

Press  button (or [5 or Numpad 5] Key) to see all 4 channels at the same time.

Press  button (or [1 or Numpad 1] Key) to see channel 1 enlarged.

Press  button (or [2 or Numpad 2] Key) to see channel 2 enlarged.

Press  button (or [3 or Numpad 3] Key) to see channel 3 enlarged

Press  button (or [4 or Numpad 4] Key) to see channel 4 enlarged.

v. Viewer Control Buttons

Use Viewer Control Buttons to control viewer playback.



Fig.6. Viewer Control Buttons

*Press  button (or [<-] Key) to start fast reverse playback. By pressing this button again, you can adjust the speed. The maximum speed is 8 times faster than reverse playback.

*Press  button (or [<-] Key) to start reverse playback.

*Press  button (or [Space Bar]) to pause playback.

*Press  button (or [->] Key) to start normal playback.

*Press  button (or [->] Key) to start fast forward playback. By pressing this button several times, you can adjust the speed. The maximum speed is 8 times faster than normal playback.

vi. Capture Stream Button

If you want to capture stream, follow the stream capture procedure listed below:

- * Using Positioning Slider Bar find the stream position you want.
- * Make sure that the playback is in PAUSE mode, and the Capture Stream Button is enabled.
- * Press the button, then the application will start capturing. During capturing, Capturing Indicator Window will be popped up.



Fig.7. Capturing Indicator Window

- * To stop capturing, press Stop Capturing button on the window.
- The captured file (an MYS file) will be stored in the Capture Directory. See the Application Setting Section, to know more about the Capture Directory setting.

vii. Screen Capture Button



If you want to capture the screen, follow the screen capture procedure listed below:

- * Using Positioning Slider Bar find the stream position you want.
- * Make sure that the playback is in PAUSE mode, and the Screen Capture Button is enabled.
- * Press the button, then the application will start to make a JPEG file. When a JPEG file successfully created. The application let you know that the image file is created showing the file name and the Capture Directory path.

viii. Audio Control



Fig.8. Audio Control Buttons

Press  button to enable sound. Once sound is enabled, the button icon will be changed to . Press it to disable sound again. Using the slider bar, you can adjust the volume.

■ MYS Player

A. User Interface

Fig. 9 shows the user interface of the MYS player.

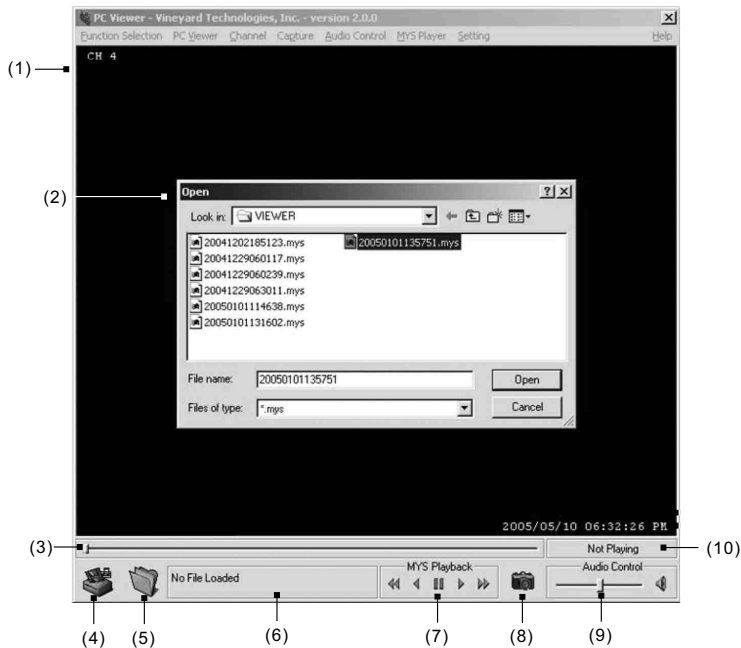

(1) Screen	(6) MYS file information
(2) MYS File Select Dialog	(7) MYS File Playback Control
(3) Positioning Slider Bar	(8) Screen Capture Button [JPEG]
(4) PC Viewer Button	(9) Audio Control
(5) File Open Button	(10) Playback Status

Fig.9. MYS File Player User Interface

B. Functions

i. PC Viewer Button

When you want to back to PC Viewer function, press this button.

ii. File Open Button

Press this button to select MYS file.

iii. MYS file information

When an MYS file selected and being played, the file name and the file size will be displayed in the MYS file information box.

iv. MYS file Playback Control Buttons

Use MYS file playback buttons to control the playback.



Fig.10. MYS file playback control Buttons

- * Press ◀ button (or [-] Key) to start fast reverse playback. By pressing this button again, you can adjust the speed. The maximum speed is 64 times faster than reverse playback.
- * Press ◀ button (or [-] Key) to start reverse playback.
- * Press || button (or [Space Bar]) to pause playback.
- * Press ▶ button (or [=] Key) to start normal playback.
- * Press ▶▶ button (or [=] Key) to start fast forward playback. By pressing this button several times, you can adjust the speed. The maximum speed is 64 times faster than normal playback.

v. Screen Capture Button

If you want to capture the screen, follow the screen capture procedure listed below:

- * Using Positioning Slider Bar find the stream position you want.
- * Make sure that the playback is in PAUSE mode, and the Screen Capture Button is enabled.
- * Press the button, then the application will start to make a JPEG file. When a JPEG file successfully created. The application let you know that the image file is created showing the file name and the Capture Directory path.

vi. Audio Control



Fig.11. Audio Control Buttons

Press button to enable sound. Once sound is enabled, the button icon will be changed to . Press it to disable sound again. Using the slider bar, you can adjust the volume.

■ Application Setting

A. User Interface

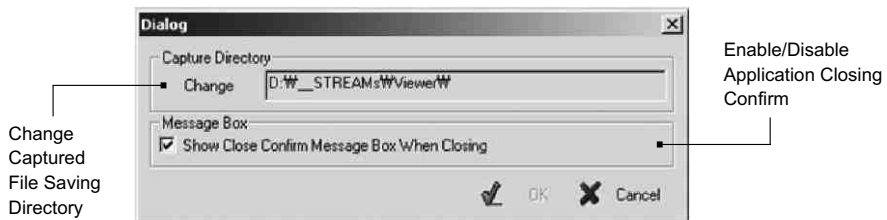

Fig.12. Application Setting Dialog

B. Functions

i. Capture Directory

You can specify Capture Directory. To change the path, press Change Button, select directory you want, and press OK again.

ii. Message Box

You can enable/disable the application close confirm message box.

11、SATA TO PATA CONVERT BOARD (Option)

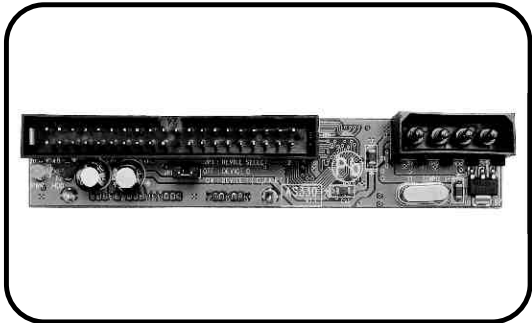

Foreword

This is a SATA convert PATA interface PCB board, before using the product, please read this manual carefully for further recognizing for the product!

I. Key Feature

- Convert SATA TO PATA interface
- Transfer rate max up to 66/100/133MB/sec
- No SATA HDD capacity limited
- LED indicators for Power(green) & HDD(red)
- Compact JBOD (Big) special function.

II. Hardware and Install

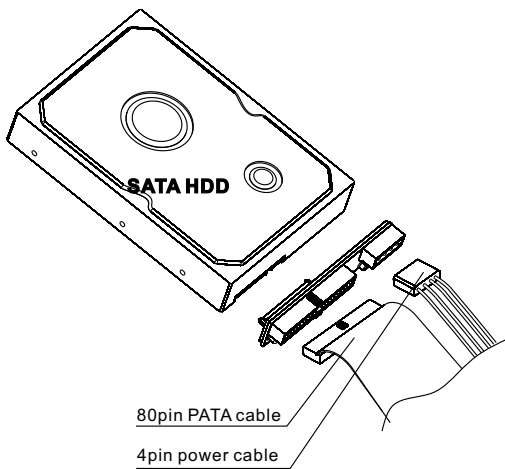
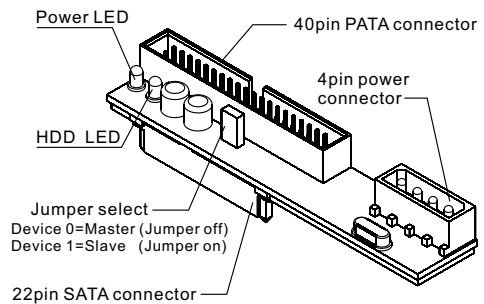

III. Jumper setting for Master & Slave

1. One PATA cable with one SATA HDD then Jumper setting in Master (Jumper off)
2. One PATA cable with two SATA HDD then Jumper setting in one is Master (Jumper off); and another is Slave (Jumper on).
3. Using JBOD (Big) special function.
 - a.) One PATA cable with two SATA HDD then Jumper setting same as step 2.
 - b.) Two PATA cable, each cable with one SATA HDD then these two Jumpers always setting in Master (Jumper off)

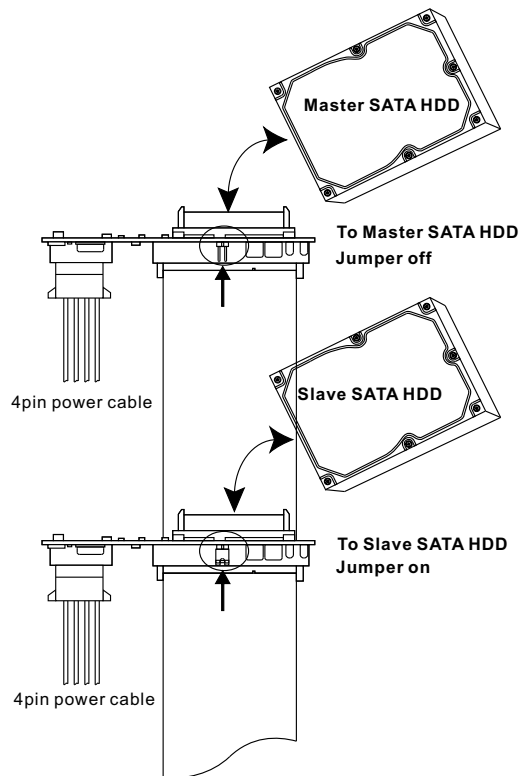

4CH STANDALONE DVR

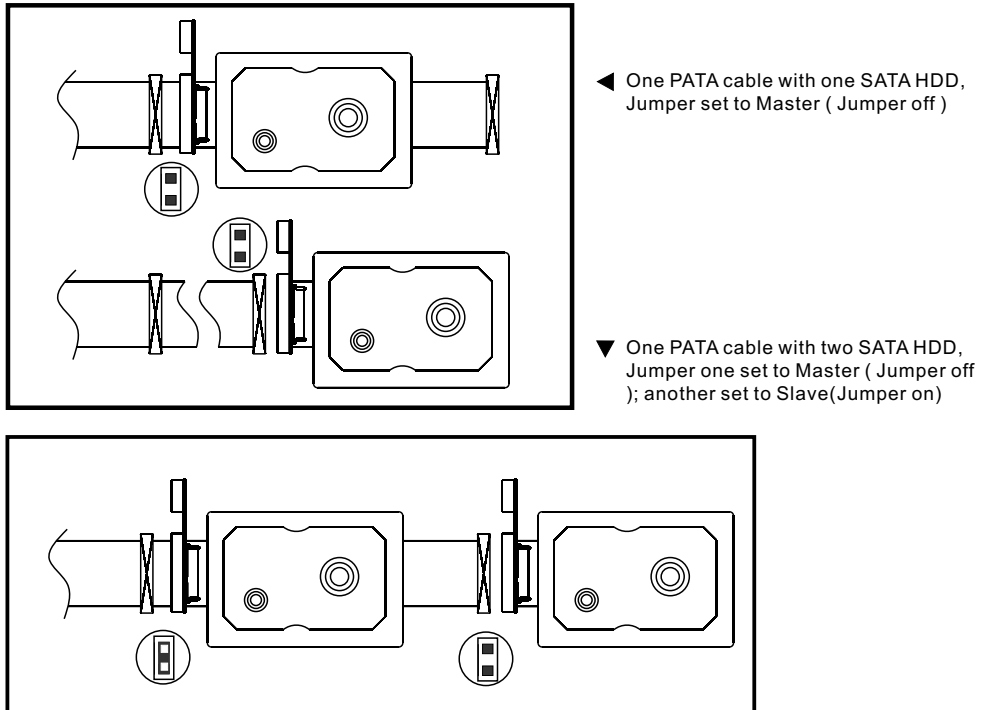

Using JBOD (Big) special function

- ▼ One PATA cable with two SATA HDD, Jumper one set to Master (Jumper off); another set to Slave(Jumper on)

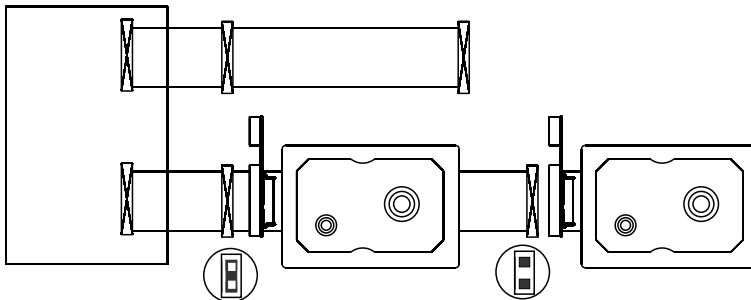

- ▼ Each one PATA cable with one SATA HDD, Jumper all set to Master (Jumper off)

