

Digital Multiplex Recorder



USER'S MANUAL

Please read the instructions thoroughly before operation and retain it for future reference.

777 W V1.0

WARNING

All the safety and operating instructions should be read before operation. The improper operation may cause permanent damage.

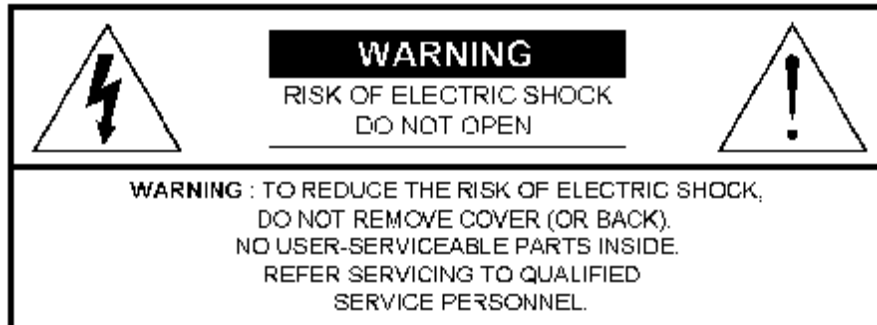

- Please use the provided adaptor (Other adaptor is not suitable for this machine).
- Please lift and place this equipment gently.
- Do not expose this equipment to open sunlight.
- Do not use this equipment near water or in contact with water.
- Do not spill liquid of any kind on the equipment.
- Please power down the unit before unplugging.
- Do not switch the Power On & Off within short period of time (within 3 seconds).
- Do not attempt to have this equipment serviced by yourself.
- Installation should be made by qualified service personnel.



The lightning flash with arrowhead symbol, within an equilateral triangle, is intended to alert the user to the presence of uninsulated "dangerous voltage" within the product's enclosure that may be of sufficient magnitude to constitute a risk of electric shock to persons.



The exclamation point within an equilateral triangle is intended to alert the user to the presence of important operating and maintenance-(servicing) instructions in the literature accompanying the appliance.

TABLE OF CONTENTS

What Do You Get ?

- FEATURES ----- 1
- PACKAGE INCLUDING ----- 1

Before Operation

- INSTALLATION GUIDE ----- 2
- FRONT PANEL ----- 3
- BACK PANEL ----- 5

Basic Operation

- START THIS UNIT ----- 6
- OPERATION ----- 6

Detailed Menu Setup

- MENU ----- 8
- ACCESS MENU ----- 9
- MAIN MENU ----- 9
- MENU OPTIONS ----- 10
- MOTION DETECTION ----- 15

Network Setting Guide

- HARDWARE CONNECTION AT DMR SIDE ----- 17
- STATIC IP SETTING ----- 18
- DYNAMIC IP SETTING ----- 22
- SOFTWARE OPERATION AT CLIENT SIDE ----- 34
- INTRODUCTION OF BASIC OPERATION ----- 35
- PLAYBACK OPERATION ----- 37
- ADVANCED SETTING ----- 38
- CONNECT VIDEO WEB SERVER VIA IE BROWSER ----- 41

TABLE OF CONTENTS

Advanced Operation

• OPERATION OPTIONS -----	43
• KEY LOCK -----	44
• TROUBLE SHOOTING-----	44
• SPECIFICATIONS -----	45

Appendix

• APPENDIX #1 – INSTALL HDD-----	46
• APPENDIX #2 – RACK MOUNT-----	48
• APPENDIX #3 – RECORDING SPEED-----	49
• APPENDIX #4 – PIN CONFIGURATIONS-----	50

What Do You Get ?

FEATURES

DMR Features

- Remote control via the Internet
- Wavelet Compression Format replaces Time-Lapse VCR + Multiplexer
- 4 Audio inputs / 2 Audio outputs
- On Screen Display and RTC (Real time clock) Function
- Support from 4 channels to 7/9/10/13/16 channels video inputs
- Picture-In-Picture (PIP) is available in live and DMR playback modes
- Motion detection function and 4 level video quality adjustable on each channel
- Alarm Input & Output Function
- Video loss detected on each channel can record up to 160 events
- Power-loss memory function
- Support 2 Removable HDDs, IDE Type
- Quick Multiple Search by date/time, alarm, full list
- Security password protection

PACKAGE INCLUDING



Digital Multiplex Recorder(with HDD cartridge)



User's Manual



CD-ROM



Accessories pack



2 Keys for Cartridge



Power Adapter and Cord

NOTE : Please check the package to make sure that you receive the complete accessories which includes the components shown above.

Before Operation

INSTALLATION GUIDE

1. Connect cameras and monitor with the DMR.
2. Shown below is one example for connecting the DMR to your existing Observation System.
3. Install HDDs (The compatible HDD Brands are listed in the following table.)

Please refer to page.46 Appendix #1 for installation instructions.

The HDDs must be installed before the DMR is turned on.

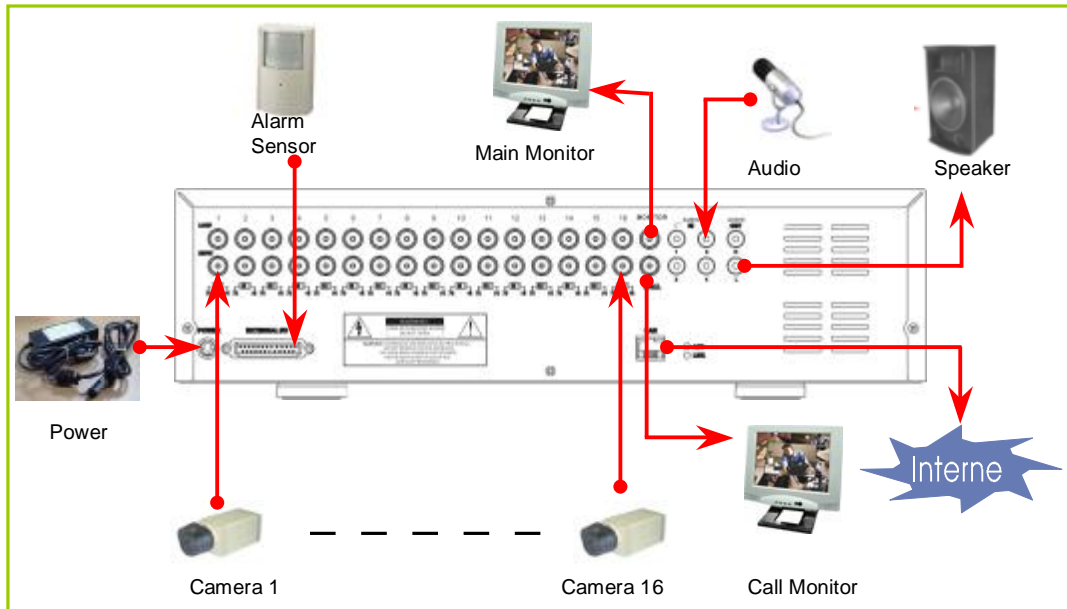

COMPATIBLE HARD DISK BRANDS

Manufacturer	Model	Capacity	Rotation
HITACHI	Deskstar 180 GXP (120 GB)	120GB	7200 rpm
HITACHI	Deskstar 7K250, HDS722516VLAT20	160GB	7200rpm
HITACHI	Deskstar 7K250, HDS722525VLAT80	250GB	7200rpm
IBM	Deskstar 120GXP (80GB)	80GB	7200 rpm
IBM	Deskstar 120GXP (120GB)	120GB	7200 rpm
Maxtor	DiamondMax 536DX(60GB) 4W060H4	60GB	5400rpm
Maxtor	DiamondMax Plus 9	80GB	7200 rpm
Maxtor	DiamondMax Plus 9, Model#6Y120L	120GB	7200 rpm
Maxtor	DiamondMax Plus 9, Model#6Y160L0	160GB	7200rpm
Seagate	Barracuda ATA IV, ST380021A	80GB	7200rpm
Seagate	Barracuda ATA V, ST3120023A	120GB	7200 rpm
Seagate	Barracuda 7200.7 Plus, ST3160023A	160GB	7200 rpm
Western Digital	Caviar WD1200BB-00CAA1	120GB	7200rpm
Western Digital	Caviar WD2000BB-00DWA0	200GB	7200rpm

FRONT PANEL

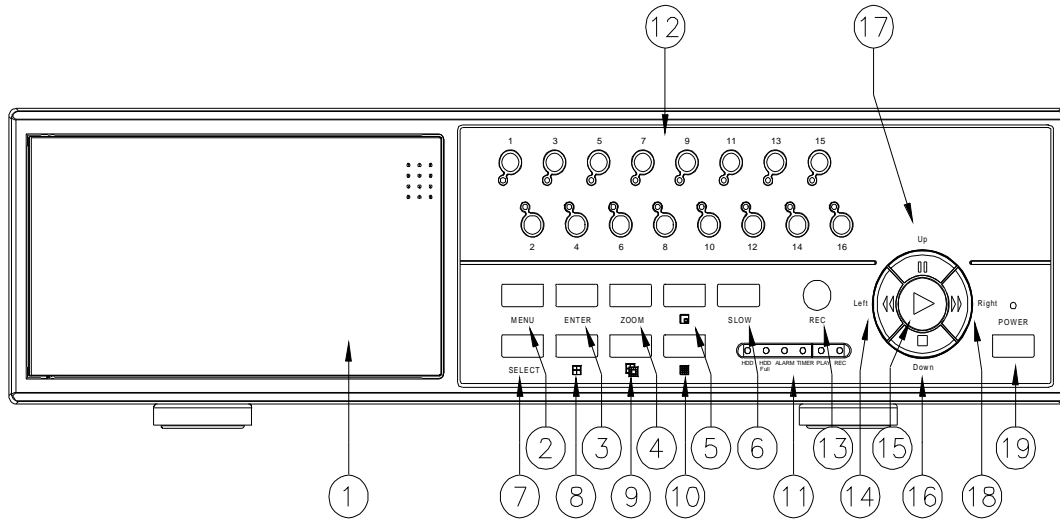

1. REMOVABLE HDD CARTRIDGE

Please refer to page.46 Appendix #1.

2. MENU

Press MENU button to enter main menu.

3. ENTER

Press ENTER button for confirmation.

4. ZOOM

Press ZOOM button to enlarge the picture display.

5.

Press PIP button for Picture in Picture screen.

6. SLOW

To slow down speed of play mode.

7. SELECT

Press SELECT button to select appointed camera (1~16) to display on full screen mode.

8.

4 channels display mode

9. 
7, 9, 10, 13 channels display mode

10. 
16 channels display mode

11. LED LIGHT

The LED Light is ON under the following conditions.

- HDD : HDD is activated
- HDD Full : HDD is full
- ALARM : If you want to turn off the ALARM LED light, please refer to page.13 and set the Camera / ALARM item as OFF. (all of the cameras should be set as OFF.)
- TIMER : When Timer is set as Enabled
- PLAY : On Play mode
- REC : On Recording mode

12. CAMERA (1-16)

Press the Camera Select (1-16) to select specified camera.

13. REC

Press REC to start recording.

14. REW / LEFT

- REW : Under DMR play mode, it can play video backward at different speeds. (Press REW again to adjust speed as 1, 2, 4, 8, 16, 32 times)
- Left : Under setup mode, it works as Left button.

15. PLAY

Press PLAY to play recorded video.

16. STOP / DOWN

- STOP : Under DMR Record / Play mode, it can stop the action.
- DOWN : Under setup mode, it works as Down button.

17. PAUSE / UP

- Pause : Under DMR play mode, it can pause the action.
- UP : Under setup mode, it works as Up button.

18. FF / Right

- FF : It can play video forward at high speed, and press FF again to adjust speed from 1, 2, 4, 8, 16, 32 times.
- Right : Under setup mode, it can work as Right button.

19. POWER

Press Power to turn ON / OFF the DMR.

BACK PANEL

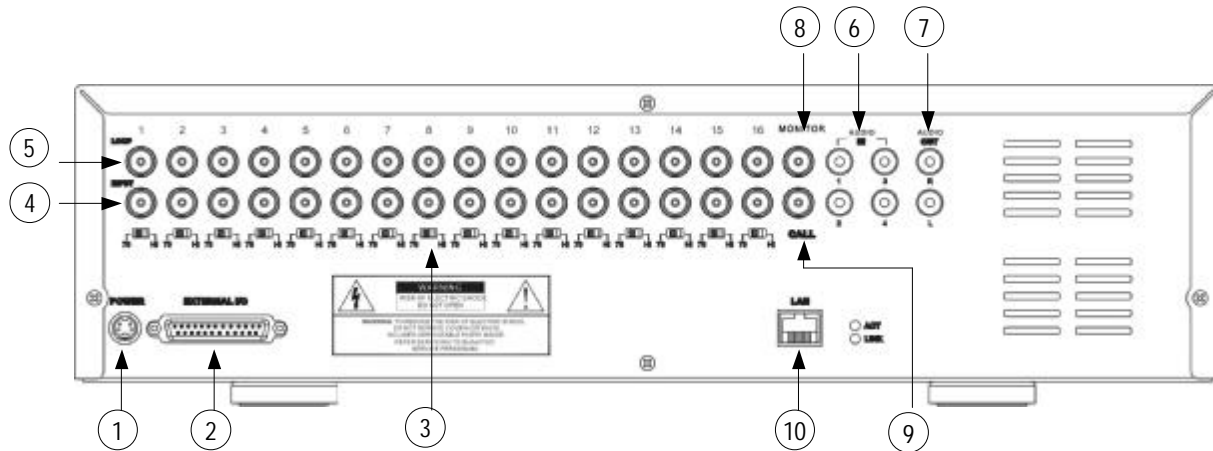

1. POWER

Please use the provided adaptor to connect power cord (Other adaptors are not suitable for this machine).

2. EXTERNAL I/O

- Controlled remotely by an external device or control system.
- Alarm input, external I / O explanation.

3. 75 Ω / HI

When using Loop function, please switch to HI. If you don't use Loop function or disconnect the video input, please set it as 75 Ω .

4. VIDEO INPUT (1-16)

Connect to video source, such as camera.

5. LOOP (1-16)

Connect video signal between Input port and Loop port to make a loop.

6. AUDIO IN (1-4)

Connect to audio source, such as microphone.

- IPS should be set to 25A (for NTSC) or 18A (for PAL)

*** 4 audio inputs, but users can only select 1 for recording.**

7. AUDIO OUT (R/L)

Connect to monitor or speaker.

- IPS should be set to 25A (for NTSC) or 18A (for PAL)

*** with 2 mono audio outputs from the same source.**

8. MONITOR

Connect to Main monitor.

9. CALL

Connect to CALL monitor. Show the Switch Display. When the alarm is triggered, the call monitor will show the triggered channel for a period of time.

10. LAN

Connect Internet by LAN cable.

Basic Operation

START THIS UNIT

Before using the DMR, please have the HDDs installed ready. (refer to Appendix #1 for installation or removal of HDDs).

1. Connect the AC Power Cord with Power Adapter and plug into an electrical outlet. The Red LED indicator light will be ON and the DMR is in Standby mode.
2. Press the Power button. The POWER LED will turn from red to orange, and other red LED indicators will turn ON. It takes approximately 5 to 15 seconds to boot the system with the message : " HDD Detecting ". On connecting, the POWER LED will change to green color, and the Alarm LED will be ON.
3. Before operating the DMR, please set up the system time first. (for setting system time, please refer to page.12).

NOTE : When "HDD not found" message shows up, please refer to appendix # 1. It may result from the improper installation of the HDD.

OPERATION

RECORDING

The DMR offers a variety of recording modes, such as continuous recording, scheduled time, or by events. You can set up recording speed and resolution. You can set these options by selecting MENU / RECORD before recording, please refer to page.13. Under the recording status, if power is off accidentally, recorded video will still be stored in the HDDs. DMR will return to original recording situation after power is on again.

On the screen, you will find the date, time, HDD recording type, the amount of available GB left in the HDDs memory and the letter "M" represents the method of recording that is occurring.

(OW : HDD Overwrite)

NOTE : 1. When the HDDs are full under O/W Recording mode, previous recorded files may be overwritten without further warning notices.

2. XXGB on the left side means the left space in the Master HDD and that at the right side means the left space in the Slave HDD.
3. If the HDD's capacity is only 5 GB left, it will buzz for 3 seconds; so as in 4GB, 3GB, 2GB and 1GB. If the O/W Recording mode(NOTE 1) is on, it won't have the warning buzzer.

2002 - JAN -01 01:02:03
M ● 032GB 080GB

There are 4 recording modes in which Recording can occur : Alarm, Timer, Manual and Motion Trigger.

1. ALARM RECORDING

DMR is triggered by an alarm input. Indicated by the letter "A" and will show  diagram on the triggered channel.

2. TIMER RECORDING

Recording is scheduled by a Timer. Indicated by the letter "T".

3. MANUAL RECORDING

Recording is initiated by manually pressing the REC button. Indicated by the letter "M".

4. MOTION TRIGGER RECORDING

Recording is triggered by motion detection. Indicated by the letter "D". And show  diagram on the triggered channel.

PLAY

Press "PLAY" button, the DMR will show the last recording.

1. FAST FORWARD (F.F.) & FAST REWIND (F.R.)

You can increase speed for Fast Forward and Rewind on the DMR.

In the Play mode, press "▶▶" once to get 2X speed forward and press twice to get 4X speed,... and the maximum speed can reach 32X.

Press "◀◀" once to get 1X speed rewind and press twice to get 2X speed, ... and the maximum speed can reach 32X.

2. SLOW FORWARD (S.F.) & SLOW REWIND (S.R.)

You can also slow down the speeds of Forward and Rewind on the DMR.

In the Play mode, press the SLOW button and you will enter Slow mode.

Press "▶▶" once to get 1/2X speed forward and press twice to get 1/4X speed,... and the slowest speed can reach 1/32X.

Press "◀◀" once to get 1/2X speed rewind and press twice to get 1/4X speed, ... and the slowest speed can reach 1/32X.

3. PAUSE

It will let you pause the current image displayed on the screen.

4. STOP

Press "STOP" button under all circumstance, it will return DMR to live monitoring mode.

5. IMAGE JOG DIAL

It will allow you to manually view video frame-by-frame, one image at a time.

While in PLAY mode, press "PAUSE", it will pause the screen.

Press "▶▶" button to advance the frozen screen one image forward.

Press "◀◀" button to move back one image.

CAMERA SELECT (1--16)

Press Camera Select (1-16) to select appointed camera to display on full screen mode.

Detailed Menu Setup

MENU

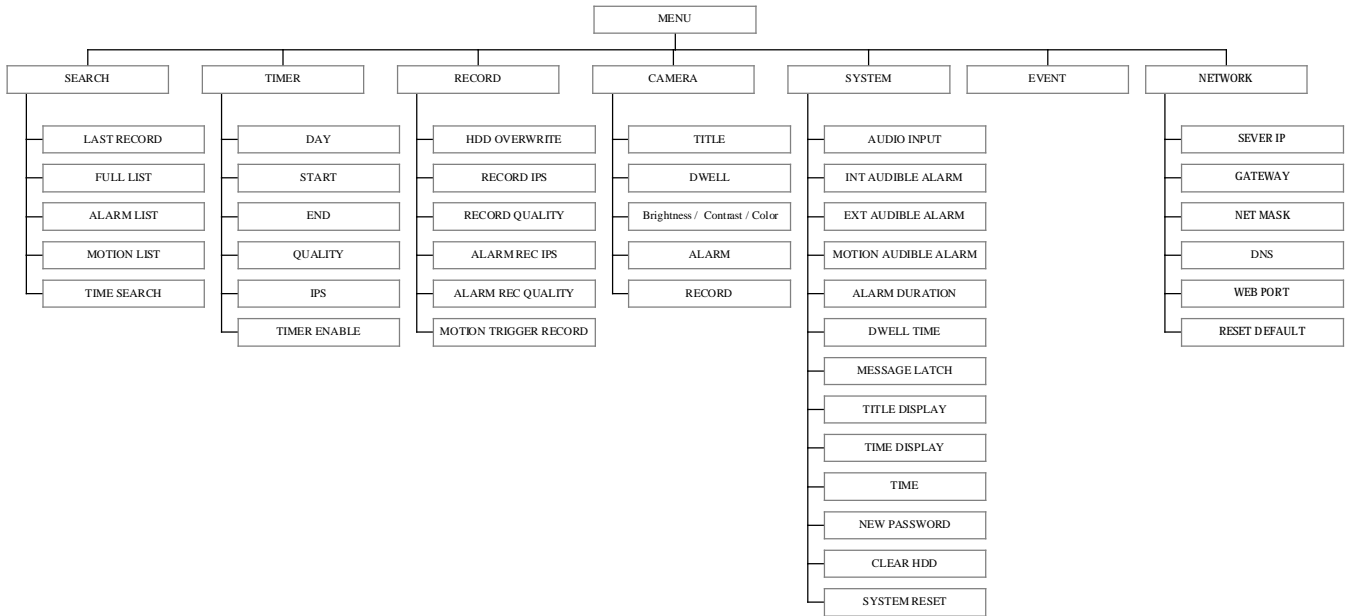

ACCESS MENU

The Menu allows you to configure your DMR settings. Please follow the steps below to access the Menu :

Press the Menu button. The password screen will appear:

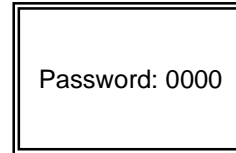

NOTE : The default Password is 0000. Press the Enter button to access the Menu.

To key-in the Password, press the "Right" and "Left" buttons to move between numbers, and use the "Up" and "Down" buttons to input the number.

Press the ENTER button once the correct Password is entered. The MENU options screen will appear.

Note: If you get a message "Password Error", you might enter an incorrect password.

MAIN MENU

There are 7 options available in the Main Menu:

SEARCH ----- Find recorded list
TIMER ----- Scheduling Record
RECORD ----- Record Mode Setup
CAMERA ----- Camera Channel Setup
SYSTEM ----- System Setup
EVENT ----- Event List
NETWORK-----Network Setup

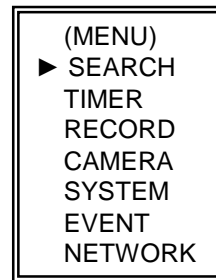

Outlined below are the buttons used for Menu setting :

- "Up" and "Down" : Scroll up and down or change values when an option is selected and is blinking
- "Left" and "Right" : Scroll sideways within a menu option that has been selected
- ENTER : Selects a submenu / an option under a submenu for browsing / modification
- MENU : Completes modification of a menu option and exits a menu

MENU OPTIONS

SYSTEM

1. AUDIO INPUT

To choose one of 4 channels to record. (can only select 1 during operation for recording)

2. INT AUDIBLE ALARM

To set the INTERNAL AUDIBLE ALARM. It will be triggered by event occurrence when the setting is ON.

3. EXT AUDIBLE ALARM

To set the EXTERNAL AUDIBLE ALARM. It will be triggered by event occurrence when the setting is ON.

4. MOTION AUDIBLE ALARM

To set the MOTION AUDIBLE ALARM. It will be triggered by motion detection occurrence when the setting is ON.

5. ALARM DURATION

Set the reaction time which was determined by the length of alarm mode responded to a buzzer. Default setting is 10 sec. Options are 10 SEC, 15 SEC, 20 SEC, 30 SEC, 1MIN, 2MIN, 3 MIN, 5 MIN, 10 MIN, 15 MIN, 30 MIN, ALWAYS.

6. DWELL TIME

DWELL TIME is the time period that each channel sequentially shown on call monitor.

7. MESSAGE LATCH

To select whether the DMR messages will disappear after 10 sec or remain on screen. NO is the default setting which the messages will go away after 10 sec.

NOTE : Video loss, Alarm and Motion messages will be shown the same as Alarm Duration time.

8. TITLE DISPLAY

To set the title shown on monitor or not.

9. TIME DISPLAY

To set the time format on the DMR.

10. TIME

To set the correct time on the DMR.

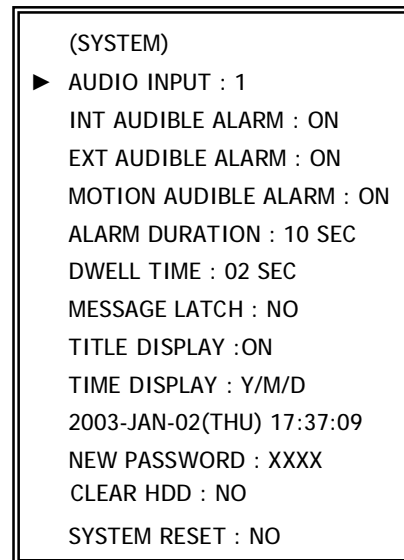
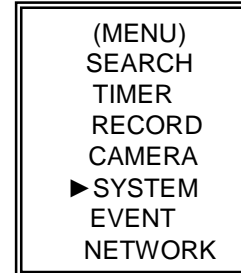

11. NEW PASSWORD : XXXX (Default password : 0000)

To set the new password.

12. CLEAR HDD

Delete all the contents of your HDD. When you choose "YES" on this option, you will be prompted with the question shown : Press "▶" to clear HDD or press "◀" not to clear HDD.

ALL DATA IN HDD
WILL BE CLEARED
ARE YOU SURE?
(◀ : NO ▶ : YES)

13. SYSTEM RESET

Reset the system to book to the factory default settings.

SEARCH

Press "ENTER" to confirm SEARCH setup, and the screen will show the following options.

1. LAST RECORD

Play the last recorded video.

2. FULL LIST

Show a listing of all recorded video sorted by time on the HDD.

D : Motion Recording
M : Manual Recording time
A : Alarm Recording time
T : Timer Recording time
M-HDD : Storage in Master HDD
S-HDD : Storage in Slave HDD

3. ALARM LIST

Show a listing of all recorded video triggered by an Alarm.

NOTE : If there is no Alarm recorded, the screen will display "EMPTY".

4. MOTION LIST

Show a listing of all triggered motion detections.

5. TIME SEARCH

Find video recorded on a specific date that is entered.

(MENU)
▶ SEARCH
TIMER
RECORD
CAMERA
SYSTEM
EVENT
NETWORK

▶ M 2002-JAN-01 02:32:03 M-HDD
M 2002-JAN-03 01:02:03 M-HDD
A 2002-JAN-05 21:12:24 M-HDD
T 2002-JAN-12 12:57:38 M-HDD
D 2002-JAN-13 16:16:39 S-HDD
M 2002-JAN-15 23:55:23 S-HDD
T 2002-JAN-22 18:22:13 M-HDD
D 2002-JAN-25 12:52:03 S-HDD

◀ : PAGE UP ▶ : PAGE DOWN

(SEARCH)
▶ LAST RECORD
FULL LIST
ALARM LIST
MOTION LIST
TIME SEARCH

TIMER

1. DAY

Select the day, or days of the week (Mon–Fri / Sat-Sun / Daily) that you wish to schedule the DMR to auto recording.

NOTE : 1.Special Date could be changed by “Enter”, “Up” and “Down” buttons.

2. If you have selected the specific date and recording timer set from that specific day to a new day, then the Recording Timer Schedule will be set as a whole week. For specific date of Recording Timer Schedule, it is not recommended to set End Time over 23:59. For Example:If you set Timer Schedule Day as Sunday, and START from 11:30, but End on 00:20, then Recording Timer Schedule is set as from every Sunday's 11:30 to next Sunday's 00:20. If you only want to set Recording Timer Schedule from every Sunday 11:30 to Monday 00:20, then you should set Recording Timer Schedule as Sunday from 11:30 to 23:59, and Monday from 00:00 to 00:20.

2. START

Select the starting time for the recording.

3. END

Select the finishing time for the recording.

4. QUALITY

Select the image quality for the recording. There are four Quality settings : BEST, HIGH, NORMAL and BASIC.

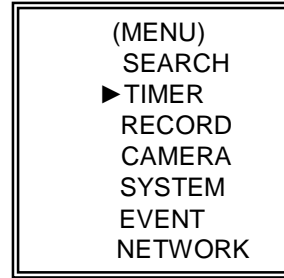

5. IPS

Stand for Images Per Second and it could let you see Record submenu for more details.

NTSC — 25A 、 15 、 08 、 04 、 02 、 01

PAL — 18A 、 12 、 06 、 03 、 02 、 01

NOTE : “A” means “ Record with Audio”.

(TIMER)				
DAY	START	END	QUALITY	IPS
DAILY	00:00	00:00	BEST	25A
DAILY	00:00	00:00	BEST	25A
DAILY	00:00	00:00	BEST	25A
DAILY	00:00	00:00	BEST	25A
DAILY	00:00	00:00	BEST	25A
DAILY	00:00	00:00	BEST	25A
DAILY	00:00	00:00	BEST	25A
TIMER ENABLE : NO				

6. TIMER ENABLE

Enables / disables Timer recording function.

RECORD

1. HDD OVERWRITE

Select "YES" to overwrite previous recording video in HDD.

NOTE : When the HDD is full under O/W Recording mode, previous recorded files may be overwritten without further warning notices.

2. RECORDING IPS

Select the images per second of recording. The options are as following :

NTSC—25A、15、8、4、2、1

PAL—18A、12、6、3、2、1

NOTE : "A" means "Record with Audio".

3. RECORDING QUALITY

There are four quality settings : BEST, HIGH, NORMAL and BASIC.

4. ALARM REC IPS

Select the images per second of recording during an Alarm. The options are as following :

NTSC—25A、15、8、4、2、1

PAL—18A、12、6、3、2、1

NOTE : "A" means "Record with Audio".

5. ALARM REC QUALITY

There are four quality settings during an Alarm : BEST, HIGH, NORMAL and BASIC.

6. MOTION TRIGGER RECORDING

When you set up the MOTION DETECTION function (Please refer to Page.15 for MOTION DETECTION SETUP),

1. Select "ON" to set up the motion trigger recording: It can automatically switch from stand-by mode to Recording Mode.

The motion detection will change the scanning sequence and shows  and "D" on the monitor.

NOTE: The trigger recording time will depend on ALARM DURATION mode setting (Please refer to page.10 for ALARM DURATION) and it will record from the last trigger time. For example, when the alarm duration setting is 1 min, the time recording time is from 9:00:00 to 9:01:00.

If the motion detection triggered again at 9:00:40, the triggered recording time will from 9:00:00 to 9:00:40 and 9:00:40 to 9:01:40. The total recording time is 00:01:40.

2. Select "OFF": The screen shows  the motion detection will change the scanning sequence while in recording mode and shows "M" on the monitor.

(MENU)
SEARCH
TIMER
RECORD
▶ CAMERA
SYSTEM
EVENT
NETWORK

CAMERA

1. TITLE

Assign a six-characters title to each camera input. Initially each title is the camera's max number.

2. DWELL

Select "ON" to set up the channel auto switching on the call monitor.

3. (Brightness) / (Contrast) / (Color)

Have a video adjustment (Brightness / Contrast / Color) of each channel. The level is from 0 to 9.

4. ALARM

Select LOW / OFF / HIGH for alarm polarity. The default value is LOW.

5. RECORD

Set up which channel you want to record during alarm trigger. The DMR record methods are as below :

EVENT : when alarm input is triggered, DMR will record alarming channel more frequently.

For example : when CH01 is triggered, the recording method will become 1-2-1-3-1-4....

NORMAL : when alarm input is triggered, DMR will record normally as set up.

OFF : when alarm input is triggered, DMR will not record.

	TITLE	DWELL	☀	●	■	ALARM	RECORD
▶	--- 01	ON	5	5	5	LOW	EVENT
	--- 02	ON	5	5	5	LOW	EVENT
	--- 03	ON	5	5	5	LOW	EVENT
	--- 04	ON	5	5	5	LOW	EVENT
	--- 05	ON	5	5	5	LOW	EVENT
	--- 06	ON	5	5	5	LOW	EVENT
	--- 07	ON	5	5	5	LOW	EVENT
	--- 08	ON	5	5	5	LOW	EVENT
	--- 09	ON	5	5	5	LOW	EVENT
	--- 10	ON	5	5	5	LOW	EVENT
	--- 11	ON	5	5	5	LOW	EVENT
	--- 12	ON	5	5	5	LOW	EVENT
	--- 13	ON	5	5	5	LOW	EVENT
	--- 14	ON	5	5	5	LOW	EVENT
	--- 15	ON	5	5	5	LOW	EVENT
	--- 16	ON	5	5	5	LOW	EVENT

NETWORK

Press the “▲” “▼” “◀” “▶” buttons to move the cursor.

Press the “+” “-” buttons to change the digit.

Press the “MENU” button to confirm the changes/ to exit the menu.

Set IP ADDRESS, GATEWAY, NET MASK, DNS and PORT.

Choose YES in RESET DEFAULT will go back to default value of NETWORK.

(MENU)
SEARCH
TIMER
RECORD
CAMERA
SYSTEM
EVENT
▶ NETWORK

(NETWORK)	
SERVER IP	192.168.001.010
GATEWAY	192.168.001.065
NET MASK	255.255.255.000
DNS	168.095.001.001
WEB PORT	00080
RESET DEFAULT	NO

MOTION DETECTION

MOTION DETECTION SETUP

1. Press "MENU" to enter the menu set up, then "Down" to CAMERA setup.
2. Press "ENTER" twice to enter the Motion Detection Setup.
3. Each screen displays the current camera picture overlaid with the motion targets (as Figure 1).
You can push the button "Left" or "Right", "Up" or "Down" to adjust motion detection in ON or OFF.
4. The targets on each motion setup can be turned to ON or OFF individually. To set up targets, using the front panel buttons:
 - ↵ Press "ENTER" to confirm the channel
 - ↵ Press "ENTER" to enter motion mode
 - ▲ Up -- moves the target cursor up one row at a time.
 - ▼ Down -- moves the target cursor down one row at a time.
 - ◀ Left -- moves the target cursor left one column at a time.
 - ▶ Right -- moves the target cursor right one column at a time.
 - ↵ Press "ENTER" to turn the target cursor ON and press "ENTER" again to turn the target cursor OFF. (Figure 1-1)
 - Zoom – turns all targets in the current row ON or OFF. (Figure 1-2)
 - PIP – turns all targets on the screen ON or OFF. (Figure 1-3)
5. Press "SLOW" button to setup the Sensitivity list up to 255 and "REC" button to setup the Sensitivity list down to 000.
The default value is set on 32.

NOTE : Sensitivity value is related to motion and brightness change. Low value (as 001) means higher sensitivity on motion and brightness change. High value (as 255) means lower sensitivity on motion and brightness change. User can choose the suitable sensitivity value in different locations.

NOTE : When motion trigger recording setting is ON, it can automatically switch from stand-by mode to record mode. The motion detection will change the scanning sequence and shows  on the monitor. There will be an action as following:



For example : If the motion is detected on Camera #1, its recording & scanning sequence will be more frequent. The sequence will be as 1st, 2nd, 1st, 3rd, 1st, ... 16th. And channel 1 will show  on the screen. If 2nd camera and 3rd camera both motion detection are activated, they will be scanning as 1st, 2nd, 3rd, 2nd, 2nd, 3rd, 3rd, 2nd, 3rd, 4th, 2nd, 3rd ... and vice versa. And CH2 & CH3 will show  for a period of time which is same as Alarm Duration time.

Figure 1 MOTION DETECTION SETUP

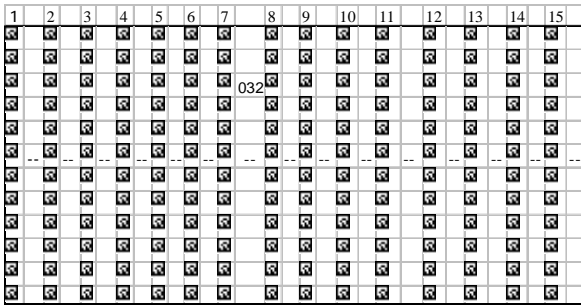

Figure 1-1 MOTION DETECTION SETUP — 1~15

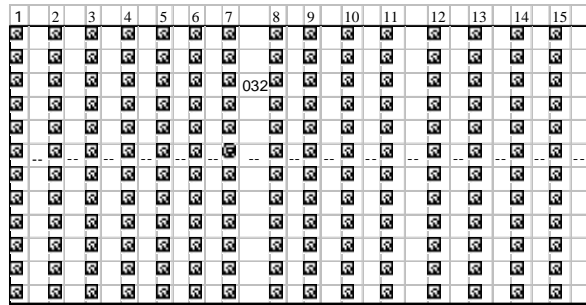

Figure 1-2 MOTION DETECTION SETUP-- LINE

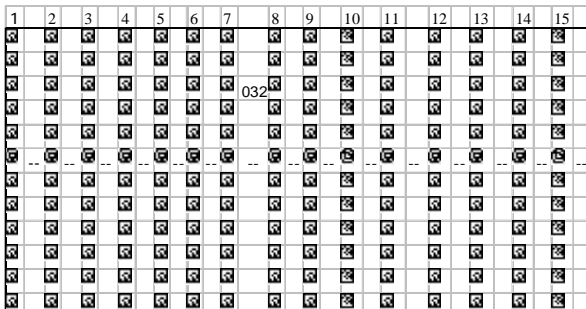
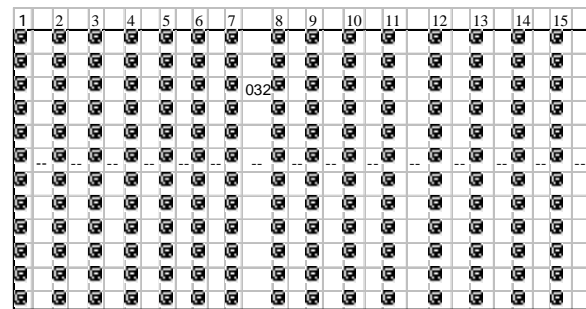

Figure 1-3 MOTION DETECTION SETUP-- ALL



EVENT

There are only 16 recorded events will be shown on a single page and please press “◀” or “▶” to change the pages or press ▲ + ▼ to CLEAR the EVENT record.

M-HDD WARNING: Master HDD might be failed.

M-HDD LOSS: Master HDD does not exist. Now user can use the other HDD.

M-HDD ERROR: Master HDD might be error

S-HDD WARNING: Slave HDD might be failed

S-HDD LOSS: Slave HDD does not exist. Now user can use the other HDD.

S-HDD ERROR: Slave HDD might be error

HDD FULL: HDD is full

SYSTEM ERROR: System might be failed

----02 VLOSS: Channel: 2 Video loss

----03 ALARM: Channel: 3 External I/O Alarm have triggered

POWER RESTORE : Power restore

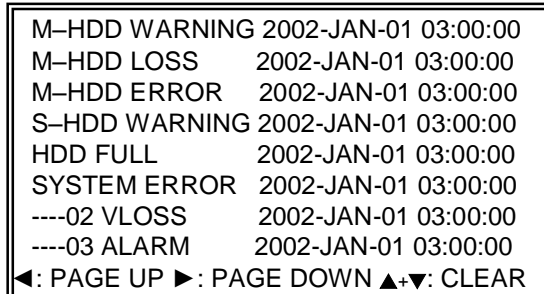
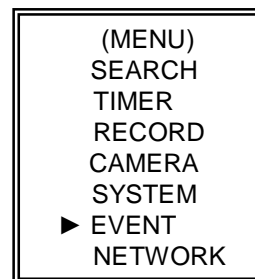

Network Setting Guide

HARDWARE CONNECTION AT DMR SIDE

Direct Connect with PC

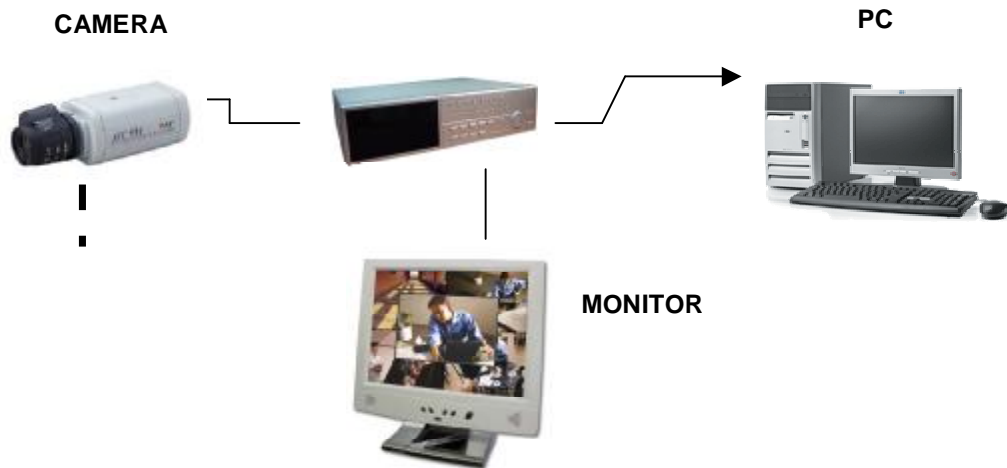

Remote Connect Via Internet

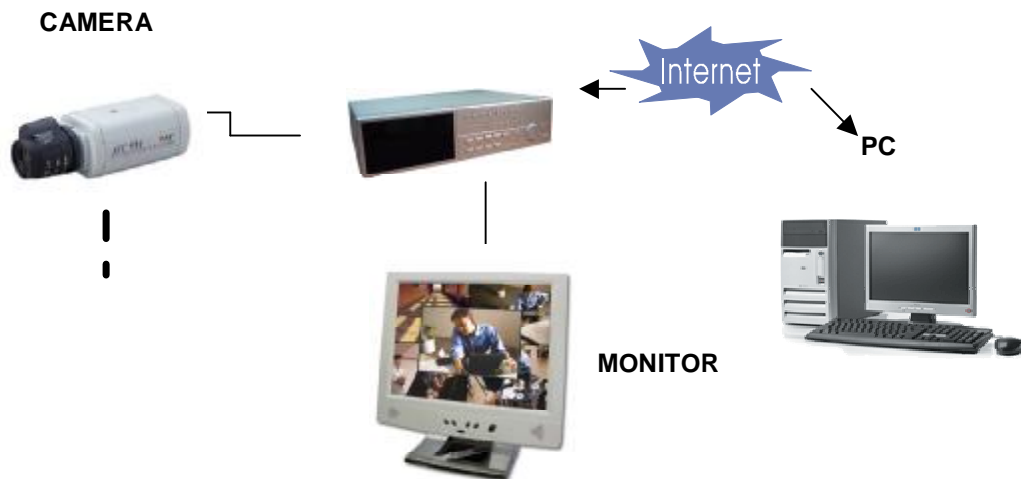

STATIC IP SETTING

STEP1: Software installation

1. Put the attached CD into a CD-ROM and it will start to install the application program on Windows PC.
2. Press "Next".



3. Choose destination location and press "Next".

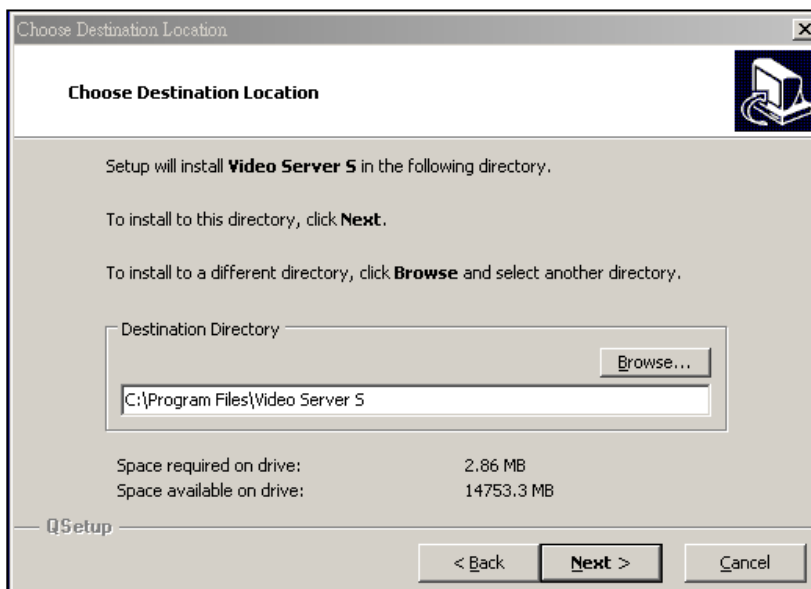

4. Set program shortcuts setting and press "Next".

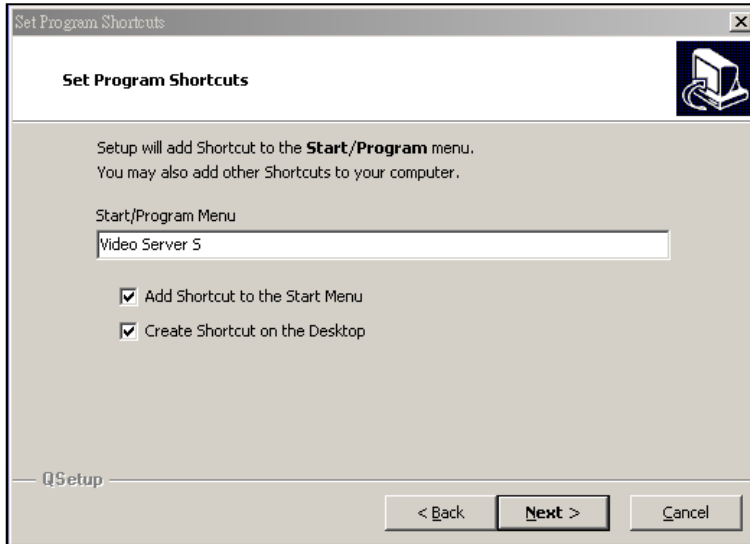

5. Press "Next" to copy files

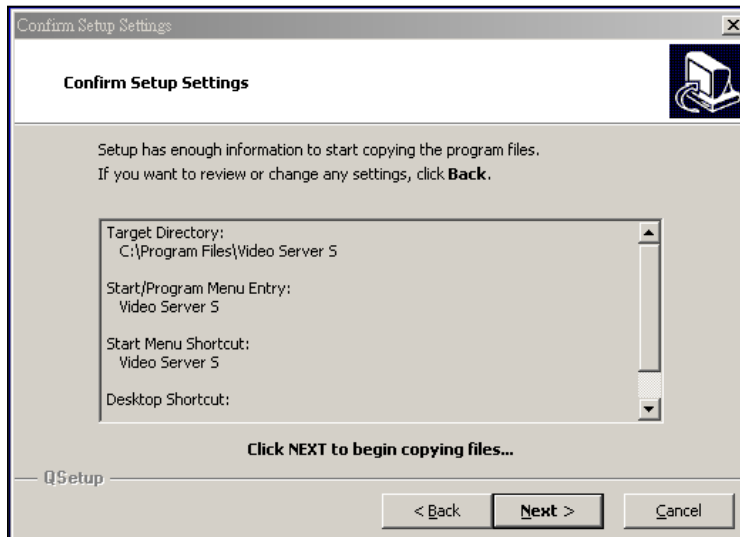

6. After the installation, there are 6 files and 1 folder in your assigned path (file folder) as below.



Step2 : Static IP setting

In DMR MENU / NETWORK set IP ADDRESS, GATEWAY, NET MASK, DNS and WEB PORT which are provided from your local ISP (internet service provider).

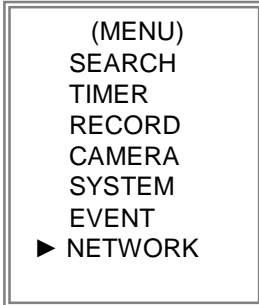

For example

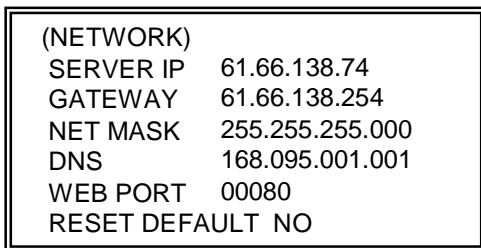

After all network settings are finished, please connect DMR to internet.

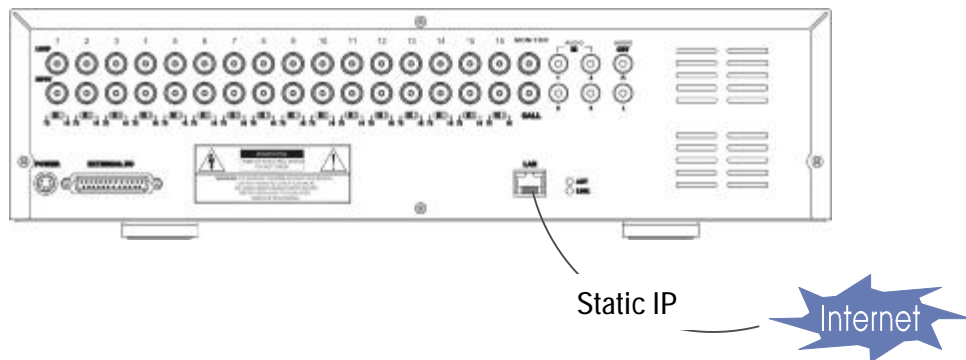

Step3 : Connect PC and DMR via the internet

Click  twice and enter your User name, Password (Note : If you never change the "Account" before, the default user name and password are both "admin") and Server IP which you have set to DMR in step 2. Then click OK to connect.



The screenshot shows a dialog box titled "VIDEO WEB SERVER". It contains the following fields and controls:

- User Name :** (highlighted with a red box)
- Password :** (highlighted with a red box)
- Server IP :** (highlighted with a red box)
- Web Port :** 
-

DYNAMIC IP SETTING

Step1 : Software installation

- 1.Put the attached CD into a CD-ROM and it will start to install the application program on Windows PC.
2. Press "Next".

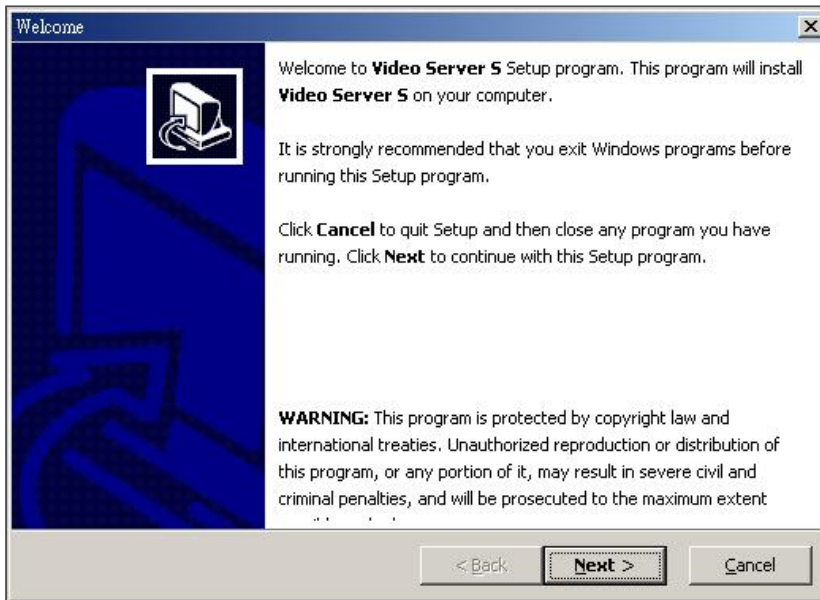

- 3.Choose destination location and press "Next".

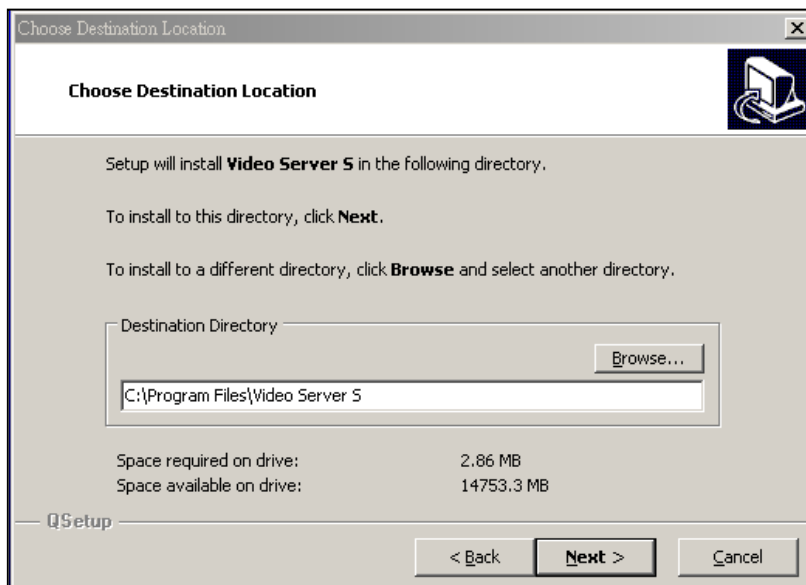

4. Set program shortcuts setting and press "Next".

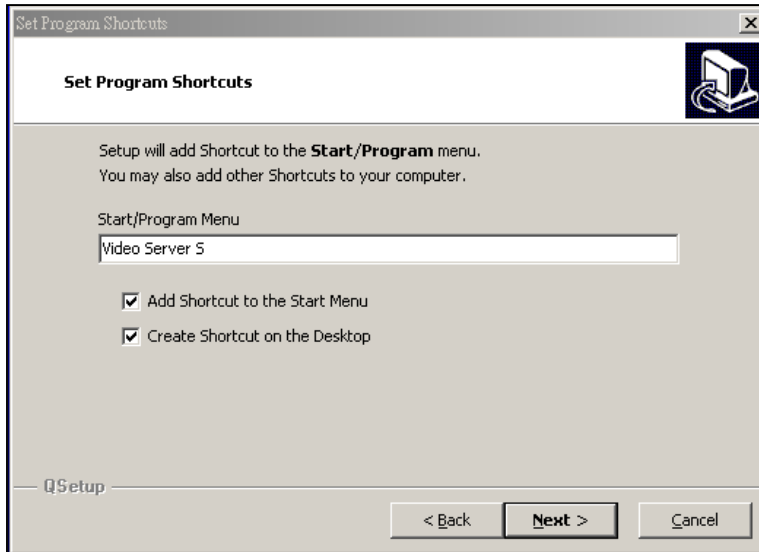

5. Press "Next" to begin copying files

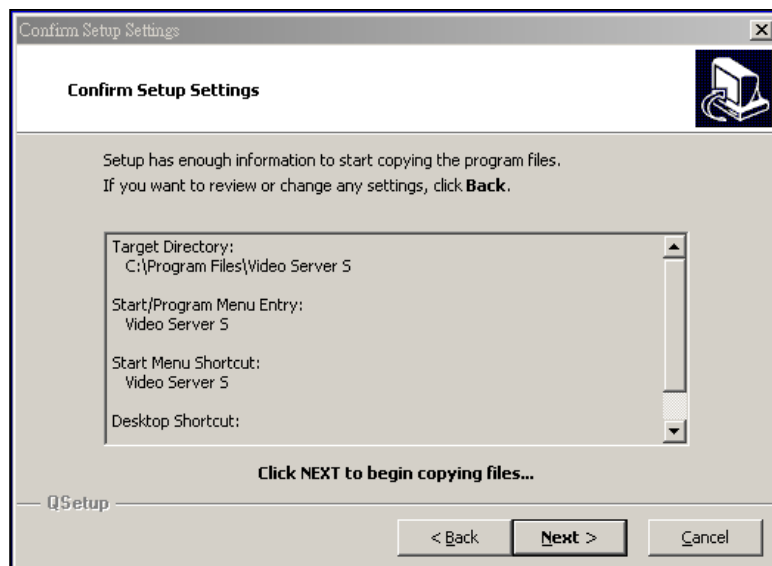

6. After the installation, there are 6 files and 1 folder in your assigned path (file folder) as below.



Step2 : DDNS apply

1. Click on free site "<http://www.dyndns.org>" (please look at the example below, you can also apply DDNS in other DDNS web page) and "ACCOUNT"

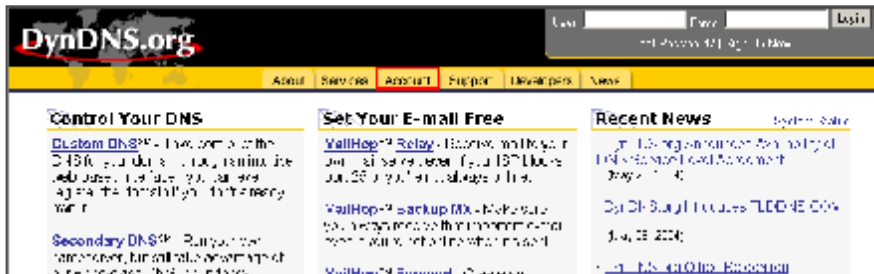

2. Press "Create Account"

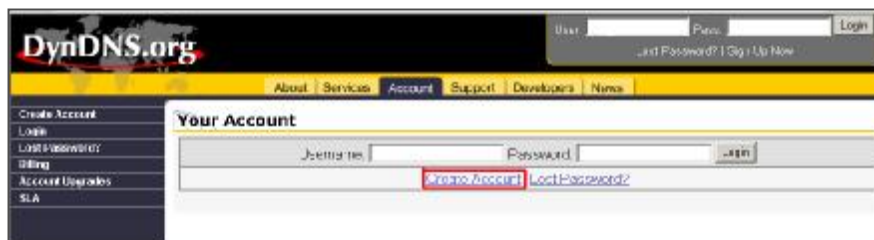

3. Register the information and click on “Create Account”

The screenshot shows the 'Create Account' page on DynDNS.org. The page has a dark blue header with the DynDNS.org logo and navigation links for 'About', 'Services', 'Account', 'Support', 'Developers', and 'News'. A sidebar on the left contains links for 'Create Account', 'Login', 'Lost Password?', 'Billing', 'Account Information', and 'FAQ'. The main content area is titled 'Create Account' and contains the following text: 'Please complete the form below to create your account. You will receive an e-mail containing instructions to activate your account. If you do not follow these directions within 48 hours, you will need to re-register your account.' Below this is a security warning: 'It is strongly recommended that you visit this page [securely](#). You are not currently visiting this page securely.' A scrollable box contains the 'ACCEPTABLE USE POLICY' text, which states that services are provided under specific terms and conditions. Below the policy is a checkbox labeled 'I have read and agree to the Acceptable Use Policy above:'. The form includes input fields for 'Username', 'E-mail Address' (with a 'Confirm E-Mail Address' field), and 'Password' (with a 'Confirm Password' field). At the bottom of the form are two buttons: 'Create Account' and 'Reset Pass'.

4. After registering your account, you will receive an e-mail, which contains instructions to activate your account. If you do not follow these directions within 48 hours, you will need to re-register your account.

5. Login your account.

The screenshot shows the login page on DynDNS.org. It features the same dark blue header and navigation links as the registration page. The login form is located in the top right corner and consists of two input fields: 'User' and 'Pass', followed by a 'Login' button. Below the input fields are links for 'Lost Password?' and 'Forgot My Pass'. The sidebar on the left is the same as in the registration page.

6. Click on “Account” and “Add Host”



7 Users can set up their own DDNS HOST. For example, the user’s applied Host name is “TEST”. And then press “Add Host” to finish the setting.

(NOTE : Some routers don’t support some DDNS HOST)

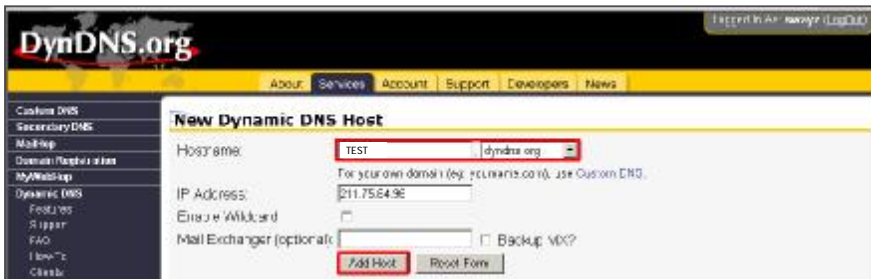

Step3: Login router

NOTE : The following settings are different from router to router. Please read the instruction of your router thoroughly.

1. Connect PC and router (LAN end)

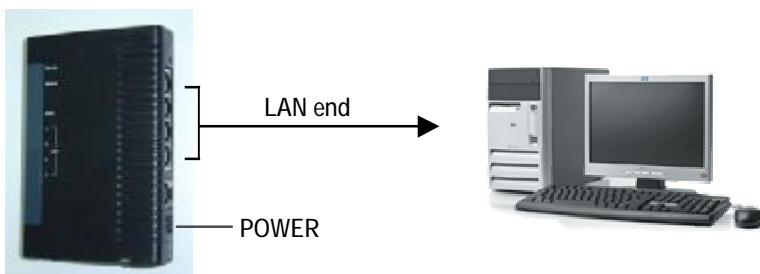

2. Network setting for PC. (The instruction is based on Win XP O/S. If your O/S is Win 2000 or Win 2003, the setup procedure is similar to that of Win XP O/S.)



3. Click "Properties" for TCP/IP setup

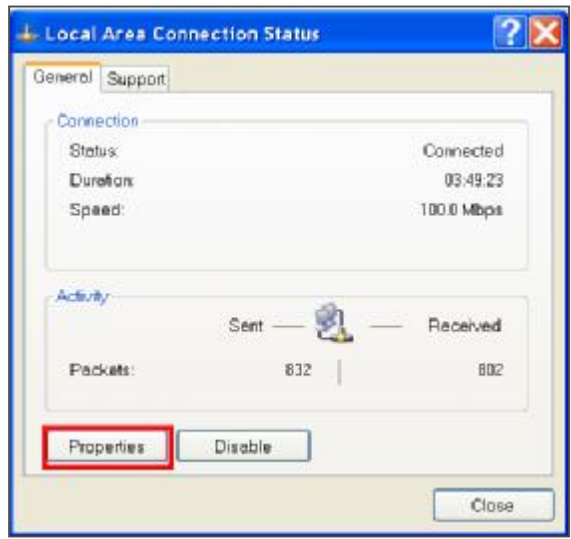

4. Click on "INTERNET PROTOCOL (TCP/IP)", then select "Properties" to setup

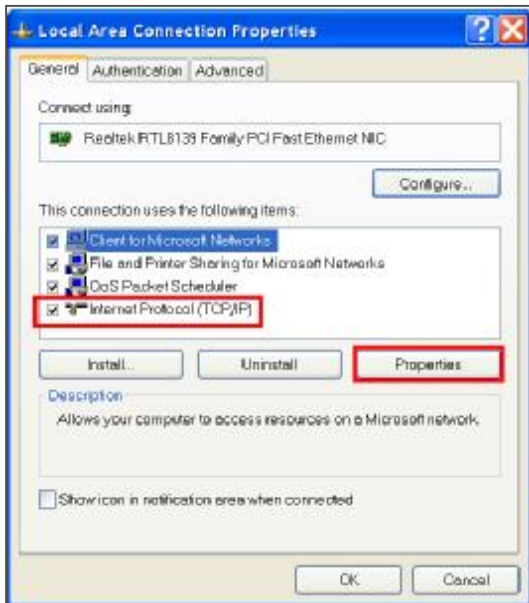

5. Choose "Obtain an IP address automatically"

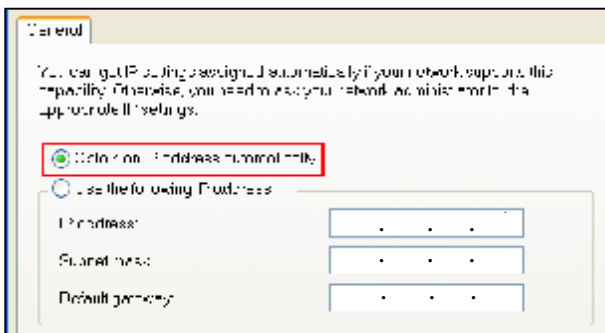

6. Enter "Command Prompt"



7. In the setting window, type “ ipconfig” to find out router’s gateway(e.q. 192.168.1.1)

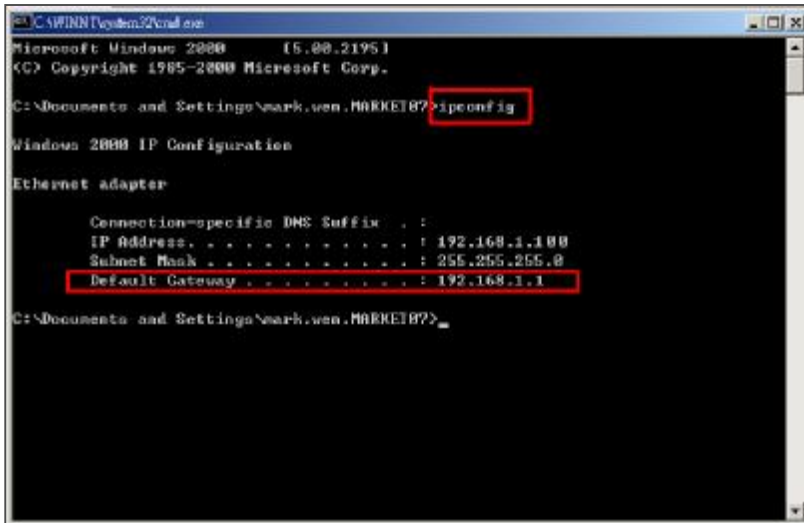

8. Close the window in the above step. Enter the IP address (router’s gateway : 192.168.1.1) to log in to the router from internet explore. And then enter the login web page and key in the router’s user name and password.



Step4 : Router setting

NOTE : In the router setting, we have four steps as follows.

1. Dial setting
2. DHCP setting
3. Virtual server setting
4. DDNS setting

(◇ The following settings will differ from router to router. Please refer to the user's manual of router)

1. Press "INTERNET PORT" and choose your WAN type (e.g. PPPoE), and then enter your "User Name" and "Password" of dialing up to dynamic IP. Press save after you finish the set up.

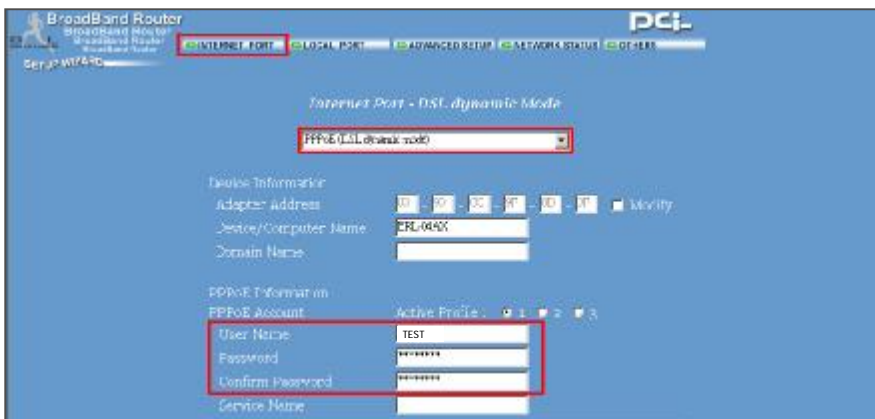

2. Press "LOCAL PORT" and set "Start IP address" and "Number of IP address". (For example, if the IP address of DMR is 192.168.1.10, then 10 is excluded from the setting range) Press save after you finish setting up.



3. In “ADVANCED SETUP / Virtual Server”. Choose “By Port” and set “Port Number” to 80 for DMR. And set “Local Server IP Address” to 192.168.1.10. Press add after you finish the set up.



4. In “ADVANCED SETUP / Dynamic DNS”. Key in the “DNS Account”, “User Name” and “Password” that you applied in step 3. Press save after you finish the set up.



Step 5 : IP setting

In DMR MENU / NETWORK set SERVER IP, GATEWAY, NET MASK, DNS and WEB PORT.

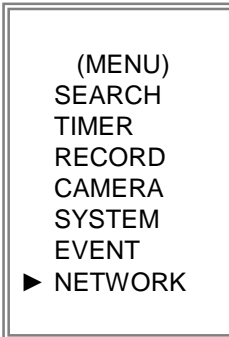

For example

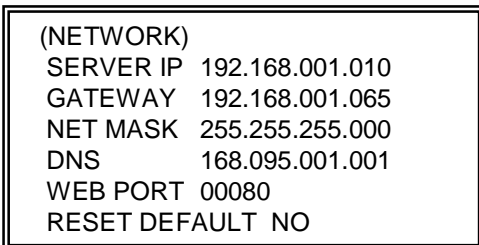

Step6 : Connect router

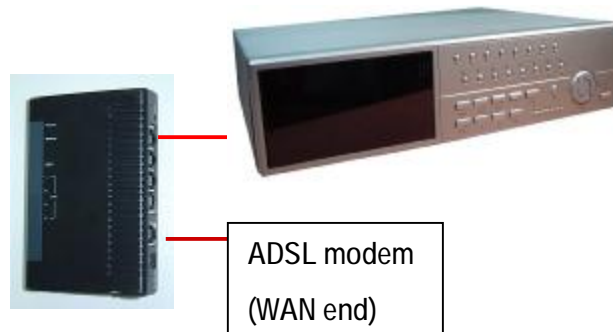

Step7 : Connect to DMR via internet

1. Change PC network setting to the original setting and link PC to the internet.

2. Click  twice and enter your User name, Password and host (Note : The default User Name and Password are both “admin”). Then click OK to connect.

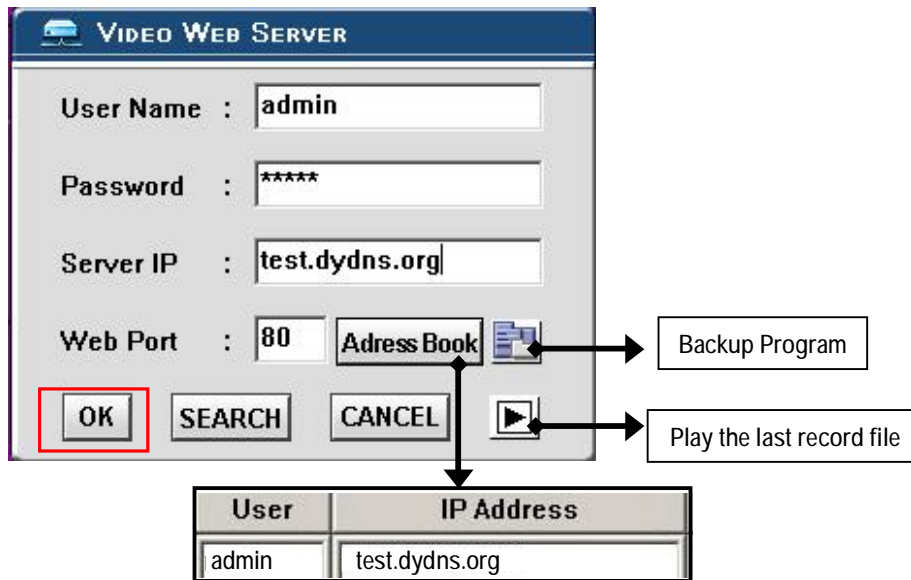

NOTE:

There are two ways to get the software, one is via attached CD, and the other is via Video Web Server.(Refer to P.41~42)

✓Address Book

You can press “Address Book” button to add a new IP or choose any logged IP address to access the Video Server. This function is designed to store the list of IP addresses which you can control and manage.

✓Backup Program

You can press “” button and you can backup all related files of this application program to any storage device that you want (for example: any hard disk or USB Flash Drive).

✓Play last record file

You can press “” button and you can play the last record file.

Note of Dynamic IP setting

*In step 2.7 : Some routers don't support some DDNS HOST.

*In step 3.1 : Please use router's LAN end to connect PC.

*In step 3.8 : Please use IE browser to enter router's gateway.

*In step 4.1 : Please make sure that you have pressed save after setting.

*In step 4.2 : Please make sure that you have pressed save after setting.

*In step 4.3 : Please make sure that you have pressed add after setting.

*In step 4.4 : Please make sure that you have pressed save after setting.

*In step 6 : Please use router's LAN end to connect to DMR. Use WAN end to connect to ADSL modem.

*In step 7 : The Server IP is the DDNS HOST which you set in step 4.4.

SOFTWARE OPERATION AT CLIENT SIDE

Follow the steps for connection at your client site (remote site). (e.g. If you set up the server at your office with one static IP, you can remotely proceed to watch the video anywhere with a networked computer.)

Step 1 : Click  twice to enter Login setup (please refer to “software installation”)

Step 2 : Key in “User Name” and “ Password”. Click “OK” to establish the connection.

For example



Step 3 : If you could see the video screen as following, you have been successfully connecting to the server.



INTRODUCTION OF BASIC OPERATION

A. Video Web Server control panel



1. Image transmission rate per second
2. Data transmission rate
3. Connection/Disconnection
4. Resolution : D1 、 CIF
5. Image quality : High 、 Middle 、 Low
6. Image adjusting : Brightness/ Contrast/ Saturation
7. Snapshot : press this button, the image will be automatically saved in the PC.
8. Record : press this button, the recording file will be saved in the PC automatically.
9. System Config
10. Number of online users

B. Digital device control panel

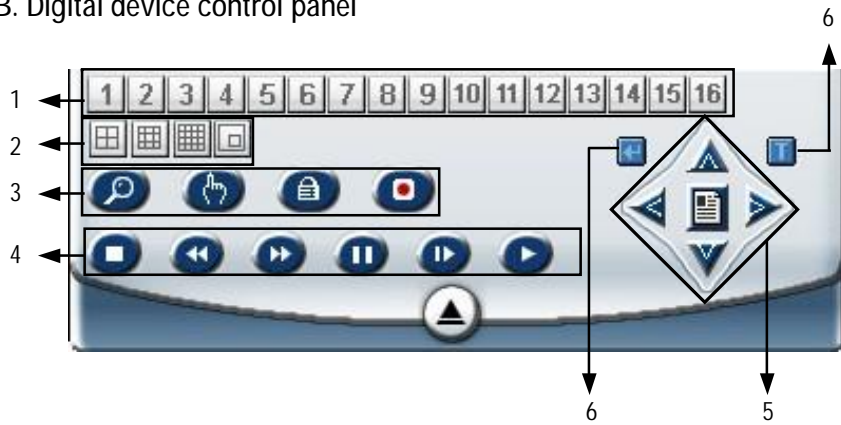

1. CH1-16,
2. 4cut, 7cut, 9cut, 10cut, 13cut, 16cut, PIP
3. Zoom, Select, Lock, Record
4. Stop, Rewind, Fast Forward, Pause, Slow, Play
5. Menu(Exit), Left, Right, Up, Down
6. Enter
7. TURBO

NOTE :

After you press the record icon, there will be a recording file in the path that you have set. Each recording file can be save up to 6000 frames. The recording file will be assigned to the second File if it is more than 6000 frames. Besides, if the HDD space is less than 200MB, the program will stop recording.

PLAYBACK OPERATION

Please find a recording file in the PC and click twice on it to playback.



1. On Screen Display
2. Snapshot
3. Stop
4. Pause
5. Slow (1/2X, 1/4X, 1/8X, 1/16X, 1/32X)
6. PLAY
7. Fast (2X, 4X, 8X, 16X, 32X)
8. OSD show / hide
9. Config setting (Path of snapshot, text color, progress color, channel color)
10. Open Last File
11. Open Next File
12. Duration time / Status
13. Playback controlling bar

ADVANCED SETTING

Click "System Config" for advanced setting.



NOTE :

Apply--

After changing all setting, press "apply" to refresh the data.

Reboot--

Press this button to restart the server.

ACCOUNT

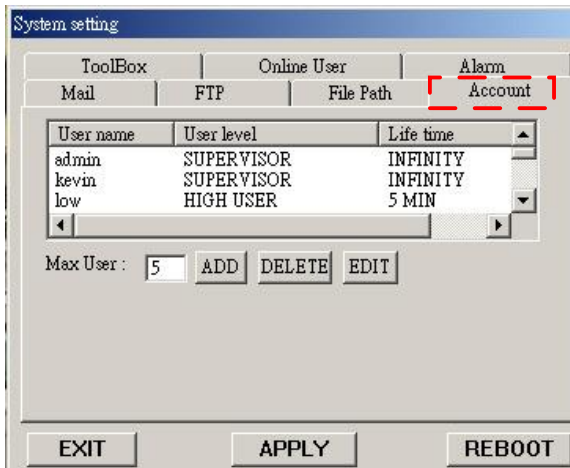

Set up the user's account(Max 10 accounts) , password and authority (Max 6 accounts on line at the same time) .

1.User's level:

SUPERVISOR-control all the functions

HIGH LEVEL-control advanced functions

NORMAL -control basic functions only

GUEST LEVEL -watch the image only

2.Life time : During the period of time, users are allowed to control the Video Web Server.

ALARM

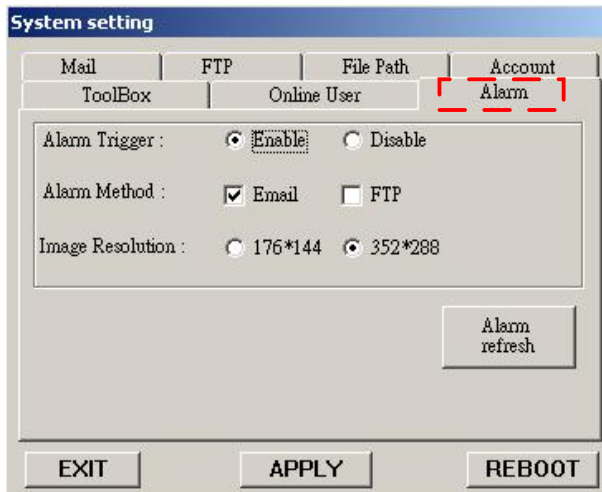

Set up the ALARM function. You can use it to operate "alarm trigger recording" function.

1.Alarm Trigger: Enable or disable Alarm trigger function.

2.Alarm Method : Two selections—E-mail or FTP.

3.Image Resolution : Image storing resolution for Email or FTP function (CIF is 176 *144 ; D1 is 352*288)

4.Alarm refresh : Clean the alarm message "🔴" which is showed on the screen.

* When the motion detection is triggered, the DMR will issue the alarm sound to notify the users.

MAIL

System setting

ToolBox | Online User | Alarm

Mail | FTP | File Path | Account

Server :

Mail from :

Modify alarm email address

ADD DELETE EDIT

Mail Account

Verify Password

Verify : Yes No

User :

Password :

EXIT APPLY REBOOT

When the alarm is triggered, the video server program will capture the instant picture and e-mail the captured image to the assigned recipients.

- 1.You can get all the data from the ISP company or by mailing to the server supplier.(POP3/SMTP server)
- 2.You should set the mail list which you want to send to when the alarm is triggered.
- 3.If it is not necessary for you to verify password and user's name, please choose Verify as "No".

FTP

System setting

ToolBox | Online User | Alarm

Mail | FTP | File Path | Account

UserName :

Password :

Port :

Server :

Directory :

EXIT APPLY REBOOT

When the alarm is triggered, the video server program will capture the instant picture and upload the captured image to the assigned FTP site.

- 1.You can get all the data from your MIS department.
- 2.The default uploading port is No.21.
- 3.You can set the uploading directory.

File Path

System setting

ToolBox | Online User | Alarm

Mail | FTP | File Path | Account

Record Path :

Modify C:\Documents and Settings\bowbow.huang\desktop

Snapshot Path :

Modify C:\Documents and Settings\bowbow.huang\desktop

EXIT APPLY REBOOT

You can modify the storing path for recording file and snapshot images.

TOOLBOX

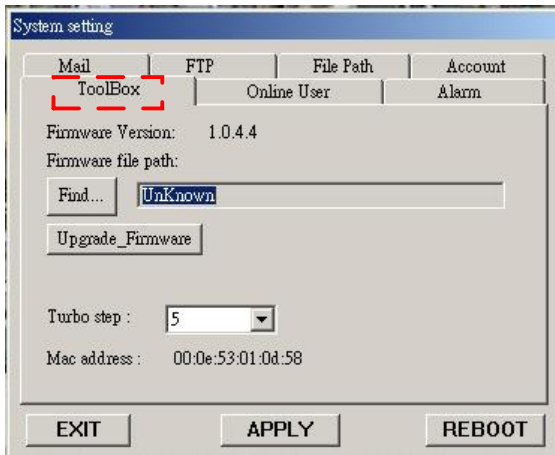

Upgrade the firmware and get the online users' information.

NOTE :Do not reboot the DMR while it is upgrading the firmware.

1.Firmware Version : The current firmware version. You can click on "Find" button to get the latest firmware from PC and press "Upgrade Firmware" to upgrade it.

2.Turbo Step:Activate the turbo button when you would like to shift the selections more quickly by jumping 6 selections at a time.

Online User

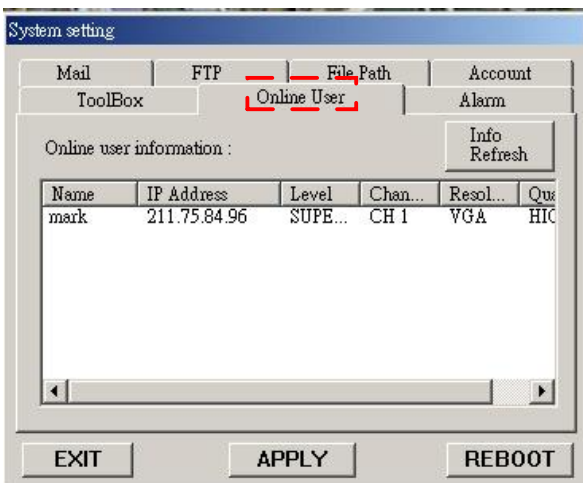

The information of online user.

Info Refresh:
It can refresh the users' information.

CONNECT VIDEO WEB SERVER VIA IE BROWSER

You can also connect Video Web Server via browser. This function is suitable in both WIN 2000 and WIN XP (WIN XP is preferable to WIN 2000)

Step 1 : Enter IP address that you want to connect.(example)



Step 2 : Enter your Username and Password to login Video Web Server.



Step 3 : After you login, you will see as below. (example)

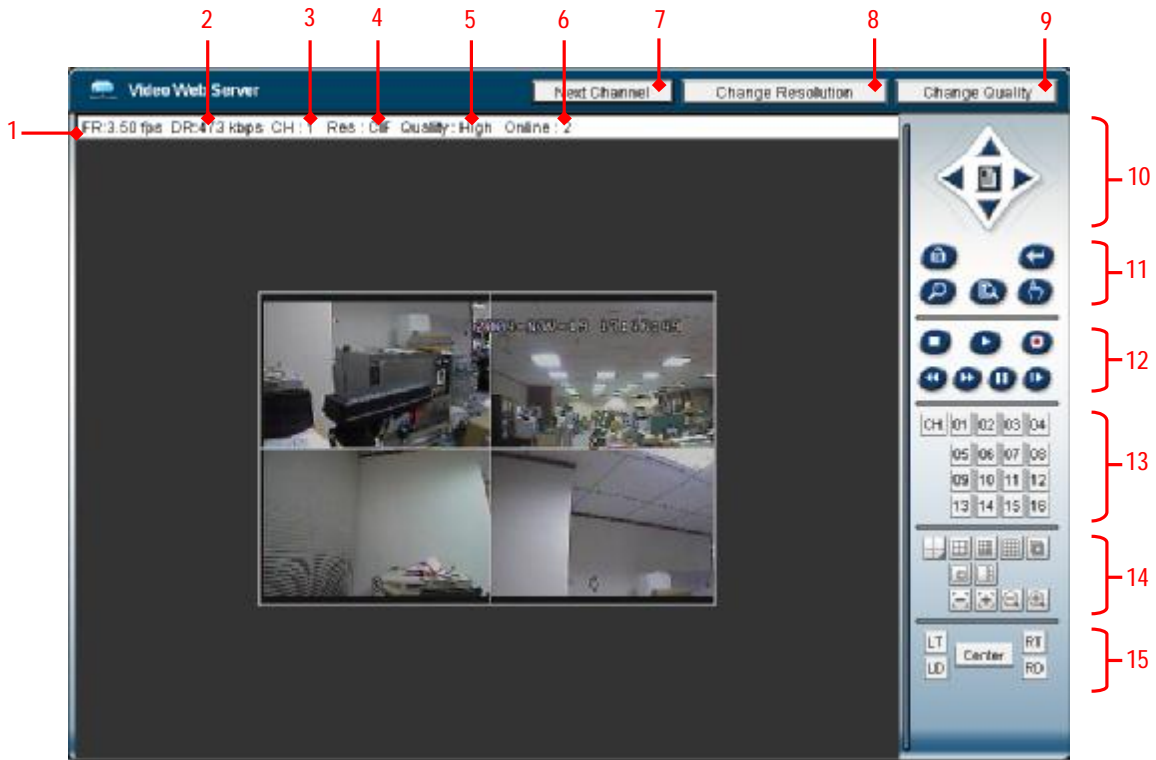

1. Image transmission rate per second
2. Data transmission rate
3. Video Channel
4. Resolution : D1 - CIF
5. Image quality : High - Middle - Low
6. Number of online users
7. Channel switching button
8. Resolution switching button

9. Quality switching button
10. Menu, Left, Right, Up, Down, Exit
11. Lock, Enter, Zoom, Search, Select.
12. Stop, Play, Record, Rew, Fast, Pause, Slow
13. Camera
14. 4cut, 7cut, 9cut, 10cut, 13cut, 16cut, Pip
15. Position of view

Advanced Operation

OPERATION OPTIONS

SELECT

This device allows user to get the ideal view size.

à Press , ,  button to make different view size.

à Press “ Select ” then “ Left ” or “ Right ” button to locate the desired position.

à Press “ Camera Select (1-16) ” to select the appointed camera.

à Press “ Menu ” to exit.

PICTURE IN PICTURE (PIP)

Press PIP  button to enter PIP display screen. The PIP format displays a full screen “background” picture with a 1 / 16 size screen “insert”.

à Press  button to move the insert screen.

à Press “Select” button to confirm the camera selection.

à Press “Left” or “Right” to choose background or insert screen.

à Press camera select (1-16) to select appointed camera into screen.

à Press “Menu” to exit.

ZOOM

Press ZOOM button to enlarge the display of main picture. It displays zoomed picture on main picture and a small window inserted. The inserted window contains a movable 1/4 view size of the appointed camera.

à Press the appointed “Camera Select (1-16)”.

à Press “Zoom” button to select zoom mode.

à Press the “Zoom” button again to move the zoom pointer.

à Press “Menu” to exit.

VIDEO LOSS

Screen will display  if the video input is not connected properly.

KEY LOCK

For further security, you can "Lock" all buttons on your DMR. Locking disables the buttons and prevents other people from using the system.

Press ENTER and MENU at the same time to enable Key Lock.

Press ENTER and MENU at the same time and key in password (Default : 0000), then press "ENTER" to disable Key Lock.

TROUBLE SHOOTING

When malfunction occurs with DMR, it may be not serious and can be corrected easily. The table below describes some typical problems and their solutions. Please check them before calling your DMR dealer.

PROBLEM	SOLUTION
HDD Not Found	I Please Insert HDD
	I Please use the Key to lock the HDD Cartridge
	And press any key
No power	I Check power cord connections.
	I Confirm that there is power at the outlet.
Not working when press any button	I Check if it is under Key Lock mode.
	I Press " MENU " & " ENTER " to exist Key Lock mode.
No recorded video	I Check if the HDD is installed properly.
Timer Record enable does not working	I Check if the Record Enable is set to YES
No live video	I Check camera video cable and connections.
	I Check monitor video cable and connections.
	I Confirm that the camera has power.
	I Check camera lens setting.

SPECIFICATIONS

Video format	NTSC/EIA or PAL/CCIR
Network Interface	Ethernet(10/100 Base-T)
Protocols	TCP/IP, ICMP, SMTP, HTTP, FTP
Trigger & Action	E-Mail images or images uploading to FTP site's specific account/Remote Recording
Hard disk storage	IDE type, UDMA 66
Record mode	Manual / Alarm / Timer / Motion
Camera Input Signal	Composite video signal 1 Vp-p 75Ω BNC, 16 channels
Camera Loop Back	Composite video signal 1 Vp-p 75Ω BNC, 16 channels
Main Monitor Output	Composite video signal 1 Vp-p 75Ω BNC
Call Monitor Output	Composite video signal 1 Vp-p 75Ω BNC
Audio input	4 audio inputs, (RCA) *
Audio output	2 audio outputs, (RCA) **
Motion Detect Area	15 * 12 targets per camera (NTSC) / 15 * 14 targets per camera (PAL)
Motion Detect Sensitivity	256 Levels
Video Loss Detection	Yes
Refresh Rate	Up to 120 images/sec. for NTSC / 100 images/sec. for PAL
Recording Rate	Up to 25 images/sec. for NTSC / 18 images/sec. for PAL
Dwell Time	Programmable (1~10 Sec)
Picture in Picture	Yes (Movable)
Key Lock	Yes
Picture Zoom	2*2 (Movable)
Camera Title	6 letters
Video Adjustable	Color/ Contrast/ Brightness Adjustable
Alarm Input	TTL input, Hi (5V), Low (GND)
Alarm Output	COM,/N.O
Time Display Format	YY/MM/DD, DD/MM/YY, MM/DD/YY, OFF
Power Source	AC100~240V \pm 10% switching adaptor
Power Consumption	<45W
Operation Temperature	10 ~ 40 °C
Dimension (mm)	432(W) x 110(H) x 325(L)
Net Weight	5.7 kg

Specifications are subject to change without notice.

* 4 audio inputs, but only can select 1 during operation for recording

** with 2 mono audio outputs from the same source.

APPENDIX #1 – INSTALL HDD

Please follow the next steps carefully in order to ensure correct installation.

The compartment located on the front panel of the DMR is the removable Cartridge Casing in which you insert the HDD. The various parts of the Cartridge Casing are labeled for your reference.

1. Remove the Cartridge Case from the DMR

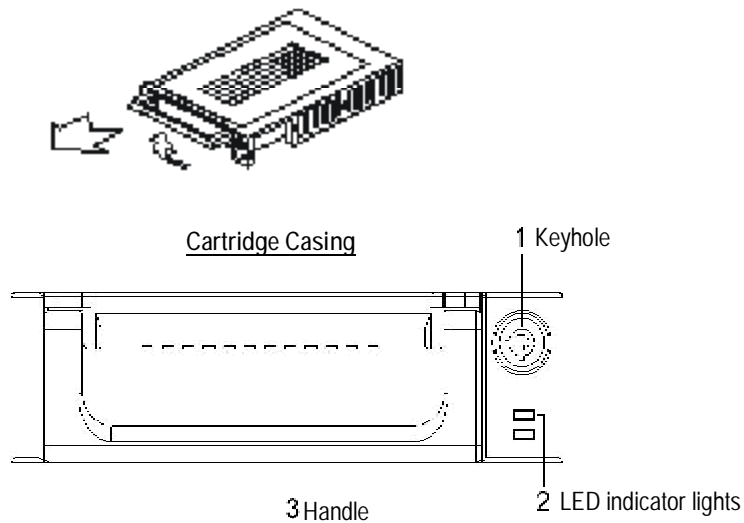

2. Remove the Cover from the Cartridge Casing

- Unclip the release latch with the word "OPEN" printed beside it by gently pushing on the latch.
- Slide the cover off the Cartridge Casing.

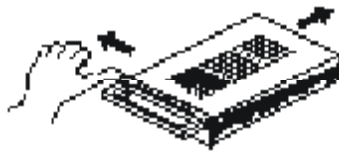

3. Connect the HDD into the Cartridge Casing

Please take the Hard Disk Drive and Connect the two cables from the back of the Cartridge Casing to the HDD.

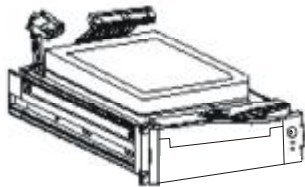

4. Secure the HDD in the Casing (optional)

Use the supplied screws and tighten them, and positioning the HDD into place.

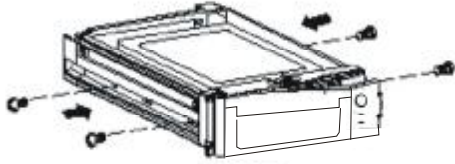

5. Slide the top Cover over the Cartridge Casing

Slide the Cover forward over the Cartridge Case. Ensure it is secured in place over the release latch.

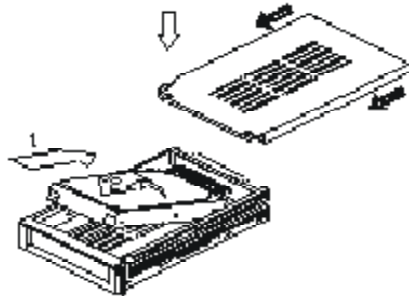

6. Reinsert the Cartridge Casing into the DMR

Fully insert the Cartridge Case into the DMR.

7. Lock the Cabinet

Lock the cabinet by turning the key clockwise.

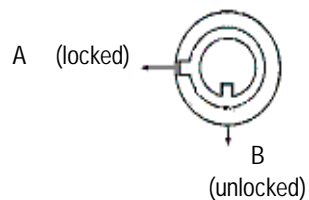

Note : If you do not lock the cabinet, the DMR system will not function properly.

1. If two HDDs are set up, one should be selected as " Master " and the other should be selected as " Slave".
2. This product does not support hot swap. Please power off the unit before removing HDD.
3. Approved models and manufacturers of HDD listed in page.2 have been tested and proven compatible with this appliance.
4. Please remove hard disk drive ONLY after power was shut off for more than 60 seconds.
This would protect and extend the operating life of the hard disk drive.
5. Master or Slave HDD should be set up by selecting HDD Jumper.

APPENDIX #2 – RACK MOUNT

Screws and brackets for rack mounting applications can be purchased as an optional accessory.

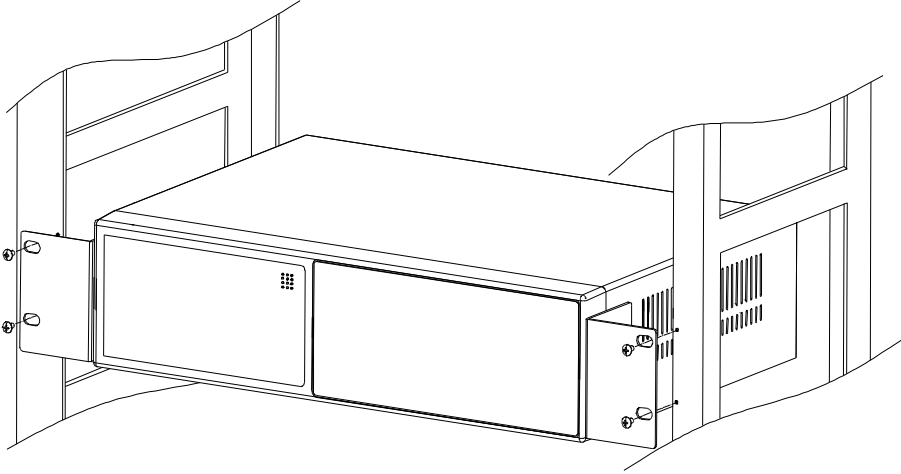

Front Angle with Rack Mount

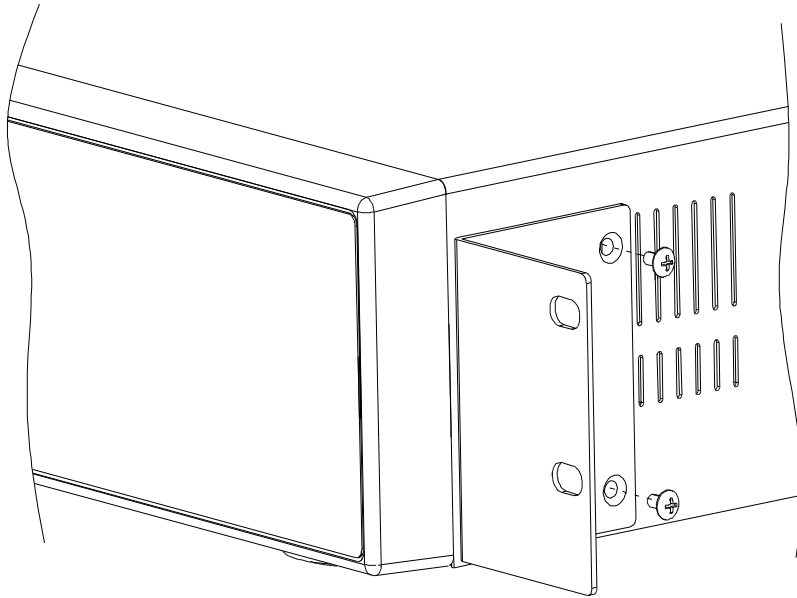

Side View with Rack Mount

APPENDIX #3 – RECORDING SPEED

The Record Time is different based on Record Speed and Record Quality. Please refer to following table.

NTSC SYSTEM

IPS		25A	15	8	4	2	1
Record Quality	Best	48hr	96hr	180hr	360hr	720hr	1440hr
	High	60hr	120hr	226hr	450hr	900hr	1800hr
	Normal	96hr	192hr	360hr	720hr	1440hr	2880hr
	Basic	160hr	320hr	600hr	1200hr	2400hr	4800hr
HDD Type		240GB (120GB X 2)					

PAL SYSTEM

IPS		18A	12	6	3	2	1
Record Quality	Best	48hr	100hr	202hr	406hr	608hr	1216hr
	High	60hr	126hr	254hr	506hr	760hr	1520hr
	Normal	98hr	202hr	406hr	810hr	1216hr	2440hr
	Basic	162hr	336hr	676hr	1350hr	2026hr	4050hr
HDD Type		240GB (120GB X 2)					

*Note: Above data is from actual test data obtained from recording normal TV program.
(Reference only)*

APPENDIX #4 – PIN CONFIGURATIONS

25 pin com port

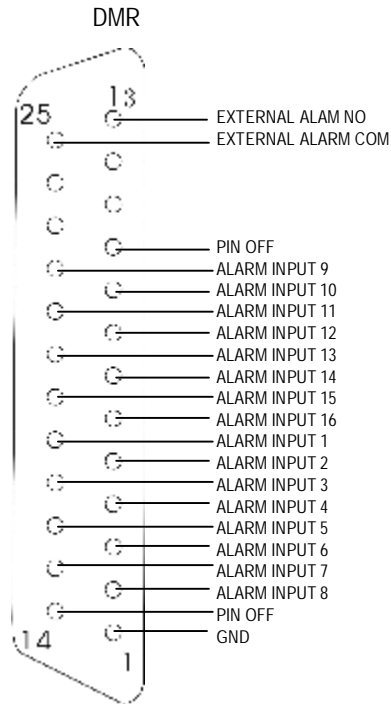

GND	GROUND	PIN 1
ALARM INPUT	To connect wire from ALARM INPUT (PIN 2 -- 9 ; PIN 15-22) to GND (PIN 1) connector, DMR will start recording and buzzer will be on. Ø When Menu/ Camera/ Alarm is set up to “Low” : When alarm input signal is “ Low ”, the unit starts to record and buzzer. Ø When Menu/ Camera/ Alarm is set up to “High” : When alarm input signal is “ High ”, the unit starts to record and buzzer.	PIN2-9; PIN 15-22
PIN OFF	----	PIN10,11,12,13, 14,21,24
EXTERNAL ALARM NO	Under normal operation COM disconnect with NO. But when Alarm triggered, COM connect with NO.	PIN13
EXTERNAL ALARM COM	Under normal operation COM disconnect with NO. But when Alarm triggered, COM connect with NO.	PIN 25