

4 CH Digital Video Recorder

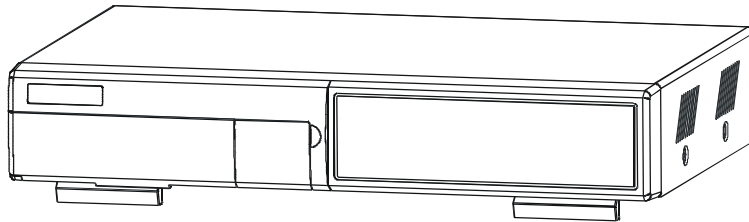

User's Manual

Please read this instructions thoroughly before operation and keep the manual in a safe place for further reference.

WARNING

*All the safety and operating instructions should be read before operation.
Improper operations may cause permanent damage.*



- This adaptor is only for this machine.
Do not use it for other electronic products or it will damage other products.
- Please lift and place this equipment gently.
- Do not expose this equipment to direct sunlight.
- Do not use this equipment near water or in contact with water.
- Do not spill liquid of any kind on the equipment.
- Please power down the unit before unplugging.
- Do not block the ventilation holes at the top and bottom of the unit.
- Do not switch the Power On & Off within short period of time
(within 3 seconds).
- Installation should be made by qualified service personnel.

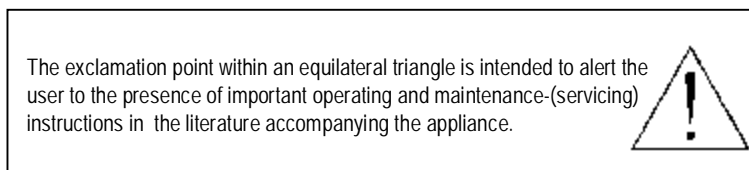
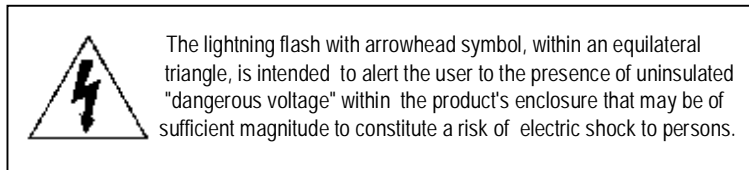

TABLE OF CONTENTS

What do you get ?

- FEATURES 1
- PACKAGE CONTENT 1

Before Operation

- INSTALLATION GUIDE 2
- FRONT PANEL 3
- REAR PANEL 5

Basic Operation

- GETTING STARTED 6
- OPERATION 6

Detailed Menu Setup

- MAIN MENU 8
- MENU OPTIONS 8

Network setting guide

- HARDWARE CONNECTION AT SERVER SITE..... 17
- STATIC IP SETTING 18
- DYNAMIC IP SETTING 22
- SOFTWARE OPERATION AT CLIENT SITE 34
- PLAYBACK OPERATION 36
- ADVANCE SETTING 37
- CONNECT VIDEO WEB SERVER VIA IE BROWSER 40

Advanced Operation

- OPERATION OPTIONS 42
- KEY LOCK 43
- TROUBLE SHOOTING 43
- SPECIFICATIONS 44
- APPENDIX #1 – INSTALL THE HDD 45
- APPENDIX #2 – REPLACE THE HDD 46
- APPENDIX #3 – PIN CONFIGURATIONS 47
- APPENDIX #4 – RECORDING SPEED 49

FEATURES

What do you get ?

DVR Features

- Remote control via internet
- Wavelet compression format replaces Time-Lapse VCR + Multiplexer / Quad
- 4 audio inputs / 2 audio outputs
- On Screen Display and Remote Control via PC
- Connect video web server via IE browser
- Auto sending message by e-mail or FTP when there have alarm.
- Auto recording when there have alarm.
- Picture-in-Picture (PIP) and Picture-on-Picture (POP) function in live, Linear Zoom (2x-4x)
- Motion detection & motion trigger recording function (16*12 detection point)
- Alarm input & output function(COM / NO / NC)
- Recording rate up to full size 30 fields/sec. or quad size 240 fields/sec.
- Multiple quick search by date/time/alarm/full/motion list
- Support IDE HDD capacity more than 400G.
- Security password protection

PACKAGE CONTENT

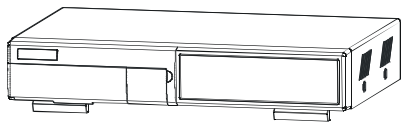

Digital Video Recorder(with HDD cartridge)



User's Manual



2 Keys



Accessories pack



Accessories pack



Power Adapter and Cord



CD-ROM

Warning:

1. Please check the package to make sure that you receive the complete accessories which includes the components shown above.
2. This adaptor is suited for DC19V 2A use. If it is damaged, users can find replacement adaptor easily in the locality with this specification.

INSTALLATION GUIDE *Before Operation*

1. Connect cameras and monitor to the DVR.
2. Shown below is an example of connecting the DVR to your existing Observation System.
3. Install HDD (The compatible HDD brands are listed in the following table.)

Please refer to page.45 Appendix #1 for installation instructions.

Note: The HDD must be installed before turning on the DVR. If HDD is not installed, the DVR would function as a 4 CH multiplexer.

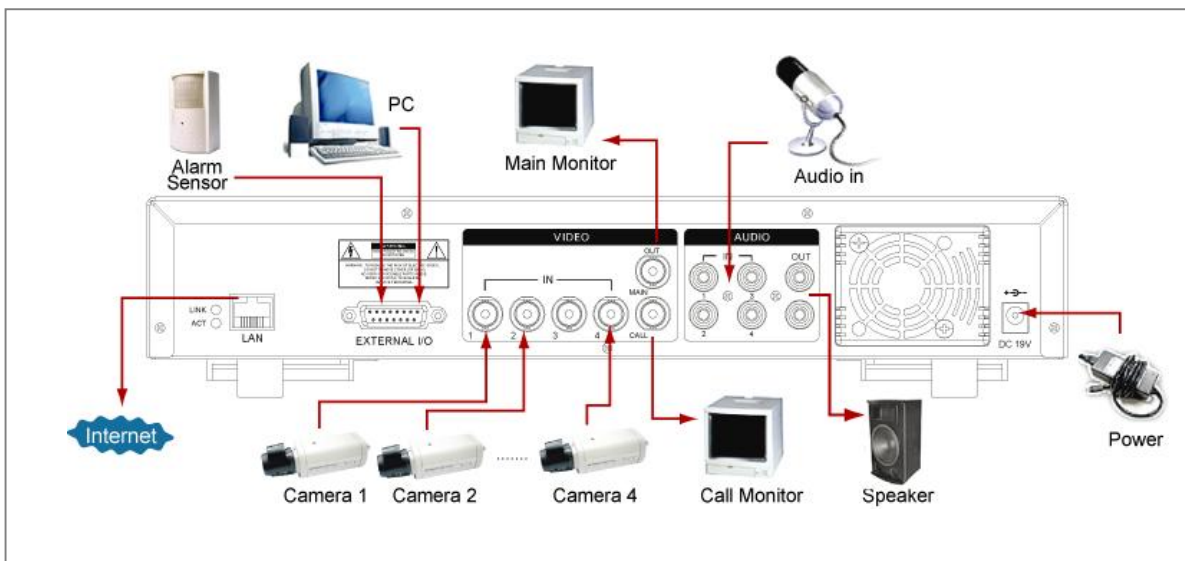





COMPATIBLE HARD DISK MODELS

Manufacturer	Model	Capacity	Rotation
HITACHI	Deskstar 180 GXP (120 GB)	120GB	7200 rpm
HITACHI	Deskstar 7K250, HDS722516VLAT20	160GB	7200 rpm
HITACHI	Deskstar 7K250, HDS722525VLAT80	250GB	7200 rpm
HITACHI	Deskstar 7K400, HDS724040KLAT80	400GB	7200 rpm
IBM	Deskstar 120GXP (80GB)	80GB	7200 rpm
IBM	Deskstar 120GXP (120GB)	120GB	7200 rpm
Maxtor	DiamondMax 536DX(60GB) 4W060H4	60GB	5400 rpm
Maxtor	DiamondMax Plus 9	80GB	7200 rpm
Maxtor	DiamondMax Plus 9, Model#6Y120L	120GB	7200 rpm
Maxtor	DiamondMax Plus 9, Model#6Y160L0	160GB	7200 rpm
Maxtor	MaxLine Plus II , Model#7Y250P0	250GB	7200 rpm
Seagate	Barracuda ATA IV, ST380021A	80GB	7200 rpm
Seagate	Barracuda ATA V, ST3120023A	120GB	7200 rpm
Seagate	Barracuda 7200.7 Plus, ST3160023A	160GB	7200 rpm
Western Digital	Caviar WD1200BB-00CAA1	120GB	7200 rpm
Western Digital	Caviar WD2000BB-00DWA0	200GB	7200 rpm

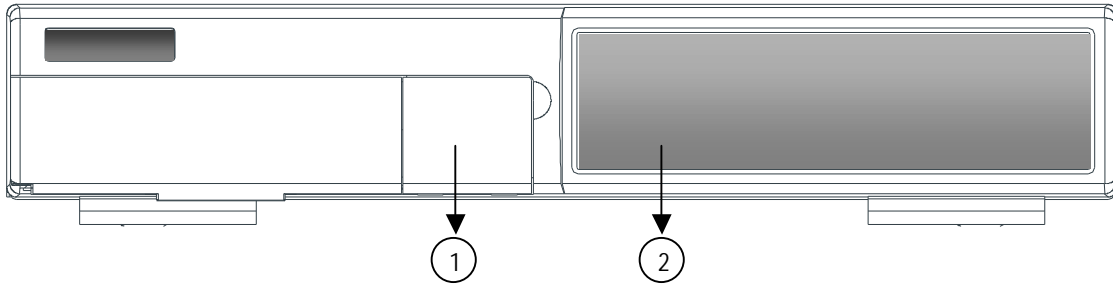
NOTE: For non-stop long-time recording, we suggest having two HDD for recording to ensure good reliability of HDD.

FRONT PANEL



1. REMOVABLE HDD CARTRIDGE & KEYHOLE	Please refer to page.44 Appendix #2.
2. CONTROL PANEL	
LED LIGHT	<p>The LED Light is ON under the following conditions.</p> <ul style="list-style-type: none"> • HDD : HDD is reading or recording. • HDD Full : HDD is full • ALARM : To turn off the ALARM LED light, please refer to page.12 and set the ALARM mode as OFF. • TIMER : When Timer is Enabled • PLAY : Playing mode • REC : Recording mode
MENU	Press MENU button to enter main menu.
ENTER	Press ENTER button for confirmation.
SEARCH	Press SEARCH button for searching recorded video.
ZOOM	Press ZOOM button to enlarge the picture display.
 / + PICTURE IN PICTURE	<p>PIP: Press “  ” button for Picture in Picture screen.</p> <p>+ : Press “+” button can change the setting in the menu.</p>
 / - 4 CHANNELS DISPLAY MODE	<p>Press ‘  ’ button for 4 CH display modes and press twice to enter POP (Picture On Picture) function.</p> <p>- : Press “-” button can change the setting in the menu.</p>
SLOW	To slow down the speed of playing mode.
POWER	Press Power to turn ON / OFF the DVR.

FF / ►	<ul style="list-style-type: none"> • FF : Play video fast forward. (Press FF button again to adjust speed as 1, 2, 4, 8, 16, 32 times) • ► : Under setup mode, it works as Right button.
REW / ◀	<ul style="list-style-type: none"> • REW : Play video fast backward. (Press REW button again to adjust speed as 1, 2, 4, 8, 16, 32 times) • ◀ : Under setup mode, it works as Left button.
STOP / ▼	<ul style="list-style-type: none"> • STOP : Under DVR Recording / Playing mode, it can stop the action. • ▼ : Under setup mode, it works as Down button.
PAUSE / ▲	<ul style="list-style-type: none"> • Pause : Under DVR playing mode, it can make the action pause. • ▲ : Under setup mode, it works as Up button.
PLAY	Press "PLAY" button to playback recorded video.
REC	Press "REC" to start recording.
CAMERA SELECT (1-4)	Press the Camera Select (1-4) to select the camera.

REAR PANEL

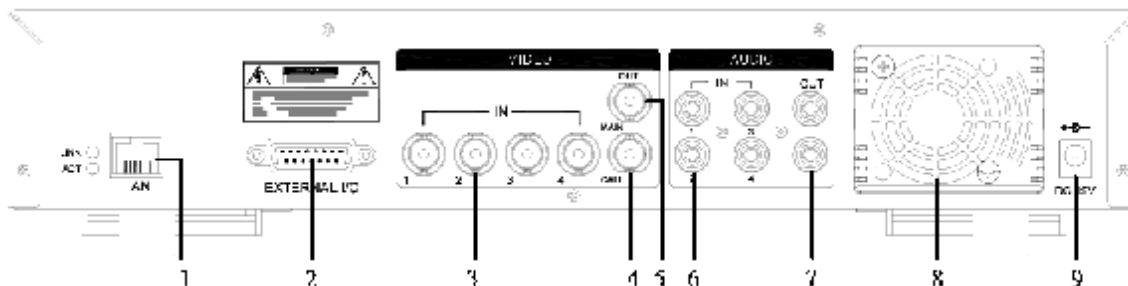

1. LAN

Connect DVR by LAN cable.

2. EXTERNAL I/O

- Controlled remotely by an external device or control system such as Video Web Server or PC.
- Alarm input, external I / O expansion.

3. VIDEO INPUT (1-4)

Connect to video source, such as camera.

4. CALL

Connect to CALL monitor. Show the Switch Display.

When the alarm is triggered, the call monitor will show the triggered channel for a period of time.

5. MAIN

Connect to Main monitor.

6. AUDIO IN (1-4)

Connect to audio sources, such as a microphone.

- IPS should be set to 30 (for NTSC) or 25 (for PAL)
- * 4 audio inputs, but can only record one input at the same time.

7. AUDIO OUT

Connect to monitor or speaker.

- IPS should be set to 30 (for NTSC) or 25 (for PAL)
- * with 2 mono audio outputs from the same source.

8. FAN

For ventilation, do not block the opening.

9. POWER

Please use the provided power cord.

Warning:

1. This adaptor is only for this machine. Do not use it for other electronic product or it will damage other products.
2. This adaptor is suited for DC19V 2A use if it is damaged, user can find replacement adaptor easily in the locality with this specification.

GETTING STARTED **Basic Operation**

Before using the DVR, please have a HDD installed ready, or it will function as 4 CH multiplexer (refer to Appendix #1 and Appendix #2 for installation or removal of a HDD).

1. Connect the AC power cord and plug into an electrical outlet. The Red LED indicator light will be ON and the DVR is in standby mode.
2. Press the Power button. The POWER LED will turn from red to orange, and other red LED indicators will turn ON. It takes approximately 5 to 15 seconds to boot the system with the message : " HDD Detecting ". Once connected, the POWER LED will change to green color, and the Alarm LED will be ON.
3. Before operating the DVR, sets the system time first. (refer to page.9).

NOTE : 1.If the HDD is not installed correctly or not installed, the "HDD not found" message will appear for 3 seconds and then return to 4 CH Multiplexer display mode.

2.To switch the system, you need to turn off the power and pull out the AC power cord before reconnecting the power. And after pressing "POWER" + "FF" to NTSC system or "POWER" + "REW" to PAL system and reconnect the AC power cord, the system of the DVR will be switched.

OPERATION

RECORDING

The DVR offers 4 recording modes, variety of recording modes. Refer to p.11 for advanced setting of recording speed and resolution. Under the recording status, if power is off accidentally, the recorded video will still be stored in the HDD. And the DVR will return to original recording setting after the power restores again.

On the screen, you will find the date, time, HDD recording type, the available space of HDD (in GB) left and the symbol "  " represents the recording mode.

NOTE : 1. Under O/W recording mode, previously recorded files will be automatically overwritten without further warning notices, when the HDD is full.

2. If the HDD capacity is only 5 GB left, it will display "5 GB" on the up-right screen and shows orange color, and it will buzz for seconds; so as in 4GB, 3GB, 2GB and 1GB. If the O/W Recording mode (NOTE 1) is on, it won't have the warning buzzer.

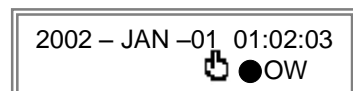

(OW : HDD Overwrite)

There are 4 recording modes: Alarm, Motion, Timer and Manual Recording.

1. ALARM RECORDING

DVR is triggered by an alarm input.  symbol will be shown on the triggered channel. (refer to page12)

2. MOTION TRIGGER RECORDING

Recording is triggered by motion detection.  symbol will be shown on the triggered channel. (refer to page13)

3. TIMER RECORDING

Recording is scheduled by a Timer. It will indicate by the symbol . (refer to page9)

4. MANUAL RECORDING

Recording is initiated manually by pressing the REC button. Symbol  will be shown.

PLAY BACK

Press "PLAY" button, the DVR will show the last recording.

1. FAST FORWARD (F.F.) & FAST REWIND (F.R.)

You can increase the speed of Fast Forward and Rewind on the DVR.

In the Play mode, press "▶" once to get 2X speed forward and press twice to get 4X speed,... and the maximum speed can reach 32X.

Press "◀" once to get 1X speed rewind and press twice to get 2X speed, ... and the maximum speed can reach 32X.

2. SLOW FORWARD (S.F.) & SLOW REWIND (S.R.)

You can also slow down the speed of Forward and Rewind on the DVR.

In the Play mode, press the SLOW button and you will enter Slow mode.

Press "SLOW" once to get 1/2X speed forward and press "▶" to get 1/4X speed,... and the slowest speed can reach 1/32X.

Press "◀" once to get 1/2X speed rewind and press twice to get 1/4X speed, ... and the slowest speed can reach 1/32X.

3. PAUSE

You can make the playback pause and the image will be displayed on the screen.

4. STOP

Press "STOP" button under any circumstance, the DVR will return to live monitoring mode.

5. IMAGE JOG DIAL

It will allow you to manually view video frame-by-frame, one image at a time.

While in PLAY mode, press "PAUSE", and the screen will pause.

Press "▶" button advances the frozen screen one image forward.

Press "◀" button moves back one image.

Note: During the LIVE or PLAY mode, press "ENTER" + "SEARCH" buttons at the same time to switch the "NORMAL" and "SHARPNESS" display.

6. SHARPNESS

When in play mode, press "ENTER + SEARCH" to switch the sharpness(normal or sharpness)

CAMERA SELECT (1-4)

Press Camera Select (1-4) to select the camera to display in full screen.

MAIN MENU **Detailed Menu Setup**

There are 12 options available in the Main Menu:

- TIMER ----- Program Timer Recording
- CAMERA ----- Camera Setup
- RECORD ----- Recording Mode Setup
- ALARM ----- Alarm Setup
- DWELL ----- Dwell time Setup
- PIP ----- Picture in Picture Setup
- MOTION ----- Motion Detection Setup
- DISPLAY ----- Display Mode Setup
- NETWORK ----- Network Setup
- USER ----- User Password Setup
- SYSTEM ----- System Setup
- EVENT ----- Event List

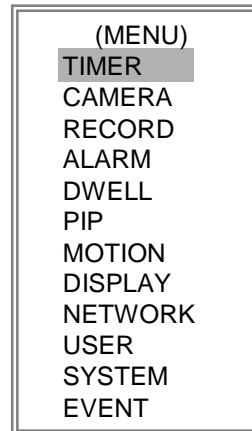

Outlined below are the buttons used for Menu setting :

- “▲” and “▼” : Scroll up and down within a menu option.
- “◀” and “▶” : Scroll sideways within a menu option that has been selected.
- “+” and “-” : Increase and decrease the number or change values when an option is selected and is blinking.
- ENTER : Select a submenu / an option under a submenu for browsing / modification.
- MENU : Complete modification of a menu option; exit a menu.

MENU OPTIONS

SYSTEM

1. AUDIO INPUT

To choose one of 4 channels to record. (It can only record 1 input at the same time)

2. BUZZER

Set the BUZZER “ON”, it will buzzer by event occurrence when the setting is ON.

3. EXT ALARM

To set the EXT ALARM. It will be triggered by event occurrence when the setting is ON.

4. VLOSS ALARM

To set the VLOSS ALARM. When the setting is “ON”, the alarm will start by the setting of Buzzer, EXT alarm or Alarm Duration.

5. MOTION ALARM

To set the MOTION ALARM. When the setting is “ON”, the alarm will start by the setting of Buzzer, EXT alarm or Alarm Duration.

6. KEY MUTE

To set the KEY MUTE. When the setting is “YES”, there will be no sound when you press any key.

7. HDD OVERWRITE

To set the HDD OVERWRITE. When the HDD is full under O/W recording mode, previously recorded files will be overwritten without further warning notices if the HDD OVERWRITE is ON.

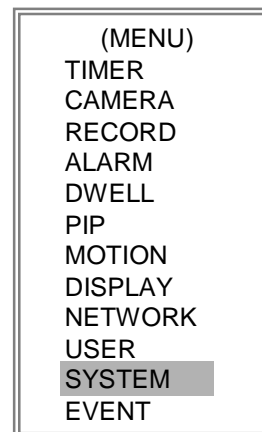

8. MESSAGE LATCH

To select whether the DVR messages will disappear after 10 seconds or remain on screen. NO is the default setting which the messages will disappear after 10 sec.

NOTE : Video loss, Alarm and Motion messages will be shown like the Alarm Duration time.

9. DATE DISPLAY

To set the date Y/M/D, M/D/Y, D/M/Y or OFF on the monitor.

10. DATE

To set the date on the DVR.

11. TIME

To set the time on the DVR.

12. CLEAR HDD

Delete all the contents of the HDD. When you choose "YES" on this option, press "ENTER" and you will be prompted with the question shown: Press "→" to clear HDD or press "←" to cancel.

13. SYSTEM RESET

Reset all system settings back to factory default settings. Select "YES" and press "ENTER" button.

(SYSTEM)	
AUDIO INPUT	1
BUZZER	ON
EXT ALARM	ON
VLOSS ALARM	ON
MOTION ALARM	ON
KEY MUTE	YES
HDD OVERWRITE	YES
MESSAGE LATCH	YES
DATE DISPLAY	D/M/Y
DATE	26-DEC-2003 [FRI]
TIME	22:55:34
CLEAR HDD	YES
SYSTEM RESET	YES

TIMER

1. DAY

Select the day, or days of the week (Mon–Fri / Sat-Sun / Daily) that you wish to schedule the DVR to automatically record.

NOTE :

1. Date could be changed by "+" and "-" buttons.
2. If you have selected the date and Timer recording set from that specific day to a new day, then the Timer Recording Schedule will be set as whole week.
For specific date of Timer Recording Schedule, it is not recommended to set Ending Time over 23:59. For example: If you set Timer Schedule Day as Sunday, and START from 11:30, but End on 00:20, then Recording Timer Schedule is set as from every Sunday's 11:30 to next Sunday's 00:20. If you only want to set Recording Timer Schedule from every Sunday 11:30 to Monday 00:20, then you should set Recording Timer Schedule as Sunday from 11:30 to 23:59, and Monday from 00:00 to 00:20.
3. It is not suggested that users press "STOP" button or restart the system during setting time. In doing so, the recording will stop, and users can resume recording by pressing "ENTER" + "MENU".

2. START

Set the time to start the recording.

3. END

Set the time to end the recording.

4. IPS (IMAGE PER SECOND)

NTSC—30、15、8、4、2、1

PAL—25、12、6、3、2、1

5. QUALITY

Select the quality of recording image: BEST, HIGH, NORM and BASIC.

6. MODE

There are three recording mode settings :

QUAD-FRAME, QUAD-FIELD, MULTIPLEX.

NOTE: To select the appropriate recording mode before you start recording. We don't suggest users to change the different recording mode during recording to ensure the best recording quality.

7. TIMER ENABLE

When TIMER ENABLE is "YES", press "menu" button, and you can see the timer diagram according to your setting.

(TIMER)						
DAY	START	END	IPS	QLT	MODE	
DAILY	01:00	22:00	30	BEST	Q-FR	
OFF	00:00	00:00	30	BEST	Q-FI	
OFF	00:00	00:00	30	BEST	Q-FI	
OFF	00:00	00:00	30	BEST	Q-FR	
OFF	00:00	00:00	30	BEST	Q-FR	
OFF	00:00	00:00	30	BEST	Q-FR	
OFF	00:00	00:00	30	BEST	MUX	
OFF	00:00	00:00	30	BEST	Q-FI	
TIMER ENABLE : YES						

1ST	00--05	06--11	12--17	18--23
MON	☐☐☐☐☐☐	☐☐☐☐☐☐	☐☐☐☐☐☐	☐☐☐☐☐☐
TUE	☐☐☐☐☐☐	☐☐☐☐☐☐	☐☐☐☐☐☐	☐☐☐☐☐☐
WED	☐☐☐☐☐☐	☐☐☐☐☐☐	☐☐☐☐☐☐	☐☐☐☐☐☐
THU	☐☐☐☐☐☐	☐☐☐☐☐☐	☐☐☐☐☐☐	☐☐☐☐☐☐
FRI	☐☐☐☐☐☐	☐☐☐☐☐☐	☐☐☐☐☐☐	☐☐☐☐☐☐
SAT	☐☐☐☐☐☐	☐☐☐☐☐☐	☐☐☐☐☐☐	☐☐☐☐☐☐
SUN	☐☐☐☐☐☐	☐☐☐☐☐☐	☐☐☐☐☐☐	☐☐☐☐☐☐
2ND	00--05	06--11	12--17	18--23
MON	☐☐☐☐☐☐	☐☐☐☐☐☐	☐☐☐☐☐☐	☐☐☐☐☐☐
TUE	☐☐☐☐☐☐	☐☐☐☐☐☐	☐☐☐☐☐☐	☐☐☐☐☐☐
WED	☐☐☐☐☐☐	☐☐☐☐☐☐	☐☐☐☐☐☐	☐☐☐☐☐☐
THU	☐☐☐☐☐☐	☐☐☐☐☐☐	☐☐☐☐☐☐	☐☐☐☐☐☐
FRI	☐☐☐☐☐☐	☐☐☐☐☐☐	☐☐☐☐☐☐	☐☐☐☐☐☐
SAT	☐☐☐☐☐☐	☐☐☐☐☐☐	☐☐☐☐☐☐	☐☐☐☐☐☐
SUN	☐☐☐☐☐☐	☐☐☐☐☐☐	☐☐☐☐☐☐	☐☐☐☐☐☐

CAMERA

1. TITLE

Assign a title to each camera. Initially each title is the camera's number.

2. ALARM

Select LOW / OFF / HIGH for alarm polarity. The default value is LOW.

TITLE	ALARM	(CAMERA)				
		REC	BR	CT	CL	HUE
CAMERA01	LOW	ON	18	15	15	18
CAMERA02	OFF	OFF	18	15	15	18
CAMERA03	HIGH	OFF	18	15	15	18
CAMERA04	HIGH	ON	18	15	15	18

3. REC (RECORD)

Set up which channel you want to record.

ON : when alarm input is triggered, DVR will record alarming channel more frequently.

For example : when CH01 is triggered, the record method will become 1-2-1-3-1-4....

OFF : DVR will not record.

4. BR (BRIGHTNESS)

Adjust the brightness of each channel. The level is from 0 to 63.

5. CT (CONTRAST)

Adjust the contrast of each channel. The level is from 0 to 63.

6. CL (COLOR)

Adjust the color of each channel. The level is from 0 to 63.

7. HUE (HUE)

Adjust the hue of each channel. The level is from 0 to 63.

RECORD

1. RECORD IPS

Select the recording speed. The options are as following :

NTSC— 30、15、8、4、2、1

PAL— 25、12、6、3、2、1

(RECORD)	
RECORD IPS	30
QUALITY	NORMAL
RECORD MODE	QUAD-FRAME

2. QUALITY

There are four quality settings : BASIC, BEST, HIGH, NORMAL.

NOTE : Please refer to page.49 APPENDIX #4 recording speed for the relationship of recording time, IPS and recording quality.

3. RECORD MODE

There are three recording settings : QUAD-FRAME, QUAD-FIELD, MULTIPLEX.

NOTE: To select the appropriate recording mode before you start recording. We don't suggest to change the different recording mode during the recording to ensure the best recording quality.

ALARM

1. ALARM ENABLE

Alarm will be triggered by event occurrence when the setting is YES.

2. ALARM DURATION

Set the reaction time which was determined by how long the alarm mode responded to a buzzer. Default setting is 10 sec. Options are 10 Sec, 15 Sec, 20 Sec, 30 Sec, 1 MIN, 2 MIN, 3 MIN, 5 MIN, 10 MIN, 15 MIN, 30 MIN, ALWAYS, AUTO.

- NOTE :
1. Video loss, Alarm and Motion messages is shown like the Alarm Duration time is.
 2. When the setting is AUTO, the alarm duration time is based on the setting of the external alarm device.
 3. During ALARM DURATION'S setting time, users can restart ALARM/MOTION function by pressing both "ENTER" + "STOP" buttons.

3. REC IPS

Select the images per second of recording during an ALARM.
The options are as following:

NTSC—30、15、8、4、2、1

PAL—25、12、6、3、2、1

4. QUALITY

There are four quality settings during an alarm.
ALARM : BASIC, BEST, HIGH, NORMAL.

5. RECORD MODE

There are three recording settings : QUAD-FRAME, QUAD-FIELD, MULTIPLEX.

(ALARM)	
ALARM ENABLE	YES
ALARM DURATION	15 MIN
RECORD IPS	30
QUALITY	NORMAL
RECORD MODE	QUAD-FRAME

DWELL

1. NORM

To set up the DWELL time period that each channel auto sequentially shows on call monitor. The level is from 1 to 15 Sec or OFF.

2. ALARM

To set up the DWELL time period when alarm input is triggered.
The level is from 1 to 15 Sec or OFF.

(DWELL)		
	NORM	ALARM
CAM1	01	01
CAM2	01	01
CAM3	01	01
CAM4	01	01

PIP

1. FULL SCREEN

To set up the full screen background picture display.

2. PIP SCREEN

To set up the picture with a 1/9 size screen "insert".

3. POSITION

There are six position settings : D/L, D/M, D/R, U/L, U/M, U/R.

(PIP)	
FULL SCREEN	CAM 1
PIP SCREEN	CAM 2
POSITION	D/R

MOTION

(MOTION)					
	SEN	MD-NUM	RE	DET	
CAM1	70	03	64	ON	AREA
CAM2	70	03	64	OFF	AREA
CAM3	70	03	64	ON	AREA
CAM4	70	03	64	ON	AREA
MOTION RECORD : ON					
	DAY	START	END		
	DAILY	00 : 00	00 : 00		

1. SEN (SENSITIVITY)

Sets the sensitivity of the pixel-based Motion Detection feature from 1 to 99.
The highest sensitivity setting is 01, the lowest sensitivity setting is 99.
The default setting is 70.

2. MD-NUM (MOTION DETECTION NUMBER)

Sets the number of targets of the motion detection to occur in order to trigger an Alarm (from 1-99 target areas).
Note: MD-NUM cannot be less than the number of targets set in the AREA.

3. RE (REFERENCE)

Set the Reference image to which the current screen is compared (from 1-99).
For example, the value 64 would compare the current image to the 64th previous screen image. The higher value may increase the sensitivity.

4. DET (DETECTION)

The motion detection on each channel can be turned to be
ON or OFF individually.

5. AREA

Press the ENTER button on this option to set the Pixel-based Motion Detection Area for each channel. Red targets represent where the target is (Figure 1-1). Green targets represent the Motion Detection Area (Figure 1-2), and Purple targets represent motion currently taking place (Figure 1-3). After stopping the detection, the color of target will be green (Figure 1-4).

To modify the Motion Detection Area, use the following controls:
ZOOM: turn the selected target ON/OFF.

▲▼◀▶ : navigates between targets

- : turns all targets on the screen ON/OFF

+ : turn all targets in the selected row ON/OFF

Note: When the "DET" (DETECTION) setting is "ON", you must set the motion detection area or it won't be triggered.

Figure 1-1

MOTION DETECTION SETUP

	1	2	3	4	5	6	7	8	9	10	11	12	13	14	15	16
1																
2																
3																
4																
5						■										
6																
7																
8																
9																
11																
12																

Figure 1-2

MOTION DETECTION SETTING — ROW SETUP

	1	2	3	4	5	6	7	8	9	10	11	12	13	14	15	16
1																
2					■	■	■									
3					■	■	■									
4																
5	■	■	■	■	■	■	■	■	■	■	■	■	■	■	■	■
6																
7																
8																
9																
11																
12																

Figure 1-3

MOTION DETECTION TRIGGERED-TURN INTO PURPLE

	1	2	3	4	5	6	7	8	9	10	11	12	13	14	15	16
1																
2						■	■	■								
3						■	■	■								
4						■	■	■								
5	■	■	■	■	■	■	■	■	■	■	■	■	■	■	■	■
6																
7																
8																
9																
11																
12																

Figure 1-4

BACK TO MOTION DETECTION SETTING



	1	2	3	4	5	6	7	8	9	10	11	12	13	14	15	16
1																
2						■	■	■								
3						■	■	■								
4																
5	■	■	■	■	■	■	■	■	■	■	■	■	■	■	■	■
6																
7																
8																
9																
11																
12																

6. MOTION RECORD

When the DET setting is “ON”, you can set up the MOTION RECORD function,

1. Select “ON” to set up the motion trigger recording: It can automatically switch to Record Mode. The motion detection will change the scanning sequence and show  on the monitor.

NOTE: The triggered recording time is based on ALARM DURATION mode setting (Please refer to page.12 for ALARM DURATION) and it will record from the last triggered time. For example, when the alarm duration setting is 1 min, the recording time is from 9:00:00 to 9:01:00. If the motion detection is triggered again at 9:00:40, the triggered recording time will be from 9:00:00 to 9:00:40 and 9:00:40 to 9:01:40. The total recording time is 00:01:40.

For example : If the motion is detected on Camera #1, its recording & scanning sequence will be more frequently. The sequence will be as 1st, 2nd, 1st, 3rd, 1st, ... 4th. And channel 1 will show  on the screen. If the motion detection of 2nd camera and 3rd camera are both activated, they will be scanning as 2nd, 3rd, 1st, 2nd, 3rd, 4th, 2nd, 3rd, 1st, 2nd, 3rd, 4th ... and vice versa. And CH2 & CH3 will show  for a period of time which is just like the Alarm Duration time.

2. Select “OFF”: The screen still shows  and if it is in recording mode, the motion detection will change the scanning sequence.

7. DAY / START / END

To setup the DAY and the START/ END time for motion trigger recording timer setting.

DISPLAY

1. TITLE DISPLAY

To set the title shown on monitor or not.

2. OSD COLOR

Select the OSD (On Screen Display) color. The options are YELLOW, GREEN, CYAN, BLUE, PINK, GRAY, WHITE, RED.

3. LOSS SCREEN

Retain the last picture or select the LOSS SCREEN color.

The options are GREEN, BLACK, BLUE and RETAIN.

4. TIME POSITION

To set the OSD POSITION shown on monitor.

The options are NORMAL or CENTER.

(DISPLAY)	
TITLE DISPLAY	YES
OSD COLOR	YELLOW
LOSS SCREEN	GREEN
TIME POSITION	NORMAL

NETWORK

1. SERVER IP

To set the the IP address

2. GATEWAY

To set the gateway

3. NET MASK

To set the net mask

4. DNS

To set the DNS

5. WEB PORT

To set the web port

6. RESET DEFAULT

Go back to default setting YES/NO

(NETWORK)	
SERVER IP	061.062.147.111
GATEWAY	061.062.147.254
NET MASK	255.255.255.000
DNS	168.095.001.001
WEB PORT	00080
RESET DEFAULT	NO

USER

1. USER

To set up the user account for controlling. It allows 8 users setting.

Supervisor – Control all the functions.

Other Users – View all functions except the menu setting and event list cleaning.

2. PASSWORD

To set the security password for each account. The maximum length of user's password is 4 characters.

NOTE: To switch to different USER, press "ENTER" + "MENU" buttons to "KEY LOCK" and then enter the different user's password to UNLOCK.

(USER)	
PASSWORD	
SUPERVISOR	0000
USER 1	0000
USER 2	0000
USER 3	0000
USER 4	0000
USER 5	0000
USER 6	0000
USER 7	0000

EVENT

A single page can display 16 recorded events. Press "◀" or "▶" to change the pages or press "▲" + "▼" to CLEAR the EVENT record.

DISK FULL: HDD is full

PWR REST : Power restored

M-HD REMS: HDD remove

M-HD REPL: HDD replace

M-HD ERR : HDD error

M-HD WARM: HDD warming

K UNLOCKS: Key unlock

DMA ERROR: DMA error

C1 VLOSS : The video of Channel 1 is lost

C2 ALARM : Channel 2 has been triggered by external I/O alarm

C3 MOTION: Channel 3 has been triggered by motion detection

SYSTEM ERROR: System might fail

POWER RESTORE : Power restored

C1 VLOSS	26-DEC-2002	03:00:00
C2 ALARM	26-DEC-2002	03:00:00
K UNLOCKS	26-DEC-2002	03:00:00
M-HD ERR	26-DEC-2002	03:00:00
M-HD WARM	26-DEC-2002	03:00:00
PWR REST	26-DEC-2002	03:00:00
DMA ERROR	26-DEC-2002	03:00:00
M-HD REPL	26-DEC-2002	03:00:00
↑ + ↓ : CLEAR		

Direct connect with PC.



Remote Control Via Internet



STATIC IP SETTING

STEP1: Software installation

1. Put the attached CD into a CD-ROM and it will start to install the application program into PC.
2. Press "Next".

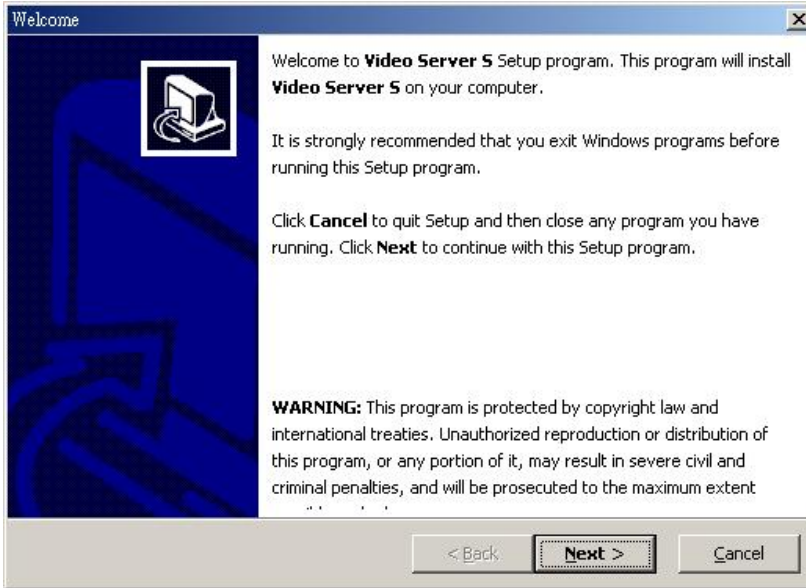

3. Choose destination location and press "Next".

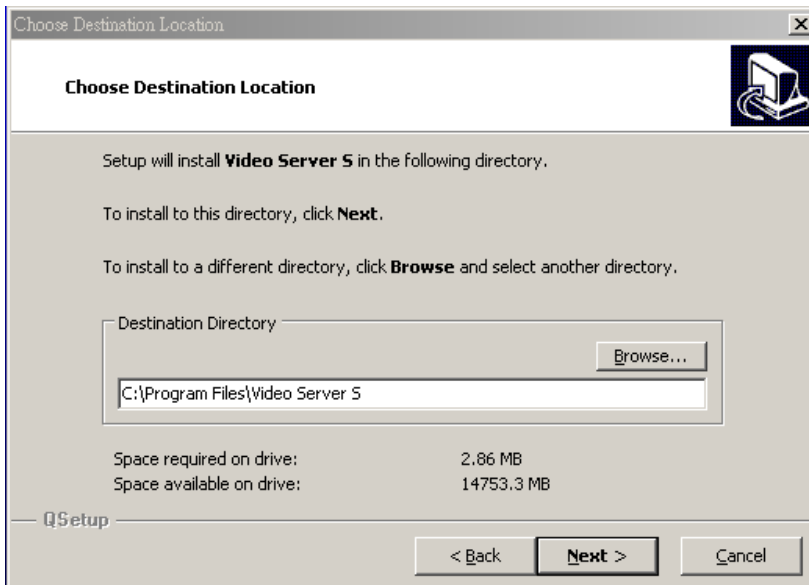

4. Set program shortcuts setting and press "Next".

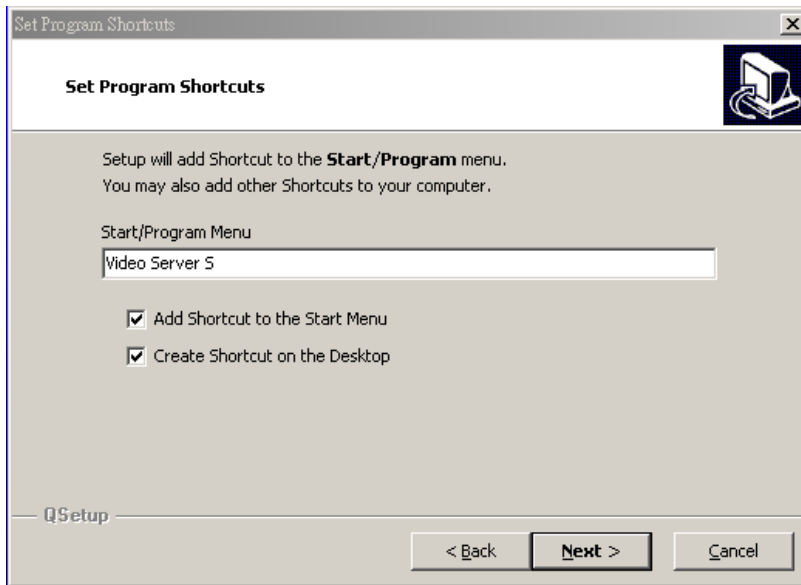

5. Press "Next" to begin to copy files

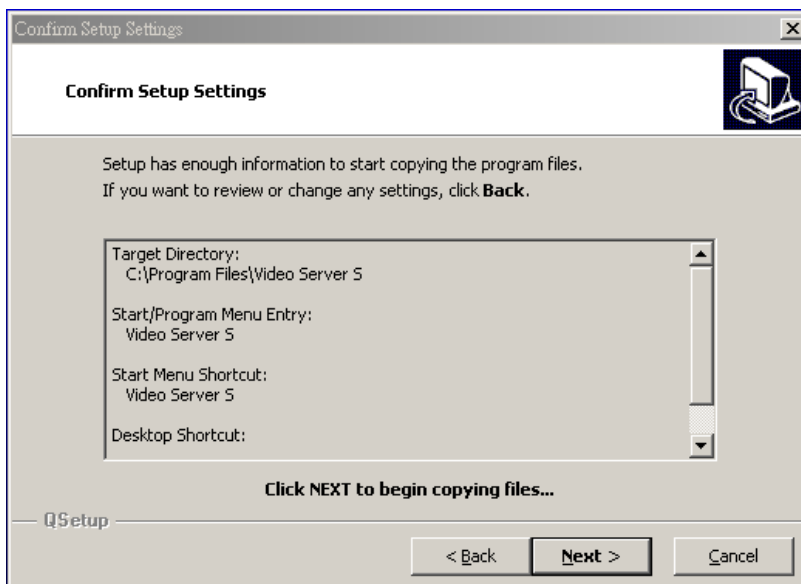

6. After the installation, there are 6 files and 1 folder in your assigned path (file folder) as below.



Step2 : Static IP setting

In DVR MENU / NETWORK set SERVER IP, GATEWAY, NET MASK, DNS and WEB PORT which are provided from your local ISP (internet service provider).

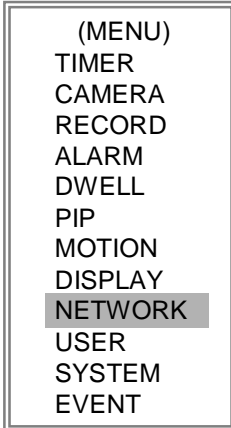

For example

(NETWORK)	
SERVER IP	061.066.138.074
GATEWAY	061.066.138.073
NET MASK	255.255.255.000
DNS	168.095.001.001
WEB PORT	00080
RESET DEFAULT	NO

After all network settings are finished, please connect DVR and static IP.

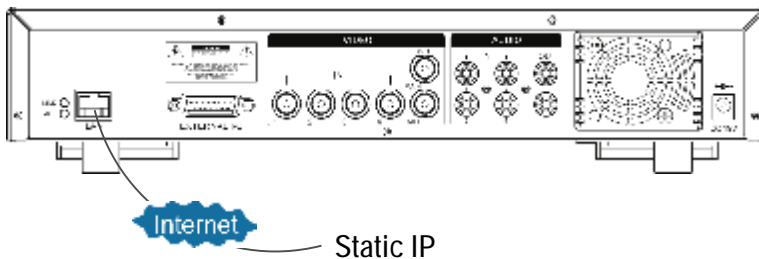

Step3 : Connect PC and DVR via internet

Click  twice and enter your User name, Password (Note : If you never change the "Account" before, the User Name and Password are both "admin") and Server IP which you have set to DVR in step 2. Then click OK to connect.



The image shows a dialog box titled "VIDEO WEB SERVER". It contains the following fields and buttons:

- UserName :** admin
- Password :** *****
- Server_IP :** 61.66.138.74
- Web Port :** 80
- Adress Book** (button)
- OK** (button)
- SEARCH** (button)
- CANCEL** (button)

A red rectangular box highlights the UserName, Password, and Server_IP fields.

DYNAMIC IP SETTING

Step1 : Software installation

- 1.Put the attached CD into a CD-ROM and it will start to install the application program into PC.
2. Press “Next”.



- 3.Choose destination location and press “Next”.

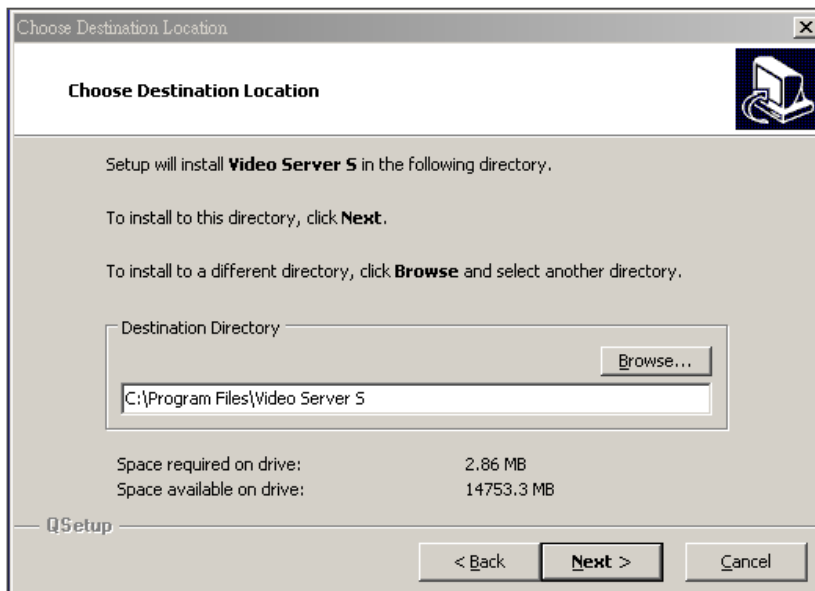

4. Set program shortcuts setting and press "Next".

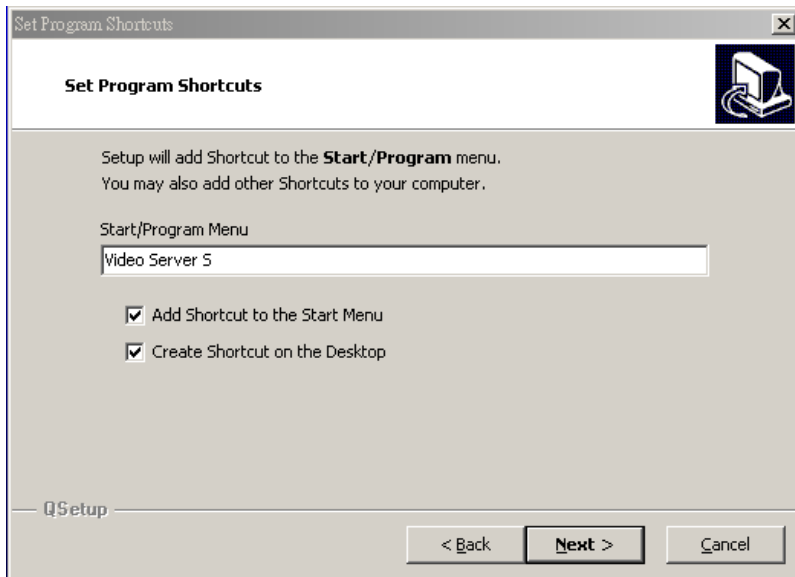

5. Press "Next" to begin copying files

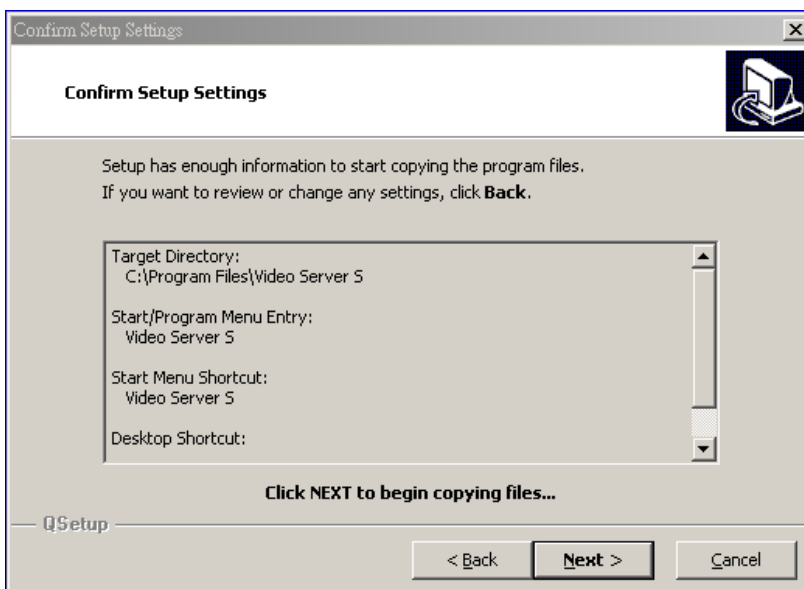

6. After the installation, there are 6 files and 1 folder in your assigned path (file folder) as below.



Step2 : DDNS apply

1. Click on free site "<http://www.dyndns.org>" (please look at the example below, you can also apply DDNS in other DDNS web page) and "ACCOUNT"

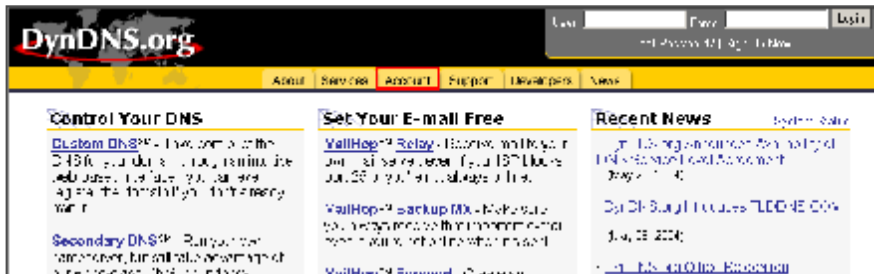

2. Press "Create Account"

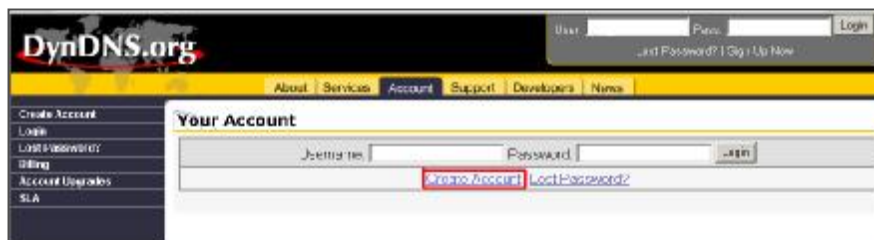

3. Register the information and click on “Create Account”

The screenshot shows the DynDNS.org website's registration page. At the top, there is a navigation bar with links for 'About', 'Services', 'Account', 'Support', 'Developers', and 'News'. Below this is a sidebar with links for 'Create Account', 'Login', 'Lost Password?', 'Billing', 'Account Operations', and 'FAQ'. The main content area is titled 'Create Account' and contains the following text: 'Please complete the form below to create your account. You will receive an e-mail containing instructions to activate your account. If you do not follow these directions within 48 hours, you will need to re-create your account.' Below this, there is a security warning: 'It is strongly recommended that you visit this page [securely](#). You are not currently visiting this page securely.' A scrollable box contains the 'ACCEPTABLE USE POLICY' text, which states that services are provided under specific terms and conditions. Below the policy, there is a checkbox labeled 'I have read and agree to the Acceptable Use Policy above:' which is currently unchecked. The form then asks for 'Username' (with a note that it will be used for logging in and making changes), 'E-mail Address' (with a note that it will be used for activation and that accounts with invalid addresses will be removed), and 'Password' (with a note that it must be more than 5 characters and cannot be the username). Each of these fields has an empty input box. At the bottom of the form are two buttons: 'Create Account' and 'Reset Form'.

4. After registering your account, you will receive an e-mail, which contains instructions to activate your account. If you do not follow these directions within 48 hours, you will need to re-register your account.

5. Login your account.

The screenshot shows the DynDNS.org website's login page. At the top, there is a navigation bar with links for 'About', 'Services', 'Account', 'Support', 'Developers', and 'News'. Below this is a sidebar with links for 'Create Account', 'Login', 'Lost Password?', 'Billing', 'Account Operations', and 'FAQ'. The main content area is titled 'Login' and contains the following text: 'Please enter your username and password to log in to your account.' Below this text are two input fields: 'Username' and 'Password'. To the right of the 'Password' field is a 'Login' button. Below the input fields is a link for 'Lost Password?'. At the bottom of the page are two buttons: 'Create Account' and 'Reset Form'.

6. Click on "Account" and "Add Host"



7 Users can set up their own DDNS HOST. For example, the user's applied Host name is "avtech.dyndns.org". And then press "Add Host" to finish the setting.

(NOTE : Some routers don't support some DDNS HOST)



Step3 : Login router

NOTE : The following settings are different from router to router. Please read the instruction of your router thoroughly.

1. Connect PC and router (LAN end)

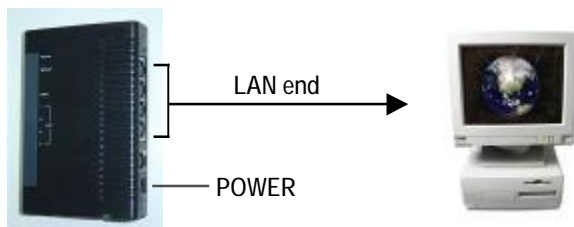

2. Network setting for PC. (The instruction is based on Win XP O/S. If your O/S is Win 2000 or Win 2003, the setup procedure is similar to that of Win XP O/S.)



3. Click "Properties" for TCP/IP setup

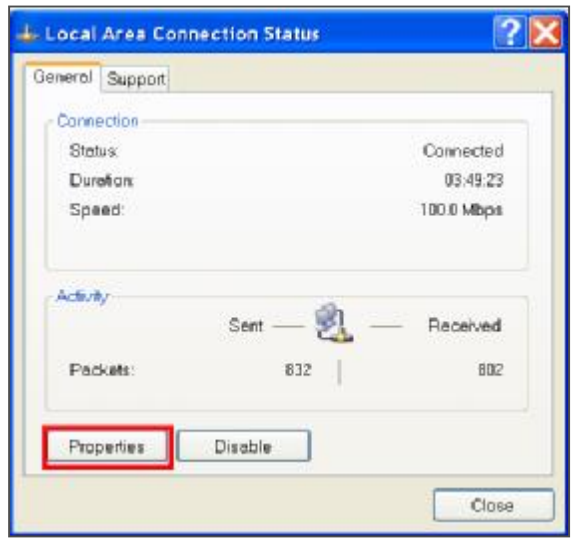

4. Click on “INTERNET PROTOCOL (TCP/IP)” and then select “Properties” to setup

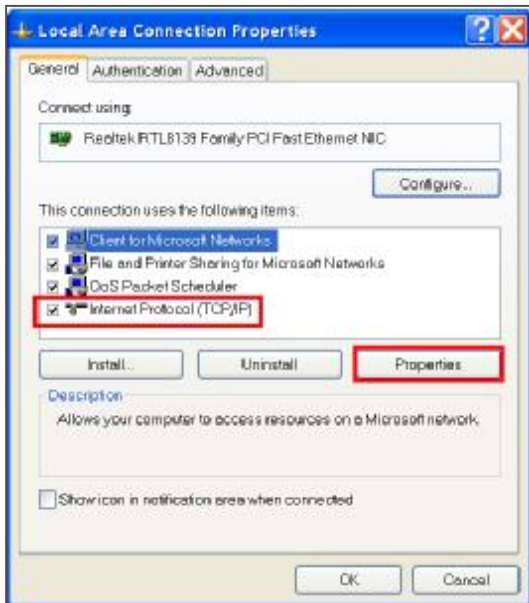

5. Choose “Obtain an IP address automatically”

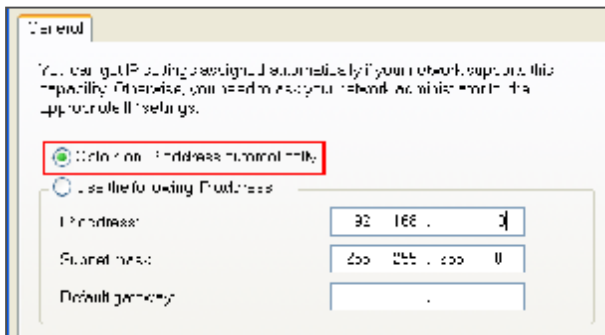

6. Enter “Command Prompt”



7. In the setting window, enter “ ipconfig” to write down router’s gateway(e.q. 192.168.1.1)

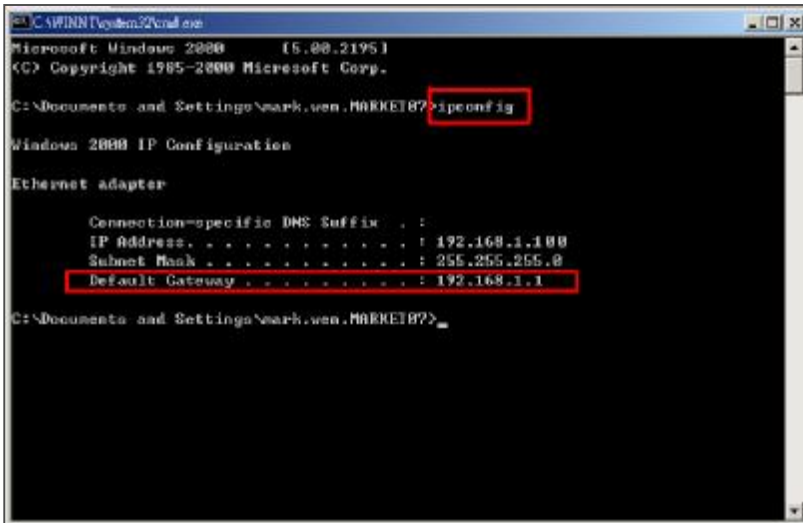

```
C:\WINNT\system32\cmd.exe
Microsoft Windows [Version 5.00.2195]
(C) Copyright 1985-2000 Microsoft Corp.

C:\Documents and Settings\mark.wen.HARRETB7>ipconfig

Windows 2000 IP Configuration

Ethernet adapter

    Connection-specific DNS Suffix . :
    IP Address. . . . . : 192.168.1.100
    Subnet Mask . . . . . : 255.255.255.0
    Default Gateway . . . . . : 192.168.1.1

C:\Documents and Settings\mark.wen.HARRETB7>
```

8. Close the window in the above step. Enter the IP address (router’s gateway : 192.168.1.1) to log in to the router from internet explore. And then enter the login web page and key in the **router’s user name and password**.



IP 192.168.1.1

User Name

Password

OK Cancel

Step4 : Router setting

NOTE : In the router setting, we have four steps as follows.

1. Dial setting
2. DHCP setting
3. Virtual server setting
4. DDNS setting

1. Press "INTERNET PORT" and choose your WAN type (e.q. PPPoE), and then enter your "User Name" and "Password" of dialing up to dynamic IP. Press save after you finish the set up.

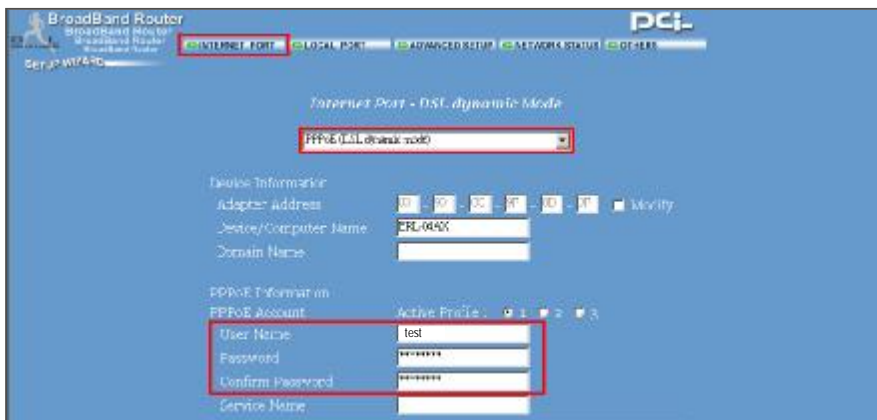

2. Press "LOCAL PORT" and set "Start IP address" and "Number of IP address". (For example, if the IP address of DVR is 192.168.1.10, then 10 is excluded from the setting range) Press save after you finish setting up.



3. In “ADVANCED SETUP / Virtual Server”. Choose “By Port” and set “Port Number” to 80 for DVR. And set “Local Server IP Address” to 192.168.1.10. Press add after you finish the set up.



4. In “ADVANCED SETUP / Dynamic DNS”. Key in the “DNS Account”, “User Name” and “Password” that you applied in step 3. Press save after you finish the set up.



Step 5 : IP setting

In DVR MENU / NETWORK set SERVER IP, GATEWAY, NET MASK, DNS and WEB PORT.

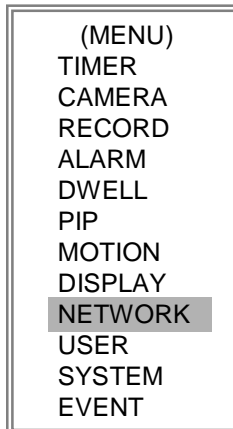

For example

(NETWORK)	
SERVER IP	192.168.001.010
GATEWAY	192.168.001.001
NET MASK	255.255.255.000
DNS	168.095.001.001
WEB PORT	00080
RESET DEFAULT	NO

Step6 : Connect router



Step7 : Connect to DVR via internet

1. Change PC network setting to the original setting and link PC to the internet.
2. Click  twice and enter your User name, Password and host (Note : If you never change the “Account” before, the User Name and Password are both “admin”). Then click OK to connect.)

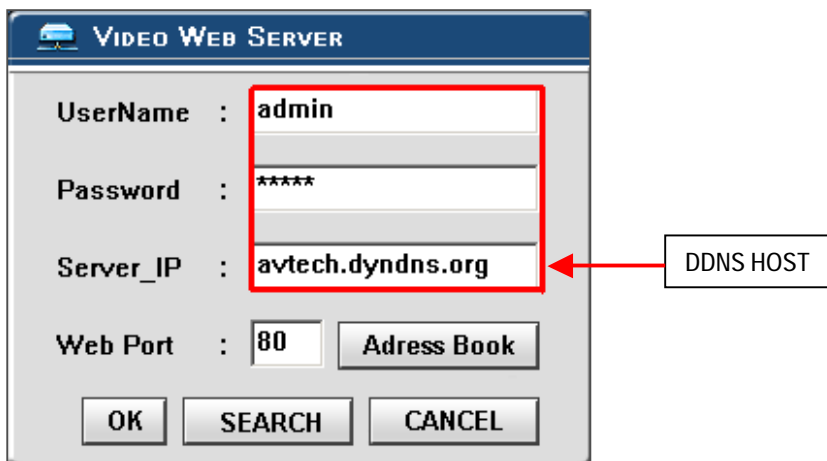

The screenshot shows a configuration window titled "VIDEO WEB SERVER". It contains the following fields and buttons:

- UserName :** admin
- Password :** *****
- Server_IP :** avtech.dyndns.org (This field is highlighted with a red box and labeled "DDNS HOST" with a red arrow pointing to it.)
- Web Port :** 80 (Next to it is an "Adress Book" button.)
- Buttons at the bottom: OK, SEARCH, CANCEL.

Note of Dynamic IP setting

- *In step 2.7 : Some routers don't support some DDNS HOST.
- *In step 3.1 : Please use router's LAN end to connect PC.
- *In step 3.8 : Please use IE browser to enter router's gateway.
- *In step 4.1 : Please make sure that you have pressed save after you finish setting.
- *In step 4.2 : Please make sure that you have pressed save after you finish setting.
- *In step 4.3 : Please make sure that you have pressed add after you finish setting.
- *In step 4.4 : Please make sure that you have pressed save after you finish setting.
- *In step 6 : Please use router's LAN end to connect to DVR. Use WAN end to connect to ADSL modem.
- *In step 7 : The Server IP is the DDNS HOST which you set in step 4.4.

SOFTWARE OPERATION AT CLIENT SITE

Follow the steps for connection at your client site (remote site). (e.g. If you set up the server at your office with one static ADSL, you can remotely proceed to watch the video anywhere with a networked computer.)

Step 1 : Click  twice to enter Login setup (please refer to “software installation”)

Step 2 : Key in “User Name” and “Password”. (e.g. “User Name” and “Password” are “dan” and the IP address is 61.222.50.174). Click “OK” to establish the connection.



NOTE:

1. There are two ways to get the software, one is via the attached CD, and the other is via Video Web Server. (Refer to APPENDIX#3)
2. You can press “Address Book” button to add a new IP into this table or choose any logged IP address to access the Video Server.
3. This function is designed to store the list of IP addresses which you can control and manage.

Step 3 : If you could see the video screen as following, you have been successfully connecting to the server.



Introduction of Basic Operation

A. Video Web Server control panel

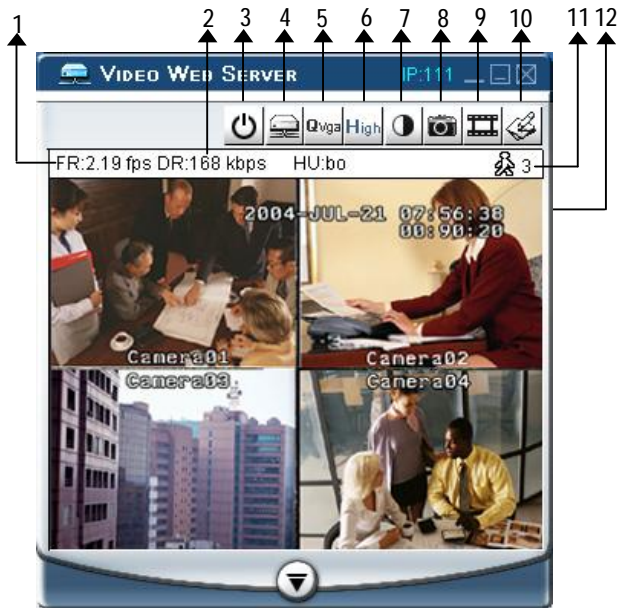

B. Digital device control panel



- 1.Camera video inputs
- 2.PIP, POP, QUAD screen
- 3.Zoom, Select, Lock, Search, Enter
- 4.Stop, Record, Rewind, Fast Forward, Pause, Slow, Play
- 5.Menu, Left, Right, Up, Down, Exit

NOTE :

After you press the record icon, there will be a recording file in the path that you have set. Each recording file can be saved up to 6000 frames. The recording file will be assigned to the second file if it has more than 6000 frames. Besides, if the HDD space is less than 200MB, the program will stop recording.

- 1.Image transmission rate per second
- 2.Data transmission rate
- 3.Power
- 4.Disconnection
- 5.Resolution : VGA 、 QVGA
- 6.Image quality : High 、 Middle 、 Low
- 7.Image adjusting : Brightness/ Contrast/ Saturation
- 8.Snapshot : press this button, the image will be automatically saved in the PC.
- 9.Record : press this button, the recording file will be saved in the PC automatically.
- 10.System setting
- 11.Number of online users
- 12.Window adjust (right click for Full Screen)

PLAYBACK OPERATION

Please find a recording file in the PC and click twice on it to playback.



1. On Screen Display
2. Snapshot
3. Stop
4. Pause
5. Slow (1/2, 1/4, 1/8)
6. PLAY
7. Fast
8. OSD show / hide
9. System setting (Path of snapshot, text color, progress color, channel color)
10. Next (Play next file on the same folder)
11. Duration time / Play speed
12. Playback controlling bar

ADVANCED SETTING

Click "System Config" for advanced setting.



NOTE :
Apply--
 After all setting changes, press "apply" to refresh the data.
Reboot--
 Press this button to restart setting.

ACCOUNT

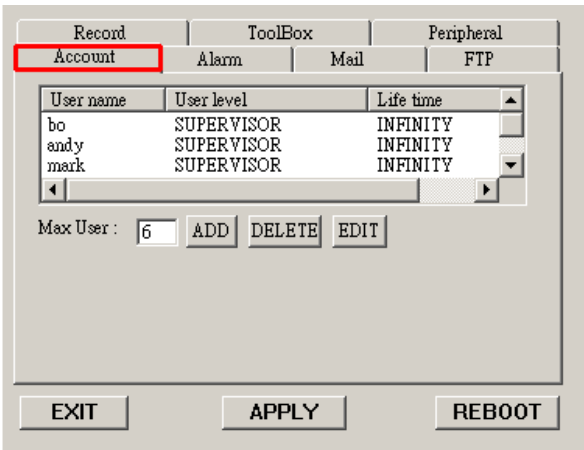

Set up the user's account(Max 10 accounts) , password and authority (Max 6 accounts in line at the same time) .

1. User's level:
 SUPERVISOR-control all the functions
 USER LEVEL-control advanced functions
 GUEST LEVEL-control basic functions only
2. Life time : During the period of time, users are allowed to control the Video Web Server.

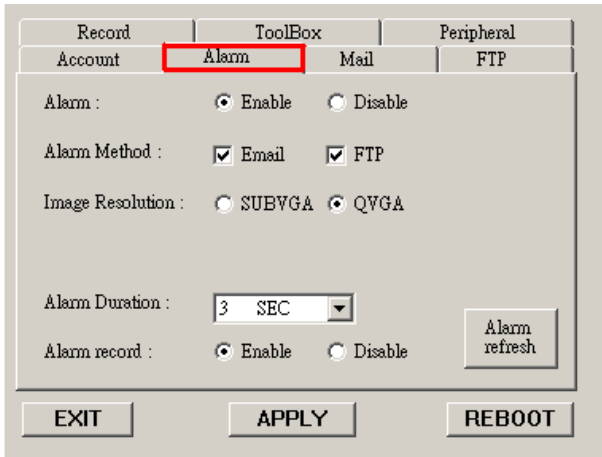

Set up the ALARM function. You can use it to operate "alarm trigger recording" function.

1. Alarm : Enable or disable Alarm trigger function.
2. Method : Two selections—E-mail or FTP.
3. Resolution : Image storing resolution for Email or FTP function(SUBVGA is 160 *120 QVGA is 320*240)
4. Alarm Duration : Alarm and alarm record duration time.
5. Alarm record : Enable or disable "Alarm trigger recording" function.
7. Alarm refresh : Clean the alarm message "🔴" which is showed on the screen.

MAIL

Record | ToolBox | Peripheral
Account | Alarm | **Mail** | FTP

Server : 211.75.84.99
Mail from : KEVIN
Verify Password
Verify : Yes No
User : romain.chien
Password : *****

Modify alarm email address
ADD DELETE EDIT

Mail Account
sam.ling@avtech.com.tw
kevin.chu@avtech.com.tw

EXIT APPLY REBOOT

When the alarm is triggered, the video server program will capture the instant picture and e-mail the captured image to the assigned recipients.

- 1.You can get all the data from the ISP company or by mailing to the server supplier.(POP3/SMTP server)
- 2.You should set the mail list which you want to send to when the alarm is triggered.
- 3.If it is not necessary for you to verify password and user's name, please choose Verify as "No".

FTP

Record | ToolBox | Peripheral
Account | Alarm | Mail | **FTP**

Username : ftp_svc
Password : ***
Port : 21
Server : 211.75.84.102/tulu
Directory :

EXIT APPLY REBOOT

When the alarm is triggered, the video server program will capture the instant picture and upload the captured image to the assigned FTP site.

- 1.You can get all the data from your MIS department.
- 2.The default uploading port is No.21.
- 3.You can set the uploading directory by yourself.

RECORD

Account | Alarm | Mail | FTP
Record | ToolBox | Peripheral

Record Path
Modify
C:\Documents and Settings\mark.wen.MARKE707\桌

Snapshot Path
Modify
C:\Documents and Settings\mark.wen.MARKE707\桌

EXIT APPLY REBOOT

You can modify the storing path for recording file and snapshot images by yourself.

TOOLBOX

Name	IP Address	Level	Chan...	Resol...
andy	211.75.84.96	SUPE...	CH 1	QVGA
andy	211.75.84.96	SUPE...	CH 1	QVGA
andy	211.75.84.96	SUPE...	CH 1	QVGA

Upgrade the firmware and get the online users' information.

NOTE : Do not reboot the DVR while it is upgrading the firmware.

1. Firmware Version : The current firmware version. You can click on "Find" button to get the latest firmware from PC and press "Upgrade Firmware" to upgrade it.
2. Info refresh : Refresh the online users' information.

PERIPHERAL

ID :	0
Model :	4CH DVR
Turbo Step :	5

You can see the default peripheral settings in this Windows.

1. Turbo Step: Set the shift step when you shift the zone which you see during the zoom in function.

CONNECT VIDEO WEB SERVER VIA IE BROWSER

You can also connect Video Web Server via browser. This function is suitable in both WIN 2000 and WIN XP (WIN XP is preferable to WIN 2000)

Step 1 : Open IE browser, in Tools/ Internet Options/Security/Custom Level, please select “Enable” for all options of ActiveX.

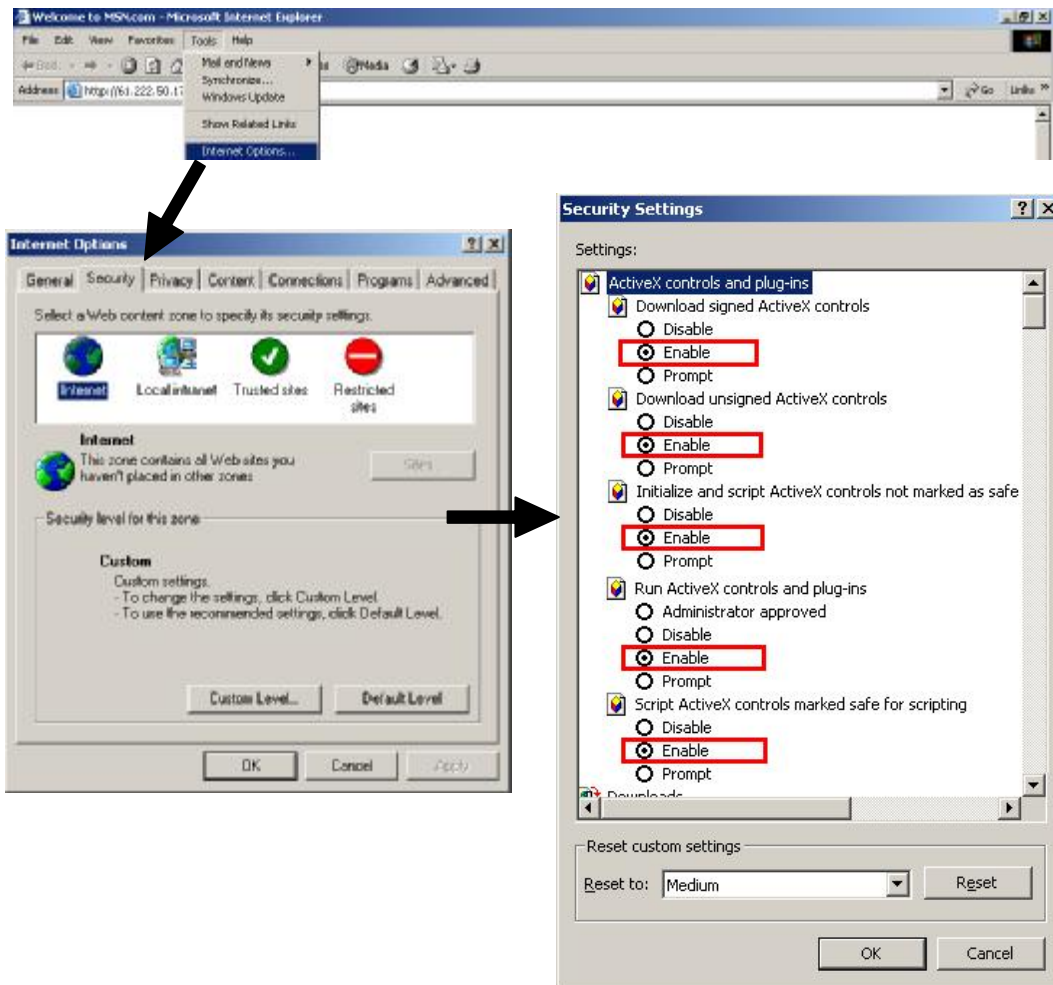

Step 2 : Enter IP address that you want to connect.

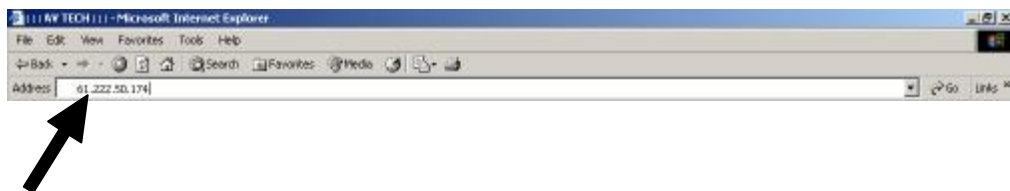

Step 3 : Enter your Username and Password to login Video Web Server.



Step 4 : After you login, you will see as below.

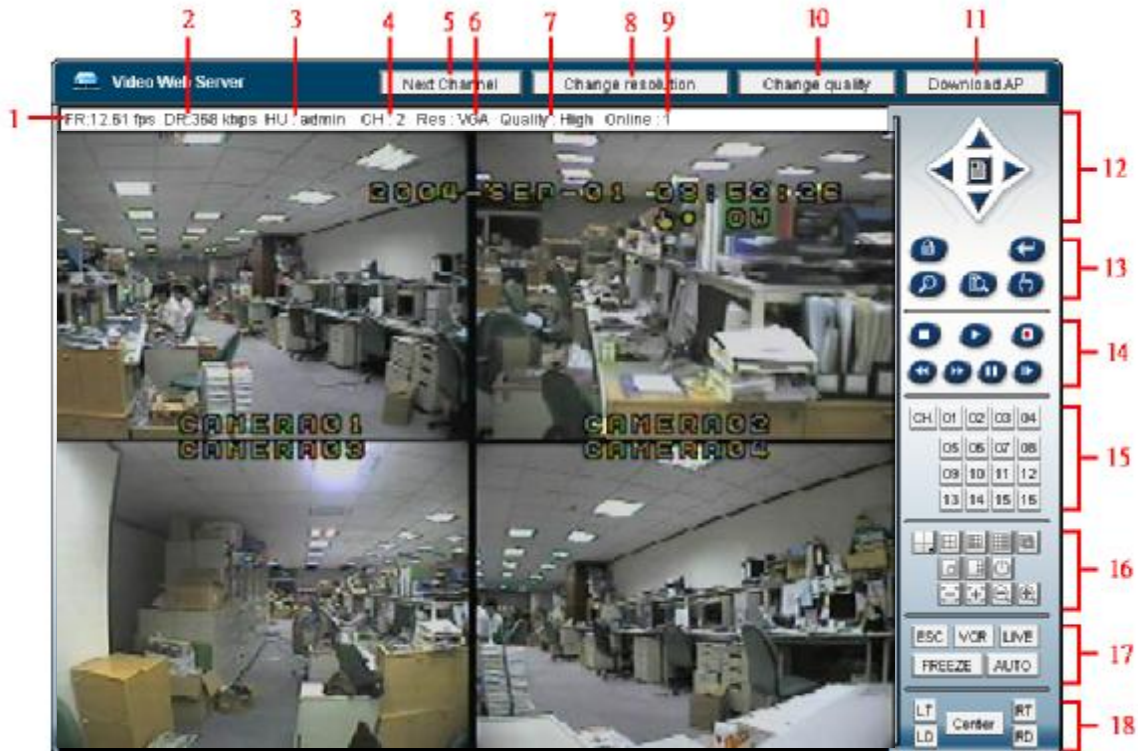

1. Image transmission rate per second
2. Data transmission rate
3. User name
4. Video CHs
5. Channel switching button
6. Resolution : VGA 、 QVGA
7. Image quality : High 、 Middle 、 Low
8. Resolution switching button
9. Number of online users

10. Quality switching button
11. Download AP button
12. Menu, Left, Right, Up, Down, Exit
13. Lock, Zoom, Enter, Search, REC.
14. Stop, Record, Rewind, Fast Forward, Pause, Slow, Play
15. Camera
16. 4, 9, 16, Multi, PIP, POP, Power, Focus, Zoom
17. ESC, VCR, LIVE, FREEZE, AUTO
18. Position of view

OPERATION OPTIONS **Advanced Operation**

ZOOM

Press ZOOM button to enlarge the display of main picture. It displays zoomed picture on main picture and a small window inserted. The inserted window contains a movable 1/4 view size of the appointed camera. The range is from 2X to 4X.

- Press PIP button : Zoom in
- Press QUAD button: Zoom out
- Press the "Zoom" button again to leave the zoom pointer.
- Press Camera 1-4 button to select channel.
- Press ▲▼◀▶ button to move the zoom position.



Original



2X Zoom



4X Zoom

VIDEO LOSS

Screen will display "LOSS" in the center of display picture, if the video input is not connected properly.

SEARCH

1. LAST RECORD

Play the last recorded piece of video.

2. FULL LIST

List all recorded video on the HDD that are sorted by time.

 : Motion Recording

 : Manual Recording

 : Alarm Recording

 : Timer Recording

M : Storage in Master HDD (or S:Storage in Slave HDD)

NOTE: It will display different color on each record list mention above.

3. ALARM LIST

List all recorded video triggered by an Alarm.

NOTE : If there is no Alarm in the record, the screen will display "EMPTY".

4. MOTION LIST

List all motion triggered recordings.

5. TIME SEARCH

Find video recorded on a specific date.

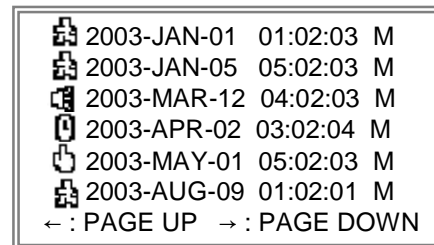
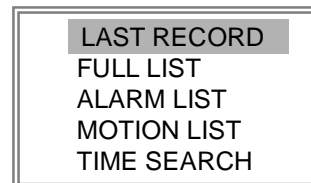

KEY LOCK

For advanced security, users can "Lock" the buttons on your DVR. Key-Lock prevents other people from using the system.

Press "ENTER" + "MENU" at the same time to enable Key Lock.

Press "ENTER" + "MENU" at the same time and key in password (Default : 0000), then press "ENTER" to disable Key Lock.

NOTE: To switch to different USER, press "ENTER" + "MENU" buttons to "KEY LOCK" and then enter the different user's password to UNLOCK.

TROUBLESHOOTING

When malfunction occurs, it may be not serious and can be corrected easily. The table below describes some typical problems and their solutions. Please check them before calling your DVR dealer.

PROBLEM	SOLUTION
No power	<ul style="list-style-type: none">I Check power cord connections.I Confirm that there is power at the outlet.
Not working when press any button	<ul style="list-style-type: none">I Check if it is under Key Lock mode.I Press "MENU" & "ENTER" to exit Key Lock mode.
No recorded video	<ul style="list-style-type: none">I Check if the HDD is installed properly.
Timer Record enable does not working	<ul style="list-style-type: none">I Check if the Record Enable is set to YES
No live video	<ul style="list-style-type: none">I Check camera video cable and connections.I Check monitor video cable and connections.I Confirm that the camera has power.I Check the setting of camera lens.
NTSC & PAL System switch	To switch the system, press " POWER " + " FF " to NTSC system and " POWER " + " REW " to PAL system. (Refer to Page 7 "GETTING STARTED".)

SPECIFICATIONS

Camera Input Signal	Composite video signal 1 Vp-p 75Ω BNC, 4 channels
Network Interface	Ethernet (10/100 Base-T)
Protocols	TCP/IP, ICMP, SMTP, HTTP, FTP
Main Monitor Output	Composite video signal 1 Vp-p 75Ω BNC
Call Monitor Output	Composite video signal 1 Vp-p 75Ω BNC
Audio input	4 audio inputs, (RCA) *
Audio output	2 audio outputs, (RCA) **
Motion Detect Area	16 * 12 targets per camera
Motion Detect Sensitivity	99 Levels
Video Loss Detection	Yes
Refresh Rate	240 fields/sec. <NTSC> / 200 fields/sec. <PAL>
Recording Rate	Multiplex:Up to 30 fields/sec.< NTSC> / 25 fields/sec.<PAL> Quad-field:Up to 120 fields/sec.<NTSC> / 100 fields/sec.<PAL>*** Quad-frame:Up to 240 fields/sec.<NTSC> / 200 fields/sec.<PAL>****
Dwell Time	Programmable (1~15 Sec)
Picture in Picture	Yes (Movable)
Key Lock	Yes
Picture Zoom	2*2 ~4*4 (Movable)
Camera Title	8 letters
Video Adjustable	Hue/ Color/ Contrast/ Brightness Adjustable
Alarm Input	TTL input, Hi (5V), Low (GND)
Alarm Output	COM./N.O/N.C
Trigger & Action	E-Mail images or images uploading to FTP site's specific account/ Remote Recording
Web Interface	Yes
Time Display Format	YY/MM/DD, DD/MM/YY, MM/DD/YY, OFF
Power Source	DC 19V
Power Consumption	<32W
Operation Temperature	10 ~ 40°C
Dimension (mm)	343(W) x 223(L) x 59(H)

• Specifications are subject to change without notice.

* 4 audio inputs, can select only 1 during operation for recording at the same time.

** with 2 mono audio outputs from the same source.

***NTSC: 4CH x 30IPS = 120 fields/sec, PAL: 4CH x 25IPS = 100 fields/sec

****NTSC: 4CH x 60IPS = 240 fields/sec,PAL: 4CH x 50IPS= 200 fields/sec

APPENDIX #1 – INSTALL THE HDD

Follow the steps carefully in order to ensure correct installation.

The compartment located on the front panel of the DVR is the removable Cartridge, in which you insert the HDD. The various parts of the Cartridge are labeled for your reference.

*****Note: Users need to set the HDD on the Master mode for the system detecting.*****

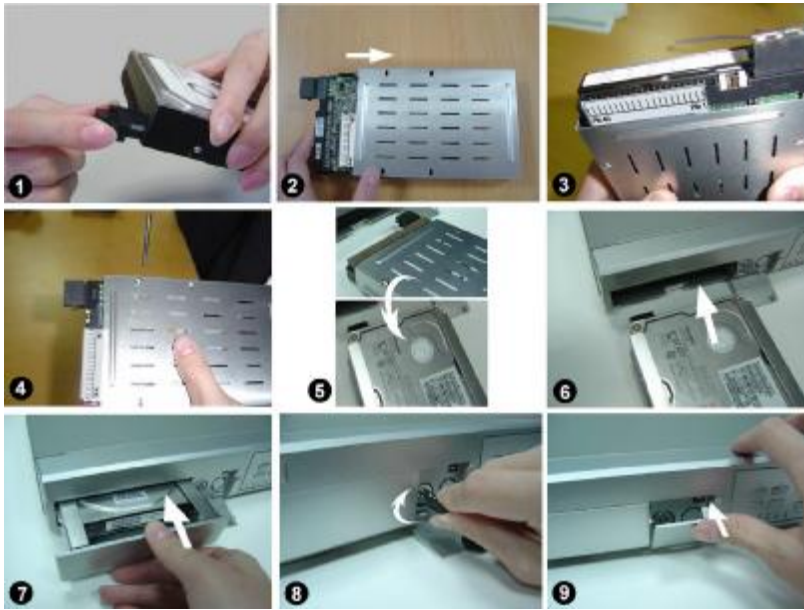

Step 1 Connect the connector with the HDD (refer to Picture 1).

Step 2 Put HDD into the HDD cartridge. Please notice the bottom side is power side as chart shows (refer to Picture 2).

Step 3 Screw the HDD to the cartridge. Before you screw the HDD, please be aware that you must to level pin 1 of the HDD at pin 1 mark, because the screw hole is different from different HDD brands. Then screw the HDD correctly (refer to Picture 3 and 4). You must precisely align the hard disk to the pin connection to ensure correct installation.

Step 4 Reverse the HDD and put it into DVR (refer to Picture 5 and 6).

Step 5 Connect the HDD with DVR (refer to Picture 7).

Step 6 Lock the cabinet by turning the key clockwise (refer to Picture 8).

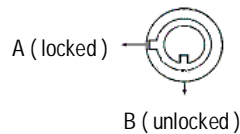

Note : If you do not lock the cabinet, the DVR system will not function properly.

Step 7 Close the cap (refer to Picture 9).

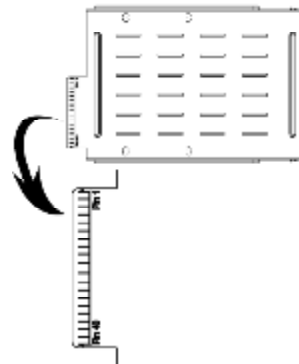

APPENDIX #2 – REPLACE THE HDD



Step 1 Open the cap



Step 2 Unlock the cabinet by turning the key anti-clockwise

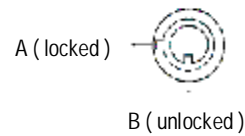

Step 3 Pull out the cartridge



Step 4 Loosen all screws on the Cartridge



Step 5 Remove the HDD from Cartridge

- Note: 1. If you want to change a different HDD, you must remove the connectors from HDD (refer to Page 51).
2. When HDD works for a period of time, the surface temperature will be high, please pay attention to it.
3. After turning the key to unlock position, please wait for several seconds until HDD operation stops completely.

HDD HOT SWAP FUNCTION

Please follow the steps as following to ensure the reliability.

- 1)Unlock the cabinet by turning the key anti-clockwise.
- 2)Key in your password and press enter to disable the hard drive.
- 3)Pull out the HDD cartridge.
- 4)Replace the HDD in the tray.

Note: After turning the key to unlocked position, please wait for several seconds till HDD operation stops completely.

APPENDIX #3—PIN CONFIGURATIONS

15 pin com port

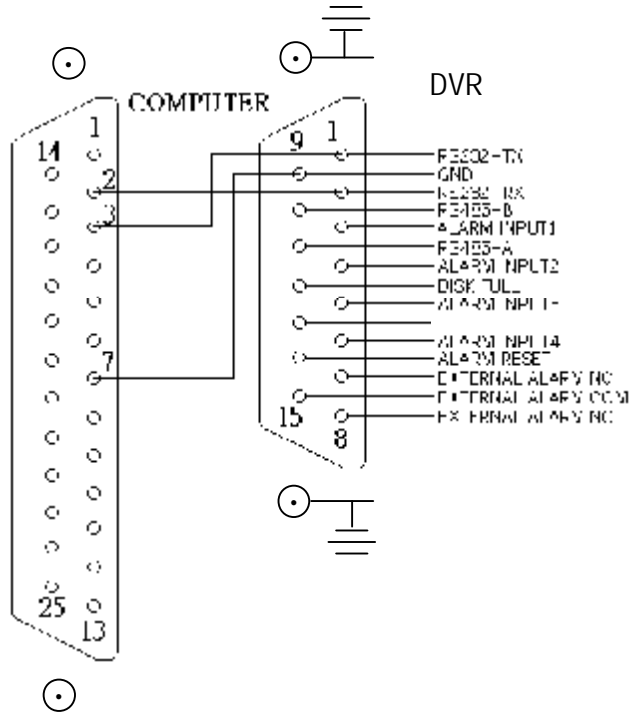

9 pin com port

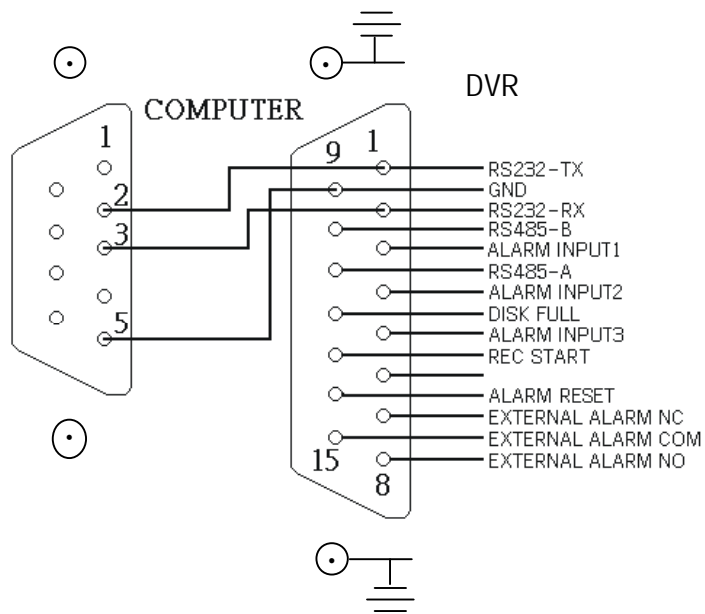

PIN 3, 4, 5, 6 ALARM INPUT

To connect wire from ALARM INPUT (PIN 3, 4, 5, 6) to GND (PIN 9) connector, DVR will start recording and buzzer will be on. When alarm has been triggered, signal becomes “Low”, and it will stop all alarm activities. Under normal operation, signal remains “High”.

PIN 7. EXTERNAL ALARM NC

Under normal operation COM connects with NC and disconnects with NO. But when alarm is triggered, COM disconnect with NC, and connect with NO.

PIN 8. EXTERNAL ALARM NO

Under normal operation, COM will disconnect from NO. But when Alarm is triggered, COM will connect with NO.

PIN 9. GND

GROUND

PIN 12. DISK FULL (OUTPUT)

When the HDD is full, it sends a signal to trigger next DVR recording mode, if you install another DVR. Under normal operation, the signal remains “High”, but when the disk is full, DVR will send “Low” signal.

PIN 14. ALARM RESET (INPUT)

To connect wire from ALARM RESET (PIN 14) to GND (PIN 9) connector, it can disable ALARM. An external signal to ALARM RESET (PIN 14) can be used to reset both ALARM OUTPUT signal and DVR’s internal buzzer. When alarm has been triggered, signal becomes “Low”, and it will stop all alarm activities. Under normal operation, signal remains “High”.

PIN 15. EXTERNAL ALARM COM

Under normal operation COM connect with NC and disconnect with NO. But when alarm is triggered, COM disconnects with NC, and connects with NO.

APPENDIX #4 – RECORDING SPEED

The Recording Time is different based on Recording Speed, Recording Quality and Recording Mode. Please refer to the following table. The HDD capability is 250GB.

NTSC SYSTEM

IPS		30	15	8	4	2	1
MULTIPLY	Best	50hr	100hr	187hr	375hr	750hr	1500hr
	High	62hr	125hr	235hr	468hr	937hr	1875hr
	Normal	100hr	200hr	375hr	750hr	1500hr	2998hr
	Basic	167hr	333hr	625hr	1250hr	2498hr	4996hr
QUAD-FIELD	Best	48hr	95hr	178hr	356hr	712hr	1425hr
	High	59hr	118hr	223hr	445hr	890hr	1781hr
	Normal	95hr	190hr	356hr	712hr	1425hr	2848hr
	Basic	158hr	316hr	594hr	1187hr	2373hr	4746hr
QUAD-FRAME	Best	24hr	48hr	89hr	178hr	356hr	713hr
	High	30hr	59hr	112hr	223hr	445hr	890hr
	Normal	48hr	95hr	178hr	356hr	713hr	1424hr
	Basic	79hr	158hr	297hr	594hr	1187hr	2373hr
HDD Type	250 GB						

PAL SYSTEM

IPS		25	12	6	3	2	1
MULTIPLY	Best	50hr	104hr	210hr	423hr	633hr	1266hr
	High	62hr	131hr	265hr	527hr	792hr	1583hr
	Normal	102hr	210hr	422hr	844hr	1266hr	2542hr
	Basic	168hr	350hr	704hr	1406hr	2110hr	4218hr
QUAD-FIELD	Best	48hr	98hr	200hr	400hr	600hr	1202hr
	High	58hr	124hr	251hr	500hr	752hr	1503hr
	Normal	98hr	200hr	400hr	800hr	1202hr	2414hr
	Basic	160hr	332hr	668hr	1335hr	2004hr	4005hr
QUAD-FRAME	Best	24hr	50hr	100hr	200hr	300hr	600hr
	High	30hr	62hr	125hr	250hr	376hr	751hr
	Normal	49hr	100hr	200hr	400hr	601hr	1207hr
	Basic	80hr	166hr	334hr	667hr	1002hr	2003hr
HDD Type	250 GB						

*Note: The data above is obtained from actual test of recording normal TV programs.
(For Reference Only)*