

4 CH Digital Multiplex Recorder



User Manual

Please read this instructions thoroughly before operation and keep the manual in a safe place for further reference.

WARNING

All the safety and operating instructions should be read before operation. The improper operation may cause permanent damage.

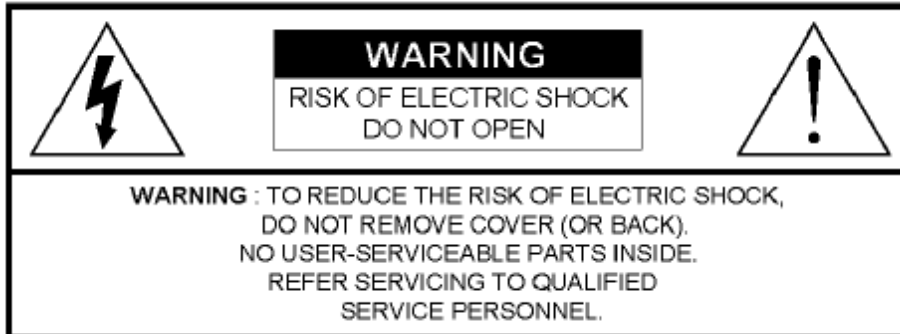

- Please use the provided adaptor (Other adaptor is not suitable for this machine).
- Please lift and place this equipment gently.
- Do not expose this equipment to open sunlight.
- Do not use this equipment near water or in contact with water.
- Do not spill liquid of any kind on the equipment.
- Please power down the unit before unplugging.
- Do not switch the Power On & Off within short period of time (within 3 seconds).
- Do not attempt to service this equipment by yourself.
- Installation should be made by qualified service personnel.



The lightning flash with arrowhead symbol, within an equilateral triangle, is intended to alert the user to the presence of uninsulated "dangerous voltage" within the product's enclosure that may be of sufficient magnitude to constitute a risk of electric shock to persons.



The exclamation point within an equilateral triangle is intended to alert the user to the presence of important operating and maintenance-(servicing) instructions in the literature accompanying the appliance.

TABLE OF CONTENTS

What do you get ?

- FEATURES ----- 3
- PACKAGE CONTENT ----- 3

Before Operation

- INSTALLATION GUIDE ----- 4
- FRONT PANEL ----- 5
- BACK PANEL ----- 7

Basic Operation

- START THIS UNIT ----- 8
- OPERATION ----- 8

Detailed Menu Setup

- ACCESS MENU ----- 10
- MAIN MENU ----- 10
- MENU OPTIONS ----- 11
- MOTION DETECTION ----- 14

Advanced Operation

- OPERATION OPTIONS ----- 16
- KEY LOCK ----- 17
- RS-232 PROTOCOL ----- 17

Trouble Shooting ----- 17

Specifications ----- 18

APPENDIX #1 – INSTALLING THE HDD ----- 19

APPENDIX #2 – PIN CONFIGURATIONS ----- 21

APPENDIX #3 – RACK MOUNT ----- 23

APPENDIX #4 – RECORDING SPEED ----- 24

What do you get ?

FEATURES

DVR Features

- | Wavelet compression format replaces Time-Lapse VCR + Multiplexer / Quad
- | 4 audio inputs / 2 audio outputs
- | On Screen Display and Remote Control via Video Server & PC
- | Picture-in-picture (PIP) in live
- | Motion detection & motion trigger recording function
- | Alarm input & output function
- | Video loss detected on each channel
- | Linear Zoom (2x~4x)
- | Multiplexer & Quad recording mode switching
- | Recording rate up to full size 30 images/sec. or Quad size 120 images/sec.
- | Support 1 removable HDD with hot-swap capability, IDE TYPE (over 250 GB)
- | Quick multiple search by date/time, alarm, full, motion list
- | Security password protection
- | RS-232, RS-485 communication protocol

PACKAGE CONTENT



Digital Multiplex Recorder(with HDD cartridge)



User Manual



Accessories pack



2 Keys for Cartridge



Power Adapter and Cord

NOTE : Please check the package to make sure that you receive the complete accessories which includes the components shown above.

INSTALLATION GUIDE

1. Connect cameras and monitor to the DVR.
2. Shown below is an example of connecting the DVR to your existing Observation System.
3. Install HDD (The compatible HDD Brands are listed in the following table.)

Please refer to page.22 Appendix #1 for installation instructions.

*The HDD must be installed before turning on the DMR, but if HDD is not installed, the DVR would be functioned as 4 CH multiplexer.

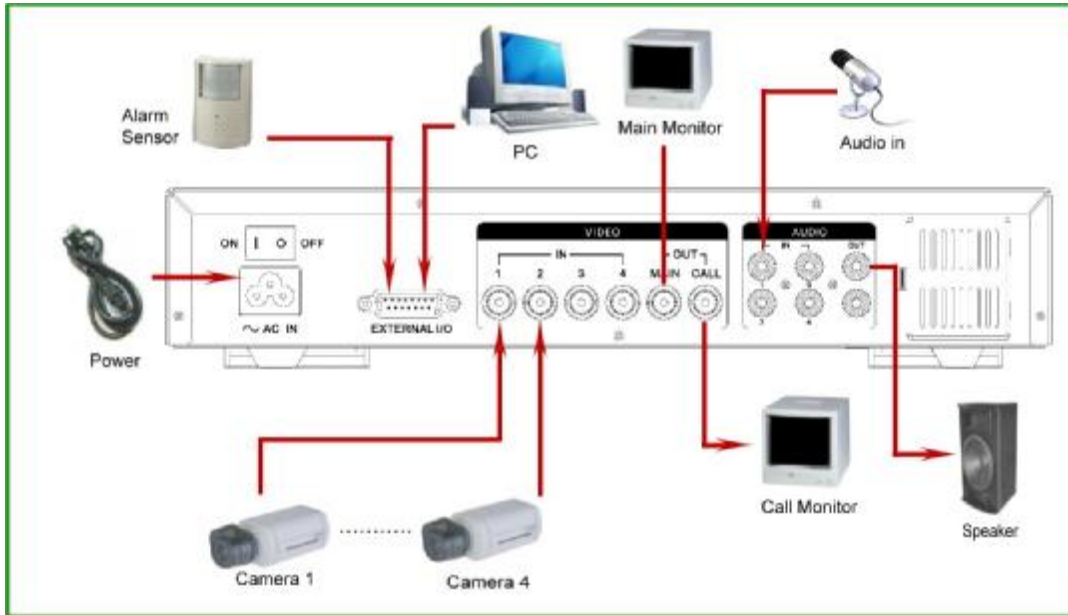

COMPATIBLE HARD DISK MODELS

Manufacturer	Model	Capacity	Rotation
HITACHI	Deskstar 180 GXP (120 GB)	120GB	7200 rpm
HITACHI	Deskstar 7K250, HDS722516VLAT20	160GB	7200rpm
HITACHI	Deskstar 7K250, HDS722525VLAT80	250GB	7200rpm
IBM	Deskstar 120GXP (80GB)	80GB	7200 rpm
IBM	Deskstar 120GXP (120GB)	120GB	7200 rpm
Maxtor	DiamondMax 536DX(60GB) 4W060H4	60GB	5400rpm
Maxtor	DiamondMax Plus 9	80GB	7200 rpm
Maxtor	DiamondMax Plus 9, Model#6Y120L	120GB	7200 rpm
Maxtor	DiamondMax Plus 9, Model#6Y160L0	160GB	7200rpm
Maxtor	MaxLine Plus II , Model#7Y250P0	250GB	7200rpm
Seagate	Barracuda ATA IV, ST380021A	80GB	7200rpm
Seagate	Barracuda ATA V, ST3120023A	120GB	7200 rpm
Seagate	Barracuda 7200.7 Plus, ST3160023A	160GB	7200 rpm
Western Digital	Caviar WD1200BB-00CAA1	120GB	7200rpm
Western Digital	Caviar WD2000BB-00DWA0	200GB	7200rpm
Western Digital	CaviarSE WD2500JB	250GB	7200rpm

FRONT PANEL

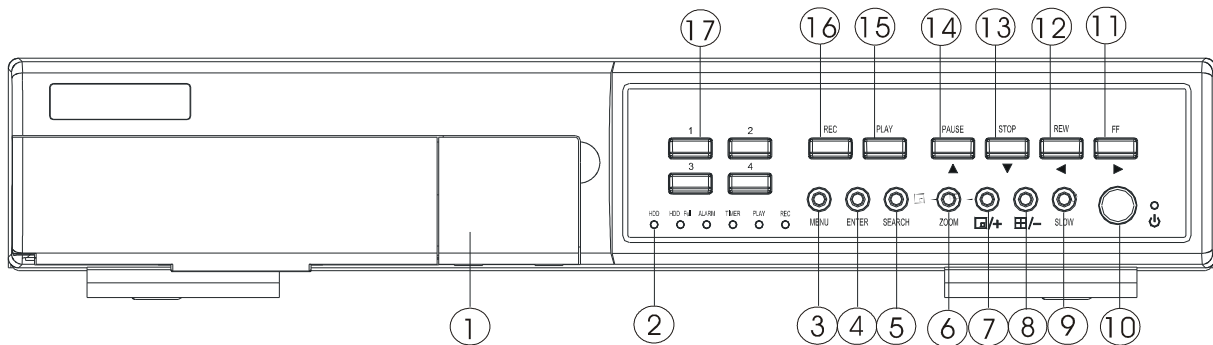

1. REMOVABLE HDD CARTRIDGE & KEYHOLE

Please refer to page.22 Appendix #1.

2. LED LIGHT

The LED Light is ON under following condition.

- HDD : HDD status display
- HDD Full : HDD is full
- ALARM : To turn off the ALARM LED light, please refer to page.14 and set the ALARM mode as OFF.
- TIMER : When Timer is set as Enabled
- PLAY : On Playing mode
- REC : On Recording mode

3. MENU

Press MENU to enter main menu.

4. ENTER

Press ENTER for confirmation.

5. SEARCH

Press SEARCH for searching recorded video.

6. ZOOM

Press ZOOM to enlarge the picture display.

7. /+ Picture in Picture

Press PIP button for Picture in Picture screen, and “+” can be used for detail change.

8. /- 4 channels display mode

Press “” button for 4 channels display mode, and “-” can be used for detail change.

9. SLOW

To slow down the speed of playing mode.

10. POWER

Press Power to turn ON / OFF the DMR.

11. REC

Press REC to start recording.

12. PLAY

Press PLAY to playback recorded video.

13. PAUSE / Up

- Pause : Under DMR play mode, it can pause the action.
- UP : Under setup mode, it works as Up button.

14. STOP / Down

- STOP : Under DMR Record / Play mode, it can stop the moment action.
- DOWN : Under setup mode, it works as Down button.

15. REW / Left

- REW : Under DMR play mode, it can play video backward at different speeds. (Press REW again to adjust speed as 1, 2, 4, 8, 16, 32 times)
- Left : Under setup mode, it works as Left button.

16. FF / Right

- FF : It can play video forward at high speed, and press FF again to adjust speed from 1, 2, 4, 8, 16, 32 times.
- Right : Under setup mode, it can work as Right button.

17. CAMERA SELECT (1-4)

Press the Camera Select (1-4) to select specified camera.

REAR PANEL

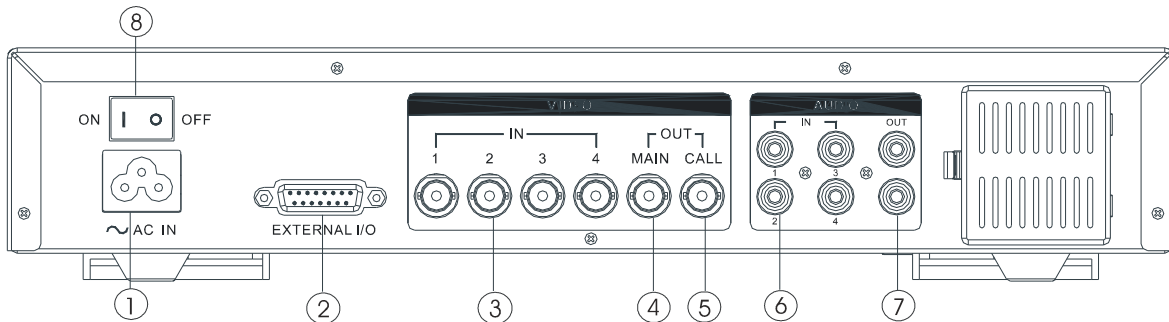

1. POWER

Please use the provided power cord (The adaptor is embedded).

2. EXTERNAL I/O

- Controlled remotely by an external device or control system like Video Web Server.
- Alarm input, external I / O explanation.

3. VIDEO INPUT (1-4)

Connect to video source, such as camera.

4. MAIN

Connect to Main monitor.

5. CALL

Connect to CALL monitor. Show the Switch Display.

When alarm trigger happens, the call monitor will show the triggered channel for a period of time.

6. AUDIO IN (1-4)

Connect to audio sources, such as a microphone.

- IPS should be set to 30 (for NTSC) or 25 (for PAL)

*** 4 audio inputs, but can only record one input at the same time.**

7. AUDIO OUT (R/L)

Connect to monitor or speaker.

- IPS should be set to 30 (for NTSC) or 25 (for PAL)

*** with 2 mono audio outputs from the same source.**

8. FAN

Basic Operation

GETTING STARTED

Before using the DMR, please have a HDD installed ready, or it will be functioned as 4 CH multiplexer (refer to Appendix #1 for installation or removal of a HDD).

1. Connect the AC Power Cord and plug into an electrical outlet then press the power switch "ON". The Red LED indicator light will be ON and the DMR is in Standby mode.
2. Press the Power button. The POWER LED will turn from red to orange, and other red LED indicators will turn ON. It takes approximately 5 to 15 seconds to boot the system with the message : " HDD Detecting ". Once connected, the POWER LED will change to green color, and the Alarm LED will be ON.
3. Before operating the DMR, set the system time first. (refer to page.11).

NOTE : If the HDD is not installed correctly or not installed, the "HDD not found" message will appear only 3 seconds and then return to 4 CH Multiplexer display mode.

OPERATION

RECORDING

The DMR offers a variety of recording modes, such as record continuously, by scheduled time, and by events. You can set up recording speed and resolution. You can set these options by selecting MENU / RECORD before recording, please refer to page.13. Under the recording status, if power is off accidentally, recorded video will still be stored in the HDD. DMR will return to original recording situation after power restores again.

On the screen, you will find the date, time, HDD recording type, the amount of available GB left in the HDD memory and the letter " " represents the method of recording that is occurring.
(OW : HDD Overwrite)

2002 – JAN –01 01:02:03

 ●OW

NOTE : 1. When the HDD is full under O/W Recording mode, previous recorded files will be overwritten without further warning notices.

2. If the HDD capacity is only 5 GB left, it will display "5 GB" on the up-right screen and shows orange color, and it will buzz for seconds; so as in 4GB, 3GB, 2GB and 1GB. If the O/W Recording mode (NOTE 1) is on, it won't have the warning buzzer.

There are 4 recording modes: Alarm, Motion, Timer and Manual Record.

1. ALARM RECORDING

DMR is triggered by an alarm input.  symbol will be shown on the triggered channel.

2. MOTION TRIGGER RECORDING

Recording is triggered by motion detection.  symbol will be shown on the triggered channel.

3. TIMER RECORDING

Recording is scheduled by a Timer. It will indicate by the symbol .

4. MANUAL RECORDING

Recording is initiated manually by pressing the REC button. Symbol  will be shown.

PLAYBACK

Press "PLAY" button, the DMR will show the last recording.

1. FAST FORWARD (F.F.) & FAST REWIND (F.R.)

You can increase the speeds of Fast Forward and Rewind on the DMR.

In the Play mode, press "▶" once to get 2X speed forward and press twice to get 4X speed,... and the maximum speed can reach 32X.

Press "◀" once to get 1X speed rewind and press twice to get 2X speed, ... and the maximum speed can reach 32X.

2. SLOW FORWARD (S.F.) & SLOW REWIND (S.R.)

You can also slow down the speeds of Forward and Rewind on the DMR.

In the Play mode, press the SLOW button and you will enter Slow mode.

Press "SLOW" once to get 1/2X speed forward and press "▶" to get 1/4X speed,... and the slowest speed can reach

1/32X.

Press "◀" once to get 1/2X speed rewind and press twice to get 1/4X speed, ... and the slowest speed can reach 1/32X.

3. PAUSE

It will let you pause the current image displayed on the screen.

4. STOP

Press "STOP" under any circumstance, DMR will return to live monitoring mode.

5. IMAGE JOG DIAL

It will allow you to manually view video frame-by-frame, one image at a time.

While in PLAY mode, press "PAUSE", it will pause the screen.

Pressing "▶" button advances the frozen screen one image forward.

Pressing "◀" button moves back one image.

CAMERA SELECT (1-4)

Press Camera Select (1-4) to select appointed camera to display on full screen mode.

Detailed Menu Setup

MAIN MENU

There are 12 options available in the Main Menu:

TIMER ----- Programs Specific Time to Record
CAMERA ----- Camera Channel Setup
RECORD ----- Record Mode Setup
ALARM ----- Alarm Setup
DWELL ----- Dwell time Setup
PIP ----- Picture in Picture Setup
MOTION ----- Motion Detection Setup
DISPLAY ----- Display Mode Setup
REMOTE ----- Remote Control Setup
USER ----- User Password Setup
SYSTEM ----- System Setup
EVENT ----- Event List

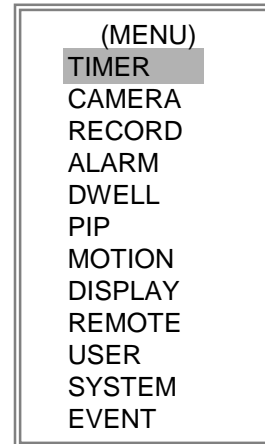

Outlined below are the buttons used for Menu setting :

- “Up” and “Down” : Scroll up and down or change values when an option is selected and is blinking
- “Left” and “Right” : Scroll sideways within a menu option that has been selected
- “ + ” and “ - ” : Increase and decrease the number or change values when an option is selected and is blinking
- ENTER : Selects a submenu / an option under a submenu for browsing / modification
- MENU : Completes modification of a menu option; exits a menu

MENU OPTIONS

SYSTEM

1. AUDIO INPUT

To choose one of 4 channels to record. (It can only record 1 input)

2. BUZZER

Set the BUZZER "ON", it will buzzer by event occurrence when the setting is ON.

3. EXT ALARM

To set the EXTERNAL AUDIBLE ALARM. It will be triggered by event occurrence when the setting is ON.

4. VLOSS ALARM

To set the VLOSS ALARM. When the setting is "ON", the alarm will occurrence by the setting of Buzzer, EXT alarm or Alarm Duration.

5. MOTION ALARM

To set the MOTION AUDIBLE ALARM. When the setting is "ON", the alarm will occurrence by the setting of Buzzer, EXT alarm or Alarm Duration.

6. HDD OVERWRITE

To set the HDD OVERWRITE. When the HDD is full under O/W recording mode, previous recorded files will be overwritten without further warning notices when the HDD OVERWRITE is ON.

7. MESSAGE LATCH

To select whether the DMR messages will disappear after 10 second or remain on screen. NO is the default setting which the messages will disappear after 10 sec.

NOTE : Video loss, Alarm and Motion messages will be shown the same as Alarm Duration time.

8. DATE DISPLAY

To set the date Y/M/D, M/D/Y, D/M/Y and OFF on monitor or not.

9. DATE

To set the date shown on the DMR.

10. TIME

To set the time on the DMR.

11. CLEAR HDD

Delete all the contents of the HDD. When you choose "YES" on this option, press "ENTER" and you will be prompted with the question shown: Press "→" to clear HDD or press "←" to cancel.

12. SYSTEM RESET

Reset all system settings back to factory default settings.

(MENU)
TIMER
CAMERA
RECORD
ALARM
DWELL
PIP
MOTION
DISPLAY
REMOTE
USER
SYSTEM
EVENT

(SYSTEM)	
AUDIO INPUT	1
BUZZER	ON
EXT ALARM	ON
VLOSS ALARM	ON
MOTION ALARM	ON
HDD OVERWRITE	YES
MESSAGE LATCH	YES
DATE DISPLAY	D/M/Y
DATE	26-DEC-2003 [FRI]
TIME	22:55:34
CLEAR HDD	YES
SYSTEM RESET	YES

TIMER

1. DAY

Select the day, or days of the week (Mon–Fri / Sat–Sun / Daily) that you wish to schedule the DMR to automatically record.

NOTE :

1. Special Date could be changed by “+” and “-” buttons.
2. If you have selected the specific date and recording timer set from that specific day to a new day, then the Recording Timer Schedule will be set as whole week. For specific date of Recording Timer Schedule, it is not recommended to set End Time over 23:59. For example: If you set Timer Schedule Day as Sunday, and START from 11:30, but End on 00:20, then Recording Timer Schedule is set as from every Sunday's 11:30 to next Sunday's 00:20. If you only want to set Recording Timer Schedule from every Sunday 11:30 to Monday 00:20, then you should set Recording Timer Schedule as Sunday from 11:30 to 23:59, and Monday from 00:00 to 00:20.

(MENU)
TIMER
CAMERA
RECORD
ALARM
DWELL
PIP
MOTION
DISPLAY
REMOTE
USER
SYSTEM
EVENT

2. START

Select the starting time for the recording.

3. END

Select the finishing time for the recording.

4. IPS

Stands for Images Per Second and it could let you see Record submenu for more details.

NTSC—30、15、8、4、2、1

PAL—25、12、6、3、2、1

5. QUALITY

Select the image quality for the recording. There are four Quality settings : BEST, HIGH, NORM and BASE.

(TIMER)					
DAY	START	END	IPS	QLT	MODE
DAILY	01:00	22:00	30	BEST	Q-FR
OFF	00:00	00:00	30	BEST	Q-FI
OFF	00:00	00:00	30	BEST	Q-FI
OFF	00:00	00:00	30	BEST	Q-FR
OFF	00:00	00:00	30	BEST	Q-FR
OFF	00:00	00:00	30	BEST	Q-FR
OFF	00:00	00:00	30	BEST	Q-FI
OFF	00:00	00:00	30	BEST	Q-FI
TIMER ENABLE : ON					

6. MODE

There are three record mode settings : QUAD-FRAME, QUAD-FIELD, FULL-FIELD.

7. TIMER ENABLE

After sets up the recording timer, you can enable or disable timer recording function., when TIMER ENABLE is “ON”, press “menu” button then you can see the timer setting diagram by your setting.

1ST	00--05	06--11	12--17	18--23
MON	☐☐☐☐☐☐	☐☐☐☐☐☐	☐☐☐☐☐☐	☐☐☐☐☐☐
TUE	☐☐☐☐☐☐	☐☐☐☐☐☐	☐☐☐☐☐☐	☐☐☐☐☐☐
WED	☐☐☐☐☐☐	☐☐☐☐☐☐	☐☐☐☐☐☐	☐☐☐☐☐☐
THU	☐☐☐☐☐☐	☐☐☐☐☐☐	☐☐☐☐☐☐	☐☐☐☐☐☐
FRI	☐☐☐☐☐☐	☐☐☐☐☐☐	☐☐☐☐☐☐	☐☐☐☐☐☐
SAT	☐☐☐☐☐☐	☐☐☐☐☐☐	☐☐☐☐☐☐	☐☐☐☐☐☐
SUN	☐☐☐☐☐☐	☐☐☐☐☐☐	☐☐☐☐☐☐	☐☐☐☐☐☐
2ST	00--05	06--11	12--17	18--23
MON	☐☐☐☐☐☐	☐☐☐☐☐☐	☐☐☐☐☐☐	☐☐☐☐☐☐
TUE	☐☐☐☐☐☐	☐☐☐☐☐☐	☐☐☐☐☐☐	☐☐☐☐☐☐
WED	☐☐☐☐☐☐	☐☐☐☐☐☐	☐☐☐☐☐☐	☐☐☐☐☐☐
THU	☐☐☐☐☐☐	☐☐☐☐☐☐	☐☐☐☐☐☐	☐☐☐☐☐☐
FRI	☐☐☐☐☐☐	☐☐☐☐☐☐	☐☐☐☐☐☐	☐☐☐☐☐☐
SAT	☐☐☐☐☐☐	☐☐☐☐☐☐	☐☐☐☐☐☐	☐☐☐☐☐☐
SUN	☐☐☐☐☐☐	☐☐☐☐☐☐	☐☐☐☐☐☐	☐☐☐☐☐☐

CAMERA

1. TITLE

Assign a title to each camera. Initially each title is the camera's number.

2. ALARM

Select LOW / OFF / HIGH for alarm polarity. The default value is LOW.

TITLE	ALARM	REC	BR	CT	CL	HUE
CAMERA 1	LOW	ON	18	15	15	18
CAMERA 2	OFF	OFF	18	15	15	18
CAMERA 3	HIGH	OFF	18	15	15	18
CAMERA 4	HIGH	ON	18	15	15	18

(MENU)
 TIMER
CAMERA
 RECORD
 ALARM
 DWELL
 PIP
 MOTION
 DISPLAY
 REMOTE
 USER
 SYSTEM
 EVENT

3. RECORD (REC)

Set up which channel you want to record.

ON : when alarm input is triggered, DMR will record alarming channel more frequently.

For example : when CH01 is triggered, the record method will become 1-2-1-3-1-4....

OFF : DMR will not record.

4. BRIGHTNESS (BR)

Have a video bright adjustment of each channel. The level is from 0 to 63.

5. CONTRAST (CT)

Have a video contrast adjustment of each channel. The level is from 0 to 63.

6. COLOR (CL)

Have a video color contrast adjustment of each channel. The level is from 0 to 63.

7. HUE (HUE)

Have a video hue adjustment of each channel. The level is from 0 to 63.

RECORD

1. RECORD IPS

Select the images per second of recording. The options are as following :

NTSC—30、15、8、4、2、1

PAL—25、12、6、3、2、1

2. QUALITY

There are four quality settings : BASIC, BEST, HIGH, NORMAL.

NOTE : The relationship of Record time, IPS and record quality, please refer to page.26 Recording Speed.

3. RECORD MODE

There are three record mode settings : QUAD-FRAME, QUAD-FIELD, FULL-FIELD.

(MENU)
 TIMER
 CAMERA
RECORD
 ALARM
 DWELL
 PIP
 MOTION
 DISPLAY
 REMOTE
 USER
 SYSTEM
 EVENT

(RECORD)
RECORD IPS 30
 QUALITY NORMAL
 RECORD MODE QUAD-FRAME

ALARM

1. ALARM ENABLE

To set the ALARM ENABLE. It will be triggered by event occurrence when the setting is ON.

2. ALARM DURATION

Set the reaction time which was determined by how long the alarm mode responded to a buzzer. Default setting is 10 sec. Options are 10 SEC, 15 SEC, 20 SEC, 30 SEC, 1 MIN, 2 MIN, 3 MIN, 5 MIN, 10 MIN, 15 MIN, 30 MIN, ALWAYS, AUTO.

3. REC IPS

Select the images per second of recording during an ALARM. The options are as following:
 NTSC—30、15、8、4、2、1
 PAL—25、12、6、3、2、1

4. QUALITY

There are four quality settings during an ALARM : BASE, BEST, HIGH, NORM.

5. RECORD MODE

There are three record mode settings : QUAD-FRAME, QUAD-FIELD, FULL-FIELD.

(MENU)
TIMER
CAMERA
RECORD
ALARM
DWELL
PIP
MOTION
DISPLAY
REMOTE
USER
SYSTEM
EVENT

(ALARM)

ALARM ENABLE	YES
ALARM DURATION	15 MIN
RECORD IPS	30
QUALITY	NORMAL
RECORD MODE	QUAD-FRAME

DWELL

1. NORM

To set up the DWELL time period that each channel auto sequentially shows on call monitor. The level is from 1 to 15 SEC or OFF.

2. ALARM

To set up the DWELL time period when alarm input is triggered. The level is from 1 to 15 SEC or OFF.

(DWELL)

	NORM	ALARM
CAM1	01	01
CAM2	01	01
CAM3	01	01
CAM4	01	01

(MENU)
TIMER
CAMERA
RECORD
ALARM
DWELL
PIP
MOTION
DISPLAY
REMOTE
USER
SYSTEM
EVENT

PIP

1. FULL SCREEN

To set up the full screen background picture display.

2. PIP SCREEN

To set up the picture with a 1/9 size screen "insert".

3. POSITION

There are six position settings : D/L, D/M, D/R, U/L, U/M, U/R.

(PIP)

FULL SCREEN	CAM 1
PIP SCREEN	CAM 2
POSITION	D/R

(MENU)
TIMER
CAMERA
RECORD
ALARM
DWELL
PIP
MOTION
DISPLAY
REMOTE
USER
SYSTEM
EVENT

MOTION

1. SEN (Sensitivity)

Sets the sensitivity of the Pixel-based Motion Detection feature from 1 to 70.

2. MD-NVM

Sets the number of targets in which Motion must occur in order to trigger an Alarm (from 1-99 target areas).

Note: MD-NVM cannot be less than the number of targets set in the AREA.

3. RE

Sets the Reference image to which the current screen is compared (from 1-99). For example, the value 64 would compare the current image to the 64th previous screen image.

4. DET

The motion detection on each channel setup can be turned to ON or OFF individually.

5. AREA

Press the ENTER button on this option to set the Pixel-based Motion Detection Area for each channel. Green targets represent the Motion Detection Area (Figure 1-2), and Purple targets represent motion currently taking place (Figure 1-3).

To modify the Motion Detection Area, use the following controls:

+ : turns the selected target ON/OFF.

▲▼◀▶ : navigates between targets

- : turns all targets on the screen ON/OFF

Zoom: turns all targets in the selected row ON/OFF



6. MOTION RECORD

When the DET setting is "ON", you can set up the MOTION RECORD function,

1. Select "ON" to set up the motion trigger record: It can automatically switch to Record Mode. The motion detection will change the scanning sequence and shows  on the monitor.

NOTE: The trigger recording time will depend on ALARM DURATION mode setting (Please refer to page.11 for ALARM DURATION) and it will record from the last trigger time. For example, when the alarm duration setting is 1 min, the recording time is from 9:00:00 to 9:01:00. If the motion detection triggered again at 9:00:40, the triggered recording time will from 9:00:00 to 9:00:40 and 9:00:40 to 9:01:40. The total recording time is 00:01:40.

2. Select "OFF": The screen still shows  and if it is in record mode, the motion detection will change the scanning sequence.

For example : If the motion is detected on Camera #1, its recording & scanning sequence will be more frequently. The sequence will be as 1st, 2nd, 1st, 3rd, 1st, ... 4th. And channel 1 will show  on the screen. If 2nd camera and 3rd camera both motion detection are activated, they will be scanning as 2st, 3rd, 1st, 2nd, 3rd, 4th, 2nd, 3rd, 1st, 2nd, 3rd, 4th ... and vice versa. And CH2 & CH3 will show  for a period of time which is same as Alarm Duration time.

(MENU)
TIMER
CAMERA
RECORD
ALARM
DWELL
PIP
MOTION
DISPLAY
REMOTE
USER
SYSTEM
EVENT

(MOTION)					
	SEN	MD-NVM	RE	DET	AREA
CAM1	70	03	64	ON	AREA
CAM2	70	03	64	OFF	AREA
CAM3	70	03	64	ON	AREA
CAM4	70	03	64	ON	AREA

MOTION RECORD : ON		
DAY	START	END
DAILY	00 : 00	00 : 00

7. DAY / START / END

To setup the DAY and the START/ END time for motion trigger recording timer setting.

Figure 1-1

MOTION DETECTION SETUP

	1	2	3	4	5	6	7	8	9	10	11	12	13	14	15	16
1																
2																
3																
4																
5						■										
6																
7																
8																
9																
11																
12																

Figure 1-2

MOTION DETECTION SETTING — ROW SETUP

	1	2	3	4	5	6	7	8	9	10	11	12	13	14	15	16
1																
2					■	■	■									
3					■	■	■									
4					■	■	■									
5	■	■	■	■	■	■	■	■	■	■	■	■	■	■	■	■
6																
7																
8																
9																
11																
12																

Figure 1-3

MOTION DETECTION TRIGGERED-TURN INTO PURPLE

	1	2	3	4	5	6	7	8	9	10	11	12	13	14	15	16
1																
2						■	■	■								
3						■	■	■								
4						■	■	■								
5	■	■	■	■	■	■	■	■	■	■	■	■	■	■	■	■
6																
7																
8																
9																
11																
12																

Figure 1-4

BACK TO MOTION DETECTION SETTING

	1	2	3	4	5	6	7	8	9	10	11	12	13	14	15	16
1																
2						■	■	■								
3						■	■	■								
4						■	■	■								
5	■	■	■	■	■	■	■	■	■	■	■	■	■	■	■	■
6																
7																
8																
9																
11																
12																

DISPLAY

1. TITLE DISPLAY

To set the title shown on monitor or not.

2. OSD COLOR

Select the OSD (On screen display) color. The options are YELLOW, WHITE, GREEN, BLACK, BLUE, RED, PINK, CYAN.

3. BORDER TYPE

To set the BORDER TYPE on screen display.
The options are 8/4, 4/2, 2/1 or OFF.

4. BORDER COLOR

Select the BORDER COLOR. The options are YELLOW, WHITE, GREEN, BLACK, BLUE, RED, PINK, CYAN.

(MENU)
TIMER
CAMERA
RECORD
ALARM
DWELL
PIP
MOTION
DISPLAY
REMOTE
USER
SYSTEM
EVENT

5. LOSS SCREEN

Retain the last picture or select the LOSS SCREEN color.

The options are GREEN, BLACK, BLUE.

6. OSD POSITION

To set the OSD POSITION shown on monitor.

The options are NORMAL or CENTER.

(DISPLAY)	
TITLE DISPLAY	YES
OSD COLOR	YELLOW
BORDER TYPE	4/2
BORDER COLOR	WHITE
LOSS SCREEN	GREEN
OSD POSITION	NORMAL

REMOTE

1. REMOTE MODE

Set the remote mode for connection with computer via RS-232 or RS-485.

(Please refer to page. 23 for RS-232 Remote Control).

2. BAUD RATE

Set the remote protocol transmitting baud rate. Available options are 115200, 57600, 19200, 9600, 4800, 3600, 2400, 1200.

3. ID

To control different DMR by setting remote protocol. ID number can be set from 000 to 255.

(MENU)
TIMER
CAMERA
RECORD
ALARM
DWELL
PIP
MOTION
DISPLAY
REMOTE
USER
SYSTEM
EVENT

(REMOTE)	
REMOTE MODE	RS-485
BAUD RATE	9600
ID	255

USER

1. USER

To set up the user account for controlling. It allows 8 users setting.

Supervisor – Control all the functions.

Other User – Review all functions except the menu setting and event list cleaning.

2. PASSWORD

To set the security password for each account. The maximum length of user password is 4 characters.

(MENU)
TIMER
CAMERA
RECORD
ALARM
DWELL
PIP
MOTION
DISPLAY
REMOTE
USER
SYSTEM
EVENT

(USER)	
	PASSWORD
SUPERVISOR	0000
USER 1	0000
USER 2	0000
USER 3	0000
USER 4	0000
USER 5	0000
USER 6	0000
USER 7	0000

EVENT

A single page can display 16 recorded events. Press “◀” or “▶” to change the pages or press ▲ + ▼ to CLEAR the EVENT record.

DISK FULL: HDD is full

PWR REST : Power restored

M-HD REMS: HDD remove

M-HD REPL: HDD replace

M-HD ERR : HDD error

M-HD WARM: HDD warning

K UNLOCKS: Key is unlock

DMA ERROR: DMA error

C1 VLOSS : Camera 1 is video loss

C2 ALARM : Camera 2 has been triggered by external I/O alarm

C3 MOTION: Camera 3 has been triggered by motion detection

SYSTEM ERROR: System might fail

CAM 2 VLOSS: Channel: 2 Video loss

CAM 3 ALARM: Channel: 3 External I/O Alarm have triggered

POWER RESTORE : Power restored

(MENU)
TIMER
CAMERA
RECORD
ALARM
DWELL
PIP
MOTION
DISPLAY
REMOTE
USER
SYSTEM
EVENT

C1 VLOSS	26-DEC-2002	03:00:00
C2 ALARM	26-DEC-2002	03:00:00
K UNLOCKS	26-DEC-2002	03:00:00
M-HD ERR	26-DEC-2002	03:00:00
M-HD WARM	26-DEC-2002	03:00:00
PWR REST	26-DEC-2002	03:00:00
PMA ERROR	26-DEC-2002	03:00:00
M-HD REPL	26-DEC-2002	03:00:00
↑ + ↓ : CLEAN		

OPERATION OPTIONS

ZOOM

Press ZOOM button to enlarge the display of main picture. It displays zoomed picture on main picture and a small window inserted. The inserted window contains a movable 1/4 view size of the appointed camera. The range is from 2X to 4X.

- Press PIP : Zoom in
- Press QUAD : Zoom out
- Press the "Zoom" button again to leave the zoom pointer.
- Press Camera (1-4) to select channel.
- Press ▲▼◀▶ to move the zoom position.

VIDEO LOSS

Screen will display 'LOSS' in the center of display picture, if the video input is not connected properly.





SEARCH

1. LAST RECORD

Play the last recorded piece of video.

2. FULL LIST

List all recorded video on the HDD which sorted by time.

-  : Motion Recording
-  : Manual Recording
-  : Alarm Recording
-  : Timer Recording
- M : Storage in Master HDD
- S : Storage in Slave HDD

NOTE: It will display different color on each record list mention above.

3. ALARM LIST

List all recorded video triggered by an Alarm.

NOTE : If there are no Alarm in the record, the screen will display "EMPTY".

4. MOTION LIST







List all motion triggered records.

5. TIME SEARCH

Find video recorded on a specific date that is entered.

LAST RECORD

FULL LIST
ALARM LIST
MOTION LIST
TIME SEARCH

	2003-JAN-01	01:02:03	M
	2003-JAN-05	05:02:03	M
	2003-MAR-12	04:02:03	M
	2003-APR-02	03:02:04	M
	2003-MAY-01	05:02:03	M
	2003-AUG-09	01:02:01	M

← : PAGE UP → : PAGE DOWN

KEY LOCK

For advanced security, you can “Lock” the buttons on your DMR. Key-Lock prevents other people from using the system.

Press ENTER and MENU at the same time to enable Key Lock.

Press ENTER and MENU at the same time and key in password (Default : 0000), then press “ENTER” to disable Key Lock.

RS-232 REMOTE PROTOCOL

You can use the PC keyboard to simulate DMR keypad.

DATA: REMOTE PROTOCOL using 8 bit data · 1 start bit · 1 stop bit

FUNCTION	CODE	ASCII	FUNCTION	CODE	ASCII
KEY_MENU	0x4D	M	KEY_PLAY	0x50	P
KEY_SEARCH	0x73	s	KEY_DOWN	0x4E	N
KEY_ENTER	0x0D	ENTER	KEY_RIGHT	0x52	R
KEY_QUAD	0x51	Q	KEY_POWER	0x57	W
KEY_ZOOM	0x5A	Z	KEY_KEY_LOCK	0x4B	K
KEY_PIP	0x70	p	KEY_CH1	0x31	1
KEY_SLOW	0x53	S	KEY_CH2	0x32	2
KEY_REC	0x72	r	KEY_CH3	0x33	3
KEY_LEFT	0x4C	L	KEY_CH4	0x34	4
KEY_UP	0x55	U	TIMER REC PROCEED	0X54	T

TROUBLESHOOTING

When malfunction occurs, it may be not serious and can be corrected easily. The table below describes some typical problems and their solutions. Please check them before calling your DMR dealer.

PROBLEM	SOLUTION
No power	I Check power cord connections.
	I Confirm that there is power at the outlet.
Not working when press any button	I Check if it is under Key Lock mode.
	I Press " MENU " & " ENTER " to exist Key Lock mode.
No recorded video	I Check if the HDD is installed properly.
Timer Record enable does not working	I Check if the Record Enable is set to YES
No live video	I Check camera video cable and connections.
	I Check monitor video cable and connections.
	I Confirm that the camera has power.
	I Check camera lens setting.

SPECIFICATIONS

Video format	NTSC/EIA or PAL/CCIR
Hard disk storage	IDE type, UDMA 66, supported 200 GB HDD
Record mode	Manual / Alarm / Timer / Motion
Camera Input Signal	Composite video signal 1 Vp-p 75 Ω BNC, 4 channels
Camera Loop Back	Composite video signal 1 Vp-p 75 Ω BNC, 4 channels
Main Monitor Output	Composite video signal 1 Vp-p 75 Ω BNC
Call Monitor Output	Composite video signal 1 Vp-p 75 Ω BNC
Audio input	4 audio inputs, (RCA) *
Audio output	2 audio outputs, (RCA) **
Motion Detect Area	16 * 12 targets per camera
Motion Detect Sensitivity	99 Levels
Video Loss Detection	Yes
Refresh Rate	Up to 240 images/sec. for NTSC / 200 images/sec. for PAL
Recording Rate	Up to 30 images/sec. for NTSC / 25 images/sec. for PAL
Dwell Time	Programmable (1~15 Sec)
Picture in Picture	Yes (Movable)
Key Lock	Yes
Picture Zoom	2*2 ~4*4 (Movable)
Camera Title	8 letters
Video Adjustable	Hue/ Color/ Contrast/ Brightness Adjustable
Alarm Input	TTL input, Hi (5V), Low (GND)
Alarm Output	COM./N.O./N.C
Remote Control	RS-232 or RS-485
Time Display Format	YY/MM/DD, DD/MM/YY, MM/DD/YY, OFF
Power Source	AC90~220V, 47Hz~63Hz
Power Consumption	<32W
Operation Temperature	10 ~ 40 $^{\circ}$ C
RS-232C / RS-485 (bps)	115200、57600、19200、9600、4800、3600、2400、1200
Dimension (mm)	343(W) x 223(L) x 59(H)
Net Weight	2.05 kgs

• Specifications are subject to change without notice.

* 4 audio inputs, can select only 1 during operation for recording

** with 2 mono audio outputs from the same source.

APPENDIX #1 – INSTALLING the HDD

Follow the steps carefully in order to ensure correct installation.

The compartment located on the front panel of the DMR is the removable Cartridge, in which you insert the HDD. The various parts of the Cartridge are labeled for your reference.

1.Remove the Cartridge from the DMR

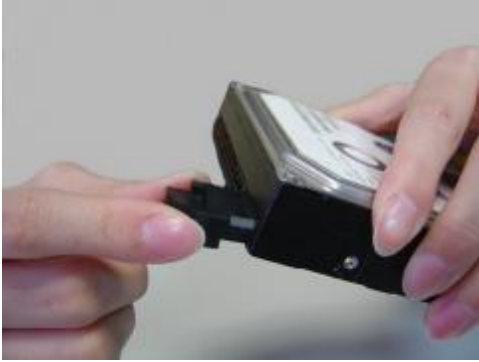

Step 1

Remove the Cartridge from the DMR.



Step 2

Put HDD into the HDD cartridge.

Please notice the bottom side is power side as chart shows.



Step 3

Screw the HDD to the cartridge. Please be aware that the screw hole is different from different brands HDD.

For example, for Western Digital, it is to the right side; for IBM and Maxtor, it is to the left side.

APPENDIX #2 – PIN CONFIGURATIONS

15 pin com port

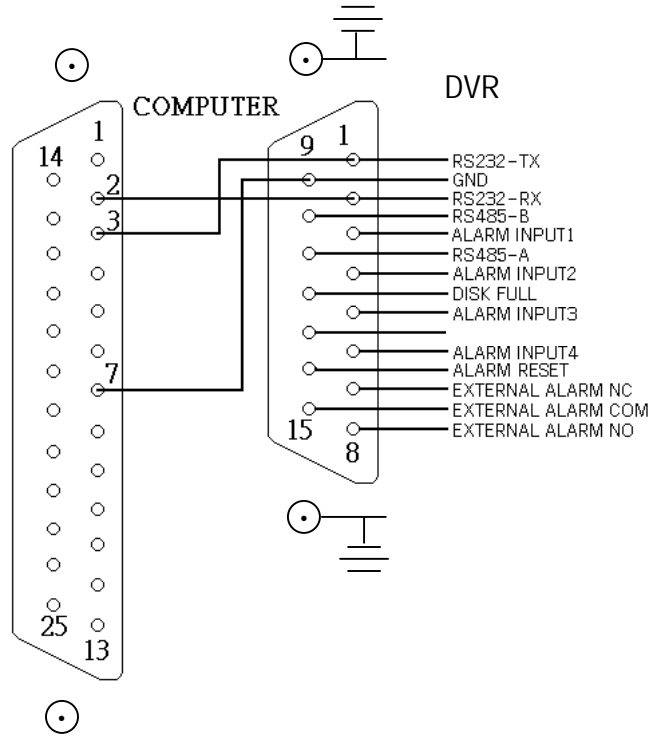

9 pin com port

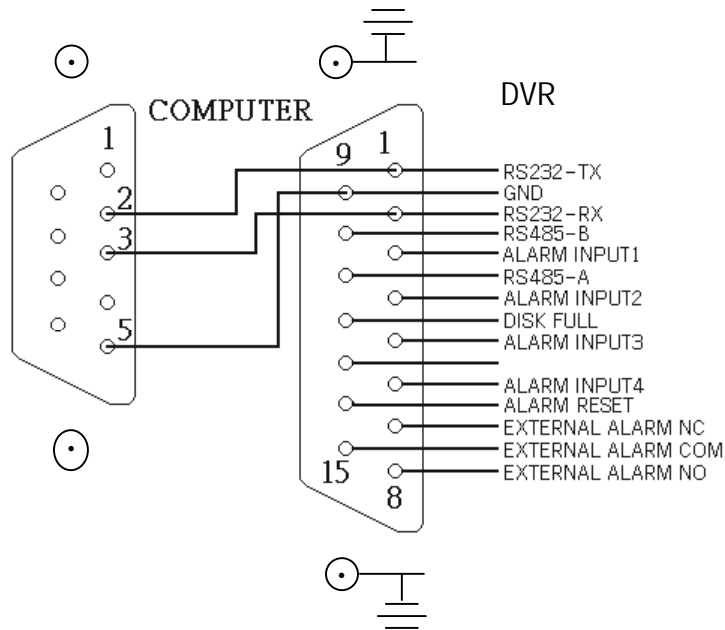

PIN 1. RS232-TX : RS-232

DQR can be controlled remotely by an external device or control system, such as a control keyboard, using RS-232 serial communications signals.

PIN 2. RS232-RX : RS232

DQR can be controlled remotely by an external device or control system, such as a control keyboard, using RS-232 serial communications signals.

PIN 3, 4, 5, 6 ALARM INPUT

To connect wire from ALARM INPUT (PIN 3, 4, 5, 6) to GND (PIN 9) connector, DQR will start recording and buzzer will be on. When alarm has been triggered, signal becomes "Low", and it will stop all alarm activities. Under normal operation, signal remains "High".

PIN 7. EXTERNAL ALARM NC

Under normal operation COM connect with NC and disconnect with NO. But when alarm triggered, COM disconnect with NC, and connect with NO.

PIN 8. EXTERNAL ALARM NO

Under normal operation, COM will disconnect from NO. But when Alarm triggered, COM will connect with NO.

PIN 9. GND

GROUND

PIN 10. RS485-B

DQR can be controlled remotely by an external device or control system, such as a control keyboard, using RS485 serial communications signals.

PIN 11. RS485-A

DQR can be controlled remotely by an external device or control system, such as a control keyboard, using RS485 serial communications signals.

PIN 12. DISK FULL (OUTPUT)

When HDD is full, it sends a signal to trigger next DQR record mode, if you install another DQR. Under normal operation, the signal remains "High". But when disk full, DQR will send the "Low" signal.

PIN 14. ALARM RESET (INPUT)

To connect wire from ALARM RESET (PIN 14) to GND (PIN 9) connector, it can disable ALARM. An external signal to ALARM RESET (PIN 14) can be used to reset both ALARM OUTPUT signal and DQR's internal buzzer. When alarm has been triggered, signal becomes "Low", and it will stop all alarm activities. Under normal operation, signal remains "High".

PIN 15. EXTERNAL ALARM COM

Under normal operation COM connect with NC and disconnect with NO. But when alarm triggered, COM disconnect with NC, and connect with NO.

APPENDIX #4 – RECORDING SPEED

The Record Time is different based on Record Speed and Record Quality. Please refer to following table.

NTSC SYSTEM

IPS		30	15	8	4	2	1
Record Quality	Best	48hr	96hr	180hr	360hr	750hr	1440hr
	High	60hr	120hr	226hr	450hr	937hr	1800hr
	Normal	96hr	192hr	360hr	750hr	720hr	2880hr
	Basic	160hr	320hr	600hr	1250hr	1200hr	4800hr
HDD Type		240 GB					

PAL SYSTEM

IPS		25	12	6	3	2	1
Record Quality	Best	48hr	100hr	202hr	406hr	608hr	1216hr
	High	60hr	126hr	254hr	506hr	760hr	1520hr
	Normal	98hr	202hr	406hr	810hr	1216hr	2440hr
	Basic	162hr	336hr	676hr	1350hr	2026hr	4050hr
HDD Type		240 GB					

Note: Above data is obtained from actual test of recording normal TV program. (For Reference Only)