 <div style="display: inline-block; background-color: black; color: white; padding: 5px; text-align: center; font-weight: bold; font-size: 1.2em;">CAUTION</div> 
<p>RISK OF ELECTRIC SHOCK DO NOT OPEN</p>
<p>CAUTION: TO REDUCE THE RISK OF ELECTRIC SHOCK, DO NOT REMOVE COVER (OR BACK). NO USER - SERVICEABLE PARTS INSIDE. REFER SERVICING TO QUALIFIED SERVICE PERSONNEL.</p>

CAUTION:
TO PREVENT ELECTRIC SHOCK, MATCH WIDE BLADE OF PLUG TO WIDE SLOT, FULLY INSERT.

ATTENTION:
POUR ÉVITER LES CHOCS ÉLECTRIQUES, INTRODUIRE LA LAME LA PLUS LARGE DE LA FICHE DANS LA BORNE CORRESPONDANTE DE LA PRISE ET POUSSER JUSQU' AU FOND.



The lightning flash with arrowhead symbol, within an equilateral triangle, is intended to alert the user to the presence of uninsulated "dangerous voltage" within the product's enclosure that may be of sufficient magnitude to constitute a risk of electric shock to persons.



The exclamation point within an equilateral triangle is intended to alert the user to the presence of important operating and maintenance (servicing) instructions in the literature accompanying the appliance.

"WARNING"

"TO REDUCE THE RISK OF FIRE OR ELECTRIC SHOCK, DO NOT EXPOSE THIS APPLIANCE TO RAIN OR MOISTURE."

SAFETY INSTRUCTIONS

1. Read Instructions - All the safety and operating instructions should be read before the appliance is operated.
2. Retain Instructions - The safety and operating instructions should be retained for future reference.
3. Heed Warnings - All warnings on the appliance and in the operating instructions should be adhered to.
4. Follow Instructions - All operating and use instructions should be followed.
5. Water and Moisture - The appliance should not be used near water - for example, near a bathtub, washbowl, kitchen sink, laundry tub, in a wet basement, or near a swimming pool, and the like.
6. Carts and Stands - The appliance should be used only with a cart or stand that is recommended by the manufacturer.



An appliance and cart combination should be moved with care. Quick stops, excessive force, and uneven surfaces may cause the appliance and cart combination to overturn.

7. Wall or Ceiling Mounting - The appliance should be mounted to a wall or ceiling only as recommended by the manufacturer.
8. Ventilation - The appliance should be situated so that its location or position does not interfere with its proper ventilation. For example, the appliance should not be situated on a bed, sofa, rug, or similar surface that may block the ventilation openings; or, placed in a built-in installation, such as a bookcase or cabinet that may impede the flow of air through the ventilation openings.
9. Heat - The appliance should be situated away from heat sources such as radiators, heat registers, stoves, or other appliances (including amplifiers) that produce heat.
10. Power Sources - The appliance should be connected to a power supply only of the type described in the operating instructions or as marked on the appliance.
11. Grounding or Polarization - The precautions that should be taken so that the grounding or polarization means of an appliance is not defeated.

12. Power Cord Protection - Power supply cords should be routed so that they are not likely to be walked on or pinched by items placed upon or against them, paying particular attention to cords at plugs, convenience receptacles, and the point where they exit from the appliance.
13. Cleaning - The appliance should be cleaned only as recommended by the manufacturer.
14. Nonuse Periods - The power cord of the appliance should be unplugged from the outlet when left unused for a long period of time.
15. Object and Liquid Entry - Care should be taken so that objects do not fall and liquids are not spilled into the enclosure through openings.
16. Damage Requiring Service - The appliance should be serviced by qualified service personnel when:
 - A. The power supply cord or the plug has been damaged; or
 - B. Objects have fallen, or liquid has been spilled into the appliance; or
 - C. The appliance has been exposed to rain; or
 - D. The appliance does not appear to operate normally or exhibits a marked change in performance; or
 - E. The appliance has been dropped, or the enclosure damaged.
17. Servicing - The user should not attempt to service the appliance beyond that described in the operating instructions. All other servicing should be referred to qualified service personnel.
18. The appliance should be situated away from drops of water or spray of water.
19. Objects containing liquid such as vase must not be put on the appliance.
20. The appliance is not completely isolated from the power supply even if the power switch is at off position.
21. Apparatus shall not be exposed to dripping or splashing and no objects filled with liquids, such as vases, shall be placed on the apparatus.
22. Only use attachments/accessories specified by the manufacturer.
23. An appliance with a protective earth terminal should be connected to a mains outlet with a protective earth connection.
24. An appliance should be placed in a position where an AC plug / inlet can be easily pulled out by hand.
25. Main plug is used as the disconnection device. It shall remain readily operable and should not be obstructed during intended use. To be completely disconnected the apparatus from supply mains, the mains plug of the apparatus shall be disconnected from the mains socket outlet completely.

Contents

Package contents	5
Recording media	5
Preparation for the current drive	6
Installing a hard disk in the caddy	6
Formatting a hard disk drive	9
Checking the available recording time (REMAIN) on a formatted disk	11
Setup of the Internal Clock	12
Connecting a analog mixer	13
Connecting a digital mixer	14
Initial settings	15
About Sampling Frequency	15
Basic recording	16
Basic analog recording	16
Undo and redo recording (single undo/redo)	17
Basic digital recording	18
Multitrack recording using overdubbing	20
Ping-pong recording	20
Mlxdown	21
Basic Locate function	21
Recording in a new Program	22
Changing the program FS	23
Playback using the Vari-pitch function	24

<Recording media>

The D2424LVmkII is not equipped with recording media for recording and playback. Please read the section from page 5 to prepare the recording media to record, playback, and edit data on the recorder.

<Damages>

Fostex is not responsible for any direct or consequential damages caused by operating the recorder and/or a connected E-IDE hard disk.

<Copyrights>

It is prohibited by law to use materials recorded on the recorder from music CDs and/ or video tapes for which copyrights belong to a third party for commercial contents, broadcasts, sales, and/ or distribution, except for your personal entertainment.

Package contents

Make sure that the package contains all the items listed below. The illustrations may not precisely match the appearance of the actual items. If you find that items are missing, contact your local dealer.

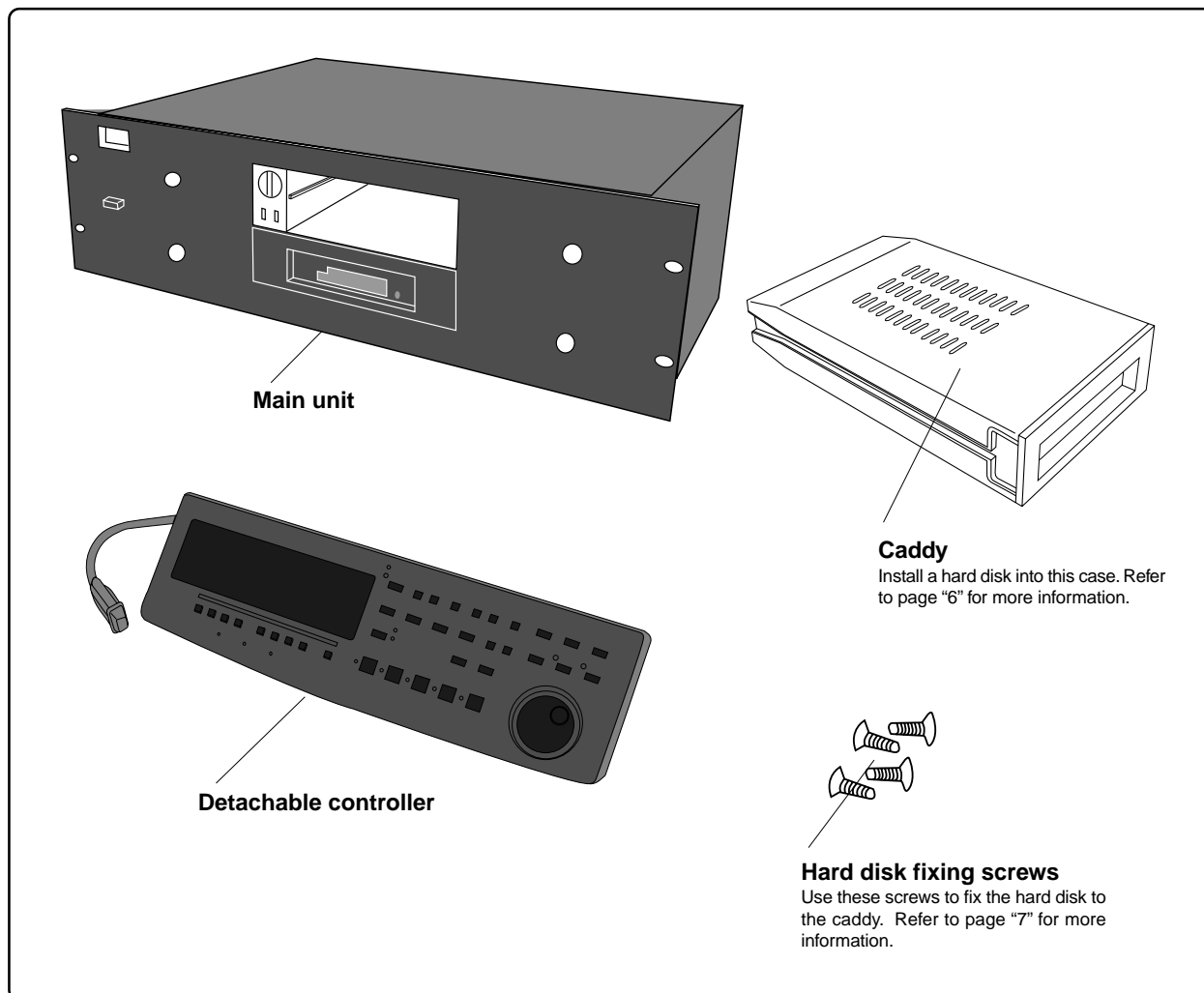

Recording media

The D2424LVmkII is not equipped with any recording medium for recording/playback such as a hard disk drive (in this manual, we call the installed medium "**current drive**"). Therefore, to execute the multitrack recording using the D2424LVmkII, you have to separately prepare a current drive.

For a current drive, you can use any universal "E-IDE" hard disk drive* which has been tested and approved by FOSTEX. A hard disk drive can be installed in the removable case attached.

<OPERATION CONFIRMED HD & BACKUP MEDIA LIST for FOSTEX D2424LVmkII>

The updated information on the operation-confirmed HD and backup media for D2424LVmkII is mentioned in the following Fostex international web site.

<<http://www.fostexinternational.com>>

For those who are not able to check our web site, please contact Fostex distributor in your territory.

Preparation for the current drive

The D2424LVmkII has a slot for an optional hard disk. First you need to install a hard disk into the caddy included in this recorder package before you install it into the slot.

The following instructions assume that you have already purchased an E-IDE hard disk unit. Prepare the following items for hard disk installation:

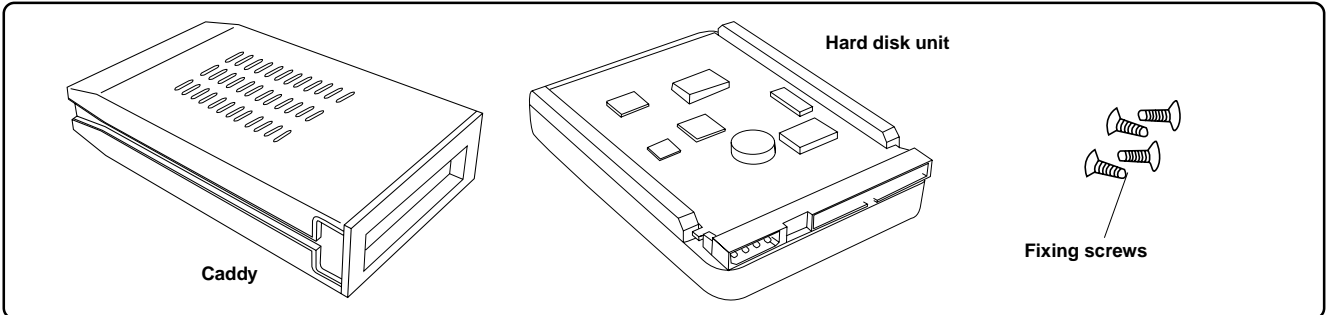

<Note>

Be sure to turn off the power to the D2424LVmkII (or remove the power cable from the AC outlet) before installing a hard disk.

Installing a hard disk in the caddy

First, you need to disassemble the caddy included in the package so that you can install a hard disk into it.

• Disassembling the caddy

1. Apply your thumb to the edge of the case on the connector side as shown in the figure, and slightly pull the cover in the direction of the arrow.
2. Apply your thumbs to the side of the case and open the cover. In the same manner, open the cover on the other side. (Caution: Be careful not to pinch your fingers.)

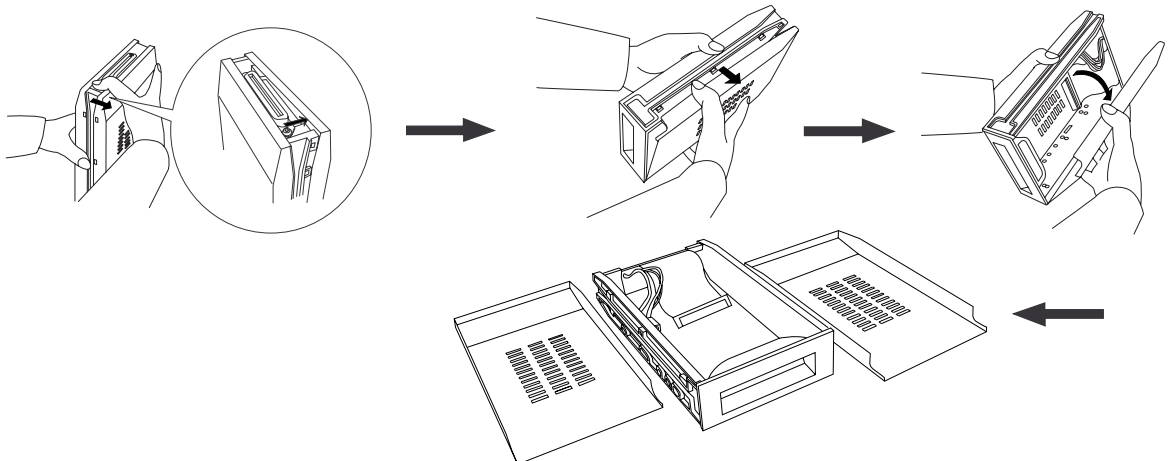

<Notes on handling a hard disk>

- A hard disk is a high-precision device. Do not apply any impact to the disk when and after you install it in the caddy. Do not leave the disk near a device that generates a strong magnetic field. Choose a level and stable surface for installation. Be careful not to injure yourself.
Fostex is not liable for any malfunction or damage to the hard disk caused by mishandling.
- You need to set the DIP (Jumper) switch on the hard disk to "Master" before you install it into the caddy. If the switch is set to "Slave," the hard disk will not function correctly. Refer to the instruction manual that came with your hard disk for more information on the DIP (Jumper) switch setting.

• Connecting cables

1. Connect the cables in the caddy to the connectors on the rear of the hard disk.

As shown in the figure, first connect the power supply cable. Make sure that you connect the cables securely in the correct direction.

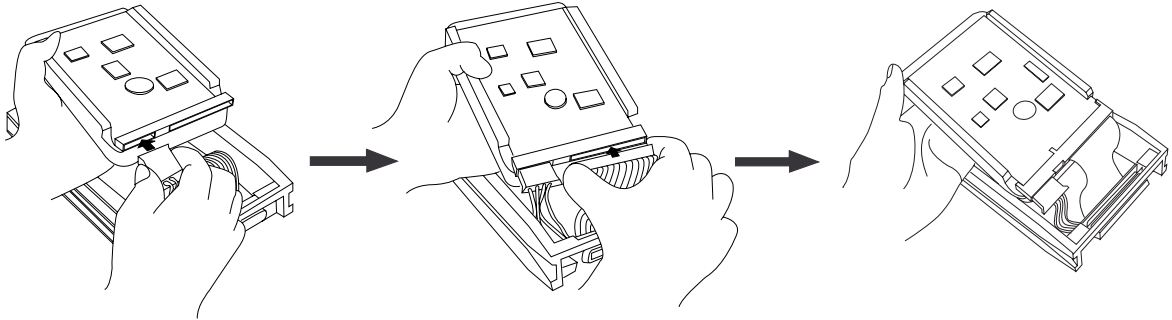

<Note on the connectors>

Some connectors on the hard disks may be too tight to connect cables easily. Do not apply excessive force to such connectors to avoid injury or damage to the hard disk.

• Fixing the hard disk to the case

1. Align the screw holes.

As shown in the figure, align the screw holes on the side of the disk with the holes on the case.

2. Insert four included fixing screws (two screws on each side) and tighten them.

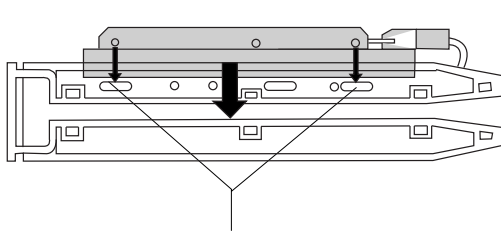

Align the screw holes on the other side of the hard disk with the holes on the case.

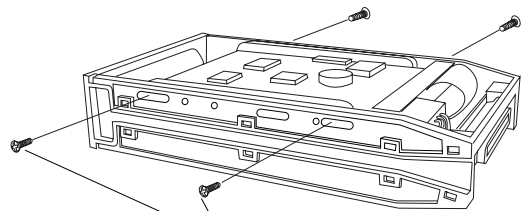

Tighten four screws (two on each side).

<Note on tightening the screws>

Do not tighten the screws too much. Otherwise, you may damage the case.

• Assembling the case

<Note>

When you assemble the case, follow the note below:

If a projecting part on the hard disk touches the cover, apply the insulation seal (included in the package) to the surface of the case where the part would touch. If you use the disk with its part touching the cover, a short-circuit may occur, leading to a malfunction.

1. Assemble the case by installing the covers.

After you assemble the case, store the case in a place not subject to magnetic fields.

If you remove the case from the recorder and store or move the unit, cover the connectors on the caddy with the dust cover (included in the package) to protect the hard disk from building up static electricity and dust.

Do not touch the connectors with your fingers to avoid static electricity.

• **Installing the removable case in the recorder**

1. **Install the caddy (containing a hard disk inside) into the slot.**
Push in the case with the correct side facing toward you. (Use both hands to push it in so that the surface of the case and the front panel become flush.)
2. **Use the coin to lock the caddy.**

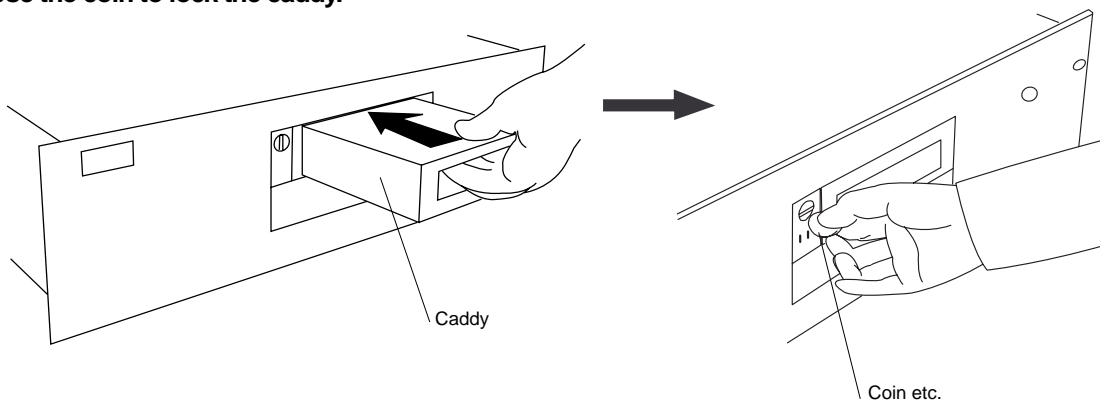

<CAUTION>
*Do not forget to lock the caddy installed into the slot.
When locking or unlocking the caddy with the coin, make sure that the recorder's power is off.*

• **Connecting a detachable controller**

1. **Attach a detachable controller (included) to the hooks on the front panel.**
2. **Securely insert the controller's connector cable to the connector on the front panel.**
Instead of using the controller, you may use an optional extension cable (Model 8551B).
Consult your dealer for more information.

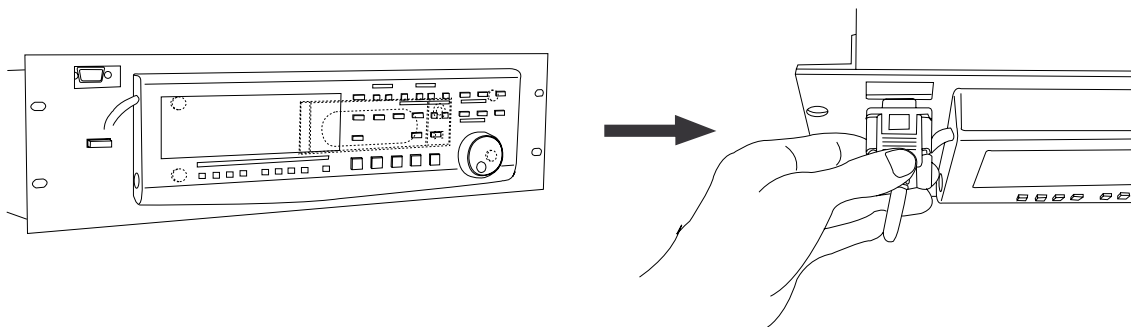

Model 8551B Optional extension cable
Consult the dealer you purchased the recorder from or our sales office about information on the extension cable.

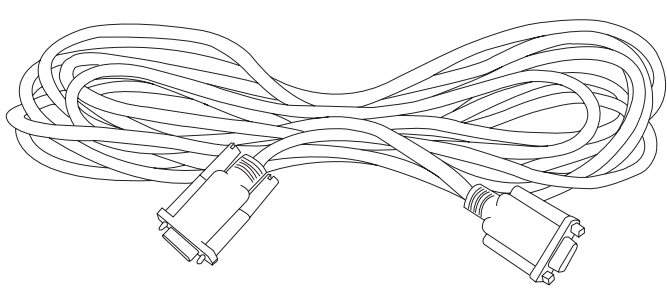
A line drawing of a coiled extension cable with two connectors. One connector is a multi-pin D-sub connector, and the other is a different type of multi-pin connector.

Formatting a hard disk drive

After installing a hard disk drive into the recorder, you must format the disk; otherwise you cannot record or playback any data. Note that the following explanation assumes that the disk is unformatted. If you want to know how to reformat a formatted disk, see the Reference manual.

<CAUTION>
 Be sure to connect the recorder to the power supply specified in the specification section of the Reference manual. Do not use an AC outlet of any other voltage.

1. Turn the power on.

The display will show the ROM version and time/date, followed by "Initializing..." -> "Current IDE Drv" -> [(hard disk model name)]. Then after "Unformat!" appears momentarily, the recorder automatically accesses the Disk Format menu in the SETUP mode and the following screen appears.

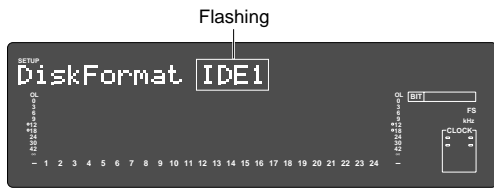
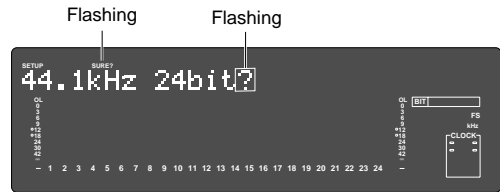

2. Press the [EXECUTE/YES] key.

The E-IDE hard disk name will be displayed and, "SURE?" and "?" will flash.

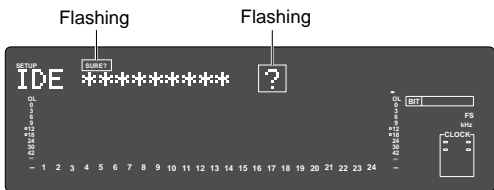

3. Press the [EXECUTE/YES] key.

The display changes the screen for setting the sampling frequency and quantization (default indication is "44.1kHz 24bit?").

4. Select desired sampling frequency/quantization with the Jog dial.

For sampling frequency/quantization, other settings given in chart below can be selected in addition to the presently shown "44.1kHz 24bit."

At selecting the sampling frequency/quantization, be sure to refer to <Note> below.

The sampling frequency:
 The sampling frequency and quantizing of the current drive (E-IDE hard disk) are setup during the formatting or reformatting process. Consequently, all programs in the current drive will adhere to the sampling frequency used at formatting. You can change the format, however, after compiling a program. In other words, a variety of programs with different sampling frequencies can be installed on the current drive. But alterable frequencies will be limited, depending on quantization at formatting. For details, refer to page "23".

Sampling frequency	44.1kHz		48kHz		88.2kHz	96kHz
Quantization	16 bits	24 bits	16 bits	24 bits	24 bits	24 bits
Number of available tracks	24 real tracks + 32 additional tracks				8 real tracks + 48 additional tracks	

<Available recording time after formatting>

A greater sampling frequency will reduce the available recording time/space after formatting. Under the same sampling frequency setting, the greater quantization (bit number) reduces the available recording time.

The following table shows the "approximate available recording time" under each sampling frequency/quantization. Depending on your medium, the available recording time may differ slightly. It will be a good idea to check the available recording time. See "Checking the available recording time (REMAIN) on a formatted disk" on page "11."

Note that the available time values in the following table are based on a mono track recording.

Capacity	44.1kHz		48kHz		88.2kHz	96kHz
	16 bits	24 bits	16 bits	24 bits	24 bits	24 bits
10.0GB	Approx. 1888min.	Approx. 1258min.	Approx. 1735min.	Approx. 1156min.	Approx. 628min.	Approx. 577min.

<Note>

You cannot save audio data recorded in a 88.2kHz/24bit or 96kHz/24bit program using an adat digital signal. See the Reference manual for details about the save/load operations.

5. Select the desired sampling frequency using the Jog dial and press the [EXECUTE/YES] key.

By pressing the [EXECUTE/YES] key after selecting the sampling frequency, the screen for the multiple undo On/Off setting will appear.

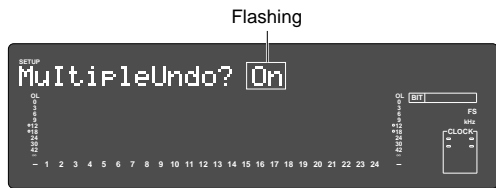

In the initial setting, "On" will flash and if the Jog dial is rotated in this state, either "On" or "Off" can be selected. Normally, format is executed with multiple undo set to "On" but if the current drive capacity is small and you wish to limit consumption of the hard disk, it must be set to "Off."

Multiple Undo function	
On (default)	Off
When set to On, the undo function is applied to all takes (recording, editing, etc.) executed after the disk has been formatted. However, consumption of the hard disk increases, so if the disk capacity is not large enough, we recommend setting this function to Off.	When set to Off, the undo function is only applied to the current take (recording, editing, etc.). If the disk capacity is not large enough, we recommend setting this function to Off.
For details on multiple undo function, refer to the Reference Manual.	

6. Select "On" or "Off" via the Jog dial, and press the [EXECUTE/YES] key.

The screen for selecting the format appears (the default shows "Standard Format?"). You can select the format type between "Standard Format" and "Quick Format" using the Jog dial. To newly format the hard disk, select the initial setting of "Standard format?" and proceed to the next step.

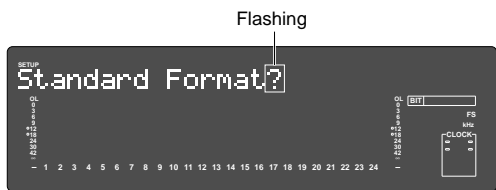

Format type	
Standard Format (default)	Quick Format
During formatting, the recorder checks the hard disk performance including the access time of each block. The time required for the format is longer but the reliability is enhanced. In general, it is best to select this default format type.	Formatting this way, the recorder assumes that all sectors in the hard disk are good and simply formats the disk. The time required to format is very short, however, bad sectors on the disk will not be found. Select this format type only when using a new hard disk that is checked by FOSTEX.

7. Press the [EXECUTE/YES] key while holding down the [RECORD] button.

The size of unformatted area on the hard disk appears on the display, and counts down as the formatting progresses.

It will take a while to complete formatting, especially if you are formatting a large-capacity disk.

Upon completion of formatting, "COMPLETED!" will be lit and the effective hard disk capacity as a result of formatting will be indicated.

The display below is an example at formatting in "48kHz/24 bit," and the number of effective tracks after formatting will be indicated as 24.

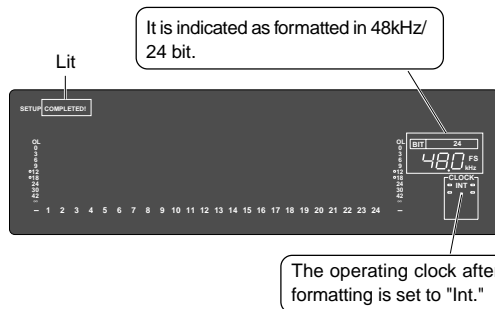

Display below is the example at completion of formatting in "96kHz/24 bit". Number of effective tracks after formatting is 8 (It will also be 8 tracks when formatted in "88.2kHz/24 bit.").

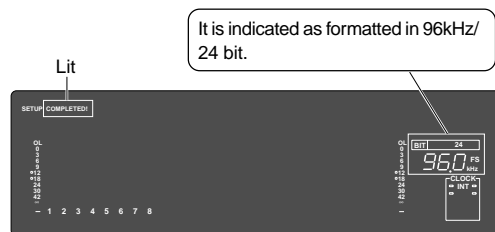

8. Press the [EXIT/NO] key or [STOP] button after confirming that "COMPLETED!" is lit.

It will exit from the SETUP mode format menu and change to indication of the head of disk (ABS 0) by ABS time.

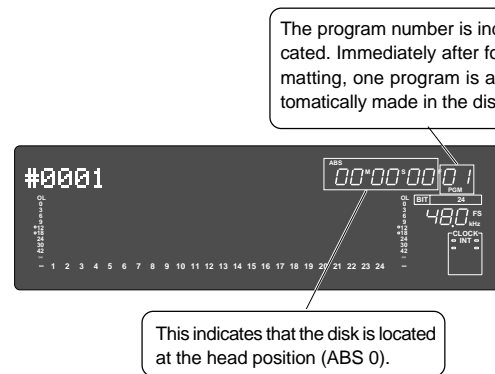

When you format the hard disk one Program (*1) is automatically set up, and “ABS 00M 00S 00F” (ABS Time Base - *2) appears, indicating that the top of the Program is located. Now, you can start recording, playback, and editing on this unit using the installed hard disk.

(*1) Program:
 You can set up a maximum of 99 Programs, limited by the available space on your hard disk. You can select any Program to perform recording, playback, and edit (Program Select function). You may also name the Programs to facilitate managing individual songs (Program Title Edit function). You can delete unnecessary Programs (Program Delete function). For more information, refer to the Reference Manual.

(*2) Time Base:
 This document and the Reference Manual use the word “Time Base” frequently. This refers to the units to indicate the current transport position of the recorder, in other words, Absolute Time. This recorder also uses MTC (MIDI time code) and BAR/BEAT/CLK (bar/beat/clock). An MTC value is a relative time value calculated by adding an MTC offset value to the ABS time value. BAR/BEAT/CLK indicates a position within a song of this recorder’s tempo map based on the MIDI clock position pointer. You can switch to any of these units as follows. For more information on the Time Base, refer to the Reference Manual.

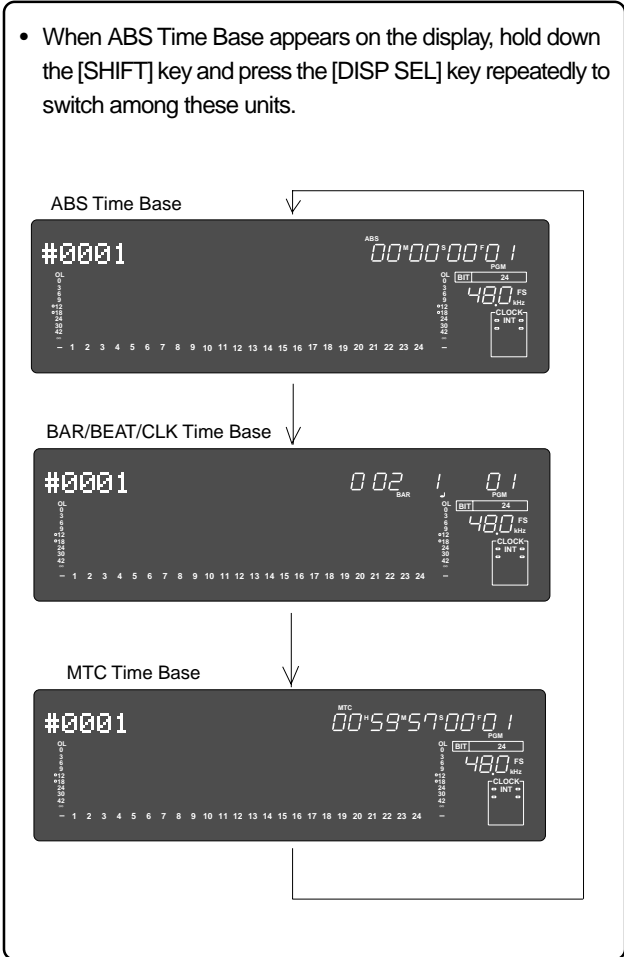

Checking the available recording time (REMAIN) on a formatted disk

It is a good idea to check the available recording time after you format the disk. To do so, press the [DISP SEL] key to display the REMAIN time indication, which indicates the available recording space in the selected Time Base unit. Press the [DISP SEL] key to return to the previous Time Base display.

<Note>
 The REMAIN time values are based on a mono track recording. If you wish to record on multiple tracks, you can find out how many minutes of a song you can record by dividing the REMAIN time value by the number of tracks. Check the REMAIN value each time before you make a new recording.



Setup of the Internal Clock

This recorder contains an internal clock function.

Upon finishing format of the current drive, set internal clock to the present time by procedure explained below. Procedures below is explained on the assumption that current drive has been formatted, the program head (ABS 0) is displayed and this recorder is on standby.

<Note>
 Be sure the internal clock is setup to the correct year, month, day and present time.
 The year, month, day and time are important data necessary for executing the "Multiple Undo Function" explained in the Reference Manual. For details on multiple undo function, refer to the Reference Manual.

- 1. Press the [SETUP] key while in the stop mode.**
 The recorder will enter the SETUP mode and "Signature Set?" menu will be displayed.

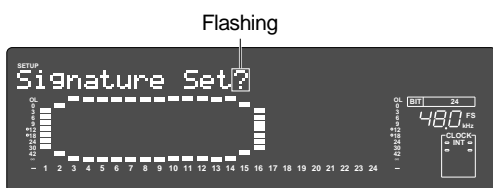

- 2. Rotate Jog dial to display the "Date & Time Set?" ("?" flashes) menu and press the [EXECUTE/YES] key.**

The recorder will change to display of hour, minute, second, day and month in real time setup at shipping the recorder from the plant. Example is January 8, 8 hour, 28 minutes, 54 seconds).

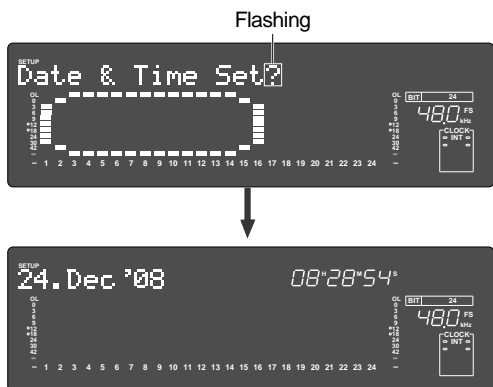

- 3. Press the [EXECUTE/YES] key.**
 The date section will flash and enter in the editing mode. The time display will change to indicating hour/minute.

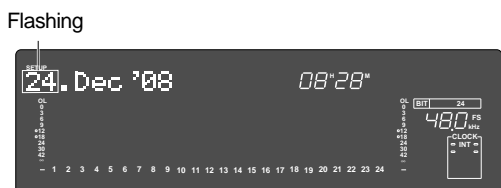

- 4. Move edit point with the Shuttle dial and input the number with the Jog dial.**
 When the Shuttle dial is rotated CW, the edit point will move in order of "day," "month," "year," "hour," "minute," but in reverse order when rotated CCW. Numbers, etc. shown below can be entered at each edit point.

Hour	:00 ~ 23
Minute	:00 ~ 59
Day	:01 ~ 31
Month	:January ~ December
Year	:00 ~ 99

<Note>
 The "second" figures will start from 00 at the instant the following is executed (Pressing the [EXECUTE/YES] key). Press the [EXECUTE/YES] key in reference to the time announcement.

- 5. Press the [EXECUTE/YES] key.**
 The recorder will be set to the time/month, day that was input and continue to function as the internal clock.
- 6. Exit from the SETUP mode by pressing the [EXIT/NO] key or [STOP] button twice.**
 The recorder will change to the time base display prior to entering the SETUP mode.

Connecting a analog mixer

The D2424LVmkII is equipped with 24 [ANALOG INPUT] and 24 [ANALOG OUTPUT] connectors, allowing up to 24-channel input/output connection, which may be powerful for live recording, etc.

<Notes>

- At making connections with the mixer, switch off power to this unit and the mixer.
- Analog input/output ports of D2424LVmkII are set to "**unbalanced input/output**" in the initial state. These can be changed to "balanced input/output" by the "BAL (+4dBu)/UNBAL (-10dBV) setup menu" in the SETUP mode in accordance to the application. For details on setup, refer to the separate "Reference Manual."

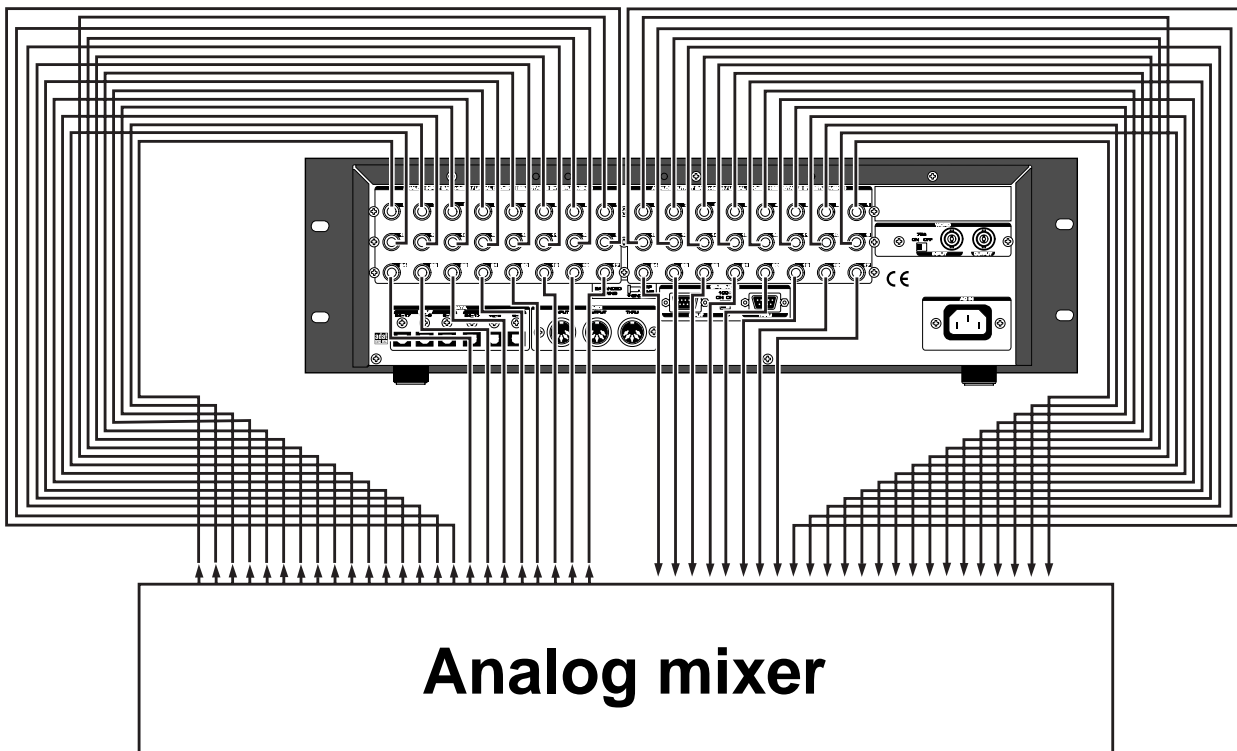

Connecting a digital mixer

When making connections with a digital recording mixer, refer to the connecting example below.

<CAUTION>

- When connecting the recorder to a digital mixing console, make sure that the power of both units are off.
- The [DATA INPUT] and [DATA OUTPUT] connectors do not support adat digital signals of 96-kHz Fs. In other words, the unit cannot receive of feed an adat digital signal of 96-kHz Fs.

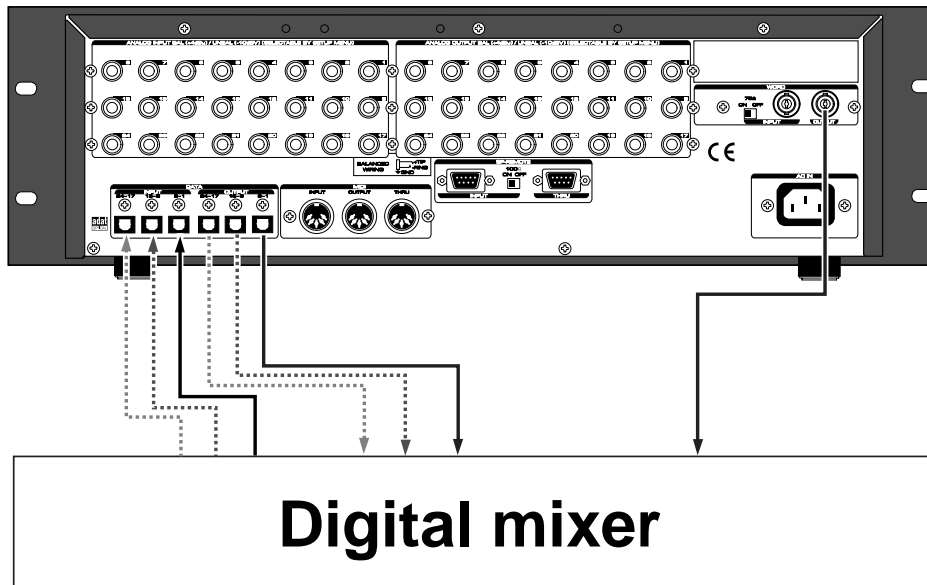

<adat digital signal>

[DATA IN/OUTPUT] 1-8, 9-16 and 17-24 can all be used for record/playback of adat digital signals.

Signals to [DATA INPUT] 1-8, 9-16 and 17-24 will, respectively, be assigned to tracks 1-8, 9-16 and 17-24, and recorded.

At playback, the track outputs are respectively assigned from each [DATA OUTPUT] connectors in the same manner.

<Note>: Except for 96-kHz Fs adat digital signals.

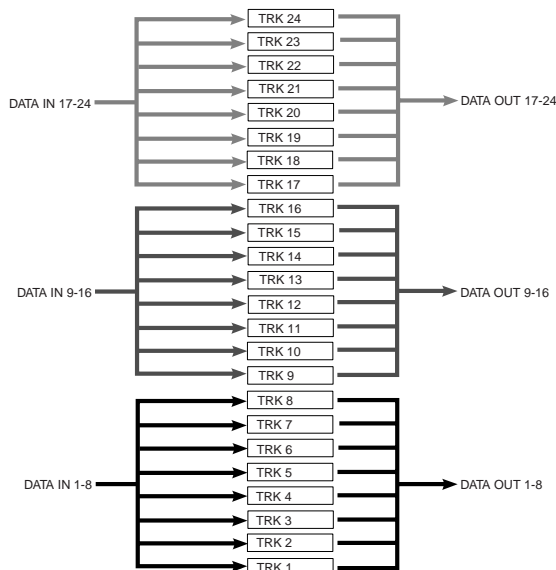

<S/P DIF digital signal>

At record/playback of S/P DIF digital signals, input connectors [DATA INPUT] 1-8 only can be used and the output ports will be [DATA OUTPUT] 1-8, 9-16 and 17-24.

Signals input to [DATA INPUT] 1-8 will be assigned and recorded in tracks 1 and 2.

At playback, signals output from track 1-2, 3-4 and 5-6 will be, respectively, assigned and output from [DATA OUTPUT] 1-8, 9-16 and 17-24.

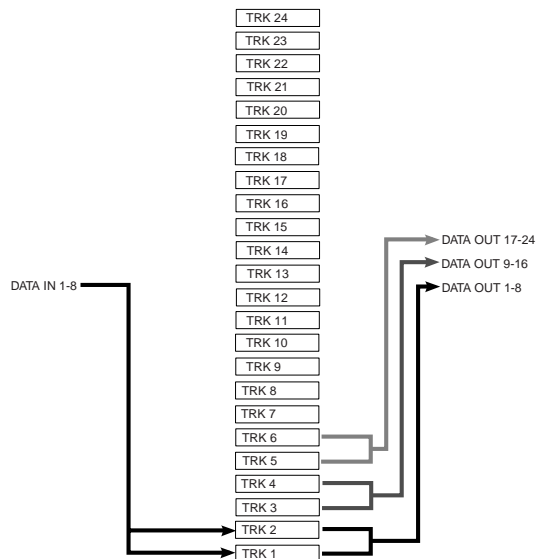

<Hints>

- When connecting the recorder to a digital mixing console as shown in the example above, unlike connecting to an analog console, both digital devices must be synchronized with each other. To achieve this, use "word clock," the signal for synchronization. Word clock is used to synchronize all digital words in a system. Normally one digital devices in the system acts as a master of word clock, and the other devices act as slaves. All the slave devices receive the word clock fed from the master device and synchronize to it. In the example above, the recorder acts as a word clock master and the digital mixing console acts as a slave and synchronizes with the recorder. The word clock is fed from the [WORD OUT PUT] terminal of the recorder to the [WORD INPUT] terminal of the digital mixing console.
- Note that the master word clock setting of the digital mixing console must match the recorder's sampling frequency. See the instruction manual of the digital mixing console for details. To execute the digital multitrack recording using a digital mixing console, see "Basic digital recording" on page "18" for details about the digital multitrack recording using a digital mixing console.

Initial settings

You need to reset all the controls on this recorder to their initial settings according to the controls and switches on the mixer before you proceed to the next step. This procedure is called "Initialize" in this Guide and in the Reference Manual. The buttons and switches on this recorder should be reset as shown below. Remember to "initialize this recorder" before you start a new session.

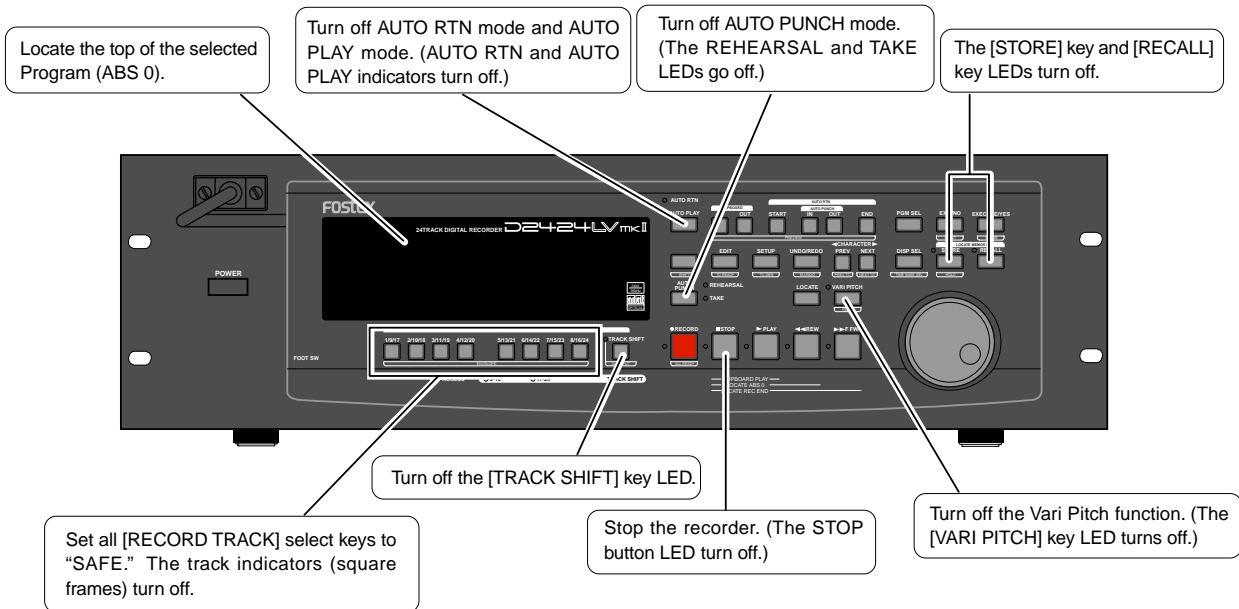

About Sampling Frequency

The sampling frequency is important when recording a digital source, as described later in "Basic digital recording", but is not as important when recording analog source.

As described earlier in "Formatting a hard disk drive", the sampling frequency and quantization of the current drive (<44.1 kHz 16bit or 24bit>, <48 kHz 16bit or 24bit>, <88.2 kHz 24 bit> or <96 kHz 24bit>) are fixed when formatting. Therefore, the sampling frequency of a digital device connected to the recorder must match the recorder's sampling frequency.

In this recorder, the program to be compiled in the current drive after formatting can be changed to any sampling frequency. When several programs recorded using different sampling frequencies are in the current drive, sampling frequencies must be confirmed at each change of the program.

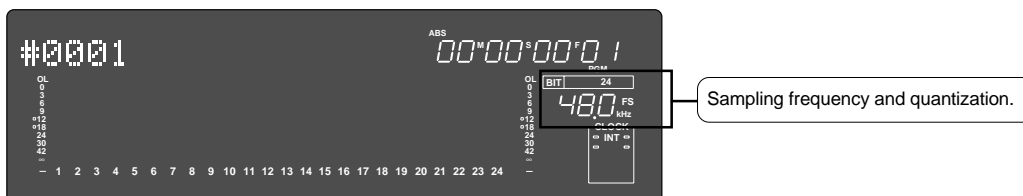

Basic recording

After you finish preparing a recording media and connecting a mixer, you can start basic recording using this recorder.

Basic analog recording

The following explanation assumes that this recorder has been connected to an external mixing console (as explained in the “Connecting a Mixer” section). Because the D2424LVmkII can accept 24 channel analog signals, you can record up to 24 audio sources simultaneously.

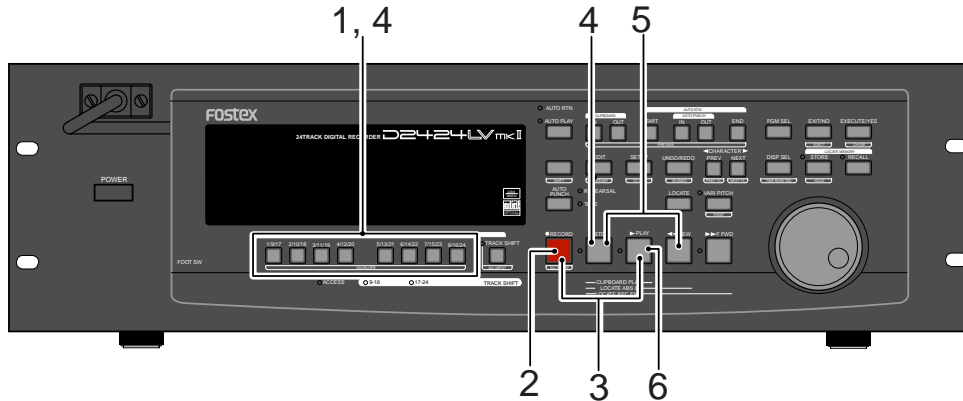

Selecting a recording track

1. Press the **[RECORD TRACK]** select key of the desired recording track to set it in **READY** mode. The “ready” track indicator (a small square) flashes on the display.



Flashing

Adjusting the recording level

This recorder does not have any recording level controls. You need to adjust the recording level on the device that outputs recording data. Use the group master faders on the mixer (faders that control the output level of BUSS OUTs). Set the recording tracks on this recorder to input monitoring status so that you can check the level adjustment.

2. Press the **[RECORD]** button once. (The **RECORD LED** flashes.)
The “ready” tracks enter the input monitoring status. As you raise the group output level on the mixer, the level meter segments of the ready tracks light up. Adjust the level so that the “0” to “3” level segments of the level meter light up at the highest peak. If the “OL” segments of the meter light up, the recording level is too high. If the recording level is too high on a digital recorder, the recording signal may distort, unlike an analog recorder. Especially, if you are recording vocal or acoustic instruments, the recording level may suddenly peak. In this case, you may want to lower the signal peak by applying a compressor/limiter using an insertion connector.

Starting recording

3. Hold down the **[RECORD]** button and press the **[PLAY]** button.
The flashing **RECORD LED** and the track indicator (a small square) light up steadily.

Stopping recording

4. Press the **[STOP]** button.
When the recorder section is stopped, the “Please Wait!” message appears on the display momentarily, then the current position appears. The ready track indicators flash.

Playing the recorded tracks

5. Press the **[RECORD TRACK]** select keys for the ready tracks to set the tracks in the safe status.
The flashing track indicators turn off.
6. Hold down the **[STOP]** button and press the **[REWIND]** button to locate the top of the Program (**ABS 0**).
The top of the Program is immediately located in **LOCATE ABS 0** mode.
7. Press the **[PLAY]** button.
The playback starts from the top of the Program. Adjust the level of input signal at **TAPE IN** on the mixer and monitor the sound.

Repeat the procedure described above to record more tracks (mono track or multiple tracks). You can record eight different sound sources on this recorder simultaneously.

<Undo and redo recording>
If you make a mistake or you are not satisfied with the recording, you can “undo” recording. Refer to the “Undo and redo recording” section below.

Undo and redo recording (single undo/redo)

Everybody makes mistakes. If you make a mistake in recording, you can restore and re-do the data that existed before the mistake occurred. These functions are called “Undo” and “Redo,” and are executed by the [UNDO/REDO] key on the control panel.

The Undo function enables you to cancel the latest recording or edit and restore the previous state. Using the Redo function after using the Undo function enables you to cancel the Undo operation and restore the latest recording or edit. These functions have some limitations as described in the <Note> below.

As described earlier in "Formatting a new disk", if you format the disk with the multiple undo function ON, "multiple undo" is possible. See "Multiple undo function" in the Reference manual.

<Note>
You can repeatedly use the Undo/Redo functions until you perform one of the following operations:

- You make a new recording.
- You perform a new edit (Copy/Paste, Move/Paste, Auto Punch in/out, Erase, etc.).
- You turn off the power to the recorder.
- You select a different Program.
- You execute the Multiple Undo operation.

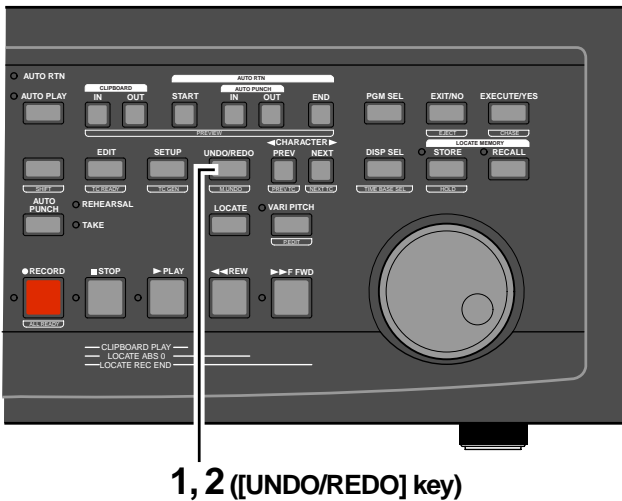

Performing the Redo operation will cancel the Undo operation and restore the state obtained after recording.



1. **After making a recording (or playing back a newly recorded data), press the [UNDO/REDO] key.**
 The recorder displays “Undo!”, then “COMPLETED !”, and displays the previous Time Base indication. Undoing the recording will restore the status obtained before recording.



2. **To cancel the undo operation, press the [UNDO/REDO] key again.**
 The recorder displays “Redo!”, then “COMPLETED !”, and displays the previous Time Base indication.

<Hints>

The single undo/redo function executes undo/redo operation only against the latest take.

The "multiple undo function" can execute undo against all takes after the current disk had been formatted. When the multiple undo function is set to ON, the recorder stores all takes automatically and can recall the desired take (undo) if necessary.

<Cautions for the multiple undo function>

- Multiple undo is possible only when the current disk is formatted with the "Multiple undo function" ON.
- A disk formatted with the multiple undo function ON has more information stored on it more than a disk formatted with the multiple undo function OFF.
- With the single undo/redo function described above, the data you undo will be erased when the next recording is done. Therefore, once you execute a single undo, the undone take cannot be restored even if you execute multiple undo later.

** Refer to the Reference manual for details.*

Basic digital recording

In the following, basic multi-recording of adad digital signals will be carried out on the assumption that a digital mixer is connected to D2424LVmkII (To output adad digital signals from the digital mixer, refer to the Operating Manual of the digital mixer you are using). Prior to operation, D2424LVmkII must be set to the "Initial state."

Selecting Digital In

<About Digital In selection>

For setup items of digital in, in addition to the initial setting of "Analog," "SPDIF: Async," "SPDIF: Sync," "adat: Async" or "adat: Sync" can be selected and setup to match the application.

"Analog" indicates that none of the tracks are assigned to digital in and is the setting in which digital signals cannot be input to any of the [DATA INPUT] connectors.

"SPDIF:Async" and "SPDIF: Sync" are used when assigning S/P DIF signals (L, R) from external digital equipment to tracks 1 and 2 of D2424LVmkII, and selected to digital in asynchronous (Async) or synchronous (Sync) depending on the system in use. In this case, [DATA INPUT] 1-8 only can be used.

"adat:Async" and "adat: Sync" are used to assign adad signals (ch 1-ch 8) from external digital equipments to tracks 1-8 (9-16, 17-24) of D2424LVmkII, and in compliance to the system, select it to asynchronous (Async) or synchronous (Sync) with digital-in. In this case, all [DATA INPUT] connectors can be used and each input port will function as shown below.

[DATA INPUT] 1-8: Tracks 1 - 8 will be assigned.
 [DATA INPUT] 9-16: Tracks 9 - 16 will be assigned.
 [DATA INPUT] 17-24: Tracks 17 - 24 will be assigned.

1. Press the [SETUP] key to enter the SETUP mode.
2. Select the "D. in?" menu by using the Jog dial, and press the [EXECUTE/YES] key.
 The current selection will be displayed together with "D. in?" (the default is "Analog").
 By pressing the [EXECUTE/YES] key, the selection starts flashing, showing that you can now change the selection.

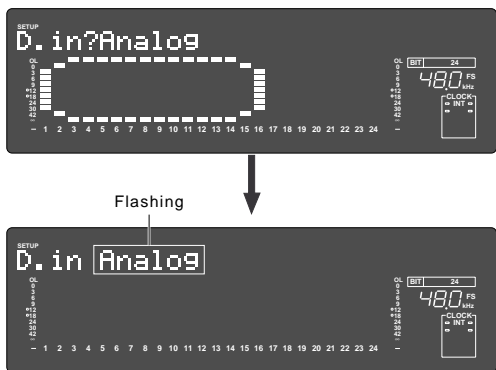

3. Select "adat: Async" or "adat: Sync" by using the Jog dial, and press the [EXECUTE/YES] key.
 To lock the mixing console to recorder's WORD OUT (or digital out), select "adat: Async".
 If the mixing console cannot be locked to the digital word clock, select "adat: Sync".

"DIGITAL" will be lit if set to the asynchronous mode while a correct adad digital signal is being input from the digital mixer, and "EXT" will also be lit if set to the synchronous mode. If it is locked to the word signal, "WORD" will be lit.

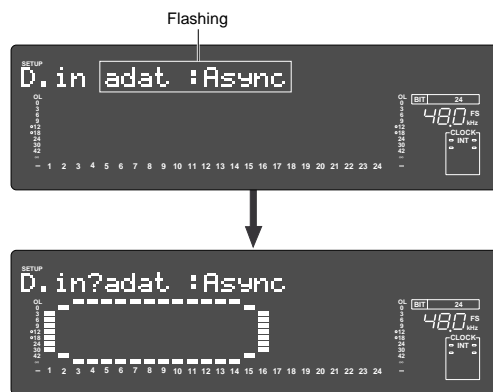

After completing the Digital In setting, select "Digital Out". When setting Digital In to an "Async" mode ("adat: Async" or "SPDIF: Async"), Also select "Reference clock".

Selecting Digital Out

<About Digital Out selection>

In addition to the initial setting of "D.out adat" from among the digital out setup items, "D.out SPDIF" can also be selected, and setup in compliance with the application. When set to "D.out adat," outputs of tracks 1-8 (6-16, 17-24) will be assigned to digital out. This will be the initial setting and signals can be output to digital mixers and adad equipments provided with adad input functions. The following signals will be output from each [DATA OUTPUT] connectors.

[DATA OUTPUT] 1-8: Outputs of tracks 1 - 8
 [DATA OUTPUT] 9-16: Outputs of tracks 9 - 16
 [DATA OUTPUT] 17-24: Outputs of tracks 17 - 24

When set to "D.out SPDIF," outputs of two tracks (1-2, 3-4, 5-6) will be assigned to digital out. It will thus be possible to output S/P DIF signals (L, R) to external digital equipments. Signals listed below will be output from each [DATA OUTPUT] connectors.

[DATA OUTPUT] 1-8: Outputs of tracks 1 - 2
 [DATA OUTPUT] 9-16: Outputs of tracks 3 - 4
 [DATA OUTPUT] 17-24: Outputs of tracks 5 - 6

4. Select the "D.out?" menu by using the Jog dial, and press the [EXECUTE/YES] key.
 The current selection is displayed together with "D. out?".
 The default is "D.out adat". If another selection is displayed, select "D.out adat" using the following operation. Press the [EXECUTE/YES] key and the current selection will start flashing.

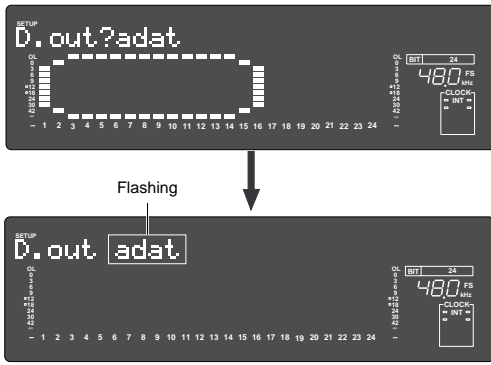

5. Select "D.out adat" by using the Jog dial, and press the [EXECUTE/YES] key. Now the Digital Out is set to "adat".

Setting the reference clock

When setting "Digital In" (see the previous page) to an "Async" mode ("adat: Async" or "SPDIF: Async"), you must select whether the recorder is referenced to the internal clock or word clock from an external digital device. When setting "Digital In" to a "Sync" mode ("adat: Sync" or "SPDIF: Sync"), the recorder is referenced to the word clock received through the external digital audio signal.

<About reference clock setting>
 You must set the reference clock when setting "Digital In" (see the previous page) to an "Async" mode ("adat: Async" or "SPDIF: Async"). You can select from "Auto", "Word" and "Video" in addition to the default "Int". Note that "Video" is available only when the optional TC/SYNC card (model 8346) is installed. See the table below about the relation between the Digital In setting and reference clock.

6. Select the "Clock Sel?" menu via using the Jog dial, and press the [EXECUTE/YES] key. The current reference clock is displayed together with "Clock Sel?". The default is "Clock Sel Int". Press the [EXECUTE/YES] key, and the current selection will start flashing.

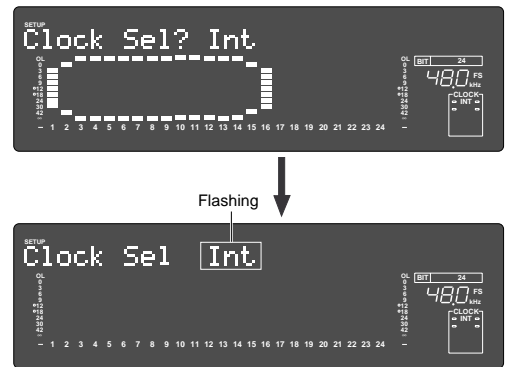

7. Select the desired reference clock by using the Jog dial, and press the [EXECUTE/YES] key. The reference clock is now set to your desired clock. When connecting the recorder to a digital mixing console that can accept the word clock from the WORD OUT of the recorder, set the recorder's reference clock to "Int". See the table below in other cases.
8. Press the [EXIT/NO] key or [STOP] button to exit the SETUP mode. The display shows the beginning of the disk with ABS time base.

After complete "Digital In", "Digital Out" and "Reference Clock" settings, execute the basic recording in a similar manner to "Basic analog recording" described earlier.

[D. in ?] setting		[Clock Sel ?] setting			
		Int	Auto	Word	Video
SPDIF :Async adat :Async	clock received from WORD IN	Regardless of receiving or not receiving word clock from WORD IN, the recorder is referenced to the internal clock. When the recorder receives correct digital signals, the "DIGITAL" indicator lights in the display.	When receiving word clock from WORD IN, the recorder automatically synchronizes to the incoming clock, while the "DIGITAL", "EXT", and "WORD" indicators light in the display.	When receiving word clock from WORD IN, the recorder synchronizes to the incoming clock, while the "DIGITAL", "EXT", and "WORD" indicators light in the display.	Available only when installing the optional Model 8346 TC/SYNC card. If you try to select "Video," "Void w/o 8346" is displayed and you cannot select it. See the appendix of the Reference manual for details.
	no clock received from WORD IN		When no word clock is received, the recorder is referenced to the internal clock, while the "EXT" indicator flashes.	When no word clock is received, the "EXT" indicator flashes showing that the recorder cannot be locked.	
SPDIF :Sync adat :Sync	clock received from WORD IN	Regardless of receiving or not receiving word clock from WORD IN, the recorder synchronizes to the external S/P DIF digital signal. When the recorder receives correct digital signals, the "DIGITAL" and "EXT" indicators light in the display. When Digital In is set to a SYNC mode, if you try to select "Clock Sel?" menu, The display will show "Clock Sel D.in!" (indicating that the clock is set to Digital In!) and the recorder ignores your operation.			
	no clock received from WORD IN				

Multitrack recording using overdubbing

Multitrack recording is a term for the series of processes in which you record various sound sources to different tracks and combine them into two mixes (L and R). This recording involves an important process called “overdubbing,” in which you record additional sound sources to different tracks while monitoring the input sound and listening to the recorded sound. The following procedure assumes that you have already recorded a rhythm section using a drum machine on Track 1.

Initialize the recorder.

1. **Press the [RECORD TRACK] select key of the desired overdubbing track to set it in READY mode.**
The “ready” track’s indicator (a small square) flashes on the display.
2. **Press the [RECORD] button once.**
The ready tracks enter input monitoring status, and the other tracks enter playback monitoring status.
3. **Press the [PLAY] button to play the Program from the beginning. (Rehearsal)**
Adjust the level of the playback monitoring sound (rhythm sound on Track 1) on the mixer. Play the sound source to overdub and adjust the recording level on the mixer.
4. **When you finish rehearsing, locate the top of the Program for the actual take.**
5. **Press and hold down the [RECORD] button and press the [PLAY] button. (Take)**
Play the sound source accompanying the Track 1 sound in the same way as during the rehearsal.
6. **When you finish overdubbing, stop this unit, locate the top of the Program, and play the overdubbed sound as explained in the “Basic Recording And Playback.”**
If you are not satisfied with your overdubbing, perform the Undo function and record again.

In the same way, overdub the necessary tracks.

Ping-pong recording

Ping-pong recording is a recording process in which you mix the playback sound of multiple tracks and record the mix on an empty track. Ping-pong recording enables you to use previously-recorded tracks in a new recording. In this way, you can overdub more sound sources using a limited number of tracks. The following procedure explains how to ping-pong record the sound sources recorded on Tracks 1-6 to Tracks 7 and 8. Once you ping-pong record the tracks, you cannot apply effects to the individual tracks. If necessary, apply effects on the mixer prior to ping-pong recording.

Initialize the recorder.

1. **Set all tracks to the SAFE status.**
2. **Locate the top of the Program on this recorder.**
3. **Set the master recorder to REC-STANDBY mode.**
4. **Play the Program from the beginning and adjust the recording level on the master recorder while adjusting the tonal quality and mix balance of the playback sound from the mixer. (Rehearsal)**
Adjust the input level on the master recorder so that the STEREO OUT L/R meters on the mixer respond to the same degree as the level meters on the master recorder.
5. **Locate the top of the Program.**
6. **Start recording on the master recorder. (Take)**
7. **Press the [PLAY] button on this recorder to start playing the Program from the beginning.**
8. **When mixdown is completed, stop the master recorder and this recorder.**

Mixdown

After overdubbing and ping-pong recording, you can mix all track data into two channel stereo data and record it onto your master recorder. This final process of multitrack recording is called “**mixdown.**” The mixdown signals are usually output from the mixer’s STEREO OUT L/R. Connect the master recorder.

Initialize the recorder.

- | | |
|--|---|
| <ol style="list-style-type: none"> 1. Set all tracks to the SAFE status. 2. Locate the top of the Program on this recorder. 3. Set the master recorder to REC-STANDBY mode. 4. Play the Program from the beginning and adjust the recording level on the master recorder while adjusting the tonal quality and mix balance of the playback sound from the mixer. (Rehearsal) | <ol style="list-style-type: none"> 5. Locate the top of the Program. 6. Start recording on the master recorder. (Take) 7. Press the [PLAY] button on this recorder to start playing the Program from the beginning. 8. When mixdown is completed, stop the master recorder and this recorder. |
|--|---|

Adjust the input level on the master recorder so that the STEREO OUT L/R meters on the mixer respond to the same degree as the level meters on the master recorder.

Basic Locate function

The Locate function enables you to locate the desired point (move the current position of the recorder) immediately. There are two locate methods: storing the desired locate point (time or bar/beat/clock value) into the memory keys, and locating the point without storing it.

This section explains “**Locating the top of the Program**” and “**Locating the last recording point in the Program**” and do not involve storing locate points. Refer to the Reference Manual for information on storing and locating locate points.

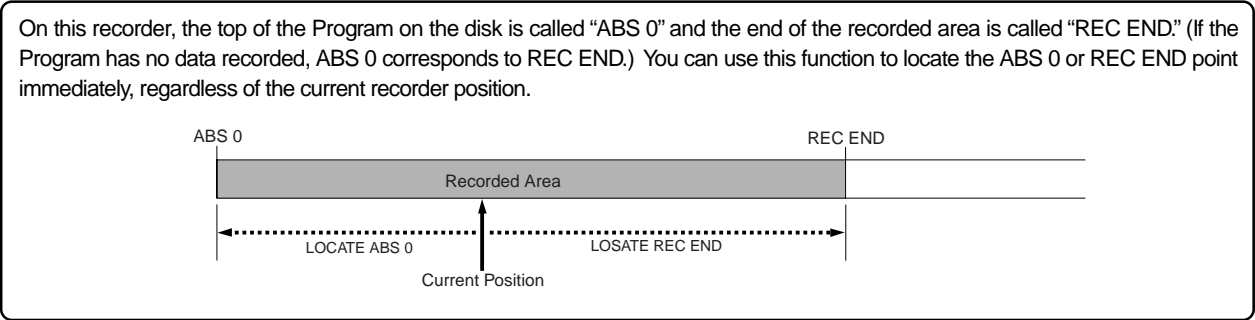

• Locating the top of the Program

You can immediately move to the top of the Program (ABS 0), regardless of the current position of the Program.

1. **Press and hold down the [STOP] button, and press the [REWIND] button.**

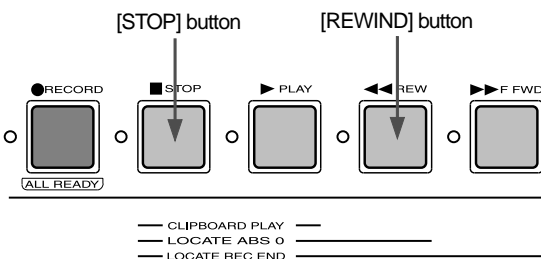

• Locating the end of the recorded area of the Program

You can immediately move to the end of the recorded area of the Program, regardless of the current position of the Program.

1. **Hold down the [STOP] button and press the [F FWD] button.**

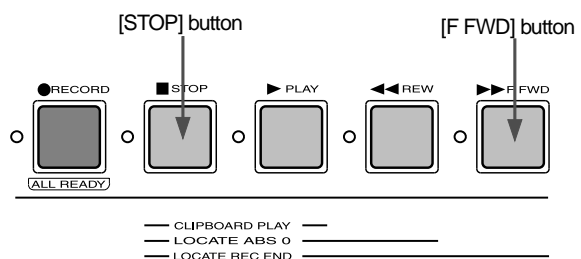

Recording in a new Program

The explanation so far has been based on one Program set up when you format a current drive (E-IDE hard disk). You may create up to 99 Programs, depending on the available disk space.

Multiple Programs do not interfere with each other. You can record, play, and edit each Program independently, which facilitates song management. This section explains how to set up a new Program on the disk. Refer to the reference manual for more information regarding Programs.

<CAUTION>

- When creating a new program, the initial settings such as the tempo map are copied from the current program. For example, if the default tempo map is edited in the current program, the edited tempo map is copied to the newly created program.
- A new compilation is possible only when the “Chain Play?” (Setup of the chain play mode) menu in the SETUP mode is set to “Off.” If the [PGM SEL] key is pressed when the “Chain Play?” menu is set in other than the “Off” mode, the recorder will enter the “Chain Play mode”. Before starting compilation, check that the “Chain Play?” is “Off” and if it is not, be sure to reset it to “Off.”

1. **While this recorder is stopped, press the [PGM SEL] key.**

The display indicates “Select PGM!” momentarily, then shows the title of Program 1. The Program number and “SURE?” flash.



2. **Turn the Jog dial clockwise to select “New Program?”.** The “?” mark of “New Program?”, and “SURE?” flash, indicating that you can set up a new Program.

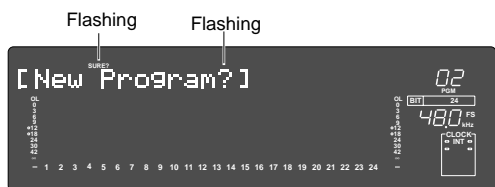

3. **Press the [EXECUTE/YES] key.** This recorder sets up a new Program (Program 2) and enters the “Title Edit?” menu in SETUP mode, showing the following display. In this example, we use the default title. You can change the title later. Refer to the Reference manual for more information.

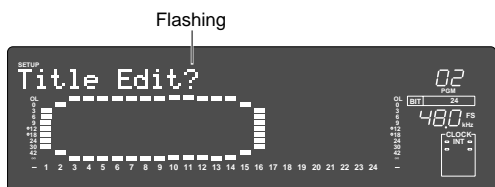

4. **Press the [EXIT/NO] key.** This recorder exits SETUP mode, and the top of Program 2 in ABS Time Base (ABS 0) appears.



Normally, any new program that is compiled will be in the sampling frequency set when formatting the current drive. However, in this recorder, it is possible to change the program sampling frequency.

In other words, programs with different sampling frequencies can be made in the current drive and thus recording can be matched to a chosen task. For details refer to the next page.

<Selecting the desired Program>

If you have set up multiple Programs on the disk, you first need to select the target Program prior to recording, playback, or edit. To select a Program, follow the steps below. Do not select a different Program until you finish the session.

1. **While this recorder is stopped, press the [PGM SEL] key.** “Select PGM!” appears momentarily, then the number and title of the current Program appear.
2. **Turn the Jog dial clockwise or counter-clockwise.** The numbers and titles of the Programs on the disk appear in turn.
3. **Select the desired Program number and press the [EXECUTE/YES] key.** The top of the selected Program appears in ABS Time Base (ABS 0).

Changing the program FS

In the following, we will change a program’s sampling frequency in the current drive.

IN general, the sampling frequency of the program made in the current drive will be the value set during the most recent formatting of the current drive. But even after a program has been made, the sampling frequency can be changed. However, the changes will be limited as follows depending on the quantizing figure when formatting.

<Note>

- Do not change the sampling frequency of a completed program.
- Changing of the sampling frequency will be limited by the quantizing figure (16bit or 24bit) set at formatting of the current drive.

Current drive formatting by 24bit:
A program in 44.1kHz, 48kHz, 88.2kHz or 96kHz can be made.

Current drive formatting by 16bit:
A program in 44.1kHz or 48kHz can be made.

- Please remember the following points should there be programs with a different FS in the current drive.
- * Do not copy or paste between programs with different FS. Fostex cannot take responsibility in compensation of data which had been “copied” or “pasted” between programs with different FS.
- * In the section “Digital recording” explained above, be sure to set the external digital equipment sampling frequency the same as that of the program.

1. First, start the program in which the FS is to be changed by using the “program change” menu explained above.
2. Press the [SETUP] key to enter the SETUP mode. The display will change to SETUP mode.
3. Rotate the Jog dial to display the “Sample Rate?” menu and then press the [EXECUTE/YES] key. When the [EXECUTE/YES] key is pressed, the FS figure of the current activated program will flash and the recorder will enter the editing mode.

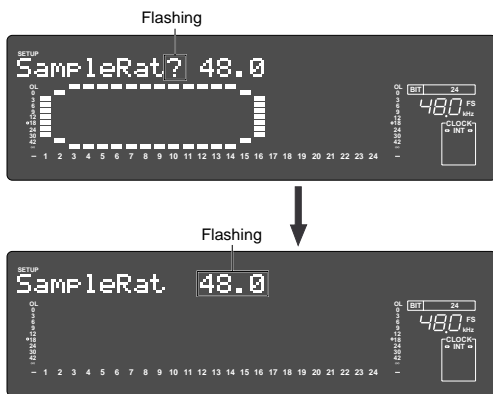

4. Display the desired FS by rotating the Jog dial, and then press the [EXECUTE/YES] key. Either “44.1” or “48” can be selected in the 16bit current drive, “44.1,” “48,” “88.2,” or “96” can be selected in the 24 bit current drive. After selection, the recorder will be set to the chosen FS when the [EXECUTE/YES] key is pressed.

5. Exit from the SETUP mode by pressing the [EXIT/NO] key or [STOP] button.

<Note>

If you change the FS (44.1 or 48kHz) of a program in the 24-track mode to 88.2 or 96kHz, the program automatically changes to the 8-track mode and track numbers 1 through 8 on the display are lit.

The following shows display examples when changing the FS of a 48kHz/24bit program to 96kHz.

Track numbers 1 through 8 are lit.

Playback using the Vari-pitch function

This section explains how to change the playback speed of the recorder using the Vari Pitch function. You can set the playback speed in the range of +6.0% to -6.0% in 0.1% increments.

The **[VARI PITCH]** key turns Vari Pitch mode on and off. When the function is turned on, the VARI PITCH LED lights up. When the function is turned off, the LED turns off.

Initialize the recorder.

Vari-pitch function procedures

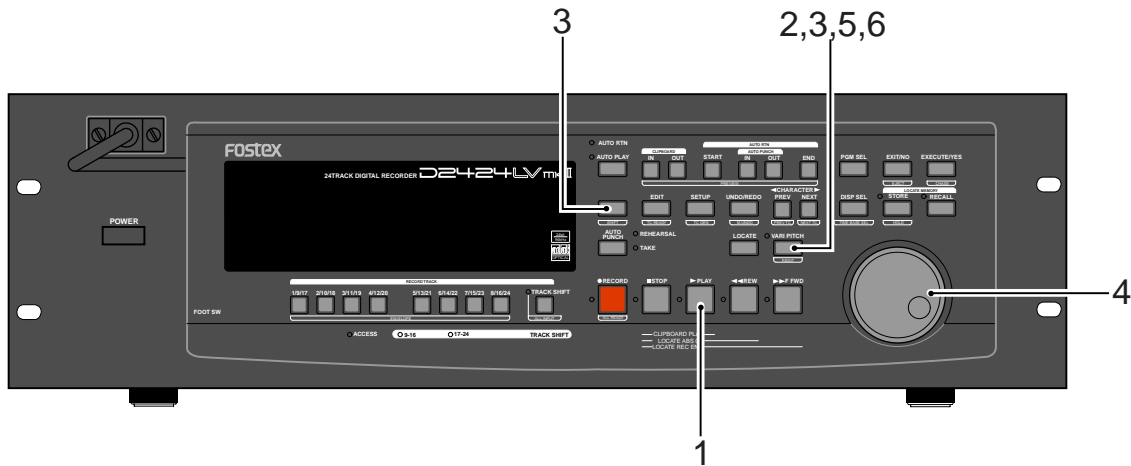

1. Press the **[PLAY]** button to play this recorder.
2. Press the **[VARI PITCH]** key.
The VARI PITCH key LED lights up on the display, indicating that the Vari Pitch function is turned on.
3. Press the **[SHIFT]** key, then press the **[VARI PITCH]** key.
The current pitch data flashes on the display, indicating that you can change the pitch data now. (The “%” mark flashes.)
4. Set the desired pitch data using the Jog dial.
5. To turn off Vari Pitch mode, press the **[VARI PITCH]** key.
6. If you wish to play back data at the current Vari Pitch again, press the **[VARI PITCH]** key to turn the LED on. You can turn the Vari Pitch function on and off and edit the pitch data while this recorder is playing or stopped, but not during recording. However, if the Vari Pitch function has already been turned on and the pitch data was specified before you started recording, this recorder will record using the current Vari Pitch.

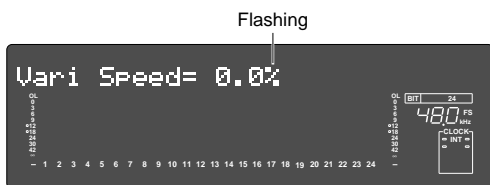

4. Set the desired pitch data using the Jog dial.
Rotating the Jog dial enables you to hear changes in playback speed. Rotating the Jog dial clockwise increases the speed, and rotating it counter-clockwise decreases the speed.
- To continue the playback with the Vari Pitch function on, press the **[EXIT/NO]** key. This recorder exits Vari Pitch data edit mode, indicates the previous Time Base display, and continues playing with the Vari Pitch you just set.
5. To turn off Vari Pitch mode, press the **[VARI PITCH]** key.
The VARI PITCH LED turns off, the Vari Pitch function is cancelled, and this recorder resumes playback at normal speed.

<Notes>

- Even if the pitch data is 0.0% (no speed change), pressing the **[VARI PITCH]** key will still turn on the VARI PITCH function. The speed is not changed, but the Vari Pitch is turned on.
- The Vari Pitch function is automatically turned off under the following conditions:
 1. You have turned off and on the power to this recorder.
The pitch data will be reset to 0.0%.
 2. You must press the **[EXECUTE/YES]** key while holding down the **[SHIFT]** key to turn the "SLAVE mode" on (the setting pitch data remains).
 3. You set "Digital In" of the SETUP mode to a "Sync" mode ("SPDIF: Sync" or "adat: Sync") and the recorder is locking to the external clock from DIGITAL IN or WORD IN. In consequence, "DIGITAL" and "EXT" indicators light in the display.

***** Reference manual reference pages *****

Names and functions	10
Before starting	25
Formatting and optimizing disks	32
Handling programs	38
Punch in/out	43
Recording digital data	48
Recording to a Metronome sound	52
Storing a locate points (=edit points)	54
Locate function	58
Chain Play function	61
Envelope function (Cue & preview function)	65
Preview function	67
Multiple Undo function	69
Editing tracks	71
MIDI sync function	80
Saving and loading song data	90
SETUP mode	108
MIDI implementation chart	128
MMC command list	129
Inquiry message list	129
Fostex MIDI system exclusive message	130
Specifications	140

Declaration of EC Directive

This equipment is compatible with the EMC Directive (2004/108/EC) - Directive on approximation of member nation's ordinance concerning the electromagnetic compatibility and with the Low Voltage Directive (73/23/EEC) - Directive on approximation of member nation's ordinance concerning electric equipment designed to be used within the specified voltage range.

The Affect of Immunity on This Equipment

The affect of the European Specification EN61000-6-1 (coexistence of electromagnetic waves - common immunity specification) on this equipment are as shown below.

* In the electrical fast transient/burst requirements, surge, conducted disturbances by radio-frequency fields, power frequency magnetic field, radiate electromagnetic field requirements and static electricity discharging environment, this could be affected by generation of noise in some cases.

FOSTEX DISTRIBUTORS LIST IN EUROPE

* Including non-EU countries (as of March, 2007)

<AUSTRIA>

NAME: ATEC Audio-u. Videogeraete VertriebsgesmbH.
ADD: Im Winkel 5, A-2325 Velm, Austria
TEL: (+43) 2234-74004, FAX: (+43) 2234-74074

<BELGIUM>

NAME: General Audio
ADD: Raymond Pelgrimslaan 101, B-1702 Groot-Bijgaarden, Belgium
TEL: (+32) 2-4630650, FAX: (+32) 2-4661500

<DENMARK>

NAME: SC Sound ApS
ADD: Malervej 2, DK-2630 Taastrup, Denmark
TEL: (+45) 4399-8877, FAX: (+45) 4399-8077

<FINLAND>

NAME: Noretron Oy Audio
ADD: P. O. Box 22, FIN-02631 Espoo, Finland
TEL: (+358) 9-5259330, FAX: (+358) 9-52593352

<FRANCE>

NAME: Sennheiser France
ADD: 128 bis, avenue Jean-Jaures, 94851 Ivry-sur-Seine Cedex, France
TEL: (+33) 1 4987 0300, FAX: (+33) 1 4987 0324

<GERMANY>

NAME: Mega Audio GmbH
ADD: Stromberger Str. 32, D-55411 Bingen, Germany
TEL: (+49) 6721-94330, FAX: (+49) 6721-32046

<GREECE>

NAME: Bon Studio S. A.
ADD: 6 Zaimi Street, Exarchia, 106.83 Athens, Greece
TEL: (+30) 210-3809-605, 606, 607, 608
FAX: (+30) 210-3845-755, 210-3827-868

<ICELAND>

NAME: I. D. elrf. electronic Ltd.
ADD: ARMULA 38 108 REYKJAVIK, ICELAND
TEL: (+354) 588 5010, FAX: (+354) 588 5011

<ITALY>

NAME: Proel S. p. A.
ADD: Zona Via Alla Ruenia, 37/43 64027 -Sant'Omero (Teramo), Italy
TEL: (+39) 0861-81241, FAX: (+39) 0861-887862

<THE NETHERLANDS>

NAME: IEMKE ROOS AUDIO B. V.
ADD: Kuiperbergweg 20, 1101 AG Amsterdam, The Netherlands
TEL: (+31) 20-697-2121, FAX: (+31) 20-697-4201

<NORWAY>

NAME: Siv. Ing. Benum AS
ADD: P.O. Box 145, Vinderen, 0319 Oslo, Norway
TEL: (+47) 2213 9900, FAX: (+47) 2214 8259

<SPAIN>

NAME: Letusa S. A.
ADD: C/Laguna 10, 28923 Alcorcon, Madrid, Spain
TEL: (+34) 91-4862800, 91-4470898
FAX: (+34) 91-6414597

<SWEDEN>

NAME: Kinovox-Benum A/B
ADD: Solna Strandvag 78 171 54 Solna, Sweden
TEL: (+46) 8 5052 1176, FAX: (+46) 8 5052 1010

<SWITZERLAND>

NAME: Audio Bauer Pro AG
ADD: Bernerstrasse-Nord 182, CH-8064 Zurich, Switzerland
TEL: (+41) 1-4323230, FAX: (+41) 1-4326558

<UK>

NAME: SCV London
ADD: 40 Chigwell Lane, Oakwood Hill Industrial Estate, Loughton, Essex IG10 3NY U. K.
TEL: (+44) 20-8418-0778, FAX: (+44) 20-8418-0624

Fostex[®]

FOSTEX CO.

3-2-35, Musashino, Akishima-shi, Tokyo, Japan 196-0021