INSTRUCTION MANUAL

Digital Eight Channels/Four Channels Video Recorder

EDR810H/810M/ 410H/410M

V 1.21



About this manual

Before installing and using this unit, please read this Manual carefully.
Be sure to keep it handy for later reference.



Updated on: Nov. 17th 2005

Federal Communication Commission Interference Statement

This equipment has been tested and found to comply with the limits for a Class B digital device, pursuant to Part 15 of the FCC Rules. These limits are designed to provide reasonable protection against harmful interference in a residential installation. This equipment generates, uses and can radiate radio frequency energy and, if not installed and used in accordance with the instructions, may cause harmful interference to radio communications. However, there is no guarantee that interference will not occur in a particular installation. If this equipment does cause harmful interference to radio or television reception, which can be determined by turning the equipment off and on, the user is encouraged to try to correct the interference by one of the following measures :

- Reorient or relocate the receiving antenna.
- Increase the separation between the equipment and receiver.
- Connect the equipment into an outlet on a circuit different from that to which the receiver is connected.
- Consult the dealer or an experienced radio/TV technician for help.

FCC Caution : Any changes or modifications not expressly approved by the party responsible for compliance could void the users's authority to operate this equipment.

This device complies with Part 15 of the FCC Rules. Operation is subject to the following two conditions : (1) This device may not cause harmful interference, and (2) this device must accept any interference received, including interference that may cause undesired operation.

This device and its antennas(s) must not be co-located or operating in conjunction with any other antenna or transmitter.

This advice complies with Part 15 of the FCC Rules. Operation is subject to the following two conditions: (1) this device may not cause harmful interference, and (2) this device must accept any interference received, including interference that may cause undesired operation.

Safety Warning

**WARNING**

TO REDUCE RISK OF FIRE OR ELECTRIC SHOCK,
DO NOT EXPOSE THIS APPLIANCE TO RAIN OR MOISTURE.

**CAUTION**

DO NOT REMOVE COVER. NO USER SERVICEABLE PARTS INSIDE.
REFER SERVICING TO QUALIFIED SERVICE PERSONNEL.

**Note:**

This equipment has been tested and found to comply with the limits for a Class A digital device, The changes or modifications not expressly approved by the party responsible for compliance could void the user's authority to operate the equipment.

**Note:**

This is a class A product. In a domestic environment this product may cause radio interference In which case the user may be required to take adequate measures.

Notice:

The information in this manual was current when published. The manufacturer reserves the right to revise and improve its products. All specifications are therefore subject to change without notice.

Safety Precautions

Safety Precautions



⚠ Refer all work related to the installation of this product to qualified service personnel or system installers.



⚠ Do not block the ventilation opening or slots on the cover.



⚠ Do not drop metallic parts through slots. This could permanently damage the appliance. Turn the power off immediately and contact qualified service personnel for service.



⚠ Do not attempt to disassemble the appliance. To prevent electric shock, do not remove screws or covers. There are no user-serviceable parts inside. Contact qualified service personnel for maintenance. Handle the appliance with care. Do not strike or shake, as this may damage the appliance.



⚠ Do not expose the appliance to water or moisture, nor try to operate it in wet areas. Do take immediate action if the appliance becomes wet. Turn the power off and refer servicing to qualified service personnel. Moisture may damage the appliance and also cause electric shock.



⚠ Do not use strong or abrasive detergents when cleaning the appliance body. Use a dry cloth to clean the appliance when it is dirty. When the dirt is hard to remove, use a mild detergent and wipe gently.



⚠ Do not overload outlets and extension cords as this may result in a risk of fire or electric shock.



⚠ Do not operate the appliance beyond its specified temperature, humidity or power source ratings. Do not use the appliance in an extreme environment where high temperature or high humidity exists. Use the appliance at temperature within indoor type DVR for 0°C ~ +40°C and a humidity below 90%.
The input power source for this appliance is AC100~240V.

Safety Precautions

Safety Precautions



The lightning flash with an arrowhead symbol, within an equilateral triangle, is intended to alert the user to the presence of uninsulated "dangerous voltage" within the product's enclosure that may be of sufficient magnitude to constitute a risk of electric shock to persons.



Warning:
Electrostatic-sensitive device. Use proper CMOS/MOSFET handling precautions to avoid electrostatic discharge.



The exclamation point within an equilateral triangle is intended to alert the user to presence of important operating and maintenance(servicing)instructions in the literature accompanying the appliance.



Do not place on uneven or unstable work surfaces. Seek servicing if the casing.



Warning :
To prevent fire or shock hazard, do not expose units not specifically designed for outdoor use to rain or moisture.



Attention:
Installation should be performed by qualified service personnel only in accordance with the National Electrical Code or applicable local codes.



Power Disconnect:
Units with or without ON-OFF switches have power supplied to the unit whenever the power code is inserted into the power source; however, the unit is operational only when the ON-OFF switch is in the ON position. The power cord is the main power disconnect for all units.



External Power Supplies
Use only the recommended power supplies. Power supplies must comply with the requirement of the latest version of IEC 60065/CNS 13439. Substitutions may damage the unit or cause a fire or shock hazard.



AC100~240V Power Cords
AC100~240V power cords

Important Safeguards

Important Safeguards



Read Instruction---All the safety and operating instructions should be read before the unit is operated.



Retain Instructions---The safety and operating instructions should be retained for future reference.



Heed Warnings—All warnings on the unit and in the operating instructions should be adhered to.



Follow Instructions—All operating and use instructions should be followed.



Cleaning—Unplug the unit from the outlet before cleaning. Do not use liquid cleaners or aerosol cleaners.
Use a damp cloth for cleaning



Attachments—Do not use attachment not recommended by the product manufacturer as they may cause hazards.



Water and Moisture—Do not use this unit near water—for example, near a bath tub, wash bowl, kitchen sink, or laundry tub, in a wet basement, near a swimming pool, in an unprotected outdoor installation, or any area which is classified as a wet location.



Servicing—Do not attempt to service this unit by yourself as opening or removing covers may expose you to dangerous voltage or other hazards. Refer all servicing to qualified service personnel.



Power Cord Protection—Power supply cords should be routed so that they are not likely to be walked on or pinched by items placed upon or against them, paying particular attention to cords and plugs, convenience receptacles, and the point where they exit from the appliance.



Object and Liquid Entry—Never push objects of any kind into this unit through openings as they may touch dangerous voltage points or short-out parts that could result in a fire or electric shock. Never spill liquid of any kind on the unit.

Table of Contents

1. PRODUCT INTRODUCTION	8
1.1 FEATURES	8
1.2 SPECIFICATIONS	9
1.3 FRONT PANEL KEYPADS	11
1.4 BACK PANEL CONNECTORS	14
1.5 MONITOR DISPLAY	17
2. INSTALLATION	20
2.1 PACKING LIST	20
2.2 SYSTEM FLOORPLAN	20
2.3 BASIC CONNECTIONS	21
2.4 BOOT UP EDR810/410.....	21
2.5 QUICK INSTALLATION GUIDE FOR EDR810M & EDR410M ONLY.....	22
3. MENU SETUP.....	28
3.1 TIME/DATE SETUP MENU	28
3.2 CAMERA SETUP MENU	32
3.3 RECORD SETUP MENU	35
3.4 ALARM SETUP MENU	37
3.5 MOTION SETUP MENU	39
3.6 VLOSS SETUP MENU	42
3.7 NETWORK SETUP MENU	44
3.8 SCHEDULE SETUP MENU	49
3.9 DISK SETUP MENU	50
3.10 CONTROL SETUP MENU	51
3.11 WARNING SETUP MENU.....	52
3.12 SYSTEM SETUP MENU	56
4. RECORDING	59
4.1 INSTANT RECORDING	59
4.2 SCHEDULE RECORDING	60
4.3 EVENT RECORDING	60
4.4 ALARM INPUT RECORDING	61

Table of Contents

5. PLAYING BACK.....	62
5.1 NORMAL PLAYBACK.....	62
5.2 SEARCH PLAYBACK	64
6. COPY TO A VIDEO FILE	66
7. CALL	68
8. SCREEN DISPLAY SETTING	70
9. SCREEN DISPLAY MODE	71
10. REMOTE VIEWER	72
APPENDIX A: RS232 specifications	78
APPENDIX B: RS485 specifications	79
APPENDIX C: Alarm I/O Assignment	80
APPENDIX D: Troubleshooting	81

1. PRODUCT INTRODUCTION

The Digital Video Recorder is the industry's first full-featured digital video recorder designed specifically for use in security industry. The Digital Video Recorder incorporates all the benefits of digital video recording, is simple to install, and operates just like a VCR. Highly efficient compression technology and superior resolution of recorded images make the Digital Video Recorder stand out from the competition as the best choice for security surveillance.

1.1 FEATURES

- ✍ Duplex Operation for Recording & Playback
- ✍ Built-in MPEG4 Codec with Configurable Quality
- ✍ Variable Recording Speeds up to 60/50 Images per second for NTSC/PAL
- ✍ Audio Recording Capabilities
- ✍ Motion Detection Capabilities
- ✍ One 3.5" Hard Disk with Hot-Swap Tray for Internal Storage
- ✍ Ethernet Interface for Remote Network Viewing
- ✍ Optional Wireless LAN Interface for Data Transmission (Reserved)
- ✍ RS232 and RS485 for Remote Control
- ✍ Shuttle/Jog Dial for Picture-by-Picture or Fast/Slow Viewing
- ✍ Easy-to-use Control Panel with Common VCR and Multiplexer Functions
- ✍ On-Screen Menus Operations with Multi-Language Support
- ✍ Real-Time Live Display for all Cameras
- ✍ Easy archiving of video and Remote Viewer through USB port

1.2 SPECIFICATIONS

Video Format	NTSC/EIA or PAL/CCIR
Video Input	4/8 camera inputs (BNC), 1Vp-p/75ohm
Video Output	1 BNC video out (1Vp-p/75ohm) for Main Monitor 1 BNC video out (1Vp-p/75ohm) for CALL Monitor 4 video out (1Vp-p/75ohm) for Looping (4 Channels only)
Video Compression	MPEG4
Recording Resolution	720x240, 720x480 or 360x240 for NTSC 720x288, 720x576 or 360x288 for PAL
Video Display	Full, PIP, 4, 7, 8/9 and 2x2 Zoom for Live Viewing and Playback
Display Resolution	720x240, 720x480 or 360x240 for NTSC 720x288, 720x576 or 360x288 for PAL
Video Pause	Yes
4/8 Alarm Inputs	4/8 Alarm Inputs
1 Alarm Output	1 Alarm Output
Hard Disk Storage	One Hot-Swappable 3.5" IDE Hard Disk
Recording Rate	Up to 60/50 Images per second for NTSC/PAL
Recording Mode	Continue, Time-lapse, Schedule, Event recording (Motion and Alarm)
Playback Rate	Up to 60/50 Images per second for NTSC/PAL
Playback Search	By Date/Time or Event (Motion, Video Loss, Alarm)
Motion Detection	Yes, with MULTIPLE configurable detection areas & sensitivity
Video Loss Detection	Yes
Event Log	Yes
User Interface	User-friendly Menu Driven
Setup	On screen display setup
User Input Device	Front panel keypad with Shuttle/Jog, Keyboard (optional)
Timer	Built-in real time clock and Auto Time Synchronization with global NTP server through Internet
Watch Dog Timer	Yes

Title	12-characters title for each camera
Ethernet	RJ45 connectors for network communication
Archive	USB for archiving Archive through Wireless transmission (Reserved)
RS-232	9-pin female connector for local communication
RS-485	for Keyboard connection
Audio	2 mono inputs, 2 mono (SPEAKER) outputs
Power Rate	DC 12V/DC 24V
Dimension	Half size: 320 mm (L) x 215mm (W) x 100mm (H) Mobile : 320.8mm (L) x 215mm (W) x 109.9mm(H)
Weight	4.85 KG
Operating Temperature	0°C ~ +50°C
Remote Controller	IR Remote Controller IR Remote Controller with Extension Wire(optional)

1.3 FRONT PANEL KEYPADS

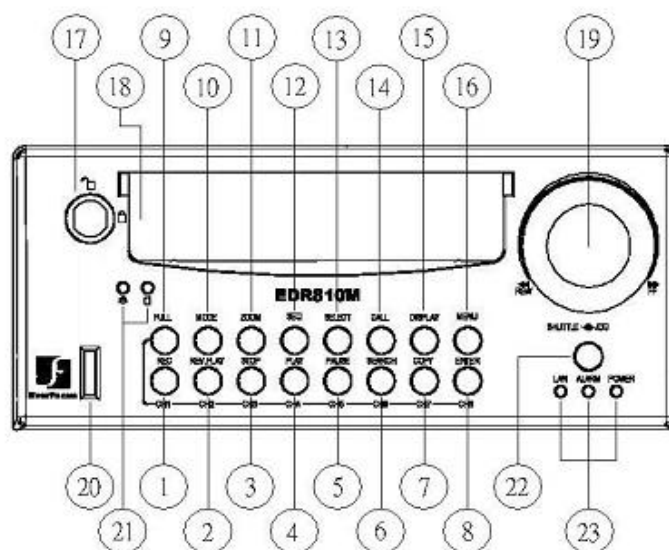

KEY

- ① ~ ⑧ **Channel Key:** Press **FULL**+Channel Key (**CH1~CH8**) to display video image in the full screen format the picture of the corresponding will fill the whole screen of the monitor display.
- ① **CH1 / REC:** Press this key to start instant recording.
- ② **CH2 / REV. PLAY:** Reverse Play Back.
- ③ **CH3 / STOP:** Press this key to stop recording and playing back.
- ④ **CH4 / PLAY:** Play Back.
- ⑤ **CH5 / PAUSE:** Press this key to pause the playback picture.
- ⑥ **CH6 / SEARCH:** Press this key to enter the **SEARCH MENU**.
- ⑦ **CH 7 / COPY:** Press this key to start to copy video stream under **PAUSE** mode into USB.
- ⑧ **CH8 / ENTER:** Press this key to enter items , or jump to next subentry in the menu setting.
- ⑨ **FULL:** Press this key and channel Key at the same time to switch to full screen in both live mode and play back mode. Press “**MODE**” to exit full screen.

-
- ⑩ **MODE:** Switch PIP, 4, 7, and 8 displays in **Live** and **Playback** modes.
 - ⑪ **ZOOM:** Press this key while viewing the full screen image to display a magnified resolution on the monitor. You must be in “Full” screen mode first before zooming. While zooming, all other function keys will be disable until you press “ZOOM” again to exit “ZOOM” mode.
 - ⑫ **SEQ:** Press this key to enter the auto sequential switching mode.
 - ⑬ **SELECT:** Press this key to select, to assign a camera to a display, to adjust screen display, and so on.
 - ⑭ **CALL:** Press this key to enter and set up **CALL MENU**.
 - ⑮ **DISPLAY:** Press this key to switch display of channels and/or status bar.

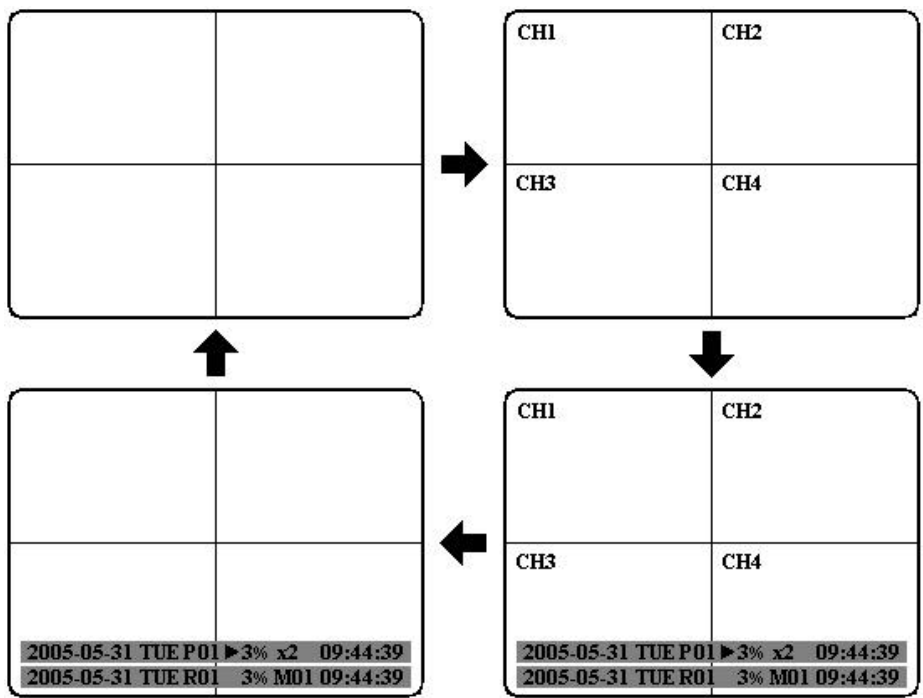

- ⑯ **MENU:** Press this key to enter or quit **MAIN SETUP MENU**.
- ⑰ **HDD LOCK:** Protect HDD without steal and turn on HDD power.
- ⑱ **Hard Disk Tray:** Hard Disk holder for HDD.

19

Shuttle and Jog Dial

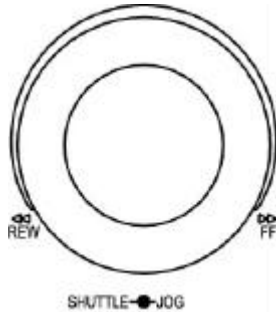

Shuttle: In the **Playback** mode, turn the **Shuttle** dial to fast forward/rewind the video.

In the **Pause** mode, turn the **Shuttle** dial to slow forward/rewind the video.

In the **Search** mode, turn the **Shuttle** to change pages.

Jog Dial: In the **Pause** mode, turn the **Jog** dial to forward/rewind the video.

In the **Menu** mode, turn the **Jog** dial to change settings and values in subentries.

20

USB Slot: Insert a USB to archive an image or video file.

21

HDD LEDs: LEDs for HDD active power (GREEN) and data reading /writing (YELLOW).

22

Remote Control: IR remote control receiver.

23

System LEDs: LEDs for system active **LAN**, **ALARM** and **POWER** display.

1.4 BACK PANEL CONNECTORS

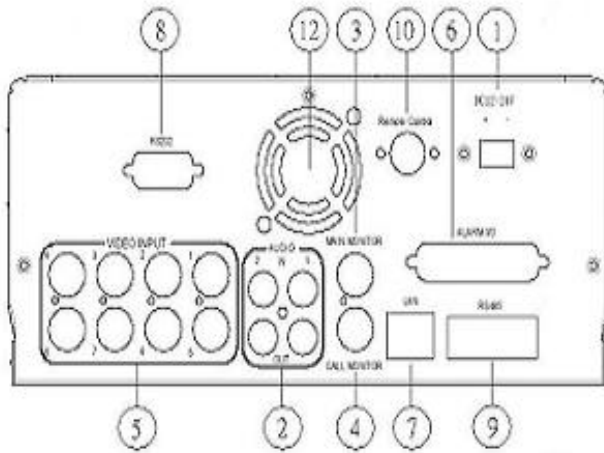

Back panel of 810H

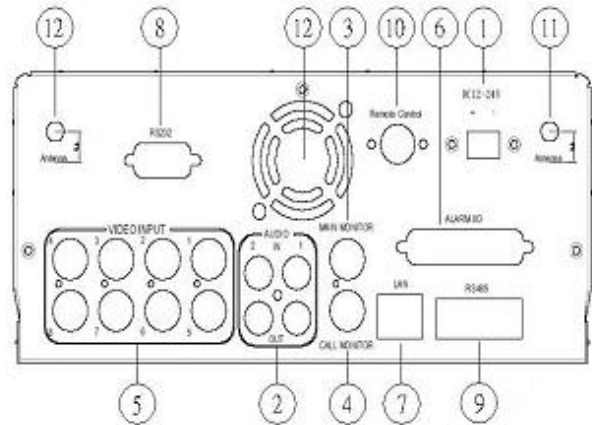

Back panel of 810M

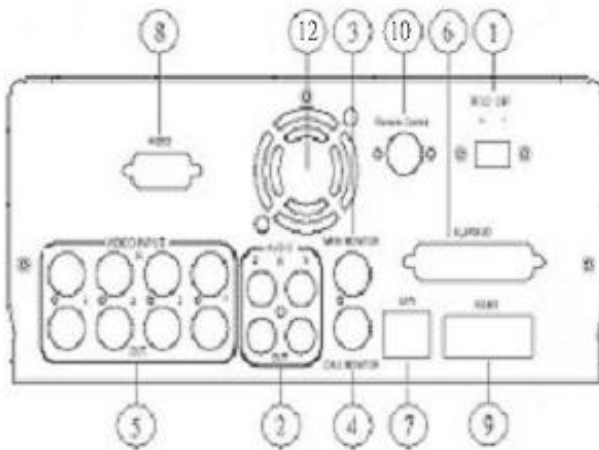

Back panel of 410H

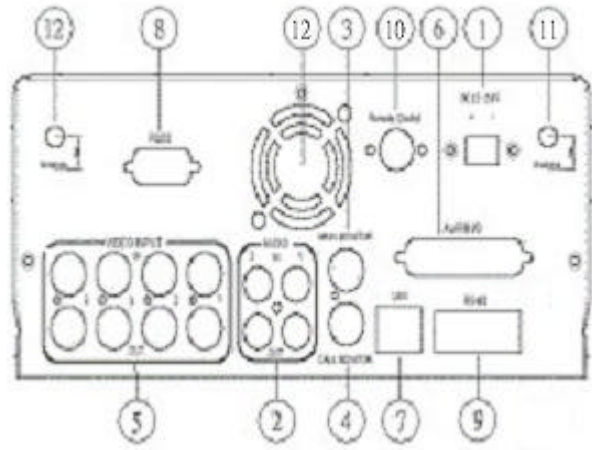

Back panel of 410M

POWER

- ① **Main Power plug:** Connect the DC 12~ 24V power source to adapter for AC 100~ 240V.

AUDIO

- ② **Audio IN:** Audio input for recording, and it can be set to “YES” or “NO” in the **RECORD SETUP MENU**.

Audio OUT: Connect to an audio input of a monitor or other device.

MONITOR

- ③ **MAIN MONITOR:** This connector is used for the main monitor display, a number of different display modes may be selected for viewing.
- ④ **CALL MONITOR:** This connector is used for the call monitor. This monitor can only display a full screen or a quad screen.

VIDEO IN

- ⑤ **For EDR810 Series:**

VIDEO IN(1-8): The BNC connectors of video input enables the system to receive the signals from each camera through the 75 ohm coaxial cables.

Alarm Input/Output

- ⑥ **Alarm Input**

ALM-INPUT: Normal open or normal close type alarm signal inputs.

The Alarm Input can be selected as Normal Open (**N.O.**), Normal

Close (**N.C.**), **N.C. TRANS.**, or **N.O, TRANS** input in the **ALARM SETUP MENU**.

When an alarm occurs, alarm recording will automatically start.

ALM-OUTPUT: A build-in relay offers 3 nodes which are **ALM-COM** (common), **ALM-NO**

(normal open) and **ALM-NC** (normal close) for external use.

Note: Please check **APPENDIX C** to see other available alarm input/output functions.

LAN

7 **LAN Connector:** The RJ-45 LAN connector.

RS232

8 **RS232 connector:** Connect D-Sub 9 pins connector to RS232 ports for remote control.

RS485

9 **RS485 connector:** RJ 45 Connector to Cascade multi Digital Video Recorder.

Remote

10 **Remote Control:** Remote control port provides you an extension wire with an IR receiver instead of the IR receiver on the front panel.

Note: The IR receiver extension line (10m) must be purchased separately.

Wireless LAN (Reserved)

11 **Antenna:** Integrated IEEE 802.11b/g wireless LAN capabilities. The antenna port is for wireless network antenna use (For EDR810M option).

12 **FAN:** Cooling FAN.

1.5 MONITOR DISPLAY

The status information of the cameras or machine will show up, and be located at different places on the screen.

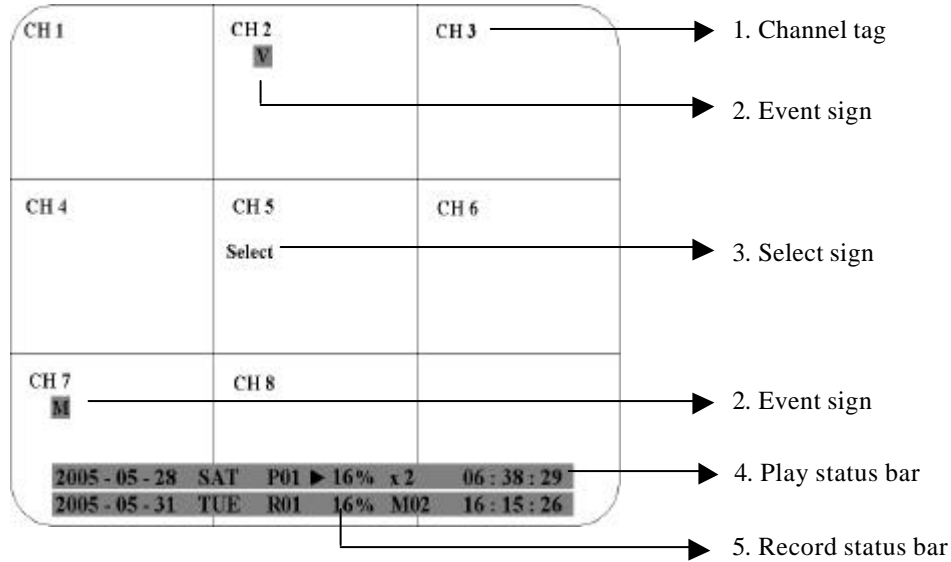

- ① **Channel tag:** A channel tag indicates the channel name of the screen.
- ② **Event sign:** Event signals which are small icons with a capital letter and red background show the events on each screen. There are 4 different signals which are

A : Alarm event. The alarm place where the camera locates. In order to show the camera video to a corresponding alarm, setting a **FOCUS CAMERA** in **ALARM SETUP MENU** is necessary.

M : Motion event. Motion event only shows up when the camera's **MOTION** is enabled in **MOTION SETUP MENU**, and the camera detects a motion.

V : Video loss event. Video loss event only shows when the camera's **VLOSS** is enabled in **VLOSS SETUP MENU**, and the camera signal is lost.

S : Sequence sign. Sequence sign shows up when the display is in the sequence mode.

The sequence display is located on display with a “*” sign in 4, 7, Full screen and PIP (picture in picture) display mode. The **S** sign will replace “*” sign in the display when sequence occurs.

3 **Select sign:** You can assign a camera to a display by pressing **SELECT** key in life mode. Dial **Jog** to move the select sign to the display you would like to change camera, and then press **FULL** + channel key to relocate the camera.

4 **Play status bar:** The play status bar appears in play back mode if you enable a status bar on the screen (Check page 12, item 15th, **DISPLAY**). Three parts which are play date, play time and play status are shown in the play status bar.



1. **Play date:** The play date in which the video is recorded.

2. **Play status:** It shows PAUSE, play speed and reverse play speed.

“PAUSE”, when the video play is paused.

“>” means normal play speed;

“<” means normal reverse play speed;

“>> x N” means N time fast play speed;

“<< x N” means N time fast reverse play speed.

3. **Play time:** The play time at which the video is recorded. The time format depends on the time format setting in the **TIME/DATE SETUP MENU**.

5 **Record status bar:** The record status bar appears when you enable a status bar on the screen (Check page 12, item 15th, **DISPLAY**). Three parts which are current date, record status (% of space used for recording) and current time.

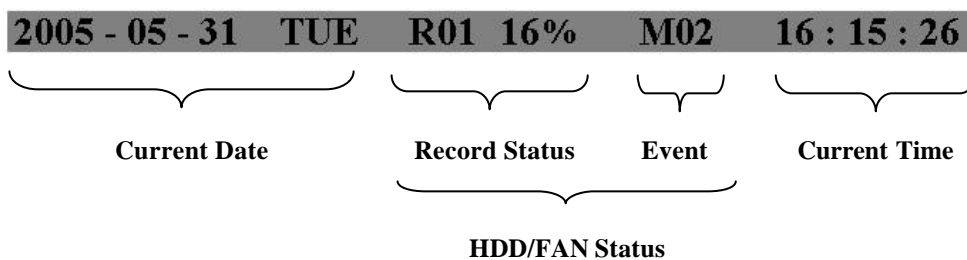

1. Current date: The current date which is set in the **TIME/DATE SETUP MENU**.

2. Record status: It shows REC and recording hard disk number.

“**REC**”, it shows when machine is recording.

“**R01**”, the recording hard disk number. There is only one hard disk available in this model, so it always shows R01 when recording.

3. Event: The last happened event.

4. Current time: The current time which is set in the **TIME/DATE SETUP MENU**.

5. HDD/Fan status: “**No Disk**”, it shows when no disk is installed or detected.

“**No Fan**”, it shows when cooling fan stops working.

2. INSTALLATION

The installations described below should be done by qualified service personnel or system installers.

2.1 PACKING LIST

Please check accessories in the packing before the installation.

2.2 SYSTEM FLOORPLAN

Please refer to the following diagram for the system connections.

Note: Monitor and Camera must be purchased separately.

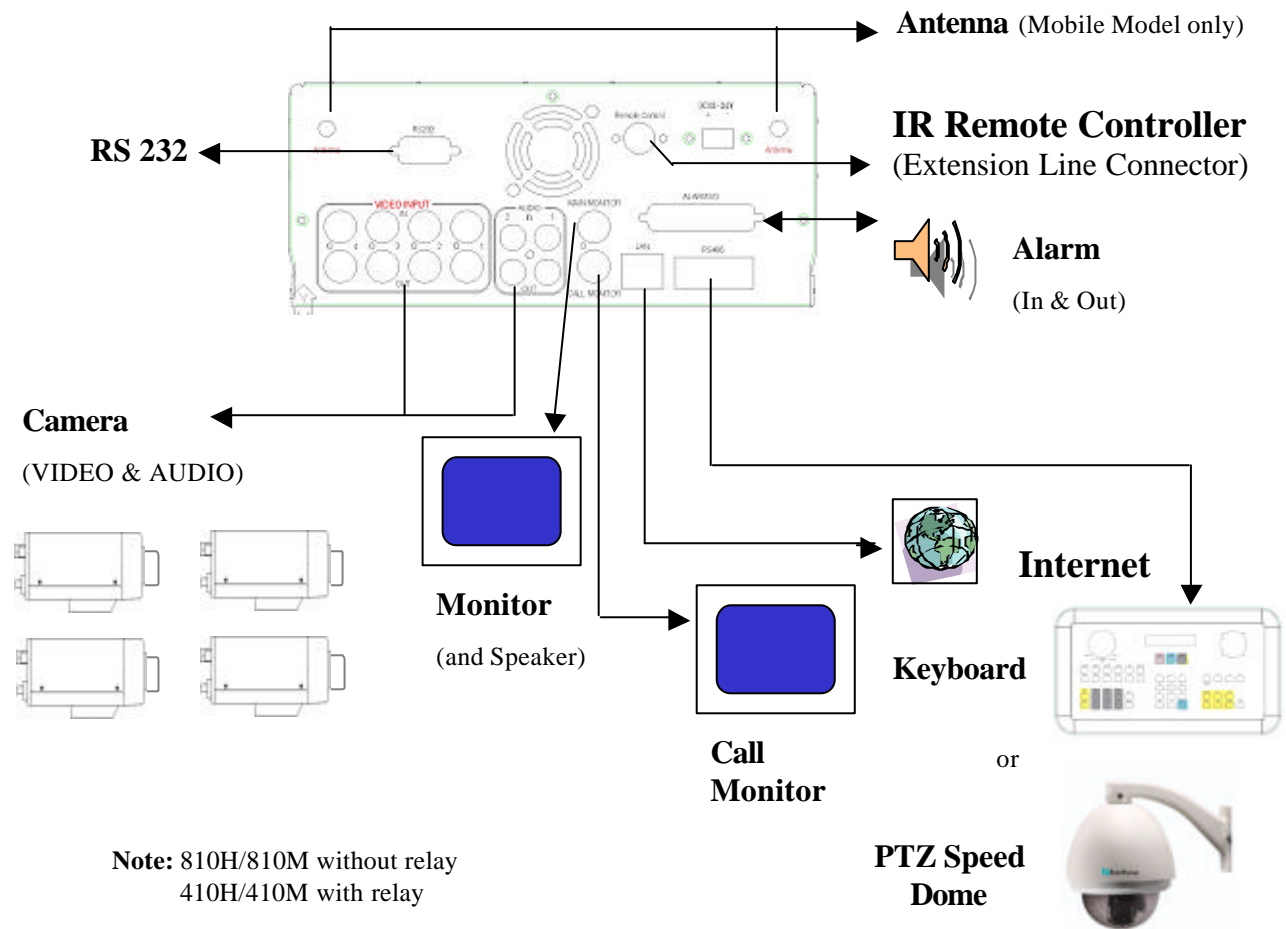

2.3 BASIC CONNECTIONS

■ Power

Connect the power source or adapter into the power socket.

■ Cameras

Connect each camera video input connector to the video output from a camera or other composite video source. At least one camera must be connected before the system is running for the auto detection of video standard to take effect.

■ Audio In/Out

The camera audio In/Output is connected to the audio input terminal at the rear panel.

■ Speaker

Connect the speaker or other audio devices.

■ 10/100M Ethernet

Digital Video Recorder is enabled control from the PC via Ethernet. Connect the LAN connector to a standard RJ45 connector Ethernet cable or wireless network (IEEE 802.11b/g).

■ RS232/RS485

Digital Video Recorder is enabled control from the PC or EverFocus keyboard via RS232/RS485.

■ Main/Call Monitor

Connect the Main/Call monitor output connector to a Main/Call monitor. The Main/Call monitor displays selected live or recorded cameras in any available format.

2.4 BOOT UP EDR810/410

(1) Insert a HDD (IDE) for Video Storage

Insert a HDD(IDE) for Video Storage. The HDD should be set as MASTER. After hard disk case is inserted into the hard disk tray, be sure to turn the tray key in lock position. Otherwise, HDD will not be detected.

Note: A HDD has to be installed before EDR810/410 is booted, or the EDR810/410 will not detect a HDD until you reboot it with a HDD. Please make sure the HDD indicator light is ON.

(2) Connect cable for video/audio input and video/audio out.

(3) Turn on system

The system will be turned on after connecting to power.

2.5 QUICK INSTALLATION GUIDE FOR EDR810M & EDR410M ONLY

The EDR810M & EDR410M are the full-featured digital video recorders designed specifically for use in mobile applications. Please refer to the following Quick Installation Guide for installing EDR810M or EDR410M into mobile applications such as buses, cars and police cruisers.

- The DVR can be mounted horizontally (suspend or support mounted).

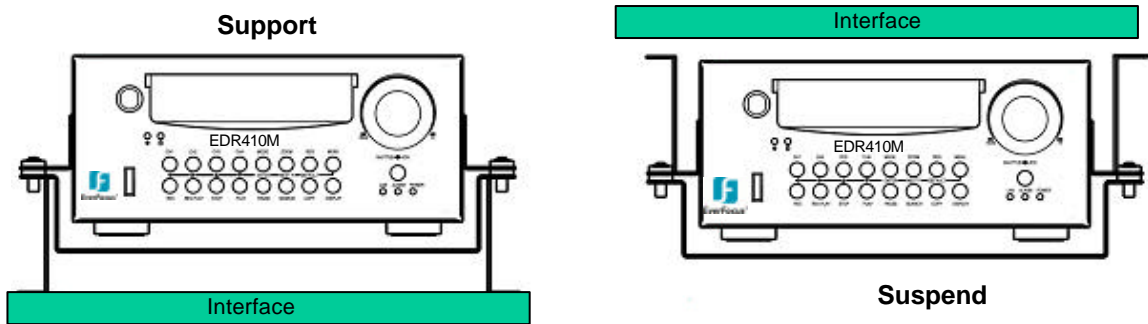

- Show all the possible ways to mount the DVR.
Use the two Z-brackets supplied to mount it in any ways shown.

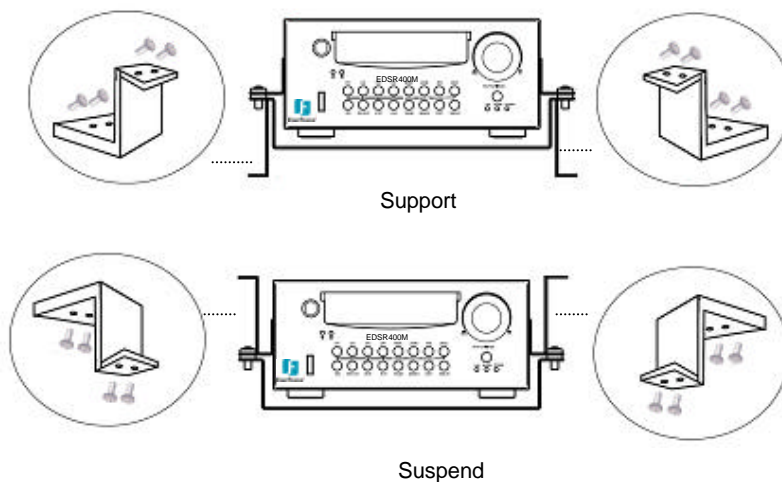

Quick Install Guide :

■ 1. Unpack Everything

Make sure you have everything you need before you begin the installation.

■ 2. Equipment Required

The following tools may help you to complete the installation:

- Drill
- Screwdrivers
- Wire cutters

■ 3. Choosing the Location

Choose a location for installation that:

- Provides convenient access for installing or removing the hard drive
- Allows air to flow around the fan vents. Inadequate or improper air flow can impede proper operation of the unit

Avoid any location for installation:

- That is subject to high vibration
- That is subject to high sunlight levels
- That is subject to drenched of the rain
- Where passengers can interfere with unit
- Next to a heater duct

The following table lists the recommended location options.

Location	Convenient operation	Easy to install	Low vibration	Good air flow
Bottom of glove box- horizontal mount	Yes	Yes	Yes	Yes
Bottom of passenger seat next to the driver	NO	Yes	Yes	Yes
Underneath bulkhead-horizontal mount	Yes	Yes	NO	Yes
Front of bulkhead-horizontal mount	Yes	Yes	Yes	Yes
Beside driver seat -horizontal mount	Yes	Yes	Yes	Yes

Caution: Do not install the DVR on the floor or on the transmission access hatch. These locations have the highest levels of vibration and may be subject to water damage.

■ Possible Installation Locations Inside the Automobile Vehicle: Truck

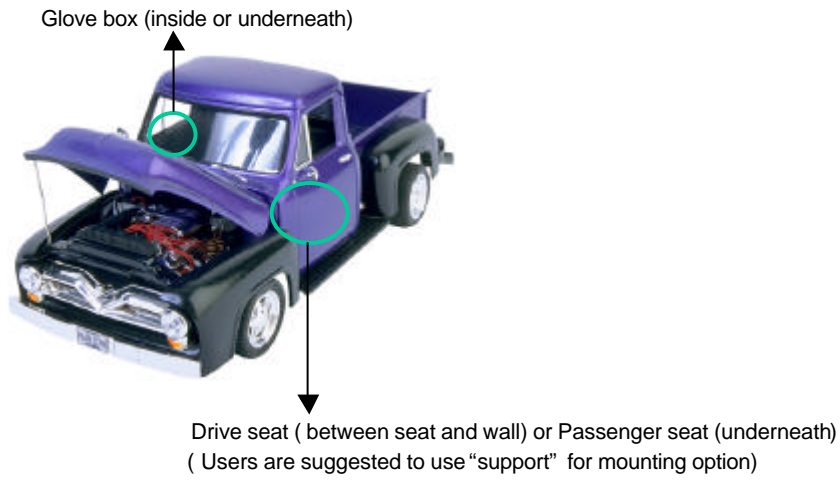

■ Show the wiring on the wiring harness that connects to the electrical system.

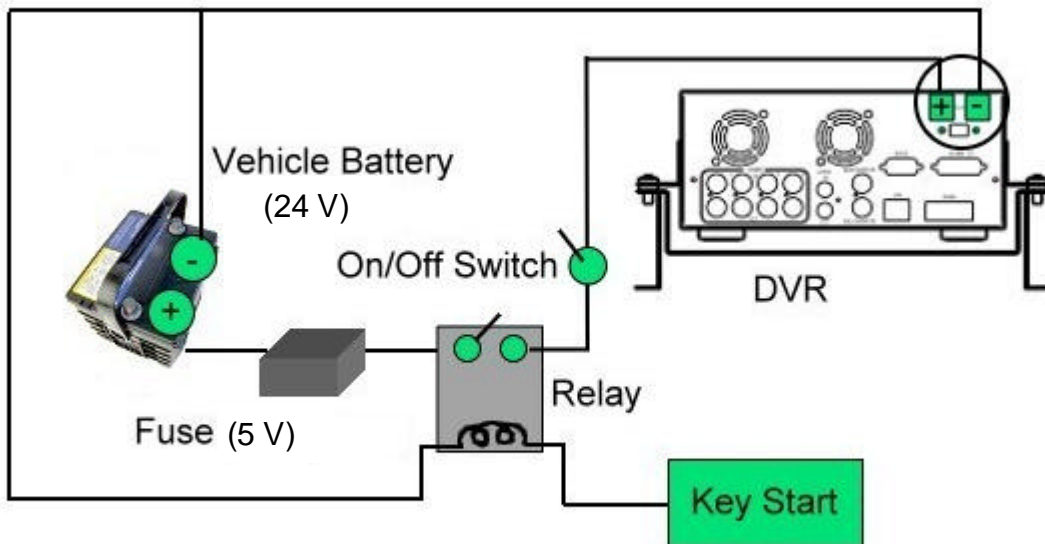

■ Possible Installation Locations Inside the Automobile Vehicle: TOYOTA CAMRY

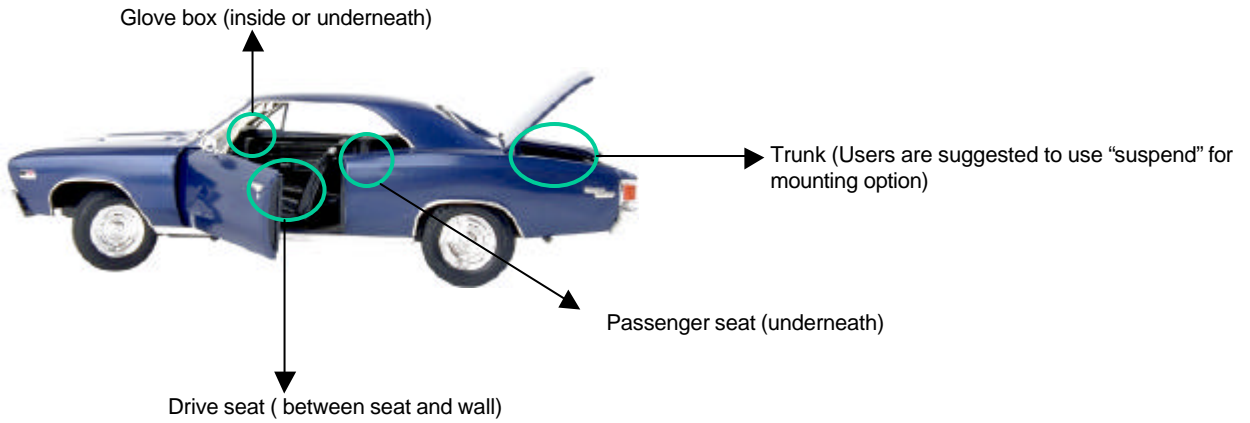

■ Show the wiring on the wiring harness that connects to the electrical system.

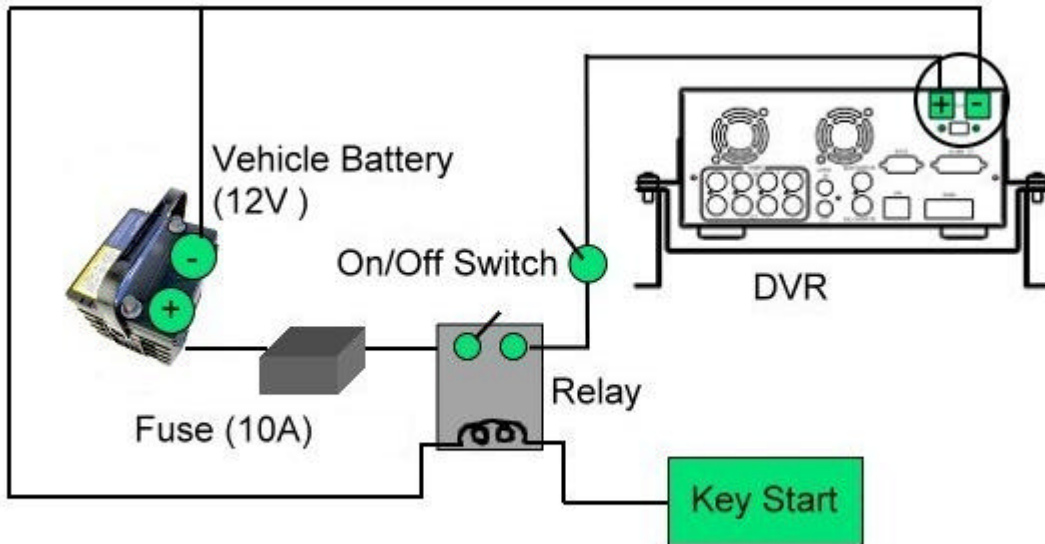

■ Installing the Camera(s) and Monitor

The DVR is typically connected to one camera installed inside the car. Other camera(s) can also be installed in different locations (for example, use the waterproof camera to the outside of vehicle). For installation procedure, refer to the guide that came with the camera(s) you purchased.

The Monitor power supply connects from the Automotive adapter (cigarette plug). Monitor and cameras must be purchased separately.



■ Connect the Camera(s)

Connect the power connector from the camera(s) harness into the CAMERA POWER OUT jack on the back panel of the DVR.

Connect the primary camera(s) video connector to the CAMERA INPUT and the audio connector to the AUDIO INPUT in the back panel.

Adjust the camera(s). After the camera is installed, connect a monitor directly to the camera and observe the image. Make any adjustment if necessary.

■ Installing the Hard Drive

The following figures are for the 3.5" and 2.5" HDD.

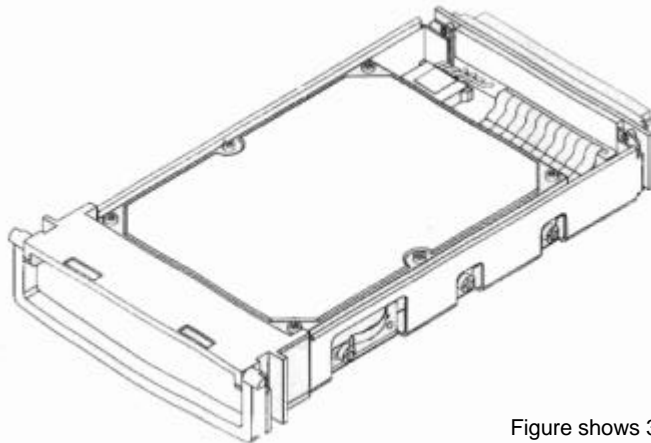

Figure shows 3.5" HDD

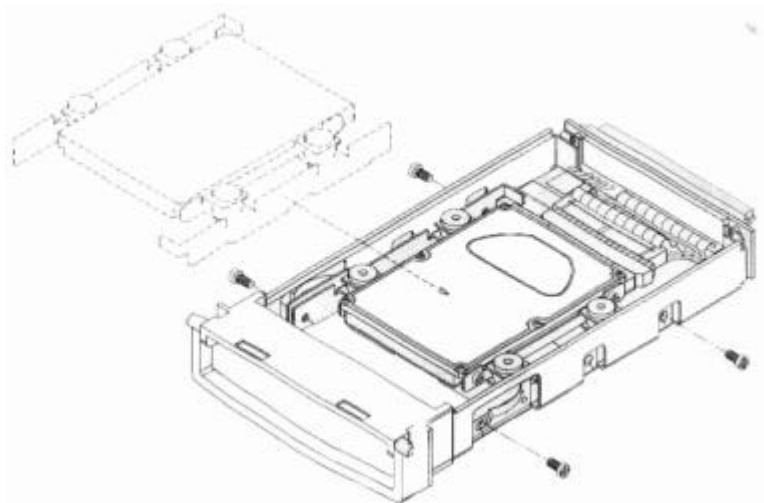

Figure shows 2.5" HDD

3. MENU SETUP

To set up the machine before using is necessary, especially first time to use.



Press the **MENU** key to enter the **MAIN MENU**.
Press the **MENU** key to quit current setting, and go back to last setting.

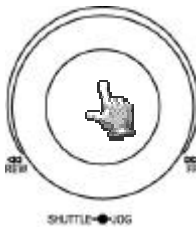

Dial the **Jog** clockwise or counterclockwise to change subentry values.
Press the **ENTER** key to go next subentry in a menu setting, and press the **DISPLAY** key to go last subentry in a menu setting.

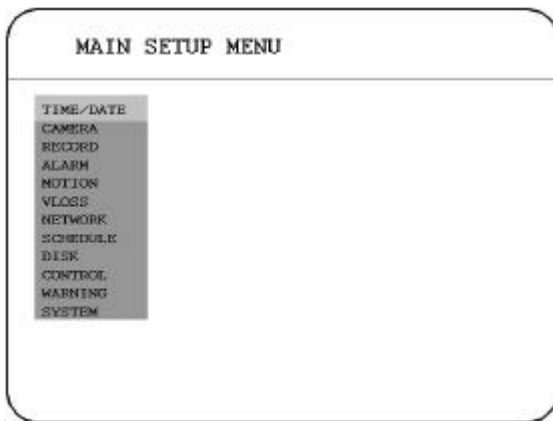

3.1 TIME / DATE SETUP MENU

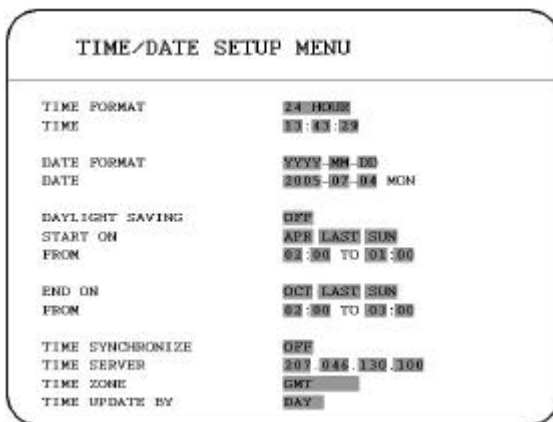

In the **TIME/DATE SETUP MENU**, we define :

(1) TIME FORMAT:

There are two time formats that are **12 HOUR** and **24 HOUR** to be selected.

(2) TIME: Current time

Hour: 00 ~ 23 (1 ~ 12 if **TIME FORMAT** is **12 HOUR**)

Minute : 00 ~ 59

Second: 00 ~ 59

(3) DATE FORMAT:

There are three date formats which are **YYYY-MM-DD**, **MM-DD-YYYY** and **DD-MM-YYYY** to be selected.

(4) DATE: Current date

Date: 01~31 Month:01~12 Year: 2000 ~ 2099 Day:Sun~Mon

(5) DAYLIGHT SAVING:

Select "**ON**" or "**OFF**" to enable or disable daylight saving time function.

In order to set a daylight saving time zone, you need to disable daylight saving first. Enable the daylight saving after finish setting the time zone.

(6) **START TIME:** To set the start time of daylight saving time.

To set the start month of daylight saving time: Dial the jog to set the start month.

JAN	FEB	MAR	APR	MAY	JUN
JUL	AUG	SEP	OCT	NOV	DEC

To set the start week of daylight saving time: Dial the jog to set the start week.

1 ST	2 ND	3 RD	4 TH	LAST
------	------	------	------	------

To set the start date of daylight saving time: Dial the jog to set the start date.

SUN	MON	TUE	WED	THU	FRI	SAT
-----	-----	-----	-----	-----	-----	-----

To set the start time of daylight saving time: To set the start “**FROM**” time and “**TO**” time of daylight saving time.

(7) **END TIME:** To set the end time of daylight saving time.

To set the end month of daylight saving time: Dial the jog to set the end month.

JAN	FEB	MAR	APR	MAY	JUN
JUL	AUG	SEP	OCT	NOV	DEC

To set the end week of daylight saving time: Dial the jog to set the end week.

1 ST	2 ND	3 RD	4 TH	LAST
------	------	------	------	------

To set the end date of daylight saving time: Dial the jog to set the end date.

SUN	MON	TUE	WED	THU	FRI	SAT
-----	-----	-----	-----	-----	-----	-----

To set the end time of daylight saving time: To set the end “**FROM**” time and “**TO**” time of daylight saving time.

(8) TIME SYNCHRONIZE:

Select “**ON**” or “**OFF**” to enable or disable time synchronize which can let you have correct time automatically when network is connected.

(9) TIME SERVER:

You can set the time server address where you locate if you connect to network and enable time synchronize. For checking the IP address of NTP Server, please follow the steps:

1. Connect your PC to the internet for searching the IP address of NTP Server.
2. Go to “START” -> “RUN” -> type “Command” and press “OK”

Under Dos Prompt, type “C:\Ping Pool.NTP.ORG to find out the IP address of NTP Server.

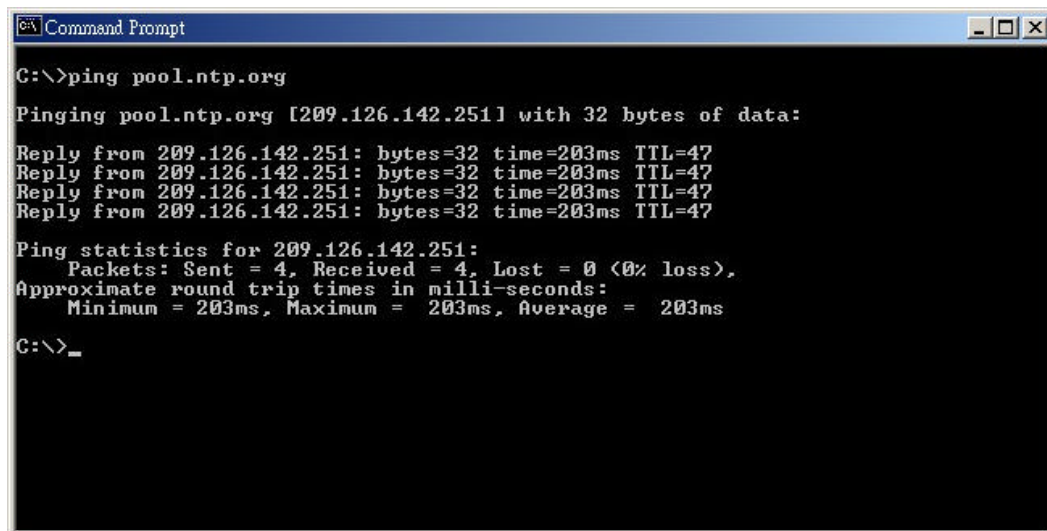

```
Command Prompt
C:\>ping pool.ntp.org
Pinging pool.ntp.org [209.126.142.251] with 32 bytes of data:
Reply from 209.126.142.251: bytes=32 time=203ms TTL=47
Reply from 209.126.142.251: bytes=32 time=203ms TTL=47
Reply from 209.126.142.251: bytes=32 time=203ms TTL=47
Reply from 209.126.142.251: bytes=32 time=203ms TTL=47
Ping statistics for 209.126.142.251:
    Packets: Sent = 4, Received = 4, Lost = 0 (0% loss),
    Approximate round trip times in milli-seconds:
        Minimum = 203ms, Maximum = 203ms, Average = 203ms
C:\>_
```

(10) TIME ZONE:

You can set the time zone where you locate if you connect to network and enable time synchronize.

(11) TIME UPDATE BY:

Once you enable the **TIME SYNCHRONIZE**, you can select the synchronization frequency by:

DAY **WEEK** **MONTH**

3.2 CAMERA SETUP MENU

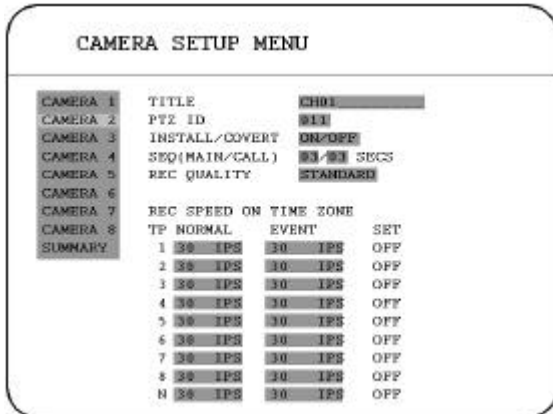

In the **CAMERA SETUP MENU**, we define :

(1) TITLE:

The title setting allows you to assign a title to each camera input.

Titling with 12 characters is supported in each channel.

The available alphanumeric characters are:

0,1,2,3,4,5,6,7,8,9,

A,B,C,D,E,F,G,H,I,J,K,L,M,N,O,P,Q,R,S,T,U,V,W,X,Y,Z,

() . , + - / and an empty space.

(2) PTZ ID: Select PTZ ID from 001~255 or OFF. The default value is 10+N where N is camera's number. This ID must be the same as the ID used in PTZ Dip Switch.

(3) INSTALL/COVERT: For installation of camera; select "ON" to enable a camera, and "OFF" to disable it. Please make sure to stop recording before making change of **INSTALL**. For covert, select "ON" to cover a camera, and disable the screen in live mode to show up. However, the image is recorded, and can be played back by user who has playback right. The covert channels will not show up on the sequence mode.

(4) SEQ(MAIN/CALL): Setup a retention period for sequences.

(5) **REC QUALITY:** Select an image quality for recording. Normal record image quality and event record image quality can be set individually. There are six different qualities available. A higher image quality needs more HDD space. The theory space needed per second lists below:

<u>ESTIMATE BIT SIZE</u>	
SUPERIOR	: 4.0 Mega Bits/sec
HIGH	: 3.5 Mega Bits/sec
STANDARD	: 3.0 Mega Bits/sec
BASIC	: 2.5 Mega Bits/sec
LOW	: 2.0 Mega Bits/sec
LOWER	: 1.5 Mega Bits/sec

Since Variable Bit Rate (VBR) might be used, therefore this table is for your reference only.

(6) **REC SPEED ON TIME ZONE:**

TP: Scheduled recording time 1~8 which can be set in the **SCHEDULE SETUP MENU**.

“N” in the column of “TP” is the normal recording time.

NORMAL: Normal record speed (Images per second) up to 30 IPS. EDR810/410 will adjust to the maximum recording speed by calculating the total installed cameras that have enabled in the **CAMERA SETUP MENU**.

EVENT : Event record speed (Images per second) up to 30 IPS or “**OFF**”.

Note: In order to validate a new record speed, you need to disable all record actions before setting up.

SET: Set “**ON**” when using schedule recording.
Set “**OFF**” when not using schedule recording.

Note: The status of **SET** can only be changed in the **SCHEDULE SETUP MENU**.

(7) SUMMARY :

CAMERA	ITEM	TITLE
CAMERA 1	1	CH01
CAMERA 2	2	CH02
CAMERA 3	3	CH03
CAMERA 4	4	CH04
CAMERA 5	5	CH05
CAMERA 6	6	CH06
CAMERA 7	7	CH07
CAMERA 8	8	CH08
SUMMARY		

Dial **Jog** to change items in the **SUMMARY** table.

All camera's statuses are shown in the **SUMMARY** table. The table is for checking camera overall statuses only, not for setting.

Note: The **SUMMARY** table also exists in **ALARM**, **MOTION** and **VLOSS SETUP MENU**.

All of these **SUMMARY** tables are also for checking particular overall statuses, not for setting.

(8) Copy camera's setting from a camera to other cameras

In order to copy the setting from a camera to other cameras, we provide a setting copy function.

Press **MENU** when you finish setting up a camera, and then press **COPY**. A **COPIED** sign will show up on the top right corner of the screen, and it means the setting has been copied. Dial the **Jog** to the camera you would like to copy, and then press **SEARCH** to paste. The previous setting of the camera will be covered, and a **PASTED** sign will show up.

3.3 RECORD SETUP MENU

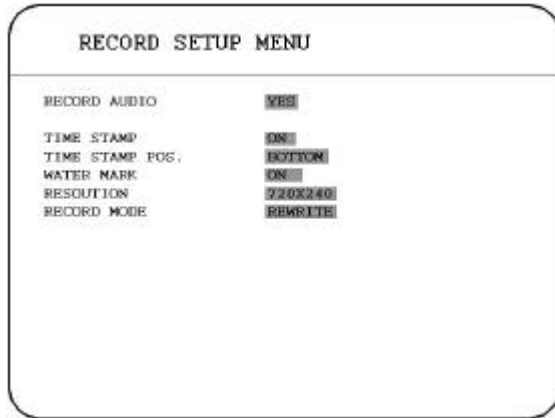

In the **RECORD SETUP MENU**, we define :

(1) RECORD AUDIO:

YES: Audio will be recorded when machine is recording.

NO: Audio will not be recorded when machine is recording.

(2) TIME STAMP:

ON: The time stamp will show on the video and picture when recording.

OFF: The time stamp will not show on the video and picture when recording.

(3) TIME STAMP POS. :

BOTTOM: The time stamp will show on the bottom.

TOP: The time stamp will show on the top.

(4) WATER MARK :

ON: Shows a water mark on the picture when copying image to USB flash memory.

OFF: This erases the water mark on the picture when copying image to USB flash memory.

(5) RESOLUTION:

The resolutions for NTSC are 720x480, 720x240 and 360x240 to be selected. Its default value is 720x240. The resolutions for PAL are 720x288, 720x576 and 360x288 to be selected. Its default value is 720x288.

(6) RECORD MODE:

REWRITE: Continue recording. Disk will be overwritten if it is full.

STOP: Stop recording when disk is full.

3.4 ALARM SETUP MENU

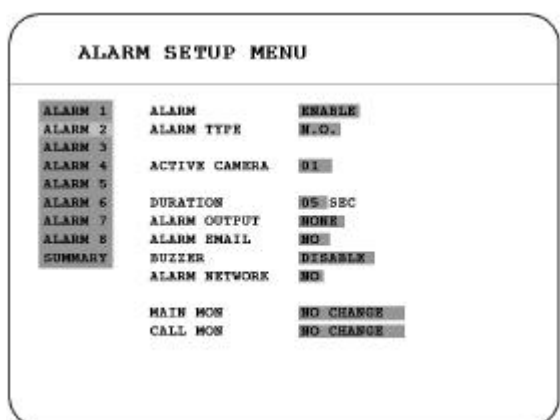

In the **ALARM SETUP MENU**, we define :

(1) ALARM:

ENABLE: Enable alarm detection.

DISABLE: Disable alarm detection.

(2) ALARM TYPE:

N. O. : Normal Open alarm.

N. C. : Normal Close alarm.

N.O. Trans.: When the alarm is triggered, buzzer starts to function no matter how long the alarm duration is set until you set it back to N.O.

N.C. Trans.: When the alarm is triggered, buzzer starts to function no matter how long the alarm duration is set until you set it back to N.C.

(3) ACTIVE CAMERA:

Active camera setting, from camera 01~08. You can set the camera which corresponds to the place where the alarm is located.

Note: The recording camera number in an event depends on the alarm number, and the active camera images will not be recorded. Example: You assign camera 3 as the active camera to alarm 1. When the alarm 1 is triggered, camera 3 will be displayed and camera 1 will be recorded.

(4) DURATION:

Buzzer noise and event record duration of an alarm, from 1 sec to 99 seconds. The default value is 5 seconds.

(5) ALARM OUTPUT:

The setting of alarms which are **NONE** and **1**, where **1** means the alarm is enabled.

(6) ALARM EMAIL:

Select “**YES**” for sending an email when alarm occurs. The email address can be set in the **NETWORK SETUP MENU**.

(7) BUZZER: Alarm buzzer.

ENABLE: To enable an alarm buzzer.

DISABLE: To disable an alarm buzzer.

(8) ALARM NETWORK:

YES: Enable alarm network.

NO: Disable alarm network.

(9) MAIN MON: Display on a main monitor when an alarm occurs.

NO CHANGE: Nothing changes on the display in the main monitor when an alarm occurs.

FULLSCREEN: A full screen will pop up when an alarm occurs.

(10) CALL MON: Display on a call monitor when an alarm occurs.

NO CHANGE: Nothing changes on the display in the call monitor when an alarm occurs.

SEQUENCE: Display in the sequence mode when an alarm occurs.

ACTIVE CAMERA: Display the active camera in full screen mode to the call monitor.

(11) SUMMARY :

Dial **Jog** to change items in the **SUMMARY** table.

All alarm’s statuses are shown in **SUMMARY** tables. These tables are for checking alarm overall statuses, but not for setting.

Note : Please check **APPENDIX C** to see other available alarm input / output functions.

3.5 MOTION SETUP MENU

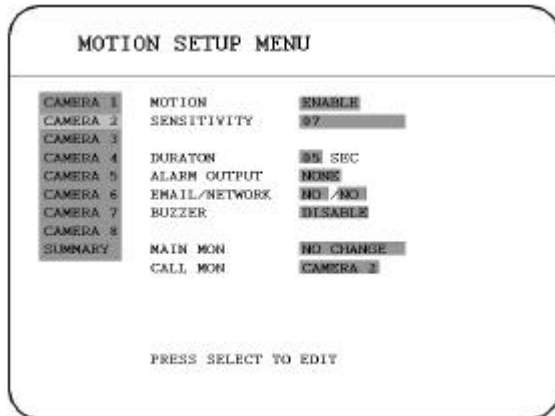

In the **MOTION SETUP MENU**, we define :

(1) MOTION:

ENABLE: Enable motion detection.

DISABLE: Disable motion detection.

Note: Motion only works in live and playback modes. It is invalid when you are setting menus.

(2) SENSITIVITY:

The sensitivity allows users to adjust to a suitable motion detection sensitivity. There are 10 sensitivities available; level 1 is the lowest, and level 10 is the highest sensitivity.

(3) DURATION:

Buzzer noise and event record duration of an alarm, from 1 sec to 99 seconds. The default value is 5 seconds.

(4) ALARM OUTPUT:

The setting of alarms which are **NONE** and **1**, where **1** means the alarm is enabled.

(5) EMAIL/NETWORK:

YES: Send an email / Enable alarm network when an alarm occurs.

NO: Do not send an email / Disable alarm network when an alarm occurs.

The email address and e-mail server can be set in the **NETWORK SETUP MENU**.

(6) BUZZER: Motion buzzer.

ENABLE: To enable a motion buzzer.

DISABLE: To disable a motion buzzer.

(7) MAIN MON: Display on a main monitor when a motion occurs.

NO CHANGE: Nothing changes on the display in the main monitor when a motion occurs.

FULLSCREEN: A full screen pops up when a motion occurs.

(8) CALL MON: Display on a call monitor when a motion occurs.

NO CHANGE: Nothing changes on the display in the call monitor when a motion occurs.

SEQUENCE: Display in the sequence mode when a motion occurs.

ACTIVE CAMERA: Display the active camera in full screen mode to the call monitor.

(9) SUMMARY:

Dial **Jog** to change items in the **SUMMARY** table.

All motion's statuses are shown in **SUMMARY** tables. These tables are for checking motion overall statuses, but not for setting.

(10) EDIT MULTIPLE MOTION AREA

Enter a desired channel, and press **SELECT** to edit a motion area. Please make sure that **MOTION** is set as “**Enable**” before entering the motion detection area.

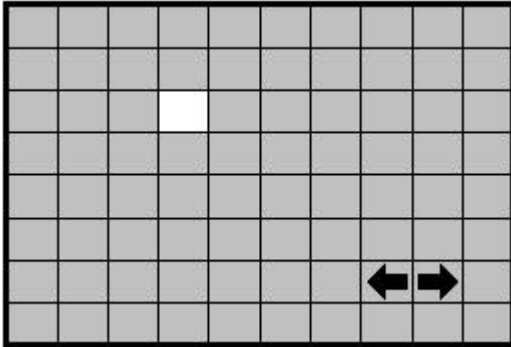





In the motion edit mode:

The default motion area of each camera is entire screen which displays in light green.

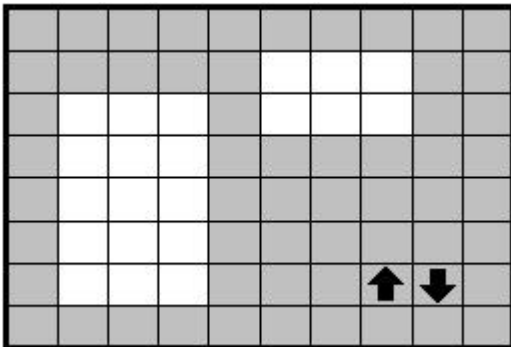
Press **COPY** to start to set an area.

Then press **SEARCH** to end and enable the area, or press **PAUSE** to end and disable the area.



Dial **JOG** to select a horizontal  or a vertical  area, and press **ENTER** to switch a horizontal  or vertical  area.

Press **MENU** to quit the motion area edit.

⚡**To test a motion area:** Grids will turn into light red from light green when a motion is detected.

⚡**To clean up the entire area:** Press **PLAY** to clean up the entire motion area.

⚡**To get a motion area setting hint:** Press **DISPLAY** to get a hint window (shows below) in motion edit mode.

MENU	- EXIT
COPY	- SELECT AREA
ENTER	- CHANGE DIR
SEARCH	- ON AREA
PAUSE	- OFF AREA

3.6 VLOSS SETUP MENU



In the **VLOSS (Video Loss) SETUP MENU**, we define :

(1) VLOSS:

ENABLE: Enable video loss detection.

DISABLE: Disable video loss detection.

(2) DURATION:

Buzzer noise and event record duration of an alarm, from 1 sec to 99 seconds. The default value is 5 seconds.

(3) ALARM OUTPUT:

The setting of alarms which are **NONE** and **1**, where **1** means the alarm is enabled.

(4) ALARM EMAIL:

YES: Send an email when video loss occurs. The email address can be set in the **NETWORK SETUP MENU**.

NO: Not to send the email when video loss occurs.

(5) BUZZER: Video loss buzzer.

ENABLE: To enable a video loss buzzer.

DISABLE: To disable a video loss buzzer.

(6) ALARM NETWORK:

YES: Enable alarm network.

NO: Disable alarm network.

(7) SUMMARY:

All video loss's statuses are shown in **SUMMARY** tables. These tables are for checking video loss overall statuses, but not for setting.

3.7 NETWORK SETUP MENU

There are 5 subentries that are **CONFIG**, **ALARM**, **EMAIL PASSWORD**, and **WIRELESS** in the **NETWORK SETUP MENU**. Each of them has to be set up completely before the network functions.

3.7.1 CONFIG

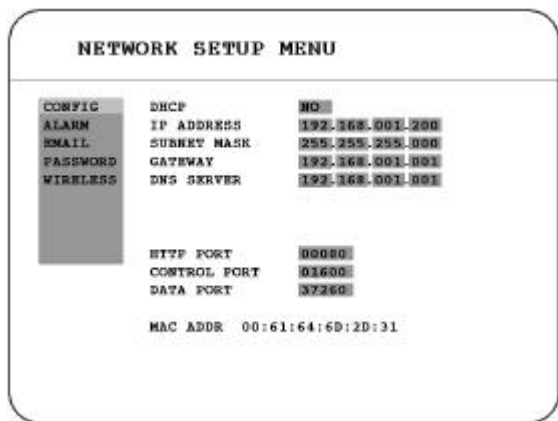

Please Note: Since every Network Configuration is different, please contact your Network Administrator or ISP for how to assign those IP addresses and port numbers.

In the **CONFIG** of the **NETWORK SETUP MENU**, we define :

(1) **DHCP**: Enable or disable the Dynamic Host Communication Protocol.

YES: Enable DHCP service.

NO: Disable DHCP service.

(2) **IP ADDRESS**: Assign an IP address for this unit, for example:192.168.010.200

When DHCP is YES, the DHCP server will assign this value automatically.

(3) **SUBNET MASK**: Assign a subnet mask of the network for this unit, for example:

255.255.255.0. When DHCP is YES, the DHCP server will assign this value automatically.

(4) **GATEWAY**: Assign a default gateway for this unit, for example:192.168.010.001

When DHCP is YES, the DHCP server will assign this value automatically.

(5) **DNS SERVER**: Assign a DNS server to EDR810, for example: 168.195.001.001

When DHCP is YES, the DHCP server will assign this value automatically.

(6) **HTTP PORT:** The default port number is 80. User can change it to different port number for HTTP/WEB communication between DVR and client PC.

(7) **CONTROL PORT:** The default port number is 1600. User can change it to different port number for Controlling comment between DVR and client PC.

(8) **DATA PORT:** The default data transmitting port number is 32760. User can change it to different port number.

(9) **MAC ADDR:** It display out this DVR 's MAC address. Each DVR has unique MAC address. This is non-changeable.

3.7.2 ALARM (Reserved)

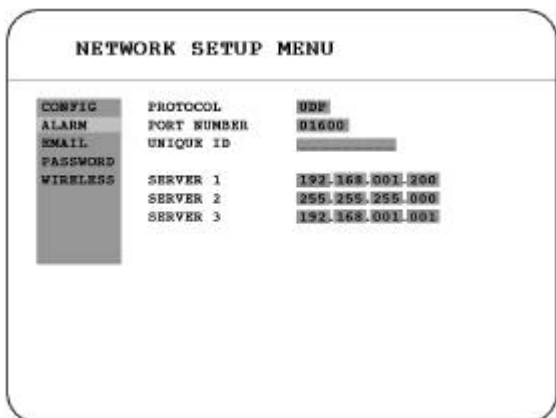

Please Note: Since every Network Configuration is different, please contact your Network Administrator or ISP for how to assign those IP addresses and port numbers.

DVR can send out Alarm message to an Alarm Server. In the **ALARM** of the **NETWORK SETUP MENU**, we define:

(1) **PROTOCOL:** Select which communication protocol with Alarm servers or Alarm receiving clients.

TCP: communicate with client via TCP protocol.

UDP: communicate with client via UDP protocol

(2) **PORT NUMBER:** setting the communication port with Alarm server.

(3) **UNIQUE ID:** setting the ID number of your DVR to Alarm server.

(4) **SERVER 1** : assign the IP address of Alarm server 1.

(5) **SERVER 2** : assign the IP address of Alarm server 2.

(6) **SERVER 3** : assign the IP address of Alarm server 3.

3.7.3 EMAIL

The image shows a screenshot of a 'NETWORK SETUP MENU' interface. On the left, there is a vertical menu with options: CONFIG, ALARM, EMAIL, PASSWORD, and WIRELESS. The 'EMAIL' option is highlighted. The main area of the screen displays the 'SMTP SERVER' configuration. It includes fields for 'SMTP SERVER' (with a text input field), 'PORT NUMBER' (with a dropdown menu showing '0000'), 'AUTHENTICATION' (with a dropdown menu showing 'NO'), 'USER' (with a text input field), 'PASSWD' (with a text input field), and 'EMAIL ADDR' (with a text input field).

In the **EMAIL** of the **NETWORK SETUP MENU**, we define :

- (1) **SMTP SERVER:** assign the SMTP (e-mail) server's IP address.
- (2) **PORT NUMBER:** assign the port number for SMTP server.
- (3) **AUTHENTICATION:** select "YES", if the SMTP server requires Authentication/Login.
- (4) **USER:** Input the login user ID if the SMTP server requires Authentication.
- (5) **PASSWD:** Input the password if the SMTP server requires Authentication.

(6) **EMAIL ADDR:** Input the e-mail address for receiving e-mail message when the EVENT is enabled and triggered. For example: In Motion Setup Menu, if the “EMAIL/NETWORK” is set to “YES”, this e-mail address will receive a text message and an “ARV” format of a still image from DVR when Motion is triggered. This “ARV” file can be played back by opening “EDRViewer.exe” that you downloaded from the DVR or the Remote Viewer.

In Alarm Setup Menu, if the “ALARM EMAIL” is set to “YES”, this e-mail address will receive a text message and an “ARV” format of a still image from DVR when the Alarm is triggered. This “ARV” file can be played back by opening “EDRViewer.exe” that you downloaded from the DVR or the Remote Viewer.

Note: If you are unable to play “AVI” file downloaded from “EDRViewer”, please go to the following URL:

<http://www.divx.com/divx/play/download/index.php>

for downloading DivXPlay.exe. This will enable you to play “AVI” file successfully.

3.7.4 PASSWORD

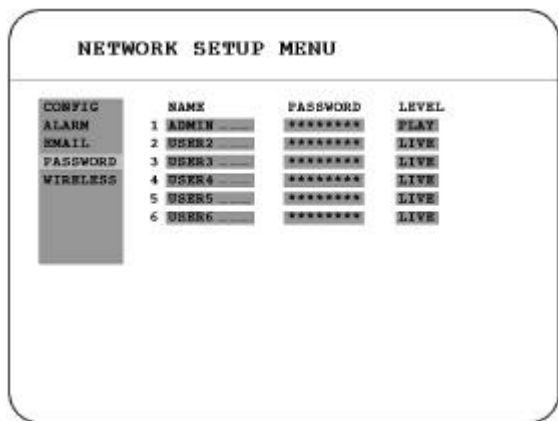

CONFIG	NAME	PASSWORD	LEVEL
ALARM	1 ADMIN	*****	PLAY
EMAIL	2 USER2	*****	LIVE
PASSWORD	3 USER3	*****	LIVE
WIRELESS	4 USER4	*****	LIVE
	5 USER5	*****	LIVE
	6 USER6	*****	LIVE

In the **PASSWORD** of the **NETWORK SETUP MENU**, we define :

- (1) **NAME:** assign the login name for remote accessing.
- (2) **PASSWORD:** assign the password for remote accessing.
- (3) **LEVEL:** assign the accessing Right/Priority of that login user. “PLAY” allows users to playback the video and to see live images. “LIVE” only allows users to see live images.

3.7.5 WIRELESS (This section is reserved for models that have WIRELESS function)

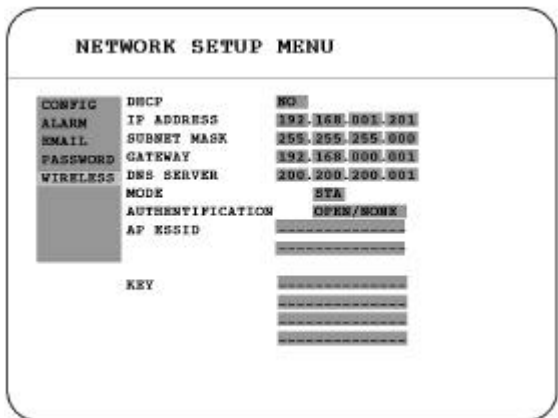

In the **WIRELESS** of the **NETWORK SETUP MENU**, we define :

(1) **DHCP:** Enable or disable the Dynamic Host Communication Protocol.

YES: Enable DHCP service.

NO: Disable DHCP service.

(2) **IP ADDRESS:** Assign an IP address for this unit, for example:192.168.010.200

When DHCP is YES, the DHCP server will assign this value automatically.

(3) **SUBNET MASK:** Assign a subnet mask of the network for this unit, for example:

255.255.255.0. When DHCP is YES, the DHCP server will assign this value automatically.

(4) **GATEWAY:** Assign a default gateway for this unit, for example:192.168.010.001

When DHCP is YES, the DHCP server will assign this value automatically.

(5) **DNS SERVER:** Assign a DNS server for this unit, for example: 168.195.001.001

When DHCP is YES, the DHCP server will assign this value automatically.

(6) **MODE:** STA (Station).

(7) **AUTHENTICATION:**

Select from **OPEN/NONE**, **OPEN/WEP**, **SHARED/NONE**, **SHARED/WEP** or **WPAPSK/TKIP**.

(8) **AP ESSID:** Enter the SSID of AP to be connected.

(9) **KEY:** Password of the AP.

3.8 SCHEDULE SETUP MENU

SCHEDULE SETUP MENU				
SCH	DAY	START	END	SET
1	WEND	00 :00	12 :00	ON
2	WDAY	00 :00	12 :00	ON
3	DLY	12 :00	12 :00	ON
4	DLY	00 :00	10 :00	OFF
5	DLY	00 :00	10 :00	OFF
6	DLY	00 :00	10 :00	OFF
7	DLY	00 :00	10 :00	OFF
8	DLY	00 :00	10 :00	OFF

DLY	=	DAILY
WDAY	=	MON to FRI
WEND	=	SAT and SUN

In the **SCHEDULE SETUP MENU**, we define :

(1) DAY:

MON (Monday), **TUE** (Tuesday), **WED** (Wednesday), **THU** (Thursday), **FRI** (Friday),
SAT (Saturday), **SUN** (Sunday).

WDAY: Weekday, from Monday to Friday.

WEND: Weekend, Saturday and Sunday.

DLY: Daily.

(2) START: The start time of a scheduled record time zone.

Hour: 0 ~ 23 in 24 hour time format; 1~12 in 12 hour time format.

Minutes: 00 ~ 59

(3) END: The end time of a scheduled record time zone.

Hour: 0 ~ 23 in 24 hour time format; 1~12 in 12 hour time format.

Minutes: 00 ~ 59

(4) SET :

ON: Enable a scheduled record time zone.

OFF: Disable a scheduled record time zone.

3.9 DISK SETUP MENU

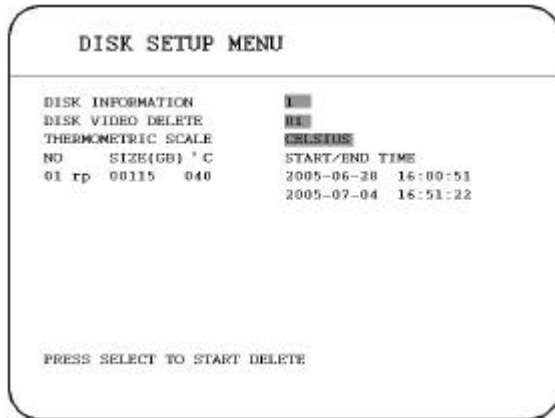

In the **DISK SETUP MENU**, we define :

(1) **DISK INFORMATION:** Only one disk is available in this model.

(2) **DISK VIDEO DELETE:** Select the disk that you wish to delete, then press SELECT button from the front panel to start deletion.

Note: This option is not available in this model.

(3) **THERMOMETRIC SCALE:** Select **CELSIUS** or **FAHRENHEIT** for thermometric scale of the disk.

3.10 CONTROL SETUP MENU

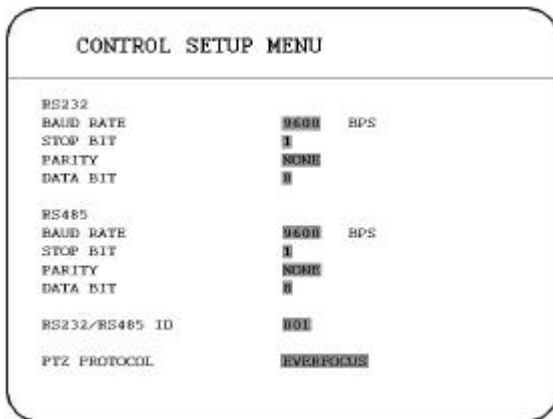

In the **CONTROL SETUP MENU**, we define :

(1) RS 232:

BAUD RATE: There are 5 different speeds that can be used to transmit instruction or information through the RS232 port on the device, which are **2400, 4800, 9600, 19200, 38400** and **57600** BPS. The default setting from the factory is 9600 BPS.

STOP BIT: Select stop bit : **1** or **2**.

PARITY: Select parity level : **NONE, ODD** or **EVEN**.

DATA BIT: Select data bit : **7** or **8**. The default setting from the factory is 8.

Note: RS 232 pin definition is shown in **APPENDIX A**.

(2) RS 485:

BAUD RATE: There are 5 different speeds that can be used to transmit instruction or information through the RS485 port on the device, which are **2400, 4800, 9600, 19200, 38400** and **57600** BPS. The default setting from the factory is 9600 BPS.

STOP BIT: Select stop bit : **1** or **2**.

PARITY: Select parity level : **NONE, ODD** or **EVEN**.

DATA BIT: Select data bit : **7** or **8**. The default setting from the factory is 8.

Note: RS 485 pin definition is shown in **APPENDIX B**.

(3) RS 232 / RS 485 ID: Select ID from **001** to **255**.

(4) PTZ PROTOCOL: Select PTZ protocol from **EVERFOCUS, PELCO-D, PELCO-P** and **ED2200/2250**.

3.11 WARNING SETUP MENU

In Warning Setup Menu, you will be able to do warning setting when the following situations occur:

3.11.1 FAN FAULT

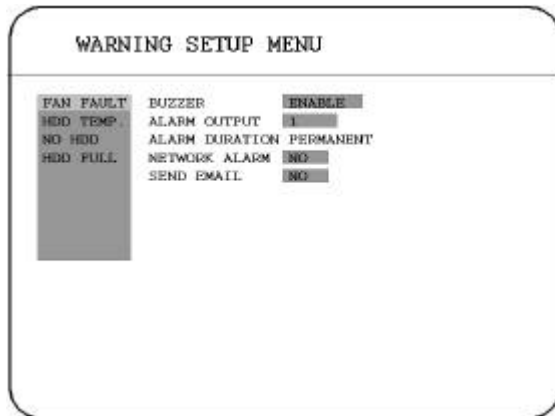

In **FAN FAULT**, we define:

- (1) **BUZZER:** Fan buzzer.

ENABLE: To enable a buzzer when the fan does not work.

DISABLE: To disable buzzer.

- (2) **ALARM OUTPUT:**

The setting of alarms which are **NONE** and **1**, where **1** means the alarm is enabled.

- (3) **ALARM DURATION: PERMANENT**

- (4) **NETWORK ALARM:**

YES: To enable network alarm.

NO: To disable network alarm.

- (5) **SEND EMAIL:**

YES: Send an email when the fan does not work.

NO: Do not send an email when the fan does not work.

The email address can be set in the **NETWORK SETUP MENU**.

3.11.2 HDD TEMP.

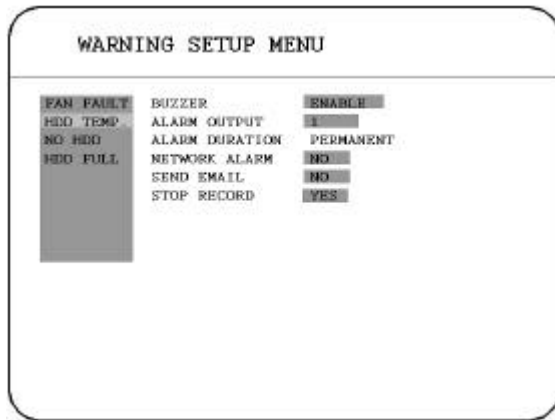

In **HDD TEMP.**, we define:

- (1) **BUZZER:** HDD TEMPERATURE buzzer.
ENABLE: To enable a buzzer when HDD's temperature is over 70 ° C.
DISABLE: To disable buzzer.

- (2) **ALARM OUTPUT:**
The setting of alarms which are **NONE** and **1**, where **1** means the alarm is enabled.

- (3) **ALARM DURATION: PERMANENT**

- (4) **NETWORK ALARM:**
YES: To enable network alarm.
NO: To disable network alarm.

- (5) **SEND EMAIL:**
YES: Send an email when HDD's temperature is overheated.
NO: Do not send an email when HDD's temperature is overheated.
The email address can be set in the **NETWORK SETUP MENU**.

- (6) **STOP RECORD:**
YES: Stop recording when HDD's temperature is overheated.
NO: Won't stop recording even when HDD's temperature is overheated.

3.11.3 NO HDD

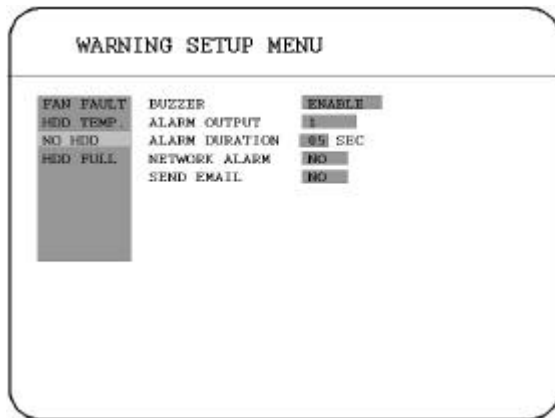

In **NO HDD**, we define:

- (1) **BUZZER:** NO HDD buzzer.
ENABLE: To enable a buzzer when no HDD has been found.
DISABLE: To disable buzzer.

- (2) **ALARM OUTPUT:**
The setting of alarms which are **NONE** and **1**, where **1** means the alarm is enabled.

- (3) **ALARM DURATION:** Buzzer noise and event record duration of an alarm, from 1 sec to 99 seconds. The default value is 5 seconds.

- (4) **NETWORK ALARM:**
YES: To enable network alarm.
NO: To disable network alarm.

- (5) **SEND EMAIL:**
YES: Send an email when no HDD has been found.
NO: Do not send an email when no HDD has been found.
The email address can be set in the **NETWORK SETUP MENU**.

3.11.4 HDD FULL

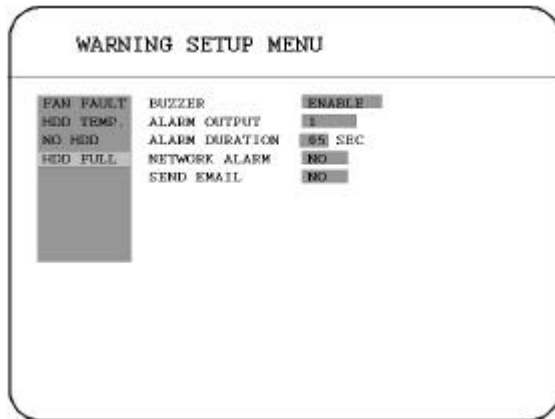

In **HDD FULL**, we define:

- (1) **BUZZER:** HDD FULL buzzer.
ENABLE: To enable a buzzer when HDD is full.
DISABLE: To disable buzzer.
- (2) **ALARM OUTPUT:**
The setting of alarms which are **NONE** and **1**, where **1** means the alarm is enabled.
- (3) **ALARM DURATION:** Buzzer noise and event record duration of an alarm, from 1 sec to 99 seconds. The default value is 5 seconds.
- (4) **NETWORK ALARM:**
YES: To enable network alarm.
NO: To disable network alarm.
- (5) **SEND EMAIL:**
YES: Send an email when HDD is full.
NO: Do not send an email when HDD is full.
The email address can be set in the **NETWORK SETUP MENU**.

3.12 SYSTEM SETUP MENU

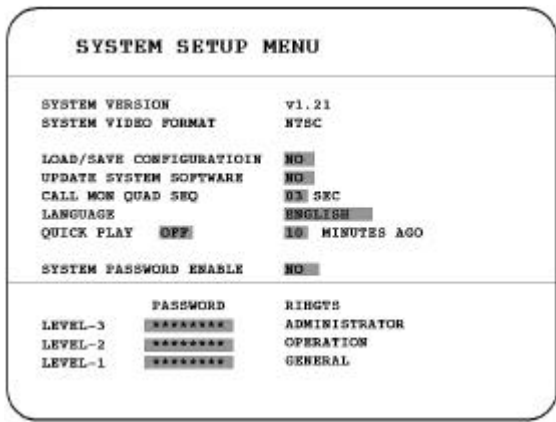

In the **SYSTEM SETUP MENU**, we define :

(1) **SYSTEM VERSION:** Current system firmware version.

(2) **SYSTEM VIDEO FORMAT:** NTSC or PAL. System can detect the input signal type automatically from camera 1 while system is booting up. Users do not need to set it up.

Note: The signal type is detected by the camera 1, so camera 1 input has to be connected.

(3) **LOAD/SAVE CONFIGURATION:**

YES: Dial the jog to enter the selection window, there are 4 options available: **CANCEL**, **DEFAULT**, **LOAD**, and **SAVE**. Select “CANCEL” for leaving the existing window. Select “DEFAULT” to load factory default values. Select “LOAD” to load saved setting from USB. Select “SAVE” to save existing settings to USB device. Press “**SELECT**” button from the front panel to confirm once the selection is made. Please note that a USB device has to be inserted properly before choosing “LOAD” or “SAVE” options. System will ask you to stop recording if you confirm to load default setting, to load saved setting or to save existing setting when the system is recording.

NO: Press “ENTER” to leave “LOAD/SAVE CONFIGURATION”.

(4) **UPDATE SYSTEM SOFTWARE:** Dial the jog to enter the selection window.

YES: Select **YES** to update system software from USB by pressing **SELECT** to start.

NO: Select **NO** for canceling updating by pressing **SELECT** to start.

Note: 1. System will ask you to stop recording if you confirm to update when system is recording.

2. USB device must be inserted properly before updating system software.

3. Do not remove USB device when you are updating system software, it may cause crash to the machine.

(5) **CALL MON QUAD SEQ:** The retention period of the call monitor quad display in the sequence mode.

Note: Please refer to **CALL** setting for an advanced call monitor setting.

(6) **LANGUAGE:**

Note: Three languages are available to be chosen: English, Chinese and Japanese. Subject to change without further notice. Please consult your sales representative for the most update information.

(7) **QUICK PLAY:** Set up the start play time of the normal play mode.

ON: Enable quick play. The video played time is the immediate play time from now.

OFF: Disable quick play. Videos will start to be played from the end point of the last play.

TIME: Quick play time, from 00:00 to 59:59. The default value is 10 minutes.

Note: The recommendatory quick play time is 10 minutes. The video cannot be played due to the video file is not stored to HDD yet if you set a quick play time too short.

(8) **SYSTEM PASSWORD ENABLE :**

YES: Select **YES** to enable the password function.

NO: Select **NO** to disable the password function.

(9) **PASSWORD and RIGHTS :**

The login passwords here are used to operate and set up this machine. The different login passwords indicate the different level of users, and no login name is necessary.

The digit will show up instead of a “*” sign when the cursor is moved on it. Dial the Jog to change the digit on which the cursor is located of the password, and press **ENTER/DISPLAY** to go next/last digit. The available digits are **1, 2, 3, 4, 5, 6, 7, and 8.**

There are three system access levels and one none access level. The below chart on the next page shows the rights of each level.

Note: If the passwords of different levels are set the same, you will enter a higher level when you login. For example, you will login to the **ADMINISTRATOR** level if the password of **ADMINISTRATOR** and **GENERAL** levels are the same.

Note: After upgrading system software, please do the following actions before recording:

1. Load System Default in **System Setup Menu**.
2. Delete disk in **Disk Setup Menu**.

User Level and Right V. 1.0				
LEVEL RIGHT	LEVEL-3 ADMINISTRATOR	LEVEL-2 OPERATOR	LEVEL-1 GENERAL	NONE ACCESS ----
DISPLAY	OK	OK	OK	OK
MODE	OK	OK	OK	OK
ZOOM	OK	OK	OK	OK
FULL	OK	OK	OK	OK
SELECT	OK	OK	OK	NO
SEQ	OK	OK	OK	NO
CALL	OK	OK	NO	NO
MENU	OK	NO	NO	NO
COPY	OK	NO	NO	NO
SEARCH	OK	NO	NO	NO
PLAY	OK	NO	NO	NO
STOP	OK	NO	NO	NO
REV.PLAY	OK	NO	NO	NO
REC	OK	NO	NO	NO
PAUSE	OK	NO	NO	NO

Note: The above table will be updated if there is any change.

4. RECORDING

4.1 INSTANT RECORDING

- Press the Record key to start recording immediately.



REC

When **REC** is pressed, the pictures being monitored will be recorded in the HDD.

- The recording rate, recording quality and recording speed can be set in the **CAMERA SETUP MENU**.
- A “**RECORD**” sign appears in the record status bar.



STOP

Press **STOP** key to stop instant recording.

- The **STOP** key can be activated only in instant recording mode, but not available in the schedule or event recording mode.
- When the HDD is full, the machine will stop recording automatically or overwrite from the beginning of the HDD. It depends on the setting in the **RECORD SETUP MENU**.

- Note:**
1. If **STOP** key is pressed while machine is recording or playing video, the playing function will be disabled first.
 2. Do not remove the hard disk while machine is recording. Or stop recording first before removing the hard disk.

4.2 SCHEDULE RECORDING

- Set up the **DAY**, **START** time, **END** time and then enable **SET** function in the **SCHEDULE SETUP MENU**.

Please refer to **SCHEDULE SETUP MENU**, to see setting procedure and more details.

SCHEDULE SETUP MENU				
SCH	DAY	START	END	SET
1	WEND	00:00	12:00	ON
2	WDAY	00:00	17:00	ON
3	DLY	17:00	23:00	ON
4	DLY	00:00	00:00	OFF
5	DLY	00:00	00:00	OFF
6	DLY	00:00	00:00	OFF
7	DLY	00:00	00:00	OFF
8	DLY	00:00	00:00	OFF

DLY	=	DAILY
WDAY	=	MON To FRI
WEND	=	SAT and SUN

4.3 EVENT RECORDING

We define two event types which are **ALARM** and **MOTION** events that can be recorded. After the event recording is enabled, the **EDR810/410** will start an event recording when an event occurs.

In order to start an event recording, you need:

1. Enable the event in each event setting first. For example, to enable alarm 2 in the **ALARM SETUP MENU**(shown as below). You can also enable more alarms, or add a motion event.

ALARM SETUP MENU		
ALARM 1	ALARM	ENABLE
ALARM 2	ALARM TYPE	MOTION
ALARM 3		
ALARM 4	ACTIVE CAMERA	01
ALARM 5		
ALARM 6	DURATION	05 SEC
ALARM 7	ALARM OUTPUT	NONE
ALARM 8	ALARM EMAIL	NO
SUMMARY	BUZZER	DISABLE
	ALARM NETWORK	NO
	MAIN MON	NO CHANGE
	CALL MON	NO CHANGE

2. After enable an event, you need to set a time zone in the **SCHEDULE SETUP MENU**. An event recording has to be included in a scheduled time zone. You can refer to **SCHEDULE SETUP MENU** to set up a time zone which you would like to record when an event occurs.

3. When the event and schedule are set, you can enter the **CAMERA SETUP MENU** to set the event recording speed (IPS) of a camera in the time zone you set.

Note: You can set the time zone from 00:00 to 00:00 daily in the **SCHEDULE SETUP MENU**, and set the normal record speed as **0 IPS** in the **CAMERA SETUP MENU** if you only need events recording all the time.

4.4 ALARM INPUT RECORDING (Input trigger)

EDR810/410 provides a record function which is triggered by external signal via the 19th pin of the **ALARM INPUT / OUTPUT** port. When the record input signal is pulled low constantly, **EDR810/410** will start to record. The system will stop recording when the record input signal is not pulled low.

Note: Please check **APPENDIX C** to see other available alarm input/output functions.

5. PLAYING BACK

5.1 NORMAL PLAYBACK

(1) Playback



PLAY

Press the **PLAY** key to start playing back the stored image/audio. The video start time depends on the immediate play setting in the **SYSTEM SETUP MENU**.



REV.PLAY

Press the **REV. PLAY** key to start reverse playing back the stored image/audio from the last segment.

(2) STOP



STOP

Press the **STOP** key to stop playing back.

(3) Fast Forward/Reverse Playback



PLAY

Press the **PLAY** key to start playing back.

Turn the **Shuttle** dial clockwise, to start fast forward playback.

The speed will be shown on the status bar of the bottom screen.

>> **2, 4, 6, 8, 16, 32X**, and press **ENTER** at the same time to fasten the play speed.

Press **PLAY** again to return normal play speed.

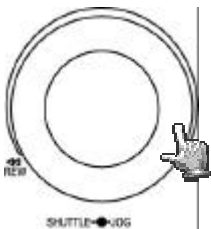

Turn the **Shuttle** dial counterclockwise, to start fast reverse playback.

The speed will be shown on the status bar of the bottom screen.

<< **2, 4, 6, 8, 16, 32X**, and press **ENTER** at the same time to fasten the play speed.

Press **PLAY** again to return normal play speed.

(4) Slow Forward/Reverse Playback



PAUSE

During playback mode, press **PAUSE** key to freeze the playing back picture.

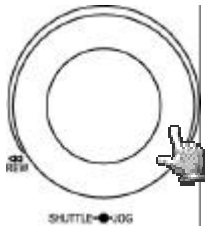

Turn the **Shuttle** dial clockwise, to start slow forward playback.

The speed will show on the status bar of the bottom screen.

>> **1/2, 1/4, 1/8, 1/16, 1/32**, and press **ENTER** at the same time to fasten the play speed.

(5) Image advance Forward/Reverse



PAUSE

Press **PAUSE** key to freeze the picture.

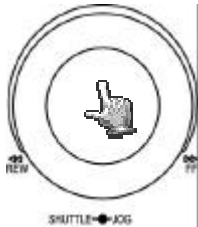

Turn the **Jog** dial clockwise to advance the still video image by image.

Turn the **Jog** dial counterclockwise to rewind the still video image by image.

The field feed speed will increase if the **Jog** dial is turned quickly.

5.2 SEARCH PLAYBACK



Press the **SEARCH** key to enter the **SEARCH MENU**.

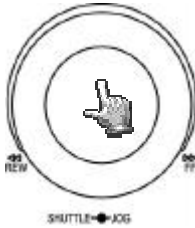

In the **SEARCH MENU**,

Dial the **Jog** clockwise or counterclockwise to change subentry values.

Press **ENTER** key to go next subentry in search menu setting, and press

DISPLAY key to go last subentry in search menu setting.

Press **MENU** to exit.

Press **SELECT** to start search.

(1) TIME / DATE Search Playback

The following window will show up after pressing **SEARCH** key. Select "**BY TIME / DATE**",

and then select the time you want to search. Press **SELECT**, the system will start to search.



EVENT is not able to be changed in the "**BY TIME / DATE**" search method. Size of total data file, HDD temperature, start recording time and end recording time of the disk show in the search screen.

Note: If there is no image stored in the date/time specified, then the image will keep at the end of the last play, and the display time on the status bar shows "??:??".

(2) EVENT Search Playback

You can change different event search methods if you select “**BY EVENT**” instead of “**BY TIME / DATE**”. 7 events which are **ALARM, MOTION, VLOSS, A/M, A/V, M/V** and **A/M/V** can be selected.

The indications of events show as below.

EVENT	Indication
ALARM	Search ALARM events
MOTION	Search MOTION events
VLOSS	Search video loss events
A / M	Search ALARM and MOTION events
A / V	Search ALARM and video loss events
M / V	Search MOTION and video loss events
A / M / V	Search all events (ALARM, MOTION and video loss)

DATE and **TIME** are not able to be changed in the **EVENT** search method. The search list shows up when **SELECT** key is pressed. There are 16 events in one page, and current page / total pages shows on the top.

Dial **Shuttle** clockwise or press **COPY** for moving to next page; dial **Shuttle** counterclockwise or press **DISPLAY** for moving to previous page. If you would like to jump to a specific page directly, you can press **Search**, then dial **Jog** to the page, and press **Enter**.

Dial the **Jog** to change events on the event list; the selected item will be highlighted. Press **ENTER** to play the selected event.

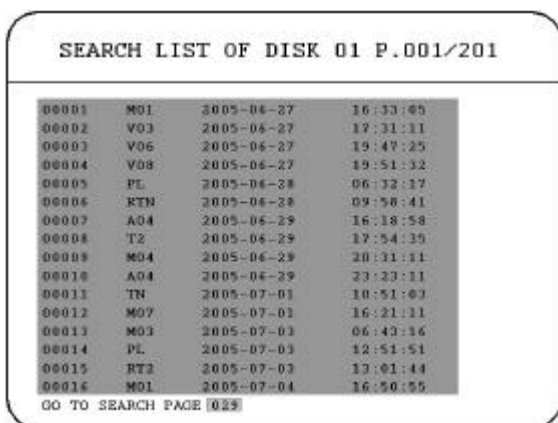

The event types and number show on the second column of the search list. Where

- A:** an alarm event;
- M:** a motion event;
- V:** a video loss event;
- TN:** an instant record event;
- Tn:** a schedule record event, n=1~8;
- PL:** a power loss event;
- RTN:** a power return event in an instant record;
- RTn:** a power return event in a schedule record, n=1~8.
- PH** (Physical Head): which is the beginning point of HDD’s space;
- LH** (Logical Head): Beginning of recording date & time right after HDD has been overwritten.

The number after letter indicates the number of even type. The last two columns are the date and time of event.

6. COPY TO A VIDEO FILE

Insert a USB pocket driver into USB slot on the front panel to copy.

USB SLOT:

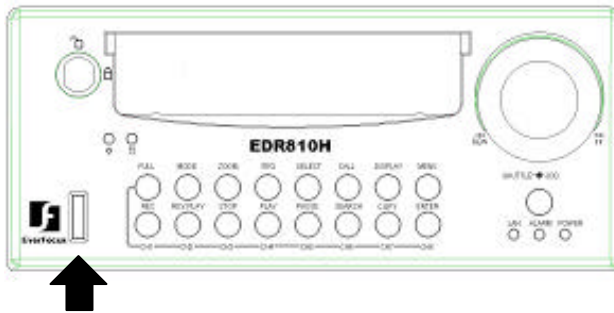

Digital Video Recorder allows users to select the camera for copying image to movie file or copying EDR Viewer player. The camera title will be displaying at the top of the screen.



Press **COPY** key and then the copy menu appears.

COPY

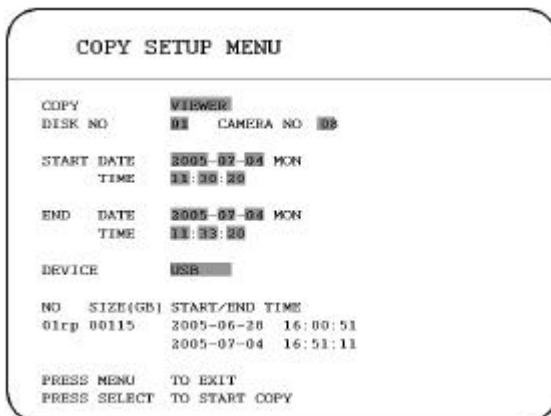

In the **COPY MENU**, we define:

COPY: Select **Image** for copying images to movie file.

Select **Viewer** for copying EDR viewer player.

DISK NO: Disk number. It is fixed as “01” in this series.

CAMERA NO: Camera channel number. You can select the video of camera you would like to copy.

START DATE & TIME: The start time of video you want to copy.

END DATE & TIME: The end time of video you want to copy.

DEVICE: The storage you want to store the file. The available device for this model is USB.

Press **SELECT** to copy after setting up everything.

An upload percentage will show up during video copy.

Copying image in bookmark mode:

1. During playing back, press **COPY** button and it will bookmark the starting copy point.
Then, **STOP** playing back. Press **COPY** button again, you will see the **START TIME** has been changed to the “Bookmark time”. The end time is preset to 5 minutes later. You can change it to other value as desire.

7. CALL

Press the **CALL** key and the **CALL MENU** will pop up as below.

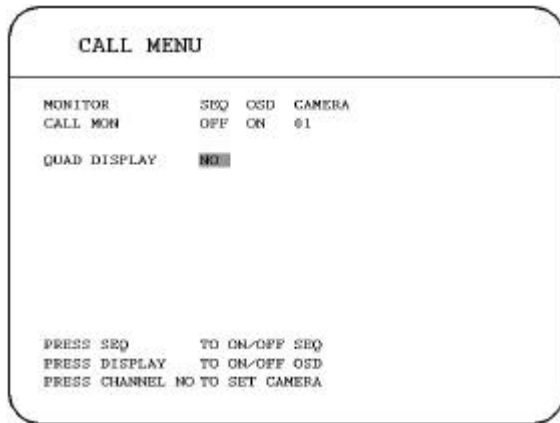

In **CALL MENU**, we define :

- (1) **SEQ:** Sequence display on the call monitor. Press **SEQ** to switch “**ON**” or “**OFF**” of the sequence status.
- (2) **OSD:** Channel name display on the call monitor. Press **DISPLAY** to switch “**ON**” or “**OFF**” of the **OSD** status.
- (3) **CAMERA:** The display camera in the call monitor.
- (4) **QUAD DISPLAY:** Display quad in the call monitor.
Dial **Jog** to enable (“**YES**”) or disable (“**NO**”) **QUAD DISPLAY** on the call monitor.

(a) **SEQ is OFF:**

When **QUAD DISPLAY** is “**NO**”, press **FULL + Channel key** to assign a specific full screen in the call monitor.

When **QUAD DISPLAY** is “**YES**” (enabled), press **FULL + CH 1** or **CH2** to display a quad screen in the call monitor. Press **FULL + CH 1** to display channel 1 to channel 4 in the call monitor, and press **FULL + CH 2** to display channel 5 to channel 8 in the call monitor.

(b) SEQ is ON:

When **QUAD DISPLAY** is “**NO**”, the call monitor displays a sequence full screen of each channel.

When **QUAD DISPLAY** is “**YES**” (enabled), the call monitor displays a sequence quad screen.

8. SCREEN DISPLAY SETTING

In a full screen display, press **SELECT** key to pop up the display adjustment window as below:

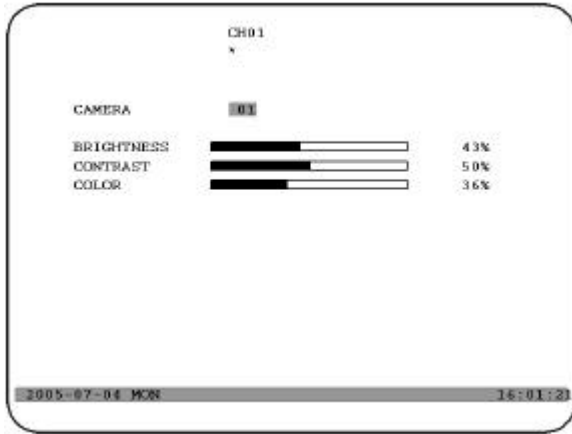

In the screen display setting menu, we define:

- (1) **CAMERA:** The display setting of the current camera.
- (2) **BRIGHTNESS:** The bright percentage of the current camera; from 0% to 100%.
- (3) **CONTRAST:** The contrast percentage of the current camera; from 0% to 100%.
- (4) **COLOR:** The color percentage of the current camera; from 0% to 100%.

The selected item will show in red color bar. Use **Jog** to increase or decrease the value. Press **ENTER** to confirm the setting value and move to next item. After finished setting, press **SELECT** or **MENU** key to save and exit the dialog. Total of 8 channels are adjustable.

Pressing **ZOOM** button from front panel will enable you to do screen adjustment. Dial the **Jog** to move leftward and rightward.

9. SCREEN DISPLAY MODE

Press **MODE** to switch 4, 7, 8, and PIP (picture in picture) displays for Live and Playback mode.

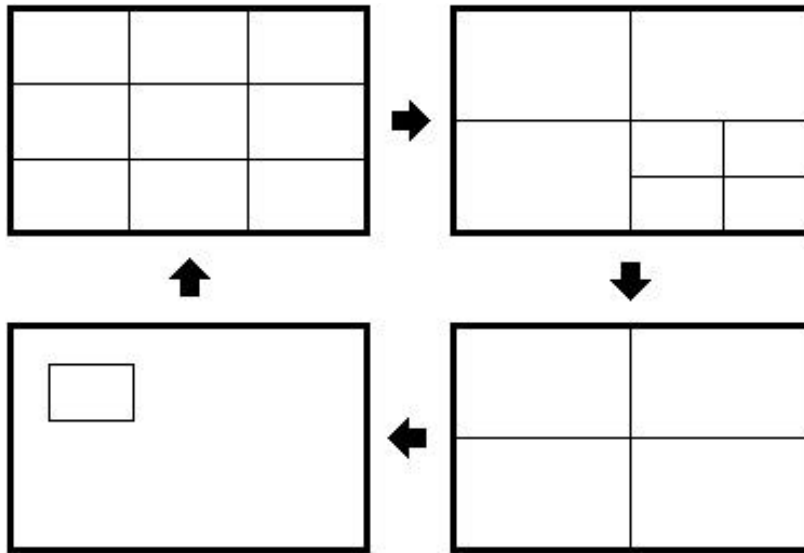

10. REMOTE VIEWER

Basic Operations and Login Display:

Go to the Internet Explorer, key in the network IP address, for example, <http://220.228.98.9> (must be the same IP address as the one assigned to the unit from the Network Setting Menu. please contact your ISP or MIS for the IP assignment)



The LOGIN dialog will be shown on the screen.

User must enter the correct user-name and password defined in the Network Setting menu.

For example:

Enter ADMIN for user name and ADMIN for password and then click on "Login" to enter system.

Main Screen

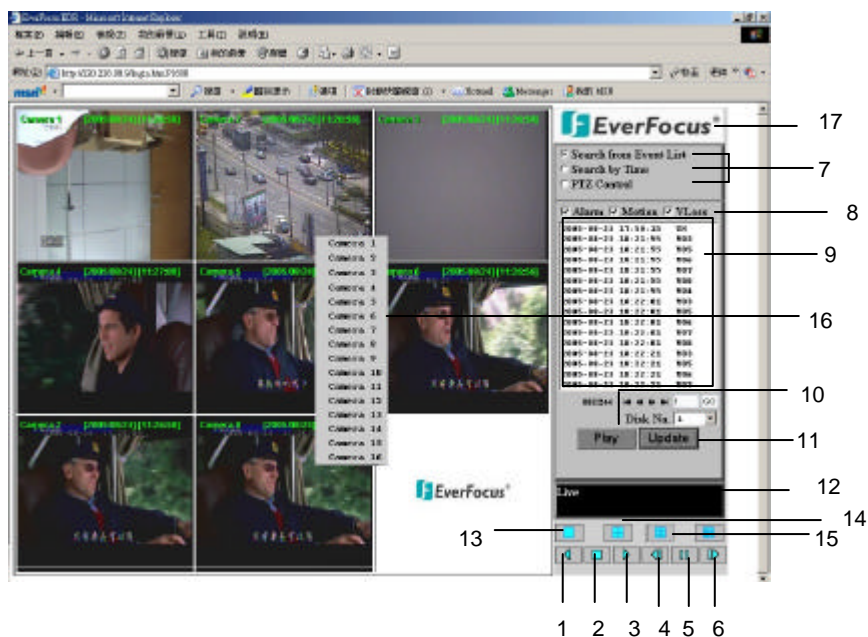







The above diagram is the main screen display.

The icons on the lower corner of the screen are mainly for control and configuration, those on the right corner are for status indication.

If any icon is grayed, it means that the specific function is not accessible in the current mode.

The followings are a brief description for each of the icons.

1.  **REV. PLAY:** Reverse Video Playback.
2.  **STOP:** Press this key to stop Video Playback.
3.  **PLAY:** Play back the Video display.
4.  **STEP FORWARD:** the Video Playback display.
5.  **PAUSE:** To pause the Video Playback display.
6.  **STEP BACKWARD:** the Video Playback display.

7. The system allows up to 3 ways to playback video, by **EVENT LIST**, **Time** and **PTZ Control**.

(Playback by **EVENT LIST**, click “Update” button to show list)

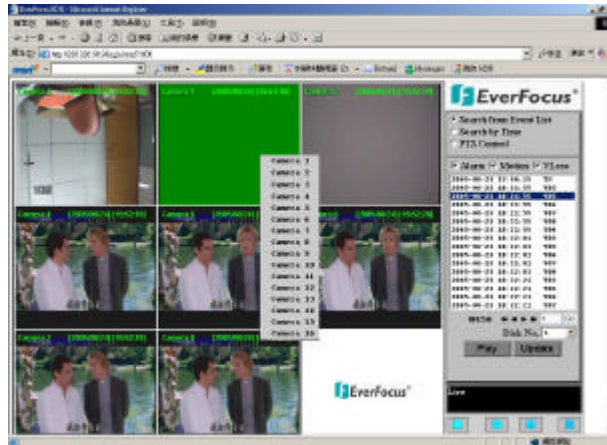

(Playback by **Time**)

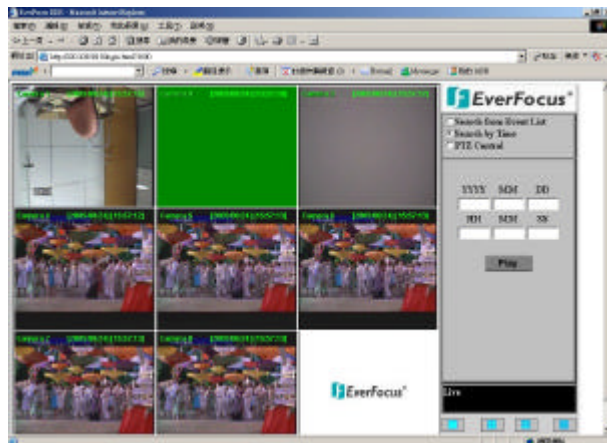

(Playback by **PTZ Control**)

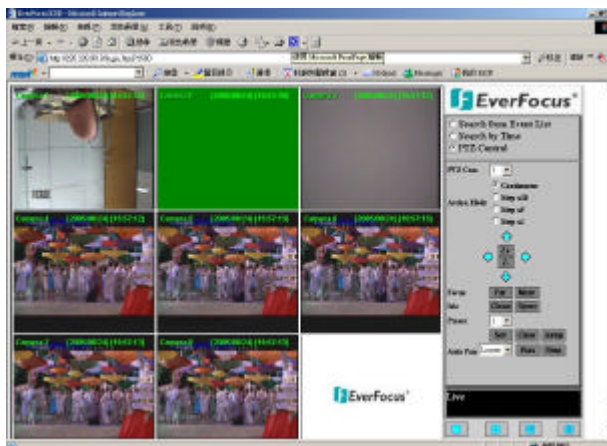

Search from **EVENT LIST**:

- I. Select Event Type from **Alarm, Motion and Vloss**.
- II. Press **Update** button to refresh the event list.
- III. All events of the selected type will be displaying along with Date/Time, event type (represents by a capital letter), camera number (represents by a number), e.g. M02 is the motion event from camera 2.
- IV. Current page and total page are shown below the event list. Press |<< for first page, << for previous page, >> for next page, >>| for last page, or simply input the page number, then press **GO**.
- V. Press **Play** button to playback the selected event.

Search by **Time**:

Search the starting date and time by entering **Year/Month/Date/Hour/Min/Sec** of the happening event. Then press **Play** button to playback.

Playback by **PTZ CONTROL**:

- I. Select the PTZ camera from drop-down menu.
- II. Select **Action Mode**. 4 options are available: **Continuous, Step x10, Step x5 and Step x1**.
- III. Use Direction Arrows (up, down, left, right) to move/adjust the focus to your desired direction and angle.
- IV. Press **Z+** for Zooming In or **Z-** for Zooming Out.
- V. In **Focus** option, press **Near** to move the focus closer to the subject. Or you can move the focus farther from the subject by pressing **Far**.
- VI. You can turn on the **Iris** by pressing **Open** or turn it off by pressing **Close**.
- VII. "**Preset**" helps you to define the preset point at which you would like to see the subject. Press **Set** for confirmation, **Clear** to exit or **Jump** to jump to a specific point.
- VIII. "**Auto Pan**" is to define the speed of PTZ camera when moving horizontally, please select from **Lower, Low, Middle, High** to **Higher**. Press **Run** for confirmation or **Stop** to exit.

8. Events to be searched: **Alarm**, **Motion** and **Vloss**.

9. All available events are shown in the list. Select the desired event and it will be highlighted.

10. Click on **“Play”** to playback selected video event.

11. Press **“Update”** to refresh the event list.

12. Current connection and playback status are shown along with date and time.

13. Full screen view.

14. Quad screen view.

15. Nine split screen view.

16. A pop-up menu to select camera to view will be shown by right-clicking the mouse.

17. Download viewer

I. To download viewer, press **“EverFocus”** logo on the right top corner of the screen.

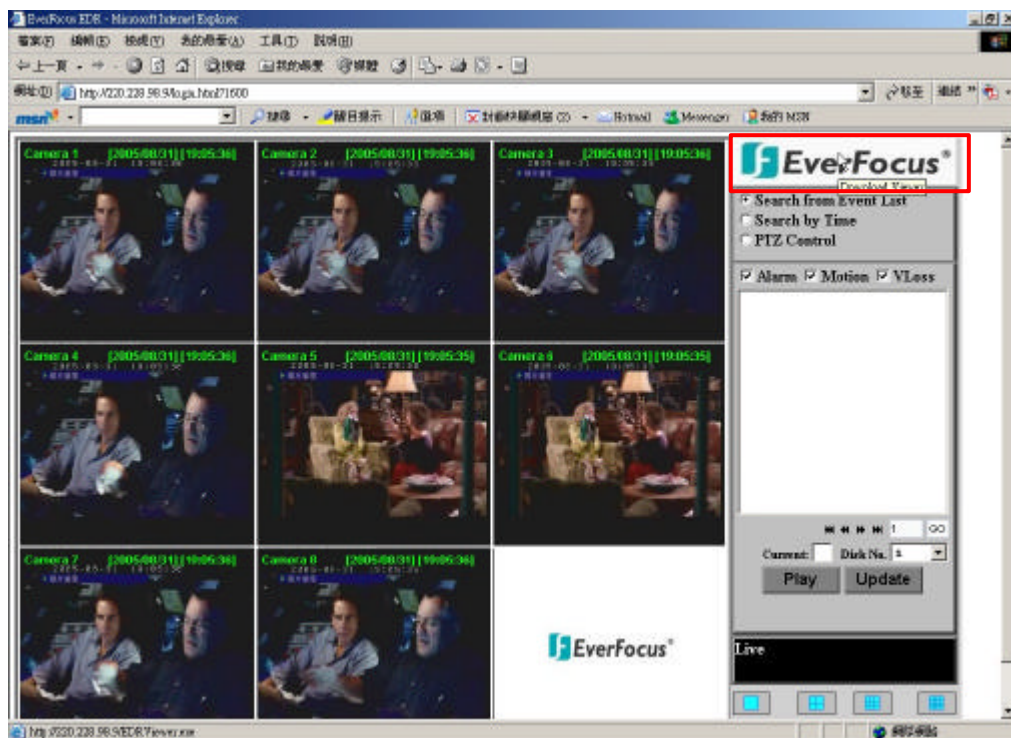

II. Select “Run” or “Save” the file.

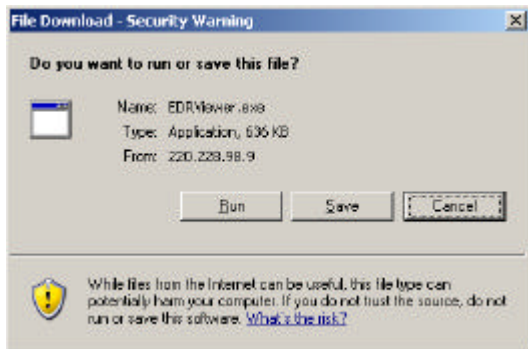

III. Open the EDRViewer.exe for loading the archived EDR MPEG Files (.arv)

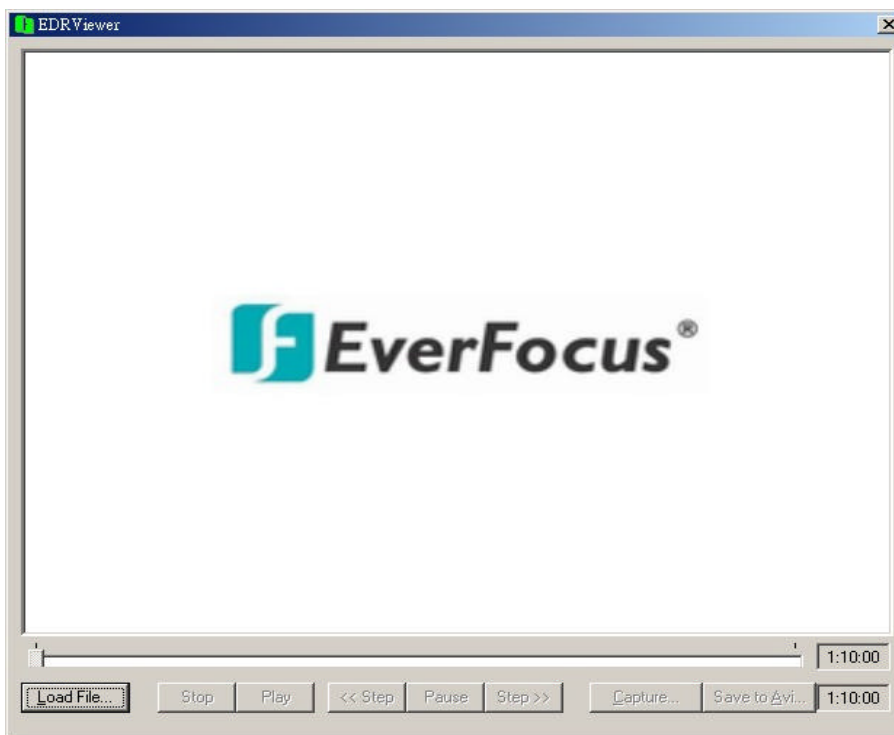

Note: If you are unable to play “AVI” file downloaded from “EDRViewer”, please go to the following URL:
<http://www.divx.com/divx/play/download/index.php>
for downloading DivXPlay.exe. This will enable you to play “AVI” file successfully.

APPENDIX

APPENDIX A : RS232 specifications

RS232

This Digital Video Recorder can be controlled by a computer or a terminal via a standard D-SUB 9-pin RS-232 connector.

■ D-SUB 9-pin connector

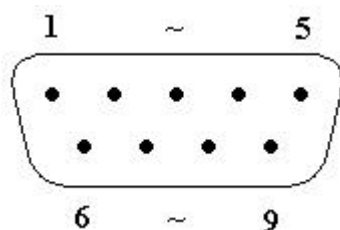

■ The pin assignment of the 9-pin D-SUB connector

Digital Video Recorder			HOST	
PIN #	NAME		PIN #	NAME
1	NOT CONNECTED		1	NOT CONNECTED
2	T x D (Transmitted Data)	→	2	R x D (Received Data)
3	R x D (Received Data)	←	3	T x D (Transmitted Data)
4	NOT CONNECTED		4	NOT CONNECTED
5	GROUND	↔	5	GROUND
6	NOT CONNECTED		6	NOT CONNECTED
7	NOT CONNECTED		7	NOT CONNECTED
8	NOT CONNECTED		8	NOT CONNECTED
9	NOT CONNECTED		9	NOT CONNECTED

■ Transmission setting

There are 6 different speeds that can be used to transmit instruction or information through the RS232 port on the device, 2400 baud, 4800 baud, 9600 baud, 19200 baud, 38400 baud, and 57600 baud. The default setting from the factory is 9600 baud.

Please refer to the CONTROL SETUP MENU for the details.

APPENDIX

APPENDIX B : RS-485 (RJ45) specifications

There are two RS-485 (RJ-45) connectors of one port on the back panel of the DVR. Please refer to the following pin assignment for application.

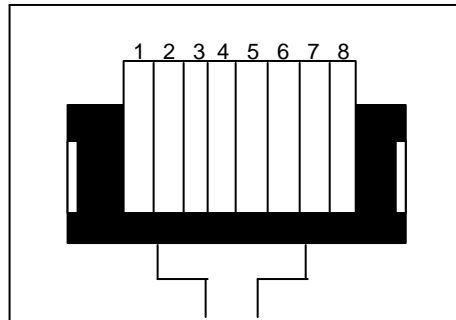

PIN #	NAME
1	GND
2	NC
3	RX
4	NC
5	NC
6	TX
7	NC
8	NC

APPENDIX

APPENDIX C : Alarm I/O Assignment

Alarm I/O pin assignment

The alarm connector, **Figure 1**, is used to provide one sensor alarm input for each camera input. For easy operation, an alarm extension board, **Figure 2**, is provided to connect to the alarm connector.

Each alarm input requires two wires, one wire connects to the desired alarm input pin, the second wire connects to the ground. The alarm signal assignment is shown as below.

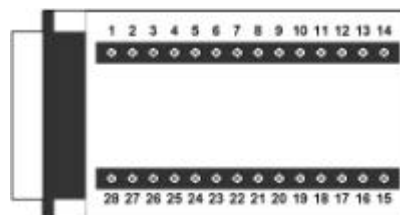
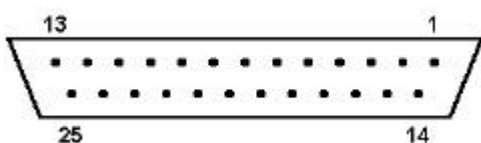

<Figure 1>

D-SUB 25 pin female connector (DVR)

<Figure 2>

PR16D00400 Alarm extension board (HOST)

DVR	
PIN #	NAME
1	GND
2	ALM 1
3	ALM 2
4	ALM 3
5	ALM 4
6	ALM 5
7	ALM 6
8	ALM 7
9	ALM 8
10	-----
11	-----
12	-----
13	-----
14	-----
15	-----
16	-----
17	-----
18	ALMRSTO
19	REC
20	REC-IN
21	DISKFULL
22	-----
23	ALM-N.C
24	ALM-N.O
25	ALM-COM

HOST	
PIN #	NAME
1	GND
2	ALM 1
3	ALM 2
4	ALM 3
5	ALM 4
6	ALM 5
7	ALM 6
8	GND
9	ALM 7
10	ALM 8
11	-----
12	-----
13	-----
14	-----
15	-----
16	-----
17	-----
18	-----
19	ALMRST
20	REC-IN
21	GND
22	-----
23	DISKFULL
24	-----
25	ALM-N.C
26	ALM-N.O
27	ALM-COM
28	GND

APPENDIX

APPENDIX D : Troubleshooting

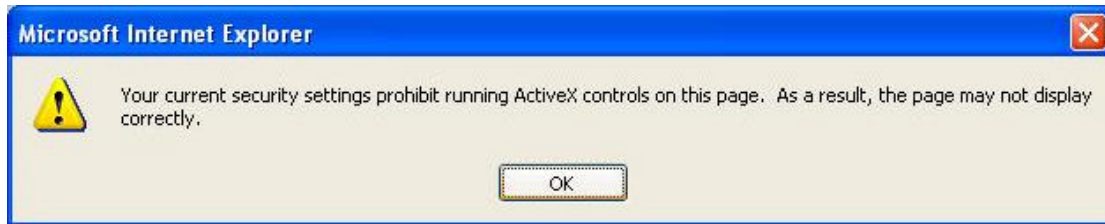

If the above error message pops up when you connect to EDR1680 for viewing from internet, you should change Internet Option of IE to enable ActiveX controls.

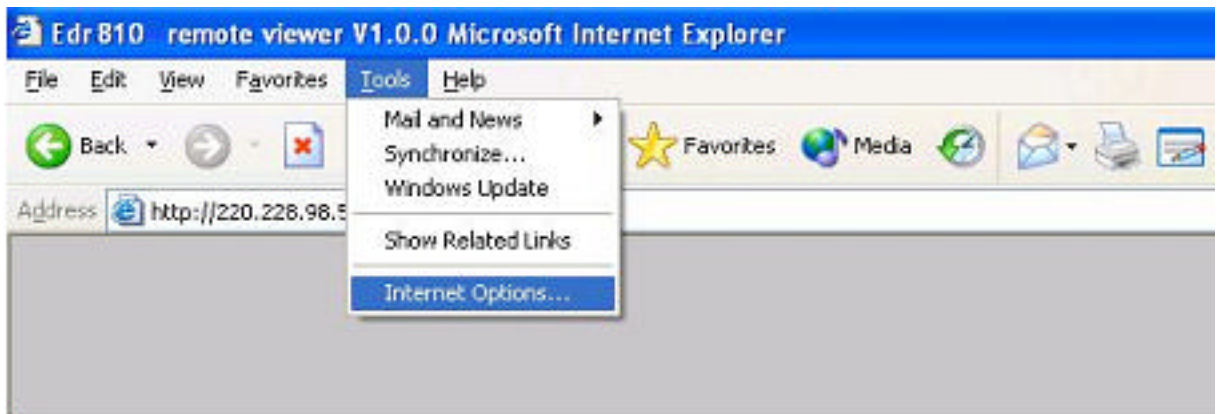

Select **Tools** -> **Internet Options...**

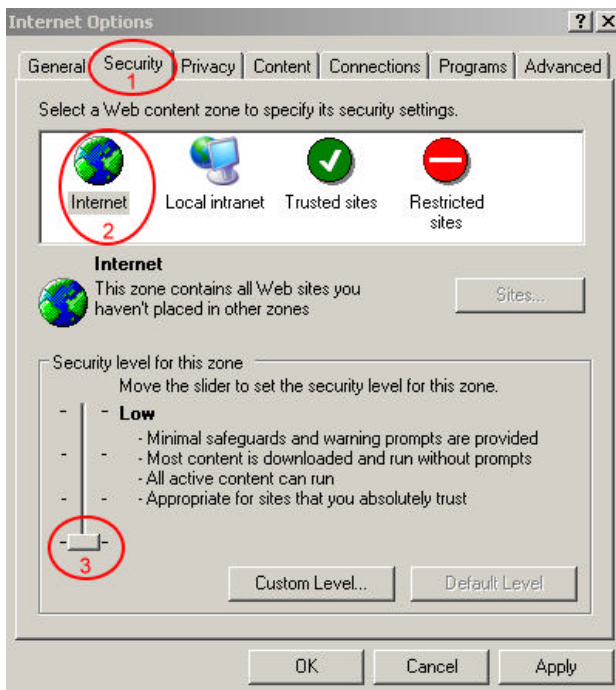

Please refer to the above steps for changing **Security Options** to **Low**.

EverFocus Electronics Corp.

Head Office:

12F, No.79 Sec. 1 Shin-Tai Wu Road,
Hsi-Chih, Taipei, Taiwan
TEL: +886-2-26982334
FAX: +886-2-26982380
www.everfocus.com.tw

USA Office:

1801 Highland Ave. Unit A
Duarte, CA 91010, U.S.A.
TEL: +1-626-844-8888
FAX: +1-626-844-8838
www.everfocus.com

European Office:

Albert-Einstein-Strasse 1
D-46446 Emmerich, Germany
TEL: 49-2822-9394-0
www.everfocus.de

China Office:

Room 609, Technology Trade Building,
Shangdi Information Industry Base,
Haidian District, Beijing, China
TEL: +86-10-62971096
FAX: +86-10-62971432
www.everfocus.com.cn

Japan Office:

1809 WBG MARIBU East 18F,
2-6 Nakase.Mihama-ku.
Chiba city 261-7118, Japan
TEL : +81-43-212-8188
FAX : +81-43-297-0081
www.everfocus.com

	<p>Your EverFocus product is designed and manufactured with high quality materials and components which can be recycled and reused. This symbol means that electrical and electronic equipment, at their end-of-life, should be disposed of separately from your household waste.</p> <p>Please, dispose of this equipment at your local community waste collection/recycling centre.</p> <p>In the European Union there are separate collection systems for used electrical and electronic product.</p> <p>Please, help us to conserve the environment we live in!</p>	<p>Ihr EverFocus Produkt wurde entwickelt und hergestellt mit qualitativ hochwertigen Materialien und Komponenten, die recycelt und wieder verwendet werden können.</p> <p>Dieses Symbol bedeutet, dass elektrische und elektronische Geräte am Ende ihrer Nutzungsdauer vom Hausmüll getrennt entsorgt werden sollen. Bitte entsorgen Sie dieses Gerät bei Ihrer örtlichen kommunalen Sammelstelle oder im Recycling Centre.</p> <p>Helfen Sie uns bitte, die Umwelt zu erhalten, in der wir leben!</p>
---	---	--



EverFocus[®]

P/N: M41HG0010D