

AVerMedia® **AVerTV™ Box**

User's Manual



AVerMedia®
Bridging PC/Mac & Video

FCC NOTICE

This device has been tested and found to comply with the limits for a Class B digital device, pursuant to Part 15 of the FCC Rules. These limits are designed to provide reasonable protection against harmful interference in a commercial, industrial or business environment. This equipment can generate, use and radiate radio frequency energy and, if not installed and used in accordance with the instruction, may cause harmful interference to radio communications. However, there is no guarantee that interference will not occur in a particular installation. If this equipment does cause harmful interference to radio or television reception, which can be determined by turning the equipment off and on, the user is encouraged to try to correct the interference by one or more of the following measures :

- Reorient or relocate the receiving antenna.
- Increase the separation between the equipment and receiver.
- Connect the equipment into an outlet on a circuit different from that to which the receiver is connected.
- Consult the dealer or an experienced radio/TV technician for help.

This device complies with Part 15 of the FCC Rules. Operation is subject to the following two conditions: (1) this device may not cause harmful interference, and (2) this device must accept any interference received, including interference that may cause undesired operation.

CAUTION ON MODIFICATIONS

To comply with the limits for the Class B digital device, pursuant to Part 15 of the FCC Rules, this device must be installed in computer equipment certified to comply with the Class B limits. All cables used to connect the computer and peripherals must be shielded and grounded. Operation with non-certified computers or non-shielded cables may result in interference to radio or television reception.

Any changes or modifications not expressly approved by the grantee of this device could void the user's authority to operate the equipment.

CE NOTICE

This is a Class B product.

DISCLAIMER

No warranty or representation, either expressed or implied, is made with respect to the contents of this documentation, its quality, performance, merchantability, or fitness for a particular purpose. Information presented in this documentation has been carefully checked for reliability; however, no responsibility is assumed for inaccuracies. The information contained in this documentation is subject to change without notice.

In no event will AVerMedia be liable for direct, indirect, special, incidental, or consequential damages arising out of the use or inability to use this product or documentation, even if advised of the possibility of such damages.

TRADEMARKS

AVerMedia and AVerTV are registered trademarks of AVerMedia TECHNOLOGIES, Inc. IBM PC is a registered trademark of International Business Machines Corporation. Macintosh is a registered trademark of Apple Computer, Inc. Microsoft is a registered trademark and Windows is a trademark of Microsoft Corporation. All other products or corporate names mentioned in this documentation are for identification and explanation purposes only, and may be trademarks or registered trademarks of their respective owners.

COPYRIGHT

© 2001 by AVerMedia TECHNOLOGIES, Inc. All rights reserved. No part of this publication may be reproduced, transmitted, transcribed, stored in a retrieval system, or translated into any language in any form by any means without the written permission of AVerMedia TECHNOLOGIES, Inc.

Contents

Introduction.....	1
<i>What's in the Package.....</i>	<i>1</i>
The AVerMedia® AVerTV Box Unit.....	2
<i>The Touch Button Control Panel.....</i>	<i>2</i>
<i>Infrared Sensor.....</i>	<i>2</i>
<i>Connection Ports.....</i>	<i>3</i>
Installation and Setup	4
<i>Connecting the VGA/MAC monitor or LCD Projector</i>	<i>4</i>
<i>Connecting the Computer.....</i>	<i>4</i>
<i>Connecting the Antenna.....</i>	<i>5</i>
<i>Connecting an Audio Cable.....</i>	<i>5</i>
<i>Connecting the External Amplified Speaker.....</i>	<i>5</i>
<i>Connecting the Power Adapter.....</i>	<i>5</i>
<i>Connecting a Video Source.....</i>	<i>6</i>
<i>Composite Video.....</i>	<i>6</i>
<i>S-Video.....</i>	<i>6</i>
<i>Analog Composite Video(Y,P_B,P_R).....</i>	<i>6</i>
<i>Connecting to a Video Output Device.....</i>	<i>6</i>
Using the AVerMedia® AVerTV Box.....	7
<i>Using AVerMedia® AVerTV Box for the First Time.....</i>	<i>7</i>
<i>Accessing TV Controls</i>	<i>7</i>
<i>The Remote Control.....</i>	<i>7</i>
<i>Calling Up a Menu Display</i>	<i>8</i>
<i>Fine Tuning</i>	<i>10</i>
<i>Switching the Background Sound.....</i>	<i>10</i>
<i>Choosing the Video Source</i>	<i>10</i>
<i>Switching the TV Source</i>	<i>10</i>
<i>Changing the Display Mode.....</i>	<i>11</i>
<i>Channel Presetting</i>	<i>11</i>
<i>Autoscan.....</i>	<i>11</i>
<i>Scan All Frequency.....</i>	<i>11</i>
<i>Channel Remapping.....</i>	<i>12</i>
<i>Area Selection.....</i>	<i>13</i>
<i>Selecting the OSD Language.....</i>	<i>13</i>
<i>Customizing the Picture Setting.....</i>	<i>13</i>
<i>Switching the PIP Border.....</i>	<i>14</i>
<i>Changing the Color of the PIP Border.....</i>	<i>14</i>
<i>Restoring the Default Channel and Picture Setting.....</i>	<i>14</i>
Using Teletext (option)	15
<i>Teletext Control Buttons</i>	<i>15</i>
<i>Viewing Teletext</i>	<i>15</i>
<i>Selecting a Teletext Page.....</i>	<i>16</i>
LIMITED WARRANTY.....	17

Introduction

Thank you for purchasing the AVerMedia® AVerTV Box!

With the AVerMedia® AVerTV Box, you can turn your VGA/Mac monitor or LCD projector into a TV with or without even having to turn on your computer. Just plug it into your monitor or LCD projector and you're ready to watch TV or play video games. AVerTV Box is completely plug-n-play. There is no software driver required.

What's in the Package

Your AVerMedia® AVerTV Box package contains the following items:

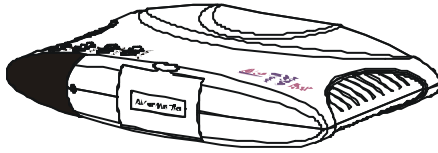

AVerMedia® AVerTV Box
with vertical stand



This User's Manual

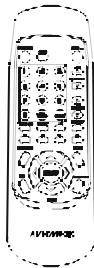

Remote Control
(with batteries)



Power Adapter



Audio Cable



VGA Cable

Optional Accessories:



Monitor Adapter
for MAC



Computer Adapter
for MAC

The AVerMedia® AVerTV Box Unit

Touch Button Control Panel

The Touch Button Panel found on the top side of the AVerTV Box provides quick access to commonly used functions.

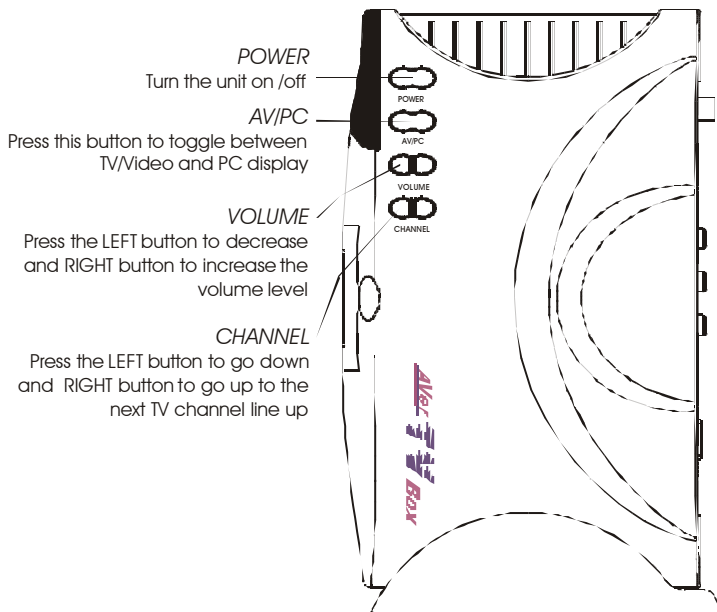

Infrared Sensor

When using the remote control, aim it at the Infrared Sensor which is located at the front panel of the AVerTV Box.

INFRARED REMOTE SENSOR

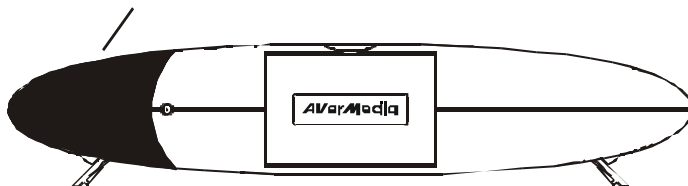

Connection Ports

The port connectors allow connection of your TV antenna, PC, VGA/Mac monitor or LCD projector, speakers, video, s-video, or analog composite video source etc.

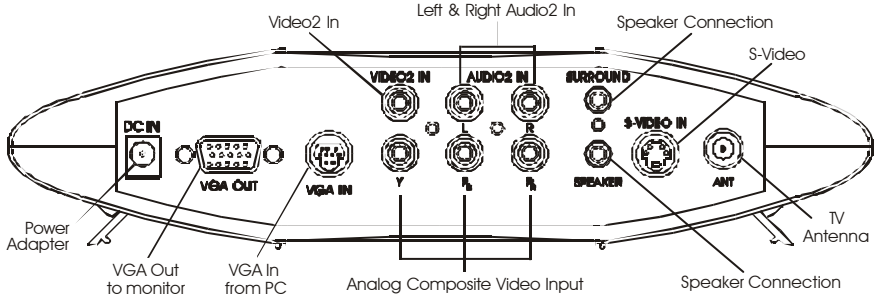

AVerMedia AVerTV Box Back Panel

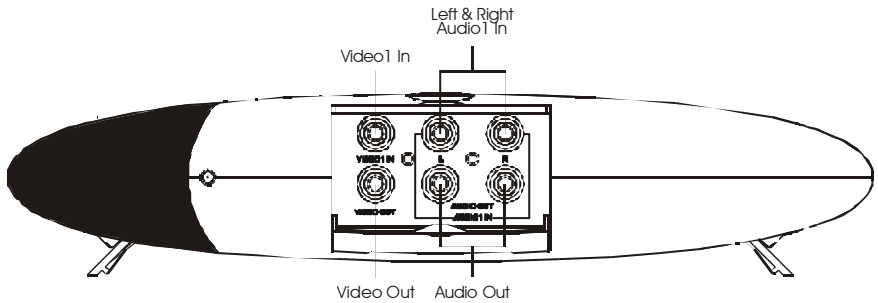

AVerMedia AVerTV Box Front Panel

Installation and Setup

Connecting the VGA/ Mac monitor or LCD Projector

Connect the monitor cable or the VGA extension cable (not supplied) to the AVerTV Box **VGA OUT** port. For MAC, use a monitor adapter (optional) to make the connection.

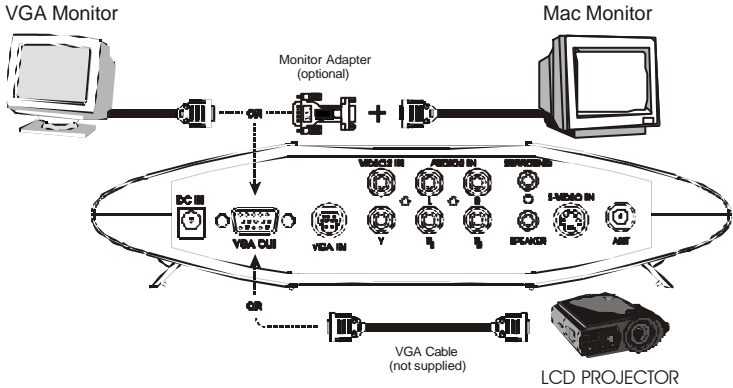

Connecting the Computer

You can use AVerTV Box with or without using the computer. To switch to PC anytime or watch in PIP (picture in picture), connect the supplied VGA cable to the AVerTV Box **VGA IN** port and to your computer's VGA card (the terminal where your monitor connects to the PC). For MAC, use a computer adapter (optional).

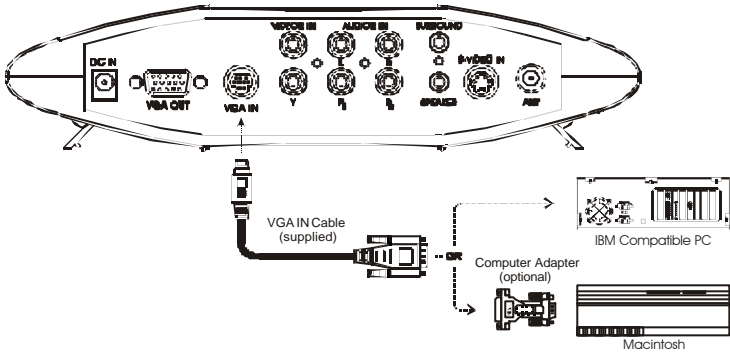

Connecting the Antenna

Attach the antenna or cable TV to the **ANT** port of AVerTV Box.

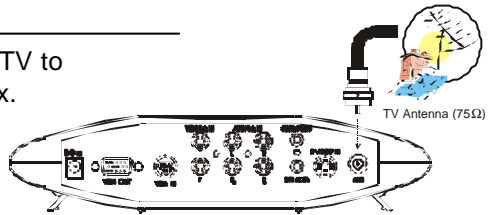

Connecting an Audio Cable

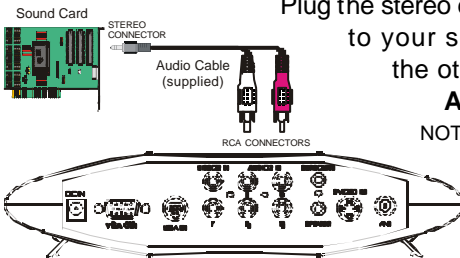

Plug the stereo end of the supplied audio cable to your sound card **LINE OUT** port and the other two RCA connectors to the **AUDIO2 IN** port of AVerTV Box.

NOTE: This type of connection allows you to have audio at all times and to adjust the volume from the AVerTV Box. For audio pass through connection, make sure the AVerTV Box is powered on or in standby mode.

Connecting the External Amplified Speaker

Connect the speaker to the **SURROUND** port to have a 3D Surround Sound effect. If you have additional external amplified speaker, you may connect it to the **SPEAKER** port of AVerTV Box.

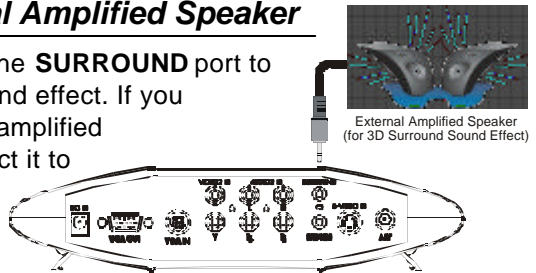

Connecting the Power Adapter

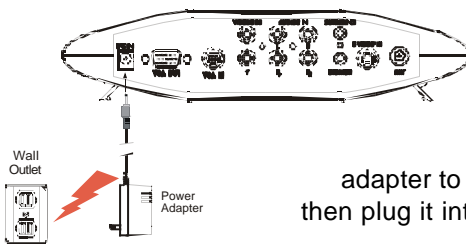

Connect the supplied power adapter to the **DC IN** port of AVerTV Box then plug it into a standard AC power outlet.

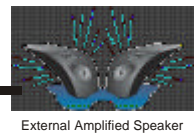

Connecting a Video Source

Composite Video: Connect a video cable (not supplied) to the video out of the video device and to the AVerTV Box **VIDEO IN** port.

Connect an audio cable to the left & right audio out of the video device and to the AVerTV Box left & right **AUDIO1 IN** ports.

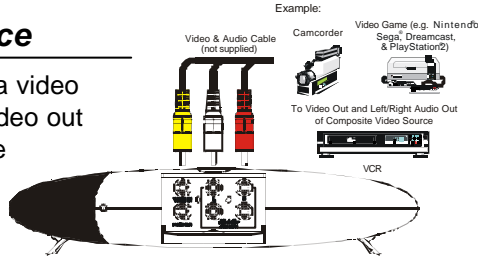

S-Video: Connect an s-video cable (not supplied) to the s-video out of the video device and to the AVerTV Box **S-VIDEO IN** port. If your video player supports s-video, use this type of connection as s-video provides better picture quality than composite video.

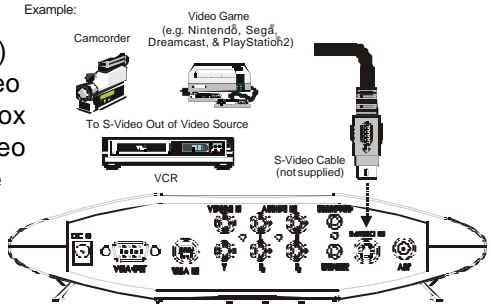

Analog Composite Video (Y,P_B,P_R): Connect the analog composite video cable (not supplied) to the Y,P_B,P_R out of the video component source and to the AVerTV Box **Y,P_B,P_R** port.

If you are using the Video2, S-Video or Analog composite video (Y,P_B,P_R), the audio must be connected to the **AUDIO2 IN** port.

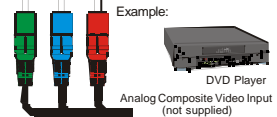

Connecting to a Video Output Device

You can output the video signal from your TV antenna or video source (like the camcorder) to a receiving device. The receiving device can be a TV monitor, VCR, video capture card, etc. Simply connect the receiving device to the AVerTV Box **VIDEO OUT** port and left & right **AUDIO OUT** ports.

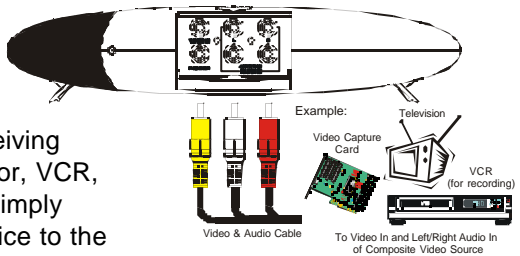

NOTE : The AVerTV Box provides composite video output only.

Using the AVerMedia® AVerTV Box

Using AVerMedia® AVerTV Box for the First Time

When you power on the AVerMedia® AVerTV Box for the first time, it will automatically proceed to the **Set Area** of Setup Menu no. 2. Since TV signals vary in different countries, you need to select the appropriate signal. Refer to the table below for country signals.

NTSC-M	SECAM-DK	SECAM-L	PAL-I	PAL-BG	PAL-DK
USA-STD	RUSSIA	FRANCE	UK	HUNGARY	POLAND-1
USA-HRC	UKRAINE		HK	EUROPE	POLAND-2
USA-IRC				ITALY	POLAND-3
TAIWAN				AUSTRALIA	CZECH
JAPAN				ZAHAV	CHINA
				MATAV	
				GVANIM	
				IDAN	

Each column in the table above corresponds to a different type of TV system. Only one of these TV systems (only one column) will appear as your **Set Area** the first time you power on the AVerTV Box. Make sure that you select the correct country signal from the menu.

To ensure that you can select and watch all active channels, refer to the section Channel Presetting on how to automatically scan and memorize all active TV channels in your area.

Accessing TV Controls

To access the various TV controls, open up the menu displays or press on the remote control buttons.

The Remote Control

The figure on the next page shows a clear layout of the remote control unit.

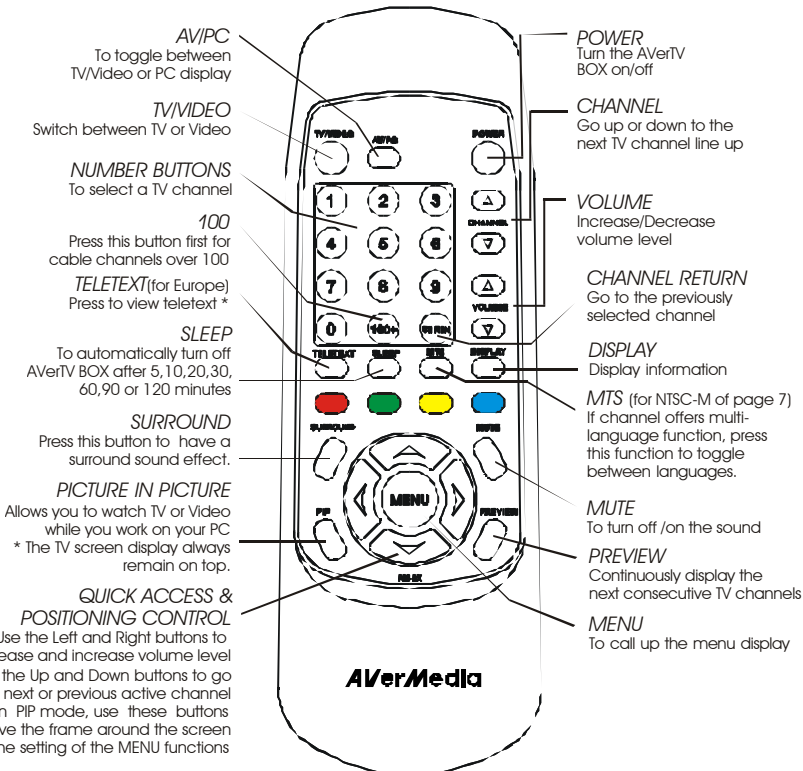

* Teletext buttons only present in European model.

Calling Up a Menu Display

Press the **MENU** button on the remote control to call up the menu displays. Then, use the **Up** or **Down** buttons to select the desired function and use the **Left** or **Right** buttons to adjust. The table below lists the different functions you will find in each of the menu.

Menu No.	Function	Usage
General Menu-1	CH Fine Tune PC BGM Video Source TV Source Display Mode	To adjust TV picture. To activate/deactivate background sound. To watch video from the external source. To switch to air or cable TV. To change the display resolutions.
Setup Menu-2	Autoscan Scan All Freq CH Add/Del Set Area Language	To search and memorize all active channel line up in your area. To scan frequency starting from $\times\times.25$ MHz and increasing by 1 MHz at a time. To reprogram, add or remove TV channel line up. To select the country signal. To change the OSD language
Picture Menu-3	Brightness Contrast Tint Color Sharpness	To increase/ decrease the brightness level. To increase/ decrease the contrast level. To increase/ decrease the tint level. To increase/ decrease the color level. To increase/ decrease the sharpness level.
PIP Menu-4	PIP Border PIP Color	Turns the PIP border on /off. To change the color of the border. There are eight (8) colors to choose from.
Reset Menu-5	Setup Picture	To restore the CH Add/ Del of Menu-2 to its' original factory setting. To restore the Picture Menu-3 to its' original factory setting.

Fine Tuning

MENU 1 2 3 4 5 GENERAL	
▶ CH FINE TUNE	[] [] +00
PC BGM	ON
VIDEO SOURCE	VIDEO-1
TV SOURCE	CATV
DISPLAY MODE	640 x 480
SELECT : ▲▼	ADJUST : ◀▶

If TV reception is not clear, choose **CH FINE TUNE** from Menu-1 and press the **Left** and **Right** buttons on the remote until the TV picture becomes clearer.

Switching the Background Sound

MENU 1 2 3 4 5 GENERAL	
▶ CH FINE TUNE	[] [] +00
▶ PC BGM	ON
VIDEO SOURCE	VIDEO-1
TV SOURCE	CATV
DISPLAY MODE	640 x 480
SELECT : ▲▼	ADJUST : ◀▶

If you want to continue listening to the TV or video sound while you work with your PC, choose **PC BGM** from Menu-1 and select **ON** to turn on the background sound. The sound of the

television channel will continue while you work on your PC. You can press the **AV/PC** button on the remote to toggle between the PC and the television. To turn off the background sound, select **OFF**.

Choosing the Video Source

MENU 1 2 3 4 5 GENERAL	
CH FINE TUNE	[] [] +00
PC BGM	ON
▶ VIDEO SOURCE	VIDEO-1
TV SOURCE	CATV
DISPLAY MODE	640 x 480
SELECT : ▲▼	ADJUST : ◀▶

If you selected to watch video from an external video device, choose **VIDEO SOURCE** from Menu-1 and press the **Left** and **Right** buttons on the remote to select from Video-1, Video-2, S-Video, or Y,P_B,P_R.

Switching the TV Source

MENU 1 2 3 4 5 GENERAL	
CH FINE TUNE	[] [] +00
PC BGM	ON
VIDEO SOURCE	VIDEO-1
▶ TV SOURCE	CATV
DISPLAY MODE	640 x 480
SELECT : ▲▼	ADJUST : ◀▶

If you want to switch the TV source, choose **TV SOURCE** from Menu-1 and press the **Left** and **Right** buttons on the remote to select between Air or Cable TV.

Changing the Display Mode

MENU	1	2	3	4	5	GENERAL
CH FINE TUNE						+00
PC BGM						ON
VIDEO SOURCE						VIDEO-1
TV SOURCE						CAV
▶ DISPLAY MODE						640 x 480
SELECT : ▲▼						ADJUST : ◀▶

To change the display resolution, choose **DISPLAY MODE** from Menu-1 and press the **Left** and **Right** buttons on the remote to select from the list of standard resolutions which the AVerTV Box support in full screen.

Channel Presetting

There are two types of *Channel Preset* functions for memorizing active TV channels:

- **Autoscan**

If this is your first time to use the AVerTV Box, first use autoscan to memorize all active TV channels in your area. autoscan will use the frequencies in a default frequency table to search for active channels.

MENU	1	2	3	4	5	SETUP
▶ AUTOSCAN						NO
SCAN ALL FREQ.						NO
CH ADD / DEL						REMAPPING
SET AREA						USA-SID
LANGUAGE						ENGLISH
SELECT : ▲▼						ADJUST : ◀▶

To memorize channels using autoscan, choose **AUTOSCAN** from Menu-2 and select **YES** to start memorizing all the active TV channels.

As AVerTV Box performs the search, it will display each channel number. You can interrupt and cancel the searching process anytime by pressing the **Left** or **Right** buttons on the remote.

Now press the **Channel Up/Down** or **Number** buttons on the remote control. Check and verify that you can access all the TV channels available in your area.

- **Scan All Frequency**

If there are channels missing after you perform autoscan, use the scan all frequency function and repeat the searching process.

Scan all frequency will scan frequencies starting from xx.25 MHz, increasing by 1 MHz at a time. It will check and record all frequencies for active channels. The new frequencies will replace the default frequency record.

MENU	1	2	3	4	5	SETUP
AUTOSCAN						NO
▶ SCAN ALL FREQ						NO
CH ADD / DEL						REMAPPING
SET AREA						USA-STD
LANGUAGE						ENGLISH
SELECT: ▲▼						ADJUST: ◀▶

To memorize channels using scan all frequency, choose **SCAN ALL FREQ** from Menu-2 and select **YES** to start scanning the new frequencies.

As the AVerTV Box finds an active channel, it will assign the frequency to a new channel. You can interrupt and cancel the process anytime by pressing the **Left** or **Right** buttons on the remote.

Scan all frequency can also search for channels with xx.75 MHz or xx.50 MHz frequency, but such channels will still be memorized as having xx.25 MHz frequency. Use the CH FINE TUNE function to adjust a channel to its exact frequency and get a clear TV picture. (Refer to the section, *Fine Tuning*, for details.)

If you want to restore the *default frequency table*, execute the **RESET** function. All the frequencies that were memorized using *Scan All Frequency* will then be erased from the channel memory. **FINE TUNE** adjustments will also be restored to their default settings.

NOTE: Scan All Frequency is a very time consuming process. If the default frequency table already includes all active TV channels in your area, then avoid using Scan All Frequency.

Channel Remapping

If your broadcast area contains channels covering diverse numbers, you can reprogram these channel numbers in AVerTV Box. For example, if your viewing area contains channels 7, 13, 21 and 28, you can reprogram these numbers in the AVerTV Box channel record as channels 1, 2, 3 and 4.

MENU	1	2	3	4	5	SETUP
AUTOSCAN						NO
SCAN ALL FREQ						NO
▶ CH ADD / DEL						REMAPPING
SET AREA						USA-STD
LANGUAGE						ENGLISH
SELECT: ▲▼						ADJUST: ◀▶

1. Select **CH ADD/DEL** from Menu-2 then Press the **left** or **right** button to access this feature.
2. In the selected USER CH, enter in the new channel number you want to assign or the channel number you want to remove/add in to the channel line up.
3. In the CATV CH, enter in the channel number you want to remap or the channel number you want to remove/add.

- REMAPPING -
▶ USER CH --- (070)
CATV CH --- (070)
ADD
DEL

- Select **ADD** to include or **DEL** to remove the channel number in the channel line up then press the **left** or **right** button.

Note: Press the **100+** button for channel number over 100. To switch to any channel number lower than 100, press the tenths digit number then press last digit of the number you want.

In case you have accidentally entered the wrong number in the **USER CH** and **CATV CH**, you need to exit and call up the menu display by pressing the **MENU** button.

Area Selection

When the AVerTV Box is first connected, the unit will automatically enter **SET AREA** mode and allow you to choose the appropriate country signal. Refer to the section, *Using the AVerTV Box for the First Time*, for details.

MENU	1	2	3	4	5	SETUP
AUTOSCAN						NO
SCAN ALL FREQ.						NO
CH ADD / DEL						REMAPPING
▶ SET AREA						USA-SID
LANGUAGE						ENGLISH
SELECT : ▲▼						ADJUST : ◀▶

If you need to enter this mode manually, press the **MENU** button and select **SET AREA** from Menu-2 and press the **Left** and **Right** buttons on the remote to choose the area selection.

Selecting the OSD Language

MENU	1	2	3	4	5	SETUP
AUTOSCAN						NO
SCAN ALL FREQ.						NO
CH ADD / DEL						REMAPPING
SET AREA						USA-SID
▶ LANGUAGE						ENGLISH
SELECT : ▲▼						ADJUST : ◀▶

The AVerTV Box has English, Chinese (tradition) and Japanese on-screen display languages. To select from the desired language, choose **LANGUAGE** from Menu-2 and press the **Left** and **Right** buttons on the remote.

Customizing the Picture Setting

MENU	1	2	3	4	5	PICTURE
▶ BRIGHTNESS						+00
CONTRAST						+00
TINT						+00
COLOR						+00
SHARPNESS						+00
SELECT : ▲▼						ADJUST : ◀▶

If you want to adjust the quality of the TV or video picture, go to **MENU-3**. Then, use the **Up** or **Down** buttons to select the desired preference and use the **Left** or **Right** buttons to adjust. To restore default setting, refer to

“Restoring the Default Channel and Picture Setting”.

Switching the PIP Border

MENU 1 2 3 4 5 PIP	
▶ PIP BORDER PIP COLOR	ON BLUE
SELECT : ▲▼ ADJUST : ◀▶	

If you want to turn off the PIP border, choose **PIP BORDER** from Menu-4 and select **OFF**. In PIP mode, the colored border will disappear.

To turn on the PIP border, select **ON**.

The table below lists the display resolutions which the AVerTV Box can support.

Computer/ Operating System	Display Resolution	Maximum Vertical Frequency	Recommended
IBM PC	640 × 480	85 Hz	60 Hz
	800 × 600	70 Hz	60 Hz
Mac	640 × 480	75 Hz	60 Hz

Note: When your computer is in sleep or standby mode, you will not be able to watch in PIP. In order to continue to watch in PIP, you must set the screen saver to animated graphics or text. Or, press the PIP button of the remote to watch in full screen.

Changing the Color of the PIP Border

MENU 1 2 3 4 5 PIP	
▶ PIP BORDER ▶ PIP COLOR	ON BLUE
SELECT : ▲▼ ADJUST : ◀▶	

To change the color of the PIP border, choose **PIP COLOR** from Menu-4 and press the **Left** and **Right** buttons on the remote to choose the desired color. There are (8) eight colors to choose from.

Restoring the Default Channel and Picture Setting

MENU 1 2 3 4 5 RESET	
▶ SETUP PICTURE	NO NO
SELECT : ▲▼ ADJUST : ◀▶	

To restore or clear all the preset channel, choose **SETUP** from Menu-5 and select **YES**.

MENU 1 2 3 4 5 RESET	
▶ SETUP ▶ PICTURE	NO NO
SELECT : ▲▼ ADJUST : ◀▶	

To restore the default picture setting in Menu-3, choose **PICTURE** from Menu-5 and select **YES**.

Using Teletext (option)

For European countries, the AVerTV Box provides the Teletext function which allows users to receive digital information from TV stations that broadcast such information. Teletext data is widely used in Europe and is transmitted along with normal television programs. The AVerTV Box can decode the teletext data and display the resulting information on your computer screen.

TV stations transmit teletext data in pages. Each page takes only a few seconds to update, so you will surely see the very latest information. Teletext pages contain all sorts of information, including the latest news, weather, sports, finance, travel, TV program listings, and more.

Teletext Control Buttons

The figure and descriptions in this section show how to use the teletext function using the remote control.

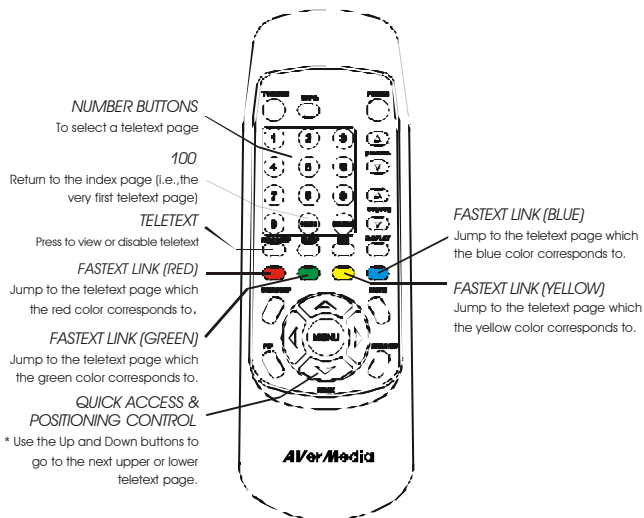

Viewing Teletext

To view teletext information, press the **TELETEXT** button on the remote. Press this button also if you wish to disable teletext.

Selecting a Teletext Page

There are many ways of selecting a teletext page :

- To enter a teletext page number, press on the **NUMBER** buttons 0 ~ 9.
- To view the next upper or lower teletext page, press the up ♦ and down arrow ◆ buttons or the **CHANNEL** ◆ ♦ buttons on the remote.
- To return to the index page (i.e., page 100), press the **100** button.
- To go directly to the next upper or lower 100th page, press the **JUMP 100 PAGES** button (labeled as **VOLUME** ◆ ♦ buttons on the remote).

For example :

If you are currently on teletext page 350, you can quickly jump to the next upper 100th page, which is page 400. Just press on the volume up ♦ button.

If you are on teletext page 350, you can quick jump to the next lower 100th page, which is page 300. Press on the volume down ◆ button.

- To select your desired teletext information, use the **FASTTEXT LINK** buttons.

In the last display line of the index page or any teletext page, text appears in four colors : *Red, Green, Yellow, and Blue*. Each color corresponds to a certain teletext information, for example, *Sports*. The **FASTTEXT LINK** buttons allow you to select your desired teletext information and quickly jump to its starting page.

For example :

If Red corresponds to News, press the Red button to jump to the starting page of News.

If Green corresponds to Finance, press the Green button to jump to the starting page of Finance.

If Yellow corresponds to Sports, press the Yellow button to jump to the starting page of Sports.

If Blue corresponds to Travel, press the Blue button to jump to the starting page of Travel.

LIMITED WARRANTY

AVerMedia TECHNOLOGIES, Inc. warrants this product to be free of defects resulting from faulty manufacture or components under the following terms:

WARRANTY LENGTH

Labor is warranted for (1) one year from the date of purchase.

Parts are warranted for (1) one year from the date of purchase.

Replacement products will be warranted for the remainder of the one year warranty period or (30) thirty days, whichever is longer.

WHO IS PROTECTED

This warranty is enforceable only by the first consumer purchaser.

WHAT IS AND IS NOT COVERED

Except as specified below, this warranty covers all defects resulting from faulty manufacturing of this product. The following are not covered by the warranty.

1. Any product on which the serial number has been defaced, modified, or removed.
2. Damage, deterioration, or malfunction resulting from :
 - A. Accident, abuse, misuse, neglect, fire, water, lightning, or other acts of nature, commercial or industrial use, unauthorized product modification, or failure to follow instructions included with the product.
 - B. Misapplication of service by someone other than the manufacturer's representative.
 - C. Any shipment damages. (Claims must be made with carrier.)
 - D. Any other cause which does not relate to a product defect.
3. Cartons, cases, batteries, cabinets, tapes, or accessories used with product.
4. AVerMedia does not warrant that this product will meet your requirements; it is your responsibility to determine the suitability of this product for your purpose.

WHAT WE WILL AND WILL NOT PAY FOR

We will pay labor and material expenses for covered items. However, we will not pay for the following :

1. Removal or installation charges.
2. Shipping charges.
3. Any incidental charges.

EXCLUSION OF DAMAGES

THE MANUFACTURER'S SOLE OBLIGATION AND LIABILITY UNDER THIS WARRANTY IS LIMITED TO THE REPAIR OR REPLACEMENT OF A DEFECTIVE PRODUCT AT OUR OPTION. THE MANUFACTURER SHALL NOT, IN ANY EVENT, BE LIABLE TO THE PURCHASER OR ANY THIRD PARTY FOR ANY INCIDENTAL OR CONSEQUENTIAL DAMAGE (INCLUDING, BUT NOT LIMITED TO, DAMAGES RESULTING FROM INTERRUPTION OF SERVICE AND LOSS OF BUSINESS) OR LIABILITY IN TORT RELATING TO THIS PRODUCT OR RESULTING FROM ITS USE OR POSSESSION.

LIMITATIONS OF IMPLIED WARRANTIES

There are no other oral or written warranties, expressed or implied, including but not limited to those of merchantability or fitness for a particular purpose. Any implied warranties are limited in duration to one year from the date of purchase.

STATE LAW AND YOUR WARRANTY

This warranty gives you specific legal rights, and you may also have other rights granted under state law. These rights vary from state to state.

CONTACT INFORMATION

www.aver.com