

SAMSUNG

DIGITAL VIDEO RECORDER

DVR COMBO User's Manual



CLASS A (For Business)

To use this product safely, have to read “**Important Safety Introductions**”, and then be well aware of the contents.

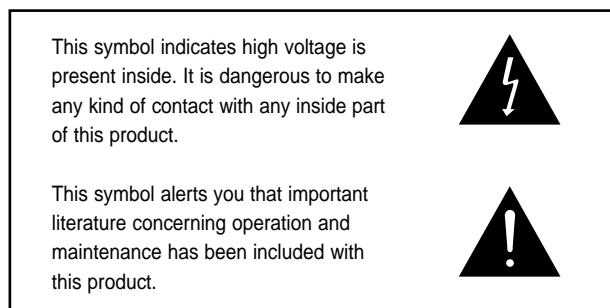
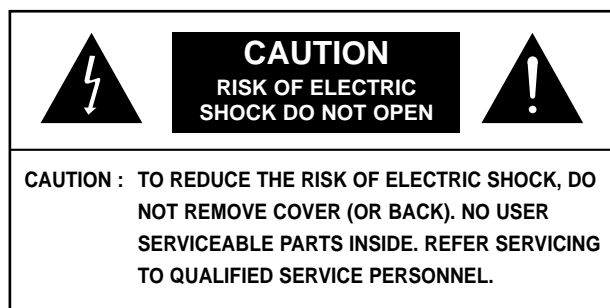

To prevent damage which may result in fire or electric shock hazard, do not expose this appliance to rain or moisture.

This device complies with part 15 of the FCC Rules. Operation is subject to the following two conditions.

- 1) This device may not cause harmful interference, and
- 2) This device must accept any interference that may cause undesired operation.

CAUTION

Danger of explosion if battery is incorrectly replaced.

Replace only with the same or equivalent type recommended by the manufacturer.

Dispose of used batteries according to the manufacturer's instructions.

Important Safety Instructions

1. Read these instructions.
2. Keep these instructions.
3. Heed all warnings.
4. Follow all instructions.
5. Do not use this apparatus near water.
6. Clean only with dry cloth.
7. Do not block any ventilation openings. Install in accordance with the manufacturer's instructions.
8. Do not install near any heat sources such as radiators, heat registers, or other apparatus (including amplifiers) that produce heat.
9. Do not defeat the safety purpose of the polarized or grounding-type plug. A polarized plug has two blades with one wider than the other. A grounding type plug has two blades and a third grounding prong. The wide blade or the third prong are provided for your safety. If the provided plug does not fit into your outlet, consult an electrician for replacement of the obsolete outlet.
10. Protect the power cord from being walked on or pinched particularly at plugs, convenience receptacles, and the point where they exit from the apparatus.
11. Only use attachments/accessories specified by the manufacturer.
12. Use only with cart, stand, tripod, bracket, or table specified by the manufacturer, or sold with the apparatus. When a used, caution when moving the cart/apparatus combination to avoid injury from tip-over.
13. Unplug this apparatus. When a cart is used, use caution when moving the cart/apparatus combination to avoid injury from tip-over.
14. Refer all servicing to qualified service personnel. Servicing is required when the apparatus has been damaged in any way, such as power-supply cord or plug is damaged, liquid has been spilled or objects have fallen into the apparatus, the apparatus has been exposed to rain or moisture, does not operate normally, or has been dropped.



Contents

iii

Important Safety Instructions

iv ~ v

Contents

1

I. Summary

- 1-1 1. Introduction
- 1-2 2. Features
- 1-3 3. Name and Function of Each Part
- 1-7 4. Introduction to the Remote Control
- 1-8 5. Checking the Package Contents
- 1-9 6. Attaching/Deleting HDD

2

II. Connection with Other Devices

- 2-1 1. Connection to External Devices
- 2-2 2. Connection with Multiplexer
- 2-3 3. System Connection for Alarm Recording
- 2-4 4. Connection with PC for Use

3

III. Basic Method to use

- 3-1 1. Booting the System
- 3-3 2. Basic Screen Viewing

4

IV. DVR Menus

- 4-1 1. Menu View
- 4-6 2. Setting of Date, Time and Screen
- 4-7 3. Record Setup
- 4-10 4. Alarm Record Setup
- 4-14 5. Reservation Timer Setup
- 4-15 6. System Setup
- 4-17 7. Communication Setup

5

V. Viewing the VCR Menu

- 5-1 1. VCR Menus
- 5-3 2. Manual Archive
- 5-8 3. Timer Archive
- 5-11 4. Archive Setup
- 5-13 5. Archive Check

6

VI. Record

- 6-1 1. Basic Record
- 6-3 2. Record Lock
- 6-4 3. Alarm Record
- 6-5 4. Reservation Record

7

VII. Retrieval and Playback

- 7-1 1. Search Menus
- 7-3 2. Retrieval by Date and Time
- 7-4 3. Recorded Data List View
- 7-5 4. Alarm Record Retrieval
- 7-6 6. Searching Motion Detection Recordings
- 7-7 7. Pb Channel Setup
- 7-8 8. System Indication
- 7-11 9. Basic Playback
- 7-13 10. VCR Playback
- 7-15 11. Searching the Backed-up Data (VISS)
- 7-16 12. Playing Back a Section Repeatedly

8

VIII. Others

- 8-1 1. Product Standards
- 8-2 2. Appearance Drawing

9

Appendix

- 9-1 1. Check Points before Call Service Center
- 9-3 2. Q & A



1 Introduction

DVR COMBO is DVR system using both hard disk drive and VCR tape simultaneously. Record TV reception into hard disk drive while also recording only desired program to VCR tape. Recorded VCR tape can be viewed with residential VCR.

DVR COMBO can play while recording sound and image simultaneously. The system and camera can be monitored and controlled from a remote PC. Together with Samsung Multiplexer, the system can backup only desired image per each channel.

2 Features

- **Data on your hard disk can easily be backed up onto video tapes.**
 - Only particular channels of the multiplexer can be backed up
 - Playback of particular channels can be protected
- **Picture quality can be adjusted to 4 different levels.**
 - Very High, High, Normal, and Low
- **The number of recording fields per second can be adjusted.**
 - NTSC : 0.50 ~ 60 fields/s
 - PAL : 0.50~50 fields/s
- **Recording and playback can be performed simultaneously.**
- **Video and audio can be recorded simultaneously.**
- **It has a timer recording function you can set just like you would your VCR.**
- **Recording can be triggered by alarm sensor input.**
- **It has a motion detection capability that can raise an alarm or start recording when motion is detected.**
- **It can be used in conjunction with a multiplexer.** SAMSUNG SDM-160(P), 090(P) Multiplexer SOM-080(N/P), SMO-150/210(TRN/TRP)
- **It offers various playback speeds.**
 - 1/5, 1/2, 1, 2, 5, 10, 20 baud rate (forward, backward)
- **It has convenient search functions.**
 - Date & Time Search, Record Event Search, Alarm Event Search, and Motion Event Search
 - VISS Search
- **The Remote Control allows for convenient operation.**
- **Remote monitoring and controlling are possible via LAN connection.**
 - Network Interface : Ethernet (10 BaseT)
 - Protocol : TCP/IP
 - Web Server : Screen capture and remote monitoring using a viewer program installed on a PC
- **The system boots up automatically and can start recording when power is restored following a power outage during Record mode.**
- **The system can be controlled remotely through serial communication ports.**
 - 1 RS-232 port
 - 2 RS-485 ports (up to 32 nodes)
 - Control of camera PAN/TILT/ZOOM by the LAN viewer program via RS-485
- **Recording status, remaining hard disk space, and in particular current playback position are displayed in bar format.**
- **A removable hard drive rack allows you to easily replace hard disk drives.**
- **Cameras can be controlled and channels can be selected using the Remote Viewer program.**
(Applicable only to Samsung products : SCC-641/SCC-643(N/P) Cameras, SCC-421(N/P) Series Camera(C4201, C4203, C4301 and C4303), and SDM-160(P), 090(P) Multiplexer SOM-080(N/P), SMO-150/210(TRN/TRP)

3 Name and Function of Each Part

Front View

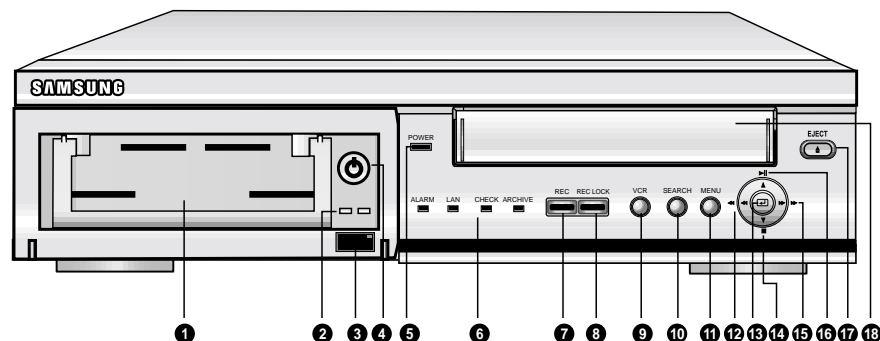

No	Name	Function
1	Hard Drive Rack	The removable hard drive rack into which your hard drive could be installed.
2	HDD LED	The hard drive status indicating LED. It indicates power status and access to the hard drive.
3	Remote Control Sensor	Receives signals from the remote control unit.
4	Hard Drive Rack Lock	Allows you to lock the hard drive rack in place.
5	POWER LED	Indicates that power is on.
6	STATUS LED	Indicates system status. <ul style="list-style-type: none"> • ALARM : Indicates alarm status. • LAN : Indicates when the system is connected to a PC via LAN. • CHECK : Indicates any abnormal occurrence during the system operation. • ARCHIVE : Indicates the video tape backup.
7	RECORD	Records live images.
8	REC LOCK	Locks all keys during recording to prevent accidental operation of the unit.
9	VCR	If the VCR LED is on, the system is in VCR mode and if it is off, the system is in DVR mode.

No	Name	Function
10	SEARCH	Displays a list of recorded data and allows you to easily search through the recorded data.
11	MENU	Displays the menu items. Use this also to exit the submenu and return to the menu at the next highest level. If the VCR LED is off, the DVR MAIN MENU will be displayed and if it is on, the VCR MAIN MENU will be displayed.
12	LEFT/REW	The LEFT arrow button moves the cursor to the left. This button also works as the REW button during playback. While in Pause mode, pressing this button will make the video reverse one frame at a time.
13	ENTER	Use this to accept the selected menu item or to accept the changed value.
14	DOWN/STOP	The DOWN arrow button moves the cursor down one position or lowers a value. This button also works as the STOP button during playback or recording.
15	RIGHT/FF	The RIGHT arrow button moves the cursor to the right. This button also works as the FF button during playback. While in Pause mode, pressing this button will make the video advance one frame at a time.
16	UP/PLAY/STILL	The UP arrow button moves the cursor up one position or raises a value. This button also works as the PLAY button and the button to pause playback or view still images.
17	EJECT	Push this button to eject the video tape.
18	VIDEO DECK	The cassette holder into which a video tape could be inserted.

Back View

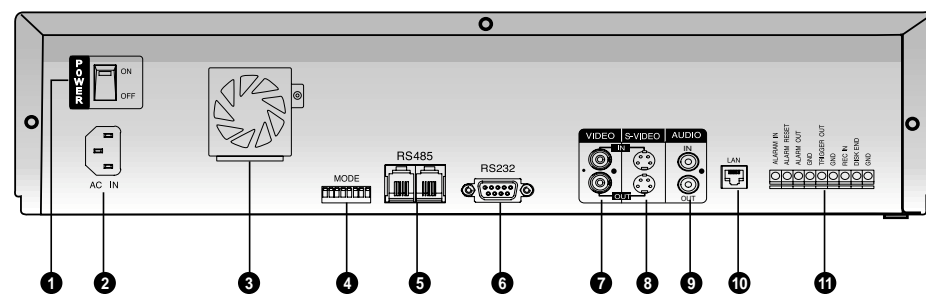

No	Name	Function
①	POWER	Power On/Off switch.
②	AC IN	The inlet for connecting the power cord. NTSC (AC 110 ~ 240V, 60 Hz) PAL (AC 220V, 50Hz)
③	FAN	Fan
④	MODE	Dip switches for setting the system ID, serial communication, and termination. <ul style="list-style-type: none"> • 1~5 : System ID (1 : Least Significant Bit, 5 : Most Significant Bit) (Push the dip switch up to set it to Off (0) and push it down to set it to On (1).) • 6 : Not Used • 7 : Termination On/Off (Use this to set the last system in a series of serially connected systems to ON or OFF.) (Push the dip switch up to set it to OFF and push it down to set it to ON.) • 8 : Not Used
⑤	RS485 PORT	A serial port for remote control.
⑥	RS232 PORT	A serial port for remote control.
⑦	Video In/Out Connectors	BNC style connectors for composite video input/output.
⑧		S-VIDEO input/output connectors.

No	Name	Function
⑨	Audio In/Out	RCA type audio input/output connectors.
⑩	LAN	Connector for LAN cable connection.
⑪	External Input/Output Ports	<ul style="list-style-type: none"> • ALARM IN: In N.C. (Normally Closed) mode, the system recognizes an alarm condition when a high (5V) signal is input for longer than 0.5 second. In N.O. (Normally Open) mode, the system recognizes an alarm condition when a low (0V) signal is input for longer than 0.5 second. • ALARM RESET: If a low (0V) signal is input for longer 0.5 second, Alarm mode will be cancelled.. • ALARM OUT: A high (5V) signal will be output during alarm recording. • TRIGGER OUT: This signal is for switching the multiplexer's recording output screen. • REC IN: The system begins recording if a low (0V) signal is input for longer than 0.5 second. • DISK END: If DISK END MODE in the RECORD MODE SETUP menu is set to STOP, a low (0V) signal will be output for about 1 second when the hard drive becomes full during recording.

4 Introduction to the Remote Control

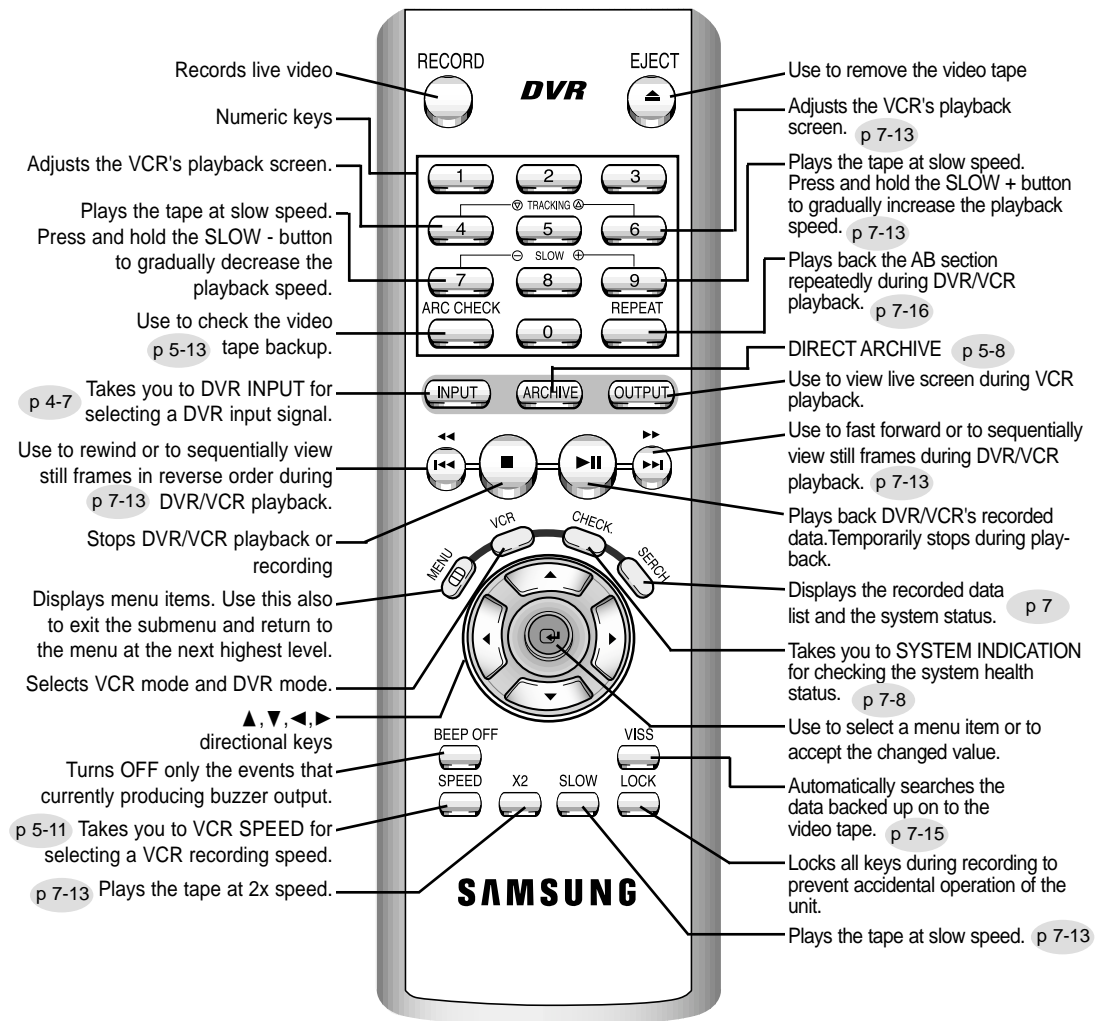

5 Checking the Package Contents

When purchasing product, first remove packing and put it on a flat floor or at a place to use it. Then, ensure all following contents are included:

- ▶ Main Unit
- ▶ User's Guide
- ▶ Power Cord (1)
- ▶ Remote Monitoring Program Installation CD-ROM
- ▶ Remote Control
- ▶ Battery (AAA size) (2)
- ▶ Removable Hard Drive Rack Key (2) (Including screw)

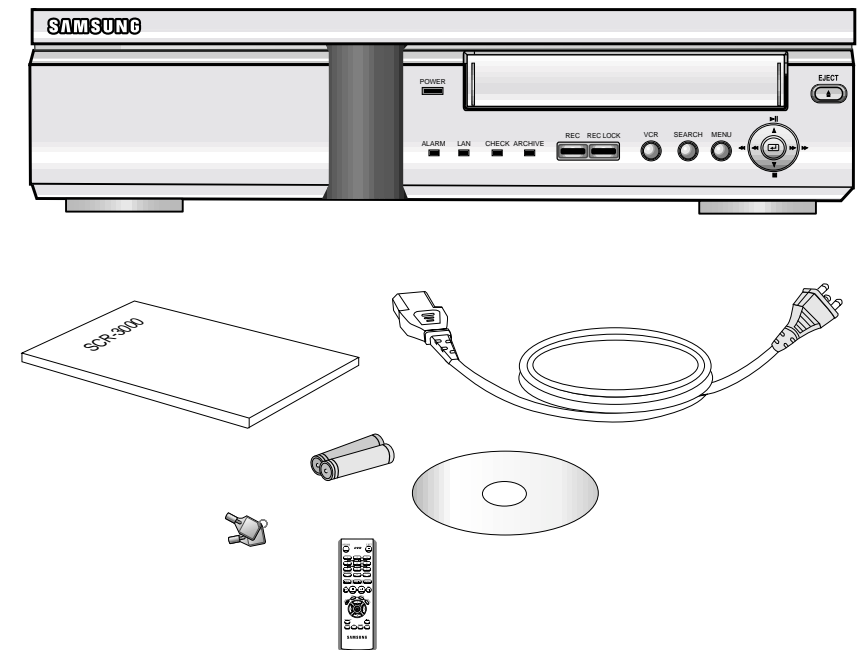

! Caution

The above items are subject to change without prior notice to improve product performance or functionality.

6 Attaching/Detaching HDD

Mounting HDD

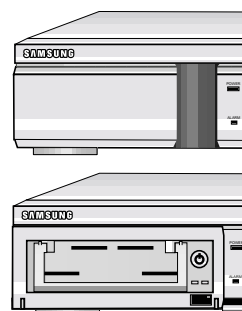

1. First, open the hard drive rack cover on the front of the main unit. Next, open the lock on the front of the rack with the key.

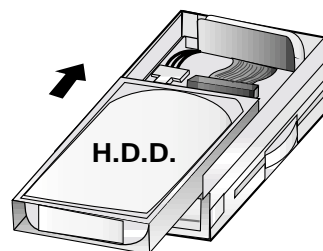

3. Connect the removable rack's data cable and power cord to your hard drive.

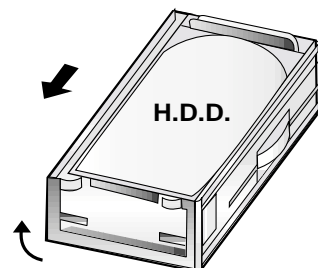

Lift up

2. Remove the hard drive rack from the main unit by lifting up the handle on the front of the rack and pulling straight out.

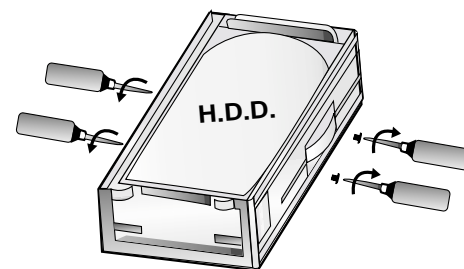

4. Slide your hard drive into the removable rack and fasten with screws.

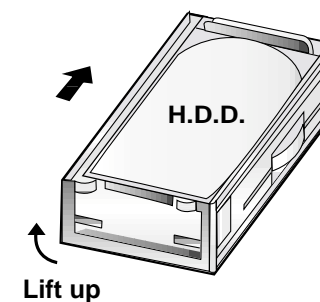

Lift up

5. Lift up the rack's front handle and push the rack into the main unit. Once the hard drive rack is fully inserted into the main unit, lower the front handle to secure it

6. Lock the hard drive rack with the key, and then turn on the power.

Note

When installing a HDD into the hard drive rack, be sure to set the HDD as Master mode. Otherwise, the system will not recognize the HDD. For instructions on how to set the HDD as Master mode, please refer to the HDD's manual. For example, for a Samsung Spinpoint V80 HDD, set the mode as follows:

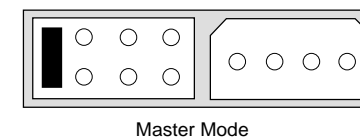

Caution

Be sure to lock the hard drive rack in place for normal operation of the system. Unless the hard drive rack is locked, the system cannot recognize your hard drive.

When removing the hard drive rack, be sure to wait until your hard drive's power LED goes off. When replacing your hard drive with another one, be sure to turn off the system's power. If you replace your hard drive with the power on, your hard drive may malfunction or be damaged.

If you want to use a hard drive from another machine, be sure to format it from a PC before using it. The system may not work normally if you use it without formatting it first. Hard disk drives recommended for use with the DVR COMBO are Samsung Spinpoint SV0802N and SEAGATE Barracuda 7200.7 80G.



II. Connection with Other Devices

1 Connection to External Devices

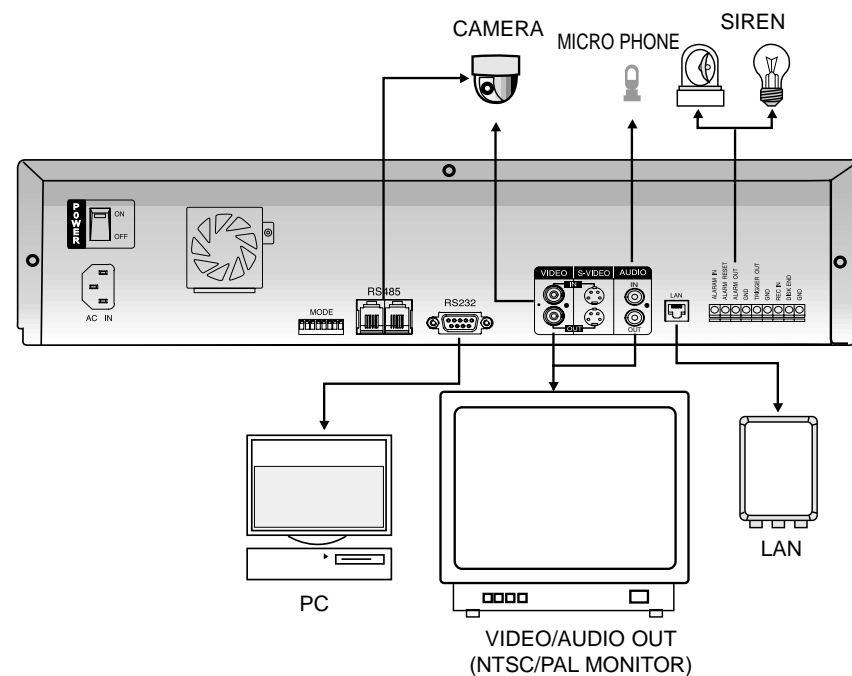

- This unit can be connected to external devices such as a camera for video signal input, a microphone for audio signal input, and an NTSC or PAL monitor for video and audio signal output.
- It can be connected to external devices such as an alarm according to the user's request.
- It can be connected to a PC through a LAN or Serial connection for remote control.

⚠ Caution

– A monitor capable of displaying an NTSC or PAL video signal must be used with this unit. An ordinary computer monitor cannot be used.

2 Connection with Multiplexer (e.g. connection to SDM-160)

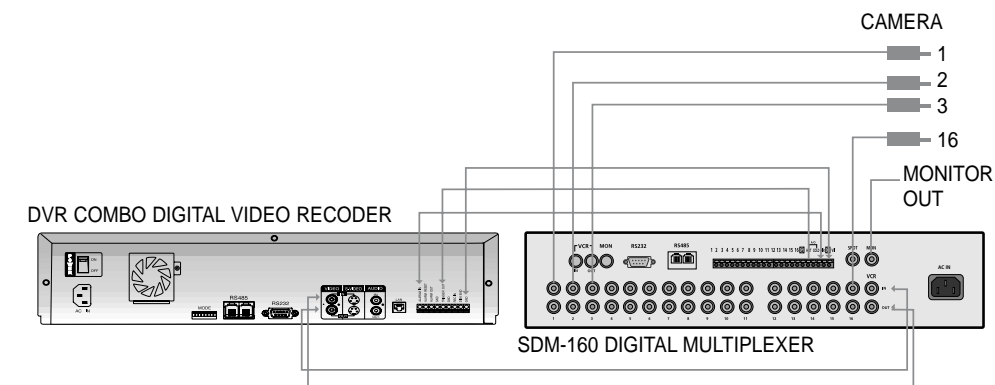

- SDM-160 is a Multiplexer for NTSC, and SDM-160P is a Multiplexer for PAL.
- Connect this unit's video signal input jack to the video signal output jack of SDM-160 and connect this unit's video signal output jack to the video signal input jack of SDM-160.
- Connect the alarm output jack (ALARM OUT) of SDM-160 to this unit's alarm input jack (ALARM IN), and connect the VTI jack of SDM-160 to this unit's trigger output jack (TRIGGER OUT).
- Connect both GND terminals together.
- For details on the functions of SDM-160, please refer to the user's guide of SDM-160.

⚠ Caution

- Be sure to connect the trigger output terminal (TRIGGER OUT) of this unit to the Multiplexer. Otherwise, a normal recording cannot be made. (For the connection method, please refer to the user's guide for the Multiplexer you want to use.)
- Set up the Multiplexer so that the selection of video signals is controlled by the Trigger Pulse in when the system's field recording rate is set from 0.5 ~ 15 FPS (Fields Per Second) for NTSC signals, or 0.5~12.5 FPS for PAL signals. (For settings related to the recording field rate, please refer to "(4) PICTURE RATE" on page 4-7.)
- Only half of a video channel may not be recorded, depending on the type of multiplexer, when the system's field recording rate is 30 FPS (for NTSC) or 25 FPS (for PAL). In this case, set the output mode of the multiplexer to Frame-Mode or adjust the field recording rate of the DVR to 60 FPS (for NTSC) or 50 FPS (for PAL).

3 System Connection for Alarm Recording

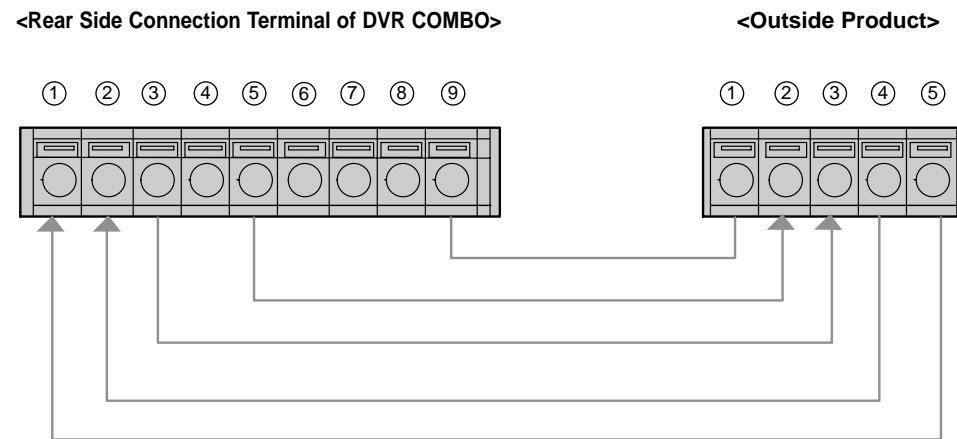

- | | |
|---------------|----------------|
| ① ALARM IN | ① GND |
| ② ALARM RESET | ② TRIGGER IN |
| ③ ALARM OUT | ③ ALARM IN |
| ④ GND | ④ ALARM CANCEL |
| ⑤ TRIGGER OUT | ⑤ ALARM OUT |
| ⑥ GND | |
| ⑦ REC IN | |
| ⑧ DISK END | |
| ⑨ GND | |

- Alarm recording is a function for recording the input video when an alarm signal is input while a device with alarm output is connected to this unit.
- Connect to the corresponding terminals, as the numbers may be different for external devices.
- For external devices, if the alarm input (ALARM INPUT) and alarm cancel (ALARM CANCEL) are not available, you can leave them unconnected.

4 Connection with PC for Use

Connection with RS-232C

A. Communication Method

- Data Code: ASCII Code
- Protocol: 8 bit Data, 1 Stop bit, None Parity
- Transmission speed: 4800, 9600, 19200, 38400, 115200 bps

B. RS-232C terminal (D-SUB 9 Pin) and Pin specifications

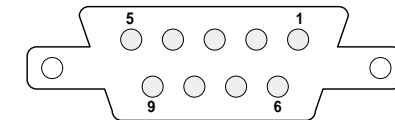

Pin No	Pin Specifications
2	TXD (Transmitted Data)
3	RXD (Received Data)
5	SG (Signal Ground)
1, 4, 6~9	NO Connection

Connection with RS-485

If you control cameras, remote control is allowed through connection with RS-485 (up to 1.2km).

A. Communication method

- Data transmission method: Start-Stop Asynchronized Serial Interface
- Protocol: 8 bit Data, 1 Stop bit, None Parity
- Transmission speed: 4800, 9600, 19200, 38400, 115200 bps

B. RS-485 terminal and Pin specifications

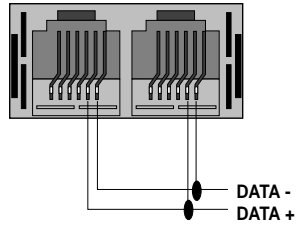

C. Data Format (Samsung Protocol)

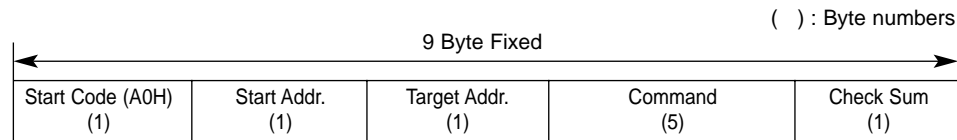

Data Byte	Type	Contents	Remarks
Byte 1	Start Code	0xA0	Start of Data Packet
Byte 2	Sender Addr.	Transmission Address	Source Range (0x00 ~ 0xFF)
Byte 3	Target Addr.	Reception Address	Destination Range (0x00 ~ 0xFF)
Byte 4	Command	Only Image Recorder Command	0x0A
Byte 5		Key Function	Range (0x01 ~ 0xFF)
Byte 6		0xFF	0xFF
Byte 7		0xFF	0xFF
Byte 8		0xFF	0xFF
Byte 9	Check Sum	Lower byte of (0xFFFF - (values adding Byte 2 ~ Byte 8))	

D. Code value by key

Function	Byte 1	Byte 2	Byte 3	Byte 4	Byte 5	Byte 6, 7, 8	Byte 9	Response (Byte 5)
[SET COMMAND]								
RECORD	0xA0	Src.Addr	Dest.Addr.	0x1A	0x0B	0xFF	Check Sum	Byte 5
REC LOCK	0xA0	Src.Addr	Dest.Addr.	0x1A	0x0A	0xFF	Check Sum	Byte 5
VCR	0xA0	Src.Addr	Dest.Addr.	0x1A	0x3D	0xFF	Check Sum	Byte 5
SEARCH	0xA0	Src.Addr	Dest.Addr.	0x1A	0x02	0xFF	Check Sum	Byte 5
MENU	0xA0	Src.Addr	Dest.Addr.	0x1A	0x01	0xFF	Check Sum	Byte 5
ENTER	0xA0	Src.Addr	Dest.Addr.	0x1A	0x35	0xFF	Check Sum	Byte 5
LEFT	0xA0	Src.Addr	Dest.Addr.	0x1A	0x06	0xFF	Check Sum	Byte 5
RIGHT	0xA0	Src.Addr	Dest.Addr.	0x1A	0x07	0xFF	Check Sum	Byte 5
STOP	0xA0	Src.Addr	Dest.Addr.	0x1A	0x08	0xFF	Check Sum	Byte 5
RIGHT	0xA0	Src.Addr	Dest.Addr.	0x1A	0x09	0xFF	Check Sum	Byte 5
UP	0xA0	Src.Addr	Dest.Addr.	0x1A	0x04	0xFF	Check Sum	Byte 5
DOWN	0xA0	Src.Addr	Dest.Addr.	0x1A	0x05	0xFF	Check Sum	Byte 5
EJECT	0xA0	Src.Addr	Dest.Addr.	0x1A	0x3E	0xFF	Check Sum	Byte 5

E. Others

- Above data format and transmission speed may be changed depending on future development conditions.
- PC operates as Master, and Target Set as Slave in transmission/reception of data.
- No status other than Set Key Function should be received.
(Some delay can be happen due to communication speed).



III. Basic Method to use

1 Booting the System

Power On

There is a power switch on the upper right hand side behind the system. Pull the power switch up to boot the system. Then, the POWER LED () on front of the system is turned on, a blue screen with the following message will appear and the system is booted.

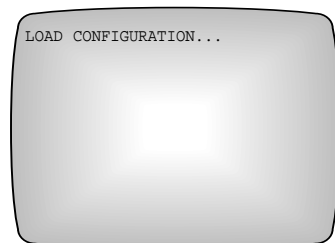

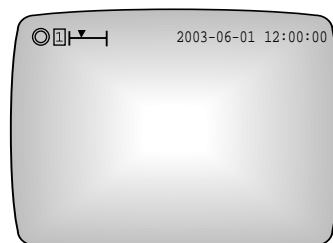

When booting is finished, the following Live screen will appear.



Recognizing incoming video signal

The SCR-3000N/SSC-Dual system only recognizes NTSC signal inputs only when booting. The system will not recognize PAL signals, and a disrupted output would result in a PAL signal were connected to the system's input. When this occurs, power-down the system and connect an NTSC signal to the input. The system then initializes to NTSC signals on power-up. On the other hand, the SCR-3000P system only recognizes PAL signal inputs. Please connect the video signals appropriate for each model.

If no HDD is installed or if the system is turned on while the hard drive rack is unlocked, the system will boot up and the Live screen will appear, but the system will not be able to find the HDD. As shown below, the HDD icon (),  will not appear.

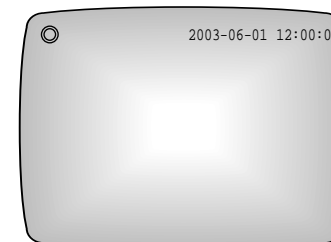

Power Off

Push the power switch down in order to turn off the system.

When the system power is turned off during recording, recording will be resumed next time the system power is turned on and booting is complete.

2 Basic Screen Viewing

Viewing Full Screen

Here comes the description of all the icons and status in the screen.

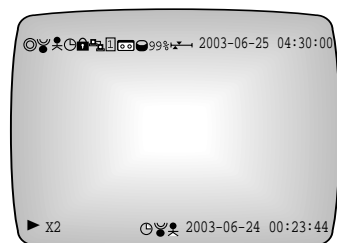

⊙	If system is in the recording state ⊙ icon will blink. However, it does not blink in the Live Screen state.
☺	If the system is in the recording state due to alarm, ☺ icon appears. In this state, ☺ icon continually blinks. While the data recorded by ALARM RECORD is playing, an ☺ icon will appear in front of the recording date and time of the data.
☹	If the system is in the recording state due to Motion Detection, ☹ icon appears. In this state, ☹ icon continually blinks. While the data recorded by Motion Detection playing, an ☹ icon will appear in front of the recording date and time of the data.
⌚	If the system is in the recording state due to the timer, ⌚ icon appears. While the data recorded by Timer record playing, an ⌚ icon will appear in front of the recording date and time of the data.
🔒	If the system in the recording lock state, 🔒 icon appears.
🌐	Appears when the system is connected to the PC's remote monitoring program via LAN.
📀	Indicates whether a HDD is installed or whether the hard drive rack is locked.
📼	Indicates whether a video tape is in the video deck.
📀	Indicates whether the data from the current HDD is being backed up on to a video tape.
99%	Displays the amount of free space remaining on the HDD in percent (%). However, this will be displayed only if DISK END MODE is set to STOP and not to OVERWRITE. For details, please refer to pages 4-8.

⏮	The upper pointer shows the relative location of the recorded data being stored inside the hard disk and the lower pointer shows the relative location of the data currently being played back. The following pointer will be hidden in the general live screen and recording screen.
You can change the above system status display position. The user will mark the position in the top left and right corner. (Select LEFT or RIGHT in STATUS POSITION of the CLOCK/DISPLAY MODE SET UP menu. Please refer to Page 4-6 for the details)	
2003-06-25 04:30:00	It shows the current date and time as configured by the system. You can change the display position of date and time. You shall designate the position in the top right or left corner by yourself. (Just choose LEFT or RIGHT in the CLOCK/DISPLAY MODE SETUP menu. Please refer to Page 4-6 for the details)
▶X2	If the system is in the playback mode, ▶ icon appears. And if the system is in the pause state, it changes to this icon . In addition, stored data can be played back at various speeds; when played in the forward direction at speeds other than the normal speed, the speed is shown on the right side of the ▶ icon and if it is played in the reverse direction at speeds other than the normal speed, ◀ icon appears and the right side of this ◀ icon shows the speed. Possible speeds in the system for forward and reverse directions are 1/5, 1/2, 1, 2, 5, 10, 20 times normal speed.
2003-06-24 00:23:44	It shows the recorded date and time of the data currently being played back. You can change the recording date and time display position. The user will mark the position in the bottom left and right corner. (Select LEFT or RIGHT in TIME MARK POSITION of the RECORD MODE SET UP menu. Please refer to Page 4-8 for the details.)

Live Screen Viewing

The normal Live screen looks like this.

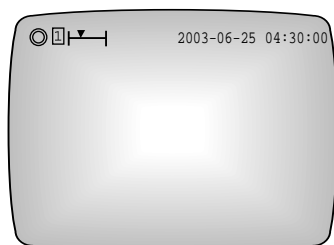

⦿	If system is in the recording state ⦿ icon will blink. However, it does not blink in the Live Screen state.
📁	Indicates whether a HDD is installed or whether the hard drive rack is locked.
⏮	It shows the relative location of the recorded data inside the hard disk.
2003-06-25 04:30:00	It shows the current date and time as configured by the system.

Viewing Screen during recording

The normal recording screen looks like this.

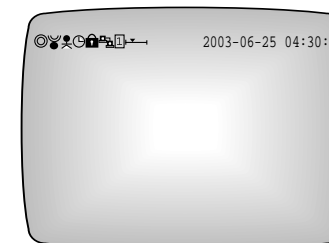



⦿	If the system is executing the recording function, ⦿ icon blinks.
📢	If the system is in the recording state due to alarm, 📢 icon appears. In this state, 📢 icon continually blinks.
👤	If the system is in the recording state due to Motion Detection, 👤 icon appears. In this state, 👤 icon continually blinks.
⌚	If the system is in the recording state due to the timer, ⌚ icon appears.
🔒	If the system in the recording lock state, 🔒 icon appears.
🌐	It occurs when the system is connected to remote viewer program through the LAN.
📁	Indicates whether a HDD is installed or whether the hard drive rack is locked.
⏮	It shows the relative location of the recorded data inside the hard disk.
2003-06-25 04:30:00	Indicates the current date and time of the system. The position of the date and time display on the screen can be changed. The date and time can be displayed either at the top left or top right of the screen. (Select either LEFT or RIGHT in DATE & TIME DISPLAY of the CLOCK/DISPLAY MODE SETUP menu. For details, see page 4-6.)

Playback screen Viewing

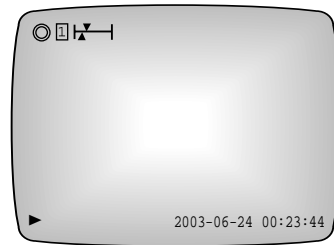
The normal Playback screen looks like this.



	<p>The upper pointer shows the relative location of the recorded data being stored inside the hard disk and the lower pointer shows the relative location of the data currently being played back.</p>
	<p>If the system is in the playback mode, ► icon appears. And if the system is in the pause state, it changes to this icon . In addition, stored data can be played back at various speeds; when played in the forward direction at speeds other than the normal speed, the speed is shown on the right side of the ► icon and if it is played in the reverse direction at speeds other than the normal speed, ◀ icon appears and the right side of this ◀ icon shows the speed. Possible speeds in the system for forward and reverse directions are 1/5, 1/2, 1, 2, 5, 10, 20 times normal speed.</p>
<p>2003-06-24 00:23:44</p>	<p>It shows the recorded date and time of the data currently being played back.</p>



IV. DVR Menu

1 Menu View

Entering the DVR MAIN MENU

Press the MENU () button. Then the following screen should appear.

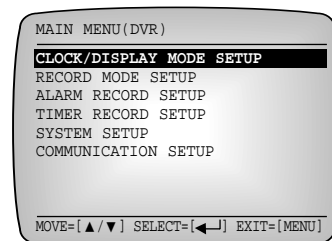

Note

- Make sure that the VCR LED is off before pressing the MENU button. If the VCR button had been pressed, the VCR MAIN MENU will be displayed.
- You can go into the menu only if the system is in Live Screen mode. If the system is in Record or Play mode, you cannot go into the menu. To go into the menu, first stop recording or playback.

Selecting a Menu Item

Use the UP(▲) and DOWN(▼) buttons to select the menu item you want. A highlighted cursor should appear over the selected item. Next, press the ENTER(↵) button to accept the choice. Settings will be displayed on the left and their values will be displayed on the right.

Changing the Settings

- ① Use the UP(▲) and DOWN(▼) buttons to select the setting you want to change.
- ② Press the ENTER(↵) button to accept the choice.
- ③ Use the UP(▲) and DOWN(▼) buttons to change the value.
- ④ Press the ENTER(↵) button to accept the choice.
- ⑤ When you press the ENTER button, some setting fields are toggled.

Move to Parent Menu or Menu End

Press the MENU() button to move to the parent menu from the lower mode or end the menu.

Example of menu setting (in case of changing time)

- ① Press the MENU button and then press the ENTER() button when the cursor points out the **CLOCK/DISPLAY MODE SETUP**. Then following screen appears.

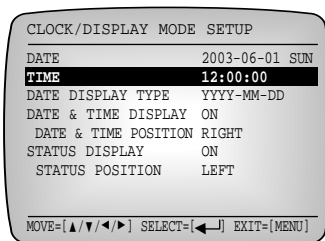

- ② Press the DOWN(▼) button so the cursor points out **TIME**. Then if pressing the ENTER() button, the cursor is changed so hour may be changed.

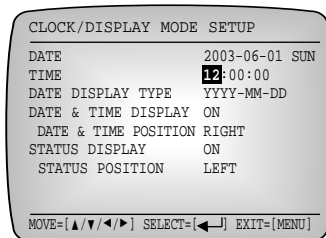

- ③ Press the UP(▲) or DOWN(▼) button so current time (hour) is displayed. Then if pressing the RIGHT(▶) button, the cursor is changed so minute may be changed.

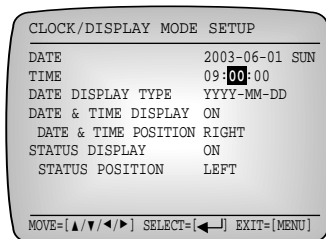

- ④ Similarly, press the UP(▲) or DOWN(▼) button so current minute is displayed. Then if pressing the LEFT(◀) or RIGHT(▶) button, the cursor is changed so hour or second is changed. For example, press the RIGHT(▶) button to change seconds and setup by pressing the UP(▲) or DOWN(▼) button so current second is displayed.

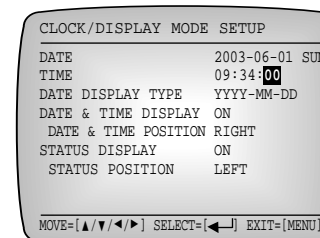

- ⑤ The cursor is changed as follows if pressing the ENTER() button after setting all hours. You may change other settings by pressing the LEFT(◀) or RIGHT(▶) button.

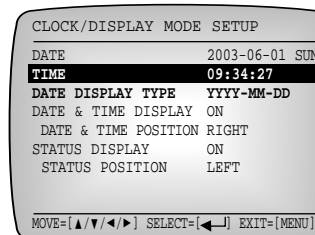

2 Setting of Date, Time and Screen

Each menu item

① CLOCK/DISPLAY MODE SETUP

CLOCK/DISPLAY MODE SETUP	
DATE	2003-06-01 SUN
TIME	12:00:00
DATE DISPLAY TYPE	YYYY-MM-DD
DATE & TIME DISPLAY	ON
DATE & TIME POSITION	RIGHT
STATUS DISPLAY	ON
STATUS POSITION	LEFT
MOVE=[▲/▼/▶/◀] SELECT=[←/→] EXIT=[MENU]	

② RECORD MODE SETUP

RECORD MODE SETUP	
DVR INPUT	VIDEO-IN
AUDIO RECORD	ON
PICTURE QUALITY	HIGH
PICTURE RATE	30.00FPS
DISK END MODE	OVERWRITE
DISK END BUZZER	ON
RECORD TIME MARK	ON
TIME MARK POSITION	RIGHT
MOVE=[▲/▼/▶/◀] SELECT=[←/→] EXIT=[MENU]	

③ ALARM RECORD SETUP

ALARM RECORD SETUP	
ALARM SIGNAL DETECTION	OFF
ALARM SIGNAL POLARITY	N.O.
ALARM BUZZER	ON
MAIN ALARM TIME	10 SECOND
PRE ALARM TIME LIMIT	2 SECOND
POST ALARM TIME LIMIT	OFF
MAIN ALARM PICTURE RATE	30.0 FPS
MOTION DETECTION	OFF
SET AREA & SENSITIVITY	
MOVE=[▲/▼/▶/◀] SELECT=[←/→] EXIT=[MENU]	

④ TIMER RECORD SETUP

TIMER RECORD SETUP				
TIMER	DAY	START	END	FIELD RATE
OFF	---	---	---	---
OFF	---	---	---	---
OFF	---	---	---	---
OFF	---	---	---	---
OFF	---	---	---	---
OFF	---	---	---	---
OFF	---	---	---	---
OFF	---	---	---	---
OFF	---	---	---	---
OFF	---	---	---	---
OFF	---	---	---	---
MOVE=[▲/▼/▶/◀] SELECT=[←/→] EXIT=[MENU]				

⑤ SYSTEM SETUP

SYSTEM SETUP	
PASSWORD	****
PASSWORD LOCK	OFF
HDD ERASE	OFF
FACTORY RESET	OFF
MENU SCREEN	DARK GRAY
LANGUAGE	ENGLISH
IR REMOCON	OFF
MULTIPLEXER	WITHOUT
MULTIPLEXER SELECT	SAMSUNG SDM-160
MOVE=[▲/▼/▶/◀] SELECT=[←/→] EXIT=[MENU]	

⑥ COMMUNICATION SETUP

COMMUNICATION SETUP	
BAUD RATE	115,200
NETWORK ACCESS	ON
IP ADDRESS	0. 0. 0. 0
GATEWAY	0. 0. 0. 0
SUBNET MASK	0. 0. 0. 0
NETWORK USER ID	****
NETWORK USER PWD	****
PAN/TILT TYPE	SCC-421
MOVE=[▲/▼/▶/◀] SELECT=[←/→] EXIT=[MENU]	

! Caution

Upon shipment from the factory, the values of the menu are set as follows.

The following illustrates the initial setting of the **CLOCK/DISPLAY MODE SETUP** menu.

CLOCK/DISPLAY MODE SETUP	
DATE	2003-06-01 SUN
TIME	12:00:00
DATE DISPLAY TYPE	YYYY-MM-DD
DATE & TIME DISPLAY	ON
DATE & TIME POSITION	RIGHT
STATUS DISPLAY	ON
STATUS POSITION	LEFT
MOVE=[▲/▼/▶/◀] SELECT=[←/→] EXIT=[MENU]	

① DATE

Set the current date.

② TIME

Time can be entered in the form of 24 hours.

! Caution

Be sure to set the date and time to the current date and time.

③ DATE DISPLAY TYPE

There are 3 date forms to be displayed. You can set in a convenient manner to see. [YYYY-MM-DD/DD-MM-YYYY/MM-DD-YYYY]

④ DATE & TIME DISPLAY

Set to **ON** to display the date and time on the screen, or set to **OFF** to not display them. [ON/OFF]

⑤ DATE & TIME POSITION

Set the location on the screen where the date and time will be displayed. Set to **LEFT** to display it on the top left of the screen, or set to **RIGHT** to display it on the top right of the screen. [LEFT/RIGHT]

⑥ STATUS DISPLAY

Set to **ON** to display the system status, such as recording, system lock, to remaining HDD capacity, and playback information when playing the recorded video; or set to **OFF** to not display them. [ON/OFF]

⑦ STATUS POSITION

Set the location on the screen where the system status will be displayed. Set to **LEFT** to display it on the top left of the screen, or set to **RIGHT** to display it on the top right of the screen. [LEFT/RIGHT]

3 Record Setup

The following illustrates the initial setting of the **RECORD MODE SETUP** menu.

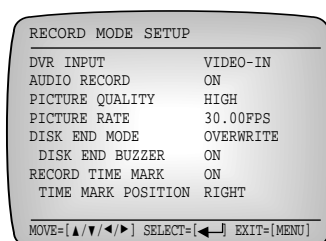

① DVR INPUT

Set the 3 types of Video Input signals going into the DVR. VIDEO-IN is the input signal going into the BNC Video Jack, S-VIDEO is the signal going into the S-VHS Jack, and VCR PB is the VCR playback signal. [VIDEO-IN/S-VIDEO / VCR PB]

② AUDIO RECORD

Set to ON to record video and audio at the same time, or set to OFF to record video only. Audio is input and recorded at 6.3 Kbps regardless of the recording field rate of the video [ON/OFF].

③ PICTURE QUALITY

Picture quality is divided into four levels. Set to **VERY HIGH** for the best picture quality, or set to **HIGH**, **NORMAL**, or **LOW** in the descending order of quality. The user can select the desired quality. [VERY HIGH/HIGH/NORMAL/LOW]

④ PICTURE RATE

Set the picture rate for the input video. Up to 60 FPS (Fields Per Second) can be recorded.

(SCR-3000P models can record up to 50 FPS (Fields Per Second))

- **SCR-3000N/SSC-Dual (NTSC)**
[60.00FPS/30.00FPS/15.00FPS/10.00FPS/7.50FPS/5.00FPS/2.50FPS/1.00FPS/0.50FPS]
- **SCR-3000P (PAL)**
[50.00FPS/25.00FPS/12.50FPS/8.33FPS/6.25FPS/5.00FPS/2.50FPS/1.00FPS/0.50FPS]

⑤ DISK END MODE

- If you select STOP, recording will stop when you consume the full HDD space.
- Setting this to OVERWRITE will continue to record the current data by overwriting the previous data. The relative positions where the recorded data are being stored in the HDD will be indicated on the screen in a bar format. If the **DISK END MODE** is set to STOP, in addition, the remaining HDD capacity will be indicated in percentage (%). [OVERWRITE/STOP]

⑥ DISK END BUZZER

If set to ON, the Buzzer will sound when the HDD is full during the recording; if set to OFF, the Buzzer will not sound. DISK END MODE needs to be set to STOP for activation. [ON/OFF]

⑦ RECORD TIME MARK

If set to ON, the recording time will be displayed during playback; if set to OFF, it will not be displayed. [ON/OFF]

⑧ TIME MARK POSITION

Set the location on the screen where the time of recording will be displayed during playback. Set to LEFT to display it on the bottom left of the screen, or set to RIGHT to display it on the bottom right of the screen. [LEFT/RIGHT]

Note

Set DVR input to VCR PB mode to show video in live video on screen. You can record the videotape into hard disk drive while playing it. Note that OSD will not display while recording. This is normal.

Please note that you cannot open VCR menu while setting the DVR input to VCR PB mode. Timer record setting in DVR menu is disabled as well.

4 Alarm Record Setup

Note

The following table shows how long it would take to fill up an 80GB HDD for each field rate.

(Recording time for each field rate may slightly vary depending on the type of input video signal.)

Picture Rate	Time-Lapse Mode				
	VERY HIGH	HIGH	NORMAL	LOW	
	80GB	80GB	80GB	80GB	
NTSC	60.0 FPS	11 H	13 H	19 H	25 H
	30.0 FPS	22 H	26 H	37 H	49 H
	15.0 FPS	44 H	53 H	74 H	99 H
	10.0 FPS	65 H	79 H	111 H	148 H
	7.5 FPS	87 H	106 H	148 H	198 H
	5.0 FPS	131 H	159 H	222 H	296 H
	2.5 FPS	261 H	317 H	444 H	593 H
	1.0 FPS	654 H	794 H	1,111 H	1,481 H
0.5 FPS	1,307 H	1,587 H	2,222 H	2,963 H	
PAL	50.0 FPS	13 H	19 H	27 H	36 H
	25.0 FPS	26 H	38 H	53 H	71 H
	12.5 FPS	52 H	76 H	107 H	142 H
	8.3 FPS	78 H	114 H	160 H	213 H
	6.3 FPS	105 H	152 H	213 H	284 H
	5.0 FPS	131 H	190 H	267 H	356 H
	2.5 FPS	261 H	381 H	533 H	711 H
	1.0 FPS	654 H	952 H	1,333 H	1,778 H
0.5 FPS	1,307 H	1,905 H	2,667 H	3,556 H	

The following illustrates the initial setting of the **ALARM RECORD SETUP** menu.

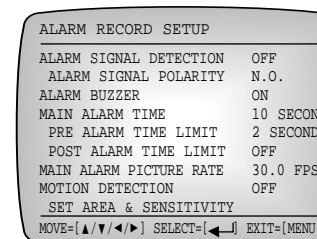

① **ALARM SIGNAL DETECTION**

You shall select **ON** to start recording in the event of alarming and select **OFF** to prevent recording in the event of alarming. If you set the **ALARM SIGNAL DETECTION** to **ON** and exit the menu, the system will begin recording whenever alarm occurs. To force stop the recording during the alarm recording, press and hold the **STOP(■)** button for 3 seconds. Then, the recording by the current alarm will be stopped, and the alarm recording will not be performed for the next 5 seconds even if alarm occurs. To completely stop the alarm recording, go into the menu within that 5 seconds to set the **ALARM SIGNAL DETECTION** to **OFF**. If no action is performed by the user for 5 seconds, the system returns to the alarm recording mode. **[ON/OFF]**

② **ALARM SIGNAL POLARITY**

Set to **N. C.** (Normally Close) when the alarm input is Active High, and set to **N.O.**(Normally Open) when the alarm input is Active Low. **[N.C./N.O.]**

③ **ALARM BUZZER**

Set to **ON** to have the system activate the Buzzer when a motion is detected in the input video or when alarm occurs, or set to **OFF** to keep the Buzzer inactive. **[ON/OFF]**

④ **MAIN ALARM TIME**

Set the duration for which alarm recording is to be performed when a motion is detected in the input video or when alarm occurs. The value can be set from 0 seconds to 5 minutes when you set to **OFF**. If you set to **AUTO**, the alarm recording is performed only during when the alarm signal is Active.

[5MINUTE/4MINUTE/3MINUTE/2MINUTE/1MINUTE/30SECOND/20SECOND/10SECOND/AUTO/OFF]

⑤ PRE ALARM TIME LIMIT

The pre-alarm recording is an important function which enables you to find out about the situation immediately before a motion is detected in the input video or before alarm occurs. Set how much video data you want to record before the motion is detected or alarm is triggered. About 2 seconds to 10 seconds of video data are stored in the system's SDRAM at all times. When a motion is detected or alarm is triggered, as much data as it is set in the **PRE ALARM TIME LIMIT** is taken from the SDRAM and written to the HDD as it simultaneously begins the alarm recording. However, since the capacity of the SDRAM is limited, the field rate of the pre-alarm recording will decrease as the time set in the **PRE ALARM TIME LIMIT** is increased.

[10SECOND/8SECOND/6SECOND/4SECOND/2SECOND/OFF]

⚠ Caution

If the system is currently recording, the PRE ALARM TIME LIMIT settings will not be applied even when alarm occurs. The PRE ALARM TIME LIMIT settings are applied only if the system is not currently recording.

⑥ POST ALARM TIME LIMIT

Set the amount of video data you want to record immediately after a motion is detected in the input video or alarm is triggered. The system records as long as the time set in the **MAIN ALARM TIME**, and then records more data as long as the time set in the **POST ALARM TIME LIMIT**.

[5MINUTE/4MINUTE/3MINUTE/2MINUTE/1MINUTE/30SECOND/20SECOND/10SECOND/OFF]

Note

The following illustrates the temporal relationship among the main alarm recording time (MAIN ALARM TIME), pre-alarm recording time (PRE ALARM TIME LIMIT), and post alarm recording time (POST ALARM TIME LIMIT) based on the time of alarm occurrence.



⑦ MAIN ALARM PICTURE RATE

Set the main alarm recording field rate.

(SCR-3000P models supports recording from 0.50 FPS (Fields Per Second) up to 50 FPS)

- SCR-3000N/SSC-Dual (NTSC)
[60.00FPS/30.00FPS/15.00FPS/10.00FPS/7.50FPS/5.00FPS/2.50FPS/1.00FPS/0.50FPS]
- SCR-3000P (PAL)
[50.00FPS/25.00FPS/12.50FPS/8.33FPS/6.25FPS/5.00FPS/2.50FPS/1.00FPS/0.50FPS]

⑧ MOTION DETECTION

The DVR will start recording images whenever it detects any movement only when **ALARM SIGNAL DETECTION** is set to **ON**. At this time, you can set the detailed items about the motion detection in the **SET AREA & SENSITIVITY** menu.

Even if MOTION DETECTION is set to ON, if you set MULTIPLEXER to WITH in SYSTEM SETUP, MOTION DETECTION will be enabled but MOTION RECORD will not be performed. To force stop the recording started by the motion detection, press and hold the STOP(■) button for 3 seconds. Then, the recording started by the motion detection will be paused for 5 seconds, during which time you should go into the menu and set the **MOTION DETECTION** to **OFF** to completely stop the recording. If no action is performed by the user for 5 seconds, the system resumes the recording started by motion detection. [ON/OFF]

⚠ Caution

When performing the recording started by motion detection, the recording time is determined by the the time set in MAIN ALARM TIME, PRE ALARM TIME LIMIT, and POST ALARM TIME LIMIT as it was the case in the alarm recording.

⑨ SET AREA & SENSITIVITY

1) AREA

Areas for motion detection are 4 in total and you can set the **LEVEL**, **SIZE**, and **MOVE** for each area. When you go into **SET AREA & SENSITIVITY** menu, the following screen appears and the cursor is positioned at the AREA item. At this time, press the UP(▲) or DOWN(▼) button to select the desired area (AREA 0 ~ AREA 3), and press the ENTER(↵) button to move the cursor to the **LEVEL** item to set the sensitivity level for the selected area. [0/1/2/3]

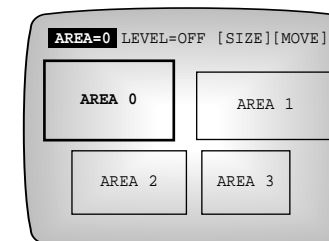

2) LEVEL

Sensitivity to motion can be set from **LOW** to **HIGH+**, or to **OFF**. Closer to **HIGH**, more sensitive to motion, closer to **LOW**, more insensitive to motion.

Press the UP(▲) or DOWN(▼) button to set the sensitivity level, and press the ENTER(↵) button to move the cursor to the **SIZE** item to set the size of the motion detection area.

[OFF/LOW/LOW+/MIDDLE/MIDDLE+/HIGH/HIGH+]

6 System Setup

The following illustrates the initial setting of the **SYSTEM SETUP** menu.

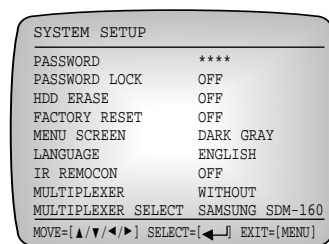

① PASSWORD

Set the system password. You can enter a 4-digit number and the initial set value is 0000.

② PASSWORD LOCK

If you set this to ON, the system will ask for a password, which was set in PASSWORD, when you press the MENU () button or when you attempt to cancel the recording lock while recording or when you attempt to remove the video tape from the video deck. If the password is invalid, you will not be able to finish the desired operation. If you set this to OFF, the system will not ask for a password for any of the operations above. [ON/OFF]

③ HDD ERASE

If you set to ON and exit the menu, the system will delete all data stored on the HDD. [ON/OFF]

Caution

Verify once again that is OK to delete the data, as deleted data cannot be restored.

④ FACTORY RESET

If you set to ON and finish the menu, all settings will be restored to their factory default settings. However, the data on the HDD will not be deleted. After RESET The message, "DO YOU REBOOT SYSTEM?" will be displayed. Select YES to reboot the system. [ON/OFF]

⑤ MENU SCREEN

If this is set to **DARK GRAY**, the background of the screen becomes darker when the MENU button is pressed and you will not be able to see the characters clearly. If set to **OFF**, you can see the current video clearly even when the MENU button is pressed. [DARK GRAY/OFF]

⑥ LANGUAGE

SCR-3000N/SSC-Dual models only supports English. SCR-3000P models however supports German, French, Spanish, and Italian in addition to English.

There is a language support setting function for the convenience of international users. The default language is set to English.

- SCR-3000N/SSC-Dual [ENGLISH]
- SCR-3000P [ENGLISH/DEUTSCH/FRANÇAIS/ESPAÑOL/ITALIANO]

⑦ IR REMOCON

If IR REMOCON to ON, signals from the remote control will be received and if it is set to OFF, signals from the remote control will not be received. The option will be turned off by factory default reset. For instructions on how to use the remote control, please refer to "4. Introduction to the Remote Control!" on page 1-7. [ON/OFF]

⑧ MULTIPLEXER

If MULTIPLEXER is set to WITHOUT, ID Detection will not be performed and the system will recognize it as 1CH regardless. If MULTIPLEXER is set to WITH, the Video ID input from the Multiplexer will be detected. Set MULTIPLEXER to WITH, and exit the MAIN MENU (DVR) to automatically start the Multiplexer ID Detection. In addition, MULTIPLEXER SELECT will be enabled and MOTION DETECTION-related functions will be disabled.

[WITHOUT/WITH]

⑨ MULTIPLEXER SELECT

If MULTIPLEXER is set to WITH, MULTIPLEXER SELECT will be enabled. The settings of all recording modes will be dependent on the Multiplexer setting.

The corresponding Multiplexers are SAMSUNG SDM-160(SDM-090), SMO-150(SMO-210, SOM-080).

- SCR-3000N/SSC-Dual [SAMSUNG SDM-160 / SAMSUNG SMO-150]
- SCR-3000P [SDM-160P / SAMSUNG VPP]

Caution

Do not set the multiplexer option to [With] and fail to receive the multiplexer output signal as input to avoid error in recording. Please set the multiplexer option to [Without] when not receiving the multiplexer output signal as input. Set the multiplexer option to [Without] unless the multiplexer manufacturer of the multiplexer is not Samsung.

7 Communication Setup

The following illustrates the initial setting of the **COMMUNICATION SETUP** menu.

COMMUNICATION SETUP	
BAUD RATE	115,200
NETWORK ACCESS	ON
IP ADDRESS	0. 0. 0. 0
GATEWAY	0. 0. 0. 0
SUBNET MASK	0. 0. 0. 0
NETWORK USER ID	****
NETWORK USER PWD	****
PAN/TILT TYPE	SCC-421
MOVE=[↑/↓/←/→] SELECT=[←/→] EXIT=[MENU]	

① BAUD RATE

Sets data transmission rate in RS-232C communication.
[4,800/9,600/19,200/38,400/115,200]

② NETWORK ACCESS/IP ADDRESS/GATEWAY/SUBNET MASK

If the system is connected to a LAN, it can be controlled from the remote surveillance program installed on a remote PC. To connect to a LAN, set the **NETWORK ACCESS** to **ON**, and configure the **IP ADDRESS**, **GATEWAY**, **SUBNET MASK**, etc. to suit the user's network environment. Then, connect the LAN Cable to the LAN Cable connection terminal on the back of the system and reboot the system. If at least one from the **IP ADDRESS**, **GATEWAY**, and **SUBNET MASK** is modified, the system must be rebooted to apply the modified setting to the system.

③ NETWORK USER ID/NETWORK USER PWD

In order to access the system through a LAN from a remote surveillance program installed on a remote PC, the user ID and password must be entered. At this time, the user ID and password entered match the ones set in the **NETWORK USER ID** and **NETWORK USER PWD**, you can connect to the system; otherwise, you cannot gain access. Both are 4-digit numbers and the initial set values are 0000.

④ PAN/TILT TYPE (Remote Control of Camera)

You can control the Pan/Tilt/Zoom function of a camera with the remote monitoring program installed in the remote PC through LAN. Then, you shall select the camera to be controlled. But, this remote control shall be applied only to SEC SCC-641/SCC-643(N/P) Cameras and SCC-421(N/P) Series Camera(C4201, C4203, C4301 and C4303) Camera which use the SAMSUNG Protocol. You can select the camera to be controlled by the remote monitoring program. Please refer to Remote Monitoring Program Use's Manual for the detailed explanation of the remote monitoring program. [SCC-641/SCC-421]



! Caution

After setting **IP ADDRESS**, **GATEWAY** and **SUBNET MASK**, exit the **MENU**. Then, a message "DO YOU REBOOT SYSTEM?" will appear. If you want to use the changed **NETWORK** information, select "YES" to reboot the system.

V. Viewing the VCR Menu

1 VCR Menus

Entering the VCR MAIN MENU

Press the VCR () button once. Then the VCR LED will light up. Now press the MENU () button. Then the following screen should appear.

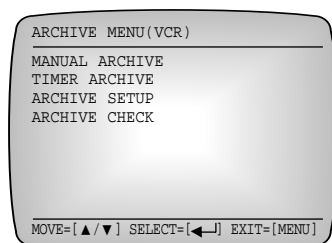

Note

- Make sure that the VCR LED is lit before pressing the MENU button. If the VCR button had not been pressed, the DVR MAIN MENU will be displayed.
- Record or Play mode, you cannot go into the menu. To go into the menu, first stop recording or playback.

Methods of selecting a menu item, changing settings, returning to the upper menu, and exiting the current menu are the same as in the DVR menus.

Menu Items

① MANUAL ARCHIVE

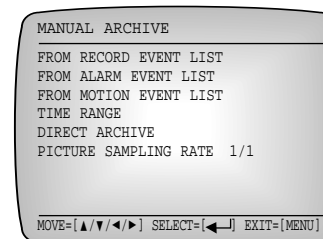

② TIMER ARCHIVE

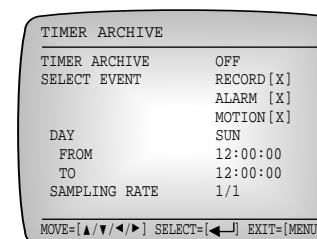

③ ARCHIVE SETUP

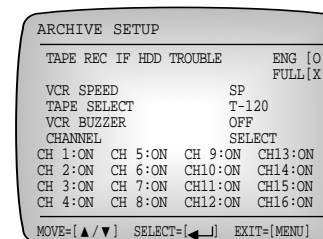

④ ARCHIVE CHECK

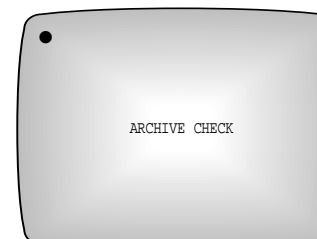

⚠ Caution

By default, the settings of each menu are as shown above.

2 MANUAL ARCHIVE

The following illustration shows the initial settings of the MANUAL ARCHIVE menu.

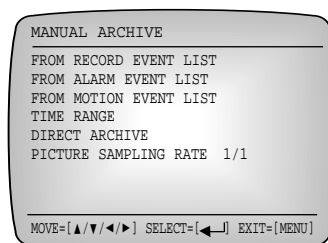

(1) FROM RECORD EVENT LIST

If you have pressed the RECORD button on the main unit to record on the hard drive or if you have recorded for a long time, the event list will be updated at a certain interval of time. FROM RECORD EVENT LIST allows you to use this list to perform the backup, more conveniently than using TIME RANGE. The following illustration shows the FROM RECORD EVENT LIST screen in detail. The EVENT (RECORD), DATE and TIME indicate when the event was recorded on the hard drive. To exit this screen and return to the MANUAL ARCHIVE menu, press the MENU button.

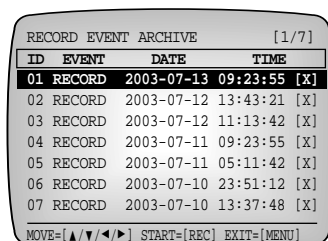

Use the LEFT(◀), RIGHT(▶), UP(▲) and DOWN(▼) buttons to select the event you want to back up. A highlighted cursor should appear over the selected item. Press the ENTER button (↵) to accept the choice. The selected event will be indicated by "[O]". Repeat this procedure for each event you want to back up, and then press the RECORD (REC) button to start the backup. The earliest event occurrence will be backed up first.

Once the backup starts, the following information will be displayed.

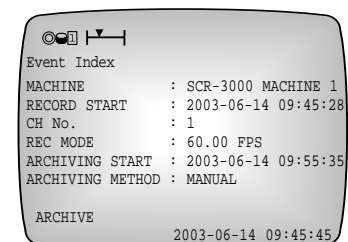

- MACHINE : "SCR-3000/SSC-Dual MACHINE 1" is the ID for the RS-485 connection.
- RECORD START : The date and time when the data you want to back up was recorded.
- CH No. : The input channel number of the data that you want to back up.
- REC MODE : The picture sampling rate of the recorded data that you want to back up
- ARCHIVING START : Backup start time.
- ARCHIVING METHOD : MANUAL ARCHIVE Method [MANUAL/TIMER/DIRECT]

Note

In REC Mode - that is, if the picture rate of the data to be backed up is less than 15FPS(for NTSC) or 12.5FPS(for PAL) - no audio will be backed up.

(2) FROM ALARM EVENT LIST

FROM ALARM EVENT LIST allows you to back up the video and audio data that has been recorded on the hard drive at the time of an event, which is triggered by alarm input or motion detection, onto a video tape. The following illustration shows the FROM ALARM EVENT LIST screen in detail. The EVENT (ALARM), DATE and TIME indicate when the event was recorded on the hard drive. To exit this screen and return to the MANUAL ARCHIVE menu, press the MENU button.



Use the UP (▲) and DOWN (▼) buttons to select the event you want to back up. A highlighted cursor should appear over the selected item. Press the ENTER (◀) button to accept the choice to set the event to [O]. Repeat this procedure for each event you want to back up, and then press the RECORD (REC) button to start the backup. The earliest event occurrence will be backed up first.

Once the backup starts, the following information will be displayed.

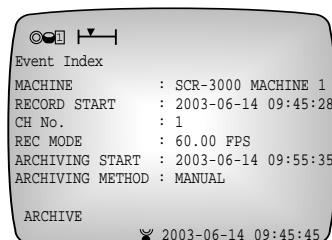

(3) FROM MOTION EVENT LIST

FROM MOTION EVENT LIST allows you to back up the video and audio data that has been recorded on the hard drive at the time of an event, which is triggered by motion detection, onto a video tape. The following illustration shows the FROM MOTION EVENT LIST screen in detail. The EVENT (MOTION), DATE and TIME indicate when the event was recorded on the hard drive. To exit this screen and return to the MANUAL ARCHIVE menu, press the MENU button.

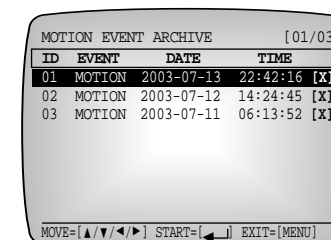

Use the UP (▲) and DOWN (▼) buttons to select the event you want to back up. A highlighted cursor should appear over the selected item. Press the ENTER (◀) button to accept the choice to set the event to [O]. Repeat this procedure for each event you want to back up, and then press the RECORD (REC) button to start the backup. The earliest event occurrence will be backed up first.

Once the backup starts, the following information will be displayed.

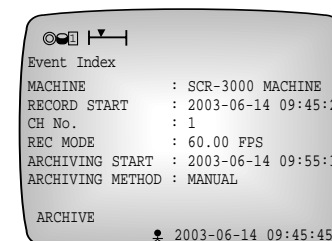



Note

- If MULTIPLEXER in the SYSTEM SETUP menu of the DVR MAIN MENU is set to WITH, MOTION EVENT ARCHIVE will be disabled. To perform the backup, set MULTIPLEXER in the SYSTEM SETUP menu to WITHOUT.

(4) TIME RANGE

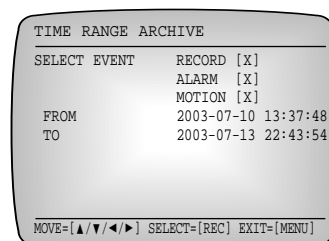
From the MANUAL ARCHIVE menu, select "TIME RANGE" and the following screen appears. In the TIME RANGE ARCHIVE screen, you can set the start and end times of a particular section of the video and audio that you want to back up from the hard drive.



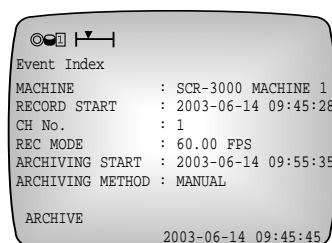

First select the event type. Next, set the start and end times of the section you want to back up. For example, if you want to back up the RECORD and MOTION types of events, set these two types of events to [O]. Next, enter the backup start and end times, and then press the RECORD () button. The RECORD and MOTION events within the specified time interval will be backed up earliest to most recent. Even if ALARM events are found within the section you have specified, they will be ignored because you did not select that event type.

**Note**

- If MULTIPLEXER in the SYSTEM SETUP menu of the DVR MAIN MENU is set to WITH, the MOTION event type will be disabled for SELECT EVENT in the TIME RANGE menu. To perform the backup, set MULTIPLEXER in the SYSTEM SETUP menu to WITHOUT.

(5) DIRECT ARCHIVE

DIRECT ARCHIVE allows you to back up the desired scenes to a video tape regardless of EVENT RECORD. First locate the desired scene. Next, press the VCR () button to enter VCR mode. Enter the MANUAL ARCHIVE menu, select DIRECT ARCHIVE, and then press the ENTER () button. The scene you have chosen will be backed up to the video tape. If you perform DIRECT ARCHIVE without locating the scene you want to back up, the backup will start from the last position stopped at during playback.

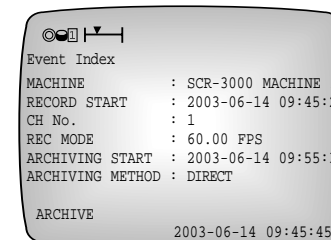
**Note**

- Even if you locate the desired scene and play it back in DVR mode for DIRECT ARCHIVE, playback will stop as soon as you press the VCR button.

(6) PICTURE SAMPLING RATE

PICTURE SAMPLING RATE allows you to reduce the picture sampling rate by a fractional number when backing up the hard drive to a video tape. For example, if you set the rate to 1/2 and back up the data that has been recorded at 30 fps, it will be backed up to the video tape at 15 fps.

Note

- If you back up the data after setting the picture sampling rate to a rate between 1/2 and 1/16, no audio will be backed up. Please note that this is not a malfunction.

3 TIMER ARCHIVE

The following illustration shows the initial settings of the TIMER ARCHIVE menu.

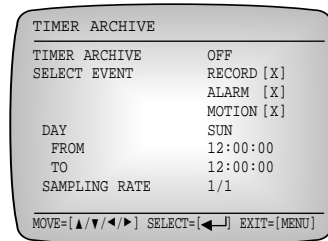

The Timer Backup function allows you to set the system to automatically back up the data that is recorded on the HDD to a video tape while you are away from the system. You can set the system to back up the desired type of event on the desired day of the week and time at the desired sampling rate. First set TIMER ARCHIVE to ON. Next, select all event types you want to back up by setting them to [O]. For example, a backup will not be performed, even if an alarm event occurs during the set time, unless ALARM EVENT is set to [O]. Set ARCHIVE SCHEDULE by selecting one from the following: SUN, MON, TUE, WED, THU, FRI, SAT, MON-FRI, MON-SAT, and DAILY. Enter the backup start and end times into FROM and TO fields respectively. Finally, set the picture sampling rate to the desired value between 1/1 to 1/16.

To cancel the TIMER ARCHIVE you have set, press the STOP(■) button for 3 seconds. The TIMER ARCHIVE will pause for 5 seconds. However, if you do not make any action for 5 seconds, the system will reset to the Timer Archive after 5 seconds have elapsed. To completely cancel the TIMER ARCHIVE, enter the menu within 5 seconds and set the TIMER ARCHIVE to OFF.

Because TIMER ARCHIVE is an automatic backup for the data that will be recorded, any data that has already been recorded will not be backed up. The following illustrates the timeline of TIMER ARCHIVE.

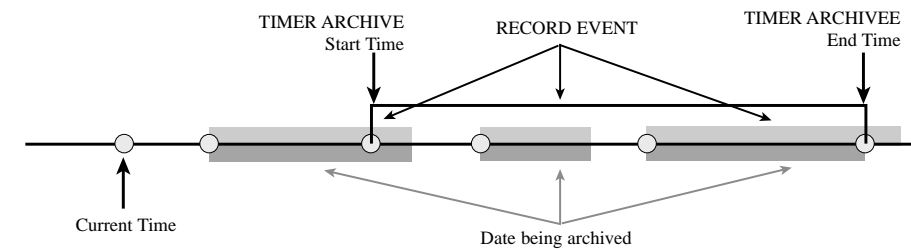

The TIMER ARCHIVE time is a future time, rather than the current time. If the time you set is earlier than the current time, it is tomorrow's time or a time in the next week. In the above illustration, the TIMER ARCHIVE time is set and there are 3 record events. The first event overlaps with the TIMER ARCHIVE start time. In this case, archiving will start at the start time of the record event that is overlapping. Archiving will start as an event ends. The third event is overlapping with the end time of TIMER ARCHIVE. In this case, only the data between the event start time and archiving end time will be archived when the TIMER ARCHIVE set time ends, even if the record event is not finished.

Note

- If MULTIPLEXER in the SYSTEM SETUP menu of the DVR MAIN MENU is set to WITH, the MOTION event type will be disabled for SELECT EVENT of the TIMER ARCHIVE menu.

4 ARCHIVE SETUP

The following illustration shows the initial settings of the ARCHIVE SETUP menu.

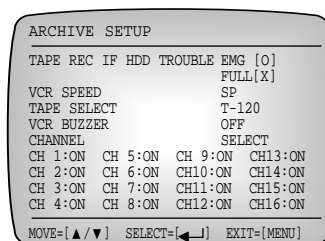

(1) TAPE REC IF HDD TROUBLE

1) EMG

Set whether to allow the VCR to continue the recording if the hard drive fails for some reason. If there is a problem in HDD, it will automatically execute VCR BACKUP. If you replace the failed hard drive with a new one, VCR backup will be cancelled and the system will to the previous state, before the failure occurred. [O/X]

2) FULL

Set whether to allow the VCR to continue the recording if DISK END MODE is set to STOP. However, if DISK END MODE is set to OVERWRITE, this will be disabled. [O/X]

(2) VCR SPEED

Set the recording mode for the VCR. If you set this to SP, recording time will be shorter but picture quality will be better than setting it to SLP; and if you set this to SLP, recording time will be longer but picture quality will be poorer than setting it to SP.

- SCR-3000N/SSC-Dual [SP/SLP]
- SCR-3000P [SP/LP]

Note

- *Recording Time to Recording Mode*

	SP	SLP
SCR-3000N/SSC-Dual (NTSC, based on T-120)	2 Hours	6 Hours
	SP	LP
SCR-3000P (PAL, based on E-180)	3 Hours	6 Hours

(3) TAPE SELECT

Set the tape length for accurate calculation of remaining tape time and precise control.

- SCR-3000N/SSC-Dual [T-120/T-160/T180]
- SCR-3000P [E-180/E-210/E-260]

(4) VCR BUZZER

Set the buzzer so that the VCR's status could be known. If there is a problem in VCR SYSTEM Set it to ON to enable the BUZZER and to OFF to disable the BUZZER.

The buzzer will sound in the following cases.:

- If there is a problem in the VCR SYSTEM.
- If the tape reaches the end part or is in PRE END (when the remaining time is less than 5 minutes) during ARCHIVE.
- If there is no tape inserted, or REC Safety TAB is removed from the inserted tape when you start ARCHIVE, or in TIMER ARCHIVE MODE. [ON/OFF]

(5) CHANNEL

CHANNEL is enabled if MULTIPLEXER is set to WITH and disabled if it is set to WITHOUT. If CHANNEL is enabled and you set it to SELECT, all channels recorded on the hard drive will be displayed. If you set it to ALL, all channels will be set to ON and become targets for backup. [SELECT/ALL]

5 ARCHIVE CHECK

The ARCHIVE CHECK function allows you to check whether the images played back on the DVR and transferred to the VCR are recorded correctly. The DVR plays back the signals to be Archived for 5 seconds and send them to the VCR and the VCR records them.

After 5 seconds, the DVR stops playback and the VCR stops recording at the same time. The VCR plays back 5 seconds of the most recently recorded data. ARCHIVE CHECK cannot be performed during archiving; it is possible after archiving has stopped.

To perform ARCHIVE CHECK, in VCR mode, place the cursor at the ARCHIVE CHECK of ARCHIVE MENU and press the ENTER () button or press the ARC CHECK button on the remote control. The ARCHIVE CHECK will start and the following screen will appear.

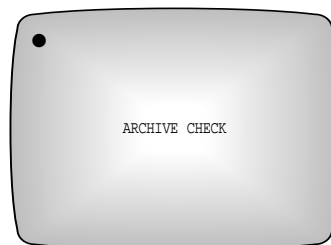

In the above screen, signals from the DVR are being recorded on the VCR for about 5 seconds. After about 5 seconds, ■ icon will appear at the top left corner of the screen and the VCR will rewind to the start point of the most recently recorded images. Then, ► icon will appear and the VCR will play back the backed-up data.

Note

- The VCR play screen will not be output to S-VIDEO OUT.





VI. Record

1 Basic Record

Basic Record

① CURRENT IMAGE RECORD

Press the RECORD() button to record current image. If doing so, the light of the RECORD() button turns on and record starts while following message appears on the screen. Settings related with record are done in the **RECORD MODE SETUP** menu.

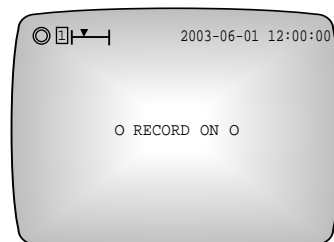



Note

- Recording is possible both when the system is in the Live screen mode or in the playback mode. However, whereas the Live screen currently showing will be recorded when the system is in the Live screen mode, the video that is currently being input separate from the screen currently being played will be recorded when the system is in the playback mode.
- While the user is in the menu, pressing the RECORD() button will not start the recording. To start the recording, first exit the menu.

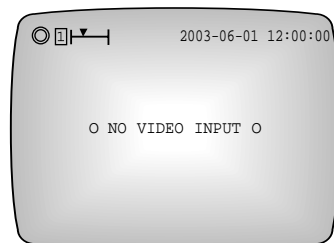
If the incoming video signal is disconnected during recording, recording will be stopped. But, if the incoming video signal is reconnected, the system recognizes this and start to record again. In addition, when pressing RECORD() button without connecting any video signals to the input port, the following Message is shown on the screen and the system will not carry out the recording function.



② RECORD STOP

Press the STOP() button to stop recording. Then, the light will go off in the RECORD () button and recording will stop with the following message on the bottom of the screen.

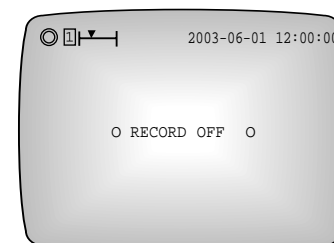

Note





Menu screen will not be displayed even if the MENU button is pressed during recording. If the MENU button is pressed during the recording, the following message will appear. To view the menu screen, the recording must be stopped.



If there is a copy protection signal while receiving VIDEO input image from DVD or VIDEO TAPE, it records for a moment and stops recording with "COPY PROTECT" message on the screen.

2 Record Lock



Record Lock

Press the REC LOCK () button during recording to lock the recording. Then, the REC LOCK () button will light up. At this time, pressing the STOP () button will not stop the recording. An  icon appears on the top left of the screen when in the Recording Lock mode.

(Please refer to “Viewing Screen during Recording” on p. 3-6.)

Record Lock Release

To cancel the Recording Lock, press the REC LOCK () button.

When the REC LOCK () button lights up, press the STOP () button to stop recording. If the **PASSWORD LOCK** of the **SYSTEM SETUP** menu is set to **ON**, you must enter a password to cancel the recording lock. At this time, if the password entered matches the one set in the **PASSWORD** of the **SYSTEM SETUP** menu, then the recording lock will be cancelled; otherwise, it will not be cancelled.

3 Alarm Record

Record in Alarm Occurrence

There is an alarm input terminal (ALARM IN) on the external I/O port at the back panel of the DVR COMBO system. Connect here the alarm output terminal of an external device, such as Multiplexer. (For detailed information on connections, please refer to “3. System Connection for Alarm Recording” on p. 2-3.) Next, set the **ALARM SIGNAL DETECTION** of the **ALARM RECORD SETUP** menu to **ON** to begin recording whenever alarm is triggered. Also, set the **MOTION DETECTION** of the **ALARM RECORD SETUP** menu to **ON** to begin the alarm recording whenever a motion is detected within the area set in the **SET AREA & SENSITIVITY**.

Release of Alarm Record

If the system is not in the alarm recording mode, in order to cancel the alarm recording mode, set the **ALARM SIGNAL DETECTION** and **MOTION DETECTION** of the **ALARM RECORD SETUP** menu to **OFF**. To force stop the recording during the recording started by an alarm, press and hold the STOP () button for 3 seconds. Then, the recording by the current alarm will be stopped, and the alarm recording will not be performed for the next 5 seconds even if alarm occurs. To completely stop the alarm recording, go into the menu within those 5 seconds to set the **ALARM SIGNAL DETECTION** to **OFF**. If no action is performed by the user for 5 seconds, the system returns to the alarm recording mode.

4

Reservation Record

Reservation Record Setup

You can enter the day, time, and field rate for the timer recording in the **TIMER RECORD SETUP** menu so that the recording will be made on the set day for the set amount of time.

Reservation Record Cancel

If the system is not in the timer recording mode, in order to cancel the timer recording, set the **TIMER** row of the line you want to cancel to **OFF** in one of the timer recording list set in the **TIMER RECORD SETUP** menu. However, if you want to force stop the timer recording during the recording, press and hold the **STOP(■)** button for 3 seconds. Then, the recording will pause for 5 seconds. If no action is performed by the user for 5 seconds, the system determines whether the timer recording setup time is elapsed and resumes the recording if not. To completely stop the recording, go into the menu within 5 seconds to set the **TIMER** item of the corresponding line to **OFF**.

Caution

To stop the recording when you are recording by pressing the **RECORD()** button, shortly press the **STOP(■)** button. However, if you want to stop the recording which is the alarm or motion recording or timer recording, you should press and hold the **STOP(■)** button for 3 seconds. This is to give the user an opportunity to change the menu settings to completely stop the recording after pressing and holding the **STOP(■)** button for 3 seconds to force stop the recording. Because if the system is in the recording mode by alarm or motion detection, or in the timer recording mode, there is no special method for the user to arbitrarily stop the recording and the user cannot go into the menu during the recording, unless an alarm or motion is not detected or the timer recording setting time is not elapsed.



VII. Retrieval and Playback

1 Search Menus

Entering the DVR SEARCH MENU

To search the recorded data, press the SEARCH () button. Then the following screen should appear.

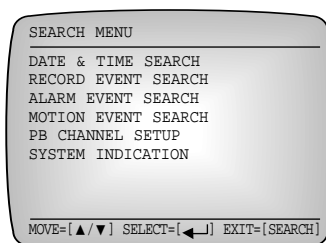

Note

- If the system is in Live Screen mode, Record mode, or Play mode, you can search all recorded data.
- If you search the recorded data during playback, the newly searched data will be played regardless of which data was playing previously.
- While you are in a menu, you cannot go into the SEARCH MENU by pressing the SEARCH () button. To go into the SEARCH MENU, exit the menu you are currently in.

Selecting a Menu Item

Use the UP(▲) or DOWN(▼) buttons to move to the menu item you want.

A highlighted cursor should appear over the selected item. Next, press the ENTER () button to accept the choice. In submenus, you can set the criteria for your data search or select and play back an item from the list of recorded data.

Setting the Search Criteria & Selecting an Item from the List

In the DATA & TIME SEARCH menu, set the search criteria. In the RECORD EVENT SEARCH and ALARM EVENT SEARCH, MOTION EVENT SEARCH menus, select one from the list of recorded data. Methods of setting the search criteria and selecting an item from the list are the same as in other menus.

Returning to the Upper Menu or Exit the Current Menu

Press the SEARCH () button to exit the current menu level or to return to the upper menu.

Menu Items

① DATE & TIME SEARCH

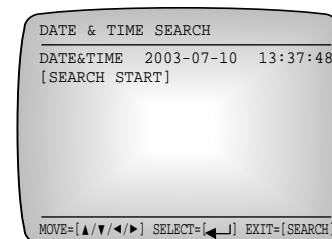

② RECORD EVENT SEARCH

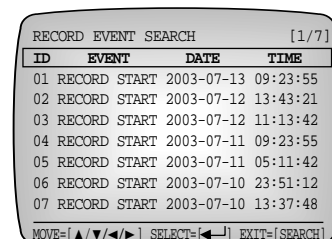

③ ALARM EVENT SEARCH

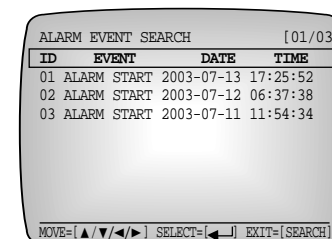

④ MOTION EVENT SEARCH

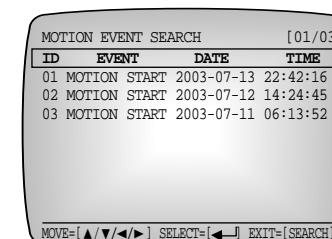

⑤ PB CHANNEL SETUP

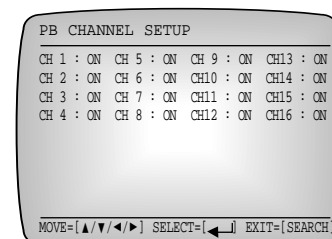

⑥ SYSTEM INDICATION

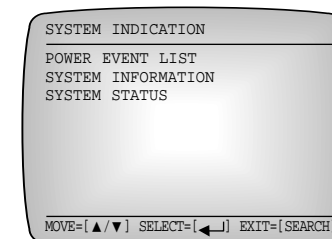

⚠ Caution

- No list will be displayed when you go into the RECORD EVENT SEARCH or ALARM EVENT SEARCH, MOTION EVENT SEARCH menu, or the POWER EVENT LIST screen because no data is recorded on the hard drive when it is first shipped from the factory.

2 Retrieval by Date and Time

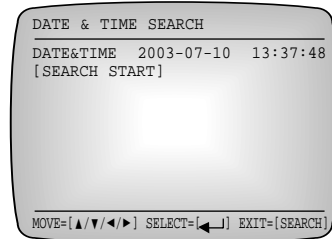

Enter the date and time you want to search, place the cursor at SEARCH START, and then press the ENTER (←) button. The following screen will appear and the system will start the data search. If the data corresponding to the date and time you entered is not available, the list that is closest to the date and time you entered will be searched.

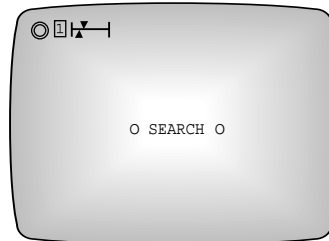

Once the system has finished searching the data, a pause screen of the searched data will appear. You can play retrieval data if pressing the PLAY/STILL (▶) button. Press the STOP (■) button to stop play. Following screen is a screen appearing when pressing the PLAY/STILL (▶) button. Date and time below the screen show when currently played data are recorded and figures at the far end shows which times of frame of the relevant second.

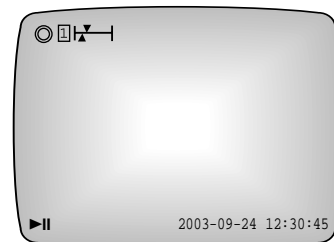

⚠ Caution

If you do not correctly set the date and time, it cannot properly search at DATE & TIME SEARCH, resulting in "SEARCH FAIL". Make sure to use the system after properly setting the data and time.

3 Recorded Data List View

ID	EVENT	DATE	TIME
01	RECORD START	2003-07-13	09:23:55
02	RECORD START	2003-07-12	13:43:21
03	RECORD START	2003-07-12	11:13:42
04	RECORD START	2003-07-11	09:23:55
05	RECORD START	2003-07-11	05:11:42
06	RECORD START	2003-07-10	23:51:12
07	RECORD START	2003-07-10	13:37:48

Of those data recorded on the HDD, the ones recorded by motion detection will be listed in order of recording start time. The list will be updated every 30 minutes, based on 30 FPS. Therefore, the system will create a new list during recording after 30 minutes has elapsed from the previous event.

The system begins the recording when the RECORD (REC) button is pressed, or when a motion is detected or alarm is triggered, or when the timer recording time is up, here the list of the data recorded by motion detection or alarm occurrence is not displayed.

Place the cursor at one of the items on the list of the recorded data and press the ENTER (←) button. The system will start the data search.

Next, the following screen will appear and the data event that you want to search will be played back.

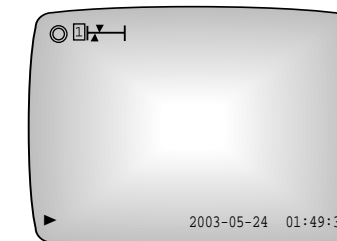

4 Alarm Record Retrieval

ALARM EVENT SEARCH [01/03]			
ID	EVENT	DATE	TIME
01	ALARM START	2003-07-13	17:25:52
02	ALARM START	2003-07-12	06:37:38
03	ALARM START	2003-07-11	11:54:34

MOVE=[▲/▼/◀/▶] SELECT=[←] EXIT=[SEARCH]

Among the data on the HDD, the ones that were recorded when an alarm was triggered will be displayed as a list based on the recording start time.

Other information is same as in "3. Recorded Data List View" on p. 7-4.

Note

If the list of the recorded data cannot be shown in a screen, you can use the LEFT(◀) or RIGHT(▶) button to view the list in pages. Press the LEFT(◀) button to move to the previous page, or press the RIGHT(▶) button to move to the next page.

5 Searching Motion Detection Recordings

MOTION EVENT SEARCH [01/03]			
ID	EVENT	DATE	TIME
01	MOTION START	2003-07-13	22:42:16
02	MOTION START	2003-07-12	14:24:45
03	MOTION START	2003-05-11	06:13:52

MOVE=[▲/▼/◀/▶] SELECT=[←] EXIT=[SEARCH]

Of those data recorded on the HDD, the ones recorded by motion detection will be listed in order of recording start time. Other information is same as in "3. Viewing the Recorded Data List" on page 7-4.

Note

- If the list of the recorded data cannot be shown in a screen, you can use the LEFT(◀) or RIGHT(▶) button to view the list in pages. Press the LEFT(◀) button to move to the previous page, or press the RIGHT(▶) button to move to the next page.
- In DVR MENU, if MULTIPLEXER of SYSTEM SETUP is set to WITH, MOTION EVENT SEARCH of SEARCH MENU will be disabled.

6 PB CHANNEL SETUP

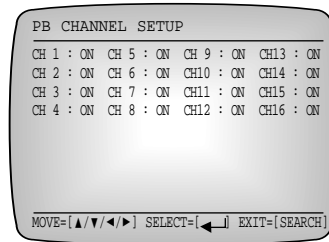

When recording in conjunction with a multiplexer, you can show or hide the playback of a particular channel. Set the channel to ON to show it or set the channel to OFF to hide it.

Note

If MULTIPLEXER in the SYSTEM SETUP menu of the DVR MAIN MENU is set to WITHOUT, PB CHANNEL SETUP will be disabled.

7 SYSTEM INDICATION

The following screen appears when you select SYSTEM INDICATION.

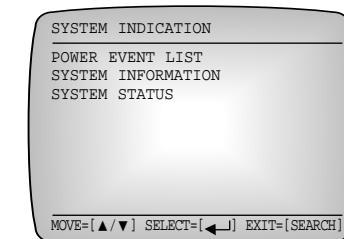

(1) POWER EVENT LIST

POWER EVENT LIST				[01/08]
ID	EVENT	DATE	TIME	
01	POWER ON	2003-09-24	00:00:52	
02	POWER OFF	2003-09-24	00:07:38	
03	POWER ON	2003-09-24	00:11:56	
04	POWER OFF	2003-09-24	00:23:24	
05	POWER ON	2003-09-24	00:39:12	
06	POWER OFF	2003-09-24	01:47:06	
07	POWER ON	2003-09-24	02:52:10	
08	POWER OFF	2003-09-24	02:55:37	

MOVE=[▲/▼/◀/▶] EXIT=[SEARCH]

The dates and times when the system was turned on and off will be displayed in chronological order.

(2) SYSTEM INFORMATION

The following illustration shows the initial settings of the SYSTEM INFORMATION menu.

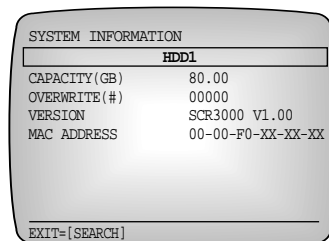

It displays the basic system information.

If DISK END MODE in the RECORD MODE SETUP menu and the hard drive's capacity (GB: Gigabyte) are set to OVERWRITE, you can tell from the information shown in the CAPACITY(GB) and OVERWRITE(#) fields the number of times the hard drive has been overwritten. The VERSION field shows the version of the software installed on the system and the MAC ADDRESS field shows the MAC address entered in the system.

(3) SYSTEM STATUS

The following illustration shows the initial settings of the SYSTEM STATUS menu.

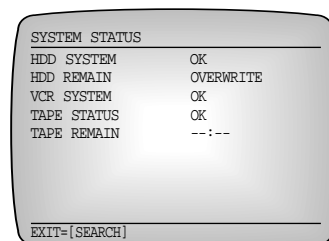

1) HDD SYSTEM

This shows the status of the hard drive. Messages used to indicate hard drive status and their meanings are as follows:

- OK : Normal
- HDD NOT IN : The hard drive rack is empty or the hard drive rack lock is unlocked.

2) HDD REMAIN

This shows the remaining hard drive space. However, if DISK END MODE in the RECORD MODE SETUP menu is set to OVERWRITE, "OVERWRITE" will be displayed. The percentage of remaining space will be displayed only if DISK END MODE is set to STOP.

3) VCR SYSTEM

This shows the status of the VCR. If the VCR fails, the CHECK LED will blink and the buzzer will sound. Messages used to indicate VCR status and their meanings are as follows:

- OK : Normal
- DE : Drum Motor Emergency
- CE : Capstan Motor Emergency
- LE : Loading Motor Emergency

4) TAPE STATUS

This shows the status of the video tape. If the current status of TAPE STATUS is not normal, the CHECK LED blinks and the BUZZER will sound at the interval of 1 second or continuously.

Messages used to indicate tape status and their meanings are as follows:

- OK : Normal
- REC PROTECT: When the it has inserted tape has the removed of REC SAFETY TAB removed.
- TAPE NOT IN: When the VIDEO TAPE is not inserted.
- TAPE END: When the VIDEO TAPE reaches the end part.
- TAPE PRE-END: When the remaining time of VIDEO TAPE is less than 5 minutes.

5) TAPE REMAIN

This shows the amount of physical tape capacity remaining.

8 Basic Playback

To immediately play back the data recorded on the HDD, press the PLAY/STILL (▶||) button. The following screen will appear and the beginning of the recorded data will be played back in turn.

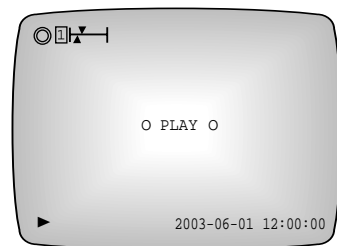

Note

- They can all be played back if the system is in the Live screen mode or in the recording mode.
- While the user is in the menu, pressing the PLAY/STILL (▶||) button will not start the playback. To start the playback, first exit the menu.

To stop playback, press the STOP (■) button. Press the PLAY/STILL (▶||) button again to resume playback from where you last stopped. When the data reaches the end of the HDD during playback, the playback will start from the beginning of the HDD.

Press PLAY/STILL (▶||) button during playback. The following screen will appear and the system will pause temporarily. Use the RIGHT (▶) or LEFT (◀) button to view a frame at a time in forward or backward direction.



To play back again, press the PLAY/STILL (▶||) button.

Note

Menu screen will not be displayed even if the MENU button is pressed during playback. If the MENU button is pressed during playback, the following message will appear. To view the menu screen, the playback must be stopped.

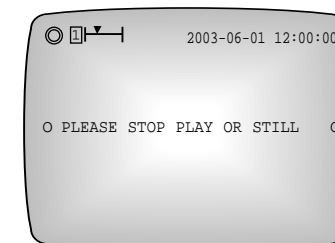

- Once you erase the hard disk drive, you will not be able to play newly recorded video until an event is created. At the initial playing after the erase, video can pause momentarily.

9 VCR Playback

Take following steps to play recorded videotape. Insert the videotape into deck. Turn VCR LED by pressing VCR button () once. Then press PLAY/STILL(▶||) button.

Note

- You can play video whether the system is in live screen mode or recording mode.
- Pressing the PLAY/STILL(▶||) button will not start playing while the menu is opened. First escape from the menu before playing video.

Press STOP (■) button to stop play. Press PLAY/STILL(▶||) button to pause and resume. Press SLOW button on lower are of remote controller or press SLOW button on top of the unit for slow play. Repeating SLOW- button on top of the unit will make the play even slower. Pressing SLOW+ button will gradually compensate it but still the play will slower than normal speed. Press PLAY/STILL(▶||) button to return to normal speed play.

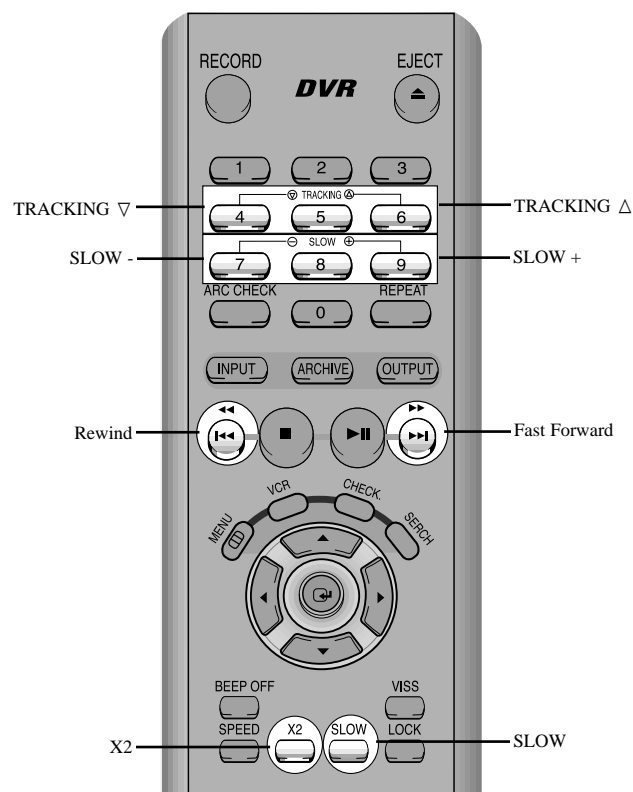

Press FF (RIGHT) (▶▶) button during play to fast-forward the video and easily find a desired scene. Hold on the FF (RIGHT) (◀◀) button to forward even faster. Sound will mute while forwarding. Pressing the FF (RIGHT) (▶▶) button while not playing will only fast-forward without playing it.

To rewind the video, press Rewind (LEFT) (◀◀) button just as the fast-forward function works.

Press double speed play button on the remote controller (X2) to fast forward in double speed. However, screen shaking or noise can occur in the double speed mode. Try to compensate it by pressing TRACKING (▲/▼) button on the remote controller.

Automatic noise control will be performed while playing the VCR. If automatic noise control is not functioning correctly, press TRACKING (▲/▼) button to control manually.

10 Searching the Backed-up Data (VISS)

The VISS function allows you to quickly and easily search the data backed up on to a video tape.

The VISS function can be operated from the remote control only.



In VCR mode, press the VISS button on the remote control, ◀▶ will appear on the screen.

Press the REW (◀◀) or FF (▶▶) button depending on the direction of your search. The closest data in either direction will be played back for 5 seconds along with the backup information. When you have found the data you want, press the PLAY/STILL (▶||) button. The search will stop and the data will be played back. To stop the VISS search, press the STOP (■) button.

Note

During a VISS search, the screen will be live.

11 Playing Back a Section Repeatedly

The REPEAT function allows you to repeatedly play back a certain section during DVR or VCR playback. The REPEAT function can be operated from the remote control only.



(1) DVR A-B Repeat Playback

During DVR playback, press the REPEAT button at the start point of the section you want to play back repeatedly. At this time, "REPEAT" blinks on the bottom left part.

Press the REPEAT button again at the end point of the section you want to play back repeatedly. The specified section will be played back 5 times. "REPEAT" will appear at the bottom left of the screen. To cancel the A-B Repeat, press the PLAY/STILL (▶||) button twice. Please note that A-B Repeat Playback will work only if the DVR's playback speed is set to normal, 1/5, or 1/2.

(2) VCR A-B Repeat Playback

During VCR playback, press the REPEAT button at the start point of the section you want to play back repeatedly. At this time, "◀▶" blinks on the upper left part.

Press the REPEAT button again at the end point of the section you want to play back repeatedly. The specified section will be played back 5 times. "◀▶" will appear at the top left of the screen. To cancel the A-B Repeat, press the PLAY/STILL (▶||) button twice. Please note that A-B Repeat Playback will work only if the DVR's playback speed is set to normal.



VIII. Others

1 Product Standards

Rated Voltage	NTSC (AC 110 ~ 240V, 60 Hz), PAL (AC 220V, 50Hz)
Power Consumption	34W
HDD	Removable HDD 80GB
BACKUP	VCR VIDEO TAPE
Video Input	Composite Video, BNC Jack - 1CH (1.0 Vp-p, 75Ω) S-VHS VIDEO
Video Output	Composite Video, BNC Jack - 1CH (1.0 Vp-p, 75Ω) S-VHS VIDEO
Audio Input	RCA Jack - 1 CH (-8 dBm, 600Ω)
Audio Output	RCA Jack - 1 CH (-6 dBm, 600Ω)
Video Compression Method	Motion JPEG
Audio Compression Method	G.723 (6.3 Kbps, 2.835 MB/h)
Video Resolution	720 x 240 [NTSC] 720 x 288 [PAL]
Picture Quality	Very High/High/Normal/Low
Recording Field Rate	60 ~ 0.50 Fields/sec [NTSC], 50 ~ 0.50 Fields/sec [PAL]
Alarm Record Time	10, 20, 30 sec, 1, 2, 3, 4, 5 min
Remote Control	RS232, RS485, LAN
Operation Temperature	0 °C ~ 40 °C
Storage Temperature	-20 °C ~ 60 °C
Operating Humidity	20% ~ 85% RH
Storage humidity	20% ~ 95% RH
Size	430(W) x 98(H) x 350.7(D) mm
Weight Approx.	6.2 Kg

2 Appearance Drawing

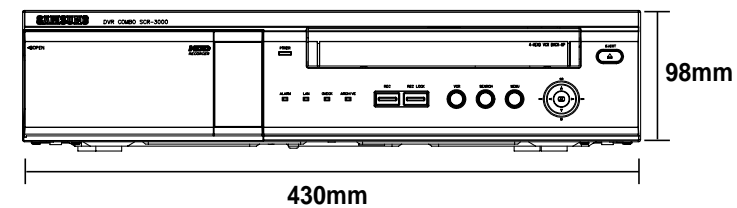
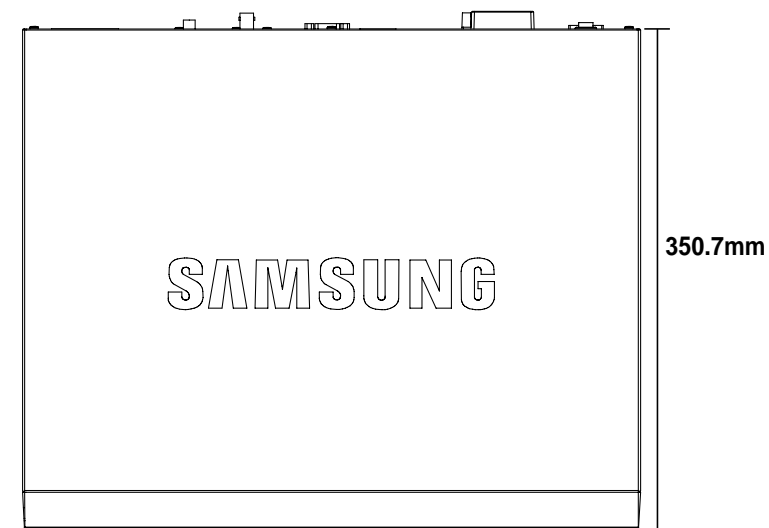
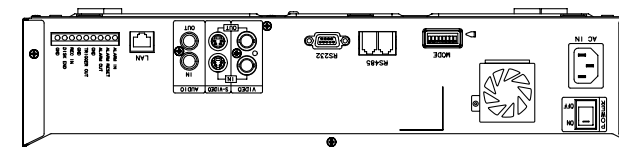





Appendix

1 Check Points before Call Service Center

If the system malfunctions, please check the following instruction before you call the service center or the shop where you bought the system.

Trouble	Check Points
<ul style="list-style-type: none"> • Unable to supply power. • The POWER LED in front of the system remains off and the system is not running 	<ul style="list-style-type: none"> – Check the power cable connection behind the system, power supply, and power switch.
<ul style="list-style-type: none"> • After power supply, the screen is all black. • After booting, the screen is all blue 	<ul style="list-style-type: none"> – Check the power cable connection of the system and monitor and power supply. – Check the connection between camera output port and system image signal input port and between monitor image signal input port and system image signal output port. – Check the camera output. – Check the BNC Cable connected to the system.
<ul style="list-style-type: none"> • After power supply, no further progress available after booting menu screen 	<ul style="list-style-type: none"> – Please call the service center or the shop where you bought the product for investigation or repair.
<ul style="list-style-type: none"> • No voice 	<ul style="list-style-type: none"> – Check the connection between microphone voice output port and system voice signal input port and between monitor voice signal input port and system voice signal output port. – Check the voice signal output. – Check the connected cable.
<ul style="list-style-type: none"> • Unable to record. • The RECORD button () can't activate recording. 	<ul style="list-style-type: none"> – Without input signal, the system can't perform recording. Please check if the camera output port is well connected. – As long as the free HDD space ratio remains 0% and the FULL indicating LED in front of the system remains on, the system will not start recording. – To start recording as it is like above, you should set the DISK END MODE in the RECORD MODE SETUP menu to OVERWRITE and press the RECORD / button(). – To start recording while the DISK END MODE is set to STOP, you should set the HDD ERASE in SYSTEM SETUP menu to ON and terminate the menu. Then, all the current data will be deleted. Now, you should press the RECORD button() to start recording. However, as the deleted data can not be recovered by all means, you should check again before deleting.

Trouble	Check Points
<ul style="list-style-type: none"> • Abnormal recording and playing after connected to the Multiplexer 	<ul style="list-style-type: none"> – Check the connection between Multiplexer image output port and system image signal input port and between Multiplexer image signal input port and system image signal output port. – Check the connection between system trigger output port(Trigger Out) and Multiplexer. – For the details of the Multiplexer, please refer to the Multiplexer User's Manual.
<ul style="list-style-type: none"> • No voice during play 	<ul style="list-style-type: none"> – If the AUDIO RECORD in the RECORD MODE SETUP menu is set to OFF, only images will be recorded. You should set it to ON to record both image and voice. – No voice will be supplied to the Still screen or Play mode at high or low speed.
<ul style="list-style-type: none"> • The screen trembles vertically during play. 	<ul style="list-style-type: none"> – Screen trembling often occurs during playing at high or low speed, which is a normal symptom.
<ul style="list-style-type: none"> • The LIVE screen is distorted. 	<ul style="list-style-type: none"> – Appropriate input signals need to be connected for each model. Connect NTSC signals to the SCR-3000N/SSC-Dual model and PAL signals to the SCR-3000P model, otherwise video output may be disrupted.
<ul style="list-style-type: none"> • The remote control does not work. 	<ul style="list-style-type: none"> – Make sure that the path between the remote control and the IR sensor is not obstructed. Also, check the angle of the remote control with respect to the IR sensor and the distance between the remote control and the IR sensor. – Make sure the remote control's batteries have sufficient power.

2

Q & A

Question	Answer
<ul style="list-style-type: none"> Does recording continue after power cut during recording. 	<ul style="list-style-type: none"> Without power supply, the system can't perform recording. But if the system was recording before power cut, it will resume recording upon power supply.
<ul style="list-style-type: none"> What would become of the system if disconnected with the input image signal during recording? 	<ul style="list-style-type: none"> Without connection with the input image signal, the system can't keep recording. But the system will resume recording upon the supply of normal input image signal.
<ul style="list-style-type: none"> What shall I do to stop recording manually while the system is detecting movements or in recording mode as set by the alarm. When system is in Reservation Recording state, how to stop the recording intentionally? 	<ul style="list-style-type: none"> Press the STOP button (■) for 3 seconds. Then, recording will be paused for 5 seconds and you shall enter the menu to change the recording setup in the meantime. If you want to stop the alarm recording, you shall set the ALARM SIGNAL DETECTION of the ALARM RECORD SETUP menu to OFF. If you want to stop the reserved recording, you shall set the TIMER of the TIMER RECORD SETUP menu to OFF. Without your action against the system for 5 seconds, the system will return to the previous mode.
<ul style="list-style-type: none"> May I use an identical IP Address for more than 2 systems? 	<ul style="list-style-type: none"> Yes, but as long as the 2 systems are not connected to LAN simultaneously. Connecting the system to LAN one by one is to be connected to the remote monitoring program by PC. If you want to connect the other system to LAN to be connected to the remote monitoring system by PC, you shall disconnect the system currently connected to LAN from the remote monitoring system by PC and connect the system to LAN. Then resume connection in at least one minute. Otherwise, you may not be connected.
<ul style="list-style-type: none"> What should I do if I have forgotten the system's password or ID/password for network access? 	<ul style="list-style-type: none"> Turn the hard drive rack's key to the OFF position and enter the MENU. Then, change the password.



www.securitysamsung.com