



DVD+VCR



DV1030

User's Guide



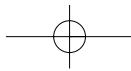

IMPORTANT SAFEGUARDS

PRODUCT INFORMATION

	CAUTION RISK OF ELECTRIC SHOCK DO NOT OPEN	
CAUTION: TO REDUCE THE RISK OF ELECTRIC SHOCK, DO NOT REMOVE COVER (OR BACK). NO USER-SERVICEABLE PARTS INSIDE. REFER SERVICING TO QUALIFIED SERVICE PERSONNEL.		



The lightning flash with arrowhead symbol, within an equilateral triangle, is intended to alert the user to the presence of uninsulated "dangerous voltage" within the product's enclosure that may be of sufficient magnitude to constitute a risk of electric shock.



The exclamation point within an equilateral triangle is intended to alert the user to the presence of important operating and servicing instructions in the literature accompanying the appliance.

WARNING	TO REDUCE THE RISK OF FIRE OR ELECTRIC SHOCK, DO NOT EXPOSE THIS APPLIANCE TO RAIN OR MOISTURE.
CAUTION	TO PREVENT ELECTRIC SHOCK, MATCH WIDE BLADE OF PLUG TO WIDE SLOT, FULLY INSERT.

IMPORTANT FOR LASER PRODUCTS	
LASER	This Digital Video Disc Player employs a Laser System. To ensure proper use of this product please read this owner's manual carefully and retain for future reference. Should the unit require maintenance, contact an authorized service location - see service procedure. Use of control adjustments or the performance of procedures other than those specified may result in hazardous radiation exposure. To prevent direct exposure to the laser beam, do not try to open the enclosure. Visible laser radiation when open and interlocks defeated. DO NOT STARE INTO THE BEAM.
DANGER	Visible laser radiation when open and interlock failed or defeated. Avoid direct exposure to beam.
CAUTION	Do not open the top cover. There are no user serviceable parts inside the Unit; leave all servicing to qualified service personnel.



FCC NOTICE: This equipment has been tested and found to comply with the limits for a Class B digital device, pursuant to part 15 of the FCC Rule. These limits are designed to provide reasonable protection against harmful interference in a residential installation. This equipment generates, uses and can radiate radio frequency energy and if not installed and used in accordance with the instructions, may cause harmful interference to radio communications. However, there is no guarantee that interference will not occur in a particular installation. If this equipment does cause harmful interference to radio or television reception; which can be determined by turning the equipment off and on, the user is encouraged to try to correct the interference by one or more of the following measures:

- Reorient or relocate the receiving antenna.
- Increase the separation between the equipment and receiver.
- Connect the equipment to an outlet on a circuit different from that to which the receiver is connected.
- Consult the dealer or an experience radio/TV technical for help.

This device complies with part 15 of the FCC Rules. Operation is subject to the following two conditions: (1) This device may not cause harmful interference, and (2) This device must accept any interference received, including interference that may cause undesired operation.

CAUTION	Any changes or modification in construction of this device which are not expressly approved by the party responsible for compliance could void the user's authority to operate the equipment.
----------------	---

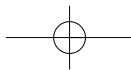

IMPORTANT SAFEGUARDS

This set has been designed and manufactured to assure personal safety. Improper use can result in electric shock or fire hazard. The safeguards incorporated in this unit will protect you if you observe the following procedures for installation, use and servicing. This unit is fully transistorized and does not contain any parts that can be repaired by the user.

1 Read Instructions

All the safety and operating instructions should be read before the unit is operated.

2 Retain Instructions

The safety and operating instructions should be retained for future reference.

3 Heed Warnings

All warnings on the unit and in the operating instructions should be adhered to.

4 Follow Instructions

All operating and use instructions should be followed.

5 Cleaning

Unplug this unit from the wall outlet before cleaning. Do not use liquid cleaners or aerosol cleaners. Use a damp cloth for cleaning.

6 Attachments

Do not use attachments unless recommended by the unit's manufacturer as they may cause hazards.

7 Water and Moisture

Do not use this unit near water- for example, near a bath tub, wash bowl, kitchen sink or laundry tub, in a wet basement, or near a swimming pool and the like. Caution : Maintain electrical safety. Powerline operated equipment or accessories connected to this unit should bear the UL listing mark or CSA certification mark on the accessory itself and should not be modified so as to defeat the safety features. This will help avoid any potential hazard from electrical shock or fire. If in doubt, contact qualified service personnel.

8 Accessories

Do not place this unit on an unstable cart, stand, tripod, bracket, or table. The unit may fall, causing serious injury to a child or adult as well as serious damage to the unit. Use this unit only with a cart, stand, tripod, bracket, or table recommended by the manufacturer.

- 8A** A unit and cart combination should be moved with care. Quick stops, excessive force, and uneven surfaces may cause the unit and

PORTABLE CART WARNING
(symbol provided by RETAC)



cart combination to overturn.

9 Ventilation

Slots and openings in the case are provided for ventilation to ensure reliable operation of the unit and to protect it from overheating. These openings must not be blocked or covered. These openings must not be blocked by placing the unit on a bed, sofa, rug, or other similar surface. This unit should never be placed near or over a radiator or heat radiator. This unit should not be placed in a built-in installation such as a bookcase or rack unless proper ventilation is provided or the manufacturer's instructions have been adhered to.

10 Power Sources

This unit should be operated only from the type of power source indicated on the marking label. If you are not sure of the type of power supply to your home, consult your dealer or local power company. For units intended to operate from battery power, or other sources, refer to the operating instructions.

11 Grounding or Polarization

This unit is equipped with a polarized alternating-current line plug (a plug having one blade wider than the other). This plug will fit into the power outlet only one way. This is a safety feature. If you are unable to insert the plug fully into the outlet, try reversing the plug. If the plug still fails to fit, contact your electrician to replace your obsolete outlet. To prevent electric shock, do not use this polarized plug with an extension cord, receptacle, or other outlet unless the blades can be fully inserted without blade exposure. If you need an extension cord, use a polarized cord.

12 Power-Cord Protection

Power-supply cords should be routed so that they are not likely to be walked on or pinched by items placed upon or against them, paying particular attention to cords at plugs, convenience receptacles, and the point where they exit from the unit.

Note to CATV system installer

This reminder is provided to call the CATV system installer's attention to Section 820-40 of the NEC which provides guidelines for proper grounding and, in particular, specifies that the cable ground shall be connected to the grounding system of the building, as close to the point of cable entry as practical.

13 Outdoor Antenna Grounding

If an outside antenna or cable system is connected to the product, be sure the antenna or cable system is grounded so as to provide some protection against voltage surges and built-up static charges. Section

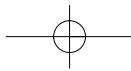

IMPORTANT SAFEGUARDS

PRODUCT INFORMATION

810 of the National Electrical Code, ANSI/NFPA No. 70-1984 (Section 54 of Canadian Electrical Code, Part 1) provides information with respect to proper grounding of the mast and supporting structure, grounding of the lead-in wire to an antenna-discharge unit, connection to grounding electrodes, and requirements for the grounding electrode. See example as shown.

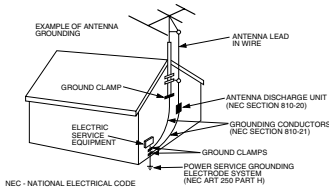

14 Power Lines

An outside antenna system should not be located in the vicinity of overhead power lines, other electric light or power circuits, or where it can fall into such power lines or circuits. When installing an outside antenna system, extreme care should be taken to keep from touching or approaching such power lines or circuits as contact with them might be fatal. Installing an outdoor antenna can be hazardous and should be left to a professional antenna installer.

15 Lightning

For added protection for this unit during a lightning storm, or when it is left unattended and unused for long periods of time, unplug it from the wall outlet and disconnect the antenna or cable system. This will prevent damage to the unit due to lightning and power line surges.

16 Disc Tray

Keep your fingers well clear of the disc as it is closing. It may cause serious personal injury.

17 Overloading

Do not overload wall outlets or extension cords as this can result in a risk of fire or electric shock.

18 Object and Liquid Entry

Never push objects of any kind into this unit through openings as they may touch dangerous voltage points or "short-out" parts that could result in a fire or electric shock. Never spill liquid of any kind on the unit.

19 Burden

Do not place a heavy object on or step on the product. The object may fall, causing serious personal injury and serious damage to the product.

20 Disc

Do not use a cracked, deformed or repaired disc. These discs are easily broken and may cause serious personal injury and product malfunction.

21 Servicing

Do not attempt to service this unit yourself as opening or removing covers may expose you to dangerous voltage or other hazards. Refer all servicing to qualified service personnel.

22 Damage Requiring Service

Unplug this unit from the wall outlet and refer servicing to qualified service personnel under the following conditions.

- A When the power-supply cord or plug is damaged.
- B If liquid has been spilled, or objects have fallen into the unit.
- C If the unit has been exposed to rain or water.
- D If the unit does not operate normally by following the operating instructions. Adjust only those controls that are covered by the operating instructions. Improper adjustment of other controls may result in damage and will often require extensive work by a qualified technician to restore the unit to its normal operation.
- E If the unit has been dropped or the cabinet has been damaged.
- F When the unit exhibits a distinct change in performance-this indicates a need for service.

23 Replacement Parts

When replacement parts are required, have the service technician verify that the replacements he uses have the same safety characteristics as the original parts. Use of replacements specified by the unit manufacturer can prevent fire, electric shock, or other hazards.

24 Safety Check

Upon completion of any service or repairs to this unit, ask the service technician to perform safety checks recommended by the manufacturer to determine that the unit is in safe operating condition.

25 Wall or Ceiling Mounting

The product should be mounted to a wall or ceiling only as recommended by the manufacturer.

26 Heat

The product should be situated away from heat sources such as radiators, heat registers, stoves, or other products (including amplifiers) that produce heat.

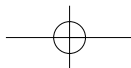

FEATURES...

- DVD, VCD, MP3 on CD-R/RW, and VHS playback
- Watch DVD and Record TV at the same time
- Multi-function remote control (VCR, DVD)
- Video Index Search System (VISS)
- Multi-channel Television Sound (MTS) playback/record
- High Quality 6-Head Hi-Fi Sound
- One Touch Recording (OTR)
- Progressive Scan
- MP3 playback
- Graphical On Screen Display (OSD)
- Screensaver function (DVD)
- 3D Sound (3D sound effect using 2 speakers)
- High bit / high sampling with 27MHz / 10bit video encoder
- High bit / high sampling with 96KHz / 24bit audio D/A converter
- Coaxial digital audio output (PCM, Dolby Digital, dts)
- Built-in Dolby Digital decoder (DVD)
- Analog audio 2-channel output for DOWNMIX (x1)
- Composite video out (x1)
- Slow Forward / Reverse (DVD) playback
- Fast Forward / Reverse playback
- DVD Title, Chapter and Time Search, and CD/VCD Track and Time Search
- Adjustable TV Aspect Ratio
- Repeat playback
- A-B Repeat (DVD)
- English, French and Spanish OSD
- Parental Lock (DVD)
- Multi Angle function (DVD)
This function allows you to choose the viewing angle of scenes which were shot from a number of different angles. (The number of angles available depends on the disc.)
- Zoom function (DVD/VCD)
- Auto Clock Set

READ CAREFULLY BEFORE USING

PRODUCT INFORMATION

Please read carefully before using this DVD player.

Placement and handling

- The picture and sound of a nearby TV, VCR, or radio may be distorted during playback. In this case, position the unit away from the TV, VCR, or radio, or turn off the unit after removing the disc.
- Do not use volatile liquids, such as insecticide spray, near the unit. Do not leave rubber or plastic products in contact with the unit for a long period of time. They will leave marks on the surface.

When Not in Use

- When the unit is not in use, be sure to remove the disc or tape and turn off the power.
- If you do not use the unit for a long period of time, remove the remote control batteries to prevent leakage.

Moving

- The original shipping carton and packing materials come in handy. For maximum protection, re-pack the unit as it was originally packaged at the factory.
- Remember to eject any videotape or disc.

Cleaning

- Use a soft, dry cloth. If the surfaces are extremely dirty, use a soft cloth lightly moistened with a mild detergent solution. Do not use strong solvents such as alcohol, benzene, or thinner, as these might damage the surface of the unit.

Maintenance

- This is a high precision video device. For optimal performance, we recommend regular inspection and maintenance every 1,000 hours by qualified service personnel. Contact your dealer or nearest service center.

Antenna Orientation

- Antennas are subject to changes in direction or damage due to wind and rain. For best results, contact your nearest service center about proper orientation and/or replacement.

Copyright

- It is forbidden by law to copy, broadcast, show, broadcast via cable, play in public, or rent copyrighted material without permission.

Tape and Disc Handling

- To prevent damage to the unit, do not use moldy, stained, scratched or otherwise damaged tapes or discs.
- Condensation may be present on your videotape. Allow the tape to dry completely before using it.
- After playing, store discs and tapes in their cases to prevent damage.
- Do not expose discs or tapes to high temperatures, humidity, mold, direct sunlight, dirt, dust or strong magnetic materials.

Using the Remote Control

- Operate remote control within 23 ft. (7m) of the unit.
- Do not press two buttons at the same time.
- Do not store in a dusty or humid location.

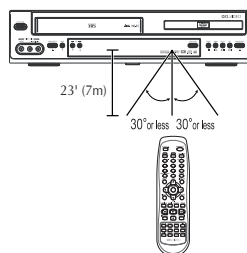

CONTENTS

1. PRODUCT INFORMATION

Important Safeguards	1
Features... ..	4
Read Carefully Before Using	5
Contents	6
Identification of Controls	7
Remote Control	10

5. DVD OPERATION

Playing a Desired Scene	35
Confirming Current Play Mode	39
Zoom, Multi Angle and 3D Audio	40
About MP3, JPEG discs	41
Displaying Disc Menus	44
Progressive Scan Mode	44

2. INSTALLATION

Connecting to a TV	12
Connecting a Cable Box	13
Connecting Other Video Equipment	14
Connecting to a Stereo Receiver	15
Connecting to a Dolby Digital decoder or DTS decoder.....	16

6. DVD FEATURE SETUP

DVD LANGUAGE Setup.....	45
VIDEO Setup	47
AUDIO Setup	48
Others Setup	49

3. BASIC OPERATION

Output Select	17
DVD Playback	18
VCR Playback	20
Clock Set	21

7. HELP

About DVD	51
About VCR and Videotape.....	53
Troubleshooting (DVD)	54
Troubleshooting (VCR).....	55
Specifications	57

4. VCR OPERATION

Memorizing TV Channels	22
Recording	24
Timer Recording	26
Watching and Recording Cable TV	29
Using Advanced VCR Features	30
Hi-Fi Stereo Playback	34

IDENTIFICATION OF CONTROLS

Front Panel

PRODUCT INFORMATION

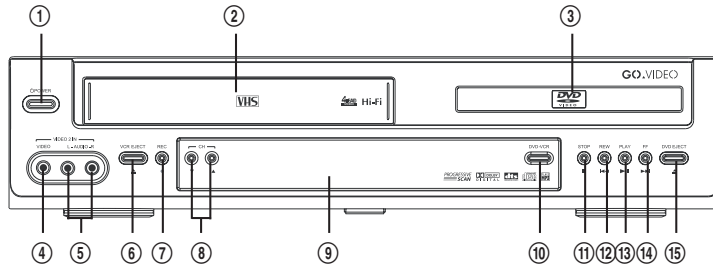

① **Power button**

Use to power the device on/off if AC power supply is connected.

② **Use to insert videotape**

③ **Disc tray**

④ **Video input jack**

⑤ **Audio input jacks**

⑥ **VCR Eject button**

⑦ **Record button**

⑧ **Channel DOWN/UP buttons**

⑨ **Operation Display Window**

Displays the status of device. For more information, see "Operation Display Window" on the next page.

⑩ **DVD/VCR button**

Use to change DVD mode to VCR mode, and vice versa.

⑪ **Stop button**

Use to stop playing.

⑫ **Rewind button**

Use to rewind videotape or skip to the previous chapter of a disc.

⑬ **PLAY/PAUSE button**

Use to start and pause playback of videotape or disc.

⑭ **Fast Forward button**

Use to fast forward videotape or skip to the next chapter of a disc.

⑮ **DVD Eject button**

IDENTIFICATION OF CONTROLS

Operation Display Window



- RECORDING MODE -

- Timer Recording on Standby
- Timer Recording Error
- Recording in Progress
- Timer Recording in Progress
- Recording Pause

- REPEAT MODE -

- Repeat one chapter
- Repeat all chapters
- Repeat a defined period from A
- Repeat a defined period from A to B

- DVD OPERATION -

- DVD playback
- Fast playback
- Fast reverse playback
- Slow playback
- Still picture
- Progressive Scan mode
- Interlaced Scan mode

- VCR OPERATION -

- VCR playback
- Fast forward
- Rewinding
- Fast playback (CUE)
- Fast reverse playback (REVIEW)
- Slow playback
- Still picture
- Stop
- Child Lock

IDENTIFICATION OF CONTROLS



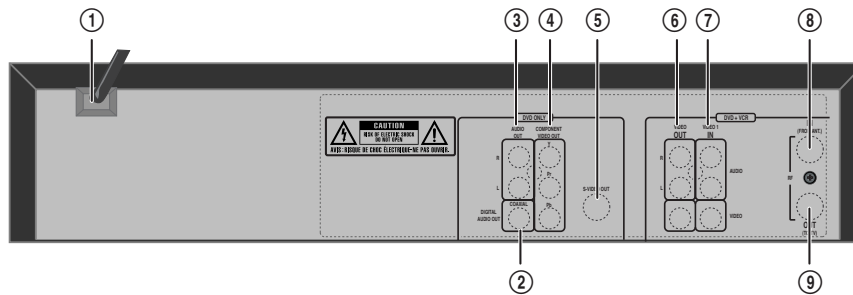

PRODUCT INFORMATION

Rear Panel



- | | |
|--|--------------------------------------|
| ① Power Cord
Connect to wall outlet. | ⑤ S-Video Output Jack |
| ② Digital Output (COAXIAL) Jack
Connect to digital receiver/ amplifier or digital audio decoder. | ⑥ A/V Output Jack |
| ③ AUDIO Out Jack | ⑦ A/V Input Jack |
| ④ COMPONENT Video Out Jack
For best picture quality, connect the unit to TV or monitor with COMPONENT(480i) input. | ⑧ Connection to Antenna/Cable |
| | ⑨ Connection to TV |

Accessories

Remote Control 	2 Batteries 	RF Cable 	Audio/Video Cable 	Owner's Manual/ Warranty 
---	--	---	--	---

- To purchase accessories or additional parts, contact your nearest dealer or service center.

REMOTE CONTROL

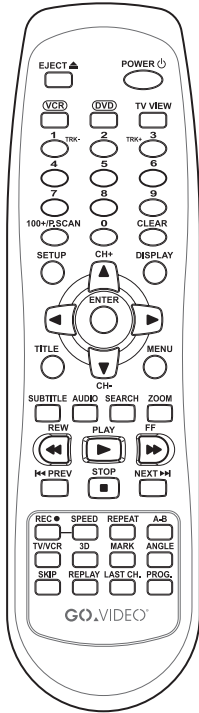



-  Switches the DVD+VCR on or off.

-  [DVD] Opens/closes the disc tray, [VCR] Ejects a tape

-  Changes to VCR mode.

-  Changes to DVD mode.

-  Selects the devices connected to the Audio/Video sockets (AV1, AV2, DVD, VCR).

-  [VCR] Manually reduces of streaks or picture "jitter".

-  Number entry

-  [DVD] Activates Progressive Scan button, [VCR] Number 100 button

-  Navigate through the menus., [VCR] Channel Up/Down button

-  Confirms a menu selection.

-  [DVD] Removes any menu or display from the screen.
[VCR] Resets the time counter to 0:00:00. Also clears on-screen menu item entries when setting the time and date or timer recordings.

-  [DVD, VCR] Shows the status displays.

-  [DVD, VCR] Displays or exits the SETUP menu.

-  [DVD] Displays the title menu when playing a DVD. Activates PBC mode when playing a VCD.

-  [DVD] Accesses the disc menu during play (if there is one).

-  [DVD] Selects a desired language for the subtitle.

-  [VCR] Selects a desired audio

-  [DVD] Activates Chapter/Title/Time SEARCH

-  [DVD] Activates the Zoom function

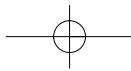

REMOTE CONTROL

PRODUCT INFORMATION

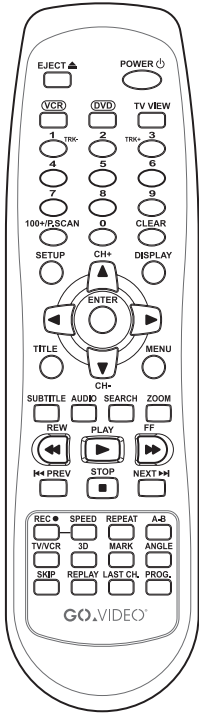

	Starts playing a disc or a tape. Pauses playback or recording modes.
	Starts fast reverse, reverses accelerated play or reverses slow motion
	Starts fast forward, forward accelerated play or forward slow motion
	Stops play, accelerated search, slow motion or recording.
	[DVD] Skips back to previous chapter or track in playback mode
	[DVD] Skips forward to next chapter or track in playback mode, advances one frame in pause mode [VCR] Advances one frame in pause mode
	[VCR] Starts record mode on tapes with the safety tab intact. Press this repeatedly to set a recording duration for OTR.
	[VCR] Overrides the default recording speed (either SP or SLP).
	[DVD] Repeats a Title, Chapter, Disc, One, Directory or Random playback.
	[DVD] Allows selection of a section and will play it repeatedly.
	[DVD, VCR] Switches between TV and VCR
	[DVD] Selects virtual 3D sound effect between VSR (Virtual Surround mode) and EST (Enhanced Stereo mode)
	[DVD] Stores bookmarks in memory to be viewed (listened to) again
	[DVD] Accesses multiple camera angles if any were added to the disc when it was created.
	[VCR] Commercial Skip skips forward 30 seconds
	[VCR] Replays previous 15 seconds
	[VCR] Go to Last Channel button
	[VCR] TIMER RECORDING button, [DVD] PROGRAM Playback button

Child Lock!!!

Press the [POWER] button on the remote control for about 8 seconds. All front panel and remote control buttons are now locked, and the Lock indicator ("SAFE") will be displayed on window display. To release child lock, press the [POWER] button again for about 8 seconds.

CONNECTING TO A TV

- The default RF Output channel is CH3. If Channel 3 is used by a TV station, you must change it to Channel 4. See "To Set Output Channel" on page 23.

Various methods of connecting your TV

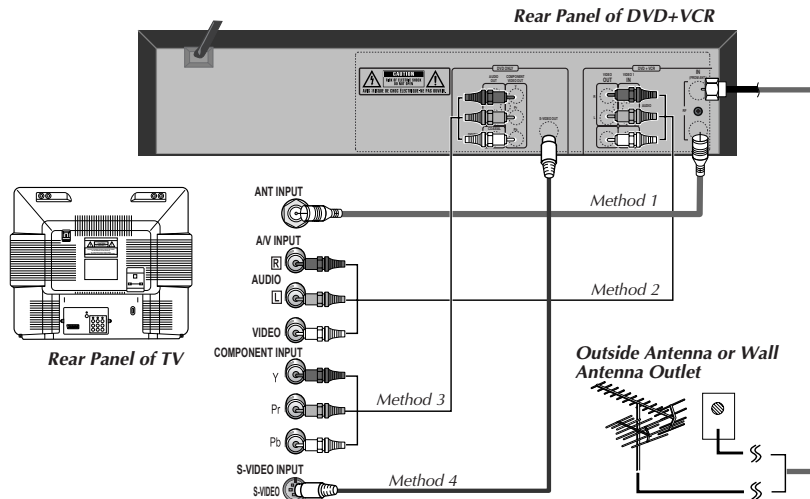

Method 1

Unplug the RF cable from the "ANT.IN" Jack on the rear panel of the TV. Plug this cable into the "ANT.IN" jack on the rear panel of the DVD+VCR. Connect the "RF OUT" jack on the DVD+VCR to the "ANT.IN" jack on the TV with another RF cable.

If your cable system provides all your channels, connect an RF Cable from the OUT jack of the Cable Box to the "IN From Antenna" jack on the DVD+VCR unit.

Method 2 : Connecting to a TV equipped with audio/video in jacks

Use the supplied audio/video cable to connect the **Video Out** jack on the DVD+VCR to the **Video In** jack on your TV. Connect the **Audio Out** jack on the DVD+VCR to the **Audio In** jack on the TV. Match the color of the cable to the color of the jack.

Method 3 : Connecting to a TV equipped with component video in jacks

Connect component video cables (not supplied) from the Component Video Out jacks on the DVD+VCR to the Component Video In jacks on the TV. If you do not receive a clear picture using the Component Video Pr, Pb, Y jacks, try connecting to the Cr, Cb, Y jacks instead. The component video connection only works in DVD playback mode.

To use the VCR or view TV channels, you still need to connect the RF cable or the audio/video cables.

Method 4 : Connecting to a TV equipped with S-Video in jacks

Connect an S-Video cable (not supplied) between the S-Video Out jack on the DVD+VCR to the S-Video In jack on the TV. The S-Video connection only works in DVD playback mode. To use the VCR or view TV channels, you still need to connect the RF cable or the audio/video cables.

 • VHF: TV channels 2~13, UHF: TV channels 14~69, CATV: Cable TV

CONNECTING A CABLE BOX

How to connect

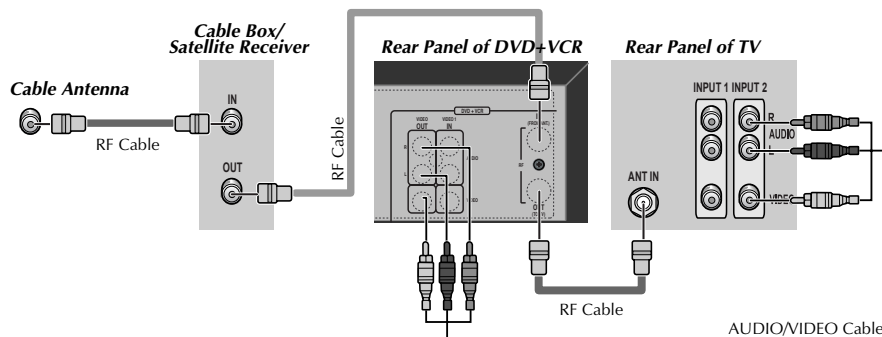

INSTALLATION

- 1 Connect the RF cable from the cable wall outlet to the RF In jack on your Cable Box.
- 2 Connect a second RF cable from the RF Out jack on the Cable Box to the IN (FROM ANT.) jack on the back panel of the DVD+VCR.
- 3 Connect the supplied RF cable from the OUT (TO TV) jack on the back panel of the DVD+VCR to your television's Antenna In jack. Or for improved picture and sound quality, connect an audio/video cable from the Audio/Video Out jacks on the DVD+VCR to the Audio/Video In jacks on your TV.
- 4 Connect the DVD+VCR power cord to a standard wall outlet.
- 5 Power on the DVD+VCR, TV, and Cable Box.
- 6 If you are using the RF connection, set your TV to Channel 3 or 4 to view the DVD+VCR. If you are using the Audio/Video connection, set your TV to its line input to view the DVD+VCR.

How to watch regular TV and record Cable TV

- 1 Set the Channel Select switch on your cable Box to CH 3. If Channel 3 is used by a local TV station, you must change it to Channel 4.
- 2 Select the channel to be recorded on the Cable Box.
- 3 Press the [REC] button on the DVD+VCR.
- 4 To watch regular TV while you record from cable, press the [TV/VCR] button on the DVD+VCR and select the desired channel on your TV. Because of the nature of cable boxes, you cannot watch one Cable TV channel and record another at the same time.

CONNECTING OTHER VIDEO EQUIPMENT

- You can connect a wide variety of audio/video equipment to your DVD+VCR, including an additional VCR, Laser Disc Player, DVD Player, Camcorder, Satellite Receiver, or Video Game. Because these devices use all of connections, they are described together.

How to Connect

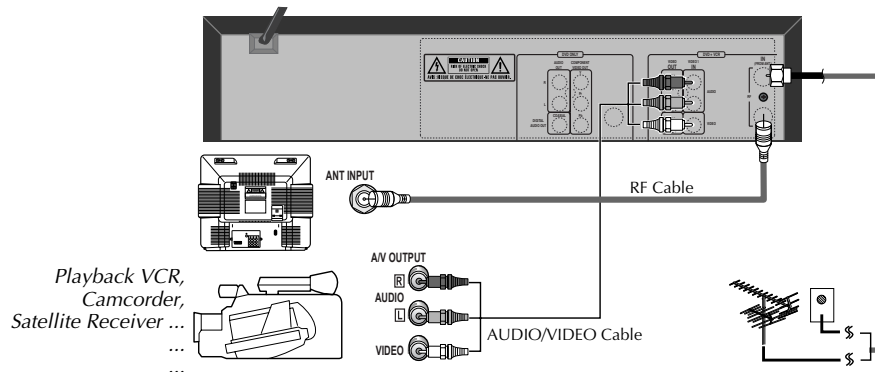

- 1 Connect audio/video cables from the **Audio/Video Out** jack on your other video equipment to the **Audio/Video In** jack on rear panel (or front panel) of DVD+VCR.
- 2 Connect an RF cable from the "ANT. IN" jack on a TV or satellite receiver to the "RF.OUT" jack on the DVD+VCR.
- 3 To record other video equipment with the DVD+VCR, insert a tape with the record safety tab intact into DVD+VCR and follow the instructions for recording on page 24.

How to Copy (Edit) Tape with Other Video Equipment

- 1 Turn on the DVD+VCR.
 - 2 Press [TV VIEW] and set the DVD+VCR to display "Video 1" or "Video 2" on TV screen.
 - 3 Press [PLAY] on the other video equipment.
 - 4 Press [REC] on the DVD+VCR when you want to record from the other video equipment.
 - 5 Press [Pause] on the DVD+VCR to prevent recording a scene you do not want.
- (Caution) Recording is stopped automatically after 5 minutes in Pause mode. Press the [REC] button again if you want to resume recording.**

CONNECTING TO A STEREO RECEIVER

How to Connect

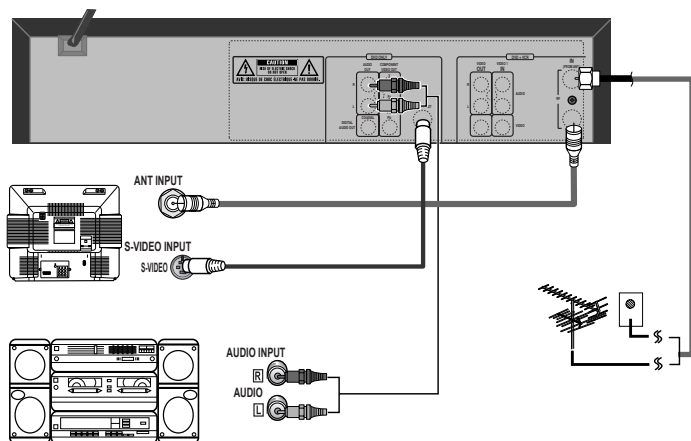

INSTALLATION

- 1 Connect audio/video cables from the **AUDIO OUT** jack on the rear panel of the DVD+VCR to the **In** jack of the stereo receiver.
- 2 On the stereo's control panel, select the "External Input" that you connected to the DVD+VCR.
- 3 Turn on the stereo receiver and start playback of a DVD disc or Hi-Fi videotape. You should hear sound from the speakers connected to your stereo receiver.

CONNECTING TO A DOLBY DIGITAL DECODER OR DTS DECODER

How to Connect

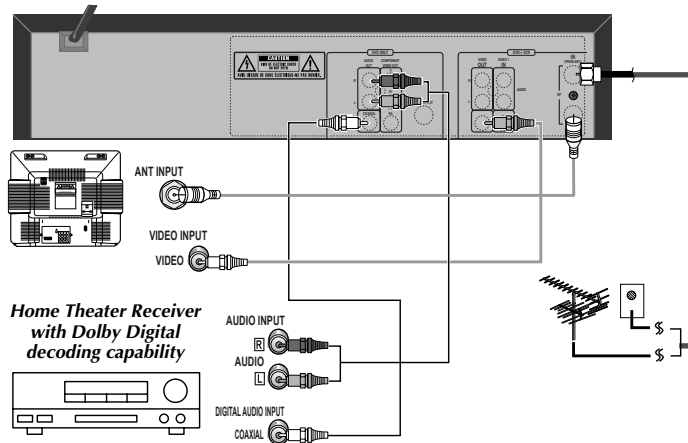

If you are playing a DVD disc that has a soundtrack in 5.1 channel Dolby Digital Surround, or DTS surround formats, the DVD+VCR outputs a Dolby Digital or DTS data stream from its COAXIAL DIGITAL AUDIO OUT jack. By hooking the DVD+VCR up to a Dolby Digital or DTS decoder, you can enjoy high-quality surround sound.

- 1** Connect a coaxial digital audio cable (not included) from the DIGITAL AUDIO OUT jack on the DVD+VCR to the Digital Audio In jack on the decoder.
- 2** Connect the TV as explained on page 12, for playback and recording of videotapes.

 Not all DVD discs have these soundtrack formats.

Manufactured under license from Dolby Laboratories.
 "Dolby" and the double-D symbol are trademarks of Dolby Laboratories.

OUTPUT SELECT

To Select DVD

Press the [DVD] button.

"DVD" lights on the operation display window and all remote control buttons control the DVD player.

To Select VCR

Press the [VCR] button.

"VCR" lights on the operation display window and all remote control buttons control the VCR.

To Watch TV or External Input

Press the [TV VIEW] button.

The unit will cycle through DVD PLAYBACK → BROADCASTING RECEPTION → EXTERNAL INPUT (Video 1, Video 2). If the status of VCR is PLAYBACK (or RECORDING) MODE, the unit will cycle through VCR PLAYBACK. (or RECORDING) → DVD.

Stop when you see the viewing mode you want.

INSTALLATION

BASIC OPERATION

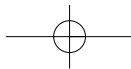

DVD PLAYBACK

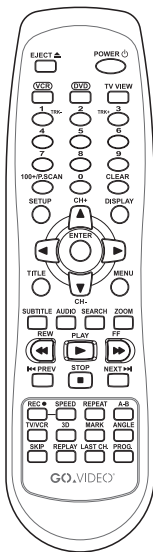

- If you do not close the tray, it will be closed automatically in 5 minutes to protect it from damage.
- Some CD-R, CD-RW (MP3, AUDIO CD) may not play due to disparities in producing medium (PC, CD-Recorder), media type, and/or disc format.

1 Press [POWER] to turn on the unit.
Press [DVD] to select DVD mode.

2 Press [EJECT] to open the disc tray.

3 Place your disc in the center of the disc tray, with the label facing upward.

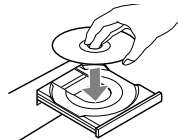

4 Press [EJECT] to close the tray.
The disc tray is closed and many discs will start playback automatically.

5 To start playback, press [PLAY].

- **In the case of DVD,**
DVD menus and titles are often displayed on screen.
- **In the case of S-VCD and VCD2.0:**
The disc menus are displayed on screen and are converted into PBC (Playback Back Control) mode.
- **In the case of CD, VCD1.1 and MP3:**
The disc plays in order of its track numbers.

6 To stop playback, press [PAUSE].
To pause, press [PLAY] during playback.
Press [PLAY] again to resume playback.

7 Press [EJECT] to open the disc tray.

8 Remove the disc, and press [EJECT] to close the tray.

Various Playback Methods

- **For fast (or reverse) playback,** press [▶▶] (or [◀◀]) in Playback mode.
* Unavailable during MP3 playback and with certain DVDs.
- **For slow (or reverse) playback,** press [▶▶] (or [◀◀]) in Pause mode.
* Not available during VCD playback. The mark will appear.
- **For still picture,** press [PLAY] in Playback mode.

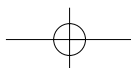

DVD PLAYBACK**Selecting an audio language**

- You may select an audio language if a disc includes multiple languages.



Certain discs may not support audio selection.

Keep pressing [AUDIO] until your preferred language appears in playback mode.

If the DVD disc includes audio information, every time you press [AUDIO], English (ENG), French (FRE), Spanish (SPA), etc. appear one by one.

**Selecting a subtitle language**

- You may select an subtitle language if a disc includes multiple languages.



Certain discs may not support subtitle selection.

Keep pressing [SUBTITLE] until your preferred language appears in playback mode.

If the DVD disc includes subtitle information, every time you press [SUBTITLE], English (ENG), French (FRE), Spanish (SPA), ... and OFF appear one by one.



BASIC OPERATION

Things to know before DVD playback**Which discs you can use**

DVD Video (Digital Versatile Disc)
 DVD-R (DVD-Recordable)
 DVD-RW (DVD-Rewritable)
 Audio CD (Compact Disc Digital Audio)
 Video CD (format 1.0/1.1./2.0)
 Super Video CD
 CD-R (CD recordable) Audio/ MP3 contents
 CD-RW (CD rewritable) Audio/ MP3 contents

**Regional code**

If the region number described on the DVD disc does not correspond to the Region number of this player, the player will not play this disc.



For more detailed information, go to "ABOUT DVD" page in "HELP" chapter .

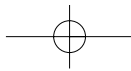

VCR PLAYBACK

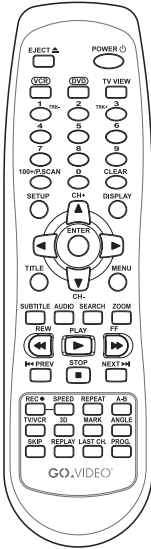

1 Press [POWER] to turn on the DVD/VCR.
Press [VCR] to select VCR mode.

2 Insert the desired tape.

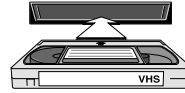

3 To start playback, press [PLAY].
If the picture is flickering or poor quality, adjust it with the [TRK +/-] buttons.

4 To stop playback, press [PAUSE].
To pause playback, press [PLAY].
Press [PLAY] again to resume playback.

5 Press [VCR EJECT] on the unit or [EJECT] on the remote control to eject the tape.

.....

Various Playback Methods

- For fast forward (or reverse) playback, press [FF] (or [RR]) in Playback mode.
- For slow-motion playback, pause the playback, then press [SLOW].
** NOTE: The VCR does not have Slow Reverse Playback.*
- For Frame Advance, pause the playback, then press [FF]. Each time you press this button, the picture advances one frame.
- For Still picture, press [PLAY] in Playback mode.

.....

To Adjust Display

This product includes automatic Tracking so you can enjoy a clear picture without additional operation. However:

- If the screen is poor in Playback mode,
- If noises occur in the upper or lower part of the screen in slow playback mode,
- If paused picture vibrates up and down.

Then try using the [TRK +/-] buttons to adjust the display manually.

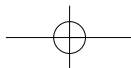

CLOCK SET

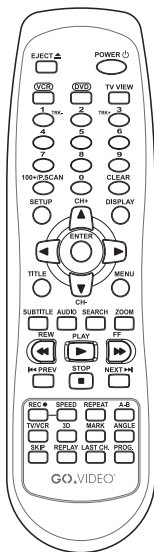

1 Set the TV to CH 3 (or 4).

2 Press [VCR] on the remote control to select VCR mode .

3 Press [SETUP].
Press [ENTER] to select "CLOCK SET".
"Time and Date Set" is already selected.
Press [ENTER] to set the time and date.

4 Set the current date and time by pressing [◀▶▲▼] keys or pressing the [0-9] keys.

For TIME SET, follow the order of Hour / Minute ; for DATE SET, follow the order of Month / Day / Year.

If the input box blinks rapidly, you have entered an invalid number. Enter a zero as the first number for hours or months between 1 and 9.

5 When CLOCK SET is complete, press [SETUP] twice to return to the main Setup menu or three times to return to VCR mode.

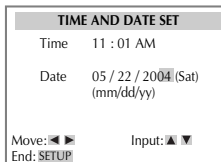
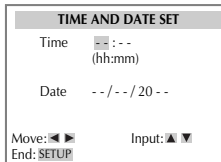
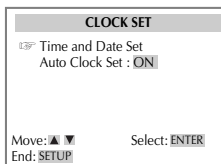
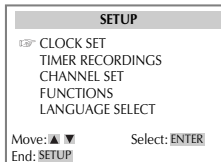

BASIC OPERATION

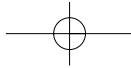

MEMORIZING TV CHANNELS

To Automatically Memorize Channels

■ Memorizing channels allows you to use the [CH+/-] button without seeing empty channels. You can manually delete channels you do not want to watch.

1 Press [VCR], then press [SETUP].
 Press [▼(CH-)] to move the  to "CHANNEL SET", and then press [ENTER].

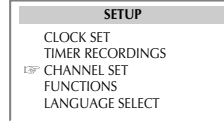

2 Select "Auto Channel Search".
 Press [ENTER] to select "AUTO CHANNEL SEARCH".

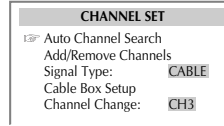

Select "Detect Automatically".
 Press [ENTER] to detect the channel automatically.

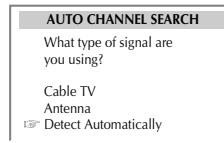

The DVD+VCR searches for all available channels. When this process is complete, the lowest channel found is displayed.

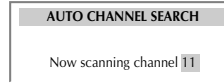

3 Check memorized channels.
 To check the memorized channels, press [CH+/-] on the remote control.

To Memorize Channels Manually

■ To add channels manually:

1 Press [VCR], then press [SETUP] and select "CHANNEL SET".
 Select "Add/Remove Channels".

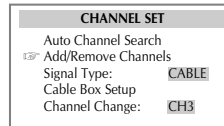

2 Select the desired channel and memorize it.
 Use the [0-9] buttons to select the desired channel.
 When [▶] is pressed, "REMOVED" under the channel number changes to "ADDED".

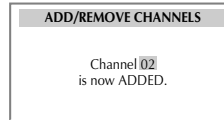

3 Check the memorized channel.
 To check the memorized channel, press [CH+/-] on the remote control.

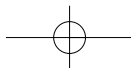

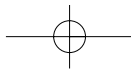

MEMORIZING TV CHANNELS

To Delete Channels Manually

- To delete memorized channels:

- Press [VCR], then press [SETUP] and select "CHANNEL SET". Select "Add/Remove Channels".
- Select the desired channel and delete it.
Use the [0-9] buttons to select the desired channel to delete.
When [◀] is pressed, "ADDED" under the channel number changes to "REMOVED".
- To check the deleted channel, press [CH+/-] on the remote control.



Selecting cable or antenna viewing

- This feature is useful if your cable signal goes out because it allows you to switch to a regular antenna for alternate television reception.

To set the signal type:

Press [ENTER] to toggle the setting between CABLE and ANTENNA in the CHANNEL SET screen.
When the desired signal type is displayed, press [SETUP] twice to exit.

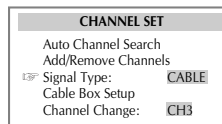

VCR OPERATION

To Set Cable Box

- This feature is useful if your cable signal goes out. It allows you to switch to a regular antenna for alternate television reception.

- Press [VCR], then press [SETUP] and select "CHANNEL SET". Select "Cable Box Setup".
- Select "Cable Box Channel".
Enter the channel number which matches to the output of the Cable Box.

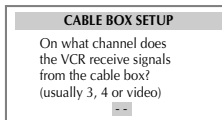
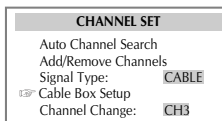

To Set Output Channel

- Use this option to change the VCR's output channel. The default is channel 3.

Press [VCR], then press [SETUP] and select "CHANNEL SET". Select "Channel Change" (or "RF Output").

Press [ENTER] to set the RF Output channel to CH3 or CH4.

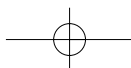
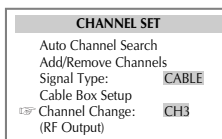

RECORDING



To Record With VCR

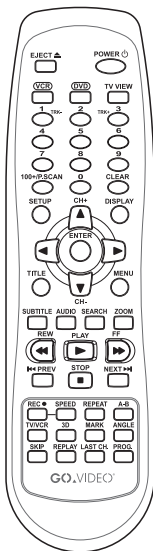

- 1 Press [POWER] to turn on the DVD/VCR.**

 - Press [VCR] to select VCR mode.
 - Turn on the TV and select Ch 3, or press [INPUT] on your TV to select External Input mode.
- 2 Insert a recordable tape.**
Insert a tape with recording tab.

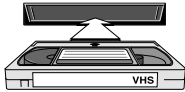
- 3 With [CH+/-], [0-9] and [TV VIEW] buttons, select the desired channel or external input to record.**
- 4 Select the desired speed (SP or SLP) with the [SPEED] button.**
- 5 Press the [REC] button.**
The unit starts recording.
- 6 If you want to pause recording, press [PLAY].**
After pressing [PLAY], if the unit is left in Pause mode for five minutes, the recording is stopped automatically.
- 7 To exit recording, press [STOP].**

To Watch Another TV Channel or DVD while recording

- 1 If you want to watch another TV channel during recording, press [TV/VCR].**
Select the desired channel by using the TV's remote control or channel buttons. If you use the DVD/VCR buttons to change channels, you will record the channel you are watching.
- 2 If you want to playback a DVD during recording, insert a DVD disc.**
Place the desired DVD disc on DVD tray, press [DVD] to change OUTPUT to DVD mode and press [PLAY].

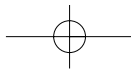

RECORDING

To Record From DVD To Videotape during DVD playback

1 Press [DVD] to select DVD mode.

Insert the desired DVD disc.

You cannot record copy-protected DVD discs.

Insert a recordable tape into the VCR.

2 Press [PLAY] to start the DVD playback and press [REC] to start the VCR recording.

3 To exit record, press [■].

Recording stops automatically when recorded tape reaches the end.

Video recorded in PROGRESSIVE SCAN mode will playback abnormally. First change PROGRESSIVE to INTERLACED mode in the SCAN MODE screen, then record from DVD to videotape. (refer to pages 44, 47)

This product incorporates copyright protection technology that is protected by U.S. patents and other intellectual property rights. Use of this copyright protection technology must be authorized by Macrovision, and is intended for home and other limited viewing uses only unless otherwise authorized by Macrovision. Reverse engineering or disassembly is prohibited.

VCR OPERATION

One Touch Recording (OTR)

■ To record the current TV program at the touch of a button, follow the procedures below.

1 First, follow steps 1 to 4 under "To Record With VCR" on page 24.

2 Press [REC] repeatedly to set the desired recording time:

Once continuous recording until you press [STOP]

Twice record for 30 mins from current time

3 (times) record for 1 hour

.....

.....

10 record for 5 hours

11 record for 6 hours

12 record for 7 hours

13 record for 8 hours

14 record for 9 hours

15 Return to normal (continuous) recording

3 To stop Recording, press [STOP].



• If the program is running overtime, pressing [REC] will extend the recording time 1/2 hour.

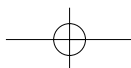

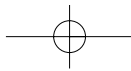

TIMER RECORDING



Timer Recording

- 1 Turn on the TV.
- 2 Make sure the current time is set correctly (see page 21 for instructions on setting the clock).

- 3 Insert a recordable tape with recording tab.

- 4 Press [VCR] to select VCR mode.

- 5 Press [SETUP] and select "TIMER RECORDINGS".
Move to "TIMER RECORDINGS" with [▼] and press [ENTER].

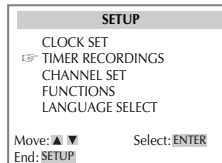

- 6 Select "Make a New Program".
Press [ENTER] to select "Make a New Program".

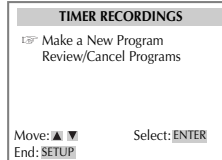

- 7 Set How Often to Record.
Move to desired recording type with [▼] and press [ENTER].
For details, see "Types of Timer Recordings" on page 28.

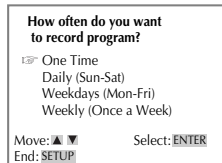

- 8 Select a Show to Record.
Select the desired channel with [0-9].
**If Converter Box and DVD+VCR are connected with an audio/video cable, select "EXTERNAL INPUT" as the TIMER REC CH with the [TV VIEW] button.

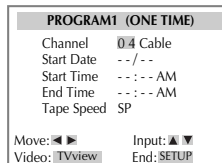

When moves to "Cable", select either "Cable" or "Antenna" with [▼] or [▲].

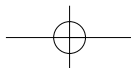

TIMER RECORDING

9 Set Date and Time to Record.
 Select the date, start time and end time to record using [0-9].

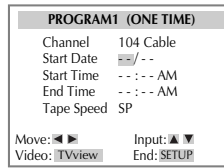

10 Set "Tape Speed".
 Select either SP, SLP or AUTO with [▼] or [▲].
 For more information on recording speed, see "Using video cassette" on page 28.

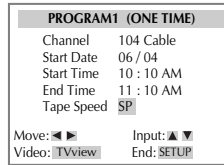

i If the unit is not ready (e.g., a recordable tape is not inserted, the tape is currently playing or the unit is powered off), an error message will appear on screen.

11 Press [SETUP] to complete the Timer Recording.
 "Program # has been saved. For program recording, insert a cassette...." message is displayed.
 TIMER RECORDING indicator,  is displayed on the operation display window.
 At the scheduled time, the Timer Recording will begin.

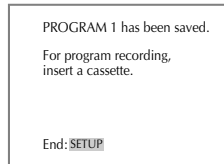
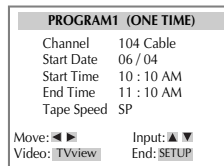

VCR OPERATION

To Confirm or Cancel TIMER RECORDINGS

1 Repeat steps 1-5 of "Timer Recording".
 Select "Review/Cancel Programs".

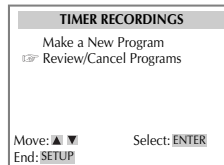

2 Confirm Timer Recording details with [▼] and press [CLEAR] to delete specific details.

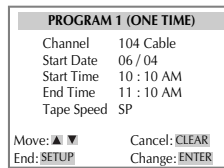

Timer Program Setting

Press [PROG.] in VCR mode.

This is a shortcut to view the Timer Recording menu.

Before setting a Timer Recording, the clock should be set correctly and VCR mode should be selected.

Types of Timer Recordings

One Time: A single Timer Recording on a specific date and time.

Daily : A Timer Recording that will record at the same time every day.

Weekday : A Timer Recording that will record at the same time Monday through Friday.

Weekly : A Timer Recording that will record once a week on the selected day and time.

Using Video Cassettes

Before you play or record on a video cassette tape, please read this information on the proper care and use of video cassettes.

Use only video cassettes that bear the VHS mark: .

There are four types of video cassettes: T-60, T-90, T-120, and T-160. The amount you can record on a tape is dependent upon the tape speed at which you record. The table below lists the recording time (hours:minutes) for each tape type according to recording speed.

Tape Type	SP Mode (Standard Play)	SLP Mode (Extended Play)
T-60	1:00	3:00
T-90	1:30	4:30
T-120	2:00	6:00
T-160	2:40	8:00

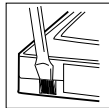

Protecting video cassettes from accidental erasure

Cassettes have a safety tab to prevent erasure. Break off the safety tab with a screw driver. If you wish to record on a cassette without a safety tab, cover the hole with cellophane tape. If you insert a video cassette without a safety tab into the unit after setting the timer recording program, "(E)" will blink on the display panel in the power off mode and the unit will automatically eject the cassette.

If you insert a video cassette with a safety tab into the unit after setting the timer recording program, the unit will be in stand-by mode.

Inserting video cassettes

Firmly insert the cassette into the cassette compartment with the label up. An inverted cassette cannot be inserted. Do not attempt to insert a video cassette if the unit is unplugged. Do not insert fingers or any foreign object beyond the door flaps of the cassette compartment; this could lead to injury or equipment damage.

Removing video cassettes

Press [VCR EJECT] on the front panel and the VCR will eject the tape. Pull the cassette out gently. Do not attempt to pull out the video cassette after the unit begins to load the video cassette. Let it finish loading, then press [EJECT] to eject it.



- Audio-visual material may include works of copyright which must not be recorded without authorization of the copyright owner.

WATCHING AND RECORDING CABLE TV

- Because of the nature of converter boxes, you cannot watch one Cable TV channel and record another at the same time.

To Watch and Record Cable TV

- 1 Turn on the cable box** and then set a channel to watch or to record.
Turn on the DVD+VCR and then set the DVD+VCR channel connected to the converter (CH03/04/EXTERNAL INPUT).
Power on TV and then set the channel connected to the DVD+VCR (CH03/04/VCR).

- 2 Recording while Watching**
With the setup described above, the channel selected by the converter is displayed on screen. Press [REC] on the DVD+VCR to record the channel selected by the converter, or press [REC] repeatedly to set One Touch Recording (OTR) (see page 25).

TIMER RECORDINGS from Cable TV

- 1 Program VCR.**
Follow the instructions on page 26 for setting a Timer Recording. Set the DVD+VCR to the channel input from the converter box (CH3, CH4 or EXTERNAL INPUT). Enter date and time of the cable program in the Timer Recording menu.
- 2 Set Channel on Converter Box.**
Set converter to the cable TV channel you wish to record.
for example to record CH48,
Display CH48 with CONVERTER CHANNEL SELECT button.
- 3 Complete Timer Recording.**
If you leave the cable box turned on, the DVD+VCR powers on automatically and starts recording at the programmed time.

VCR OPERATION

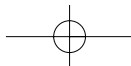

USING ADVANCED VCR FEATURES

Auto Playback

- With Auto Play turned on (the factory default setting), the DVD+VCR player automatically starts playback when you insert a tape with its safety tab removed.

- 1 Press [SETUP] and select "FUNCTIONS".**
Move  to "FUNCTIONS" with [▼] and press [ENTER].

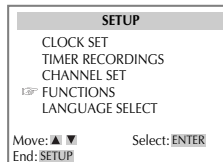

- 2 Press [ENTER] to switch between ON and OFF.**
 - Select ON if you want a tape with its safety tab removed to start playing automatically when the tape is inserted.
 - Select OFF if you do not want a tape with its safety tab removed to start playing automatically.

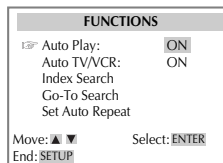

Switch the VCR to TV or VCR mode automatically

- Auto TV/VCR Controls whether the DVD/VCR's TV/VCR setting changes automatically to VCR-viewing mode when turned on.

- 1 Press [VCR] to enter VCR mode. Press [SETUP] and select "FUNCTIONS".**
Move  to "FUNCTIONS" with [▼] and press [ENTER].

- 2 Press [ENTER] to switch between ON and OFF.**
 - Select ON if you want the VCR to switch to the VCR mode when the VCR is turned on or a cassette is inserted. This only applies if you connect the ANT.IN and RF OUT jacks of your VCR and TV and watch your VCR on channel 3 of your TV.
 - Select OFF if you want the VCR to remain in TV mode. This is useful if you watch your VCR on the TV's video input and you don't want your antenna/cable signal interrupted by the VCR.

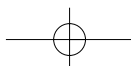

USING ADVANCED VCR FEATURES

Searching a cassette tape for programs (indexing)

- When you record a program, the VCR places an index mark at the start of the recording. To search for an index mark:

1 Press [SETUP] and select "FUNCTIONS".
Select "Index Search".

FUNCTIONS	
Auto Play:	ON
Auto TV/VCR:	ON
Index Search	
Go-To Search	
Set Auto Repeat	

2 If you want to scan through a certain number of index marks, use the number buttons to enter the number of marks you want to search. Press [CLEAR] on the remote to correct an entry.
or
Press [REW] to search backward or [FF] to search forward. The VCR will locate your index mark and begin playback. If you did not enter a specific index number, the VCR will locate the next index mark and begin playback. Press [STOP] to stop index searching.

INDEX SEARCH	
Press REW or FF to begin searching or	
Enter a specific index number	
--	
End: SETUP	

- If two recordings overlap, the index mark for the second program will be erased. Therefore, when you use the index feature to find the second program, the VCR will skip over it.
 - If you record multiple programs in one recording session, the VCR will only find the index mark that was placed on the video cassette tape when the recording session began.
- Some index marks that may be missed by the VCR :
- A mark too close to your location on the tape.
 - The mark at the beginning of a recorded segment of five minutes or less.
 - The first index mark on the tape when you start at the beginning of the tape.

VCR OPERATION

Searching with the tape counter (Go-To Search)

- The tape counter helps you locate segments by their position on the tape. The counter is in hours, minutes and seconds.

1 Press [SETUP] and select "FUNCTIONS".
Select "Go-To Search".

FUNCTIONS	
Auto Play:	ON
Auto TV/VCR:	ON
Index Search	
Go-To Search	
Set Auto Repeat	

2 The tape counter is displayed on the screen. Use the [0-9] keys to enter the tape counter you want to find and press [REW] or [FF]. The VCR will search for the time counter you specified.

GO-TO SEARCH	
Current tape counter is	
2 : 17 : 18	
Press REW or FF to go to -- : -- : 00	

USING ADVANCED VCR FEATURES

Set Auto Repeat

- You can set the DVD/VCR to play the same segment of a tape over and over in a repeating loop.

- Press [SETUP] and select "FUNCTIONS".
Select "Set Auto Repeat".

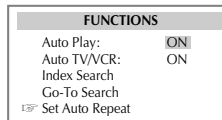

- The Set Auto Repeat menu will ask for a loop end time to be specified.
To turn off Set Auto Repeat, press the [CLEAR] button.

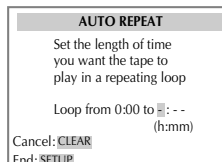

Auto Clock Set

- Auto Clock Set automatically adjusts the DVD/VCR clock for Daylight Savings Time (DST) every spring and fall. The Auto Clock Set is ON by default. If you live in an area that does not use Daylight Savings Time, turn this feature OFF.

- Press [VCR], then press [SETUP] and select "CLOCK SET".
Move ☞ into "Auto Clock Set" with [▼].

- Press [ENTER] to switch between ON and OFF.
 - Select ON if you want the VCR's clock to adjust automatically for DST
 - Select OFF if you do not want the clock to automatically adjust for DST

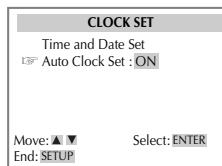

Changing the setup menu language

- You can set the language for VCR Setup menus to English, Spanish, or French.

- Press [SETUP] button and select "LANGUAGE SELECT".

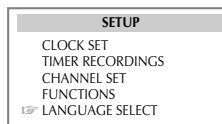

- Set the language to English, Spanish or French and [ENTER].

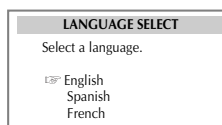

USING ADVANCED VCR FEATURES**Marking a tape for zero search**

- 1 Use [PLAY], [REW] or [FF] to locate the point on the tape you would like to mark as 0:00:00. Pause the tape at this point.
- 2 Press [DISPLAY] to display the tape counter on the screen.
- 3 Press [CLEAR] to reset the tape counter to 0:00:00.
- 4 You can continue to play the tape or perform other functions with the VCR.

On-Screen Display (O.S.D)

- 1 Press [DISPLAY] to display the tape counter, clock and status mode on the TV screen.
- 2 Press [DISPLAY] again to view just the tape counter.

REPLAY function

Replays the previous 15 seconds of videotape.

LAST CHANNEL function

Returns to the previous TV channel which was being watched.

SKIP function

Skips 30 seconds forward on a videotape, which may be used to skip commercials.

VCR OPERATION

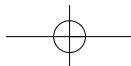

HI-FI STEREO PLAYBACK

Playing a tape in Hi-Fi high-quality

- “Hi-Fi” appears at the top of the screen.
- Pressing [AUDIO] changes the audio track as follows:



If there is noise in the recording, please select “Linear” to reduce it.

Forced Mono

- In some cases reception is poor when receiving stereo or SAP (Secondary Audio Program) audio signals. Press [AUDIO] to improve this poor audio quality by changing to mono sound.
- Press [AUDIO] again or change the channel to resume normal stereo or SAP sound.



- Television programs broadcast in stereo will be recorded in Hi-Fi.

Recording Stereo or Secondary Audio Programs (SAP)

- You can only record stereo and SAPs if the program is broadcast in stereo or with an SAP. Consult a television guide for specific broadcast information.
- Programs are broadcast in mono, stereo, or SAP.
- Press [AUDIO] to select STEREO, MONO, SAP in the following order:



- The following guidelines will help you decide on the best method for recording programs. Choose:
 - Stereo reception for normal recording and to record broadcast stereo television.
 - Mono reception if the stereo signal is weak and sound is too “noisy.”
 - SAP reception to record a second audio program. An example of an SAP is a program that is broadcast in English, but has a Spanish SAP.

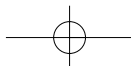

PLAYING A DESIRED SCENE

To skip scenes on a disc

DVD, VCD, VCD2.0, CD, MP3

To skip to the next chapter (or track), press [▶▶].

The current chapter (or track) skips to the next chapter (or track).

To skip to the previous chapter (or track), press [◀◀].

The current scene skips to the previous chapter (or track) or to the first scene of the current chapter (or track).

Jumping directly to a desired title

DVD

- Some movie discs contain multiple titles. If the disc has a title menu, the [TITLE] button can be used to select the desired title. Details of operation will differ depending on the disc used.

* Selecting a title may not be available on certain DVD discs.

- 1 Press [TITLE] or [MENU].**
A list of the titles on the disc is displayed.
In the case of VCD discs, menu screens will appear only if a disc has PBC function and PBC ON is activated.



VCR OPERATION

- 2 Press [ENTER] or [PLAY] after pressing [◀▶▲▼] to select the desired title.**



DVD OPERATION

The selected title starts playing.



PLAYING A DESIRED SCENE

Repeating chapters, titles, and tracks

DVD, VCD, CD, MP3

In playback mode, pressing [REPEAT] more than once changes the repeat action as follows:

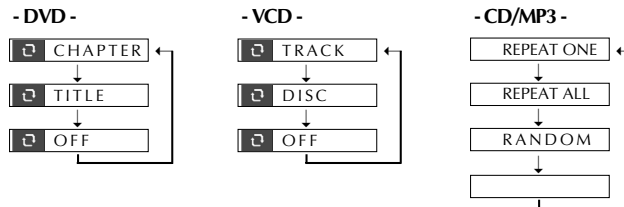

- CHAPTER : Current chapter will play repeatedly.
- TITLE : Current title will play repeatedly.
- TRACK : Current track will play repeatedly.
- DISC : Current disc will play repeatedly.
- REPEAT ONE : Current file will play repeatedly.
- REPEAT ALL : All files on the disc will play repeatedly.
- RANDOM : Tracks on the disc will play in random order.
- OFF : Repeat playback will be cancelled.

Repeating a defined period from A to B

DVD, VCD, CD

- You may use the [A-B] button to select a period to repeat.



A MP3 disc may not be repeated from A to B.

- 1 At the point where you want to start the repeat playback, press [A-B].** REPEAT A-

Point A is set. You may use the Fast Forward, Reverse playback and scene or chapter selection keys to move to the point where you want the repeat to end.
- 2 At the point where you want to end the repeat playback, press [A-B] again.** REPEAT A-B

Point B is set and the segment from A to B will play repeatedly.
- 3 To exit repeat playback mode, press [A-B].** OFF

Normal playback will resume.

PLAYING A DESIRED SCENE

Searching a DVD by Title, Chapter or Time

DVD

1 If you want to search for a title number, press [SEARCH] once.

The current and total number of titles are displayed. Use the [0-9] buttons to enter the desired title number.

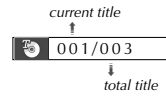

2 If you want to search for a chapter number, press [SEARCH] twice.

The current and total number of chapters are displayed. Use the [0-9] buttons to enter the desired chapter number.

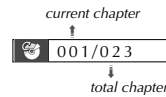

3 If you want to search for a time, press [SEARCH] three times.

Use the [0-9] buttons to enter the desired time.

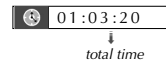

4 When finished, press [ENTER].

Playback will start from the selected position.

Searching VCD by Track or Time

VCD

1 To search for a track number, press [SEARCH] once.

If PBC is OFF, the screen shows the current and total number of tracks. Use the [0-9] buttons to enter the desired track.

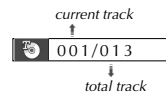

* If PBC is ON, entering the track number converts PBC to OFF mode automatically.

2 To search for a track time, press [SEARCH] twice.

If PBC is OFF, the screen shows total time. Use the [0-9] buttons to enter the desired time.

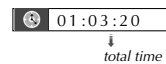

3 When finished, press [ENTER].

Playback will start from the selected position.

DVD OPERATION

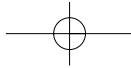
**PLAYING A DESIRED SCENE****Storing bookmarks in memory to be viewed (listened to) again**

DVD

- Storing a bookmark in the DVD memory is similar to marking your page in a book. It allows you to quickly return to any point on the disc. Marks are not permanent. They are erased from the DVD memory when you eject the disc or power off the DVD.

1**Storing a marker in the memory.**

Press [MARK] during play and press [ENTER] at the starting point to be viewed (listened to) again.

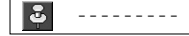
**2****Recalling/Clearing a marker**

Press [MARK] during playback. Press [◀▶] to select the marker to be recalled/cleared.

Press [PLAY] to recall a marker. Or press [CLEAR] to clear a marker.

Play resumes from the point corresponding to the selected marker, or the selected marker is cleared.

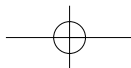

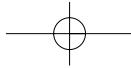

CONFIRMING CURRENT PLAY MODE

Confirming the current disc mode

While in Play mode, press [DISPLAY].

The current disc mode is displayed.

If you want to change the mode, select the item with [▲] or [▼] and enter the new settings with the [0-9], [◀] or [▶] buttons. When finished with each change, press [ENTER].

To exit Display mode, press [DISPLAY] again.

- DVD disc -

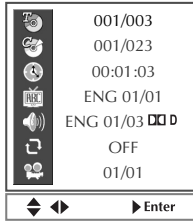

- current title / total title
- current chapter / total chapter
- time elapsed
- subtitle selected / current subtitle / total subtitle
- audio language selected / current / total audio language
- repeat playback mode
- current angle / total angle

- SVCD disc -

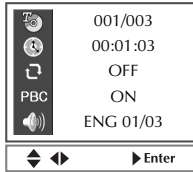

- current track / total track
- time elapsed
- repeat playback mode
- PBC mode
- current audio language / total audio language

- VCD disc -

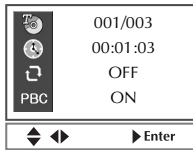

- current track / total track number
- time elapsed
- repeat playback mode
- PBC mode

- CD, MP3, JPEG disc -

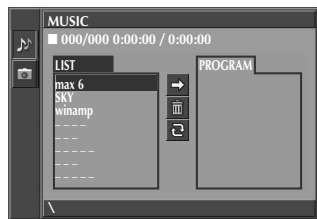

- current track / total track number
- time elapsed, repeat playback mode

DVD OPERATION

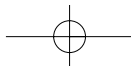

ZOOM, MULTI ANGLE AND 3D AUDIO

Using the zoom function

DVD, VCD

- You can enlarge the current screen 2 or 4 times.



In the case of SVCD and VCD, only 2 times Zoom is available.

Keep pressing [ZOOM] until the preferred level of magnification appears.

Each you press [ZOOM], the zoom magnification changes 2 times (X2) → 4 times (X4) → OFF → 2 times (X2) → ...

The default zoom position is the center of the screen. You can move this point using [◀▶▲▼].

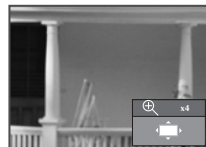
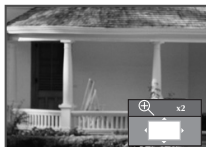

Viewing Different Angles

DVD

- If a disc includes multiple angles, you can watch the same scene from different perspectives. The function is limited to DVD discs supporting multi-angle information.

Keep pressing [ANGLE] until the preferred angle appears.

Every time you press [ANGLE], the angle changes in consecutive order.

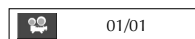

Selecting 3D Audio

DVD, VCD, CD

- You can enjoy a virtual 3D sound effect from 2-channel sources.

Press [3D].

Every time you press [3D], the 3D sound toggles between 3D ON → 3D OFF.

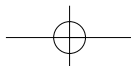
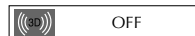
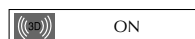

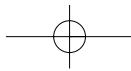

ABOUT MP3, JPEG DISCS

Playing a disc containing MP3 files

MP3

- This unit will play MP3 files recorded on CD-R and CD-RW discs.

- 1 Press [EJECT] to open the disc tray.**
Place a disc with MP3 files on the disc tray with the label side up.

Press [EJECT] to close the disc tray.
The DVD+VCR will load the disc and display the directory structure.

- 2** The following screen appears.

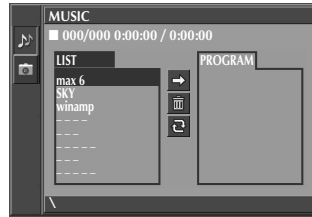

- 3 Select the desired folder.**
Move the cursor to the desired folder by pressing [◀▶▲▼] and press [ENTER] to confirm.

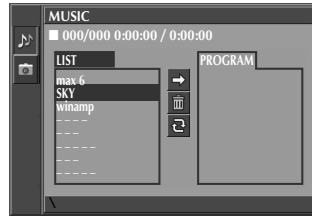

- 4 Select the file to listen to.**
Move the cursor to the file you want to listen to (or view) by pressing [◀▶▲▼].

Press [PLAY] to start playback.

The selected file will play.

Press [■] to stop playback.



- 5 Repeat playback mode.**
Every time you press [REPEAT], repeat playback mode changes as follows: REPEAT ONE → REPEAT ALL → RANDOM → → ...
Or select  by pressing [▶▼] and press [ENTER].

The selected file or folder will be playback repeatedly.



DVD OPERATION

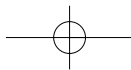

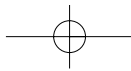

ABOUT MP3, JPEG DISCS

6

You can program playback.

Select the file in LIST folder. Then press [PROG.].

The selected file will go into PROGRAM folder.

Press [PLAY] in PROGRAM folder.

If you want to move all the files in LIST folder to PROGRAM folder, select and press [ENTER].

If you want to delete all the files in the PROGRAM folder, select by pressing and press [ENTER].

If you want to delete one file from the programmed playback, select it and then press [CLEAR] button. This does not remove the file from the disc.



The ability of this unit to read MP3 discs is dependent on the following:

- The Bit Rate must be within 64-256 kbps.
- The maximum number of directories should not exceed 32.
- The maximum depth level of directories should not exceed 4.
- If a file is recorded with a variable bit rate (VBR) (Example : 54~256kbps) distortion may occur during playback.
- File names should be 8 or fewer letters and/or numbers, and must incorporate the "MP3" file extension. EXAMPLE: *****.MP3 where each * is a letter or number.
- Use only letters and/or numbers in file names. If you use special characters, the file and/or folder names may not be displayed correctly on the on-screen display.

Caution

- Avoid using CD-RW (Rewritable) discs. They may not play back correctly.
- The CD-R should be written using the 'disc at once' method.
- Only discs made with ISO 9660 formatting can be played.

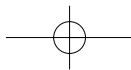

ABOUT MP3, JPEG DISCS

Playing a disc containing JPEG (PHOTO) files

JPEG

- This unit will play JPEG files recorded on CD-R and CD-RW discs. It will also play JPEG files recorded on DVD, DVD-R, DVD-RW, and DVD+RW.

- 1 Select the desired folder.**
Move the cursor to the desired folder by pressing [▲▼] and press [ENTER] to confirm.

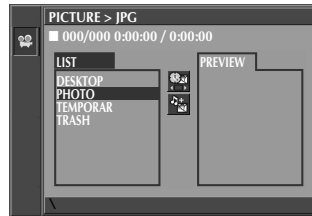

- 2 Slideshow Delay Time set.**
Select "⏸ Slideshow & Delay Time" function. Then press [ENTER] to adjust the slideshow delay time from OFF to 10 seconds.



- 3 Start the slideshow of file.**
If you press [PLAY] when a JPEG image is selected instead of [ENTER], a slideshow will begin automatically starting from the selected image.

- To stop the slideshow, press [STOP].
To turn left, press [◀].
To turn right, press [▶].
To skip to next screen (or file), press [▶▶].
To skip to previous screen (or file), press [◀◀].



- 4 Combination Play set.**
Select "⏸ Combination Play" function.
Then press [ENTER] or [PLAY] to enter into the playback of total files.

A combination play will begin.

- Playback order in Audio/Video : The first file in the first folder → The last file in the last folder



DVD OPERATION

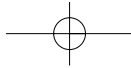

DISPLAYING DISC MENUS

To display disc menus

DVD, VCD2.0

- 1 Press [TITLE] or [MENU].**
 - The disc menu is displayed. These menus vary by disc. ("Return" will appear on the OSD with VCD2.0.)
 - If it is a VCD2.0, select PBC ON mode by pressing [TITLE].
* CD and VCD1.1 do not have menus.

- 2 Move the cursor to the desired menu item with [◀▶▲▼] and select with [ENTER] or [PLAY].**

PROGRESSIVE SCAN MODE

Selecting SCAN MODE

DVD

While in DISC STOP mode, press and hold the [P.SCAN] button for three seconds.

Each time you press and hold [P.SCAN] for three seconds, the SCAN MODE changes as follows: INTERLACED → PROGRESSIVE → INTERLACED → PROGRESSIVE.

* If SCAN MODE is set to "INTERLACED", connect Y/Pb/Pr on the DVD+VCR to the INTERLACED input on your TV.

If SCAN MODE is set to "PROGRESSIVE", connect Y/Pb/Pr on the DVD+VCR to the PROGRESSIVE SCAN input on your TV.

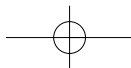

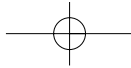

DVD LANGUAGE SETUP



■ You can set your preferred language for disc menus, audio soundtracks and subtitles.

1 While in Stop mode, press [SETUP].



2 Selecting an OSD language. Select a OSD language to be displayed on DVD menus with [ENTER].



3 Selecting an AUDIO language. Set your preferred audio language with [ENTER]. If the audio language is set and recorded on the DISC, it is automatically played in the set language every time it is played.



OTHERS - - - - : Another language can be selected. You can input 4-digit language code.

Refer to the language codes on next page. Press [CLEAR] if an incorrect language code is entered.



4 Selecting a SUBTITLE language. Set your preferred subtitle with [ENTER]. If the subtitle language is set and recorded on the DISC, it is automatically played in the set language every time it is played.



OTHERS - - - - : Another language can be selected. You can input 4-digit language code.

Refer to the language codes on next page. Press [CLEAR] if an incorrect language code is entered.



If a disc does not include language information, the selected language will not appear.

DVD OPERATION

DVD FEATURE SETUP

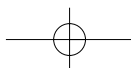

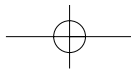

DVD LANGUAGE SETUP

5 **Selecting a DISC MENU language.**
 Set your preferred DISC MENU language with [ENTER]. If the DISC MENU language is set and recorded on the DISC, it is automatically played in the set language every time it is played.



OTHERS - - - - : Another language can be selected. You can input 4-digit language code.

Refer to the language codes. Press [CLEAR] if an incorrect language code is entered.



Table of Language and Their Abbreviations

Enter the appropriate code number for the initial settings "AUDIO", "SUBTITLE" and/or "DISC MENU".

Code	Language	Code	Language	Code	Language	Code	Language	Code	Language
6565	Afar	6983	Spanish	7473	Yiddish	7789	Burmese	8385	Sundanese
6566	Abkhazian	6984	Estonian	7487	Javanese	7865	Nauru	8386	Swedish
6570	Afrikaans	6985	Basque	7565	Georgian	7869	Nepali	8387	Swahili
6577	Ameharic	7065	Persian	7575	Kazakh	7876	Dutch	8465	Tamil
6582	Arabic	7073	Finnish	7576	Greenlandic	7879	Norwegian	8469	Telugu
6583	Assamese	7074	Fiji	7577	Cambodian	7982	Oriya	8471	Tajik
6588	Aymara	7079	Faroese	7578	Kannada	8065	Panjabi	8472	Thai
6590	Azerbaijani	7082	French	7579	Korean	8076	Polish	8473	Tigrinya
6665	Bashkir	7089	Frisian	7583	Kashmiri	8083	Pashto, Pushto	8475	Turkmen
6669	Byelorussian	7165	Irish	7585	Kurdish	8084	Portuguese	8476	Tagalog
6671	Bulgarian	7168	Scots Gaelic	7589	Kirghiz	8185	Quechua	8479	Tonga
6672	Bihari	7176	Galician	7665	Latin	8277	Rhaeto-Romance	8482	Turkish
6678	Bengali; Bangla	7178	Guarani	7678	Lingala	8279	Romanian	8484	Tatar
6679	Tibetan	7185	Gujarati	7679	Laothian	8285	Russian	8487	Twi
6682	Breton	7265	Hausa	7684	Lithuanian	8365	Sansrit	8575	Ukrainian
6765	Catalan	7273	Hindi	7686	Latvian, Lettish	8368	Sindhi	8582	Urdu
6779	Corsican	7282	Croatian	7771	Malagasy	8372	Serbo-Croatian	8590	Uzbek
6783	Czech	7285	Hungarian	7773	Maori	8373	Singhalese	8673	Vietnamese
6789	Welsh	7289	Armenian	7775	Macedonian	8375	Slovak	8679	Volapük
6865	Danish	7365	Interlingua	7776	Malayalam	8376	Slovenian	8779	Wolof
6869	German	7378	Indonesian	7778	Mongolian	8377	Samoan	8872	Xhosa
6890	Bhutani	7383	Icelandic	7779	Moldavian	8378	Shona	8979	Yoruba
6976	Greek	7384	Italian	7782	Marathi	8379	Somali	9072	Chinese
6978	English	7387	Hebrew	7783	Malay	8381	Albanian	9085	Zulu
6979	Esperanto	7465	Japanese	7784	Maltese	8382	Serbian		

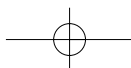

VIDEO SETUP

- To set the DVD+VCR to match the capabilities of your TV:

1 While in Stop mode, press [SETUP].

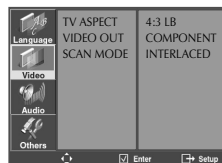

2 Selecting TV ASPECT.

If you select "4:3 LB", you can watch the original widescreen movie, but black bars will appear above and below the picture. If you select "4:3 PS", the picture will fill the screen but the sides of the movie will be cropped.

If a disc size was recorded in 4:3, you cannot watch it in wide screen even if TV ASPECT is set to "16:9 WIDE".



3 Selecting VIDEO OUT.

You may set VIDEO OUT to S-VIDEO or COMPONENT.

* If VIDEO OUT is set to S-VIDEO, you cannot set SCAN MODE. If VIDEO OUT is set to COMPONENT, you can set SCAN MODE.



4 Selecting SCAN MODE.

You may set SCAN MODE to INTERLACED or PROGRESSIVE.

* If SCAN MODE is set to "INTERLACED", connect Y/Pb/Pr on the DVD+VCR to the INTERLACED input on your TV.

If SCAN MODE is set to "PROGRESSIVE", connect Y/Pb/Pr on the DVD+VCR to the PROGRESSIVE SCAN input on your TV.

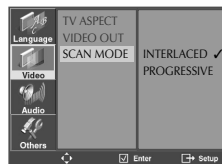

DVD FEATURE SETUP

AUDIO SETUP

- To set the DVD+VCR to match the capabilities of your audio system:

1 While in Stop mode, press [SETUP].



2 Selecting DIGITAL OUT.

Set audio output to coaxial or optical. You can set the outgoing digital signal to BITSTREAM or LPCM:

- **BITSTREAM** : The raw audio signal recorded on the disc goes to the digital audio output.
- **LPCM** : The decoded audio signal goes to the digital audio output.



3 Select a Dynamic Range

You can set the Dynamic Range as follows:

- **Off** : You can hear the sound as it was originally recorded on the disc.
- **Full** : You can hear loud sounds softer and soft sounds louder.



OTHERS SETUP

- 1** While in Stop mode, press [SETUP].

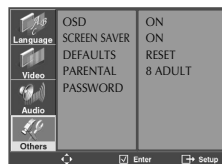

- 2** **Selecting OSD.**
Select "ON" to have the OSD (On Screen Displays) shown on the screen.



- 3** **Selecting SCREEN SAVER.**
To protect your TV from possible damage from bright scenes over long periods of time, you can turn on the built-in screensaver. When set to "ON", the screensaver functions automatically whenever the unit is left in Stop for 5 minutes.



- 4** **Restoring DEFAULTS.**
If you press [ENTER] when the cursor highlights RESET, "Are you sure?" message will appear. Confirm with [OK].
This feature resets every function to its original Factory Defaults except the Parental Control settings.



- 5** **Selecting PARENTAL.**
Press [▶] when the cursor highlights PARENTAL.

When "INPUT PASSWORD" appears on the screen, enter your password. And confirm with [OK].

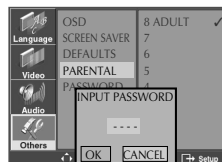

Change Parental Rating level.

After you have entered the correct password, you can change the PARENTAL rating by pressing [▲▼]. Confirm your choice by pressing [ENTER].

These 8 levels of parental control protect children from watching violence, sexual scenes and other objectionable material.



DVD FEATURE SETUP

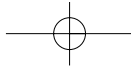

OTHERS SETUP



- If the password is wrong, "WRONG PASSWORD" appears instead of "CHANGE PASSWORD".

- The initial Password is "3308". If you forget your new password, you may input this number.

6 Changing a password.

To change your password, move the cursor to "PASSWORD" and press [▶].

Enter your current password.

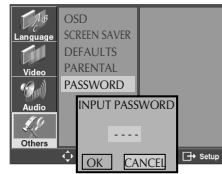

Then enter a new password and press [ENTER].

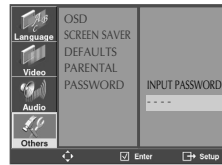

Confirm the new password by typing it again.

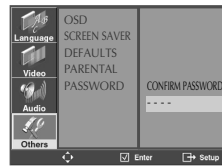

Now your password is changed.

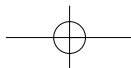
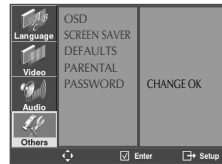

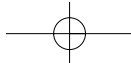

ABOUT DVD



Playable Discs

- DVD, Video CD (Version 1.1, 2.0), S-VCD and Audio CD

Disc type	Playable	Restriction
DVD	Yes	Region number 1 or Region number All
Video CD	Yes	Version 1.0/1.1/2.0, SVCD
CD	Yes	PCM
CD-G	Yes	Only Audio playback
CD-ROM	Yes	MP3 File
CD-R	Yes	Video-CD/CD/CD-ROM (MP3 File)
CD-RW	Yes	Video-CD/CD/CD-ROM (MP3 File)
DVD-R	Yes	DVD Video
DVD-RW	Yes	DVD Video
DVD+RW	Yes	DVD Video
DVD-ROM	No	
DVD-RAM	No	
Photo CD	Yes	(except Kodak-CD)

REGION MANAGEMENT INFORMATION

This unit is designed and manufactured to respond to the Region Management information that is recorded on a DVD disc. The region number of this player is "1". If the region number described on the DVD discs does not correspond to the Region number of this player, the player will not play this disc. This player will play DVD discs made for "ALL" regions. Therefore, this player will play DVD discs marked with labels containing the region number "1" or "ALL".



(Region 1)



(Region ALL)

DVD Terms

DVD	A DVD (Digital Versatile Disc or Digital Video Disc) can include 135 minutes of video information. It can also hold up to 8 languages and 32 subtitle languages. By using MPEG-2 video compression and digital 3D surround sound, DVD realizes high resolution video and theater quality sound.
CDDA	A CDDA (Compact disc digital audio) is a music disc.
MP3	MP3 (MPEG-1 Layer 3) is an audio compression format that enables audio files to be stored and transferred on a computer with a relatively small file size. It enables you to enjoy near CD quality music at a fraction of the size.
PBC	PBC (PlayBack Control) refers to control of Video CD 2.0, Video CD 3.0, SVCD and CVD. The scenes or information to be viewed (or listened to) can be selected interactively on your TV monitor.

DVD FEATURE SETUP

HELP

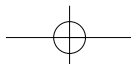

ABOUT DVD

CHAPTER	Information recorded on a DVD. A title on a DVD is divided into many tracks, each of which are referred to as chapters. Each chapter is numbered and can be searched using its number.
TITLE	Information recorded on a DVD. A DVD can be divided into many titles.
TRACK	Information recorded on a video CD or audio CD. A disc consists of many tracks. Each track is numbered and can be searched using its number.
dts	Digital Theatre System is a 5.1 -channel surround sound system that is widely used in movie theatres around the world. It enables the bit rate to be increased to provide excellent sound quality. "DTS" and "DTS Digital Out" are trademarks of Digital Theater Systems, Inc.
Multi Angle	Some DVD discs contain various scenes that have been simultaneously shot from a number of different angles.
PCM	Linear PCM is a signal-recording format used on CDs. While a CD is recorded at 44.1kHz/16bit, a DVD is recorded at 48kHz/16bit up to 96kHz/24bit.
Dolby Digital	Dolby Digital enables the delivery of mono through 5.1-channel audio at data rates from 32 kbps to 640 kbps, thus offering flexibility and economical performance as well as uncompromised sound quality.
Bitstream	Digital audio data that is decoded into an analog signal for subsequent output to speakers.
Lt/Rt	Provides a Dolby Surround-compatible downmix mode which can be decoded by a Dolby Pro Logic decoder to produce a multi-channel surround experience.
Downmix	DOWNMIX is reproducing the proper audio when audio format recorded on a disc differs from the output audio channel configuration. For example, with just one stereo speaker system you can hear full 5.1 channel audio.
S-VIDEO	The S-VIDEO output separates the color (C) and luminance (Y) signals before transmitting them to the TV set in order to achieve a sharper picture.
COMPONENT	Component Video is a technology to divide and transmit a color signal (C) into B-Y (Pb) and R-Y (Pr) color difference signal. This technology supplies a clearer and more vivid picture than composite video.

Handling Discs

- To keep a disc clean, do not touch the side containing playback information.
- Do not attach paper or tape to it.
- Do not expose a disc to direct sunlight or electric heating systems.
- Keep discs in their case between uses to prevent damage.

**Cleaning Discs**

- Before using, gently wipe the disc from the center out with a clean cloth.
- Do not use any type of solvent such as thinner, benzol (benzene), commercial cleaning products or antistatic sprays.



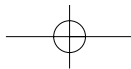

ABOUT VCR AND VIDEOTAPE

VCR Terms

AFT	Automatic fine tuning, a circuit that automatically adjusts TV reception to optimum condition.
CABLE	Cable television.
Index Search	A feature of this VCR that automatically records an index mark each time recording begins. It helps you locate a particular segment of the tape quickly and easily.
SLP	Super Long Play, an intermediate tape recording speed that combines most of the picture/audio quality obtainable at the standard recording speed with some of the tape economy of Extended Play.
OSD	On-screen display of information pertinent to the features of the VCR.
OTR	One-touch recording, a feature that allows you to record the program you're watching by pressing the REC key. Each press of the key increases the recording time by 30 minutes, up to four hours.
RF	Radio frequency, the composite audio/video signal supplied to a TV receiver (or other video component) by an antenna or cable system.
Safety tab	The plastic tab at the back of a video tape cassette which, when removed, prevents accidental erasure of a recording.
SP	Standard play, the recording speed to use when the best picture quality is of prime importance (and when total recording time is not).

What is dew condensation symptom?

- If a VCR is moved from a cool place to a warm and damp place or to a place facing a direct cool air flow from an air-conditioner... condensation may form on the VCR heads.

If condensation occurs,

- 1 First, turn the unit on for one or two hours before using it.
- 2 Do not use when condensation is present because it may damage the VCR or videotape.

How to use a head cleaner

- If you use an old or contaminated videotape, the picture may not be clear due to contamination of the VCR heads. Remove contaminants using a head-cleaner as described below.

- 1 Insert a head-cleaner tape into the VCR.
- 2 Press [PLAY] for 5 seconds, and then press [FF] for about 10 seconds.

PLAY (5 secs)



FF (10 secs)

- 3 Eject the head-cleaner from the VCR.
 - If the picture is still not clear, repeat the above 2 or 3 more times.

HELP

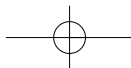

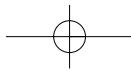

TROUBLESHOOTING (DVD)

Symptom	Checks
<ul style="list-style-type: none"> • The player does not play. 	<ul style="list-style-type: none"> ➤ If a DVD is from overseas, it may not play. Make sure the DVD's region code is 1 or All. ➤ Make sure the DVD is inserted in the right direction. ➤ If it is a CD-ROM or DVD-ROM for a PC, it will not play.
<ul style="list-style-type: none"> • No sound. 	<ul style="list-style-type: none"> ➤ Play mode may be slow or paused. (In variable speed play, no sound comes through) ➤ Check audio connections. ➤ Make sure TV and amplifier are working correctly. ➤ Check "AUDIO" items in the SETUP menu.
<ul style="list-style-type: none"> • A disc is playing but screen does not appear or poor screen appears. 	<ul style="list-style-type: none"> ➤ Did you turn on your TV? ➤ Check video connections. ➤ The player may be paused. ➤ The disc may have some contaminants or be damaged. ➤ The disc may be defective.
<ul style="list-style-type: none"> • Sound is irregular. 	<ul style="list-style-type: none"> ➤ Check the connection with Dolby Digital amplifier. ➤ Make sure plugs are securely connected. ➤ Some contaminants may be present in connection terminal.
<ul style="list-style-type: none"> • Remote control does not work. 	<ul style="list-style-type: none"> ➤ To operate DVD, first press the [DVD] button. ➤ Make sure you are within 23 feet (7 meters) of the unit, and that there are no obstacles between the remote and the front panel. ➤ Battery may be weak or dead. ➤ Unplug the power plug and plug it again.
<ul style="list-style-type: none"> • Dolby Digital sound does not work 	<ul style="list-style-type: none"> ➤ Dolby Digital sound works only with a Dolby Digital amplifier. ➤ Make sure there is a "Dolby Digital" mark on the DVD. ➤ If using the digital output, press [STOP], then press [SETUP] and make sure "DIGITAL OUTPUT" is set to "BITSTREAM". ➤ Make sure all components are connected correctly.
<ul style="list-style-type: none"> • [AUDIO] or [SUBTITLE] button does not work. 	<ul style="list-style-type: none"> ➤ If a DVD does not include language information, these functions are not supported.
<ul style="list-style-type: none"> • [ANGLE] button does not work while a DVD is playing. 	<ul style="list-style-type: none"> ➤ "ANGLE" is supported only if the DVD contains multi angle scenes.
<ul style="list-style-type: none"> • "MENU" does not appear while a DVD is playing. 	<ul style="list-style-type: none"> ➤ Make sure you are within 23 feet (7 meters) of the unit, and that there are no obstacles between the remote and the front panel. ➤ Battery may be weak or dead. ➤ A DVD may not contain menu information.
<ul style="list-style-type: none"> • Screen shakes or appears only in black and white. (or Subtitles shake) 	<ul style="list-style-type: none"> ➤ A disc may have some contaminants or be damaged. ➤ If you playback a PAL DVD disc with region code "ALL", the playback screen may shake.
<ul style="list-style-type: none"> • The file name of MP3 (CD-R) appears with strange letters. 	<ul style="list-style-type: none"> ➤ The unit only recognizes MP3 file names with letters, numbers and special symbols. The maximum length is 10 characters. ➤ Unrecognized characters will be displayed as "----".
<ul style="list-style-type: none"> • Any MP3 (CD-R) file isn't displayed. 	<ul style="list-style-type: none"> ➤ If the surface of the disk is damaged, file display and playback is not possible.

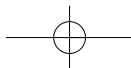

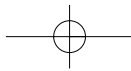

TROUBLESHOOTING (VCR)



Symptom	Checks
<ul style="list-style-type: none"> • "Power On" does not work. 	<ul style="list-style-type: none"> ➤ Make sure the power plug is inserted in an electric outlet.
<ul style="list-style-type: none"> • Unit does not work even in "Power On". 	<ul style="list-style-type: none"> ➤ Make sure a videotape is inserted. ➤ Press [VCR] on the remote control or press DVD/VCR on the front panel of the unit. ➤ Unplug the unit and plug it in again.
<ul style="list-style-type: none"> • A videotape will not insert. 	<ul style="list-style-type: none"> ➤ Make sure a power plug is inserted in an electric outlet. ➤ Make sure a videotape is not already inserted. ➤ Make sure the videotape is inserted in the right direction (the side with the transparent window should be on the top) ➤ Have you inserted the videotape again just after the tape was ejected? Try it again after fully ejecting it. ➤ When a videotape jams on insertion the tape may not be inserted correctly. Remove the tape and then reinsert it gently.
<ul style="list-style-type: none"> • On inserting a videotape, the tape is re-ejected. 	<ul style="list-style-type: none"> ➤ This is a safety feature to protect your videotape. Please pull out the tape and insert it again.
<ul style="list-style-type: none"> • A videotape is not ejected. 	<ul style="list-style-type: none"> ➤ If the product is not used for a long time, a videotape may not be ejected because the tape inside may be stretched. In this case, unplug the unit for about 10 minutes, plug it in again, then press [EJECT].
<ul style="list-style-type: none"> • A channel on video and a play screen does not appear. 	<ul style="list-style-type: none"> ➤ Check your antenna's connection. ➤ TV channel should be set to video channel (3 or 4). ➤ Check if your antenna's signal is weak. If so, connect a frequency amplifier to the device. ➤ Press [TV/VCR] until "VCR" is displayed on the display panel.
<ul style="list-style-type: none"> • Noise (screen noise) appears on screen. 	<ul style="list-style-type: none"> ➤ VCR is not playing and is tuned to a weak TV channel. ➤ Select TV by pressing [TV/VCR] on remote control.
<ul style="list-style-type: none"> • Noise appears on screen after recording. 	<ul style="list-style-type: none"> ➤ While playing a videotape, there may be some noise at the beginning of the tape or when resuming playback after pausing the tape, which is normal.
<ul style="list-style-type: none"> • While in Play mode noise appears. 	<ul style="list-style-type: none"> ➤ Press [TRK +/-] for better picture quality. Videotape may be poor. Try playing another one to decide if the problem is the tape of the VCR.
<ul style="list-style-type: none"> • Sound and picture are irregular. • Sound comes on but picture does not appear. • Screen is irregular and stripes appear. • "Screen Error" message is displayed on screen. 	<ul style="list-style-type: none"> ➤ Use a head-cleaner to clean the VCR heads. VCR heads may be contaminated.
<ul style="list-style-type: none"> • While recording and playing, the top of screen waves. 	<ul style="list-style-type: none"> ➤ Because VCR Play signals are not stable like a TV signals, the screen may be unstable or curved while playing. To fix the problem, adjust the horizontal adjustment on the TV.
<ul style="list-style-type: none"> • A screen is not clear. 	<ul style="list-style-type: none"> ➤ If the videotape is old or was recorded on another model bands may appear on the screen. ➤ Try using the [TRK +/-] buttons. ➤ Try using a head-cleaner.

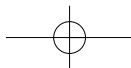

TROUBLESHOOTING (VCR)

Symptom	Checks
<ul style="list-style-type: none"> • A screen in Pause mode is shaking or slow playback is not clear. 	<ul style="list-style-type: none"> ➤ Try using a head-cleaner. ➤ Try using the [TRK+/-] buttons.
<ul style="list-style-type: none"> • The unit will not record a TV program. 	<ul style="list-style-type: none"> ➤ Check whether the desired channel is visible on the screen. If not, press [TV VIEW] to view the TV. ➤ Check whether the timer recording settings are right. ➤ Are RF cables connected to the antenna connection correctly? ➤ Does a channel number appear on the display? ➤ Check the record safety tab on the videotape. ➤ Is the RF cable connected to the "ANT.IN" terminal?
<ul style="list-style-type: none"> • When [REC] is pressed, the videotape is immediately ejected. 	<ul style="list-style-type: none"> ➤ Make sure the clock is set correctly. ➤ Does the display show "□" (Ready for timer recording)? ➤ Make sure the timer recording settings are right. ➤ Check the record safety tab on the videotape.
<ul style="list-style-type: none"> • Timer recording from Cable TV does not work. 	<ul style="list-style-type: none"> ➤ Was the cable data output code set correctly? ➤ Is the cable box setup and output channel set correctly? Refer to its user manual for instructions. ➤ Did you enter a password? (Please cancel it.) ➤ Did you turn off your player? (Please turn it on.)
<ul style="list-style-type: none"> • In spite of pressing [CH+/-], a channel can not be set. 	<ul style="list-style-type: none"> ➤ The selected channel cannot be stored. ➤ Please check your channel settings or press a number button.
<ul style="list-style-type: none"> • Screen is distorted while playing a copy of a tape. 	<ul style="list-style-type: none"> ➤ Some rental tapes or discs are set to prevent copying in manufacturing. These tapes cannot be duplicated in good condition.
<ul style="list-style-type: none"> • Remote control does not work. 	<ul style="list-style-type: none"> ➤ Battery may be weak or dead. ➤ Make sure you are within 23 feet (7 meters) of the unit, and that there are no obstacles between the remote and the front panel.
<ul style="list-style-type: none"> • [REW] and [FF] Buttons on remote control do not work. 	<ul style="list-style-type: none"> ➤ If a videotape is completely rewound, "VISS REW" and "REW" do not work. ➤ If a videotape has been played completely the end, "FF", "VISS FF", "PLAY" and "REC" do not work.
<ul style="list-style-type: none"> • VISS index search does not work. 	<ul style="list-style-type: none"> ➤ Are you playing a tape that was not recorded in this recorder? ➤ You may have started recording while the VCR was paused. Please start recording from Stop mode.
<ul style="list-style-type: none"> • Cable broadcasting can not be selected. 	<ul style="list-style-type: none"> ➤ Select "CABLE" not "NETWORK" in the "CHANNEL SETTING" menu.

SPECIFICATIONS

Power requirement	AC 120V, 60Hz	
Power consumption	24W (supplementary 4W)	
Weight	9.9 lbs (4.5kg)	
Dimensions (WxHxD)	17.1" x 3.7" x 10.0" (435mm x 93mm x 255mm)	
Operating temperature	41°F~95°F (5°C~35°C)	
Installation conditions	Horizontal / Relative humidity under 80%	
Channel coverage	VHF: 2-13 CH / UHF: 14-69 CH / Cable: 1-125	
Signal type	NTSC COLOR	
Antenna Input/output	U/V-mixed: 75Ω unbalanced	
VIDEO input	1.0 Vp-p unbalanced, RCA JACK	
AUDIO input	-8.8dBm, RCA JACK	
VHF output	3 or 4 CH	
VIDEO output	DVD/VCR	VIDEO output terminal, 1.0 Vp-p unbalanced, RCA JACK
	DVD	S-VIDEO output (75Ω In load Y: 1.0Vp-p, C:0.286Vp-p) COMPONENT output (75Ω In load Y: 1.0Vp-p, Pb:0.7Vp-p, Pr:0.7Vp-p)
AUDIO output	DVD/VCR	Audio output terminal (2 kinds): -8.8dBm(VCR), 2.0Vms(DVD), RCA JACK
	DVD	Analogue AUDIO output (2 CH): 2.0Vrms Digital audio output (COAXIAL)
Playable tapes	Very high dense tapes with VHS marks	
Playable discs	DVD, VIDEO-CD, CD (12mm), CD (8mm), MP3, CD-R, CD-RW	
Tape speed	SP: 33.35mm/s, SLP: 11.12mm/s	
Playtime	SP: 2hrs, SLP: 6hrs (use of T-120 tape)	
Clock display	12 hrs AM/PM	
Timer Recording	8 programs a year	
VIDEO S/N (VCR)	Over 45dB(Standard recording)	
Resolution	VCR	Over 220 lines (Standard recording)
	DVD	Over 500 lines (DVD Disc PLAY)
AUDIO	VCR	Over 69dB (Hi-Fi), over 40dB (Mono)
	DVD	90dB
AUDIO dynamic range	90dB	

DVD Audio output standards

Output	Disc type		
	DVD	VIDEO-CD	CD
Analogue Audio output	48/96KHz sampling	44.1KHz sampling	44.1KHz sampling
Digital Audio output	48KHz sampling	44.1KHz sampling	44.1KHz sampling

HELP

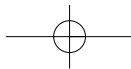

WARRANTY

GOVIDEO LIMITED WARRANTY

Who Provides the Limited Warranty

During the warranty period, the GoVideo Warranty Administrator will honor service for 90 days labor, 1 year parts from the original date of consumer purchase. See below for Commercial, Industrial or Educational use coverage. Remote controls are warrantied for 90 days from the date of purchase.



Who is Protected

This warranty protects the original consumer owner of this GoVideo product.

What is Covered and How Long

This warranty covers internal operating parts and service/labor to repair or replace covered parts in this GoVideo product for 90 days labor, 1 year parts, from the date of purchase, defined as follows: (1) Original Consumer Retail Purchase; (2) First Rental Purchase Agreement; or (3) First Lease Purchase Agreement (the "Warranty Period"). Labor and replacement parts supplied during the Warranty Period are covered only for the remaining portion of the original Warranty Period. The GoVideo Warranty Administrator shall have no liability for service under this warranty if non-OEM (Original Equipment Manufacturer) replacement parts are used in the repair of your GoVideo product.

What the Owner Must Do If Service is Required

Please contact our customer service department at 1-800-736-7679 to repair or replace your product, at GoVideo's option, if it proves to be defective in material or workmanship under normal use, during the warranty period listed above, effective from the date of original consumer purchase of the product. Repaired or replacement units are warrantied for the remaining period of the original warranty. Please retain dated sales receipt. Within the warranty period, the customer pays for inbound shipping charges and GoVideo pays return shipping charges.

Other Warranty Coverage

Commercial, Industrial or Educational use has the same warranty coverage as stated in this warranty.

What are the Exceptions

This warranty does **not** cover: (1) Normal maintenance service, such as cleaning. (2) Damage from misuse, abuse neglect or accident, natural disasters or Acts of God. (3) Cabinetry, decorative parts, A/C adapters, knobs or buttons. (4) The foreign country use of this product. (5) GoVideo product which has been electronically or mechanically modified in any way or incorporated into other products. (6) Installation and setup service adjustments. (7) Owner instruction. Your Owner's Guide provides information regarding operating instructions and user controls. For additional information, contact your authorized GoVideo dealer.

Go Video is not responsible for any shipping, handling or insurance charges.

This Exclusive Limited Warranty excludes all incidental and consequential damages. Some states do not allow the exclusion of incidental and consequential damages, so the above exclusion may not apply to you.

ALL IMPLIED WARRANTIES, INCLUDING IMPLIED WARRANTIES OF MERCHANTABILITY AND FITNESS FOR A PARTICULAR PURPOSE ARE LIMITED IN DURATION TO THE DURATION OF THIS WARRANTY PERIOD. Some states do not allow limitations on how long an implied warranty lasts, so the above limitation may not apply to you.

This Exclusive Limited Warranty gives you specific legal rights and you may also have other rights which vary from state to state.

GOVIDEO WARRANTY ADMINISTRATOR

7835 East McClain Drive • Scottsdale, Arizona 85260-1732
customersupport@govideo.com
1-800-736-7679

P/N : 97P95600N0-B7

