

DVD Player/HiFi VCR Combo DVC-2010



 **Polaroid**

Safety Precautions



The lightning flash with an arrowhead symbol within an equilateral triangle is intended to alert the user to the presence of uninsulated "dangerous voltage" within the product's enclosure that may be of sufficient magnitude to constitute a risk of electric shock to persons.



The exclamation point within an equilateral triangle is intended to alert the user to the presence of important operating and maintenance (servicing) instructions in the literature accompanying the appliance.

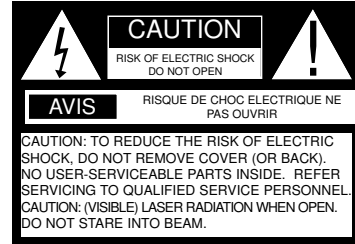

WARNING: TO REDUCE THE RISK OF FIRE OR ELECTRIC SHOCK, DO NOT EXPOSE THIS APPARATUS TO RAIN OR MOISTURE.

THE APPARATUS SHALL NOT BE EXPOSED TO DRIPPING OR SPLASHING WATER AND NO OBJECTS FILLED WITH LIQUIDS, SUCH AS VASES, SHALL BE PLACED ON THE APPARATUS. DO NOT OPEN THE CABINET, DANGEROUS HIGH VOLTAGES ARE PRESENT INSIDE THE ENCLOSURE. ONLY QUALIFIED SERVICE PERSONNEL SHOULD ATTEMPT THIS.

CAUTION: TO PREVENT ELECTRIC SHOCK, MATCH WIDE BLADE OF PLUG TO WIDE SLOT, AND FULLY INSERT.

ATTENTION: POUR EVITER LES CHOCS ELECTRIQUE, INTRODUIRE LA LAME LA PLUS LARGE DE LA FICHE DANS LA BORNE CORRESPONDANTE DE LA PRISE ET POUSSER JUSQU' AU FOND.

CAUTION: This DVD PLAYER employs a Laser System. To prevent direct exposure to the laser beam, do not try to open the enclosure. Visible laser radiation when open and interlocks defeated. Use of controls or adjustments or performance of procedures other than those specified herein may result in hazardous radiation exposure. **DO NOT STARE INTO BEAM.**

To ensure proper use of this product, please read this owner's manual carefully and retain for future reference. Should the unit require maintenance, contact an authorized service location, or contact local dealer. Only qualified service personnel should remove the cover.

FCC NOTICE: This equipment has been tested and found to comply with the limits for a Class B digital device. Pursuant to the part 15 of FCC Rules. These limits are designed to provide reasonable protection against harmful interference in a residential installation.

This equipment generates,uses and can radiate radio frequency energy and,if not installed and used in accordance with the instructions,may cause harmful interference to radio communication.However,there is no guarantee that interference will not occur in a particular installation.If this equipment does cause harmful interference to radio or television reception,which can be determined by turning the equipment off and on,the user is encouraged to try to correct the interference by one or more of the following measures:

- Reorient or relocate the receiving antenna.
- Increase the separation between the equipment and receiver.
- Connect the equipment into an outlet on a circuit different from that to which the receiver is connected.
- Consult the dealer or an experienced radio/TV technician for help.

FCC Caution:To assure continued compliance,(example-use only shielded interface cables when connecting to computer or peripheral devices).Any changes or modifications not expressly approved by the party responsible for compliance could void the user's authority to operate this equipment.

WARNING: Changes or modifications made to this equipment, not expressly approved by manufacturer or parties authorized by manufacturer will void all the manufacture warranties.

THE REGION CODE FOR THE UNIT IS 1.

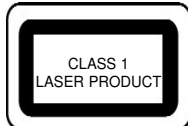

Since it is very usual for DVD movies to be released at different times in different regions of the world, all players have region codes and discs can have an optional region code. If you load a disc of a different region code to your player, you will see the region code notice on the screen. The disc will not play, and should be unloaded.

For Customer Use:

In spaces provided below, record the Model and Serial No. located on the rear panel of your combo player.

Model No. _____ **Serial No.** _____

Retain this information for future reference.

Important Safety Instructions

CAUTION: Use of controls or adjustments or performance of procedures other than those specified herein may result in hazardous radiation exposure.

CAUTION: PLEASE READ AND OBSERVE ALL WARNINGS AND INSTRUCTIONS GIVEN IN THIS OWNER'S MANUAL AND THOSE MARKED ON THE UNIT. RETAIN THIS BOOKLET FOR FUTURE REFERENCE.

This set has been designed and manufactured to assure personal safety. Improper use can result in electric shock or fire hazard. The safeguards incorporated in this unit will protect you if you observe the following procedures for installation, use and servicing. This unit is fully transistorized and does not contain any parts that can be repaired by the user. **DO NOT REMOVE THE CABINET COVER, OR YOU MAY BE EXPOSED TO DANGEROUS VOLTAGE. REFER SERVICING TO QUALIFIED SERVICE PERSONNEL ONLY.**

1. Read these instructions.
2. Keep these instructions.
3. Heed all warnings
4. Follow all instructions.
5. Do not use this apparatus near water.
6. Clean only with dry cloth
7. Do not block any ventilation openings. Install in accordance with the manufacturer's instructions.
8. Do not install near any heat sources such as radiators, heat registers, stoves, or other apparatus (including amplifiers) that produce heat.
9. Do not defeat the safety purpose of the polarized or grounding-type plug. A polarized plug has two blades with one wider than the other. A grounding type plug has two blades and a third grounding prong. The wide blade or the third prong is provided for your safety. If the provided plug does not fit into your outlet, consult an electrician for replacement of the obsolete outlet.
10. Protect the power cord from being walked on or pinched particularly at plugs, convenience receptacles, and the point where they exit from the apparatus.
11. Only use attachments/accessories specified by the manufacturer.



12. Use only with the cart, stand, tripod, bracket, or table specified by the manufacturer, or sold with the apparatus. When a cart is used, use caution when moving the cart/apparatus combination to avoid injury from tip-over.
13. Unplug this apparatus during lightning storms or when unused for long periods of time.
14. Refer all servicing to qualified service personnel. Servicing is required when the apparatus has been damaged in any way, such as power-supply cord or plug is damaged, liquid has been spilled or objects have fallen into the apparatus, the apparatus has been exposed to rain or moisture, does not operate normally, or has been dropped.

ADDITIONAL SAFETY INSTRUCTIONS

15. When you use headphones, keep the volume at a moderate level. If you use the headphones continuously with high volume sound, it may cause tearing damage.
16. Do not overload wall outlets; extension cords, or integral convenience receptacles as this can result in a risk of fire or electric shock.
17. Keep your fingers well clear of the disc tray as it is closing. Neglecting to do so may cause serious personal injury.
18. Do not place a heavy object on or step on the apparatus. The object may fall, causing serious personal injury and serious damage to the apparatus.
19. Do not use a cracked, deformed, or repaired disc. These discs are easily broken and may cause serious personal injury and apparatus malfunction.

20. Caution - Do not attempt to service this product yourself as opening or removing covers may expose you to dangerous voltage or other hazards. Refer all servicing to qualified service personnel.

Caution: This unit should only be serviced by an authorized and properly trained technician. Opening the cover or other attempts by the user to service this unit may result in serious injury or death from electrical shock, and may increase the risk of fire.

Precautions

Notes on handling

- When shipping the Player, the original shipping carton and packing materials come in handy. For maximum protection, repack the unit as it was originally packed at the factory.
- Do not use volatile liquids, such as insect spray, near the player. Do not leave rubber or plastic products in contact with the Player for a long time. They will leave marks on the finish.
- The top and rear panels of the Player may become warm after a long period of use. This is not a malfunction.
- When the Player is not in use, be sure to remove the disc and turn off the power.
- If you do not use the Player for a long period, the unit may not function properly in the future. Turn on and use the player occasionally.

Notes on locating

- Place the player on a level surface. Do not use is on a shaky or unstable surface such as a wobbling table or inclined stand. The loaded disc may come off the proper position and cause damage to the player.
- When you place this player near a TV or radio, the playback picture may become poor and the sound may be distorted. In this case, place the player away from the TV or radio.

Notes on cleaning

Use a soft, dry cloth for cleaning.

- For stubborn dirt, soak the cloth in a weak detergent solution, wring well and wipe. Use a dry cloth to wipe it dry. Do not use any type of solvent, such as thinner and gasoline, as they may damage the surface of the player.
- If you use a chemical saturated cloth to clean the unit, follow that product's instructions.

To obtain a clear picture

The player is a high tech, precision device. If the optical pick-up lens and disc drive parts are dirty or worn down, the picture quality becomes poor. To obtain a clear picture, we recommend regular inspection and maintenance (cleaning or parts replacement) every 1,000 hours of use depending on the operating environment. For details, contact your nearest dealer.

Notes on moisture condensation

Moisture condensation damages the player. Please read the following carefully.

Moisture condensation occurs, for example, when you pour a cold drink into a glass on a warm day. Drops of water form on the outside of the glass. In the same way, moisture may condense on the optical pick-up lens inside this unit, one of the most crucial internal parts of the player.

Moisture condensation occurs during the following cases.

- When you bring the player directly from a cold place to a warm place.
- When you use the player in a room where you just turned on the heater, or a place where the cold wind from the air conditioner directly hits the unit.
- In summer, when you use the player in a hot and humid place just after you move the unit from an air-conditioned room.
- When you use the player in a humid place.

Do not use the player when moisture condensation may occur.

If you use the player in such a situation, it may damage discs and internal parts. Remove the disc, connect the power cord of the player to the wall outlet, turn on the player, and leave it for two or three hours, the player will have warmed up and evaporated any moisture. Keep the player connected to the wall outlet and moisture condensation will seldom occur.

Table of Contents

Safety Precautions.....	1	Playing Back a Disc.....	11
Important Safety Instructions.....	2	Locating a Specific Title, Chapter or Track.....	13
Precautions.....	3	Using the On-screen Display.....	13
Introduction.....	4	Playing Repeatedly.....	14
Notes On Discs.....	4	Playing in Random Order.....	14
Identification of Controls.....	5	Zooming a Picture On DVD.....	14
Remote Control.....	5	Selecting Subtitles	14
Connecting with TV.....	6	Playing in a Favorite order.....	15
Connecting with other Video Equipment.....	7	Selecting The Camera Angles/Languages/Audio Settings.....	15
Connecting TV With S-VIDEO /Component Jack, AMP With Digital		MP3 Operation.....	16
Audio Out Jack.....	7	WMA Operation.....	16
Progressive Scan.....	7	Playing Back Your Kodak Picture CD/JPEG.....	16
VCR Playback.....	8	Setting the Parental Lock.....	17
Recording.....	8	Customizing the Function Settings.....	18
Search Function.....	9	Troubleshooting Guide.....	19
VCR Setting.....	9	Specifications.....	20
Tape Handling.....	10	Memo On Output Sounds.....	20
AFF Function.....	11		

Introduction

Your new VCR&DVD PLAYER is designed for you to enjoy all forms of disc media and VHS Tape. Your player will allow you to enjoy full-length motion pictures with "at-the-movies" picture and cinema quality sound. Your new player also supports CD, MP3, and WMA. Your player also has several unique features, including AFF (Active Full Screen Function that allows you to view wide screen movie presentations in full screen mode), S-Video and component video output with Progressive Scan (for greater picture clarity), Parental Control (to prevent children from viewing inappropriate content) and Kodak Picture CD compatibility (so you can view photos on your TV). This is a true multimedia machine designed for the multimedia world to enjoy.



Notes on Discs

HOW TO HANDLE, CLEAN, AND STORE DISCS.

HANDLING DISCS

- Do not touch the playback side of the disc.
- Do not attach paper or tape to discs.



NOTE: The dealer shall not be responsible for damage that may occur to a disc from being operated in the player.

CLEANING DISCS

- Fingerprints and dirt on the disc cause picture and sound deterioration. Wipe the disc from the center outward with a soft cloth. Always keep the disc clean.
- If you cannot wipe off the dirt off, wipe the disc lightly with a slightly moistened soft cloth and finish with a dry cloth.
- Do not use any type of solvent such as a thinner, benzene, commercially available cleaners or anti-static spray for vinyl LP's.



PLAYABLE DISCS

This combo player can playback the following discs.

	Disc Mark	Contains	Disc Size	Maximum playback time
DVD video disc		Audio + Video (moving pictures)	12 cm	Approx. 4 hours (single sided disc)
				Approx. 8 hours (double sided disc)
Audio CD		Audio	12 cm	Approx. 74 minutes
			8 cm (CD single)	Approx. 20 minutes
MP3 CD		Audio	12 cm	Approx. 600+ minutes
Kodak Picture CD		Spec.	12 cm	

STORING DISCS

- Do not store discs in places subject to direct sunlight or near heat sources.
- Do not store discs in places subject to moisture and dust.
- Store discs vertically in a case. Stacking or placing objects on discs outside of their case may cause warping.

NOTES ON REGIONAL NUMBERS

DVDs are divided into separate regions. The United States and Canada are designated as region 1 DVD. Your player plays region 1 DVDs only.

TYPE OF TV SYSTEM

Connect this combo player to a TV with the NTSC system.

Note:

Though every attempt is made to accommodate all supported disc technologies, certain discs may not playback.

The OSD and illustration in this manual may be somewhat different from the actual situation.

Please take the unit as the standard.

UNPACKING

First check and identify the contents of your combo player package, as listed below:

VCR&DVD Player	1
AUDIO cable(red and white)	1
Video cable(yellow)	1
Batteries(AAA)	2
Remote control	1
RF(Radio Frequency)Antenna Cable	1
User's manual	1

If any item should be damaged or missing, please inform your dealer without delay.

Keep the packaging materials, you may need them to transport your player in the future.

WHERE TO PLACE YOUR COMBO PLAYER

- Place the unit on a firm, flat surface.
- When you place this combo player near a radio, or VCR, the playback picture may become poor and/or distorted. In this situation, move the combo player away from the other units.
- If placed in a cabinet, please allow at least 2.5 cm (1 inch) of free space all around the player for proper ventilation.

TO OBTAIN A CLEAR PICTURE

The combo player is a precision device. If the optical pick-up lens, disc drive parts and head are dirty or worn down, picture quality can become poor. We recommend regular inspection and maintenance every 1,000 hours of use depending on the operating environment.

Identification of Controls

FRONT PANEL

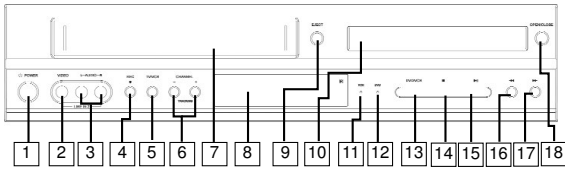

- 1 POWER
- 2 VIDEO INPUT JACK
- 3 AUDIO INPUT JACK
- 4 RECORD
- 5 TV/VCR
- 6 CHANNEL UP/DOWN BUTTON
- 7 VCR DECK
- 8 OPERATION DISPLAY WINDOW
- 9 EJECT
- 10 DVD TRAY
- 11 VCR INDICATOR
- 12 DVD INDICATOR
- 13 DVD/VCR
- 14 STOP
- 15 PLAY/PAUSE
- 16 SKIP REVERSE
- 17 SKIP FORWARD
- 18 OPEN/CLOSE

REAR PANEL

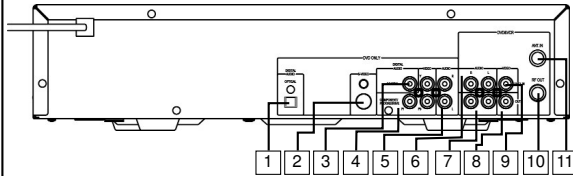

- 1 DIGITAL AUDIO-OPTICAL OUTPUT
- 2 S-VIDEO OUTPUT
- 3 DIGITAL AUDIO-COAXIAL OUTPUT
- 4 COMPONENT/PROGRESSIVE VIDEO OUTPUT Y Pb Pr
- 5 ANALOG AUDIO OUTPUT L R
- 6 ANALOG AUDIO INPUT L R
- 7 ANALOG AUDIO OUTPUT L R
- 8 COMPOSITE VIDEO OUTPUT
- 9 COMPOSITE VIDEO INPUT
- 10 RF OUTPUT
- 11 ANTENNA INPUT

Remote Control

THE DESCRIPTIONS BELOW DESCRIBE THE FUNCTIONS ON THE REMOTE CONTROL.

- | | |
|--------------------------------------|--------------------------------------|
| 1. POWER | 19. OPEN/CLOSE |
| 2. STEP (frame-by-frame slow motion) | 20. ANGLE |
| 3. SUBTITLE | 21. I/P (INTERLACE/PROGRESSIVE SCAN) |
| 4. SHUFFLE | 22. ZOOM |
| 5. REPEAT | 23. AFF |
| 6. AUDIO | 24. DISPLAY |
| 7. A-B REPEAT | 25. REC |
| 8. DVD | 26. TITLE |
| 9. VCR | 27. ENTER |
| 10. SETUP | 28. STOP |
| 11. MENU | 29. SKIP REVERSE |
| 12. DIRECTION BUTTONS | 30. SKIP FORWARD |
| 12. TRACKING | 31. SPEED |
| 12. CHANNEL UP/DOWN | 32. TV/VCR |
| 13. PLAY/PAUSE | 33. COUNTER/CLOCK |
| 14. FAST FORWARD | 34. INPUT SEL |
| 15. FAST REVERSE | 35. CLEAR/RESET |
| 16. PROGRAM | |
| 17. SEARCH | |
| 18. NUMBER BUTTONS | |



- **POWER** button on the remote control is for standby power.
- When "⊘" displayed on TV, function is not operational on the disc.
- **Child Lock!!!**
Press the POWER button of the remote control for about 8 seconds. No buttons of front panel and remote control can be operated now and Lock indicator "⊘" will be displayed on window display. To release child lock, press the POWER button of the remote control for about 8 seconds.

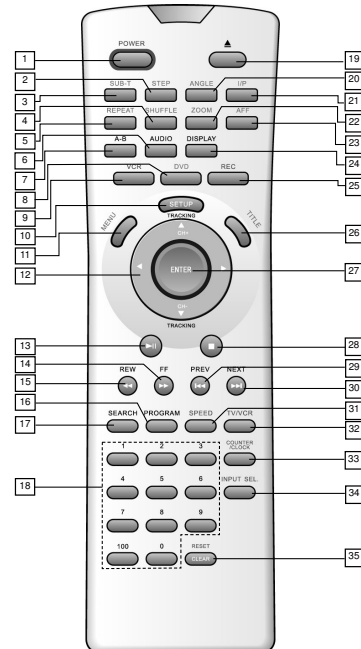

Remote Control (Continued)

PREPARING THE REMOTE CONTROL

To operate the combo player, you must first place the batteries in the remote control.



Open the cover.



Insert batteries (AAA size).

Make sure to match the + and - on the batteries to the marks inside the battery compartment.



Close the cover.

OPERATING WITH THE REMOTE CONTROL

Operating player with the remote control.

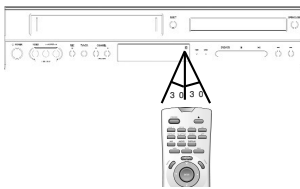

The remote control must point at the remote sensor in order for the remote to function correctly.

Distance: Maximum of 7 m from the front of the remote sensor.

Angle: Approximately 30° from each direction.

**Do not place the remote control under intense light source such as direct sunlight.*

BATTERIES

INCORRECT USE OF BATTERIES MIGHT CAUSE THEM TO LEAK, CORRODE OR EXPLODE.

- Do not place the batteries in the wrong direction.
- It is dangerous to charge, heat, open, or short-circuit the batteries.
- Do not leave dead batteries or mix new with old batteries in the remote control.
- When not using the remote control for a long duration of time, remove the batteries. When operating range becomes reduced, replace batteries.
- If battery leakage occurs, wipe the battery liquid from the battery compartment, then replace batteries.

REMOTE CONTROL

- The remote control should be aimed directly towards the remote sensor of the combo player.

Connecting With TV

When connecting the RF cable to your TV, set your TV to channel 3 or 4 depending on how your TV was originally set up for video inputs.

HOW TO CONNECT WITH RF CABLE OR AV CABLE

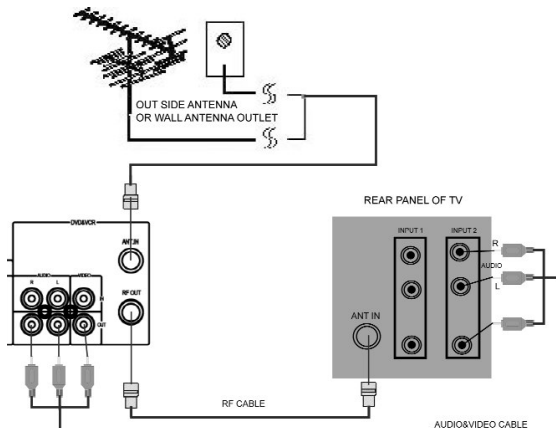

1. Using an RF or AV cable, plug one end of the cable into the cable TV outlet on your wall and the other end into the "ANT.IN" jack on the rear of the Combo Player.
2. Using another RF or AV cable, plug one end of the cable to the "RF OUT" jack on the Combo Player and the other end of the cable to the "ANT.IN" jack on your TV.
3. Using RCA cables, connect the red, white and yellow ends to the corresponding color-coded AV OUT jacks on the Combo Player. Connect the other end of the RCA cables to the corresponding color-coded AV IN jacks on the TV.

By using RCA cables you will enjoy cleaner audio and video.

Connecting With Other Video Equipment

HOW TO CONNECT

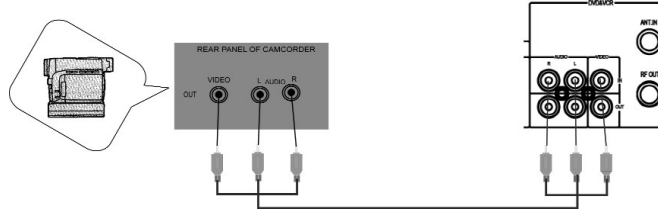

1. Using an AV cable, plug one end of the cable to the AV out jack on your camcorder (or other optional equipment) and plug the other end into the AV IN jack on the Combo Player (AV IN jacks are on both the front and rear of the Combo Player. The rear AV IN jack is AV1 while the front jack is AV2).
2. Select AV1 or AV2 (depending on which jack your camcorder or other optional equipment is plugged into) by pressing the channel + and - buttons.

Connecting TV With S-VIDEO/Component Jack, AMP With Digital Audio Out jack

How to Connect (DVD only)

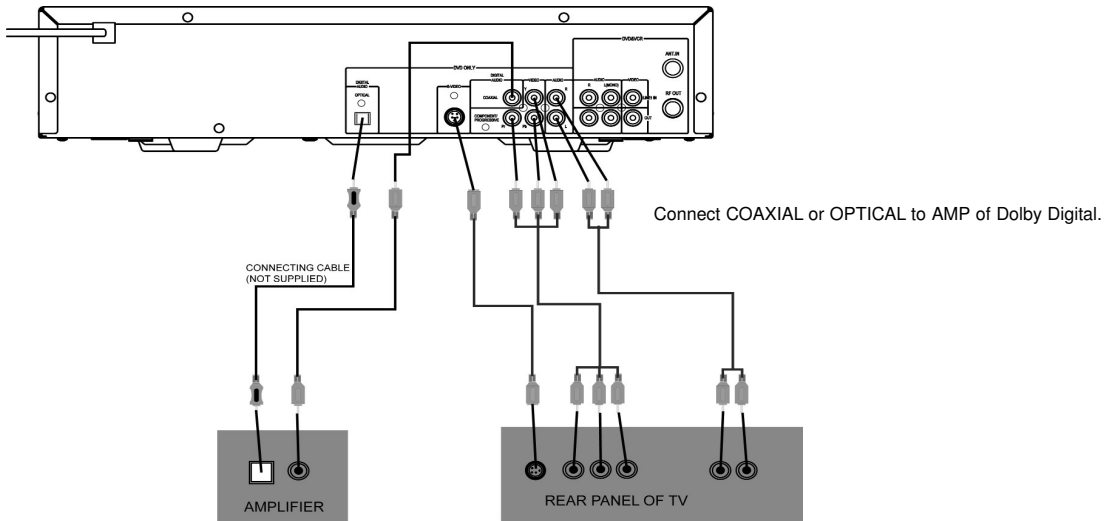

Progressive Scan

WHAT IS PROGRESSIVE SCAN?

With the introduction of Digital/High-Definition TV, televisions can scan viewable information at double the frequency of standard NTSC televisions. This provides for greater picture clarity and detail. This player provides the delivery of images to these newer televisions with greater detail and film like quality. Connect the player to your HDTV ready television using the component video inputs/outputs.

HOW TO SETUP THE VIDEO SCAN MODE?

Connect this Player with Y, Pr and Pb, if your TV has Progressive Scan & Component Video inputs commonly found on HDTV sets. Press I/P button on remote control unit to switch between Interlace & Progressive Scan mode.

It is forbidden by law to copy, broadcast, show, play in public, and rent copyrighted material without permission. DVD video discs are copy protected, and any recordings made from these discs will be distorted.

Manufactured under license from Dolby Labs.

"Dolby" and the double-D symbol are trademarks of Dolby Laboratories. Confidential unpublished works.
© 1992-1997 Dolby Laboratories, Inc. All rights reserved.

"DTS" and "DTS Digital Out" are trademarks of Digital Theater Systems, Inc.

VCR Playback

- 1 Press **POWER** button to power on.
Press **DVD/VCR** button to select VCR mode.
- 2 Insert the desired tape.
- 3 To playback, press **▶||** button.
If the playback picture is partially noisy, adjust with **TRACKING +/-** button on front panel.



- 4 To stop, press **■** button.
- To pause, press **▶||** button in playback mode.
- 5 To playback forward fast or to reverse, press **▶▶** or **◀◀** button, respectively.
- Press **EJECT** button on the front panel or **OPEN/CLOSE** button on remote control to remove the tape
- 6 To monitor Video 1, Video 2, or TV, press **INPUT SEL.** button on remote control.

Recording a Television Show

1. Turn on the Combo Player by pressing the power button.
2. Press the VCR button to change into VCR mode.
3. Turn on your TV and select channel 3 or select AV input.
4. Insert a blank tape or a tape that you wish to record over.
NOTE: VCR tapes have a recording tab that needs to be in place in order to record. If the tab is not in place, you will not be able to record on the tape and the tape will eject when you push the record button.
5. Press the Speed button on your Combo Player's remote to select the desired recording speed (SP or SLP).
6. Select the desired channel that you wish to record by using the **CH+/-** buttons on your Player Combo remote.
7. Press the **REC** button on your Combo Player's remote to begin recording.
8. Press **▶||** button to pause recording, press again to resume. Recording automatically cancels if the Combo Player is left on pause for five minutes.
9. Press the **■** button to stop recording.

WATCHING A DVD WHILE YOU RECORD A VHS VIDEOTAPE

- To playback DVD during recording with video, insert a DVD disc.
- Place the desired DVD disc on DVD tray, press **DVD** button to switch into DVD mode and press **▶||** button.

COPYING DVD DISCS TO VHS VIDEOTAPE

1. Press the **DVD** button to switch to DVD mode.
2. Insert the DVD disc you wish to record.
3. Insert a blank tape or a tape you wish to record over.
4. Press **REC** button.
5. To stop copying, press the **VCR** button and then press the **■** button. If you don't, the VCR will continue recording the DVD disc.
NOTE: This feature will not work with copy protected DVD discs.

This product incorporates copyright protection technology that is protected by method claims of certain U.S. patents and other intellectual property rights owned by Macrovision Corporation and other right owners Use of this copyright protection technology must be authorized by Macrovision Corporation, and is intended for home and other limited viewing uses only unless otherwise authorized by Macrovision Corporation. Reverse engineering or disassembly is prohibited.

RECORDING FROM DIGITAL CABLE OR SATELLITE

1. Follow directions 1-5 under "Recording a Television Show".
2. Turn on your digital cable or satellite receiver and turn the receiver to the channel you wish to record.
3. Press the REC button on your Combo Player's remote to begin recording.
*Please note: when recording from a digital cable or satellite receiver, you will not be able to record one channel and view another. The player must be tuned to channel 3 or 4 and the digital cable or satellite receiver must be tuned to the desired recording channel.

ONE TOUCH TIMER RECORDING(OTR)

One-Touch Recording(OTR) allows you to record in 30-minute increments up to 4 hours at the touch of a button.

1 Start Recording

Follow the instructions on "Recording".

2 Activate OTR

While in Record mode, press the **REC** button again to activate One-Touch Recording(OTR).

3 Add Recording Time

Continue pressing **REC** to add recording time in 30 minute increments up to 4 hours.

•The VCR&DVD PLAYER stops recording automatically when the time has elapsed.

4 Press ■ button to stop recording mode.

Search Function

There are 4 types of search modes you may select to find a segment on your tape.

SEARCH COUNTER ZERO

- Press **DVD/VCR** button to select VCR mode.
- 1 Press the **SETUP** button on the remote control.
- 2. Press the **▼** button to select the "Search", and press **ENTER** button.

- 3. Press **ENTER** button at "Go To Zero Search" to start.
- As soon as the counter searches 0:00:00 , the tape will play automatically.

SEARCH COUNTER

- Press **DVD/VCR** button to select VCR mode.
- 1 Press the **SETUP** button on the remote control.
- 2. Press the **▼** button to select the "Search", and press **ENTER** button.

- 3. Press the **▼** button to select the "Counter Search", and press **ENTER** button.
- 4. Enter the desired time and press **ENTER** button.
- The counter appears on screen and the LED.

SEARCH INDEX FORWARD/BACKWARD

- Press **DVD/VCR** button select VCR mode.
- 1 Press the **SETUP** button on the remote control.
- 2. Press the **▼** button to select the "Search", and press **ENTER** button.
- 3. If your search is forward direction, highlight "Index Search(+)" Index

- searching motion, then press **ENTER** button.
- 4. If your search is backward direction, highlight "Index Search(-)" Index searching motion, then press **ENTER** button.
- The index signal is recorded on the tape automatically when the recording is started. You can view a recording at a specific start point.

SEARCH INDEX NUMBER

- Press **DVD/ VCR** button to select VCR mode
- 1 Press the **SETUP** button on the remote control.
- 2. Press the **▼** button to select the "Search", and press **ENTER** button.
- 3. Press the **▼** button to select the "Index Number Search ", and press **ENTER** button.

- 4. Index NUMBER setting method.
- If your search is forward direction, press up **▲** button to select desired Index Number.
- If your search is reverse direction, press down **▼** button to select desired Index Number.
- 5 After setting up , Please Press **ENTER** Button.

VCR Setting

CLOCK

- Press **DVD/VCR** button to select **VCR** mode and follow the procedures below.
- 1 Press the **SETUP** button on the remote control.
- 2 Press the **ENTER** button, while highlighting **CLOCK SET**.
- 3 Set the current date and time with **▲▼◀▶** button or

- NUMBER button.
- For DATE SET, follow the order of Month/Day/ Year ; for TIME SET, follow the order of Hour/Minute in **CLOCK SET** screen.
- 4 Press **SETUP** button after completion.

PROGRAMMING

- 1 In VCR mode press the **SETUP** button on the remote control .
- 2 Press the **▼** button to select the "Program Set" and press **ENTER** button.
- 3 Select "Channel"
- Move into desired channel signal with up **▲** /down **▼** button and follow the order below.
- cable → video 1 → video 2 → Antenna
- 4 Select "Start Date"
- Move into "Start Date "with **▶** button and then, select the desired number to record with up/down button or number button
- 5 Select "REC cycle".
- Move into "REC Cycle" with **▶** button and then, select the desired one with up/down button
- REC cycle changes like the orders.
- One Time → weekly → weekdays → Daily
- 6 Select Start Time
- Move into "Start Time" with **▶** button and then, select the desired number to record with up/down button or number button.

- 7 Select End time
- Move into "End Time" with **▶** button and then, select the desired number to record with Up/down button or number button.
- 8 Select Tape Speed
- Move into "Tape Speed" with **▶** button and then, select the desired speed with the up/down button.
- Recording speed will appear in the order shown below.
- SP → SLP
- Press **SETUP** button to exit after completion
- Press **NEXT** and **PREV** button to finish 8-event programming.
- Press the **POWER** button to activate timer recording.
- To cancel a program, press the **SETUP** button, then press the **▼** button until "Program Set" is highlighted. Press the **PREV** or **NEXT** buttons on the Combo Player's remote control until you get to the program you wish to cancel. Press the **CLEAR** button on your Combo Player's remote control to cancel the programming.

VCR Setting

CHANNEL

- Operates in stop mode.
- Press **VCR** button to select VCR mode and follow the procedure below.
 - 1 Press the **SETUP** button on the remote control.
 - 2 Press the **▼** button to highlight and select (Enter) the "Channel Set".
 - 3 Selecting cable or antenna viewing
 - You must set the viewing mode for your VCR, choosing either CABLE (cable system connection) or ANTENNA (antenna connection). To set the viewing mode:
 - Press **ENTER** to toggle between CABLE and ANTENNA.
 - 4 SELECT "Manual Set"
 - Move into "Manual set" with **▼** button to select either add/erase and press **ENTER**. Memorize channel and select the desired channel when **ENTER** button is pressed, "Erase" converts into "Add".
 - Press **NUMBER** button and **◀ / ▶** button of remote control to select the desired channel to memorize.
 - To check the memorized channels, press **CH+/-** button on remote control. To delete Channels Manually, when **ENTER** button is pressed, "Add" converts into "Erase". Press **NUMBER** button and **◀ / ▶** button on the remote control to select the desired channel to delete.
 - To check the deleted channels, press **CH+/-** button on remote control.
 - 5 SELECT "Auto Preset"
 - Press **▼** button in Channel Set to highlight "Auto Preset"
 - Press **ENTER** button to detect the channel automatically.

ON-SCREEN MENU LANGUAGE

- 1 Press the **SETUP** button on the remote control. The initial MENU is displayed.
2. Press the **▼** button to select "Language Select" and press **ENTER** button
- 3 Select the language among English, Spanish and French.

SETTING THE OSD DISPLAY

- Press **DVD/VCR** button to select VCR mode
- 1 Press the **SETUP** button on the remote control.
- 2. Press the **▼** button to highlight and select "Option", and press **ENTER** button.
- 3. Press **ENTER** button until the appropriate system is selected. ("On" or "Off")
- 4. Please press **SETUP** button to quit.

AUTO POWER OFF

- Press **DVD/VCR** button to select VCR mode
- 1 Press the **SETUP** button on the remote control.
- 2. Press the **▼** button to select "Option", and press **ENTER** button.
- 3. Press the **▼** button to select "Auto Power Off".
- 4. Press **ENTER** button, until the appropriate system is selected. ("Yes" or "No")
- 5. Press **SETUP** button to quit.

RF OUT

- Press **VCR** button to change into VCR mode
- 1. Press the **SETUP** button on the remote control.
- 2. Press the **▼** button to select "Option", and press **ENTER** button.
- 3. Press the **▼** button to select the "Output Channel".
- 4. Press **ENTER** button, until the appropriate system is selected. ("CH3" or "CH4")
- 5. Press **SETUP** button to quit.

Tape Handling

1. Do not use the following:
 - Tape with mold
 - Tape stained with juice or attachments
 - Disassembled tape
2. Moisture condensation may occur and damage tape. Moisture condensation damages the tape. Please use the tape after the moisture condensation is disappeared.
3. After use, store tape vertically.
4. Do not store in the following places:
 - High temperature and humidity
 - Subject to direct sunlight
 - Near strong magnetic materials such as speakers

AFF Function

WHAT IS AFF?

AFF stands for Active Full-screen Function. It allows you to fill the television screen viewing area when using a wide screen formatted DVD. Press the AFF button on your remote control, as this will eliminate black bars on the top & bottom of the TV screen when viewing movies with an aspect ratio of 1.85:1 and minimize (but not eliminate) black bars on movies with a wider aspect ratio (2.35:1).

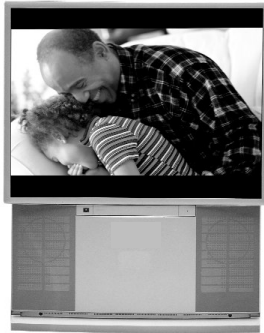

Before AFF



After AFF

Playing Back a Disc

HOW TO PLAYBACK A DISC.

BASIC PLAYBACK

How to playback DVD video discs.

- Turn on the TV and select the video input source connected to the combo player.

1. Press the POWER button on the front panel. Press DVD button of remote control to select DVD mode.

2. Press the OPEN/CLOSE button.



This will open the disc tray.

3. Place the disc on the disc tray.

Be sure the graphics side is up and playback side is faced down.

4. Press the ►| button.

NOTICE:

- A disc may be damaged if not correctly placed on the guides in the disc tray. This may also cause the combo player to malfunction.
- The menu screen will appear automatically or you may access the menu screen by pressing the TITLE button.
- Moving the combo player during playback may cause damage to the disc as well as the player.
- To open and close the disc tray, you should only use the OPEN/CLOSE button on the remote control or combo player.

FOR A HIGHER QUALITY PICTURE

The DVD discs produce a high resolution picture with abundance of information. This may cause some picture noise on the TV during playback. The noise will vary

depending on the TV used with the combo player. To control picture noise, reduce the sharpness adjustment on your TV when viewing DVD discs.

ABOUT DVD, CD

DVD, CD icons will appear depending on the disc being played back.

DVD: DVD video discs

CD: Audio CDs

HOW TO START PLAYBACK FROM THE MENU SCREEN

1. Press ▲/▼/◀/▶ or the number buttons to select the title.
 2. Press the ENTER button.
- The combo player will start playback from the title selected.

HOW TO PAUSE PLAYBACK (STILL PLAYBACK)

Press the ►| during playback.

Press the ►| button to resume normal playback.

HOW TO REMOVE THE DISC

Press the OPEN/CLOSE button.

Wait until the disc tray is completely open before removing any discs. After removing the disc, press the OPEN/CLOSE button to close the disc tray.

Playing Back a Disc (Continued)

HOW TO STOP PLAYBACK

Press the STOP button once.

The combo player is stopped.

Press the ► button to replay.

Press the STOP button twice.

The combo player is stopped completely.

ADVANCED PLAYBACK

The combo player allows you to playback discs at various speeds.

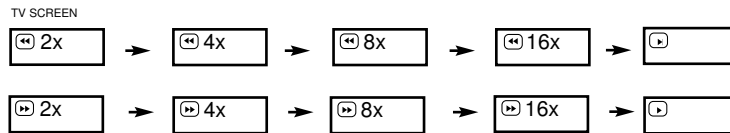

PLAYING AT 2X, 4X, 8X, OR 16X THE NORMAL SPEED

You can play back a disc at 2x, 4x, 8x, or 16x the normal speed.

Press the REW or FF button during playback.

The playback speed becomes 2x the normal speed.

The playback speed changes each time you press the REW or FF button.

REW: Fast reverse ◀◀

FF: Fast forward ▶▶

Press ► to resume normal playback.

PLAYING IN SLOW-MOTION

A disc can be played back in slow-motion.

Press the ▶▶ or ◀◀ button during pause.

Press ► button to resume normal playback.

RESUMING PLAYBACK FROM THE SAME LOCATION

This combo player allows you to stop playback and continue playback later from the same location on the disc.

1. Press the STOP button

This will interrupt the playback and the combo player will memorize the location where you stopped playback.

2. Press the ► button

The combo player will resume the playback from the location where you stopped playback.

NOTICE:

At the completion of each movie a menu screen will appear. Be aware that the on-screen setup menu may damage your TV by permanently burning that image onto the screen. To avoid this, press the STOP button at the completion of each movie. You may also decide to setup the SCREEN SAVER.

NOTICE:

- The combo player may not playback sound during scan reverse or forward playback of DVD video discs. The combo player will play sound during fast forward or fast reverse playback of audio CDs.
- The speeds may vary slightly from disc to disc and the 2x, 4x, 8x, and 16x speeds are only approximate speeds.

NOTICE

- During the slow-motion playback, the sound may not be heard.
- Some discs do not utilize this feature.

NOTICE

- The following action will cancel the RESUME function:
 - Powering off the combo player after you stop playback.
 - Ejecting the disc.
- Depending on the disc, you may experience a different location where playback resumes.
- Certain discs do not utilize this feature.

Locating a Specific Title, Chapter or Track

THE DVD VIDEO DISCS ARE NORMALLY DIVIDED INTO TITLES. THE TITLES ARE SUB-DIVIDED INTO CHAPTERS. MOREOVER, AUDIO CD AND MP3 CD ARE DIVIDED INTO TRACKS. YOU CAN CONVENIENTLY LOCATE ANY SPECIFIC TITLE, CHAPTER, OR TRACK WITH THIS COMBO PLAYER.

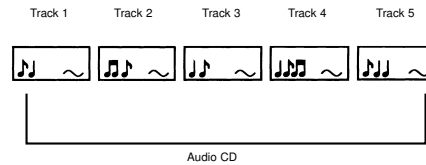
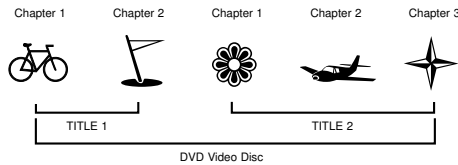

LOCATING A TITLE USING THE TITLE MENU

Locate a specific title using the title menu function, provided a DVD video disc contains a title menu.

1. Press the TITLE button

On the TV screen, the title menu will appear.

2. Press the ▲/▼/◀/▶ buttons to select the title you want.

You can also directly locate a specific title by pressing its assigned number with the number buttons.

3. Press the ENTER button

LOCATING A SPECIFIC CHAPTER OR TRACK

This combo player allows you to locate consecutive chapters or tracks.

Press the SKIP ◀◀ or ▶▶ button repeatedly to display the requested chapter or track.

The combo player starts playback from the selected chapter or track.

How to locate preceding chapters or tracks

- When you press the SKIP ◀◀ button, the combo player

LOCATING A TITLE

You may also locate a specific title by directly selecting a title number.

1. Press SEARCH button during playback.

The menu will appear.

2. Press direction buttons and numbers to select the title and chapter you want.

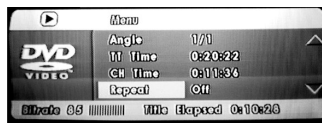
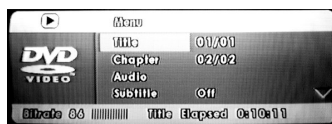

This will cause the combo player to start playback from chapter 1 of the title selected.

NOTICE

- You may find that some discs will not respond to this function.
- If different instructions appear on the TV screen, follow those instructions. The instructions above are describing the basic procedure. Procedures may vary depending on the contents of the DVD video disc.

starts playback from the beginning of the proceeding chapter or track.

How to locate succeeding chapters or tracks

- When you press the SKIP ▶▶ button, the combo player starts playback from the beginning of the succeeding chapter or track.

On certain discs the titles may not display the sub-divided chapters.

3. Move the cursor to select Audio, Subtitle, Angle, TT Time, CH Time, Repeat, Time Disp..

NOTICE

- The displays may vary depending on the discs.
- You may experience a difference in TITLE or MENU display.

Using the On-Screen Display

THE COMBO PLAYER ALLOWS YOU TO VIEW THE OPERATIONAL STATUS AND DISC INFORMATION ON YOUR TV SCREEN.

CHECKING THE OPERATIONAL STATUS

With this function you can view on your TV the following:

-Current title

-Track number

-Total playing time

Press DISPLAY during playback.

Press DISPLAY repeatedly until

DISPLAY OFF appears on TV screen.

Playing Repeatedly

THIS COMBO PLAYER ALLOWS YOU TO PLAYBACK A SPECIFIC TITLE, CHAPTER, TRACK, OR SEGMENT REPEATEDLY. (TITLE REPEAT, CHAPTER/TRACK REPEAT, A-B REPEAT).

HOW TO REPEAT A TITLE, CHAPTER, OR TRACK

1. select the title, chapter, or track you want to repeat.
 2. Press the REPEAT button.
- The repeat mode changes each time you press the REPEAT button.

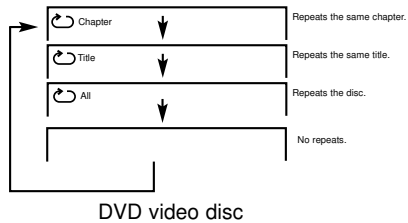

HOW TO REPEAT A SPECIFIC SEGMENT

1. Press the A-B RPT button at the beginning of the segment in which you want to repeat playback. (point A)
2. Press the A-B RPT button again at the end of the segment (point B).

The combo player will automatically return to point A and start to repeat playback of the selected segment (A-B).

3. Press the A-B RPT button to cancel the A-B repeat function.

The combo player will resume to normal playback.

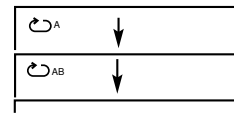

NOTICE:

- Depending on the disc, you may experience a difference between point A and the location where playback actually resumes.
- Be aware that some discs will not respond to the A-B repeat function.

Playing in Random Order

THIS COMBO PLAYER ALLOWS YOU TO PLAYBACK TITLES, CHAPTERS WITHIN A TITLE, OR TRACKS IN RANDOM ORDER. (RANDOM PLAYBACK)

PLAYING TITLES IN RANDOM ORDER

This combo player will automatically choose the titles in a DVD video disc and play them back randomly.

1. Press the SHUFFLE button .
- The combo player will now start random playback.

2. Press the SHUFFLE button again during random playback to resume normal playback.

NOTICE:

- The combo player will go to another chapter or track and start playback if you press the SKIP ►► button during random playback.

Zooming a Picture On DVD

ZOOMING A PICTURE

This combo player allows you to zoom into a picture as well as shift the zoom point.

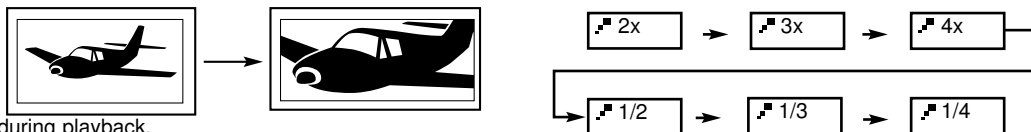

Press ZOOM during playback.

The combo player magnifies in the center of the picture.

If you press ▲/▼/◀/▶ during zoom playback, the zoom point will shift.

Press ZOOM repeatedly during zoom playback until the player resumes normal playback.

Selecting Subtitles

THIS COMBO PLAYER ALLOWS YOU TO DISPLAY THE SUBTITLES FROM THOSE INCLUDED ON THE DISC, ON TO YOUR TV SCREEN.

HOW TO DISPLAY SUBTITLES

You have the option to select a preferred subtitle from those included on the DVD video disc.

Press the SUB-T button during playback.

Press the SUB-T during playback until SUBTITLE OFF appears.

NOTICE

- With some DVDs, you may not be able to turn off the subtitles and they will appear on screen automatically.
- As you press the SUB-T button, the subtitles may not appear immediately during some scenes.
- If the subtitles continue to show on your TV even after the DVD has been turned off, please refer to the TV's close caption settings.

Subtitle	↓	01/02 : English
Subtitle	↓	02/02 : French
Subtitle Off		

Playing in a Favorite Order

COMBINE YOUR FAVORITE TITLES, CHAPTERS, OR TRACKS AND PLAY THEM BACK IN ANY ORDER.(PROGRAM PLAYBACK)

HOW TO SET TITLES, CHAPTERS, OR TRACKS IN A FAVORITE ORDER

The program playback function will automatically playback titles, chapters or tracks in the order preprogrammed.

1. Insert a disc, then press the **PROGRAM** button.
At this time, the menu will appear.

Program: TT(XX) CH(XX)	
01 TT: CH:	06 TT: CH:
02 TT: CH:	07 TT: CH:
03 TT: CH:	08 TT: CH:
04 TT: CH:	09 TT: CH:
05 TT: CH:	10 TT: CH:
Exit	NEXT

2. Using the numbered button, select the items in the order you want them programmed in.

Program: TT(XX) CH(XX)	
01 TT:05 CH:12	06 TT: CH:
02 TT:02 CH:07	07 TT: CH:
03 TT:04 CH:07	08 TT: CH:
04 TT: CH:	09 TT: CH:
05 TT: CH:	10 TT: CH:
Exit	Start NEXT

To clear the numbers that you have programmed in just now, press CLEAR button.

3. Select **START** from the menu, then press the **ENTER** button.

The combo player starts memory playback.

To CHANGE the programmed item:
Press the STOP button, then follow step 1.

To CANCEL the programmed item:
Press the STOP button, then press the **▶** button.

- When the combo player is turned off, or if the disc is removed, the program item will be removed.
- Depending on the disc, the program playback may not function.

Selecting The Camera Angles/ Languages / Audio Settings

THIS COMBO PLAYER ALLOWS YOU TO SELECT FROM SEVERAL DIFFERENT ANGLES AND LANGUAGES.

HOW TO CHANGE THE CAMERA ANGLE

Press the **ANGLE** button while playing back a scene recorded with multiple angles.

Each time you press the ANGLE button, the angle will change.

NOTICE

- The angle function will not work on DVD video discs that do not contain recorded multiple angles.
- The angle icon indicator will illuminate while playing back a title that contains at least one scene recorded with multiple angles.

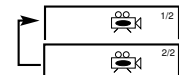

Selecting the camera angle

HOW TO SELECT A PLAYBACK AUDIO SETTING

This combo player allows you to select a preferred language and sound recording system from those included on the DVD video disc.

1. Press the **AUDIO** button during playback.
2. Press the **AUDIO** button again to cycle backwards.

NOTICE

- The player returns to the initial default settings, when you turn on the combo player or replace a disc.

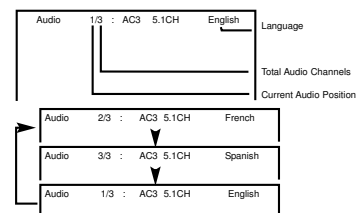

Selecting a language

MP3 Operation

WHAT IS MP3?

MP3 refers to a format of music files available for playback over the internet.

PLAYING An MP3 FORMAT

1. To play you must view through your television. Insert an MP3 CD, the combo player will initialize the disc when the tray is closed and the directory (folder) will be shown in an MP3 MENU on screen.
2. Press ◀/▶ then the ▲/▼ key to select and highlight an MP3 file (song). Press ENTER to play.



WMA Operation

WHAT IS WMA?

WMA refers to a new format of music files from Microsoft available for playback from WMA web sites. The compression used allows you to record from your computer up to 22 hours of music on CD-R and play back through your combo player.

PLAYING A WMA FORMAT

1. To play you must view through your television. Insert a WMA CD, the combo player will initialize the disc when the tray is closed and the directory (folder) will be shown in a WMA MENU on screen.
2. Press ◀/▶ then the ▲/▼ key to select and highlight a WMA file (song). Press ENTER to play.

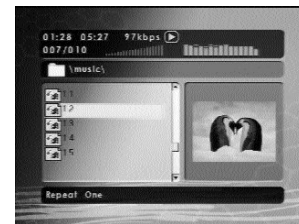

Playing Back Your Kodak Picture CD/JPEG

NORMAL

When a Kodak Picture CD/JPEG is inserted, an automated slideshow is launched, each picture in the current directory will be displayed consecutively in a slideshow fashion and will be scaled to fit most of the TV screen. Fifteen slideshow transition modes are provided. Use "PROGRAM" key to select: **Customers can set "transition" effects for every picture at any time during the slideshow.**

- | | |
|------------------------------------|-----------------------------------|
| NONE:(by default) | mode 9: EXTEND FROM CENTER H |
| mode 1: WIPE TOP | mode 10: EXTEND FROM CENTER V |
| mode 2: WIPE BOTTOM | mode 11: COMPRESS TO CENTER H |
| mode 3: WIPE LEFT | mode 12: COMPRESS TO CENTER V |
| mode 4: WIPE RIGHT | mode 13: WINDOW H |
| mode 5: DIAGONAL WIPE LEFT TOP | mode 14: WINDOW V |
| mode 6: DIAGONAL WIPE RIGHT TOP | mode 15: WIPE FROM EDGE TO CENTER |
| mode 7: DIAGONAL WIPE LEFT BOTTOM | RANDOM |
| mode 8: DIAGONAL WIPE RIGHT BOTTOM | |

To display an image indefinitely, press the ▶| key. To view the Next or Previous picture press the **SKIP FORWARD** or **SKIP REVERSE** key.

IMAGE ROTATION

There are four modes to rotate a picture: "Invert", "Mirror", "Left", and "Right". These operations are allowed only when a picture is being displayed normally, and will be cancelled automatically when a new picture is displayed. The direction buttons are used to select the different transformation modes:

- | | |
|-----------------------|---------------------|
| Up ▲ -Invert/Normal | Left ◀ -Turn left |
| Down ▼ -Mirror/Normal | Right ▶ -Turn right |

ZOOM

This features allows you to view a picture at 50%-200% in several increments. Press the **ZOOM** button. An on screen message ("**Zoom 100%**") will verify your selection. Use ▶▶ and ◀◀ keys to control the zoom level. Press the direction keys to move the picture in any direction. . Note: When in the ZOOM mode, the slideshow transition and image transformation features are disabled.

Setting the Parental Lock

YOU CAN USE THE PARENTAL LOCK FUNCTION ONLY WITH DVD VIDEO DISCS EQUIPPED WITH THE PARENTAL LOCK FEATURE.

SETTING THE PARENTAL LOCK

DVD video discs equipped with the parental lock function are rated according to their content. The contents allowed by a parental lock level and the way a DVD video disc can be controlled may vary from disc to disc. For example, if the disc allows, you can edit out violent scenes unsuitable for children and replace them with more suitable scenes, or lock out playback of the disc all together.

1. Press STOP twice during playback.

2. Press SETUP

The SETUP MENU appears on the TV screen.



3. Select Preference Page, press ENTER.

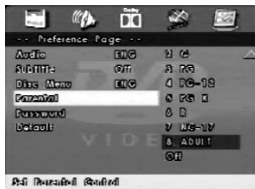

4. Select PARENTAL, press direction buttons. Select Parental, press ENTER.

5. Enter your password then press ENTER.

The preset password is **3308**



TO CHANGE YOUR PASSWORD:

1. Follow step 3 to select password, select Change.

2. Enter old password.

3. Enter new password.

4. Re-enter to confirm your new password.

5. Press ENTER.

6. Press SETUP.

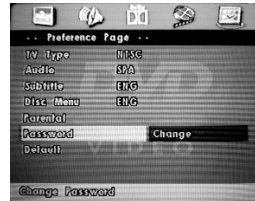

Customizing the Function Settings

THIS COMBO PLAYER ALLOWS YOU TO CUSTOMIZE THE PERFORMANCE TO YOUR PERSONAL PREFERENCE.

DISPLAYING THE SETUP MENU SCREEN

The SETUP MENU screen asks you to select a setting category from General Setup, Speaker Setup, Dolby Digital Setup, Video Setup and Preferences. The selected category will provide you the setting details on-screen.

1. Press **SETUP**.
2. Press **▲/▼/◀/▶** to select category (highlight), then press **ENTER**.
3. Press **SETUP** to exit.

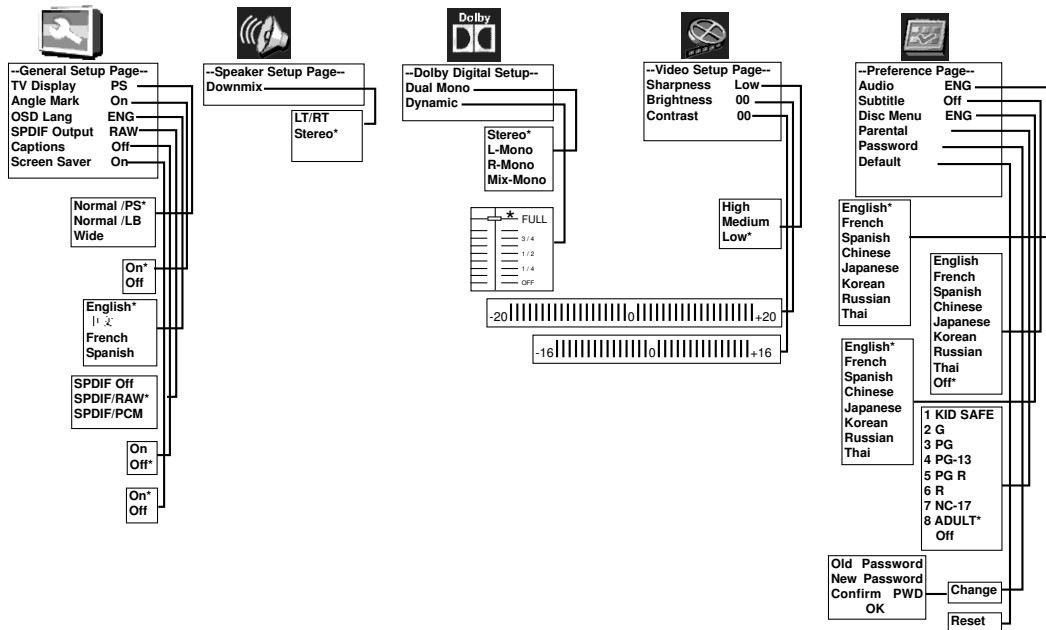

NOTICE

- Preset password is **3303**.
- The SETUP MENU screen disappears if you press the SETUP button while it is displayed.
- Any button can disable Screen Saver except the POWER button. After that, you can press some button to make the relative operation.
- Functions and menu are subject to change without notice.
- You must remove any/all disc from the player in order to access **Preference Page**.
- * Factory defaults

Troubleshooting Guide

SYMPTOMS & CORRECTION

D V D V C R	No power	<ul style="list-style-type: none"> • Connect the power plug into the wall outlet securely. • Check if the child lock is released.
	The player does not respond to the remote control.	<ul style="list-style-type: none"> • Check if the power plug is connected to an AC outlet. • Check the batteries in the remote control. • Aim the remote control directly at the remote sensor. If necessary, remove all of the obstacles between the sensor and the remote. • You have to be within 7m of the player.
	No picture	<ul style="list-style-type: none"> • Verify the connection from the video output of the player to the TV video input. Then switch TV to appropriate mode. • Connect the video cable into the jacks securely. Refer to your television owners manual. • Verify the video connection between your TV and the Combo Player. Make sure your TV channel is set to channel 3 or AV INPUT. For more details, refer to your TV manual.
	Have sound but no picture	<ul style="list-style-type: none"> • Press I/P button on the Combo Player's remote control.
	No sound	<ul style="list-style-type: none"> • Connect the audio cables into the jacks securely. • Verify the connection from the DVD audio output to the TV or receiver audio input. Then switch to the appropriate source on the receiver. Refer to your audio amplifier owners manual.
	LED no playtime display	<ul style="list-style-type: none"> • Check if the player is in VCR mode or DVD mode. • Check if the player is in counter status. Press the COUNTER/CLOCK button to switch.
V C R	Timer recording failure	<ul style="list-style-type: none"> • Make sure the timer recording is set correctly. • Make sure power is off. • Make sure the DVD/VCR is set correctly.
	Cannot go into Record mode.	<ul style="list-style-type: none"> • Make sure the tape has a safety tab. If needed, cover the hole with scotch tape.
	Playback picture is partially noisy	<ul style="list-style-type: none"> • Adjust tracking control for a better picture by pressing the TRACKING +/- button.
	Cannot view a tape but the audio is OK.	<ul style="list-style-type: none"> • Head cleaning may be necessary.
	No or poor playback picture	<ul style="list-style-type: none"> • Select channel 3 or 4 on your TV. • Fine tune your TV.
	TV programs cannot be seen normally.	<ul style="list-style-type: none"> • Check the ANT.IN and RF OUT connections. • Press the VCR button on the remote control.
	Video or color fades in and out when making a copy of a video tape.	<ul style="list-style-type: none"> • You cannot copy a copyrighted video tape. You are experiencing copy guard protection.
	Cannot remove the tape	<ul style="list-style-type: none"> • Check if the player is in the VCR mode. If not, press the VCR button to switch the mode.
D V D	Black & White picture	<ul style="list-style-type: none"> • Damaged S-Video connector (bent pin)
	The playback picture has occasional distortion	<ul style="list-style-type: none"> • A small amount of picture distortion may appear because of a poor quality video/sound transfer to disc. This is especially true of some discs manufactured between 1997-1998. • Scratched disc
	Brightness is unstable or noises are produced on playback pictures	<ul style="list-style-type: none"> • Connect the player directly through the TV and not through any other source. What you're viewing is the effect of the copy protection circuitry required on all DVD players.
	The combo player does not start playback	<ul style="list-style-type: none"> • Place the disc with the graphics side up. • Place the disc on the disc tray correctly inside the guide. • Make sure the disc is free from scratches & fingerprints. • Press the SETUP button to turn off the menu screen. • Cancel the parental lock function or change the parental lock level. (<i>The Pre-set password is 3308.</i>) • Turn the power off then disconnect the power plug and reinsert it back into the wall. Retry again. • Use region 1 discs only.
	MP3 won't read disc or it skips	<ul style="list-style-type: none"> • Reburn disc as the software edition used may not be compatible with the player. Check web site for instruction.

If our troubleshooting guide doesn't help, give us a call. For service, support and warranty information, visit www.polaroidelectronics.com or in the US call 1-866-289-5168 and in Canada call 1-866-301-7922.

WARNING: Opening the back cover of your Combo Player will void the warranty.

Specifications

Power supply	120V~ 60 Hz
Power consumption	25W
Weight (Approx.)	5.4 kg
External dimensions	430 x 91 x 355.5 mm (W/H/D)
Signal system	NTSC
Operative temperature	+5°C~35°C
Installation condition	Horizontal/Relative humidity under 80%
Received channels	VHF:2-13 CH / UHF:14-69 CH/Cable:1-125
RF Input/output	U/V-mixed:75 Ω unbalanced
Video input	1.0 V (p-p), 75 Ω unbalanced RCA JACK
Audio input	-8.8 dBm,RCA JACK
RF output	3 or 4 CH
Video output	1.0 V (p-p), 75 ohms RCA JACK
S video output	(Y) 1.0 V (p-p), 75 ohms negative sync., Mini DIN 4-pin x 1 (C) 0.286 V (p-p), 75 ohms
Component video output	(Y)1.0V (p-p), 75 ohms (Pb)0.7V (p-p), 75 ohms (Pr)0.7V (p-p), 75 ohms
Audio output(DVD analog audio)	1.8±0.2V(p-p)(rms),10k ohms, pin jack(L,R)x 1
Audio output(VCR analog audio)	-8.8 dBm,RCA JACK
Playable tape	Very high dense tapes with VHS marks
Tape speed	SP:33.35mm/s, SLP:11.12mm/s
Playtime	SP:2hrs, SLP:6hrs(use of T-120 tape)
Clock display	12 hrs AM/PM
FF/REW time(VCR)	<220 seconds (T-120 tape)

Memo On Output Sounds

DISCS AND OUTPUT SOUNDS

Sound recording system	DVD Video Discs											CD		MP3 CD	
	Dolby Digital			MPEG 2			Linear PCM					PCM44.1kHz		MP3	
	SPDIF /RAW	SPDIF /PCM	ANALOG	SPDIF /RAW	SPDIF /PCM	ANALOG	48kHz		96kHz			SPDIF /RAW	ANALOG	SPDIF /RAW	ANALOG
Audio setting on the setting screen	SPDIF /RAW	SPDIF /PCM	ANALOG	SPDIF /RAW	SPDIF /PCM	ANALOG	SPDIF /RAW	ANALOG	SPDIF /RAW	SPDIF /PCM	ANALOG	SPDIF /RAW	ANALOG	SPDIF /RAW	ANALOG
ANALOG AUDIO OUT jacks	—	—	o	—	—	o	—	o	—	—	o	—	o	—	o
DIGITAL AUDIO OUT jack	Dolby Digital bitstream	PCM (48kHz)	—	MPEG 2 bitstream	PCM (48kHz)	—	PCM (48kHz)	—	PCM (48kHz)	—	—	PCM (44.1kHz)	—	PCM (44.1kHz)	—

MPEG 1 AUDIO LAYER 3 DISC (MP3)

MP3 Audio Disc Play Back Capable	MP3 audio disc can be played back by operating the unit in the same way as the audio CD.
----------------------------------	--

English

For service, support and warranty information, visit www.polaroidelectronics.com or in the US call 1-866-289-5168, in Canada call 1-866-301-7922 and in Mexico call 01-800-400-2443.

“Polaroid” is a registered trademark of Polaroid Corporation of Waltham, MA USA and licensed for use on the DVC-2010 to Petters Consumer Brands, LLC.

French

Pour les informations concernant l'entretien, l'assistance et la garantie, visiter www.polaroidelectronics.com ou appeler le 1-866-289-5168 aux États-Unis et le 1-866-301-7922 au Canada. Au Mexique appeler le 01-800-400-2443.

«Polaroid» est une marque déposée de Polaroid Corporation, Waltham, MA, États-Unis, et dont l'usage est autorisé pour le DVC-2010 auprès de Petters Consumer Brands, LLC.

Spanish

Para información relacionada al mantenimiento, soporte y garantía, visite www.polaroidelectronics.com o, en los Estados Unidos, llame al 1-866-289-5168. En Canadá, llame al 1-866-301-7922. En México llame al 01-800-400-2443.

“Polaroid” es una marca registrada de Polaroid Corporation, Waltham, MA, USA. Petters Consumer Brands, LLC, ha sido autorizado para usarla en el DVC-2010.