

Digital Video Disc Player & Video Cassette Recorder Owner's Manual

DVD741VR



Important!
Return your
Warranty
Registration Card
within 10 days.
See why inside.



Read this manual first!

Congratulations on purchasing this Philips product. We've included everything you need to get started. If you have any problems, Philips Representatives can help you get the most from your new product by explaining:

- Hookups,
- First Time Setup, and
- Feature Operation.

Do not attempt to return this product to the store.

**For fast help, call us first!
1-800-531-0039**

Thank you for making Philips a part of your home!

Let's make things better.



PHILIPS

Return your Warranty Registration card today to ensure you receive all the benefits you're entitled to.

Once your PHILIPS purchase is registered, you're eligible to receive all the privileges of owning a PHILIPS product. So complete and return the Warranty Registration Card enclosed with your purchase at once. And take advantage of these important benefits.

Warranty Verification

Registering your product within 10 days confirms your right to maximum protection under the terms and conditions of your PHILIPS warranty.

Owner Confirmation

Your completed Warranty Registration Card serves as verification of ownership in the event of product theft or loss.

Model Registration

Returning your Warranty Registration Card right away guarantees you'll receive all the information and special offers which you qualify for as the owner of your model.

PHILIPS

Congratulations on your purchase, and welcome to the "family!"

Dear PHILIPS product owner:

Thank you for your confidence in PHILIPS. You've selected one of the best-built, best-backed products available today. And we'll do everything in our power to keep you happy with your purchase for many years to come.

As a member of the PHILIPS "family," you're entitled to protection by one of the most comprehensive warranties and outstanding service networks in the industry.

What's more, your purchase guarantees you'll receive all the information and special offers for which you qualify, plus easy access to accessories from our convenient home shopping network.

And most importantly you can count on our uncompromising commitment to your total satisfaction.

All of this is our way of saying welcome-and thanks for investing in a PHILIPS product.

Sincerely,



Lawrence J. Blanford
President and Chief Executive Officer

P.S. Remember, to get the most from your PHILIPS product, you must return your Warranty Registration Card within 10 days. So please mail it to us right now!



Know these safety symbols



⚡ This "bolt of lightning" indicates uninsulated material within your unit may cause an electrical shock. For the safety of everyone in your household, please do not remove product covering.

⚠ The "exclamation point" calls attention to features for which you should read the enclosed literature closely to prevent operating and maintenance problems.

WARNING: TO PREVENT FIRE OR SHOCK HAZARD, DO NOT EXPOSE THIS EQUIPMENT TO RAIN OR MOISTURE.

CAUTION: To prevent electric shock, match wide blade of plug to wide slot, fully insert.

ATTENTION: Pour éviter les choc électriques, introduire la lame la plus large de la fiche dans la borne correspondante de la prise et pousser jusqu'au fond.

For Customer Use

Enter below the Serial No. which is located on the rear of the cabinet. Retain this information for future reference.

Model No. _____
Serial No. _____



PHILIPS

Visit our World Wide Web Site at <http://www.philips.com>

Safety and General Information 3

Safety Precautions

Warning: To prevent fire or shock hazard, do not expose this equipment to rain or moisture.

Federal Communications Commission (FCC) Warning: Any unauthorized changes or modifications to this equipment void the user's authority to operate it.

Department of Health and Human Services (DHHS) Certification: Complies with 21 Center for Radiation (CFR) chapter I subchapter J applicable at time of manufacture.

Laser Safety: This unit employs a laser. Only a qualified service person should remove the cover or attempt to service this device, due to possible eye injury.

CAUTION: USE OF CONTROLS OR ADJUSTMENTS OR PERFORMANCE OF PROCEDURES OTHER THAN THOSE SPECIFIED HEREIN MAY RESULT IN HAZARDOUS RADIATION EXPOSURE.

CAUTION: VISIBLE AND INVISIBLE LASER RADIATION WHEN OPEN AND INTERLOCK DEFEATED. DO NOT STARE INTO BEAM. THE BEAM IS LOCATED INSIDE, NEAR THE DECK MECHANISM.

Special Information for Canadian Users: This Class B digital apparatus complies with Canadian ICES-003. Cet appareil numérique de la classe B est conforme à la norme NMB-003 du Canada.

Radio/TV Interference: This equipment has been tested and found to comply with the limits for a Class B digital device, pursuant to Part 15 of the FCC Rules. These limits are designed to provide reasonable protection against harmful interference in a residential installation. This equipment generates, uses, and can radiate radio frequency energy and, if not installed and used in accordance with the instructions, may cause harmful interference to radio communications. However, there is no guarantee that interference will not occur in a particular installation. If this equipment does cause harmful interference to radio or television reception, which can be determined by turning the equipment off and on, the user is encouraged to try to correct the interference by one or more of the following measures:

- 1) Reorient or relocate the receiving antenna.
- 2) Increase the separation between the equipment and the receiver.
- 3) Connect the equipment into an outlet on a circuit different from that to which the receiver is connected.
- 4) Consult the dealer or an experienced radio/TV technician for help.

Copyright Protection: Unauthorized copying, broadcasting, public performance and lending of Discs are prohibited. This product incorporates copyright protection technology that is protected by method claims of certain U.S. patents and other intellectual property rights owned by Macrovision Corporation and other rights owners. Use of this copyright protection technology must be authorized by Macrovision Corporation and is intended for home and other limited viewing uses only unless otherwise authorized by Macrovision Corporation. Reverse engineering or disassembly is prohibited.

Note to the Cable TV System Installer: This reminder is provided to call the Cable TV system installer's attention to Article 820-40 of the National Electrical Code, which provides guidelines for proper grounding – in particular, specifying that the cable ground shall be connected to the grounding system of the building, as close to the point of cable entry as possible.

High Quality: This VCR of the DVD/VCR has a High Quality (HQ) system and is compatible with Video Home System (VHS) equipment.

Declaration of Conformity

Model Number: DVD741VR
Trade Name: Philips
Responsible Party: Philips Consumer Electronics
P.O. Box 14810
Knoxville, TN 37914-1810
(865) 521-4316

Manufactured under license from Dolby Laboratories. "Dolby" and the double-D symbol are trademarks of Dolby Laboratories. Copyright 2002 Philips Consumer Electronics. All rights reserved.

4 Table of Contents

General Information		Disc Playback Features	
Safety and General Information	3	Disc Menus	48
Table of Contents	4	Fast Forward/Reverse Search	49
Introduction	5	Specific Title/Chapter Playback, Specific Time Playback	50
Playable Discs and Video Cassettes	6	Specific Track Playback	51
Initial DVD/VCR Setup		Paused and Step-by-Step Playback, Resuming Playback	52
Hookups	7-13	Repeat, A-B Repeat	53
Remote Control Setup	14	Markers	54
First-time DVD/VCR Setup	15	Subtitles, Camera Angles	55
Basic Playback		Parental Controls Password	56
Video Cassette Playback	16	Parental Controls Levels	57
Disc Playback	17	Audio Language	58
Basic DVD/VCR Controls		Slow Motion, Zoom	59
Display Panel (DVD)	18	Programmed Playback	60
Display Panel (VCR)	19	Random Playback, Stereo Sound Mode	61
Front Panel	20	MP3 Playback	62
Rear Panel	21	MP3 Display Information, MP3 Track Selection	63
Remote Control Buttons	22-23	Random MP3 Playback, Programmed MP3 Playback	64
Additional VCR Setup		DVD Player Setup Options	
Channel Setup	24-26	On-Screen Displays	65
Clock (VCR)	27	Display Settings	66-67
Daylight-Savings Time	28	Language Settings	68-69
Language Selection (VCR)	29	Audio Settings	70
VCR On-Screen Status Displays	30	Black Level Settings, TruSurround Setting	71
VCR Recording Options		Information You May Need	
Video Cassette Recording	31	Care and Maintenance/Specifications	72
Recording One Channel/Watching Another	32	Glossary	73
One-Touch Recording	33	Helpful Hints	74-77
Timer Recording	34-37	Limited Warranty	78-79
Rerecording (Tape Duplication)	38	Information Index	80
Video Cassette Playing Options			
Repeat Play	39		
Real-time Tape Counter Memory	40		
Time Search	41		
Special Effects Playback	42		
Automatic Operation Features	43		
Additional VCR Features			
Multi-Channel Television Sound	44-45		
Hi-Fi Stereo Sound	46		
Blue Background	47		

Introduction 5

Welcome!

This DVD/VCR combines a Digital Video Disc (DVD) Player and a Hi-Fi Video Cassette Recorder (VCR) into one unit, letting you play DVDs, Audio Compact Discs (Audio CDs), and Video Cassettes on one piece of equipment.

Read this owner's manual carefully to learn how to use the features listed below.

Features

VCR

- Automatic Channel Setup
- Automatic Head Cleaner
- Daylight-Savings Time
- English/French/Spanish displays
- Multi-Channel TV Sound
- 19 Micron head
- Real-Time Tape Counter
- Recording: One-Touch and Timer
- Repeat Play
- Searching: Time, Forward, and Reverse
- Slow Motion
- Still Picture
- Tracking Adjustment

DVD

- Audio Language choices*
- Bit Rate display
- Camera Angle *
- Display Panel and Dimmer
- Dolby Digital Sound
- Dynamic Range Control
- Fast/Paused/Slow/Step-by-Step Playback

AUDIO CD

- Markers
- Parental Lock*
- Program Playback (Audio CD, MP3)
- Random Playback (Audio CD, MP3)
- Repeat (A-B, Chapter, Title, Track, Disc)

MP3

- Screen Saver
 - Search (Title/Chapter, Time, Track)
 - SRS TruSurround
 - Subtitles*
 - Zoom Playback
- * If available on the DVD

Package Contents

The following items are provided with your new DVD/VCR.

- Remote Control and two AA batteries
- One black RF coaxial cable, 75 ohm
- One set of Audio (red and white tips) and Video (yellow tips) cables

When referring to this manual, remember...

VCR

Indicates the feature is available on Video Cassettes when the DVD/VCR is in VCR mode.

DVD

Indicates the feature is available on some Digital Video Discs when the DVD/VCR is in DVD mode.

AUDIO CD

Indicates the feature is available on some Audio CDs when the DVD/VCR is in DVD mode.

MP3

Indicates the feature is available with MP3 files when the DVD/VCR is in DVD mode.

DVD Disc Menus...

Some explanations in this manual describe DVD Disc menus. DVD manufacturers set the menus, which vary among DVDs. All DVDs do not have menus. If the DVD has a menu, access the DVD Disc menu by pressing DVD, then DISC/MENU on the remote control. Details are on page 48.

DVD Player Setup Menu...

Some instructions explain how to use the DVD Player's Setup menu to set up features of the DVD Player or a DVD. Access the DVD Player menu by pressing SETUP on the remote control when playback is stopped. Even if a feature is set in the DVD Player's menu, it may not be available if the current DVD does not include that feature.

Available Disc Features...



All features described in this manual are not available on every Disc. If the feature is not available on the Disc, you cannot use the DVD/VCR to make it available. An "X" will appear in the top right corner of the TV screen if you try to access a feature that is not currently available.

6 Playable Discs and Video Cassettes

Playable Discs

The DVD Player will play Digital Video Discs (DVDs), Audio Compact Discs (CDs), and some finalized Digital Video Discs Rewritable (DVD+RW) and Compact Discs Rewritable (CD-RW). The DVD Player can play MP3 files recorded on a CD-RW as well.

To play a DVD, make sure it meets the requirements for Region Codes and Color Systems as described below.

Discs that have the following logos will play on the DVD Player.



DVD



DVD



Audio CD



CD-RW



DVD+ReWritable

DVD+RW

Region Codes

This DVD/VCR has a Region One (1) DVD Player. DVDs must be labeled for ALL regions or for Region 1 in order to play on the DVD Player. You can not play DVDs that are labeled for other regions. Look for the symbols below on your DVDs. If these region symbols do not appear on your DVD, you cannot play the DVD in this DVD Player.



The number inside the globe refers to a region of the world. Region 1 represents the United States, Canada, upper regions of North America, Bermuda, the U.S. Virgin Islands, and small regions near Australia.

A DVD labelled for a specific region can only play on DVD Players with the same region code.

Color Systems

DVDs are recorded in different color systems throughout the world. The most common color systems are NTSC (which is used primarily in the United States and North America), PAL, and SECAM.

This DVD Player uses NTSC, so DVDs you play must be recorded in the NTSC system. You cannot play DVDs recorded in other formats. The color system of the DVD may be listed on the DVD or on the Disc case.

Unacceptable Discs

If you insert an unacceptable Disc, "Please insert a playable disc" will appear on the TV screen. (Also, "- - - -" will appear on the display panel.) The following Discs will not play on this DVD Player.

- CD-ROM
- DVD-RAM
- DVD-ROM
- Super Audio CD (SACD) (The Audio CD layer of a hybrid SACD may play.)
- Compact Disc-Interactive (CD-I)
- Photo CD
- Video Single Disc (VSD)

Audio of the following discs might play, but video will not be accessible.

- Compact Disc-Graphic (CD-G)
- Compact Disc-Video (CD-V)

Playable Video Cassettes

The VCR of this DVD/VCR has a High Quality (HQ) system and is compatible with existing Video Home System (VHS) equipment. Philips recommends you use only Video Cassettes that have the **VHS** mark. The use of other tapes may result in poor picture quality and excessive deposits on the video heads, which may not be covered by the warranty if damage occurs.

The VCR also has a 19 micron head, which provides a better picture when you view tapes recorded in slow speed (SLP).

Hookups 7

Determining the best possible connection...

Your hookup will be determined primarily by your existing equipment, especially your TV. However, the following guidelines describe which options have the best picture (video) and sound (audio) quality.

- ★★★★ If your television has Component Video In jacks (which also could be labelled Y Cr Cb, Y Pr Pb, or YUV and may be green, blue, and red), use the Component Video jacks (Y Cr Cb) for the best picture quality.
If you use only this video connection, only the DVD features of the DVD/VCR will be available. To see DVD features on the TV, set the TV to its Component Video In channel. *Details are on page 12.*
- ★★★ If your TV has S-Video In jacks (which also may be labelled Y/C or S-VHS), use the S-Video jack for excellent picture quality. If you use only this video connection, only the DVD features of the DVD/VCR will be available. To see DVD features on the TV, set the TV to its S-Video In channel. *Details are on page 11.*
- ★★ If your TV has a single yellow Video In jack (which also may be labelled CVBS, Composite, or baseband), use the yellow Video jack for good picture quality. This connection allows you to use both the DVD and VCR features. To see DVD or VCR features on the TV, set the TV to its Video In channel. *Details are on page 11.*
- ★★ If your TV only has an RF-style jack, usually labelled Antenna In, RF In, or 75 ohm, use the ANT-OUT jack of the DVD/VCR to connect to the TV. Set your TV to channel 3 or 4 - the same channel to which the CH3/CH4 switch of the DVD/VCR is set. This connection allows you to use both the DVD and VCR features. *Details are on page eight.*
- ★★★★ If you have a Stereo Receiver with DIGITAL AUDIO IN jacks, digital audio connections provide the clearest sound. Connect the DVD/VCR's COAXIAL DIGITAL AUDIO OUT jack to your Stereo Receiver for the best sound quality. If you use only this audio connection, only the DVD features of the DVD/VCR will be available. *Details are on page 13.*
- ★★★ If digital audio connections are not possible, connect the DVD/VCR's red and white AUDIO OUT jacks to the Audio In jacks of your Stereo Receiver or TV. This connection allows you to use both the DVD and VCR features. *Details are on page 11.*

Before you begin...

- Refer to the manuals of your TV, Cable Box, Stereo Receiver, or other devices as necessary. Note the style of jacks and connectors on the other equipment. Determine how to choose different Audio and Video In channels on your other equipment so you can see and hear the DVD/VCR material playing on the TV, Stereo, etc.
- Disconnect all equipment from the power outlets. Connect the equipment to the power outlets only after you have finished hooking up everything. Never make or change connections with equipment connected to the power outlet.

Remember...

- Set the TV to the correct Video In channel. Such channels may be called AUX or AUXILIARY IN, AUDIO/VIDEO or A/V IN, EXT1 or External In, etc. These channels often are located near channel 00. See your TV owner's manual for details. If you do not see the DVD or VCR playback on the TV, just keep changing TV channels until you see the DVD or VCR picture on the TV.
- Set the Stereo Receiver to the correct channel or "source" mode.
- Depending on your connection, you may need to purchase additional cables.
- To use the VCR features, you must include a connection with the supplied yellow video cable and red/white audio cables or with the supplied RF coaxial cable.

Once you determine the best option, find your choice on pages 8-13. Follow the specific steps for the hookup you choose. After hooking up the DVD/VCR, go to page 15 before turning on the DVD/VCR.

8 Hookups (cont'd)

DVD/VCR to TV only

Simplest connection using only supplied black RF coaxial cable
This connection will let you use the features of both the VCR and the DVD Player.

- 1 Disconnect the antenna or cable from your TV and connect it to the **ANT-IN (Antenna In) Jack** of your DVD/VCR.

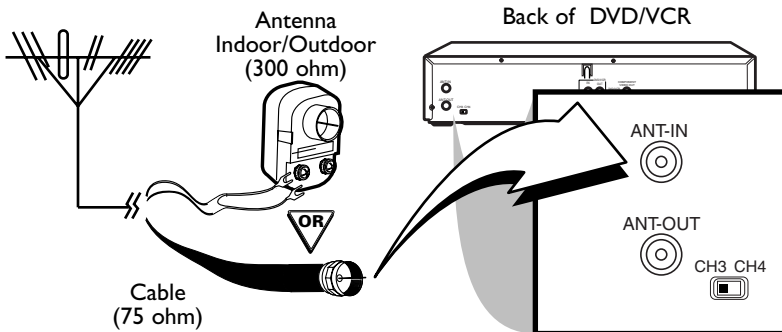

- 2 Connect the supplied black RF coaxial cable to the **ANT-OUT (Antenna Out) Jack** on the back of the DVD/VCR and to the **ANTENNA IN Jack** on the TV.

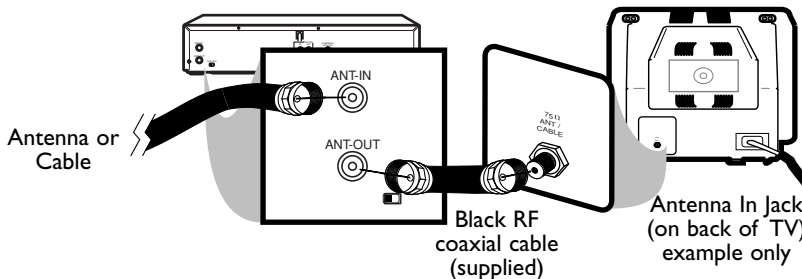

- 3 Plug in the power cords of the TV and the DVD/VCR.

- 4 Set the **CH3/CH4 switch** on the back of the DVD/VCR to **CH3** or **CH4**, whichever TV channel is not used or least used in your area. Set the **TV to the same channel**. For example, if the CH3/CH4 switch is set to CH3, the TV should be on channel 03.

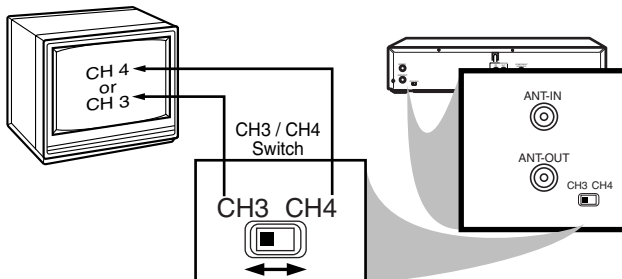

- 5 You are ready to turn on the DVD/VCR. Go to page 15 before turning on the DVD/VCR.

Hookups (cont'd) 9

DVD/VCR to Cable Box/DBS (Satellite Receiver) and TV

Using only basic RF coaxial cables

This connection will let you use the features of both the VCR and the DVD Player.

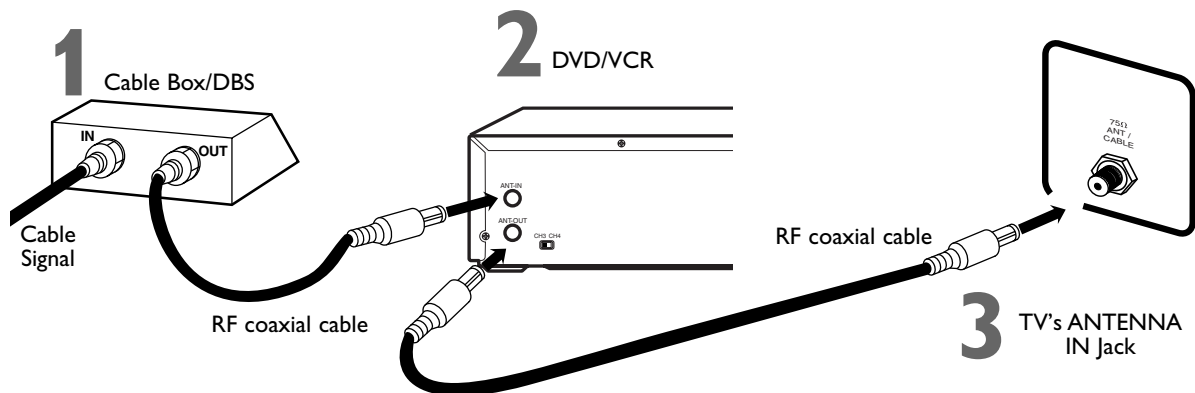

Connections

- 1** Connect a Cable signal to the **IN Jack** on the **Cable Box/DBS**.
- 2** Use an RF coaxial cable (as the one supplied) to connect the **OUT Jack** on the **Cable Box/DBS** to the **ANT-IN (Antenna In) Jack** on the **DVD/VCR**. On the **VCR** of the **DVD/VCR**, set the **TV channel** to **03** or **04** (your **Cable Box** output channel).
- 3** Use a second RF coaxial cable to connect the **ANT-OUT (Antenna Out) Jack** on the **DVD/VCR** to the **TV's Antenna In jack**. Set the **TV** to channel **03** or **04** (the channel to which the **CH3/CH4** switch is set on the back of the **DVD/VCR**).

Remember...

There are two ways to connect your Cable Box/DBS to the DVD/VCR. With the connection on this page:

- Select TV channels at the Cable Box/DBS, not the DVD/VCR. To record or view TV channels, follow these steps:
 - 1) Press **OUTPUT SELECT** to put the DVD/VCR in VCR mode. The green **VIDEO** light will appear on the front of the DVD/VCR
 - 2) Press **VCR/TV** to choose VCR position. The green **VCR/TV** light will appear on the front of the DVD/VCR
 - 3) Press **VCR**, then press the **CHANNEL/SKIP** |◀◀|▶▶| (**▼/▲**) buttons to set the DVD/VCR to the Cable Box/DBS output channel (03 or 04).
 - 4) Set the TV to the same channel as the **CH3/CH4** switch of the DVD/VCR.
 - 5) Select the channel you want to view/record at the Cable Box/DBS.
- You may not view a channel other than the one you are recording.
- You can only program a timer recording for one channel at a time. Set your Cable Box/DBS to the channel you want to record. When you enter the channel you want to record in a timer recording, select channel 03 or 04 (the Cable Box/DBS output channel). (This is step 5 on page 35.) Leave the Cable Box/DBS on for a timer recording.

10 Hookups (cont'd)

DVD/VCR to Cable Box/DBS (Satellite Receiver) and TV

Using only basic RF coaxial cables

This connection will let you use the features of both the VCR and the DVD Player.

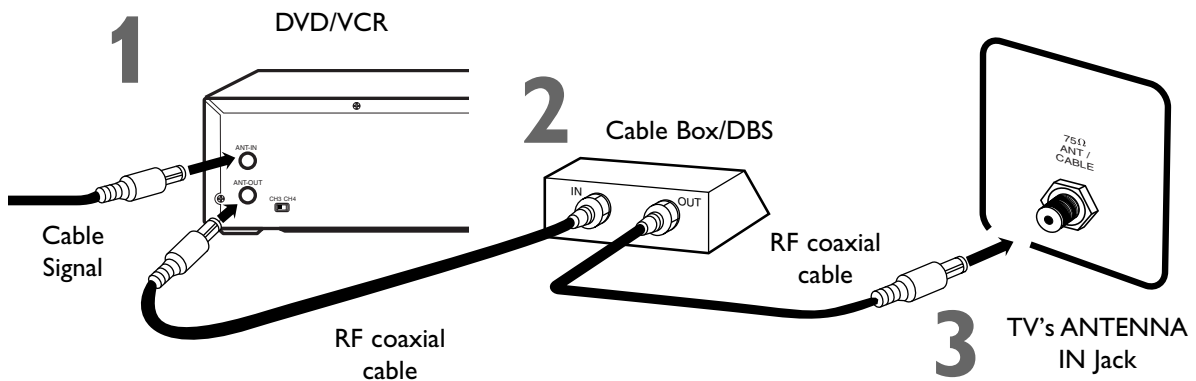

Connections

- 1** Connect a Cable signal to the DVD/VCR's ANT-IN (Antenna In) Jack.
- 2** Use an RF coaxial cable (as the one supplied) to connect the ANT-OUT (Antenna Out) Jack on the DVD/VCR to the IN Jack on the Cable Box/DBS.
- 3** Use a second RF coaxial cable to connect the OUT Jack on the Cable Box/DBS to the ANTENNA IN Jack on the TV.

Remember...

There are two ways to connect your Cable Box/DBS to the DVD/VCR. With the connection on this page:

- You may watch one channel while recording another. Follow these steps:
 - 1) Put the Cable Box/DBS on the same channel as the DVD/VCR's CH3/CH4 switch. Set the TV to the Cable Box/DBS output channel (03 or 04).
 - 2) Press OUTPUT SELECT to put the DVD/VCR in VCR mode. The green VIDEO light will appear on the front of the DVD/VCR. Then, press the VCR button, then press VCR/TV to choose VCR position. The green VCR/TV light will appear on the front of the DVD/VCR.
 - 3) Press CHANNEL/SKIP |◀◀/▶▶| (▼/▲) to select the channel you want to record at the DVD/VCR. Start the recording.
 - 4) Press the VCR/TV button once to put the DVD/VCR in TV position. The VCR/TV light will go off.
 - 5) Select the channel you want to watch at the Cable Box/DBS.
- When you play a tape or Disc, make sure the Cable Box/DBS is set to the same channel as the CH3/CH4 switch on the DVD/VCR. Set the TV to the Cable Box/DBS output channel (03 or 04).

Hookups (cont'd) 11

DVD/VCR to a TV that has Audio and Video In jacks

Using the supplied red, white, and yellow cables

This connection will let you use the features of both the VCR and the DVD Player.

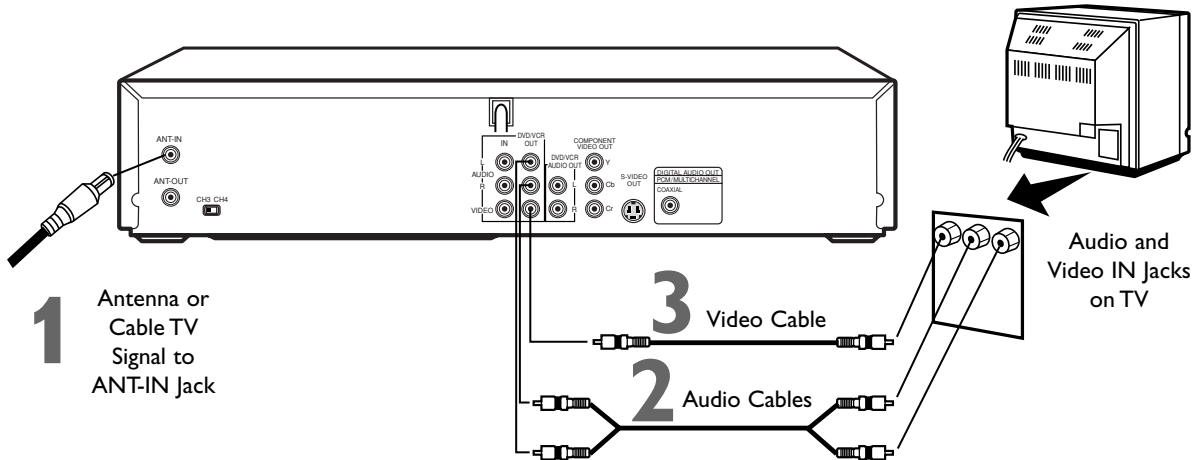

- 1** Connect the antenna or Cable TV signal to the **ANT-IN (Antenna In)** jack of your DVD/VCR.
- 2** Connect the red and white audio cables (supplied) to the red and white **DVD/VCR AUDIO OUT** jacks on the DVD/VCR and to the red and white **AUDIO IN** jacks on the TV, matching the cable colors to the jack colors. If the TV has a single **AUDIO IN** jack, use the white audio cable to connect the DVD/VCR's white DVD/VCR **AUDIO OUT** jack to the TV's **AUDIO IN** jack. You will not use the red cable.
- 3** Connect the yellow video cable (supplied) to the **DVD/VCR VIDEO OUT** jack on the DVD/VCR and to the **VIDEO IN** jack on the TV. For better DVD picture quality, connect an **S-Video** cable (not supplied) to the **S-VIDEO OUT** jack on the DVD/VCR and to the **S-VIDEO IN** jack on the TV instead. However, the **S-Video** connection only supplies video (picture) for the DVD Player of the DVD/VCR. Therefore, in order to use the VCR features or view TV channels at the DVD/VCR, you still need to either connect the **RF coaxial** cable between the **ANT-OUT** jack of the DVD/VCR and the TV's **Antenna In** jack, or connect the yellow video cable as described earlier. To connect the supplied **RF coaxial** cable, see step 2 on page eight.
- 4** Connect the power cords of the TV and the DVD/VCR to a power outlet. Turn on the TV and set it to the correct **Audio/Video In** channel. If you are using the red/white/yellow audio/video cables for VCR or DVD playback, choose the **Audio/Video In** channel at your TV. If you are using the **S-Video** cable for DVD playback, choose the **S-Video In** channel at your TV. If you are using the **RF coaxial** cable for VCR or DVD playback, choose channel 3 or 4 at the TV. See your TV owner's manual for more details. Or, simply continue changing channels at the TV until you see VCR or DVD playback on the TV screen.
- 5** You are ready to turn on the DVD/VCR. Go to page 15 before turning on the DVD/VCR.

12 Hookups (cont'd)

DVD/VCR to a Stereo and to a TV that has Component Video In jacks

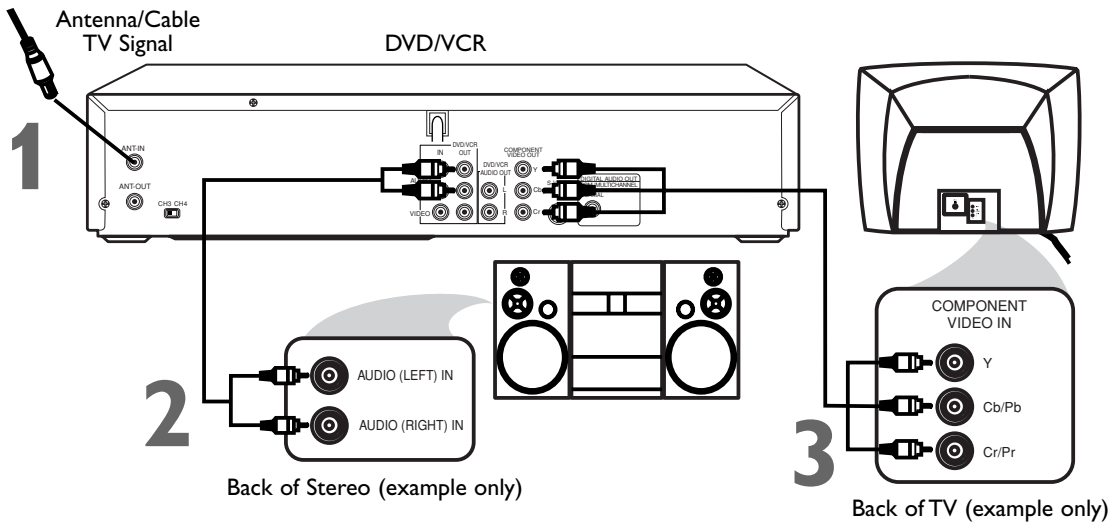

1 Connect the antenna or Cable TV signal to the **ANT-IN (Antenna In)** jack of your DVD/VCR.

2 Connect the supplied red and white audio cables to the red and white **DVD/VCR AUDIO OUT** Jacks on the DVD/VCR and to the red and white **AUDIO IN** jacks on the Stereo, matching the cable colors to the jack colors.

3 Connect component video cable (not supplied) to the **COMPONENT VIDEO OUT** jacks on the DVD/VCR and to the **COMPONENT VIDEO IN** jacks on the TV.

The Component Video connection only supplies video (picture) for the DVD Player of the DVD/VCR. Therefore, in order to use the VCR features or view TV channels at the DVD/VCR, you still need to either connect the RF coaxial cable between the ANT-OUT jack of the DVD/VCR and the TV's Antenna In jack, or connect the yellow video cable. To connect the supplied RF coaxial cable, see step 2 on page eight. To connect the supplied yellow video cable, see step 3 on page 11.

4 Connect the power cords of all the equipment to a power outlet. Turn on the Stereo and select the Stereo's **Auxiliary IN** station. Turn on the TV and set it to the **Component Video In** channel. If you are using the RF coaxial cable for VCR playback, choose channel 3 or 4 at the TV. If you are using the red/white/yellow audio/video cables for VCR playback, choose the Audio/Video In channel at your TV. Or, simply continue changing channels at the TV until you see VCR or DVD playback on the TV screen.

5 You are ready to turn on the DVD/VCR. Go to page 15 before turning on the DVD/VCR.

6 After you complete the VCR setup as described on page 15, set **DOLBY DIGITAL** to **OFF** in the DVD Player's Setup menu. Details are on page 70. If you play a DVD when the settings are wrong, the sound will be distorted or you may damage the speakers.

Hookups (cont'd) 13

DVD/VCR to a TV and to a Stereo Receiver that is Dolby Digital-compatible Using Digital Audio connections

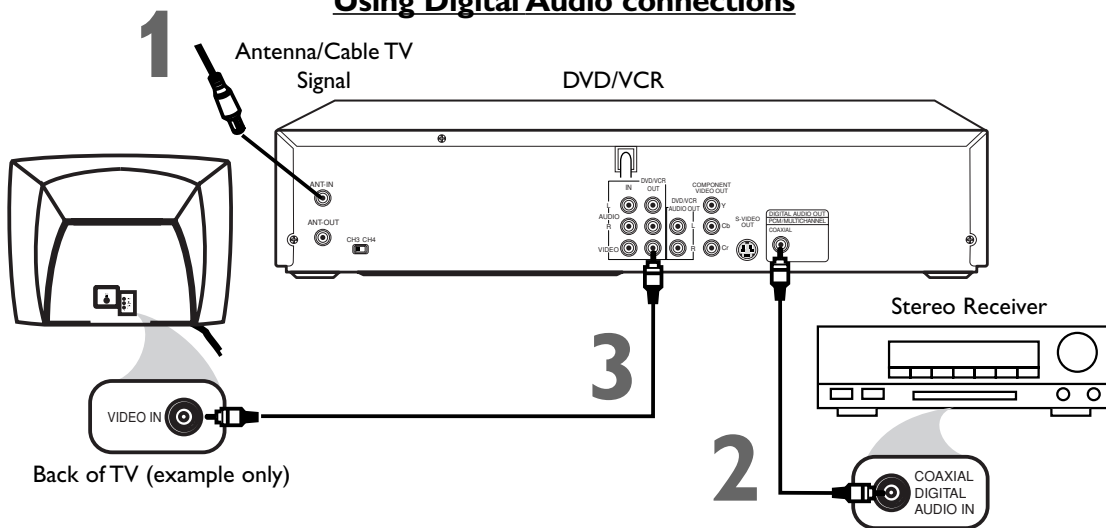

- 1** Connect the antenna or Cable TV signal to the **ANT-IN (Antenna In)** jack of your DVD/VCR.
- 2** Connect a coaxial digital audio cable (not supplied) to the DVD/VCR's **COAXIAL DIGITAL AUDIO OUT** jack and to the **COAXIAL DIGITAL AUDIO IN** jack on the Stereo Receiver.
This digital audio connection only provides sound for the DVD Player of the DVD/VCR. So, in order to use the VCR features or view TV channels at the DVD/VCR, you still need to either connect the RF coaxial cable between the ANT-OUT jack of the DVD/VCR and the TV's Antenna In jack, or connect the supplied red/white audio cables. To connect the supplied RF coaxial cable, see step 2 on page eight. To connect the red/white audio cables, see step 2 on page 11.
- 3** Connect the supplied yellow video cable to the yellow DVD/VCR **VIDEO OUT** jack on the DVD/VCR and to the **VIDEO IN** jack on the TV. To use component video cable or S-Video cable instead for the DVD Player, see pages 11-12. You will still need the yellow video cable or RF coaxial cable for VCR features.
- 4** Plug in the power cords of the stereo receiver, TV, and DVD/VCR. Turn on the stereo receiver and select its **Auxiliary IN** channel. Turn on the TV and set it to the correct **Video In** channel.
- 5** You are ready to turn on the DVD/VCR. Go to page 15 before turning on the DVD/VCR.

Remember...

Some DVDs are recorded in 5.1 channel Dolby Digital Surround. Select 5.1 channel Dolby Digital Surround Sound in the DVD Disc menu.

If you connect the DVD/VCR to a Dolby Digital Stereo Receiver, set **DOLBY DIGITAL** to **ON** in the DVD Player's Setup menu. *Details are on page 70.* If the DVD/VCR is not connected to a Dolby Digital-compatible Stereo Receiver, set **DOLBY DIGITAL** to **OFF**. Incorrect settings may cause noise distortion and damage the speakers.

14 Remote Control Setup

Putting Batteries in the Remote Control

- 1** Remove the **battery compartment lid** on the bottom of the remote control by pressing the tab, then lifting the lid.
- 2** Place **two AA batteries inside the battery compartment** with their + and – ends aligned as indicated.
- 3** Replace the **battery compartment lid**.

Using the Remote Control

- Point the remote control at the DVD/VCR's remote sensor (see page 20) when using the remote control to operate the DVD/VCR. Do not point the remote control at the TV.
- Do not put objects between the remote control and the DVD/VCR.

Recycling Guidelines/Battery Safety

- Your new product and its packaging contain materials that can be recycled and reused. Specialized companies can recycle your product to increase the amount that needs to be properly disposed. Your product uses batteries that should not be thrown away when depleted but should be disposed of as small chemical waste. Please find out about the local regulations on disposal of your old product, batteries, and packaging whenever you replace existing equipment.
- **Battery Usage CAUTION** - To prevent battery leakage that may result in bodily injury or damage to the unit:
Install ALL batteries correctly, with the + and - markings on the battery aligned as indicated on the unit;
Do not mix batteries, for example, old with new or carbon with alkaline; and
Remove batteries when the unit will not be used for a long time.

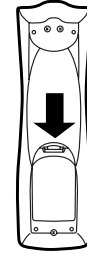

1



2



3

First-time DVD/VCR Setup 15

Before turning on your DVD/VCR, make sure batteries are in the remote control and the DVD/VCR and TV are connected correctly.

- You cannot program channels if you are using a Cable Box or a Direct Broadcast System.

1 Press VCR, then press POWER . "P-ON" will appear briefly on the front of the DVD/VCR. The green VIDEO light, the VCR/TV light, and the Power light will appear on the front of the DVD/VCR.

2 Turn on the TV. Set it to the same channel as the CH3/CH4 switch on the back of the DVD/VCR. The display shown below will appear. (If the display does not appear, check your hookups, then follow the steps on page 24 to set up channels and page 29 to select a language.)

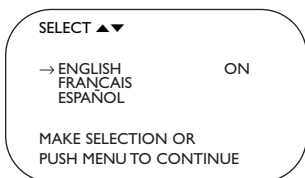

3 Within 60 seconds, press PLAY  (▲) or **STOP**  (▼) to select English, French, or Spanish as the language for VCR on-screen displays and menus.

4 Press DISC/MENU.

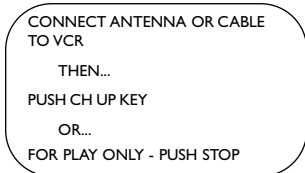



5 Within 60 seconds, press CHANNEL/SKIP  (▲) to begin automatic channel programming. AUTO CH PROGRAMMING IN PROCESS PLEASE WAIT will appear on the TV screen. The DVD/VCR will memorize all available channels. When all channels are memorized, CHANNELS ARE SET will appear on the screen briefly, then TV programming will appear.

These channels will be available when you want to watch TV while in VCR mode. To put the DVD/VCR in VCR mode, press OUTPUT SELECT so the green VIDEO light appears. Then press VCR/TV so the VCR/TV light appears. Press the VCR button, then use CHANNEL/SKIP  (▲) and the Number buttons to select a TV channel for viewing.

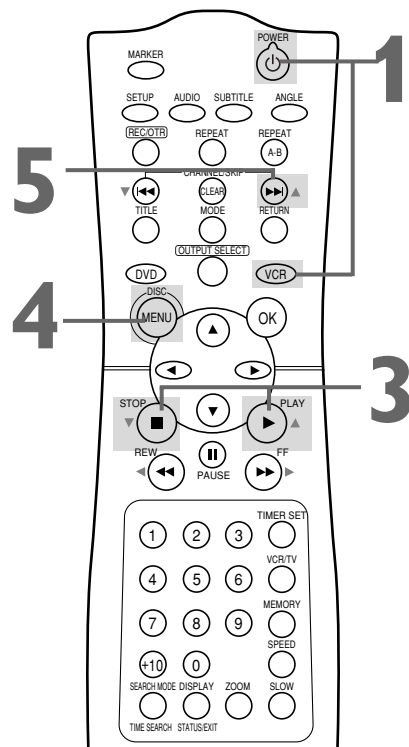
2 Turn on the TV.



Helpful Hints

- To skip this feature and play a tape immediately, insert a tape with its record tab removed.
- To skip step 3, press DISC/MENU. All on-screen displays will be in English. To skip step 5, press STOP  (▼). Channels will not be programmed, and CHANNELS NOT SET will appear on the screen.
- If you try to program channels when there is no antenna or Cable TV signal connected to the ANT-IN jack of the DVD/VCR, programming will appear to take place, but eventually a NO TV SIGNALS message will appear. Connect an antenna or Cable TV signal to the DVD/VCR's ANT-IN (Antenna In) jack and press CHANNEL/SKIP  (▲) again. If channel programming does not resume, follow the steps on page 24.
- You may need to repeat the steps on this page if the power fails.

16 Video Cassette Playback

VCR

Read and follow the steps below to play a tape.

- 1** Turn on the TV and set it to channel 3 or 4, whichever channel the CH3/CH4 switch on the back of the DVD/VCR is set to. Or, if you connected the DVD/VCR to the TV using audio and video cables, select the correct audio and video in channel at the TV. Details are on page 11.
- 2** With the DVD/VCR power off, insert a tape in the cassette compartment of the DVD/VCR. The Power, VIDEO, VCR/TV, and CST. IN lights will appear on the front of the DVD/VCR. If the tape's record tab has been removed, playback will start automatically. If the DVD/VCR power is already on, press OUTPUT SELECT to put the DVD/VCR in VCR mode if necessary. The green VIDEO light will appear on the front of the DVD/VCR.
- 3** If playback does not start automatically, press VCR, then press PLAY ► (▲).
- 4** Press STOP ■ (▼) to stop playback.
- 5** Press REW ◀◀ (◀) to rewind the tape.
- 6** After the tape stops, press STOP/EJECT on the DVD/VCR to remove the tape.

1 Turn on the TV.

2 Insert a tape in the DVD/VCR.

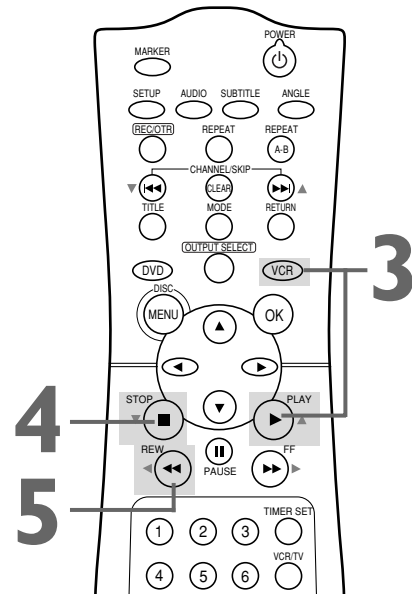

6 Press STOP/EJECT on the DVD/VCR.

Helpful Hints





- If the tape you want to play is already in the DVD/VCR, make sure the DVD/VCR power is on and the DVD/VCR is in VCR mode and VCR position. (The green VIDEO light and the VCR/TV light will appear on the front of the DVD/VCR.) Press VCR, then press PLAY ► (▲).
- Other tape playback options and features are on pages 39-46.
- When you play a tape recorded in S-VHS format on this unit, you can not get the high resolution that would be available on an S-VHS VCR. Noise lines (black and white streaks) may appear on the picture.
- If REPEAT PLAY is ON, playback will begin automatically when you insert a tape, even when the record tab is intact. Details are on page 39.
- You must connect the DVD/VCR to a TV using the RF coaxial cable or the audio/video cables in order to use the VCR features.

Disc Playback 17

DVD

AUDIO CD

- Before you begin, turn on the power of the TV, stereo receiver and any other equipment connected to the DVD/VCR. Make sure the TV and the stereo receiver (if applicable) are set to the correct channel. *Details are on pages 8-13.*

- 1 Press POWER  to turn on the DVD/VCR.** "P-ON" will appear briefly on the display panel. The DVD/VCR will be in VCR mode.
- 2 Press OUTPUT SELECT so the red DVD light appears on the front of the DVD/VCR. Then, press DVD.**
- 3 Press OPEN/CLOSE on the front of the DVD/VCR to open the Disc tray.**
- 4 Place a Disc into the tray.** Some DVDs are recorded on both sides. Make sure the side you want to play is facing up. Or, if the DVD is recorded on only one side, place the Disc in the tray with the label facing up.
- 5 Press PLAY .** The tray will close automatically, and playback will begin at the first Chapter or Track of the Disc.
Or, you may press OPEN/CLOSE or press the tray toward the DVD/VCR to close the tray; DVD playback will start automatically.
If a DVD menu appears instead, see *page 48*.
With some Audio CDs, playback will not begin unless you press PLAY .
- 6 Press STOP  to stop playback.** If Disc playback is stopped for more than five minutes, a screen saver will appear. *Details are on page 75.*

- 3 Press OPEN/CLOSE on the DVD/VCR.**

- 4 Insert a Disc.**

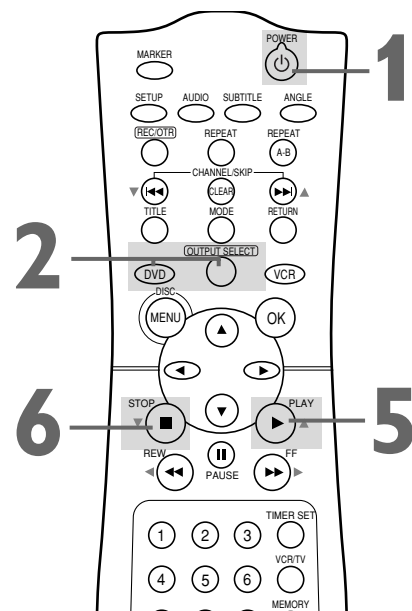

Helpful Hints

- An "X" may appear at the top right corner of the TV screen when you try a feature. Either the feature is not available on the Disc, or the DVD/VCR cannot access the feature at this time. This does not indicate a problem with the DVD/VCR.
- If a Disc is dirty or scratched, the pictures may appear distorted or playback may stop. Remove the Disc and turn off the DVD/VCR. Disconnect the power cord, then reconnect it. Clean the Disc, then turn on the DVD/VCR again and reinsert the Disc for playback.
- When the DVD or CD light appears on the display panel, the Disc is loaded completely and is ready for playback.
- When you press OPEN/CLOSE or PLAY (DVD) on the front of the DVD/VCR when the power is off, the DVD/VCR will turn on automatically and will be in DVD mode.

Remember, this DVD/VCR will play only certain Discs. See page six for details.

18 Display Panel (DVD)

Display with Dimmer

Messages about current Disc operations appear here. See Display Messages below. You can adjust the brightness of the display. Details are on pages 66-67.

DVD Light (red)

This light appears when the DVD/VCR is in DVD mode. You can only watch DVDs when the red DVD light is on. To make the red DVD light come on, press the SOURCE button on the front of the DVD/VCR or OUTPUT SELECT on the remote control.

Disc tray
Insert a Disc here.

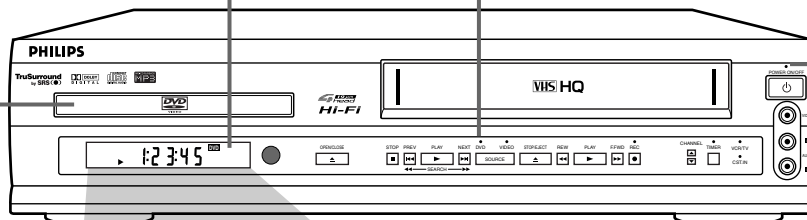

Power Light

This light appears when the power is on.

REPEAT: Appears during Repeat Playback of a Disc, along with A-B, TITLE, CHP, or TRK., depending on the type of Repeat Playback you have selected. Details are on page 53.

A-B: Appears during A-B Repeat Playback. Details are on page 53.

▶: Appears during Disc playback.

||: Appears when play is paused.

Displays the elapsed playing time of the current Title or Track. Briefly displays Title, Chapter, or Track numbers.

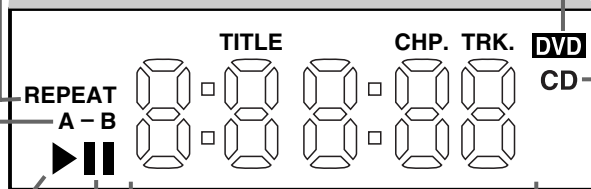

DVD: Lights when a DVD is in the tray and ready for playback.

CD: Lights when an Audio CD is in the tray and ready for playback.

Display Messages

P - 00	Power is turning on.
- - - -	Appears after the disc tray closes if the tray is empty, if there is an error reading the disc, or if an unacceptable disc is installed.
OPEN	Tray is opening or is open.
CLOSE	Tray is closing. This also may appear as the DVD Player tries to load a Disc.
Load	Disc is loading.
P - OFF	Power is turning off.

Display Panel (VCR) 19

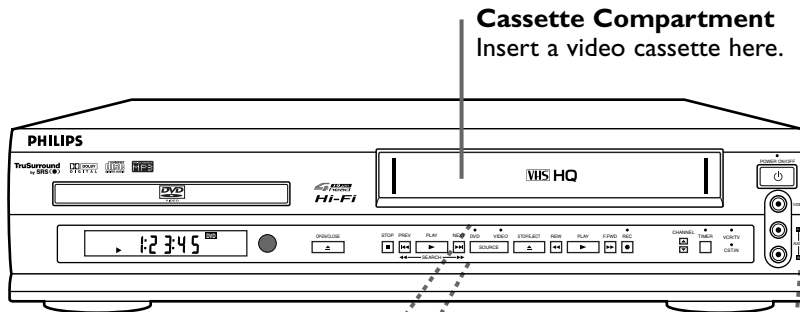

Cassette Compartment
Insert a video cassette here.

Power Light
This red light appears when the power is on.

VIDEO Light (Green)

This light appears when the DVD/VCR is in VCR mode. You can only watch video cassettes or access VCR features and TV channels when the green VIDEO light is on. To make the green VIDEO light come on, press OUTPUT SELECT on the remote control or SOURCE on the front of the DVD/VCR.

REC (record) Light

This red light appears during VCR recording. It flashes when recording is paused.

TIMER Light

This red light glows when the DVD/VCR is set for a timer recording or during a One-Touch Recording. It flashes if a timer recording is set but no tape is in the DVD/VCR. It flashes when all timer recordings or One-Touch Recordings are finished. *Details are on pages 33-37.*

CST.IN Light

(cassette inside)
This green light appears when a video cassette is in the DVD/VCR.

VCR/TV Light

This green light appears when the VCR is in VCR position. This light does not appear when the VCR is in TV position. To choose VCR position, press VCR/TV on the remote so the VCR/TV light appears. In VCR position, you can watch tapes and watch or record TV channels (changing TV channels at the VCR).

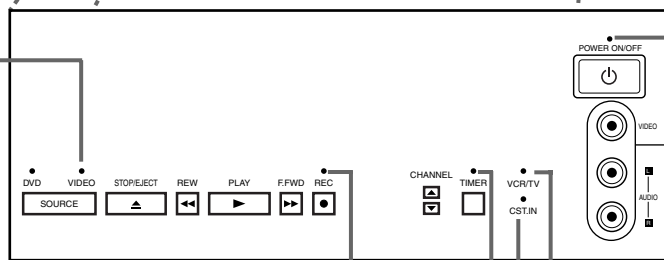

20 Front Panel

SOURCE Button

Press to select DVD mode or VCR mode. The red DVD light appears in DVD mode. The green VIDEO light appears in the VCR mode.

PLAY Button (DVD)

Press to start Disc playback.
Details are on page 17.

STOP Button (DVD)

Press to stop Disc playback.
Details are on page 17.

OPEN/CLOSE Button (DVD)

Press to open or close the Disc tray.
Details are on page 17.

Remote Sensor

Receives a signal from your remote control so you can work your DVD/VCR from a distance.

POWER ON/OFF Button

Press to turn the power on and off.

TIMER Button

Press to set a timer recording.
Details are on page 36.

CHANNEL ▲/▼ Buttons

In VCR mode, press to change TV channels at the DVD/VCR. Press to adjust tracking or to remove jitter in a Still picture.
Details are on page 43.

REC (record) button (VCR)

Press once to start a recording. Press repeatedly to start a One-Touch Recording.
Details are on page 33.

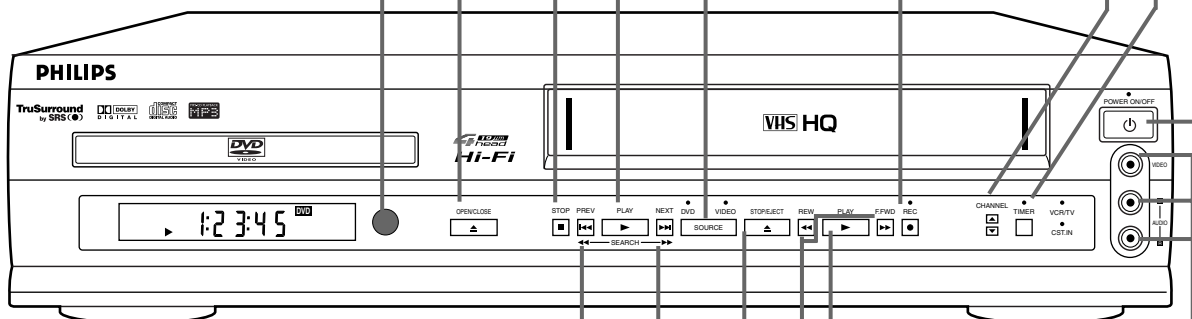

PREV/NEXT SEARCH Buttons (previous/next/search DVD)

Press during playback to go to previous or subsequent Tracks or Chapters. Press and hold for three seconds for a forward or reverse search.

STOP/EJECT Button (VCR)

Press once to stop tape playback. When playback is stopped, press to eject the tape. Press to select an item in the VCR menu.

PLAY Button (VCR)

Press to play a video cassette. Press to release Slow, Search, or Still mode and return to playback. Details are on page 42. Press to select an item in the VCR menu.

REW, F.FWD Buttons (rewind, fast forward VCR)

Press to rewind or fast forward a video cassette. Details are on page 42. Press REW to go to a previous VCR menu. Press FFWD to go to the next VCR menu.

AUDIO and VIDEO In Jacks

Connect audio and video cables coming from the audio and video out jacks of a camcorder, another VCR, another DVD Player, or audio system here.
Details are on page 38.

Rear Panel 21

ANT-IN (Antenna In) Jack

Connect your antenna or Cable TV signal here.

Details are on pages 8-13.

AUDIO IN (right/left) Jacks

Connect audio cables coming from the audio out jacks of a camcorder, another VCR, or an audio source here. Details are on page 38.

AC Power Cord

Connect to a standard AC outlet to supply power to the DVD/VCR.

COMPONENT VIDEO OUT (Y Cb Cr) Jacks

Connect optional component video cables here and to the Component Video In jacks of a television. Details are on page 12.

COAXIAL DIGITAL AUDIO OUT Jack

Connect an optional coaxial digital audio cable here and to the Coaxial Digital Audio In jack of a decoder or stereo receiver. Details are on page 13.

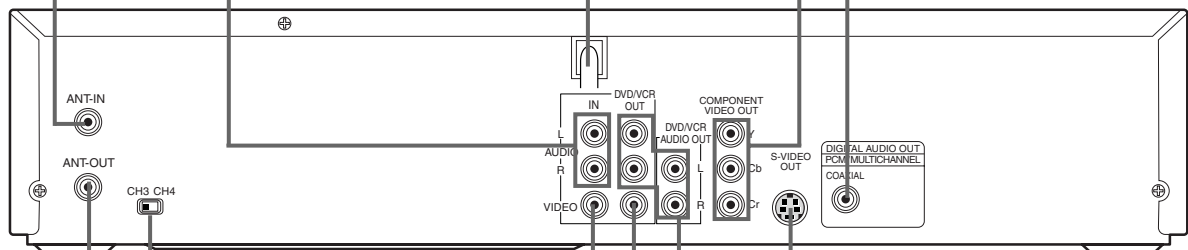

VIDEO IN Jack

Connect a cable coming from the video out jack of a camcorder, another VCR, or another DVD Player here. Details are on page 38.

DVD/VCR VIDEO OUT Jack

Connect the yellow video cable (supplied) here and to the TV's Video In jack. Details are on pages 11-13.

CH3/CH4 Switch

Set to channel 3 or 4 to use your TV with your DVD/VCR. Details are on pages 8-10.

ANT-OUT (Antenna Out) Jack

Use the supplied RF coaxial cable to connect this jack to the ANTENNA IN Jack on your TV, Cable Box, or Direct Broadcast System. Details are on pages 8-10.

S-VIDEO OUT Jack

Connect an optional S-Video cable here and to the S-Video In jack of a television. Details are on page 11.

DVD/VCR AUDIO OUT Jacks

Connect the supplied audio cables here and to the Audio In jacks of a television or other audio equipment. Details are on pages 11-12. There are two sets of AUDIO OUT jacks in case you want to connect the second pair of jacks to additional equipment (for example, a stereo receiver in addition to the TV hookup).

Helpful Hint

- The S-VIDEO OUT, COMPONENT VIDEO OUT, and COAXIAL DIGITAL AUDIO OUT jacks are only useful in DVD mode.

22 Remote Control Buttons

MARKER Button

Press to set a Marker, which gives you quick access to points you select on a Disc. Details are on page 54.

SUBTITLE Button

Press to select a language for DVD subtitles. Details are on page 55.

REPEAT Button

Press to play a Track, Audio CD, Title, or Chapter repeatedly. Details are on page 53.

DVD Button

Press before using the remote control for DVD features.

Arrow ◀▶▲▼ Buttons

Press to select an item in the DVD Player Setup menu or in the DVD Disc menu.

TIMER SET Button

Press to set a timer recording. Details are on page 36.

Number Buttons

In DVD mode, press to select a Track or Chapter for Disc playback. Details are on pages 50-51. Press to set up a Program. Details are on page 60. In VCR mode, use to set up VCR features or to select TV channels. Enter channel numbers as a two-digit number for the quickest results (to select channel 6, press 0,6). Otherwise, there may be a brief delay. For channels 100 and above, enter a three-digit number (for channel 117, press 1, 1, 7). If you have Cable TV, channels 1-125 are available. If you have an antenna, channels 2-69 are available. The +10 button has no effect in VCR mode.

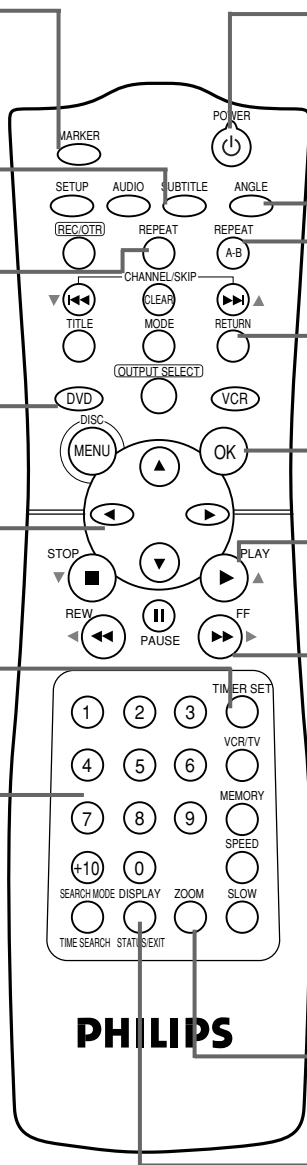

POWER Button

Press to turn the power on and off.

ANGLE Button

Press to see a DVD picture from a different angle (if available). Details are on page 55.

A-B REPEAT Button

Press to set up A-B Repeat. Details are on page 53.

RETURN Button

Press to return to the previous DVD Player's Setup menu or to remove the Setup menu.

OK Button

Press to confirm or select DVD Player menu items.

PLAY (▶) Button

Press to begin Disc or tape playback. Press to select an item in the VCR menu.

FF (▶▶) Button

(fast forward) Button
In DVD mode, press to fast forward the Disc. Details are on page 49. Press when DVD playback is paused to start slow motion playback. Details are on page 59.

In VCR mode, press to fast forward the tape. Details are on page 42. Press to go to the next VCR menu or to change a VCR menu item.

ZOOM Button

Press to enlarge the DVD picture. Details are on page 59.

DISPLAY/STATUS/EXIT Button

In VCR mode, press to access or remove the VCR's on-screen status display. Details are on page 30. Press to exit on-screen VCR menus. In DVD mode, press to access Disc information. Details are on page 65.

Helpful Hints

- For DVD Player features, press the DVD button first before pressing other buttons. To make sure the DVD/VCR is in DVD mode, press OUTPUT SELECT so the red DVD light appears on the front of the DVD/VCR.
- For VCR features, press the VCR button before pressing any other buttons. To make sure the DVD/VCR is in VCR mode, press OUTPUT SELECT so the green VIDEO light appears on the front of the DVD/VCR.

Remote Control Buttons (cont'd) 23

SETUP Button

Press to access or remove the DVD Player's Setup menu.

REC/OTR (record/one-touch recording) Button

Press once to start a VCR recording. *Details are on page 31.* Press repeatedly to start a One-Touch Recording. *Details are on page 33.*

CLEAR Button

Press to erase incorrect information. In VCR mode, press to reset the real-time tape counter. *Details are on page 40.*

TITLE Button

Press to see a DVD Title menu. *Details are on page 48.*

MODE Button

Press to set a Program. *Details are on page 60.* Press to start Random playback. *Details are on page 61.*

DISC/MENU Button

Press to see a DVD Disc menu or the VCR menu.

STOP ■ (▼) Button

Press to stop Disc playback, tape playback, or recording. Press to select an item in the VCR menu.

REW ◀◀(◀) (rewind) Button

Press to fast reverse a DVD or Audio CD. *Details are on page 49.* Press to rewind a tape. *Details are on page 42.* Press to go to a previous VCR menu.

SEARCH MODE/TIME SEARCH Button

In DVD mode, press to search for a specific Title/Chapter/Track/Time. *Details are on pages 50-51.* In VCR mode, press to fast forward or rewind the tape a specific length of time. *Details are on page 41.*

SLOW Button

Press to view a tape in slow motion; press again to resume normal playback. *Details are on page 42.*

SPEED Button

Press to select the VCR's recording speed (SP or SLP). *Details are on pages 31, 36, and 73.*

AUDIO Button

Press to choose a DVD audio language. *Details are on page 58.* Press to choose a sound mode. *Details are on page 61.*

CHANNEL/SKIP ◀◀/▶▶ (▼/▲) Buttons

In DVD mode, press to skip Chapters or Tracks. *Details are on page 51.* In VCR mode, press to change TV channels at the DVD/VCR.

VCR Button

Press before using the remote control for VCR features.

OUTPUT SELECT Button

Press to select DVD mode or VCR mode. The red DVD light indicates DVD mode. The green VIDEO light indicates VCR mode.

PAUSE || Button

Press to pause Disc playback or to advance the picture one frame at a time. *Details are on page 52.* Press to pause or resume VCR recording. *Details are on page 31.* Press during tape playback to freeze or unfreeze the picture. *Details are on page 42.*

VCR/TV Button

Use to select VCR or TV position. The VCR/TV light appears when the DVD/VCR is in VCR position.

● VCR Position

In VCR mode (the green VIDEO light is on), watch a tape or watch/record TV programs. Use CHANNEL/SKIP ◀◀/▶▶ (▼/▲) or the Number buttons to change channels at the DVD/VCR. In DVD mode (the red DVD light is on), use the DVD Player and its features.

● TV Position

In VCR mode, watch TV channels or watch one program while recording another. *Details are on page 32.*

MEMORY Button

Press to memorize a tape position. *Details are on page 40.*

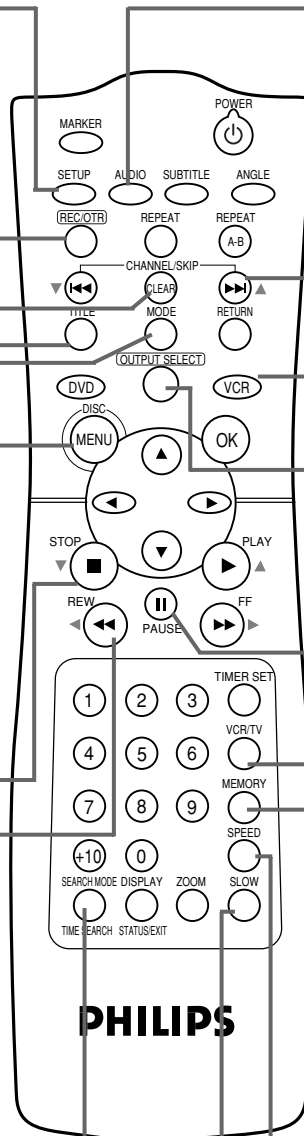

PHILIPS

24 Channel Setup

Although your DVD/VCR may automatically memorize the channels you receive when you turn it on for the first time, you can set up the channels again.

- Before you begin, place the DVD/VCR in VCR mode. Press **OUTPUT SELECT** so the green **VIDEO** light appears on the front of the DVD/VCR. Press **VCR/TV** so the green **VCR/TV** light appears on the front of the DVD/VCR.

1 Press **VCR**, then press **DISC/MENU**.

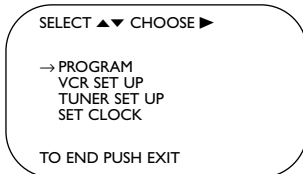

2 Press **PLAY ► (▲)** or **STOP ■ (▼)** to select **TUNER SET UP**, then press **FF ►► (►)**.

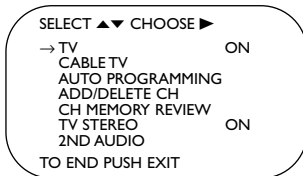

3 Press **PLAY ► (▲)** or **STOP ■ (▼)** to select **TV** (if you have an antenna) or **CABLE TV** (if you have a cable connection). Then, press **FF ►► (►)**. ON will appear beside your choice.

4 Press **PLAY ► (▲)** or **STOP ■ (▼)** to select **AUTO PROGRAMMING**, then press **FF ►► (►)**. The DVD/VCR will memorize all the channels you receive.



5 Wait for a few minutes while the DVD/VCR sets up the channels. When this is complete, **CHANNELS ARE SET** will appear on the screen. Then the programming of the lowest channel number placed in the DVD/VCR's memory will appear on the screen. Now when you press **CHANNEL/SKIP ◀◀/▶▶ (▼/▲)**, you will scan only through channels you receive. You still can select any channel number using the Number buttons.

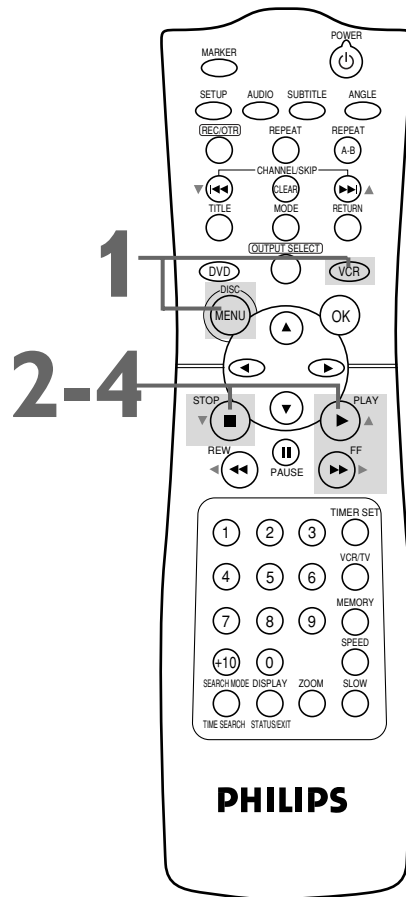

Helpful Hints

- You cannot enter the **TUNER SET UP** menu when you are in **Line Input mode (channel 001 or 002)**. When you select **channel 001 or 002, AV REAR or AV FRONT** will appear on the screen briefly.
- You cannot program channels if you are using a **Cable Box or DBS**.
- If you select **TV** at step 3, channels **2-69** will be available. If you select **CABLE TV** at step 3, channels **1-125** will be available.

Channel Setup (cont'd) 25

Adding/Deleting Channels

You may want to add or delete TV channels if your channel lineup changes or if you no longer watch some channels.

- Before you begin, place the DVD/VCR in VCR mode. Press **OUTPUT SELECT** so the green **VIDEO** light appears on the front of the DVD/VCR. Press **VCR/TV** so the green **VCR/TV** light appears on the front of the DVD/VCR.

1 Press **VCR**, then press **DISC/MENU**.

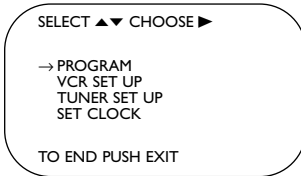

2 Press **PLAY ► (▲)** or **STOP ■ (▼)** to select **TUNER SET UP**, then press **FF ►► (►)**.

3 Press **PLAY ► (▲)** or **STOP ■ (▼)** to select **ADD/DELETE CH**, then press **FF ►► (►)**.

NOTE: If you select TV at the TUNER SET UP menu, channel numbers 2-69 will appear on the ADD/DELETE CH menu.

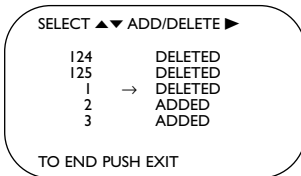

4 Press **PLAY ► (▲)** or **STOP ■ (▼)** until the channel number you want to add or delete appears beside the arrow.

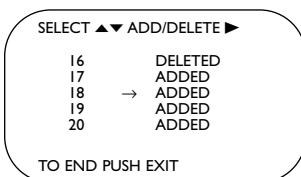

5 Press **FF ►► (►)** to select **ADDED** or **DELETED**. Repeat steps 4 and 5 until you have added or deleted all the channels you wanted to add or delete.

6 Press **DISPLAY/STATUS/EXIT**.

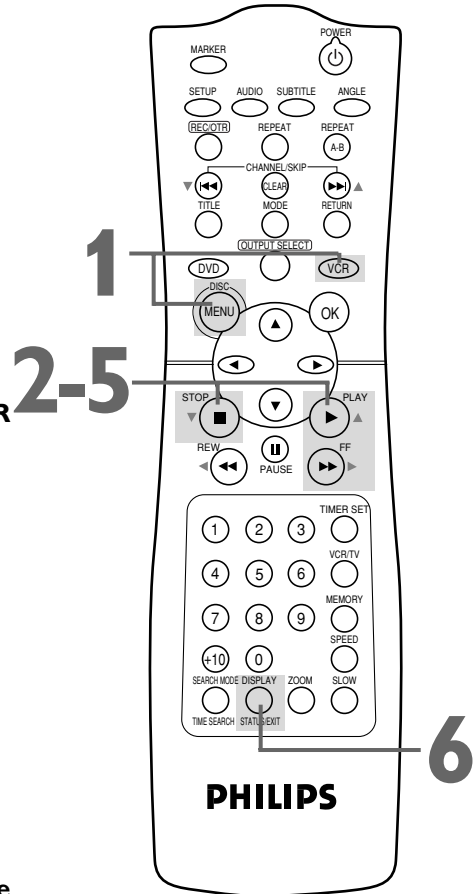

26 Channel Setup (cont'd)

Reviewing Memorized Channels

To see which TV channels the DVD/VCR has memorized, follow the steps below.

- Before you begin, place the DVD/VCR in VCR mode. Press **OUTPUT SELECT** so the green **VIDEO** light appears on the front of the DVD/VCR. Press **VCR/TV** so the green **VCR/TV** light appears on the front of the DVD/VCR.

1 Press **VCR**, then press **DISC/MENU**.

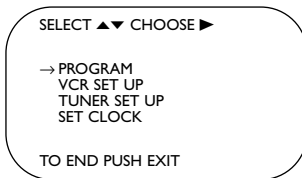

2 Press **PLAY ► (▲)** or **STOP ■ (▼)** to select **TUNER SET UP**, then press **FF ►► (►)**.

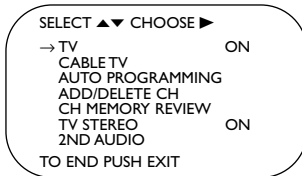

3 Press **PLAY ► (▲)** or **STOP ■ (▼)** to select **CH MEMORY REVIEW**, then press **FF ►► (►)**. A list of memorized channels will appear on the screen.

- If all the memorized channels don't fit on the screen, press **FF ►► (►)** to see the remaining channels. Then press **REW ◀◀ (◀)** to return to the first screen of channels.
- If you do not press any buttons within 10 seconds, you will either go to the next screen of channels or you will return to the previous menu.

4 Press **DISPLAY/STATUS/EXIT** once or twice to exit.

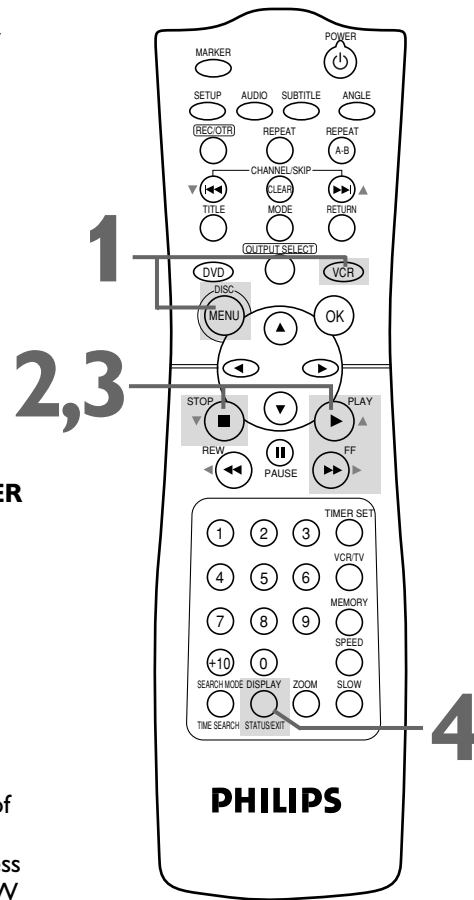

Clock (VCR) 27

Follow the steps below to set the clock for the VCR. Make sure:

- The DVD/VCR is on and the VCR/TV light appears on the front of the DVD/VCR. (If it does not, press VCR/TV once.)
- You make each entry within 60 seconds of the previous entry.
- Before you begin, place the DVD/VCR in VCR mode. Press OUTPUT SELECT so the green VIDEO light appears on the front of the DVD/VCR.

- 1** Press **VCR**, then press **DISC/MENU**.
- 2** Press **PLAY ► (▲)** or **STOP ■ (▼)** to select **SET CLOCK**, then press **FF ►► (►)**.
- 3** Press **PLAY ► (▲)** or **STOP ■ (▼)** to select **SET CLOCK**, then press **FF ►► (►)**.

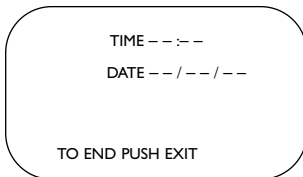

- 4** Press two **Number** buttons for the hour(s) and two **Number** buttons for the minute(s). Then press **1** for **AM** or **2** for **PM**. For example, for 2:15 PM, press 02, 15, 2.

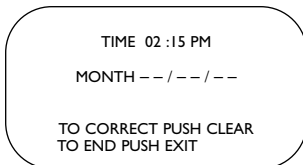

- 5** Press two **Number** buttons for the month, two **Number** buttons for the day, and two **Number** buttons for the year. For example, for July 1, 2002, press 07, 01, 02. The day of the week will appear automatically.

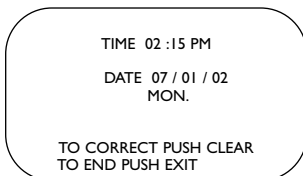

- 6** Press **DISPLAY/STATUS/EXIT**.

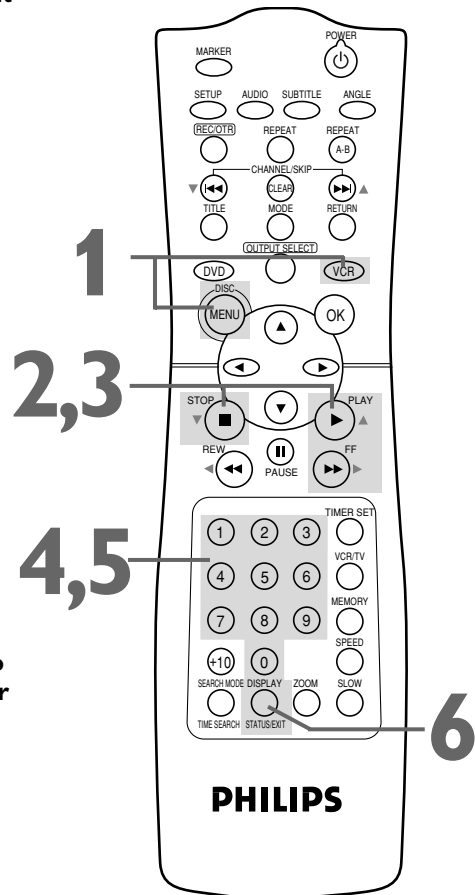

Helpful Hints

- Enter a 0 before a single-digit number.
- Entries that do not match the DVD/VCR's clock or calendar will cause a question mark to appear on the screen.
- To make corrections, press **CLEAR** until the space for the number you want to correct is flashing. Then enter the correct number.
- To see the current time on the TV screen, press **DISPLAY/STATUS/EXIT**. Details are on page 30.
- Power failures can erase the clock setting.

28 Daylight-Savings Time

You may program the DVD/VCR so the VCR clock will automatically move forward one hour in April and turn back one hour in October. Daylight-Savings Time is ON when you receive your DVD/VCR. Turn Daylight-Savings Time ON or OFF by following the steps below. Before you begin:

- Set the clock. *Details are on page 27.*
- Place the DVD/VCR in VCR mode. Press OUTPUT SELECT so the green VIDEO light appears on the front of the DVD/VCR. Press VCR/TV so the green VCR/TV light appears on the front of the DVD/VCR.

1 Press VCR, then press DISC/MENU.

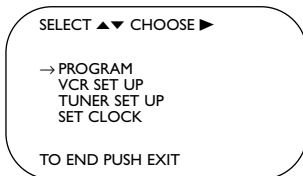

2 Press PLAY ► (▲) or STOP ■ (▼) to select SET CLOCK, then press FF ►► (►).

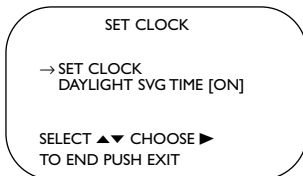

3 Press PLAY ► (▲) or STOP ■ (▼) to select DAY-LIGHT SVG TIME. Then, press FF ►► (►) so OFF (or ON) appears beside DAYLIGHT SVG TIME.

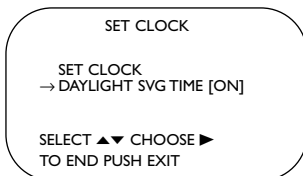

4 Press DISPLAY/STATUS/EXIT.

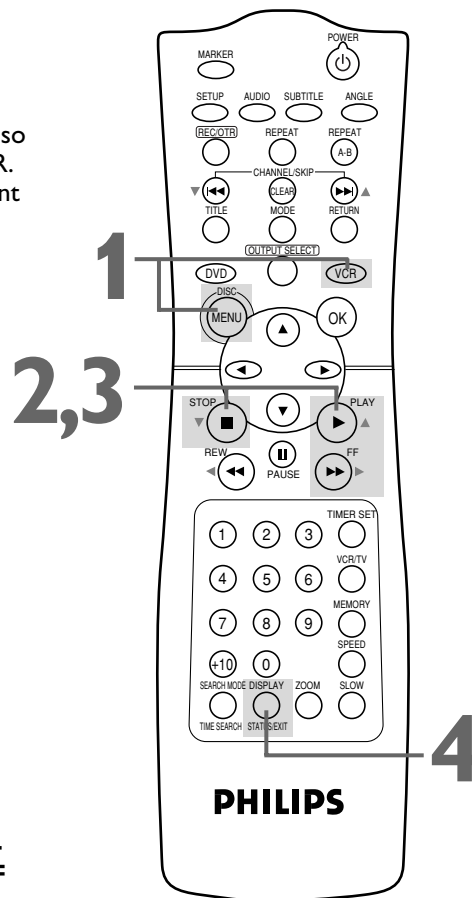

Language Selection (VCR) 29

Follow the steps below to change the language of the VCR on-screen displays and menus.

- Before you begin, place the DVD/VCR in VCR mode. Press **OUTPUT SELECT** so the green **VIDEO** light appears on the front of the DVD/VCR. Press **VCR/TV** so the green **VCR/TV** light appears on the front of the DVD/VCR.

1 Press **VCR**, then press **DISC/MENU**.

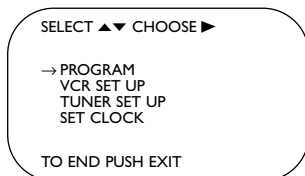

2 Press **PLAY ► (▲)** or **STOP ■ (▼)** to select **VCR SET UP**, then press **FF ►► (►)**.

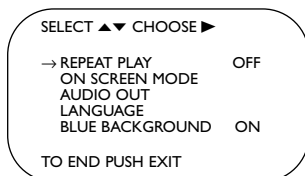

3 Press **PLAY ► (▲)** or **STOP ■ (▼)** to select **LANGUAGE**, then press **FF ►► (►)**.

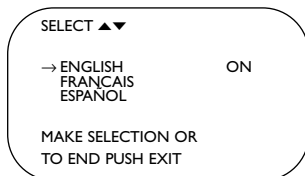

4 Press **PLAY ► (▲)** or **STOP ■ (▼)** to select **English, French (FRANCAIS), or Spanish (ESPAÑOL)** as the language for VCR on-screen displays and menus.

5 Press **DISPLAY/STATUS/EXIT**.

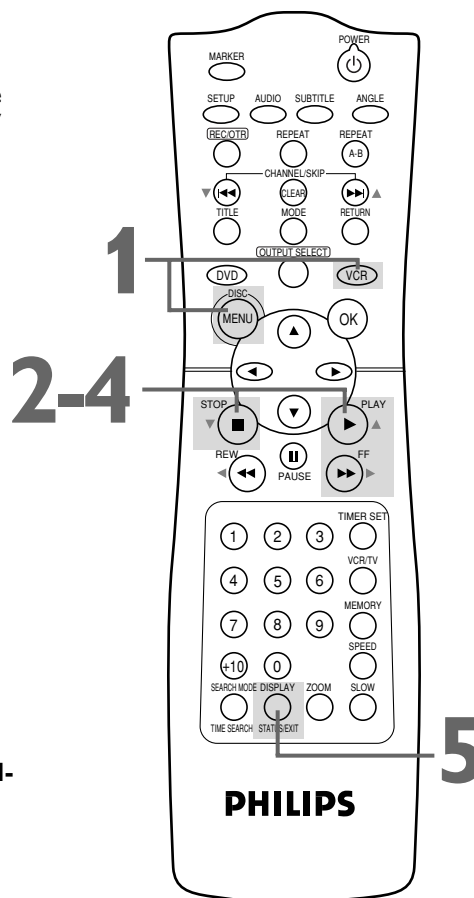

Helpful Hint

- If you accidentally select French and need English:

1. Press **VCR**, then press **DISC/MENU**.
2. Press **PLAY ► (▲)** or **STOP ■ (▼)** to select **PROGRAMMATION DU VCR**, then press **FF ►► (►)**.
3. Press **PLAY ► (▲)** or **STOP ■ (▼)** to select **LANGUE**, then press **FF ►► (►)**.
4. Press **PLAY ► (▲)** or **STOP ■ (▼)** to select **ENGLISH**.
5. Press **DISPLAY/STATUS/EXIT**.

- If you accidentally select Spanish and need English:

1. Press **VCR**, then press **DISC/MENU**.
2. Press **PLAY ► (▲)** or **STOP ■ (▼)** to select **PREPARE EL VCR**, then press **FF ►► (►)**.
3. Press **PLAY ► (▲)** or **STOP ■ (▼)** to select **LENGUAJE**, then press **FF ►► (►)**.
4. Press **PLAY ► (▲)** or **STOP ■ (▼)** to select **ENGLISH**.
5. Press **DISPLAY/STATUS/EXIT**.

30 VCR On-Screen Status Displays

A status display will appear when you press DISPLAY/STATUS/EXIT or certain function buttons. The contents of the status display will vary. To choose the status display mode, follow the steps below.

- Before you begin, place the DVD/VCR in VCR mode. Press OUTPUT SELECT so the green VIDEO light appears on the front of the DVD/VCR. Press VCR/TV so the green VCR/TV light appears on the front of the DVD/VCR.

If you select STATUS ON and COUNTER ONLY ON:

- Whenever you press STOP ■ (▼) or PLAY ► (▲) to stop or start tape playback, the status display will appear for five seconds. After five seconds, only the real-time tape counter will remain on the screen. You must press DISPLAY/STATUS/EXIT to remove it. Portions of the status display also may appear when you press other function buttons.

If you select STATUS ON and COUNTER ONLY OFF:

- Whenever you press STOP ■ (▼) or PLAY ► (▲) to stop or start tape playback, the status display will appear for five seconds. Portions of the status display also may appear when you press other function buttons.

If you select STATUS OFF:

- The status display will not appear when you press function buttons. You must press DISPLAY/STATUS/EXIT to see the status display.

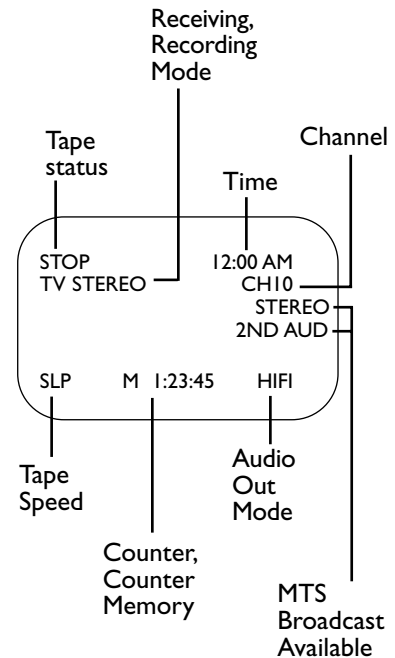

- 1 Press **VCR**, then press **DISC/MENU**.
- 2 Press **PLAY ► (▲)** or **STOP ■ (▼)** to select **VCR SET UP**, then press **FF ►► (►)**.
- 3 Press **PLAY ► (▲)** or **STOP ■ (▼)** to select **ON SCREEN MODE**, then press **FF ►► (►)**.
- 4 Press **PLAY ► (▲)** or **STOP ■ (▼)** to select **STATUS**, then press **FF ►► (►)** so **ON** or **OFF** appears beside **STATUS**.

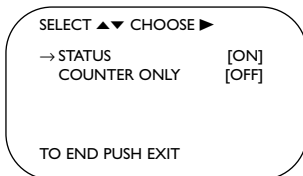

- 5 If you set **STATUS** to **OFF**, go to step 6. If you set **STATUS** to **ON**, press **PLAY ► (▲)** or **STOP ■ (▼)** to select **COUNTER ONLY**, then press **FF ►► (►)** so **OFF** or **ON** appears beside it.
- 6 Press **DISPLAY/STATUS/EXIT**.

Helpful Hints

- You may not access a status display when viewing a still picture, during slow motion playback, or during forward or reverse searching.
- The status display may not appear if a weak channel is selected and **BLUE BACKGROUND** is **OFF**. Details are on page 47.

Video Cassette Tape Recording 31

VCR

Read and follow the steps below to record a television program onto a video cassette tape. Before you begin, make sure the DVD/VCR is in VCR mode. Press OUTPUT SELECT so the green VIDEO light appears on the front of the DVD/VCR.

- 1** Turn on the TV and set it to channel 3 or 4, whichever channel the CH3/CH4 switch on the back of the DVD/VCR is set to. Or, if you connected the DVD/VCR to the TV using audio and video cables, select the correct audio and video in channel at the TV. *Details are on page 11.*
- 2** Insert a tape with its record tab intact into the cassette compartment of the DVD/VCR. If tape playback begins, press STOP ■ (▼).
- 3** If the VCR/TV light appears on the front of the DVD/VCR, go to step 4. If the VCR/TV light does not appear, press VCR, then press VCR/TV once.
- 4** Press SPEED until the desired tape speed (SP or SLP) appears briefly on the screen. *(Details about tape speed are on page 36.)*
- 5** Press CHANNEL/SKIP |◀◀|▶▶| (▼/▲) or the Number buttons to select the TV channel to be recorded.
- 6** Press REC/OTR once to start recording. The red REC light will appear on the front of the DVD/VCR.
- 7** To pause the recording, press PAUSE || once. The red REC light will flash. To resume recording, press REC/OTR or press PAUSE || again. The red REC light will come on again.
- 8** To stop recording, press STOP ■ (▼).

Recording Prevention

Video Cassettes have record tabs to ensure that recordings are not accidentally erased.

- 1** To prevent recording, break off the tab with a screwdriver.
- 2** To allow recording, cover the hole with clear tape.

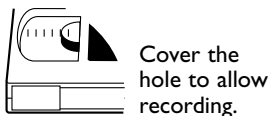

- 1** Turn on the TV.
- 2** Insert a tape in the DVD/VCR.

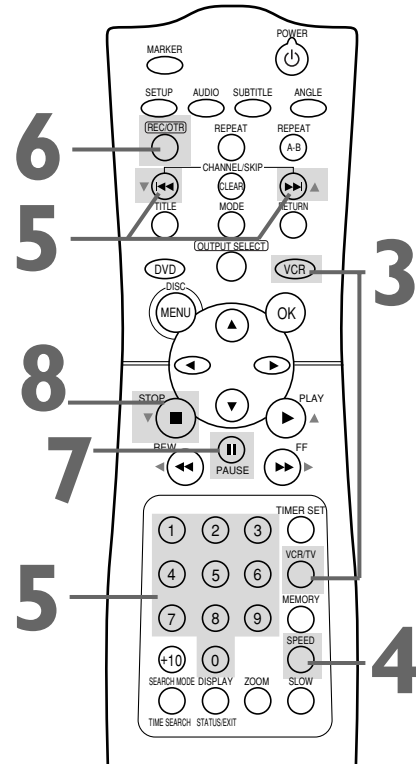

Helpful Hints

- If you press REC/OTR when there is not a tape in the DVD/VCR, NO CASSETTE will flash on the screen.
- If you press REC/OTR while a tape without a record tab is in the DVD/VCR, the DVD/VCR will eject the tape and PROTECTED CASSETTE CANNOT RECORD will flash on the screen.
- Other recording options are on pages 32-38.
- You can change the tape speed during a recording, but some distortion will appear on the tape.
- The DVD/VCR will record in a preset volume.

32 Recording One Channel/Watching Another

VCR

- Before you begin, place the DVD/VCR in VCR mode. Press OUTPUT SELECT so the green VIDEO light appears on the front of the DVD/VCR. Press VCR/TV so the green VCR/TV light appears on the front of the DVD/VCR.

- 1** Press **VCR**, then press **REC/OTR** to record the current TV channel. Details are on page 31.
- 2** Press **VCR/TV** once to put the DVD/VCR in TV position. The VCR/TV light will disappear from the front of the DVD/VCR.
- 3** Use the TV remote control to select the channel you want to watch at the TV.
- 4** To return to the channel being recorded, use the TV remote control to select channel 03 or 04 at the TV (the channel to which the CH3/CH4 switch on the back of the DVD/VCR is set). Or, if you connected the DVD/VCR to the TV using audio and video cables, select the correct audio and video in channel at the TV. Details are on page 11.
- 5** Press **VCR/TV** on the DVD/VCR remote control to put the DVD/VCR in VCR position. The VCR/TV light will appear on the front of the DVD/VCR. The channel being recorded will appear on the TV screen.
- 6** Press **STOP** ■ (▼) to stop the recording.

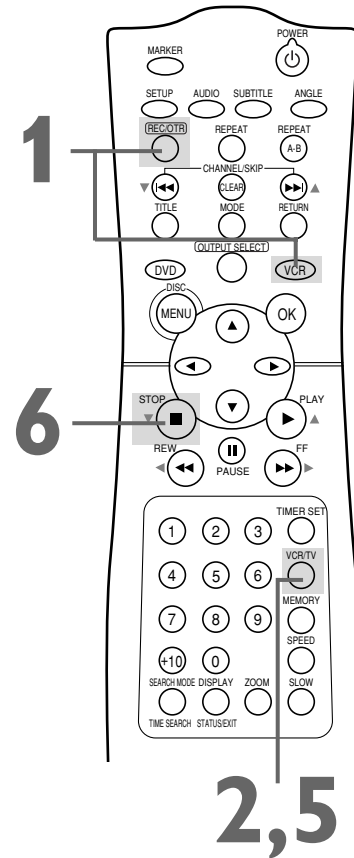

- 3** Select the channel you want to watch at the TV.

- 4** Select channel 03 or 04 at the TV.

Helpful Hint

- If you use a Cable Box or Direct Broadcast System hookup, you may not be able to watch one channel while recording another. See pages 9-10 for details.

One-Touch Recording 33

VCR

One-Touch Recording (OTR) lets you set an immediate timed recording 30 minutes to eight hours long. Before you begin:

- Place the DVD/VCR in VCR mode. Press OUTPUT SELECT so the green VIDEO light appears on the front of the DVD/VCR.
- Place the DVD/VCR in VCR position. Press VCR/TV so the green VCR/TV light appears on the front of the DVD/VCR.
- Set up the TV channels at the DVD/VCR. *Details are on page 24.*
- Select a recording speed (SP, SLP) with the SPEED button.
- Put a tape in the cassette compartment of the DVD/VCR. Make sure the tape's record tab is intact and the tape is long enough to record the program(s).
- If the end of a tape is reached during an OTR, the DVD/VCR will eject the tape. The DVD/VCR will switch to DVD mode immediately, and the TIMER light will blink. To let the OTR continue, insert another tape in the DVD/VCR.

To return to VCR mode, press TIMER on the front of the DVD/VCR to cancel the OTR, then press OUTPUT SELECT so the green VIDEO light appears on the front of the DVD/VCR.

1 Press **VCR**, then press **CHANNEL/SKIP** (◀◀/▶▶) (▼/▲) or the **Number** buttons to select the channel you want to record.

2 Press **REC/OTR** repeatedly until the desired recording length (30 minutes to eight hours) appears on the screen. Recording will begin immediately. The REC light and the TIMER light will appear on the front of the DVD/VCR.

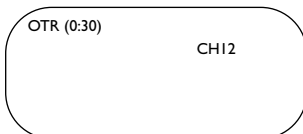

3 To stop an OTR before recording is finished, press **STOP** (■) (▼).

To cancel the OTR but continue recording, press REC/OTR repeatedly until REC appears in the upper left corner of the TV screen. (STATUS must be ON. See page 30 for details.) The REC light will remain on the front of the DVD/VCR, but the TIMER light will disappear.

When the OTR finishes, if no timer recordings are set, the TIMER light will blink. The DVD/VCR will switch to DVD mode automatically. To return to VCR mode, press TIMER SET to turn off the TIMER light, then press OUTPUT SELECT so the green VIDEO light appears on the front of the DVD/VCR.

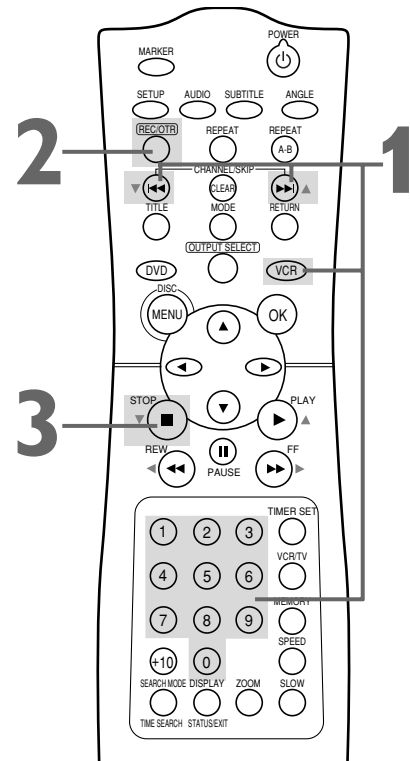

Helpful Hints

- To check the time remaining for an OTR, press DISPLAY/STATUS/EXIT.
- To change the recording length while an OTR is in progress, press REC/OTR until the desired length appears on the screen.
- You can begin an OTR when another recording is paused.
- You cannot pause an OTR.
- If the preset time for a timer recording comes up during an OTR, the OTR has priority. A message will remind you when the timer recording was scheduled to begin. You may let the OTR continue; the timer recording will not take place. Or, press STOP (■) (▼) to stop the OTR and press TIMER SET immediately. The timer recording will take place if you press TIMER SET before the timer recording's scheduled start time.

34 Timer Recording

VCR

Follow the steps below to program your DVD/VCR to record TV programs while you're away from home. Before you begin:

- Set up the TV channels at the DVD/VCR. *Details are on page 24.*
- Set the clock. If the clock is not set, **CLOCK MUST BE SET** will appear on the TV screen briefly after you select **PROGRAM**, followed by the VCR menu. Follow the directions on page 27 to set the VCR's clock.
- Put a tape in the cassette compartment of the DVD/VCR. Make sure the tape's record tab is intact and the tape is long enough to record the program(s).
- Press **OUTPUT SELECT** so the green **VIDEO** light appears on the front of the DVD/VCR.
- Press **VCR/TV** so the green **VCR/TV** light appears on the front of the DVD/VCR.

Do each step within 60 seconds of the previous step.

1 Press **VCR**, then press **DISC/MENU**.

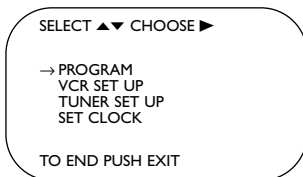

2 Press **PLAY ► (▲)** or **STOP ■ (▼)** to select **PROGRAM**, then press **FF ►► (▶)**.

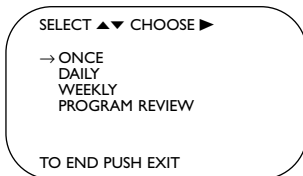

3 Press **PLAY ► (▲)** or **STOP ■ (▼)** to select a **ONCE**, **DAILY**, or **WEEKLY** recording. Then, press **FF ►► (▶)**.

- **ONCE:** The DVD/VCR will record a TV program on any day you choose, up to 12 months away.
- **DAILY:** The DVD/VCR will record the same channel every day from Monday to Friday – starting at the same time and recording for the same length of time.
- **WEEKLY:** The DVD/VCR will record the same channel on the same day, at the same time, and for the same length of time every week.

Daily Recording (example)

DAILY PROGRAM (MON-FRI)
PROGRAM -1 2 3 4 5 6 7 8-

SELECT PROGRAM NUMBER
TO END PUSH EXIT

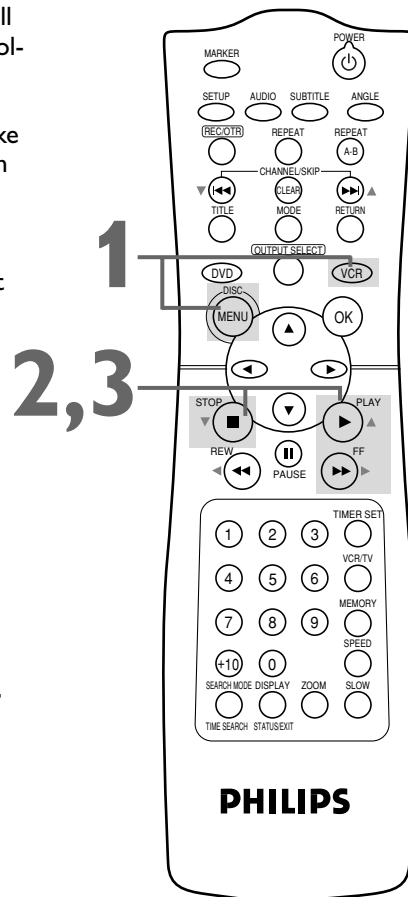

Helpful Hint

- To make a correction while programming a timer recording, press **CLEAR** until the cursor is flashing on the item you want to change. Then enter the correct information.

Timer Recording (cont'd) 35

4 Use the Number buttons (1-8) to select a slot in which to store the timer recording. There are eight slots. Numbers for open slots will flash on the screen.
NOTE: If you enter a number for a slot that has already been used to store a timer recording, PREVIOUSLY SET PROGRAM will appear on the screen briefly. Information about the program in that slot will appear on the screen. If this happens, press DIS-PLAY/STATUS/EXIT, then select another number.

5 Use the Number buttons to enter the TV channel you want to record.

- Cable TV Users, enter channel numbers as a two-digit number for the quickest results. For example, to select channel 6, press 0,6. If you only press the Number 6 button, channel 6 will be selected after a brief delay. There also may be a brief delay when you select channels 10, 11, and 12. If you want to select channels 100 and above, enter channel numbers as a three-digit number. For example, to select channel 117, press 1, 1, 7.
- Antenna Users, enter channel numbers as a two-digit number for the quickest results. For example, to select channel 5, press 0,5. If you only press the Number 5 button, channel 5 will be selected after a brief delay. You may only select channels 2-69.
- If you are recording from line input, press 0,0 to select AV REAR. See *Helpful Hints* below.
- If you are using a Cable Box/DBS, select the Cable Box/DBS output channel (03 or 04). Set the Cable Box/DBS to the channel you want to record. **Leave the Cable Box/DBS on for the timer recording.** Details are on page nine.

6 Press two Number buttons for the hour you want the recording to begin. Press two Number buttons for the minute you want the recording to begin. Press 1 for AM or 2 for PM. For example, for 9:30 PM, press 09, 30, 2.

```
ONE TIME PROGRAM
PROGRAM      1
CHANNEL      10
TIME ON      --:--
```

TO CORRECT PUSH CLEAR
TO END PUSH EXIT

7 Follow the instructions in step 6 to enter the recording's stop time. (AM or PM will be set automatically.)

```
ONE TIME PROGRAM
PROGRAM      1
CHANNEL      10
TIME ON      09:30 PM
TIME OFF     --:--
```

TO CORRECT PUSH CLEAR
TO END PUSH EXIT

Instructions continue on page 36.

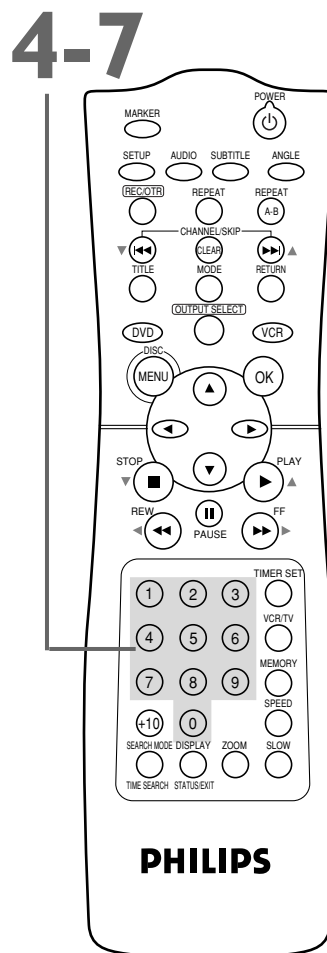

Helpful Hints

- Entries that do not match the DVD/VCR's clock or calendar will cause a question mark to appear on the screen.
- If you are recording from line input, connect the audio and video cables to the AUDIO IN and VIDEO IN jacks on the back of the DVD/VCR. (Please see illustration on page 38.)
- The +10 Number button has no effect in VCR mode, so do not use it to enter TV channel numbers at step 5.

36 Timer Recording (cont'd)

- 8** Press the **Number 1** button to record in **SP** speed or the **Number 2** button to record in **SLP** speed. (See the chart below.) You cannot use the **SPEED** button at this time.

```

ONE TIME PROGRAM
PROGRAM      1
CHANNEL     10
TIME ON     09:30 PM
TIME OFF    11:00 PM
REC SPEED   SLP
SP=1  SLP=2
  
```

TO CORRECT PUSH CLEAR
TO END PUSH EXIT

- 9** Press two **Number** buttons for the month and two **Number** buttons for the day you want to record the program. For example, for July 10, 2002, press 07, 10. The day of the week and the year will appear automatically. (You cannot program the DVD/VCR to record more than one year in advance.)

```

ONE TIME PROGRAM
PROGRAM      10
CHANNEL     10
TIME ON     09:30 PM
TIME OFF    11:00 PM
REC SPEED   SLP
START DATE  07/10/02
            WED.
  
```

TO CORRECT PUSH CLEAR
TO END PUSH EXIT

- 10** Press **DISPLAY/STATUS/EXIT**. PROGRAM WAS COMPLETED/PLEASE PUSH TIMER-SET FOR TIMER RECORDING will appear on the screen briefly. (If PROGRAM NOT COMPLETED appears, try again from step 1.)

- 11** Press **TIMER SET**. The **TIMER** light will appear on the front of the DVD/VCR. The DVD/VCR will be in DVD mode. The VCR/TV light will disappear, meaning the DVD/VCR is in TV position.

If the timer recording will take place several hours or days from now, you may use the DVD/VCR until time for the recording. (See Helpful Hints at right.) Press **TIMER SET** a few minutes before the recording starts.

If you forget to press **TIMER SET**, PLEASE PUSH TIMER-SET FOR TIMER RECORDING flashes on your TV screen two minutes before a timer recording starts. Press **CLEAR** to remove the message, then press **TIMER SET**.

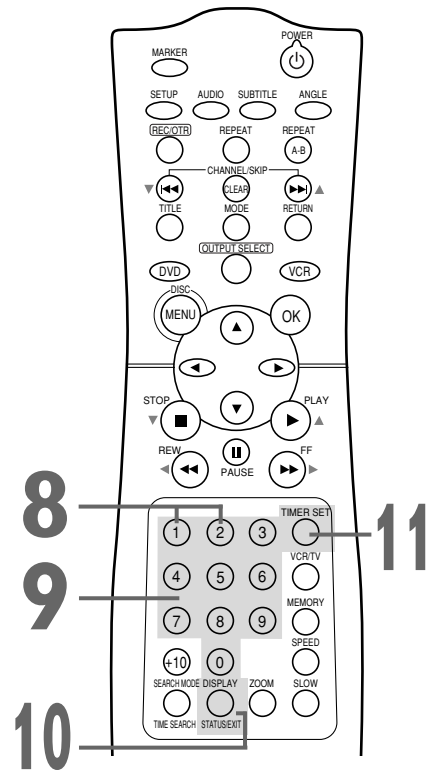

Helpful Hints

- When all timer recordings are finished, the **TIMER** light will flash. To use the DVD/VCR again as usual, press **TIMER SET** to disable the flashing **TIMER** light, then press **VCR/TV** to select VCR position. The green **VCR/TV** light will appear. Press **OUTPUT SELECT** to choose VCR or DVD mode, then continue with other features as described in this manual.
- When timer recordings are set, the **TIMER** light will appear. To use the DVD/VCR as usual until time for the recording, press the **TIMER SET** button so that the **TIMER** light disappears. Press **VCR/TV** to choose VCR position. The **VCR/TV** light will appear. Press **OUTPUT SELECT** to choose VCR or DVD mode, then continue with other features as described in this manual.

Tape Speeds

This chart shows the recording/playback time for three types of video cassettes (T160, T120, and T60). There are three playback speeds: SP, LP, and SLP. You can record in SP or SLP speed. You cannot record in LP speed.

The slower the tape speed, the more recording you can put on a tape. SLP is the slowest tape speed.

Tape Speed	Cassette type/Playback Time		
	T160	T120	T60
SP (standard play)	2 hrs. 40 mins.	2 hrs.	1 hr.
LP (long play) (playback only)	5 hrs. 20 mins.	4 hrs.	2 hrs.
SLP (super long play)	8 hrs.	6 hrs.	3 hrs.

Timer Recording (cont'd) 37

Checking or Cancelling Timer Recordings

- Before you begin, place the DVD/VCR in VCR mode.
Press OUTPUT SELECT so the green VIDEO light appears on the front of the DVD/VCR.

- 1 With the DVD/VCR on and in VCR mode and in VCR position (press VCR/TV so the green VCR/TV light appears on the front of the DVD/VCR), **press VCR, then press DISC/MENU.**
- 2 Press **PLAY ► (▲)** or **STOP ■ (▼)** to select **PROGRAM**, then press **FF ►► (▶)**.
- 3 Press **PLAY ► (▲)** or **STOP ■ (▼)** to select **PROGRAM REVIEW**, then press **FF ►► (▶)**. The timer recording information for the program in the lowest numbered slot will appear on the screen. If no timer recordings are set, nothing will happen when you press **FF ►► (▶)**.
- 4 Press **FF ►► (▶)** repeatedly to review all programmed timer recordings. If you don't press **FF ►► (▶)** within 10 seconds, the DVD/VCR will automatically display information about the next programmed timer recording. This will continue until all timer recordings have been displayed. Then the menu will disappear.
- 5 To cancel the timer recording displayed, press **CLEAR**. Either the display will disappear or information about other timer recordings will appear. If you do not press any other buttons, the display will disappear after all timer recordings have been displayed.
- 6 Repeat steps 1-4 to make sure you have cleared the correct timer recording.

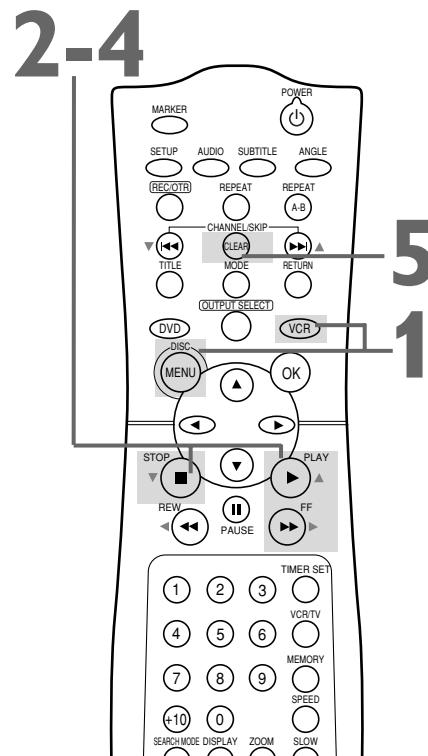

Helpful Hints

- *CLASH* may flash on the screen when you finish setting a timer recording. The timer recording you just tried to program overlaps another timer recording. The timer recording you were trying to set will not occur. You may cancel the other overlapping timer recording.
- To stop a started timer recording, press **STOP/EJECT** or **TIMER** on the front of the DVD/VCR.
- Power failures will erase timer recordings.
- If the preset time for a timer recording comes up during an OTR, the OTR has priority. A message will remind you when the timer recording was scheduled to begin. You may let the OTR continue; the timer recording will not take place. Or, press **STOP ■ (▼)** to stop the OTR and press **TIMER SET** immediately. The timer recording will take place if you press **TIMER SET** before the timer recording's scheduled start time.

See page 76 for more hints.

38 Rerecording (Tape Duplication)

VCR

The instructions on this page show you how to copy tapes. The illustration uses two DVD/VCRs. Different VCRs may operate differently.

1. Audio cables from DVD/VCR AUDIO OUT Jacks of DVD/VCR 1 to AUDIO IN Jacks of DVD/VCR 2

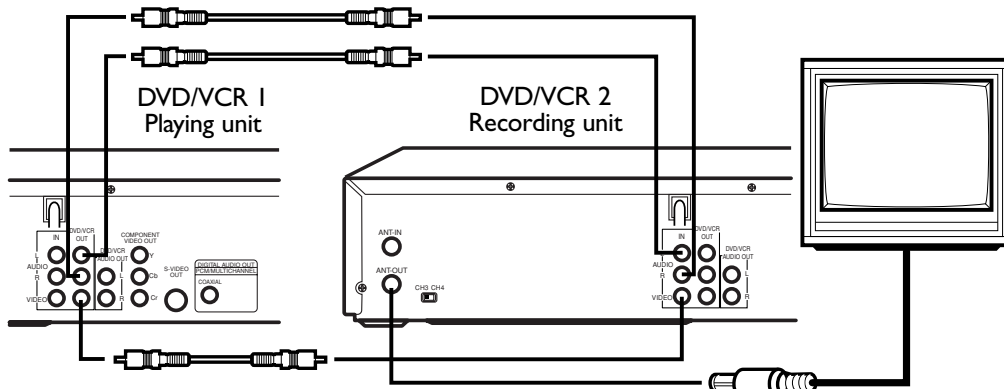

2. Video cable from DVD/VCR VIDEO OUT Jack of DVD/VCR 1 to VIDEO IN Jack of DVD/VCR 2

3. RF coaxial cable from the ANT-OUT (Antenna Out) jack of DVD/VCR 2 to the TV's ANTENNA IN Jack

1 Make the connections shown above.

2 DVD/VCR 1 will play your tape. **Put a prerecorded tape into the cassette compartment of DVD/VCR 1.** The DVD/VCR must be in VCR mode and VCR position. (The green VIDEO light and the green VCR/TV light will appear on the front of the DVD/VCR.)

3 DVD/VCR 2 will record your tape. **Insert a blank tape in the cassette compartment of DVD/VCR 2.** The DVD/VCR must be in VCR mode and VCR position. (The green VIDEO light and the green VCR/TV light will appear on the front of the DVD/VCR.)

4 Turn on the TV and set it to channel **03** or **04**, whichever channel the CH3/CH4 switch on DVD/VCR 2 is set to.

5 Point the remote control at DVD/VCR 2. Press **VCR**, then press the Number buttons **0, 0, 1** or **0, 0, 2**. (See Helpful Hints at right.)

6 Press **SPEED** to select **SP** or **SLP** at DVD/VCR 2.

7 Press **PLAY (VCR)** on the front of DVD/VCR 1 and **REC/OTR** on the front of DVD/VCR 2 at the same time.

To stop recording, press STOP/EJECT on DVD/VCR 1, then press STOP/EJECT on DVD/VCR 2.

Helpful Hints

- If you use the AUDIO and VIDEO IN Jacks on the back of DVD/VCR 2, press Number buttons 0, 0, 1 at step 5. AV REAR will appear on the TV screen.
- If you use the AUDIO and VIDEO In Jacks on the front of DVD/VCR 2, press Number buttons 0, 0, 2 at step 5. AV FRONT will appear on the TV screen.
- Unauthorized recording of copyrighted television programs, video tapes, or other materials may infringe on the rights of copyright owners and violate copyright laws.
- If a program has copyright protection, it may not record clearly.
- These instructions show you how to copy tapes using two DVD/VCRs like yours. Different VCRs may operate differently.
- You cannot record DVD material onto a video cassette using a single unit.

Repeat Play 39

VCR

Follow the steps below to play a video cassette repeatedly.

- Before you begin, place the DVD/VCR in VCR mode.
Press OUTPUT SELECT so the green VIDEO light appears on the front of the DVD/VCR.

1 Press VCR, then press DISC/MENU.

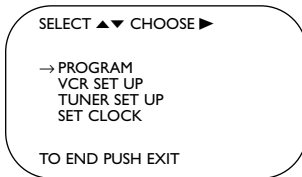

2 Press PLAY ► (▲) or STOP ■ (▼) to select VCR SET UP, then press FF ►► (►).

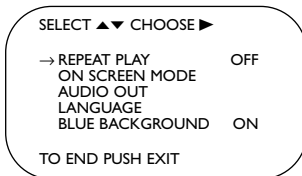

3 Press PLAY ► (▲) or STOP ■ (▼) to select REPEAT PLAY.

4 Press FF ►► (►) so ON appears beside REPEAT PLAY.

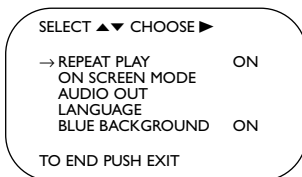

5 Press DISPLAY/STATUS/EXIT. Now, when a tape has finished playing, the DVD/VCR will rewind it and start play-back again.

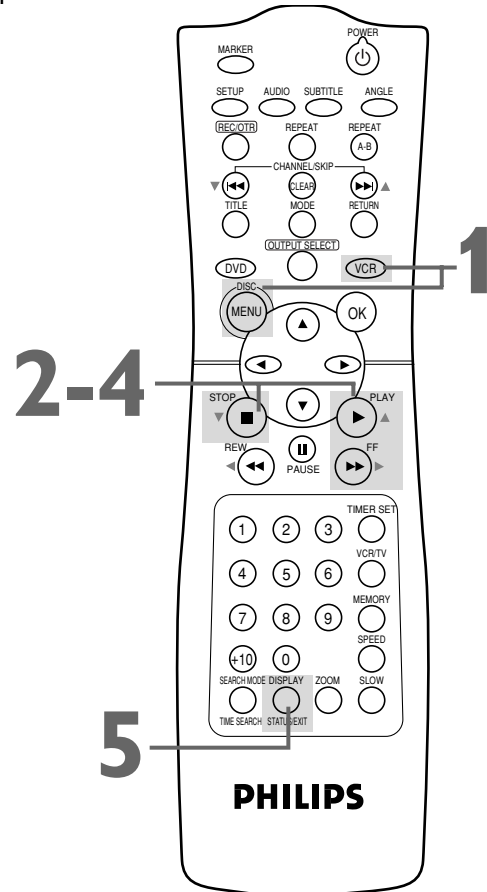

Helpful Hints

- To cancel Repeat Play, follow steps 1-3 above. At step 4, press FF ►► (►) so OFF appears beside REPEAT PLAY. Press DISPLAY/STATUS/EXIT.
- The real-time tape counter memory does not function during Repeat Play.

40 Real-Time Tape Counter Memory

VCR

Follow the steps below to reset the real-time tape counter to zero at a tape location you want to refer to later.

- Before you begin, place the DVD/VCR in VCR mode.

Press **OUTPUT SELECT** so the green **VIDEO** light appears on the front of the DVD/VCR.

- 1 Press **VCR**, then play, fast forward, or rewind a tape to the location that you would like to refer to later. Press **STOP** ■ (▼) to stop the tape.

- 2 Press **DISPLAY/STATUS/EXIT** to see the status display.

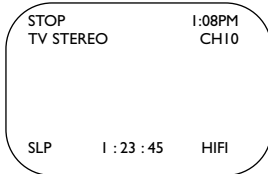

- 3 While the status display is on the screen, press **CLEAR** to reset the real-time tape counter to zero.

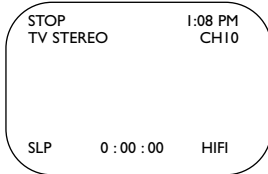

- 4 While the real-time tape counter is on the screen, press **MEMORY** so **M** appears beside the counter.

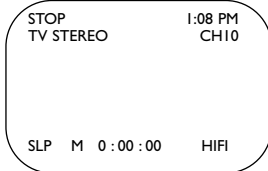

- 5 To go to a tape location where the real-time tape counter was reset to zero, press **REW** ◀◀ (◀) or **FF** ▶▶ (▶) when playback is stopped.

When the tape reaches the point at which the counter was set to zero, the tape will stop. Press **PLAY** ▶ (▶) to watch the tape.

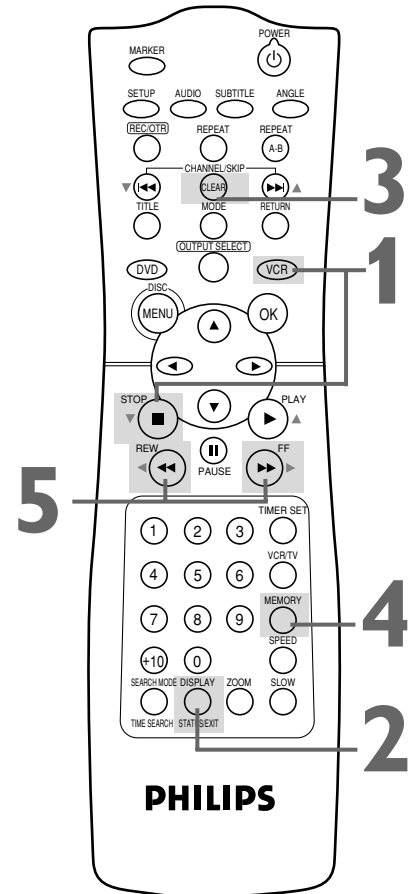

Helpful Hints

- The **MEMORY** button does not function if **REPEAT PLAY** is **ON**. Details are on page 39.
- To erase a real-time tape counter memory, press **MEMORY** until the **M** disappears from the screen.
- You may only set the real-time tape counter to zero at one location at a time. Setting the real-time tape counter to zero at a second location will erase the previous zero setting.
- If you remove the tape, the counter will reset to zero at the point at which you last stopped playback whenever you reinsert the tape.

Time Search 41

VCR

Follow the steps below to program the DVD/VCR to search forward or backward on a tape a specific length of time. There must be a tape in the DVD/VCR.

- Before you begin, place the DVD/VCR in VCR mode. Press **OUTPUT SELECT** so the green **VIDEO** light appears on the front of the DVD/VCR. Press **VCR/TV** so the green **VCR/TV** light appears on the front of the DVD/VCR.

1 Press **VCR**, then press **SEARCH MODE/TIME SEARCH**.

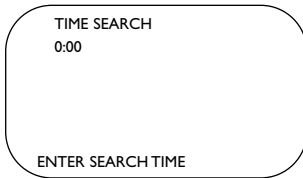

2 Within 10 seconds, use the **Number** buttons to enter the desired length of time you want to skip forward or backward. For example, for 1 hour, 25 minutes, press Number buttons 1, 2, 5. Or, for five minutes, press Number buttons 0, 0, 5.

3 Within 10 seconds, press **FF** ►► (►) or **REW** ◀◀ (◀). The DVD/VCR will skip over the specified length of time, then begin playback.

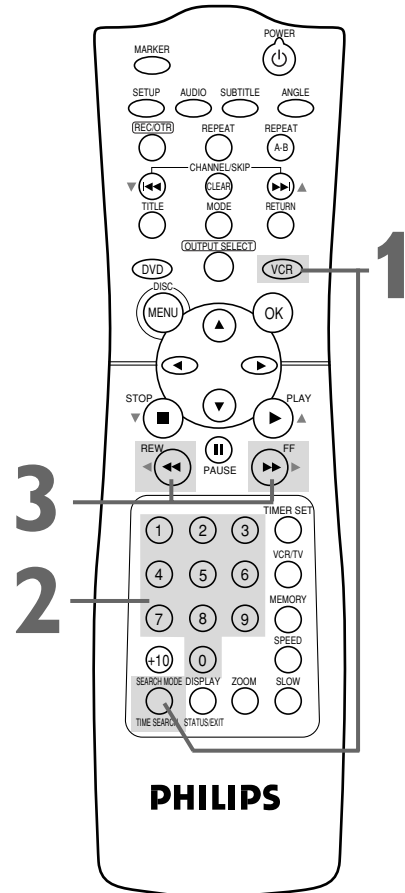

Helpful Hints

- If you want to search for more than 59 minutes, you must enter the length of time in hours and minutes. For example, to search forward 70 minutes, press 1, 1, 0 at step 2.
- You cannot do a Time Search while recording.
- To remove the Time Search display, press **SEARCH MODE/TIME SEARCH** again.
- To cancel a Time Search that is in progress, press **STOP** (▼).
- If the end of the tape is reached during a Time Search, the Time Search will be cancelled. The DVD/VCR may rewind the tape. Details are on page 43.

42 Special Effects Playback

VCR

- Before you begin, press OUTPUT SELECT so the green VIDEO light appears on the front of the DVD/VCR. Press VCR/TV so the green VCR/TV light appears on the front of the DVD/VCR.

Forward and Reverse Searching (SP/LP/SLP)

- 1 During tape playback, press and release **FF** ►► (►) or **REW** ◄◄ (◄). A fast forward or reverse picture search will begin.
- 2 To return to playback, press **PLAY** ► (►).

Super High Speed Searching (LP/SLP)

- 1 During tape playback, press **FF** ►► (►) or **REW** ◄◄ (◄), then press **again**. The DVD/VCR will now search the tape in super high speed. Repeatedly pressing **FF** ►► (►) or **REW** ◄◄ (◄) will switch between regular and high speed searching.
- 2 To return to normal playback, press **PLAY** ► (►).

Viewing a Still Picture

- 1 During tape playback, press **PAUSE** |||. A still picture will appear on the screen.
- 2 To release the still picture and return to playback, press **PLAY** ► (►) or press **PAUSE** ||| again.

Viewing a Slow Motion Picture

- 1 During tape playback, press **SLOW**. The tape will play in slow motion.
- 2 To release Slow mode and return to normal playback, press **PLAY** ► (►) or press **SLOW** again.

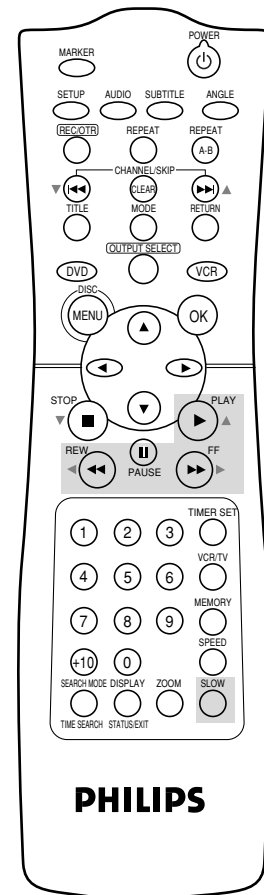

Helpful Hints

- Slow and Still modes will automatically switch to Stop mode after five minutes to protect the DVD/VCR and the tape from damage.
- SP/LP/SLP means this feature will work with tapes recorded in Standard Play, Long Play, or Super Long Play.
- LP/SLP means this feature will work with tapes recorded in Long Play or Super Long Play. For details about tape speed, see pages 36 and 73.

Automatic Operation Features 43

VCR

The following tape playback features are available in VCR mode. (Press OUTPUT SELECT so the green VIDEO light is on, if necessary.)

Automatic Playback

When you put a tape in the DVD/VCR, the power will come on automatically. If the tape's record tab is missing, playback will begin. If a timer recording is set and the TIMER light is flashing, the power will not come on automatically when you insert a tape with the record tab intact.

If a timer recording is set and the TIMER light is flashing, the DVD/VCR will eject the tape if the record tab is missing.

Automatic Rewind, Eject

When a tape is played, fast forwarded, or recorded to its end, the DVD/VCR will rewind the tape to the beginning, stop, then eject the tape. If REPEAT PLAY is ON, the DVD/VCR will not eject the tape automatically. The tape will begin to play again. *Details are on page 39.*

If the real-time tape counter memory is set, the DVD/VCR will only rewind the tape to the point at which the counter is set to zero, then stop. The DVD/VCR will not eject the tape automatically. *Details are on page 40.*

Tape Eject

A tape can be ejected with the DVD/VCR power on or off (but the DVD/VCR must be plugged in).

If a timer recording is set and the TIMER light is on, the tape cannot be ejected. To eject the tape, you must first press TIMER SET (or TIMER on the DVD/VCR) to cancel the timer recording, then press STOP/EJECT to remove the tape. To reset the timer recording, insert a tape, then press TIMER SET (or TIMER on the DVD/VCR).

Automatic Tracking Adjustment

The DVD/VCR adjusts tracking automatically to give you the best possible picture quality. With some recordings, however, you may get a better picture using the manual tracking controls (see below).

Manual Tracking

To manually adjust the tracking during normal playback and slow motion playback of a video cassette, press CHANNEL ▲/▼ on the DVD/VCR. (CHANNEL/SKIP ◀◀/▶▶ (▼/▲) on the remote control will not adjust tracking.)

Tracking will return to Automatic Tracking Adjustment when you press STOP ■ (▼) or insert a tape.

You cannot manually adjust the tracking of a Still picture. However, you may press CHANNEL ▲/▼ on the front of the DVD/VCR to remove vertical jitter in a Still picture.

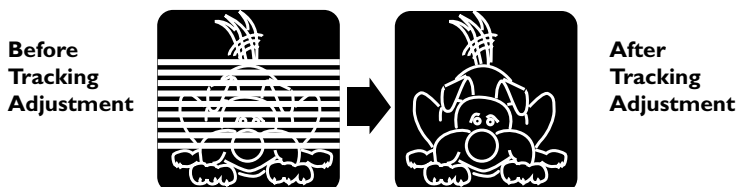

44 Multi-Channel Television Sound

VCR

Your DVD/VCR can play tapes recorded in Hi-Fi (high fidelity) stereo, which produces a crisp, clear sound from the left and right audio channels. Your DVD/VCR also can play tapes recorded in a second audio (usually, that means your program is recorded in a second language). Of course, your DVD/VCR will play tapes recorded in monaural (single-source) sound as well.

Your DVD/VCR also will record a video cassette in Hi-Fi stereo or in second audio, so when you play that tape on the DVD/VCR, it will be in stereo or second audio.

Read the directions on this page to familiarize yourself with your DVD/VCR's stereo and second audio setups. Then follow the directions on page 45 to record in stereo or second audio, or follow the directions on page 46 to play tapes recorded in Hi-Fi stereo.

Understanding On-Screen Displays

When you watch TV channels through the VCR, portions of the display shown below will appear when you press DISPLAY/STATUS/EXIT.

If 2ND AUD or TV STEREO appears here, your DVD/VCR is set to receive a second audio or stereo broadcast. (It cannot receive both at the same time.)

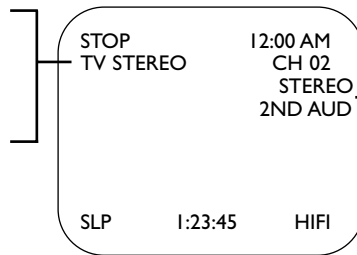

If 2ND AUD or STEREO appears here, the program you're watching is available in second audio or stereo. This indication is not available during tape playback. Even though a program is available in stereo or second audio, you still must program the DVD/VCR to receive or record the program. Follow the directions on page 45.

To record and play programs in stereo, use one of the connections shown, then follow the steps on pages 45-46. You could use the hookups shown on page 11 instead if you prefer and if your TV has right and left Audio In jacks.

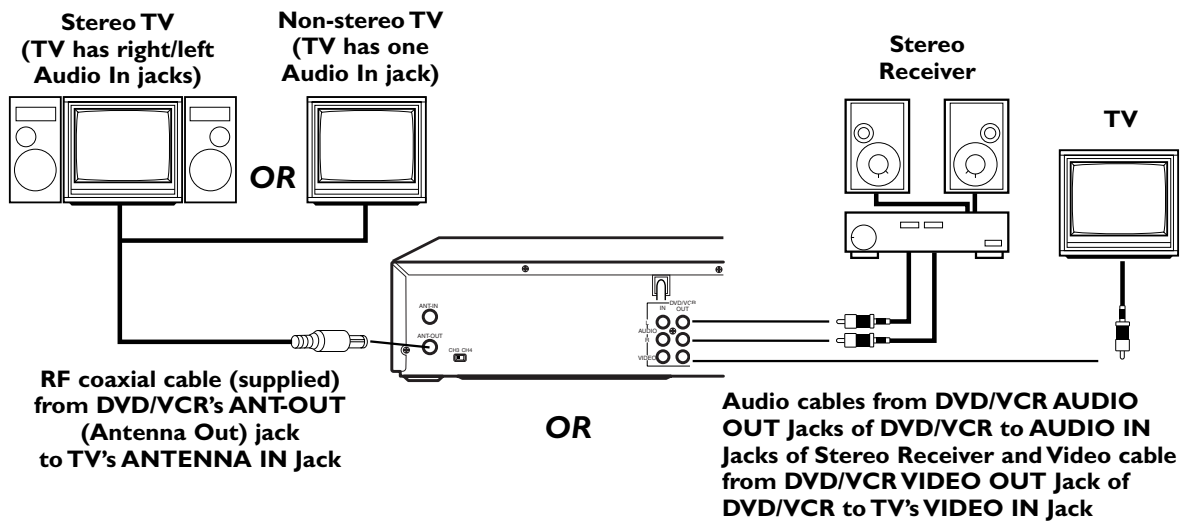

Multi-Channel Television Sound (cont'd) 45

VCR

- Before you begin, place the DVD/VCR in VCR mode. Press OUTPUT SELECT so the green VIDEO light appears on the front of the DVD/VCR. Press VCR/TV so the green VCR/TV light appears on the front of the DVD/VCR.

1 Press VCR, then press DISC/MENU.

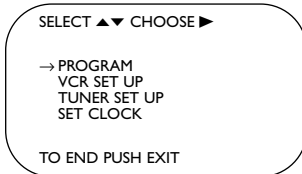

2 Press PLAY ► (▲) or STOP ■ (▼) to select TUNER SET UP, then press FF ►► (►).

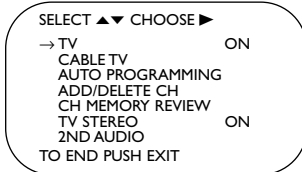

3 Press PLAY ► (▲) or STOP ■ (▼) to select TV STEREO or 2ND AUDIO. Then, press FF ►► (►). ON will appear to the right of your selection.

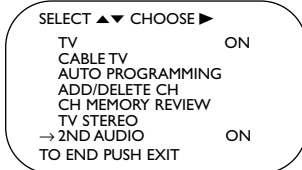

4 Press DISPLAY/STATUS/EXIT.

5 To record, select the channel to be recorded using CHANNEL/SKIP |◀◀/▶▶| (▼/▲) then go to step 6.

6 Press REC/OTR to start recording.

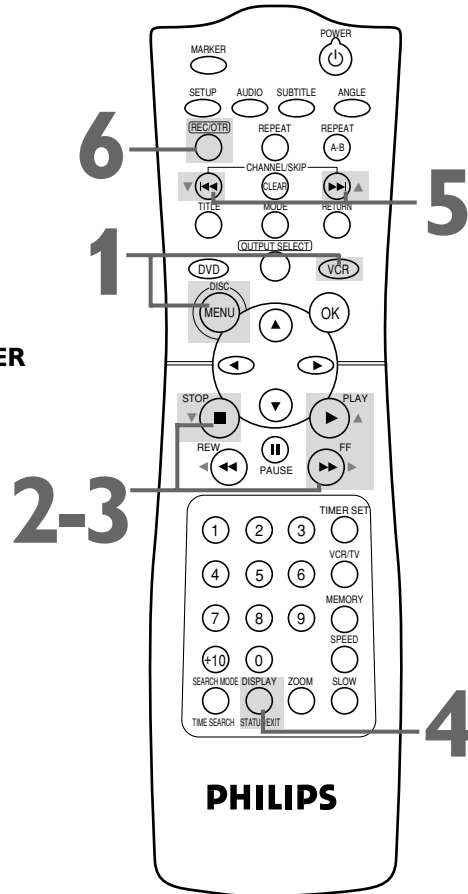

Helpful Hints

- You can only receive and record in stereo or second audio programs that are broadcast in stereo or second audio. You can only play in stereo or second audio tapes that were recorded in stereo or second audio. Please see page 44 to determine if the program you want to watch/record is being broadcast in stereo or second audio.
- If you select second audio when second audio is not available, the DVD/VCR will record normal audio.

46 Hi-Fi Stereo Sound

VCR

Multi-Channel Television Sound system broadcasts are automatically recorded in Hi-Fi stereo. To play in Hi-Fi stereo the tapes recorded in Hi-Fi stereo, however, follow steps 1-5 below.

- Before you begin, place the DVD/VCR in VCR mode. Press **OUTPUT SELECT** so the green **VIDEO** light appears on the front of the DVD/VCR. Press **VCR/TV** so the green **VCR/TV** light appears on the front of the DVD/VCR.

1 Press **VCR**, then press **DISC/MENU**.

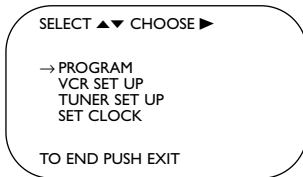

2 Press **PLAY ► (▲)** or **STOP ■ (▼)** to select **VCR SET UP**, then press **FF ►► (►)**.

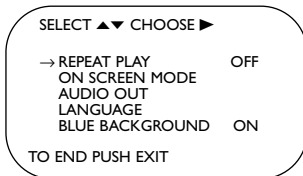

3 Press **PLAY ► (▲)** or **STOP ■ (▼)** to select **AUDIO OUT**, then press **FF ►► (►)**.

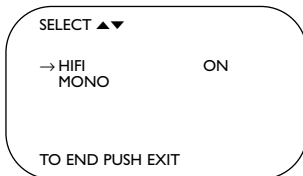

4 Press **PLAY ► (▲)** or **STOP ■ (▼)** to select **HIFI**. **ON** will appear to the right of **HIFI** on the screen.

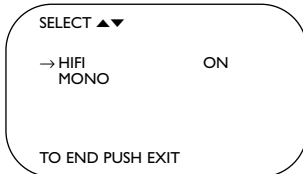

5 Press **DISPLAY/STATUS/EXIT**.

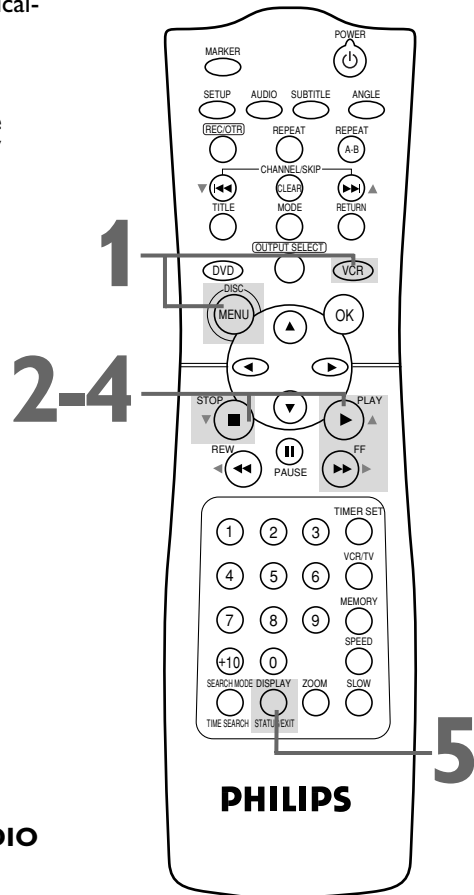

Helpful Hints

- If you want monaural audio playback, follow steps 1-3. At step 4, press **PLAY ► (▲)** or **STOP ■ (▼)** to select **MONO**. Press **DISPLAY/STATUS/EXIT**. **HIFI** will disappear from the status display.
- All programs are automatically recorded in both Hi-Fi stereo sound and in monaural sound.
- The audio level of a tape recorded in Hi-Fi stereo will differ from the audio level of a tape not recorded in Hi-Fi stereo.
- If you play non-Hi-Fi tapes while the DVD/VCR is set to HIFI, HIFI will disappear from the status display and the tape will play in monaural sound.

Please see additional notes on page 77.

Blue Background 47

VCR

If you want the TV screen to be solid blue when a weak signal is received, set BLUE BACKGROUND to ON. The screen will be blue and the sound will be muted.

Or, if you want to receive the weak signal, set BLUE BACKGROUND to OFF. When you select a channel that is receiving a weak signal, you will see and hear the static in the TV programming. The channel number will not appear on the screen when you select a weak channel.

To set BLUE BACKGROUND to ON or OFF, follow these steps.

- Before you begin, place the DVD/VCR in VCR mode. Press OUTPUT SELECT so the green VIDEO light appears on the front of the DVD/VCR. Press VCR/TV so the green VCR/TV light appears on the front of the DVD/VCR.

1 Press VCR, then press DISC/MENU.

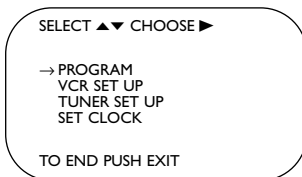

2 Press PLAY ► (▲) or STOP ■ (▼) to select VCR SET UP, then press FF ►► (►).

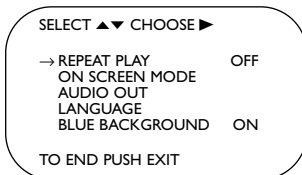

3 Press PLAY ► (▲) or STOP ■ (▼) to select BLUE BACKGROUND. Then, press FF ►► (►) repeatedly so OFF or ON appears beside BLUE BACKGROUND.

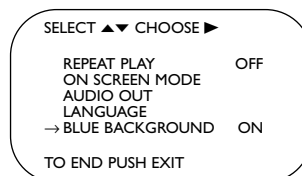

4 Press DISPLAY/STATUS/EXIT.

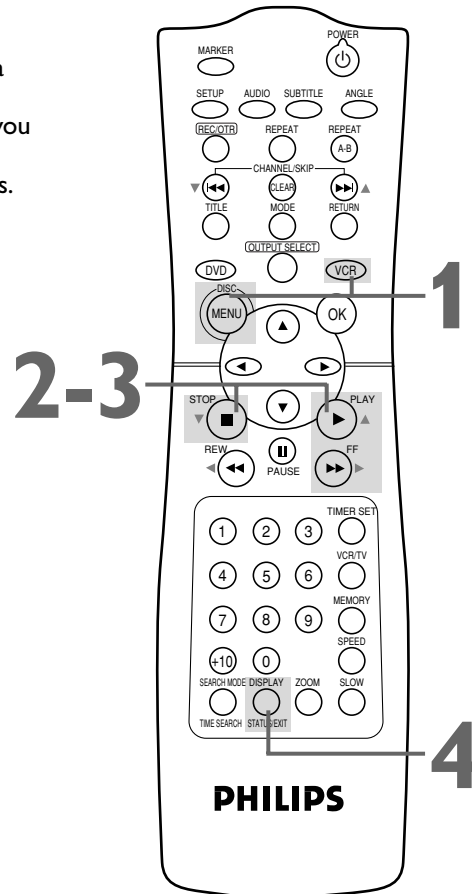

48 Disc Menus

DVD

Using the DVD Disc Menus

Some DVDs contain menus that describe the contents of the DVD or allow you to customize DVD playback. For example, the menu may offer choices for subtitle languages, special features, or scene selection. To use the DVD Disc menu and select playback features, follow these steps.

- Before you begin, place the DVD/VCR in DVD mode.
Press **OUTPUT SELECT** so the red DVD light appears on the front of the DVD/VCR.

- 1 Press DVD, then press DISC/MENU.** The DVD's main Disc menu will appear.
- 2 Press the Arrow buttons ▲ ▼ ◀ ▶ to select an item, then press OK.** Continue this process to set up all the features you wish to see on the DVD.

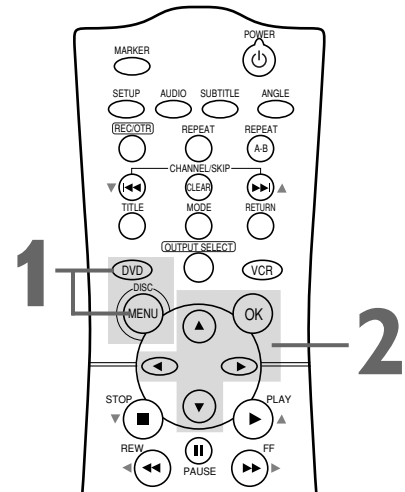

Using the Title Menu

Some DVDs have a Title Menu, which lists the Titles available on the DVD. Use the Title Menu to start playback at a specific Title.

- Before you begin, place the DVD/VCR in DVD mode.
Press **OUTPUT SELECT** so the red DVD light appears on the front of the DVD/VCR.

- 1 Press DVD, then press TITLE.** The Title Menu will appear.
If a Title menu is not available, the symbol may appear on the TV screen. Or, if the DVD only has a main Disc menu as described above, it may appear when you press **TITLE**.
- 2 Press the Arrow buttons ▲ ▼ ◀ ▶ to select the desired Title, then press OK.** Playback will begin at the Title you selected.

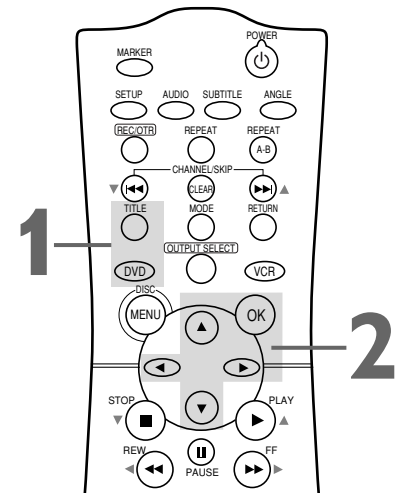

Helpful Hints

- Menus vary among DVDs. Follow the information accompanying the DVD.
- Not all DVDs have Title menus.
- Some DVDs may refer to Chapters as "scenes." Some DVDs may refer to the Title Menu as the "scene index."

Fast Forward/Reverse Search 49

DVD

AUDIO CD

- Before you begin, place the DVD/VCR in DVD mode. Press **OUTPUT SELECT** so the red DVD light appears on the front of the DVD/VCR.

1 During playback, press **DVD**, then press **FF** (▶▶) (▶) or **REW** (◀◀) (◀) on the remote control.

- During DVD playback, pressing **FF** (▶▶) (▶) or **REW** (◀◀) (◀) repeatedly will forward or reverse the picture at twice, eight times, 30 times, or 60 times the normal playback speed. An ◀◀ x2, ◀◀ x8, ◀◀ x30, or ◀◀ x60 will appear briefly on the TV screen to indicate reverse searching. Or, ▶▶ x2, ▶▶ x8, ▶▶ x30, or ▶▶ x60 will appear briefly on the TV screen to indicate fast forward searching. Sound will be muted during searching.
- During Audio CD playback, you may search forward or backward only at 16 times the normal playback speed. An ◀◀ x16 or ▶▶ x16 will appear briefly on the TV screen. Pressing **FF** (▶▶) (▶) or **REW** (◀◀) (◀) repeatedly will not affect the speed of the search. Sound will be intermittent during searching on an Audio CD.
- Use **FF** (▶▶) (▶) for a forward search. Press **REW** (◀◀) (◀) for a reverse search.

Example: Playing a DVD in reverse at twice the normal playing speed.



Example: Fast forwarding a DVD at twice the regular playback speed.



Example: Fast forwarding an Audio CD at 16 times the regular playback speed.



2 Press **PLAY** (▶) (▲) to return to normal playback.

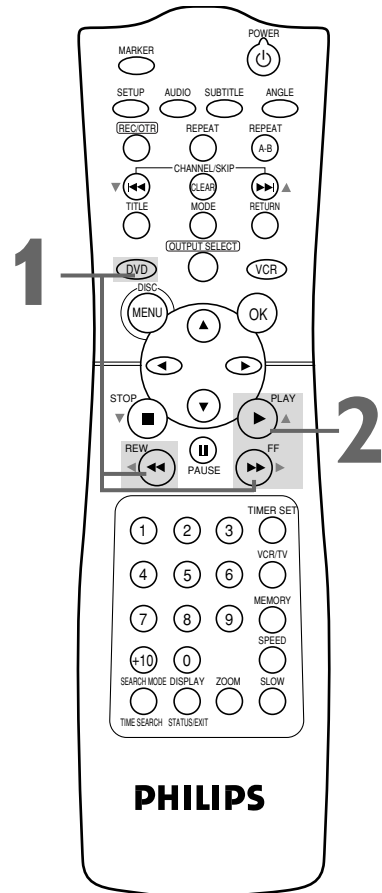

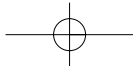

50 Specific Title/Chapter Playback, Specific Time Playback

DVD

Specific Title/Chapter Playback

- Before you begin, place the DVD/VCR in DVD mode.
Press OUTPUT SELECT so the red DVD light appears on the front of the DVD/VCR.

- 1** With a DVD in the DVD/VCR, press **DVD**, then press **SEARCH MODE/TIME SEARCH** once. The Title/Chapter Search display will appear on the TV screen.
- 2** To select the Title, press **▲** to select the Title space (beside TT), then press the Number buttons to enter the Title number. The Chapter space (beside CH) will be selected automatically.
- 3** Within 30 seconds, press the Number buttons to enter the Chapter number. In a few seconds, the selected Chapter will start playing.

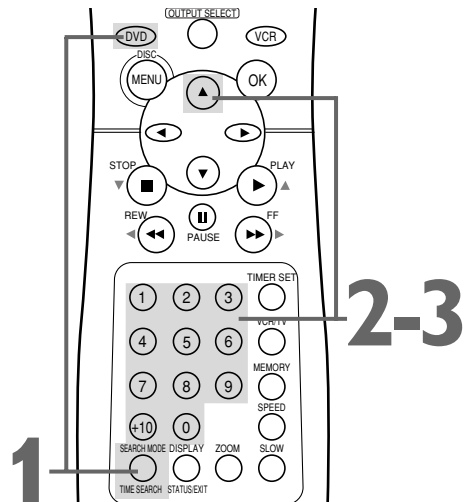
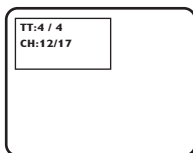

DVD

AUDIO CD

Specific Time Playback

- Before you begin, place the DVD/VCR in DVD mode.
Press OUTPUT SELECT so the red DVD light appears on the front of the DVD/VCR.

- 1** During playback, press **DVD**, then press **SEARCH MODE/TIME SEARCH** repeatedly so the Time Search display appears on the TV screen.

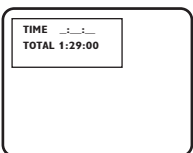

- 2** Within 30 seconds, use the Number buttons to enter the Disc time at which you want playback to begin. Enter the time in hours, minutes, and seconds. Within a few seconds, playback will start at the specified time.

- Example: 1 hour, 23 minutes, and 30 seconds
1 → 2 → 3 → 3 → 0
- Make sure the time you enter is within the total time of the current Title or Track. If it is not, the TIME space will clear and playback will continue at its current point.
- If you make a mistake, press CLEAR to erase all the information in the TIME space. Enter the correct information.

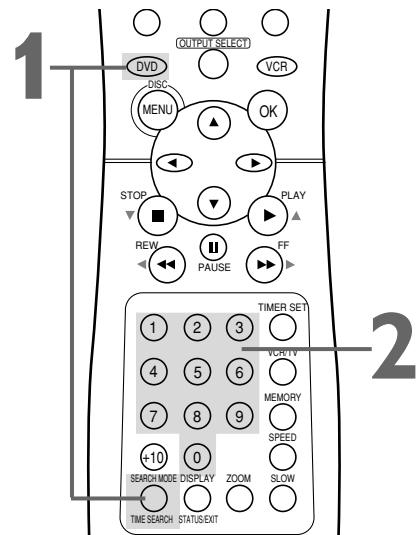

Helpful Hints

- Title/Chapter playback is not available with some DVDs.

Specific Track Playback 51

AUDIO CD

There are three ways to begin playback on an Audio CD at a specific Track: Use the Number buttons, the SEARCH MODE/TIME SEARCH button, or CHANNEL/SKIP \lll/\ggg (∇/\blacktriangle).

- Before you begin, place the DVD/VCR in DVD mode.

Press OUTPUT SELECT so the red DVD light appears on the front of the DVD/VCR.

A

Using the Number Buttons to Select a Track

During playback or when playback is stopped, press DVD, then press the Number buttons to enter the desired Track number. Playback will start at the selected Track.

For single-digit Tracks (1-9), press a single Number button.

For Tracks 10 and above, press the +10 button so the Search display appears on the TV screen. Press the Number button of the first digit, then press the Number button of the second digit.

For example, to play Track 26, press +10, then Number 2, then Number 6.

If you enter a Track number that is not available on the Disc, playback will not begin (or the current Track will continue to play). The space beside TR will clear automatically in the Search display.

B

Using SEARCH MODE/TIME SEARCH to Select a Track

Press DVD, then press SEARCH MODE/TIME SEARCH once so the Track Search display appears. Within 30 seconds, press the Number buttons to select the Track number you desire. Playback will begin at the selected Track. For a single-digit Track (1-9), enter a zero first. For example, to play Track 5, press 0, 5.

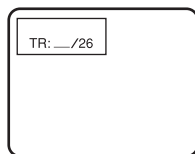

C

Using CHANNEL/SKIP \lll/\ggg (∇/\blacktriangle) to Select a Track

During playback, press DVD, then press CHANNEL/SKIP \ggg (\blacktriangle) to skip the current Track and move to the next Track. The Track number will appear briefly on the DVD/VCR display panel.

During playback, press CHANNEL/SKIP \lll (∇) to return to the beginning of the current Track or to go to previous Tracks. The Track number will appear briefly on the DVD/VCR display panel.

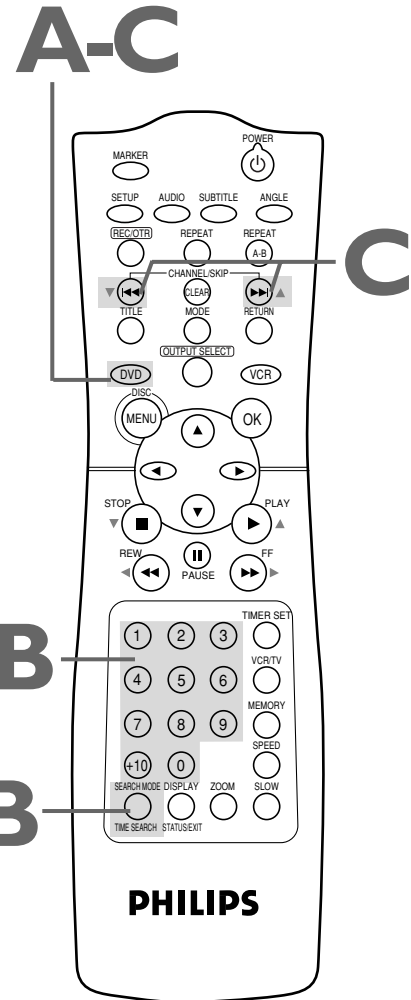

Helpful Hints

- You cannot use CHANNEL/SKIP \ggg (\blacktriangle) to go from the last Track on the disc to the first Track.
- If you press CHANNEL/SKIP \lll/\ggg (∇/\blacktriangle) when playback is paused, the selected Track will begin playing automatically.

52 Paused and Step-by-Step Playback, Resuming Playback

DVD
AUDIO CD

Paused and Step-by-Step Playback

- 1** During playback, press **DVD**, then press **PAUSE** **||**. Play will pause and the sound will be muted.
- 2** When playing a **DVD**, press **PAUSE** **||** repeatedly to see the picture advance one frame (or step) at a time. The sound will remain mute. Pressing **PAUSE** **||** repeatedly during Audio CD playback will have no effect.
- 3** Press **PLAY** **▶** (**▲**) to resume playback.

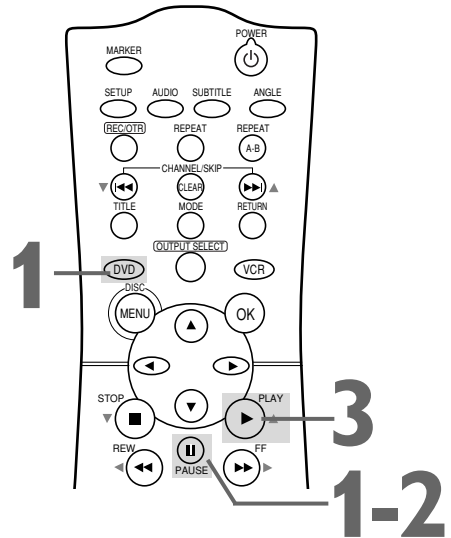

DVD
AUDIO CD

Resuming playback

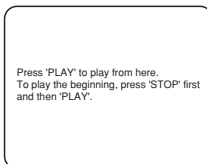
- 1** Press **DVD**, then press **STOP** **■** (**▼**) during disc playback. In a few seconds, the following Resume message will appear on the TV screen.

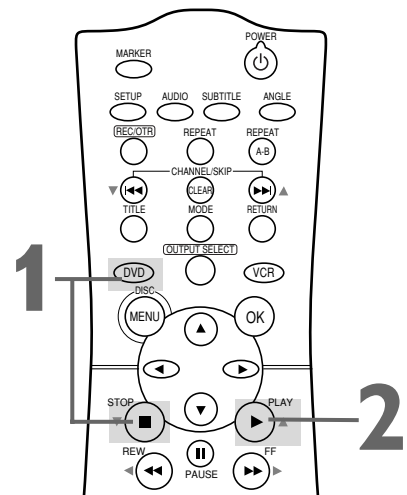

- 2** Press **PLAY** **▶** (**▲**). In a few seconds, playback will resume from the point at which playback stopped last. You can resume play at the same point even if you turn off the DVD/VCR, then turn it on again later. However, opening the disc tray will cancel the Resume feature.



Helpful Hint

- To cancel resume playback and start playing the disc from the beginning, press **STOP** **■** (**▼**) a second time while playback is stopped. The Stop Symbol (**■**) will appear briefly on the TV screen. Press **PLAY** **▶** (**▲**) to start playing the disc from the beginning.

Repeat, A-B Repeat 53

DVD
AUDIO CD

Repeat

- Before you begin, place the DVD/VCR in DVD mode. Press OUTPUT SELECT so the red DVD light appears on the front of the DVD/VCR.

- During disc playback, press **DVD**, then repeatedly press **REPEAT** until the repeat mode you want appears on the TV screen as shown in the examples below. On a DVD, press REPEAT repeatedly to select REPEAT [CHAPTER], REPEAT [TITLE], or REPEAT [OFF]. Selecting a new Chapter or Title will cancel repeat playback. On an Audio CD, press REPEAT repeatedly to select REPEAT [TRACK], REPEAT [ALL], or REPEAT [OFF]. Selecting a new Track will cancel repeat playback.



Example: Repeat a DVD Chapter



Example: Repeat an Audio CD Track

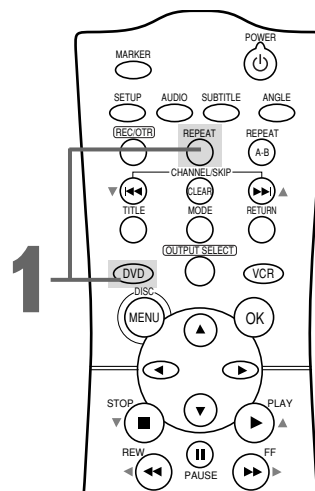

DVD
AUDIO CD

A-B Repeat

Follow these steps to play a section of a Disc repeatedly.

- Before you begin, place the DVD/VCR in DVD mode. Press OUTPUT SELECT so the red DVD light appears on the front of the DVD/VCR.

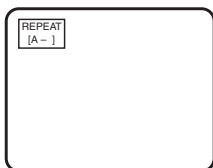
- Press **DVD**, then press **PLAY** (▶) to play the Disc to the point at which you want repeated playback to begin.
- Press **A-B REPEAT** to set the starting point (A). REPEAT [A -] will appear on the TV screen.



- Play or fast forward the Disc to the point at which you want repeated playback to end, then press **A-B REPEAT** again. REPEAT [A-B] will appear on the TV. The section will begin to play repeatedly.

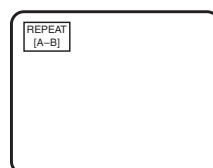

- To cancel A-B Repeat, press **A-B REPEAT** so REPEAT [OFF] appears on the TV. Regular playback will resume.

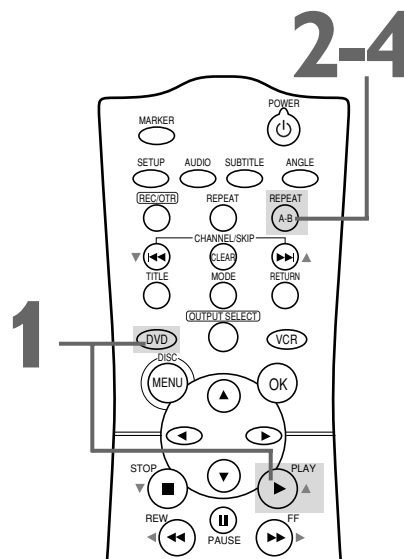

Helpful Hints

- Repeat playback and A-B Repeat are not available with all Discs.
- The entire A-B Repeat section must be within a single Title or Track. If you do not enter Point B before the end of the Track or Title is reached, the end of the Track or Title will become Point B automatically.
- Point B must be later on the Disc than Point A.
- Pressing STOP (■) (▼) will cancel A-B Repeat.

54 Markers

DVD

AUDIO CD

Use Markers to remember your favorite places on a disc. To set the Markers, follow these steps.

- Before you begin, place the DVD/VCR in DVD mode. Press OUTPUT SELECT so the red DVD light appears on the front of the DVD/VCR.

- 1 Play the Disc to within 30 seconds prior to the point at which you want to set the Marker. **During playback, press DVD, then press MARKER.** The Markers will appear at the top of the TV screen for 30 seconds.

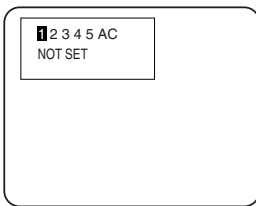

- 2 Within 30 seconds, press ◀ or ▶ to select 1, 2, 3, 4, or 5. Make sure "NOT SET" appears beneath the number.

- 3 Let the Disc continue to play to the point at which you want to set the Marker (up to 30 seconds). When the Disc reaches the point you want to remember, press OK. The Title and elapsed playing time (DVD) or Track and its elapsed playing time (Audio CD) will appear in the display.

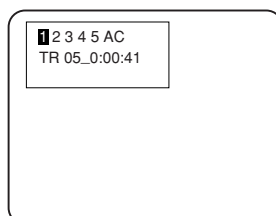
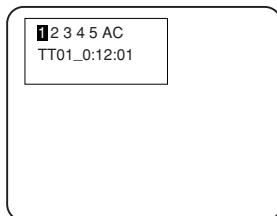

- 4 To return to the Marker later, press MARKER during playback. Press ◀ or ▶ to choose the Marker you want, then press OK. Disc play will continue from the marked point.

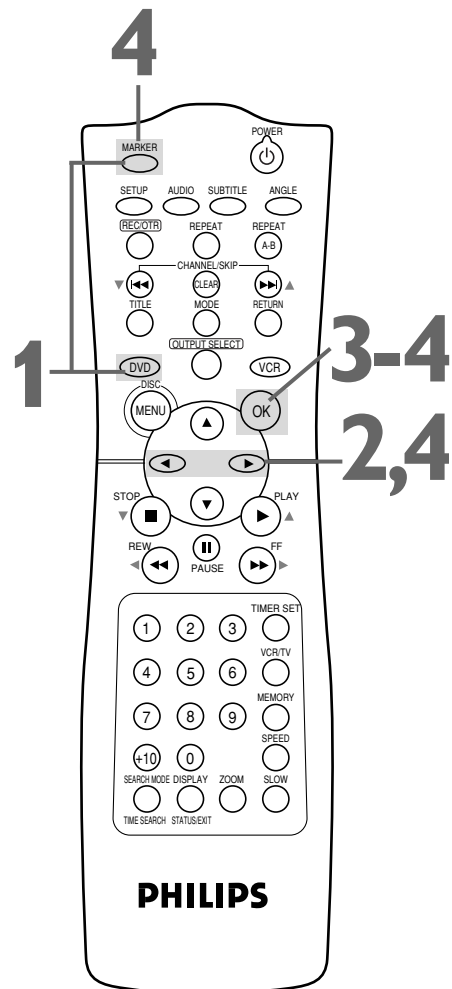

Helpful Hints

- Opening the disc tray or turning off the DVD/VCR will erase all the Markers.
- To erase a single Marker, press MARKER, then press ◀ or ▶ to select the Marker number. Press CLEAR. NOT SET will appear on the display. Press RETURN or MARKER to remove the display.
- To erase all the Markers, press MARKER, then press ▶ repeatedly to select AC. Press OK. Press MARKER to remove the display.

Subtitles, Camera Angles 55

DVD

Subtitles

You can select a language for DVD subtitles during playback. You can select only languages that are available on the DVD.

- Before you begin, place the DVD/VCR in DVD mode. Press OUTPUT SELECT so the red DVD light appears on the front of the DVD/VCR.

- 1 Press DVD, then press SUBTITLE during playback** so the subtitle display appears on the TV screen.
- 2 Within five seconds, press SUBTITLE repeatedly to select a subtitle language.** The number of available languages appears at the right of the subtitle display. In the example below, eight languages are available (/8). After a few seconds, the subtitles will appear. To turn off Subtitles, press SUBTITLE repeatedly until SUBTITLE OFF appears on the TV screen.

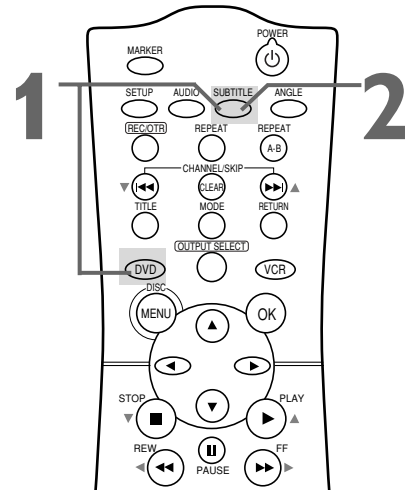

DVD

Camera Angles

Some DVDs contain scenes recorded from different angles. You may select a camera angle during playback.

- Before you begin, place the DVD/VCR in DVD mode. Press OUTPUT SELECT so the red DVD light appears on the front of the DVD/VCR.

- 1 Press DVD, then press ANGLE during playback** so the Angle display appears on the TV screen.
- 2 Within five seconds, press ANGLE repeatedly to select a different angle.** The number of available angles appears at the right of the Angle display. In this example, eight angles are available (/8).

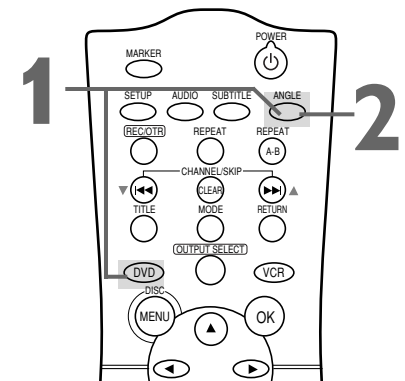

Helpful Hints

- On some DVDs, you must select a subtitle language in the Disc menu.
- If the desired language does not appear after pressing SUBTITLE several times, the Disc does not have subtitles in that language.
- Opening the disc tray will cancel your subtitle setting.
- If the Disc has multiple camera angles,  will appear on the TV screen. ANGLE ICON must be On. Details are on pages 66-67.
- The camera angle will not change if the DVD does not contain sequences recorded from different camera angles.

56 Parental Controls Password

DVD

Parental Controls limits viewing of DVDs that exceed the limits you set. This feature will not limit viewing if the DVD maker did not code the DVD. So, make sure your DVDs play according to your settings before you allow children access to the DVD/VCR. Follow these steps to change your Parental Controls password.

- Before you begin, place the DVD/VCR in DVD mode. Press OUTPUT SELECT so the red DVD light appears on the front of the DVD/VCR.

- 1 While playback is stopped, press DVD, then press SETUP.**

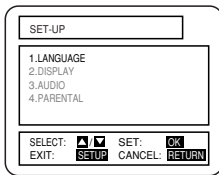

- 2 Press the Number 4 button to select PARENTAL. The SET-UP PARENTAL CONTROLS PASSWORD menu will appear.**

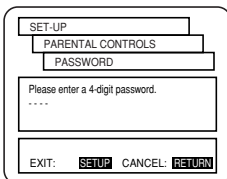

Example: First-time setting password

or

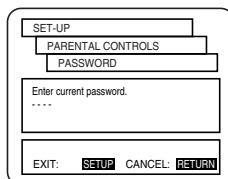

Example: Entering existing password

- 3 Press the Number buttons to enter your four-digit password. When doing this for the first time, enter any four digits, then press OK. That number will be used as the password from that point forward.**

- 4 Press the Number 2 button to select CHANGE.**

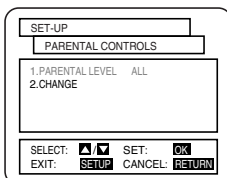

- 5 Press the Number buttons to enter your new four-digit password (which will appear on the TV screen), then press OK.**

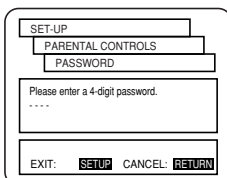

- 6 Press SETUP to remove the menu.**

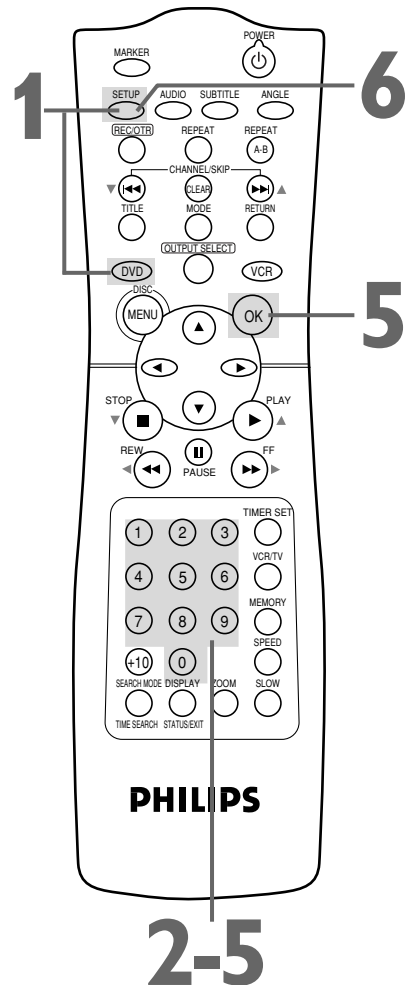

Helpful Hints

- Write down your password in case you forget it.
- The default (factory preset) password is 4737. If you forget your password, press Number buttons 4, 7, 3, 7 at step 3. The Player immediately will ask you to enter a new four-digit password. Use the Number buttons to enter a new four-digit code, then press OK. PARENTAL LEVEL automatically will be reset to ALL. See page 57 to reset PARENTAL LEVEL as you desire.
- Asterisks (*) will appear instead of your password to protect the privacy of the password.

Parental Controls Levels 57

Follow these steps to set the rating level for your DVDs. DVDs whose ratings exceed the level you set will not play.

● Before you begin, place the DVD/VCR in DVD mode. Press **OUTPUT SELECT** so the red DVD light appears on the front of the DVD/VCR.

- 1** While playback is stopped, press **DVD**, then press **SETUP**.

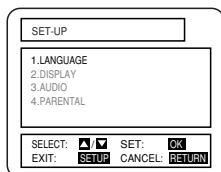

- 2** Press the **Number 4** button to select **PARENTAL**. The **SET-UP PARENTAL CONTROLS PASSWORD** screen will appear.

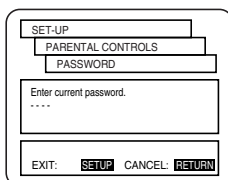

- 3** Press the **Number** buttons to enter your **four-digit password**. If your entry is incorrect, press **OK**, then enter the correct password as prompted by the on-screen message.

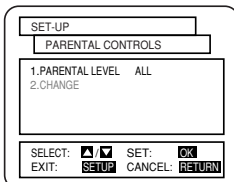

- 4** Press the **Number 1** button to select **PARENTAL LEVEL**.

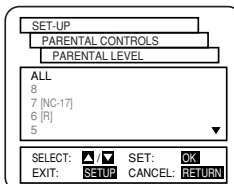

- 5** Press a **Number** button to select the level you desire. For example, if you want to play Discs rated PG-13, press the **Number 4** button (press **▲** or **▼** to see all the rating levels). The level you select will appear on the screen beside **PARENTAL LEVEL** in the **SET-UP PARENTAL CONTROLS** screen.

- 6** Press **SETUP** to remove the menu.

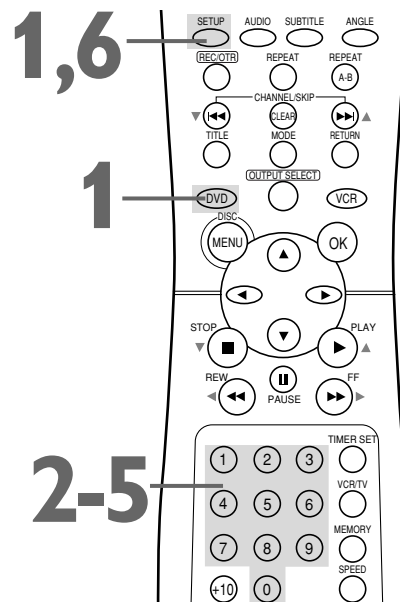

RATING EXPLANATIONS	required for viewers under 18.
• ALL - Parental Controls is inactive; All discs can play.	• 4 - PG-13 - Unsuitable for children under 13
• 8 - Adult material	• 3 - PG - Parental Guidance suggested.
• 7 - NC-17 Not appropriate for children under 17	• 1 - G - General Audience; recommended for all ages.
• 6 - R - Restricted; parental approval	

Helpful Hints

- When you play a DVD whose rating exceeds the level you set, an on-screen message will indicate the DVD cannot play. Remove the DVD, then select a level that allows playback or select ALL to turn off Parental Controls. Reload the DVD and begin playback. Some DVDs may let you enter your four-digit password to begin playback. Refer to the DVD messages.
- Some DVDs are not compatible with Parental Controls. Make sure the DVD plays according to the Parental Controls settings you have made before you allow children access to the DVD/VCR.
- You cannot change Parental Level settings until you enter the correct password.
- You cannot use the default password (4737) to play a DVD.

58 Audio Language

DVD

You can select a language for DVDs during playback. You can change the language only if multiple languages are available on the DVD.

- Before you begin, press OUTPUT SELECT so the red DVD light appears on the front of the DVD/VCR.

- 1** During DVD playback, press DVD, then press AUDIO so the audio display appears on the TV screen. Within five seconds, press AUDIO repeatedly to choose one of the available languages. The number of available languages appears at the right of the audio display. In this example, eight languages are available (/8).

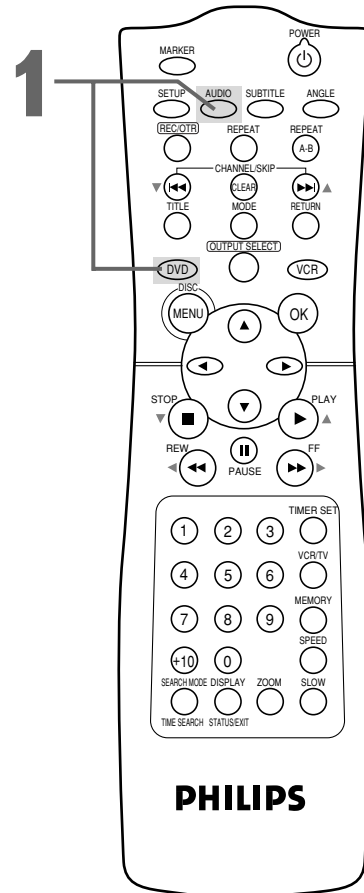
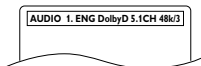







Helpful Hints

- If a desired language is not available after pressing AUDIO several times, the DVD does not have that language.
- Some DVDs only allow you to change the language in the Disc menu. Details are on page 48.

Slow Motion, Zoom 59

DVD

Slow Motion

- 1 During playback, press **DVD**, then press **PAUSE** .
- 2 Press **FF**  (▶▶). Slow motion playback will begin. Press **FF**  repeatedly to vary the speed of slow motion playback. You may play the DVD at 1/16, 1/8, or 1/2 the normal playback speed; , , or  will appear on the TV screen.



- 3 Press **PLAY**  (▶) to return to normal playback.

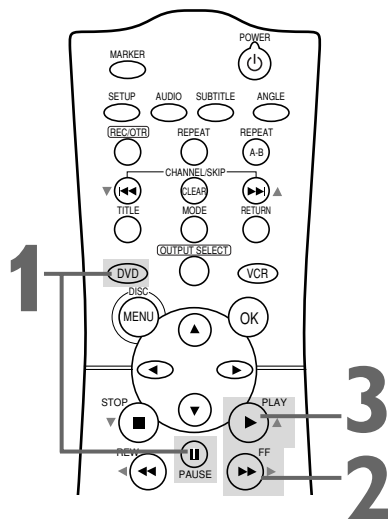





DVD

Zoom

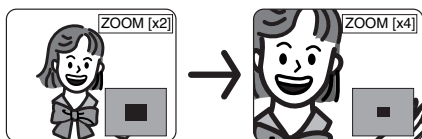
You can enlarge the DVD picture to twice or four times the regular size.

- 1 Press **DVD**, then press **ZOOM** during playback. **ZOOM [x2]** will appear on the screen and the picture will be twice as large as normal. Press **ZOOM** again to increase the picture to four times the regular size. **ZOOM [x4]** will appear on the screen.



- 2 Press , , , or  to move the zoomed image up, down, left, or right.

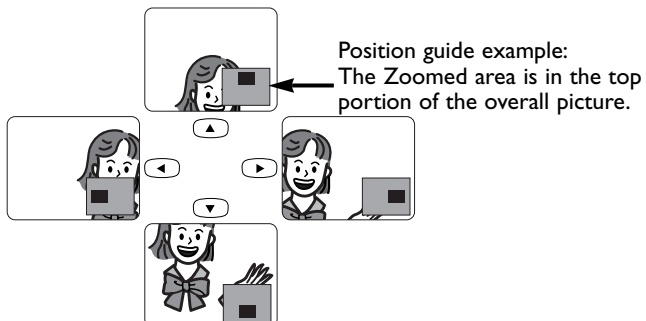

- 3 To return the picture to its normal size, press **ZOOM** again so **ZOOM [OFF]** appears on the TV screen.

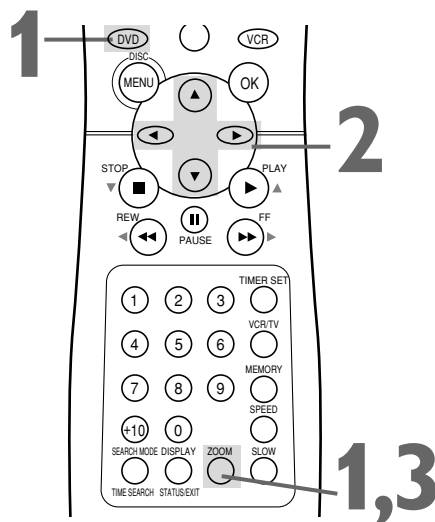

Helpful Hints

- The sound will be mute during slow motion playback.
- You cannot play a DVD in reverse slow motion.
- The gray box with an inner blue box that shows during Zoomed playback is the position guide. To remove it or show it, press **OK**. The position of the blue box inside the gray box indicates the position of the zoomed image within the overall picture.

60 Programmed Playback

AUDIO CD

You may determine the order in which Tracks will play. The order that you set is called the Program. To set up programmed playback, follow these steps.

- Before you begin, place the DVD/VCR in DVD mode. Press **OUTPUT SELECT** so the red DVD light appears on the front of the DVD/VCR.

- 1** While playback is stopped, press **DVD**, then press **MODE**. The PROGRAM screen will appear.

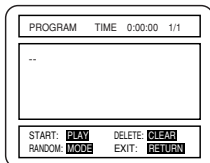

- 2** Press the Number buttons to enter the number of the first Track that you want to play.

- If you enter a wrong Track number, press **CLEAR**. The last Track in the Program will be removed.
- Enter single-digit Tracks with a single Number button. For example, for Track three, press the Number 3 button.
- For Tracks 10 and above, press the +10 button, then the Number button for the first digit, then the Number button for the second digit. For example, to play Track 26, press the +10 button, then press the Number 2 button, then press the Number 6 button.

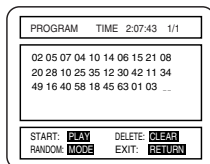

- 3** Repeat step 2 until you have entered all the Tracks you wish to play in the Program. The total playing time of the Program appears beside TIME at the top of the PROGRAM screen.

- 4** Press **PLAY** (▶). The Tracks will play in the order in which you programmed them. The Program will play once.

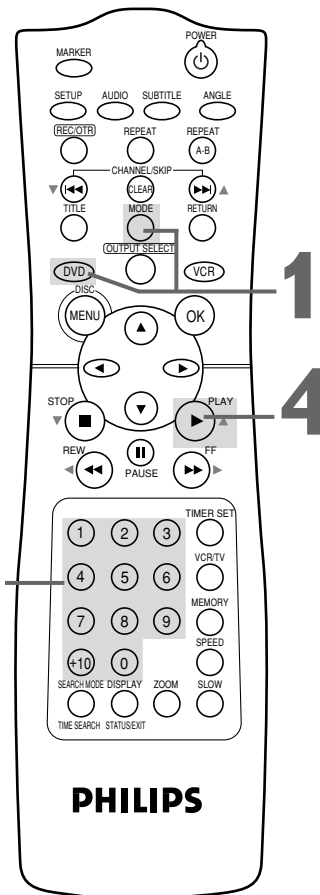

Helpful Hints

- You can not combine specific track or random playback with programmed playback.
- You may play a Program repeatedly. During programmed playback, press **REPEAT** so **REPEAT [TRACK]** or **REPEAT [ALL]** appears. The current Track or the entire Program will play repeatedly.
- To see which Tracks you stored in the Program, press **MODE** during playback.
- Track numbers that are not available on the Audio CD will be rejected and erased. Enter a valid Track number.
- Turning off the DVD/VCR or opening the disc tray will erase the Program.

Random Playback, Stereo Sound Mode 61

AUDIO CD

Random Playback

You may play the Tracks of an Audio CD in Random order instead of the order in which they are recorded (1,2,3...). To set up Random Playback, follow these steps.

- Before you begin, place the DVD/VCR in DVD mode. Press OUTPUT SELECT so the red DVD light appears on the front of the DVD/VCR.

- 1 While playback is stopped, press DVD, then press MODE twice so the RANDOM screen appears.**

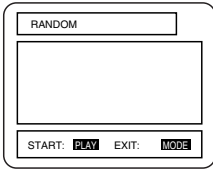

- 2 While the RANDOM screen appears, press PLAY ► (▲). The Tracks will play in random order. After all the Tracks have played once, playback will stop.**

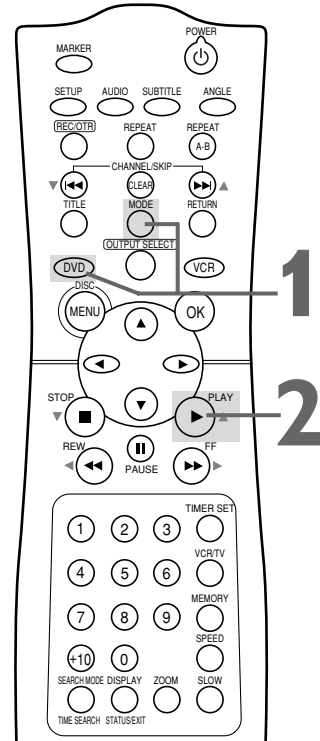

AUDIO CD

Stereo Sound Mode

- 1 Press AUDIO repeatedly during playback to choose AUDIO STEREO, AUDIO L-CH, or AUDIO R-CH.**

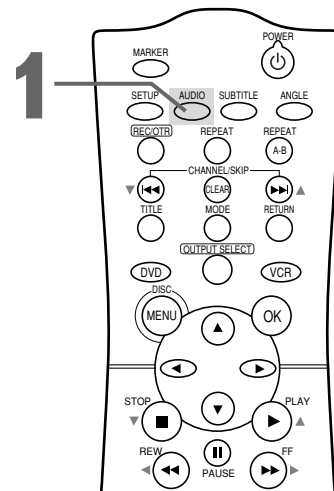
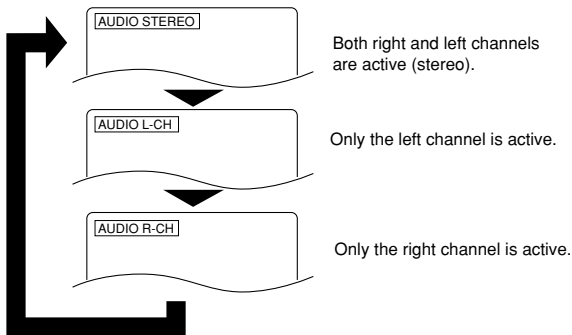

62 MP3 Playback

MP3

The DVD/VCR will play MP3 files recorded on a CD-RW (Compact Disc-Rewritable).

- Before you begin, place the DVD/VCR in DVD mode. Press **OUTPUT SELECT** so the red DVD light appears on the front of the DVD/VCR.

1 When you put a CD-RW with MP3 files in the DVD/VCR, the MP3 menu will appear on the TV screen. **While playback is stopped, press DVD, then press ▲ or ▼ to select the Album or Track you want to play.**

2 **If you choose a Track, press PLAY ► (▲) or OK.** The tracks will play in the order in which they were recorded, i.e. 1, 2, 3, starting with the Track you selected. **If you select an Album and press OK, the Track selection screen will appear. Press ▲ or ▼ to select the Track you want to play, then press PLAY ► (▲) or OK .**

- Choose **FIRST PLAY** to start play from the first Track listed.
- Press **TITLE** to return to the first item on the first MP3 screen.

3 **To stop playback, press STOP ■ (▼).**

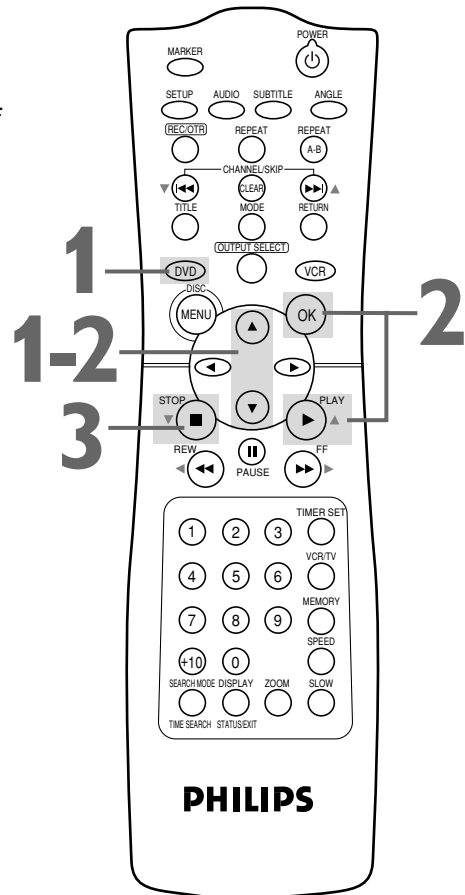

Helpful Hints

- Folders are known as Albums; files are known as Tracks.
- A "+" will appear at the start of the Album name.
- If all the Tracks cannot appear on the screen at the same time, ▼ indicates more Tracks on the next screen; ▲ indicates previous screens. The current screen number and the total number of screens will appear on the screen.
- A total of 255 Albums and Tracks can be recognized.
- Discs recorded in multi-session recordings will not play on the DVD Player of this DVD/VCR.
- Only Tracks having file names ending in .mp3 will play.
- You can play MP3 files recorded at a minimum of 112 kbps.

MP3 Display Information, MP3 Track Selection 63

MP3

MP3 Display Information

You can review MP3 file information during playback.

- Before you begin, place the DVD/VCR in DVD mode. Press OUTPUT SELECT so the red DVD light appears on the front of the DVD/VCR.

1 Press **DVD**, then press **DISPLAY/STATUS/EXIT** during playback. The currently playing Track will be highlighted in yellow.

2 Press **DISPLAY/STATUS/EXIT** again. The elapsed playing time of the current Track will appear at the top of the display.

◻T indicates Track repeat

◻A indicates Album (folder) repeat

◻D indicates Disc repeat

3 Press **DISPLAY/STATUS/EXIT** again to remove the

MP3

MP3 Track Selection

- Before you begin, place the DVD/VCR in DVD mode. Press OUTPUT SELECT so the red DVD light appears on the front of the DVD/VCR.

1 Press **DVD**, then press **SEARCH MODE/TIME SEARCH**. The SEARCH menu will appear. The current Track or the Track at which play will Resume (Resume On) will be highlighted. If Resume is off and playback is stopped, "FIRST PLAY" will be highlighted.

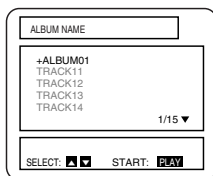

2 Press **▲** or **▼** to select a Track you want to play. Press **PLAY ▶ (▲)** to start playing the Track.

3 Press **SEARCH MODE/TIME SEARCH** to remove the SEARCH menu.

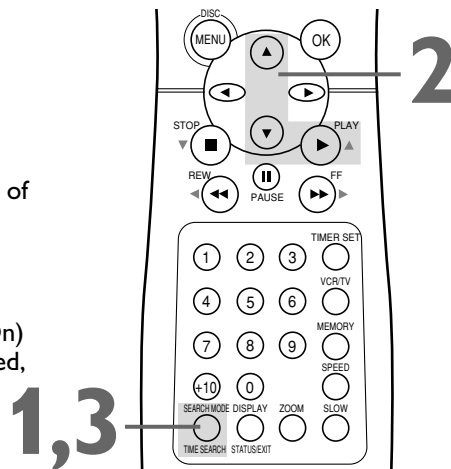
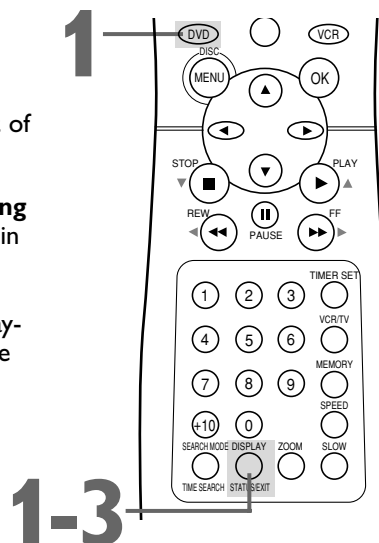

Helpful Hints

- During playback, press the Number buttons to select another Track, which will begin playing immediately. Or, press CHANNEL/SKIP ◀◀/▶▶ (▼/▲) to move to previous or subsequent Tracks.
- If the Track you chose is not available or cannot be accessed, "X" will appear on the TV screen. Play may resume at a different Track.
- Specific Time playback is not possible with MP3 files.

64 Random MP3 Playback, Programmed MP3 Playback

MP3

Random MP3 Playback

- Before you begin, place the DVD/VCR in DVD mode. Press **OUTPUT SELECT** so the red DVD light appears on the front of the DVD/VCR.

- While playback is stopped, press **DVD**, then press **MODE** twice. The **RANDOM** screen will appear.

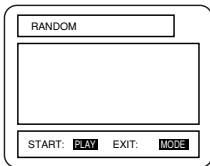

- Press **PLAY** (▶) (▲) to play the tracks in random order.

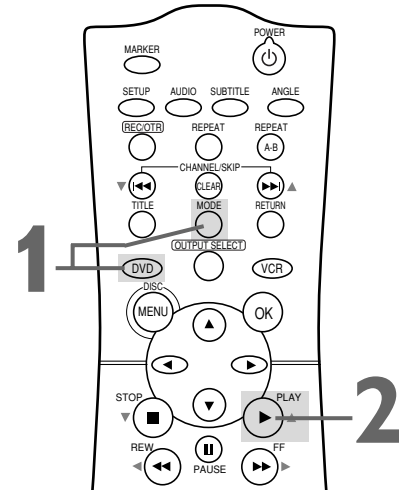

MP3

Programmed MP3 Playback

- Before you begin, place the DVD/VCR in DVD mode. Press **OUTPUT SELECT** so the red DVD light appears on the front of the DVD/VCR.

- While playback is stopped, press **DVD**, then press **MODE**. The **PROGRAM FOLDER NAME** screen will appear.

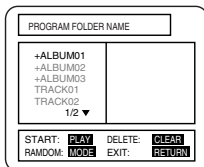

- Press ▲ or ▼ to select a Track, then press **OK** to save it in the Program. The programmed Track will appear on the right side of the screen. Press ▲ or ▼ to see additional Tracks. Repeat step 2 to enter all the Tracks you want.

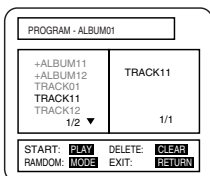

- Press **PLAY** (▶) (▲) to play the Program.
- Press **STOP** (■) (▼) to stop playing the Program.

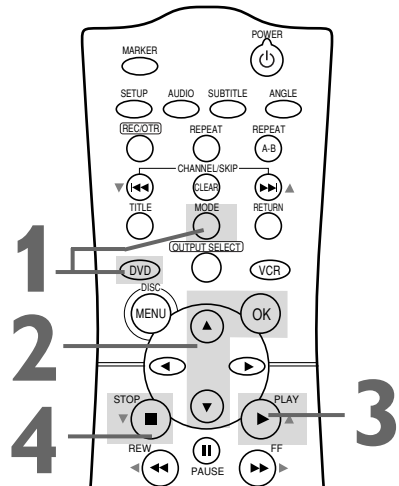

Helpful Hints

- Press **CLEAR** to delete the last item in the Program.
- Turning off the DVD/VCR or opening the Disc tray will erase the Program.

On-Screen Displays 65

DVD

You can check information about the current DVD by pressing DISPLAY/STATUS/EXIT on the remote control.

1 Press DVD, then press DISPLAY/STATUS/EXIT during playback.

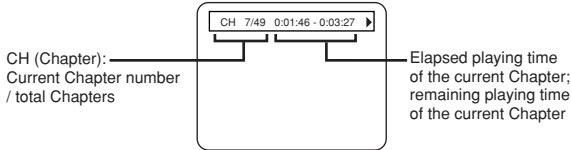

2 Press DISPLAY/STATUS/EXIT again. If you want, you can press a Number button now to start playing a specific Chapter.

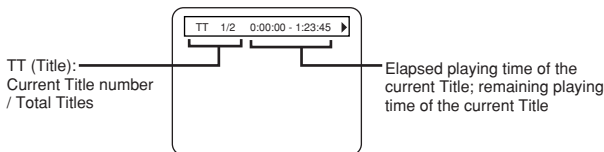

3 Press DISPLAY/STATUS/EXIT again.

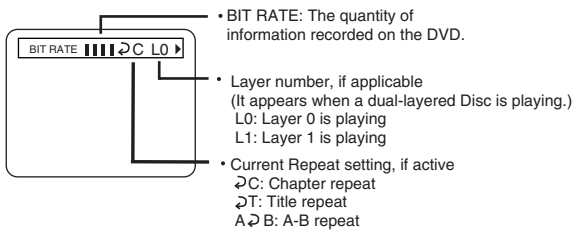

4 Press DISPLAY/STATUS/EXIT or RETURN to remove the display.

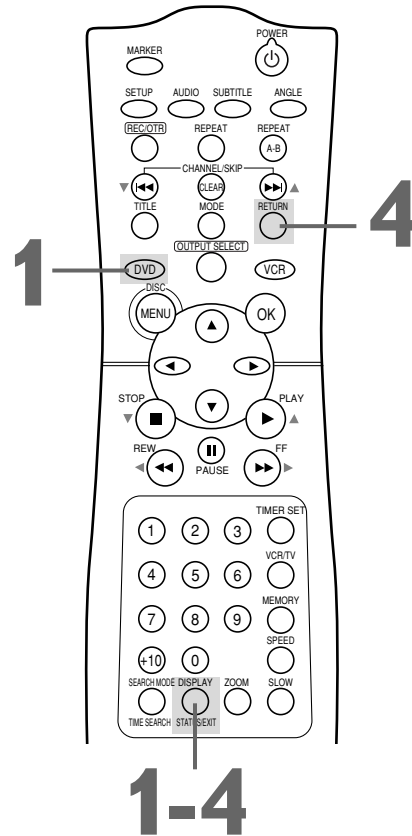

AUDIO CD

You can check information about the current Audio CD using DISPLAY/STATUS/EXIT.

1 Press DVD, then press DISPLAY/STATUS/EXIT during playback.

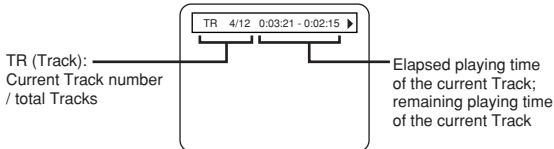

2 Press DISPLAY/STATUS/EXIT again. If you want, you can press a Number button now to start playing a specific Track.

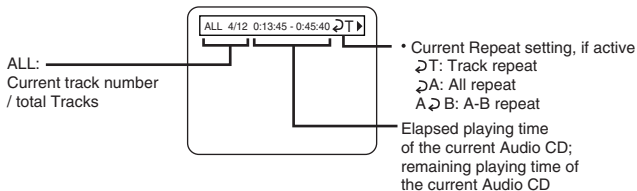

3 Press DISPLAY/STATUS/EXIT or RETURN to remove the display.

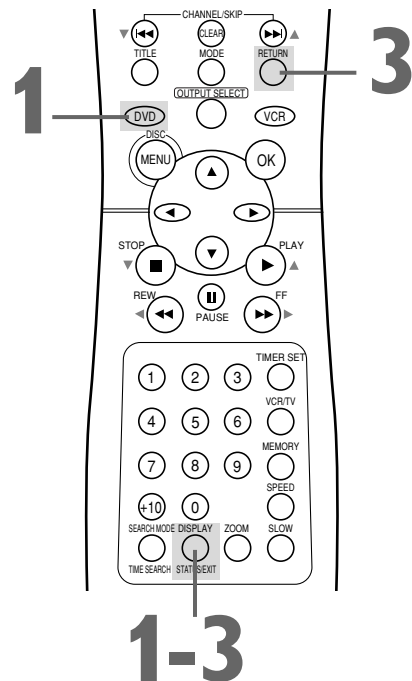

66 Display Settings

You can change certain aspects of the DVD Player's display screens, on-screen messages, and the display panel on the front of the DVD/VCR. You also can change the Aspect Ratio. To change such settings, follow these steps.

- Before you begin, place the DVD/VCR in DVD mode. Press **OUTPUT SELECT** so the red DVD light appears on the front of the DVD/VCR.

- 1** When playback is stopped, press **DVD**, then press **SETUP**. The SET-UP screen will appear.

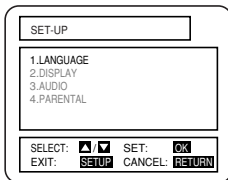

- 2** Press the **Number 2** button to select **DISPLAY**.

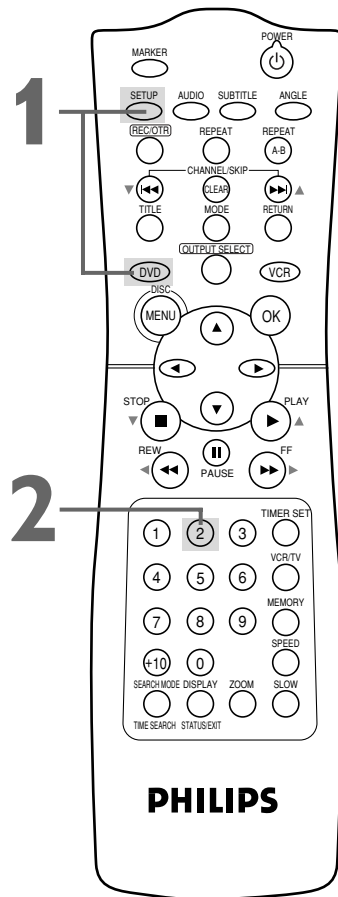
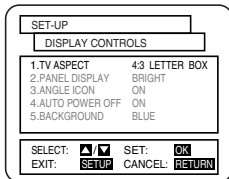

Display Settings (cont'd) 67

3 Press ▲ or ▼ to select an item, then press OK.

● If you selected TV ASPECT, press ▲ or ▼ to select a setting, then press OK. Choose 4:3 LETTER BOX if you want black bars to appear at the top and bottom of the picture. Choose 4:3 PAN & SCAN for a full height picture, with both sides trimmed.

Choose 16:9 WIDE if a widescreen TV is connected to the DVD/VCR.

● If you selected PANEL DISPLAY, press ▲ or ▼ to select BRIGHT, DIMMER, or AUTO, then press OK. This adjusts the brightness of the display panel on the front of the DVD/VCR. The default setting is BRIGHT. If you choose AUTO, the display dims only during Disc playback.

● If you selected ANGLE ICON, press OK repeatedly to turn ANGLE ICON ON or OFF. The default setting is ON. Choose ON to see the Angle icon when multiple camera angles are available during DVD playback. *Details are on page 55.* Choose OFF to disable the Angle icon.

● If you selected AUTO POWER OFF, press OK repeatedly to turn AUTO POWER OFF ON or OFF. The default setting is ON. Choose ON if you want the DVD/VCR to switch to VCR mode automatically after 35 minutes of no use in DVD mode.

● If you selected BACKGROUND, press OK repeatedly to select BLUE or GRAY as the background color for the on-screen menus.

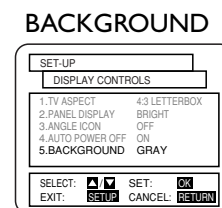
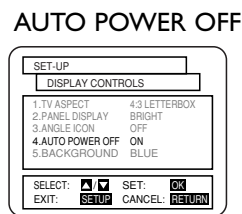
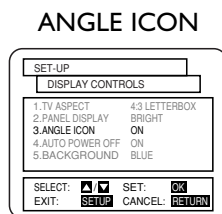
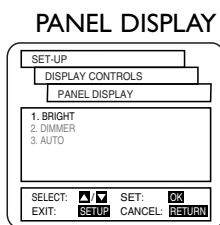
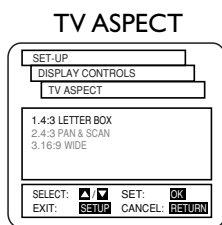
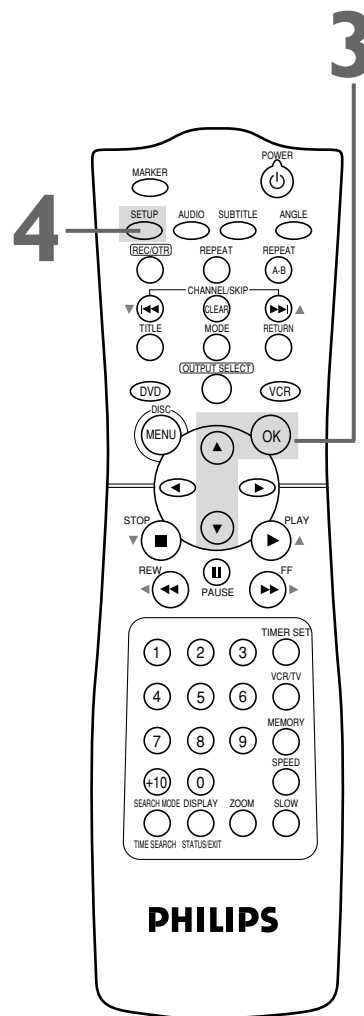

4 Press SETUP to remove the menus.

Helpful Hints

- Selecting a different TV ASPECT setting is only effective if it is available on the DVD.
- DVDs may refer to the Letterbox format as the widescreen version. Letterbox stretches the picture horizontally so the picture resembles movies seen at a theater.
- DVDs may refer to Pan and Scan as “reformatting the picture to fit your TV screen.”

68 Language Settings

You can use the LANGUAGE settings to select different languages for the Audio or Subtitles of DVDs, as well as languages for DVD Disc menus and the menus of the DVD Player SETUP menus of the DVD/VCR.

- Before you begin, place the DVD/VCR in DVD mode. Press **OUTPUT SELECT** so the red DVD light appears on the front of the DVD/VCR.

- 1 While playback is stopped, press DVD, then press SETUP.** The SETUP screen appears.

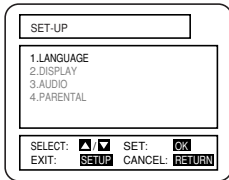

- 2 Press the Number 1 button to select LANGUAGE.**

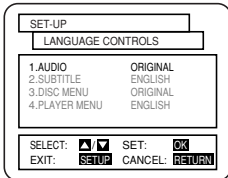

- 3 Press ▲ or ▼ to select AUDIO, SUBTITLE, DISC MENU, or PLAYER MENU. Then, press OK.** The menu for the selected item will appear.

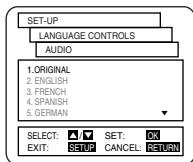

AUDIO: The DVD's audio plays in the selected language, if available on the DVD.

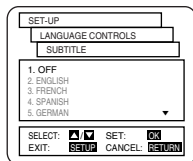

SUBTITLE: DVD subtitles appear in the chosen language, if available on the DVD.

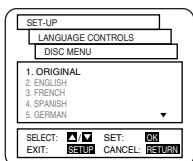

DISC MENU: A DVD's Disc menu appears in the chosen language, if available on the DVD.

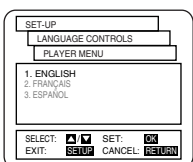

PLAYER MENU: The DVD Player's SETUP menu appears in the selected language.

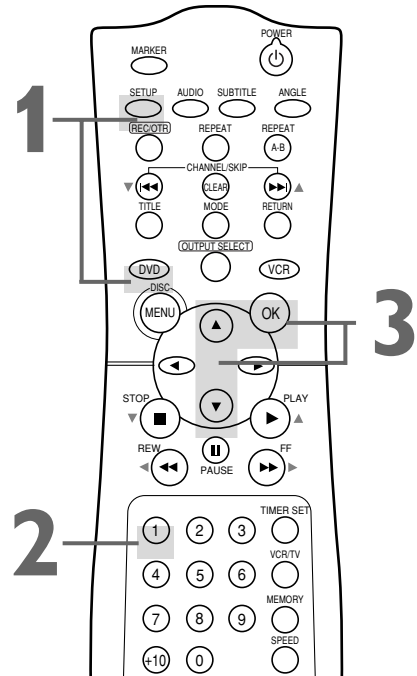

Helpful Hints

- Some DVDs only allow you to change audio, subtitle, or menu languages in the DVD Disc menu. Details are on page 48.
- Language options for AUDIO, SUBTITLE, and DISC MENU are not available with some DVDs. Use the AUDIO and SUBTITLE buttons instead to select different languages. Details are on pages 55 (subtitles) and 58 (audio).
- The Player menu can be in English, French, or Spanish. If you accidentally get French or Spanish and need English, follow these steps.
 - 1) Press DVD, then press SETUP.
 - 2) Press the Number 1 button to select LANGUE or IDIOMA.
 - 3) Press the Number 4 button to select MENU LECTEUR or MENU REPRODUC.
 - 4) Press the Number 1 button to select ENGLISH. The menus will appear in English.
 - 5) Press SETUP to remove the menus.

Language Settings (cont'd) 69

- 4** Press **▲** or **▼** to select a setting, then press **OK**.
- If you select **OTHER** at the **AUDIO**, **SUBTITLE**, or **DISC MENU** screen, press four Number buttons to enter the code for the language you desire. Refer to the list below for the correct language code. You can only select other languages for **AUDIO**, **SUBTITLE**, and **DISC MENU** if the language is available on the Disc.
 - Each screen can show a maximum of five languages. To see additional languages, press **▲** or **▼**.

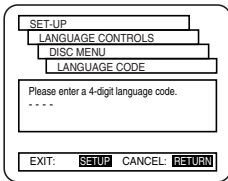

- 5** Press **SETUP** to remove the menu.

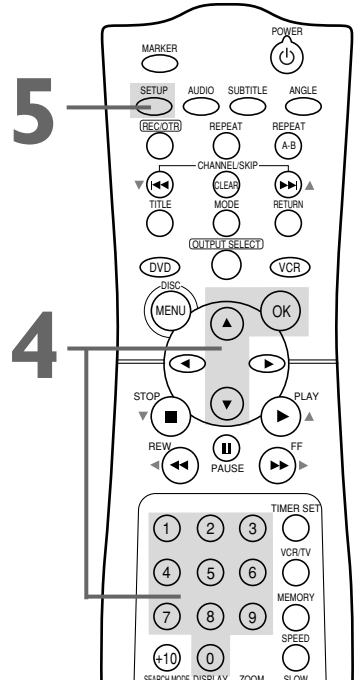

Language	Code	Language	Code	Language	Code	Language	Code	Language	Code
A-B									
Abkhazian	4748	English[ENG]	5160	Javanese	5669	Oriya	6164	Somali	6561
Afar	4747	Esperanto	5161	Kannada	5760	Oromo (Afan)	6159	Spanish[SPA]	5165
Afrikaans	4752	Estonian	5166	Kashmiri	5765	Panjabi	6247	Sundanese	6567
F-H									
Albanian	6563	Faroese	5261	Kazakh	5757	Pashto	6265	Swahili	6569
Amharic	4759	Fiji	5256	Kinyarwanda	6469	Persian	5247	Swedish[SWE]	6568
Arabic	4764	Finnish[FIN]	5255	Kirghiz	5771	Polish	6258	T	
Armenian	5471	French[FRE]	5264	Kirundi	6460	Portugese[POR]		Tagalog	6658
Assamese	4765	Frisian	5271	Korean[KOR]	5761		6266	Tajik	6653
Aymara	4771	Gaelic (Scots)	5350	Kurdish	5767	Pushto	6265	Tamil	6647
L-N									
Azerbaijani	4772	Galician	5358	Laothian	5861	Quechua	6367	Tatar	6666
Bangla	4860	Georgian	5747	Latin	5847	Rhaeto-Romance	6459	Telugu	6651
Bashkir	4847	German[GER]	5051	Latvian	5868	Romanian[RUM]	6461	Thai	6654
Basque	5167	Greek[GRE]	5158	Lettish	5868		6461	Tibetan	4861
Bengali	4860	Greenlandic	5758	Lingala	5860	Russian[RUS]	6467	Tigrinya	6655
Bhutani	5072	Guarani	5360	Lithuanian	5866			Tonga	6661
Bihari	4854	Gujarati	5367	Macedonian	5957	S		Tsonga	6665
Bislama	4855	Hausa	5447	Malagasy	5953	Samoan	6559	Turkish[TUR]	6664
Breton	4864	Hebrew	5569	Malay	5965	Sangho	6553	Turkmen	6657
Bulgarian	4853	Hindi	5455	Malayalam	5958	Sanskrit	6547	Twi	6669
Burmese	5971	Hungarian[HUN]		Maltese	5966	Serbian	6564	U-Z	
Byelorussian	4851		5467	Maori	5955	Serbo-Croatian		Ukrainian	6757
C-E									
		I-K		Marathi	5964		6554	Urdu	6764
Cambodian	5759	Icelandic[ICE]	5565	Moldavian	5961	Sesotho	6566	Uzbek	6772
Catalan	4947	Indonesian	5560	Mongolian	5960	Setswana	6660	Vietnamese	6855
Chinese[CHI]	7254	Interlingua	5547	Nauru	6047	Shona	6560	Volapuk	6861
Corsican	4961	Interlingue	5551	Nepali	6051	Sindhi	6550	Welsh	4971
Croatian	5464	Inupiak	5557	Norwegian[NOR]		Singhalese	6555	Wolof	6961
Czech	4965	Irish[IRI]	5347		6061	Siswat	6565	Xhosa	7054
Danish[DAN]	5047	Italian[ITA]	5566	O-R		Slovak	6557	Yiddish	5655
Dutch[DUT]	6058	Japanese[JPN]	5647	Occitan	6149	Slovenian	6558	Yoruba	7161
								Zulu	7267

70 Audio Settings

Choose the appropriate Audio Settings for your equipment. These settings only affect the playback of the DVD Player of the DVD/VCR.

- Before you begin, place the DVD/VCR in DVD mode. Press **OUTPUT SELECT** so the red DVD light appears on the front of the DVD/VCR.

- While playback is stopped, press **DVD**, then press **SETUP**. The **SETUP** screen will appear.

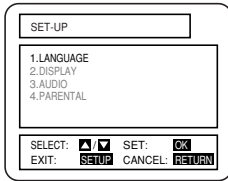

- Press the **Number 3** button to select **AUDIO**.

- Press **▲** or **▼** to select an item, then follow step 4 accordingly.

- If you selected **DRC**, press **OK** repeatedly to turn Dynamic Range Control (DRC) ON or OFF. This levels the sound volume by suppressing loud sound and raising the volume of low sound.
 - If you selected **DOLBY DIGITAL**, press **OK** repeatedly to turn DOLBY DIGITAL ON or OFF. Select ON if you connected the DVD/VCR to a stereo that is Dolby Digital compatible. *Details are on page 13.*
 - If you selected **MPEG**, press **OK** repeatedly to turn MPEG ON or OFF. Select ON when the DVD/VCR is connected to an MPEG-compatible Stereo.
 - If you selected **DOWN SAMPLING**, press **OK**. Then, press **▲** or **▼** to select **AUTO**, **48 kHz**, or **96 kHz**, then press **OK**. The **AUDIO CONTROLS** menu will reappear.

Select 96 kHz if the DVD was recorded in PCM (Pulse Code Modulation) 96 kHz. Otherwise, select 48 kHz.

DRC

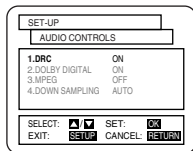

DOLBY DIGITAL

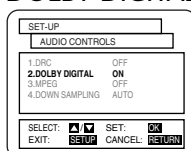

MPEG

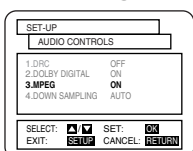

DOWN SAMPLING

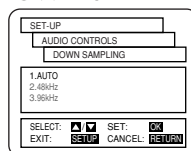

- Press **SETUP** to remove the menu.

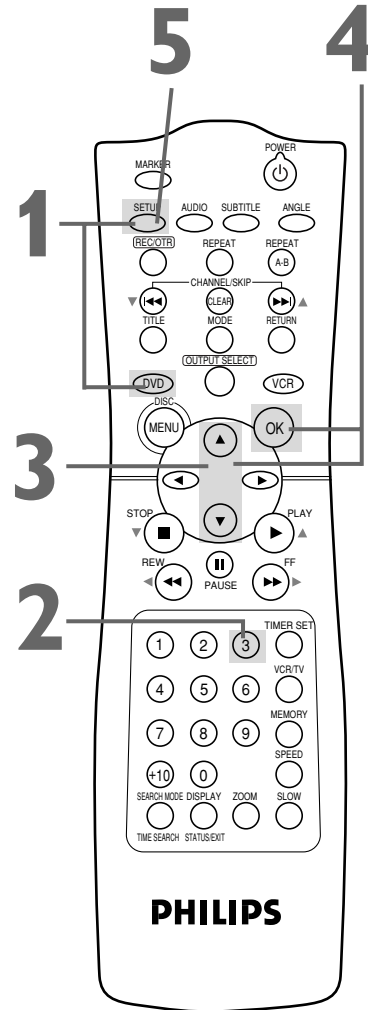

Helpful Hints

- Setting **DOWN SAMPLING** to **96kHz** activates copyright protection and mutes the sound. Selecting **AUTO** sets downsampling to 48kHz.
- MPEG** represents the Motion Picture Experts Group.

Black Level Settings, TruSurround Setting 71

DVD

Black Level Settings

Adjust the Black Level Settings to make the black parts of the DVD picture as bright as you prefer.

- Before you begin, place the DVD/VCR in DVD mode. Press OUTPUT SELECT so the red DVD light appears on the front of the DVD/VCR.

- Press **DVD**, then press **MODE** once during DVD playback so **BLACK LEVEL** shows in the top left corner of the TV screen.
- Within 10 seconds, press **OK** repeatedly to choose **ON** or **OFF**. **ON** brightens the dark parts of the picture. **OFF** shows the original picture as recorded.

BLACK LEVEL : ON

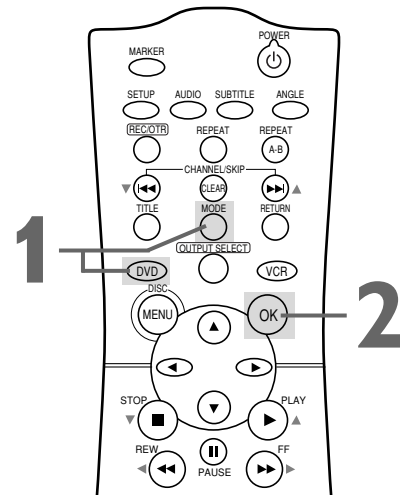

TruSurround Setting

You can enjoy improved stereo sound when you play DVDs or Audio CDs recorded in Dolby Digital, PCM 48 kHz, or MPEG Audio. Check the Disc case for details on availability.

- Press **DVD**, then press **MODE** twice during Disc playback so **SRS TruSurround** shows in the top left corner of the TV screen.
- Within 10 seconds, press **OK** repeatedly to choose **ON** or **OFF**. The default setting is **OFF**. Choose **ON** only if you connected the DVD/VCR to a stereo that has a Dolby Digital or MPEG decoder. Make sure the current DVD is recorded in Dolby Digital, PCM 48 kHz, or MPEG Audio.

SRS TruSurround ON

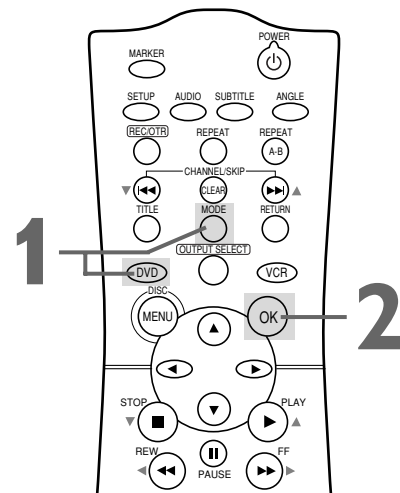

Helpful Hints

- SRS TruSurround is available only when the DVD/VCR is connected to a TV or Stereo using the red and white DVD/VCR AUDIO OUT jacks on the DVD/VCR.
- If you connected the DVD/VCR to a stereo using the COAXIAL DIGITAL AUDIO OUT jack as described on page 13, turn off SRS TruSurround; otherwise, there will be no sound.

This unit employs TruSurround system

TruSurround[™] of SRS Labs, Inc. as virtual technology.
by **SRS** (●)

TruSurround and the (●) symbol are trademarks of SRS Labs, Inc.
TruSurround technology is incorporated under license from SRS Labs, Inc.

72 Care and Maintenance, Specifications

Care and Maintenance

Cleaning the DVD/VCR

- Wipe the front panel and other exterior surfaces of the DVD/VCR with a soft, slightly damp cloth.
- Never use a solvent, thinner, benzene, or alcohol to clean the DVD/VCR. Do not spray insecticide liquid near the DVD/VCR. Such chemicals may discolor the surface or damage the DVD/VCR.

Cleaning a Disc

- Use a soft, dry cloth to wipe the Disc.
- Wipe the Disc in a straight line from the center to the edge. Never wipe the Disc in a circular motion.
- Do not use detergent or abrasive cleaning agents.
- Handle the Discs so fingerprints and dust do not adhere to the Discs.
- Always store the Disc in its protective case when it is not in use.

Checking the Laser

- If the DVD/VCR does not operate as described in this manual, the DVD Player's laser may be dirty. Consult an Authorized Service Center for inspection and cleaning of the laser.

Caring for Video Cassettes

- Use only cassettes with the **VHS** mark.
- Remove any light adhesive stick-on notes from the video cassette before putting the cassette in the VCR. Removable labels can jam the VCR.

Caring for the VCR's Video Heads

- Periodic maintenance is required to maintain your DVD/VCR's excellent performance. The VCR has an Automatic Head Cleaner. However, the video heads will require replacement eventually. Only an authorized service center should perform this service.

Specifications

Video Heads

Four heads - Hi-Fi

Antenna

VHF/UHF - 75 ohm
external antenna terminal

VHF Output Signal

Channel 03 or 04 (switchable)
75 ohms unbalanced

Color System

NTSC

Frequency Response

DVD (linear sound):
20 Hz to 22 kHz (sample rate: 48 kHz)
20 Hz to 44 kHz (sample rate: 96 kHz)
Audio CD: 20 Hz to 20 kHz

Signal-to-Noise Ratio

Audio CD: 110 dB JEITA
(Japan Electronics and Information
Technology Industries Association)

Dynamic Range

DVD (linear sound): 95 dB
Audio CD: 94 dB (JEITA)

Total Distortion Factor

Audio CD: 0.007% (JEITA)

Wow and Flutter

Below the measurement limitation
(±0.001% W PEAK) (JEITA)

Power Requirement

120V AC +/- 10%, 60 Hz +/- 0.5%

Power Consumption

Power on: 25 W
Power off: 7.2 W

Operating Temperature

41°F (5°C) to 104°F (40°C)

Relative Humidity

30% to 80%

Dimensions

17-1/8" (W) x 3-7/8" (H) x 10-1/2" (D)
(435mm x 99mm x 266mm)

Weight

8.8 lbs. (4.0 kg.)

NOTE: Designs and specifications are subject to change without notice.

Glossary 73

AUDIO IN/OUT Jacks: jacks on the front and back of the DVD/VCR that receive audio from another source (IN) or send audio to another system (OUT).

Automatic Channel Setup: process in which the VCR memorizes all available TV channels. Then, when you press CHANNEL/SKIP ◀◀▶▶ (▼/▲) in VCR mode, you only scan through channels you receive.

Bands: settings that allow you to tune channels.

- **Antenna** – VHF (very high frequency; channels 2-13) and UHF (ultra high frequency; channels 14-69).
- **Cable** – standard channels 1-125 can be received without a Cable Box.

Cable Box/DBS Output Channel: 03 or 04.

COAXIAL DIGITAL AUDIO OUT jack: Sends digital audio to a stereo receiver, allowing you to adjust the volume at the stereo receiver. This connection provides the 5.1 channel surround sound as heard in movie theaters.

COMPONENT VIDEO OUT (Y, Cr, Cb) Jacks: jacks on the back of the DVD/VCR that send high-quality video to a TV with Component Video In jacks. This connection provides the best picture quality. If you use this video connection, you will not need the supplied yellow video cable.

Dolby Digital: A surround sound system that provides 5.1 channel sound as used in movie theaters.

DTS: Digital Theater Systems. This is a surround sound system, but it is different from Dolby Digital. The formats were developed by different companies.

Dubbing: copying a video cassette using another VCR.

HQ: high quality; a feature in the VCR circuitry which provides enhanced picture detail.

Line Input: The channel to which you set your DVD/VCR during video cassette copying. If you use the AUDIO and VIDEO In jacks on the front of the DVD/VCR, select channel 002 (AV FRONT). If you use the AUDIO and VIDEO IN jacks on the back of the DVD/VCR, select 001 (AV REAR). If you accidentally enter Line Input mode, press CHANNEL/SKIP ◀◀▶▶ (▼/▲) or the Number buttons to select another channel.

OTR: One-Touch Recording; a timed recording on the VCR that starts immediately and records for 30 minutes to eight hours.

RF coaxial cable: A black cable supplied with your DVD/VCR. Use it to connect your DVD/VCR to your TV (or Cable Box or DBS).

S-Video: Produces a clearer picture by sending separate signals for the luminance and the color. If you connect an optional S-Video cable, you will not need to use the supplied yellow video cable.

Tape Speeds: how fast the video cassette travels during a recording or playback. The faster the tape speed, the better the picture quality. Slower tape speeds affect picture quality, but you can record more onto a cassette.

- **SP** (standard play) – fastest tape speed (recording time for a T120 tape is approximately two hours); best picture quality.
- **LP** (long play) – average tape speed; playback only.
- **SLP** (super long play) – slowest tape speed (recording time for a T120 tape is approximately six hours).

VIDEO IN/OUT Jacks: jacks on the front and back of the DVD/VCR that receive video from another source (IN) or send video to another system (OUT).

74 Helpful Hints

If you are having problems with your product, check this list of problems and possible solutions before requesting service. You may be able to solve the problem yourself.

If you need to call a customer service representative, please know the model number and serial number of your product before you call. This information is displayed on the back of the product. Also, please take a moment to identify the problem you are having, and be prepared to explain this to the representative. If you believe the representative will need to help you with operations, please stay near the product. Our representatives will be happy to assist you.

The DVD/VCR has no power.

- Make sure the power cord is connected completely to an AC (alternating current) outlet.
- Press the POWER  button to turn on the DVD/VCR. "P-ON" will appear briefly on the display panel as the power is turning on. The DVD/VCR always turns on in VCR mode. To switch to DVD mode, press OUTPUT SELECT so the red DVD light appears on the front of the DVD/VCR.

The remote control will not operate the DVD/VCR.

- Aim the remote control directly at the DVD/VCR's remote sensor. *Details are on page 20.*
- Remove all obstacles between the remote control and the DVD/VCR.
- Inspect and/or replace the batteries in the remote control. *Details are on page 14.*
- Use the remote control within 23 feet of the DVD/VCR.
- When trying to play Discs, press the DVD button, then try the other DVD feature buttons. Press OUTPUT SELECT so the red DVD light appears on the front of the DVD/VCR. This means the DVD/VCR is in DVD mode.
- To use the VCR features, press VCR, then try the other VCR feature buttons. Press OUTPUT SELECT so the green VIDEO light appears on the front of the DVD/VCR. This means the DVD/VCR is in VCR mode.
- Make sure the green VCR/TV light appears on the front of the DVD/VCR. If it does not, press VCR, then press VCR/TV once.

There is no picture in DVD mode.

- Make sure the video cable is connected correctly. You may connect either the yellow video cable (supplied), an optional S-Video cable, or optional component video cables. You only need one video connection between the DVD/VCR and the TV. Make sure the TV is set to the correct Video In channel (usually the AUX IN, A/V IN, Auxiliary In, EXT or External In, Component Video In, or S-Video In channel). Check your TV owner's manual for details. *Details are on pages 11-13.*
- If you only used the supplied black RF coaxial cable, *details are on pages 8-10.* Make sure the TV is set to channel 3 or 4 (the channel to which the DVD/VCR's CH3/CH4 switch is set). Or, if you have a Cable Box/DBS, make sure the TV is set to the Cable Box/DBS output channel (usually 03 or 04).
- Insert a DVD that is playable on this DVD/VCR. *Details are on page six.*
- Press VCR, then press VCR/TV to choose VCR position. The VCR/TV light will appear on the front of the DVD/VCR.
- Make sure the DVD/VCR is in DVD mode. Press OUTPUT SELECT so the red DVD light appears on the front of the DVD/VCR.

Disc cannot play.

- Insert a playable Disc. *Details are on page six.*
- Place the Disc correctly in the Disc tray. If the Disc is one-sided, place the Disc in the tray with the label facing up. If the Disc is two-sided, make sure the side you want to play is facing up.
- Clean the Disc. Make sure the Disc is not scratched or warped.
- Cancel the Parental Controls, enter the password, or change the control level. *Details are on pages 56-57.*
- Make sure the Disc is labelled for use in Region 1 or ALL regions and is NTSC compatible. *Details are on page six.*

Helpful Hints (cont'd) 75

There is no sound.

- Connect the audio cables firmly. Make sure the cables are connected to the AUDIO IN jacks on the TV or Stereo Receiver. *Details are on pages 11-13.*
- Check the audio settings of the DVD Player. *Details are on pages 70-71.*
- Check the audio settings of the DVD. For example, you may have selected “soundtrack” playback or an unavailable sound setting (such as Dolby Digital). *Details are on pages 58 and 68-69.* Try other sound options provided in the DVD Disc menu.
- If you used audio cables (instead of only using the supplied black RF coaxial cable) make sure the TV or Stereo Receiver is set to the correct Audio In channel (usually the AUX IN, Auxiliary In, A/V IN, Audio In, or External In channel). See your TV or Stereo Receiver owner’s manual for details.

The picture is distorted.

- Connect the DVD/VCR directly to the TV. *Details are on pages 8-13.* Do not connect the DVD/VCR to a VCR, then connect the VCR to the TV. Copyright protection systems in the VCR could distort the picture playing on the DVD/VCR.
- There are some cases where the picture may be distorted slightly; this is not a malfunction of the DVD/VCR.
- Make sure the Disc is compatible with the DVD Player of the DVD/VCR. *Details are on page six.*

You cannot change the camera angle of a DVD.

- The DVD might not contain segments recorded from different camera angles. See if multiple angles are available by referring to the Disc case or DVD Disc menu. *Details are on page 55.*

You cannot change the audio or subtitle language of a DVD.

- The DVD does not contain audio or subtitles in the desired language. Not all DVDs contain audio or subtitles in multiple languages. See if other languages are available by referring to the Disc case or DVD Disc menu. *Details are on pages 55 and 58.*

An “X” appears in the top right corner of the TV screen, prohibiting an operation.

- The DVD/VCR prohibits the current operation at the current time or the feature is not available on the Disc. *Details are on page five.*

The DVD/VCR switches itself from DVD mode to VCR mode after 35 minutes.

- The DVD/VCR switches itself from DVD mode to VCR mode if Disc playback stops for more than 35 minutes and you press no buttons on the remote control or the DVD/VCR. *Details are on pages 66-67.*

A screen saver appears on the TV screen during DVD mode.

- The DVD logo will appear on the TV screen if you stop Disc playback for more than five minutes (and you do not press any buttons on the remote control or the DVD/VCR). The DVD logo prevents damage to your TV’s picture tube. A prolonged still image, including TV station identification logos or video games, may damage the picture tube.

You want to use the DVD Player during a VCR timer recording or while the TIMER light appears or flashes.

- Press POWER  to turn on the DVD/VCR. Press VCR/TV to choose VCR position. (The green VCR/TV light will appear.) Press OUTPUT SELECT to choose DVD mode, then continue with other DVD features as described in this manual. Remember to press the DVD button on the remote control before continuing to use the remote control to operate the DVD Player.

76 Helpful Hints (cont'd)

Power Failure

- VCR timer recordings, clock setting, language selection, and channel setup may be lost if the power fails for more than one minute. See pages 24-29 to set up the channels, clock, and language again. See pages 34-37 to reprogram your timer recordings.

The VCR will not record a TV program.

- Put the DVD/VCR in VCR mode. Press OUTPUT SELECT so the green VIDEO light appears on the front of the DVD/VCR.
- Check the connections between the DVD/VCR, TV, antenna/cable, and Cable Box/Direct Broadcast System (if applicable). *Details are on pages 8-13.*
- Make sure the video cassette has a record tab. *Details are on page 31.*
- Make sure the DVD/VCR is in VCR position. Press VCR/TV so the green VCR/TV light appears on the front of the DVD/VCR. *Details are on page 19.*
- Check the CH3/CH4 switch. *Details are on pages 8-10.* Or, if you connected the DVD/VCR to the TV using audio and video cables, select the correct audio and video in channel at the TV. *Details are on pages 11-13.*

The VCR will not perform a timer recording.

- Make sure the recording start and stop times are set correctly. *Details are on pages 34-37.*
- Make sure a tape is in the VCR and the tape has a record tab. *Details are on page 31.* If, after programming a timer recording, you press TIMER SET without putting a tape in the DVD/VCR, the TIMER light will blink.
- If the record tab on a tape is missing, the DVD/VCR will eject the tape. The TIMER light will blink.
- Press TIMER SET to put the DVD/VCR in standby mode for the timer recording. The TIMER light should appear on the front of the DVD/VCR.
- Make sure the VCR clock is set. *Details are on page 27.*
- The VCR may not perform or continue a timer recording if the power fails for more than one minute.
- If you have a Cable Box/Direct Broadcast System, set timer recordings differently. *Details are on page nine.*
- Finish programming a timer recording at least five minutes before it is set to begin.
- 12 p.m. is noon; 12 a.m. is midnight.

There is no picture or the picture is noisy or has streaks during video cassette playback.

- Put the DVD/VCR in VCR mode. Press OUTPUT SELECT so the green VIDEO light appears on the front of the DVD/VCR.
- If you used the supplied RF coaxial cable to connect the DVD/VCR to the TV, make sure the TV is on the same channel as the DVD/VCR's CH3/CH4 switch. Make sure channel 03 or 04 is properly adjusted at the TV. Or, if you connected the DVD/VCR to the TV using audio and video cables, select the correct audio and video in channel at the TV. *Details are on pages 8-13.*
- Make sure the DVD/VCR is in VCR position. Press VCR/TV so the green VCR/TV light appears on the DVD/VCR.
- Adjust the tracking. *Details are on page 43.*
- TVs placed too close to the DVD/VCR can cause interference during tape playback. Move the DVD/VCR away from the TV.

The Number buttons won't work for TV channels above 69.

- Select CABLE TV at the TUNER SET UP menu (page 24), then let the DVD/VCR set up the channels.
- Enter channel numbers as a two-digit number. If you want to select channels 100 and above, enter channel numbers as a three-digit number. If you do not have Cable TV, only channels 2-69 are available. *Details are on page 22.*

TV programs cannot be watched normally.

- Put the DVD/VCR in VCR mode, then put it in TV position. Press OUTPUT SELECT so the green VIDEO light appears. Then, press VCR/TV so the VCR/TV light does not appear on the DVD/VCR.
- Check the connections between the DVD/VCR, TV, antenna/cable, and Cable Box/Direct Broadcast System (if applicable). *Details are on pages 8-13.*

Poor reception

- You may need to tune your TV again.

The motor (cylinder) rotates even when tape playback is stopped.

- To enable the quick play mechanism, the cylinder will rotate for about five minutes. This is normal. The quick play mechanism allows the tape mechanism to switch from Stop to Play in one second.

Helpful Hints (cont'd) 77

You can not insert a video cassette.

- Insert the tape, window side up, with the record tab facing you.
- Make sure a tape isn't already in the VCR by pressing STOP/EJECT on the front of the DVD/VCR.
- Gently push on the center of the tape when putting it in the VCR. Never force the tape into the VCR.
- If a timer recording is set, you cannot insert a tape without a record tab.

You can not remove the tape.

- The DVD/VCR must be in VCR mode. Press OUTPUT SELECT so the green VIDEO light is on the front of the DVD/VCR.
- Make sure the power plug is completely connected to a power outlet.
- You have set a timer recording. Press TIMER SET to delay the timer recording. Then, press STOP/EJECT on the front of the DVD/VCR to eject the tape. Insert another tape and press TIMER SET to reset the timer recording.
- Unplug the DVD/VCR power cord for five minutes. Then, plug in the power cord again, then press POWER ON/OFF on the DVD/VCR. If the tape does not eject, press STOP/EJECT on the DVD/VCR three to five times. If the tape still does not eject, you may need to have an authorized servicer remove the tape.

DVD/VCR ejects the tape when you press REC/OTR or TIMER SET for a timer recording.

- Make sure the tape has a record tab. *Details are on page 31.*

Direct Broadcast System Hookups

- Watching one TV channel while recording another may not be possible if you have a DBS hookup. You may have to set your TV to channel 03 or 04, then make your channel selections at the DBS.
- With many DBS hookups, if you use accessory audio and video cables to connect your DVD/VCR to your TV, you will have to put your DVD/VCR in Line Input mode (channel 001 or 002).

Line Input mode

- If you accidentally enter Line Input mode (AV FRONT or AV REAR will appear on your TV screen briefly), press CHANNEL/SKIP ◀◀/▶▶ (▼/▲) or the Number buttons to select another channel.

Hi-Fi Stereo Sound

- During playback, Hi-Fi audio may normally revert to normal audio when you adjust tracking.
- When connecting the DVD/VCR to a stereo TV, you will only get stereo sound if you use audio cables to connect the DVD/VCR AUDIO OUT jacks on the DVD/VCR to the AUDIO IN jacks on your TV, and if the TV is in Line (Auxiliary) Input mode. See your TV owner's manual for details.
- When you connect the DVD/VCR AUDIO OUT jacks on the DVD/VCR to the AUDIO IN jacks on your TV, the stereo light on the TV might not glow. If the status display indicates you are receiving stereo, you are. *Details are on page 44.*
- Only tapes recorded in Hi-Fi audio will play in Hi-Fi audio. Tapes recorded in normal audio will play in monaural audio.

Cleaning the Video Heads

- Your DVD/VCR automatically cleans the video heads of the VCR each time you insert a tape. However, the heads may become dirty. If so, have an authorized servicer clean the video heads. Eventually, the heads may need to be replaced.

The playback picture is too dim, too bright, or fluctuates in brightness.

- Some programs may be broadcast with copyright protection technology in order to protect the rights of copyright owners. This technology is used on programs that are recorded on video cassettes or DVDs, as well as some programs broadcast by antenna/cable/satellite television channels. Programs broadcast with copyright protection may not record clearly. Likewise, if you play a tape that is a recording of a copyright protected program, the picture may not be clear. Tapes of copyright protected programs may have a picture that is dark or dim, or the brightness of the picture may fluctuate. Therefore, avoid recording or playing copies of copyright protected programs.
- This DVD/VCR incorporates copyright protection technology that is protected by method claims of certain U.S. patents and other intellectual property rights owned by Macrovision Corporation and other rights owners. Use of this copyright protection technology must be authorized by Macrovision Corporation and is intended for home and other limited viewing uses only, unless otherwise authorized by Macrovision Corporation. Reverse engineering or disassembly is prohibited.

Channels above 13 cannot be received.

- Select CABLE TV at the TUNER SET UP menu (page 24), then let the DVD/VCR set up the channels.

78 Limited Warranty

Digital Video Disc Player / Video Cassette Recorder Combination 90 days Free Product Exchange / 91 days—One Year Reduced-Cost Exchange

WHO IS COVERED?

You must have proof of the date of purchase to exchange your product. A sales receipt or other document showing the date that you purchased the product is considered such proof.

WHAT IS COVERED?

Warranty coverage begins the day you buy your product. For 90 days thereafter, you may exchange the defective product for a new or renewed product through Philips.

From 91 days to one year from the date of purchase, you will pay a preset exchange fee to obtain a new or renewed product. Follow the exchange procedures on the next page. This exchange opportunity ends one year after the date of purchase. The replacement product is covered only for the warranty period of the original product. When the warranty on the original product expires, the warranty on all replaced products also expires.

When it is necessary for you to ship the product to Philips for exchange, you will pay the shipping costs for shipment to Philips. Philips will pay the shipping costs when returning a product to you.

WHAT IS EXCLUDED?

Your warranty does not cover:

- shipping charges to return defective product.
- labor charges for installation or setup of the product, adjustment of customer controls on the product, and installation or repair of antenna systems outside of the product.
- product repair and/or part replacement because of improper installation, abuse, neglect, misuse, accident, unauthorized repair or other cause not within the control of Philips.
- reception problems caused by signal conditions or cable or antenna systems outside the product.
- a product that requires modification or adaptation to enable it to operate in any country other than the country for which it was designed, manufactured, approved and/or authorized, or repair of products damaged by these modifications.
- incidental or consequential damages resulting from the product. (Some states do not allow the exclusion of incidental or consequential damages, so the above exclusion may not apply to you. This includes, but is not limited to, prerecorded material, whether copyrighted or not copyrighted.)
- damage caused by the use of non-VHS tapes or tapes that have not been tested and labeled for use in two, four, six, and eight hour VHS recorders.
- a product that is used for commercial or institutional purposes (including but not limited to rental purposes).

WHERE IS EXCHANGE AVAILABLE?

Warranty exchange is available in all countries where the product is officially distributed by Philips. In countries where Philips does not distribute the product, the local Philips service organization will attempt to exchange the product, although there may be a delay if the appropriate product is not readily available.

MAKE SURE YOU KEEP...

Please keep your sales receipt or other document showing proof of date of purchase. Attach it to the owner's manual and keep both nearby. Also keep the original box and packing material in case you need to return your product.

BEFORE EXCHANGING THE PRODUCT...

Please check your owner's manual before exchanging the product. Adjustments of the controls discussed there may save you time and money.

LIMITATION OF LIABILITY AND REMEDY...

PHILIPS IS NOT LIABLE UNDER ANY CIRCUMSTANCES FOR ANY DIRECT, INDIRECT, SPECIAL, INCIDENTAL, OR CONSEQUENTIAL DAMAGES, HOWSOEVER INCURRED, EVEN IF NOTIFIED OF THE POSSIBILITY OF SUCH DAMAGES.

TO THE EXTENT PERMITTED BY LOCAL LAW, THE REMEDIES PROVIDED IN THIS WARRANTY STATEMENT ARE YOUR SOLE AND EXCLUSIVE REMEDY. THIS LIMITED WARRANTY GIVES YOU SPECIFIC LEGAL RIGHTS, AND YOU MAY ALSO HAVE OTHER RIGHTS WHICH VARY FROM STATE/PROVINCE TO STATE/PROVINCE.

TO EXCHANGE YOUR PRODUCT IN THE U.S.A., PUERTO RICO, OR U.S. VIRGIN ISLANDS...

FOLLOW THE INSTRUCTIONS STATED PREVIOUSLY IN THE "WHAT IS COVERED" SECTION, OR REFER TO THE EXCHANGE INSTRUCTIONS ON THE NEXT PAGE. IN THE U.S.A., PUERTO RICO, AND U.S. VIRGIN ISLANDS, ALL IMPLIED WARRANTIES, INCLUDING THE IMPLIED WARRANTIES OF NON-INFRINGEMENT, MERCHANTABILITY AND FITNESS FOR A PARTICULAR PURPOSE, ARE SPECIFICALLY DISCLAIMED, AND TO THE EXTENT INCONSISTENT WITH LAW OF THE LOCALITY OF THE USER, LIMITED IN DURATION TO THE DURATION OF THIS EXPRESS WARRANTY. BECAUSE SOME STATES DO NOT ALLOW LIMITATIONS ON HOW LONG AN IMPLIED WARRANTY MAY LAST, THIS LIMITATION MAY NOT APPLY TO YOU.

TO EXCHANGE A PRODUCT IN CANADA...

Please contact Philips at:

1-800-661-6162 (French Speaking)

1-800-531-0039 (English or Spanish Speaking)

In Canada, this warranty is given in lieu of all other warranties. There are no other warranties, express or implied, including any implied warranties of merchantability or fitness for a particular purpose.

REMEMBER...

Please record below the model and serial numbers found on the product. Also, please fill out and mail your warranty registration card promptly. It will be easier for us to notify you if necessary.

MODEL # _____

SERIAL # _____

Philips, P.O. Box 520890, Miami, FL 33152 (402) 536-4171

Limited Warranty (cont'd) 79

EXCHANGE INSTRUCTIONS

To exchange your product with Philips (per the warranty conditions stated previously), remember:

- If you exchange the product within 90 days of the original purchase, there is no cost to you.
- If you exchange the product more than 90 days after but less than one year after the day of original purchase, contact Philips at 1-800-531-0039 to determine the preset cost for exchange.
- If you do not have your original sales receipt, or if you have any questions, call Philips at 1-800-531-0039.

To obtain a replacement product from Philips:

1. Contact Philips at 1-800-531-0039 to determine the cost for exchange.
2. Complete the Exchange Form below.
3. Pack the product and its accessories in the original box or a suitable alternative. You will receive replacement accessories with your replacement product. For packing details, call 1-800-531-0039.
4. Put the completed Exchange Form, a copy of the original sales receipt, and the proper payment amount into an envelope. **DO NOT SEND CASH.** Do not staple or clip these items together. Label the envelope "Return Documents Enclosed." Place this envelope in the box with the product.
5. Seal the box with packing tape and return the product via United Parcel Service (UPS), insured and freight prepaid, to:

Philips Recovery Center
 Rojas 6
 12420 Mercantile Avenue
 El Paso, TX 79928
ATTENTION: DVD/VCR COMBINATION EXCHANGE

A replacement will be sent to you via UPS within 48 business hours of Philips' receipt of the product.

When it is necessary for you to ship the product to Philips for exchange, you will pay the shipping costs for shipment to Philips. Philips will pay the shipping costs when returning a product to you.

EXCHANGE FORM

Your Address (street address to which replacement should be delivered, no P.O. boxes allowed):

Name: _____
 Street Address: _____ Apt. #: _____
 City: _____ State/Province: _____ Zip Code/Postal Code: _____
 Phone (day): _____ Phone (night): _____

Exchange Fee: _____ **+ Sales Tax:** _____ **= Total:** _____

Method of Payment: (Check one. Please, no cash or CODs.)

_____ Check/Money order Check/Money order No. _____

	Account number	Expiration date
_____ American Express	_____	_____
_____ Visa	_____	_____
_____ Novus/Discover	_____	_____
_____ Mastercard	_____	_____

Signature: _____

Detailed reason for return, use additional paper if necessary: _____

Model Number _____ Serial Number _____

Remember, the return box should include the following:

- **The product,**
- **Accessories supplied with the product, and**
- **Completed Exchange Form and sales receipt,**
- **Payment, if applicable.**

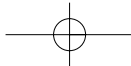

80 Information Index

- ac power cord 21
- angle button 22, 55
- ant-in (antenna in) jack 8-13, 21
- ant-out (antenna out) jack 8-10, 21
- arrow buttons 22
- audio button 23, 58
- audio cd 6
- audio in/out jacks 11, 12, 20, 21, 38, 44
- audio settings 70
- automatic
playback 43
rewind, eject 43
- a-b repeat 53
- a-b repeat button 22, 53
- batteries 14
- blue background 47
- camera angle 55
- cassette compartment 19
- ch3/ch4 switch 8-10, 21
- channel
adding 25
deleting 25
reviewing 26
selection 22
setup 15, 24
▲/▼ buttons 20, 43
- channel/skip |◀◀▶▶| (▲/▼)
buttons 23, 51
- chapters 50
- clear button 23, 40
- clock setting 27
- coaxial (digital audio out)
jack 13, 21, 73
- component video out jacks 12, 21, 73
- connections 7-13
- contents, table of 4
- controls
dvd/vcr 18-21
remote 22-23
- copyright protection 38, 77
- counter only mode 30
- cst. in light 19
- daylight-savings time 28
- disc/menu button 23, 48
- display/status/exit button 22, 30, 65
- display panel 18-19
- duplication 38
- dvd button 22
- dvd video 6
- ejecting a tape 20, 43, 77
- fast forward 42, 49
- ff (fast forward) button 22
- f.fwd (fast forward) button 20
- front panel 20
- glossary 73
- head cleaner 72, 78
- helpful hints 74-77
- hi-fi stereo sound 46
- hookups
cable box/dbs 9-10
component video 12
s-video 11
stereo receiver 13
tv 8-13
language (dvd) 68-69
language (vcr) 29
line input mode 38, 73
long play 36, 73
lp 36, 73
- marker button 22, 54
- memory button 23, 40
- menus 5, 48
- mode button 23, 60-61
- mp3 display information 63
- mp3 playback 62
- mp3 track selection 63
- number buttons 22
- ok button 22
- on-screen status displays (vcr) 30
- one-touch recording 33
- open/close button 17, 20
- output select button 23
- parental controls 56-57
- password 56
- pause button 23, 31, 42, 52
- play button 16-17, 20, 22
- playing discs 17
- playing tapes 16
- power
button 22
cord 21
light 19
power on/off button 20
programmed playback (audio cd) 60
programmed playback (mp3) 64
- random playback (audio cd) 61
- random playback (mp3) 64
- real-time tape counter 40
- rear panel 21
- rec (record) button 20
- rec (record) light 19
- rec/otr button 23, 31, 33
- recording
basic 31
one channel/watching another 32
prevention 31
timer 34-37
- remote control
buttons 22-23
sensor 20
using 14
- repeat button 22, 53
- repeat play (tape) 39
- repeat playback (discs) 53
- rerecording 38
- resuming play 52
- return button 22
- reverse searching 42, 49
- rew (rewind) button 20, 23, 42, 49
- rf coaxial cable 8-13, 38, 44, 73
- safety precautions 3
- screen saver 75
- search mode/time search button
..... 23, 41, 50-51
- searching 42, 49
- second audio broadcast
receiving 44-45
recording 44-45
- sensor (remote) 20
- settings (dvd)
audio 70
language 68-69
- setup button 23
- slow
button 23, 42
motion 42, 59
- slp 36, 73
- source button 20
- sp 36, 73
- speed button 23, 31
- standard play 36, 73
- status display (vcr) 30
- stereo broadcast
hookups 44
receiving 44-45
recording 44-45
- stereo TV hookups 11
- still picture 42, 52
- stop button 20, 23
- stop/eject button 20
- subtitle button 22, 55
- super high speed searching 42
- super long play 36, 73
- s-video out jack 11, 21
- table of contents 4
- tape
duplication 38
eject 20, 43, 77
speed 36, 73
- time search 41
- timer button 20
- timer light 19
- timer recording
cancelling 37
checking 37
setting 34-36
- timer set button 22, 36
- title button 23, 48
- titles 48, 50
- tracking 43
- tracks 51
- trusurround 71
- tv hookups 7-13
- tv position 19, 23
- vcr button 23
- vcr position 19, 23
- vcr/tv button 23
- vcr/tv light 19
- video in/out jacks 11, 13, 20, 21, 38, 44
- warranty 78-79
- zoom button 22, 59

