

DVD/VIDEO CD/CD PLAYER

Operating Instructions

Model No. **DVD-RV40**

DVD-RV20

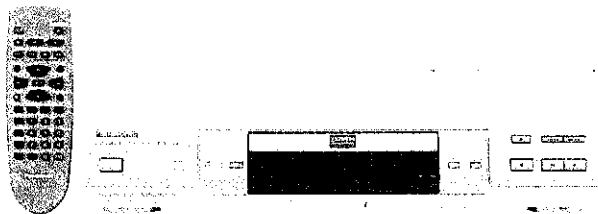

The photographs show DVD-RV40.

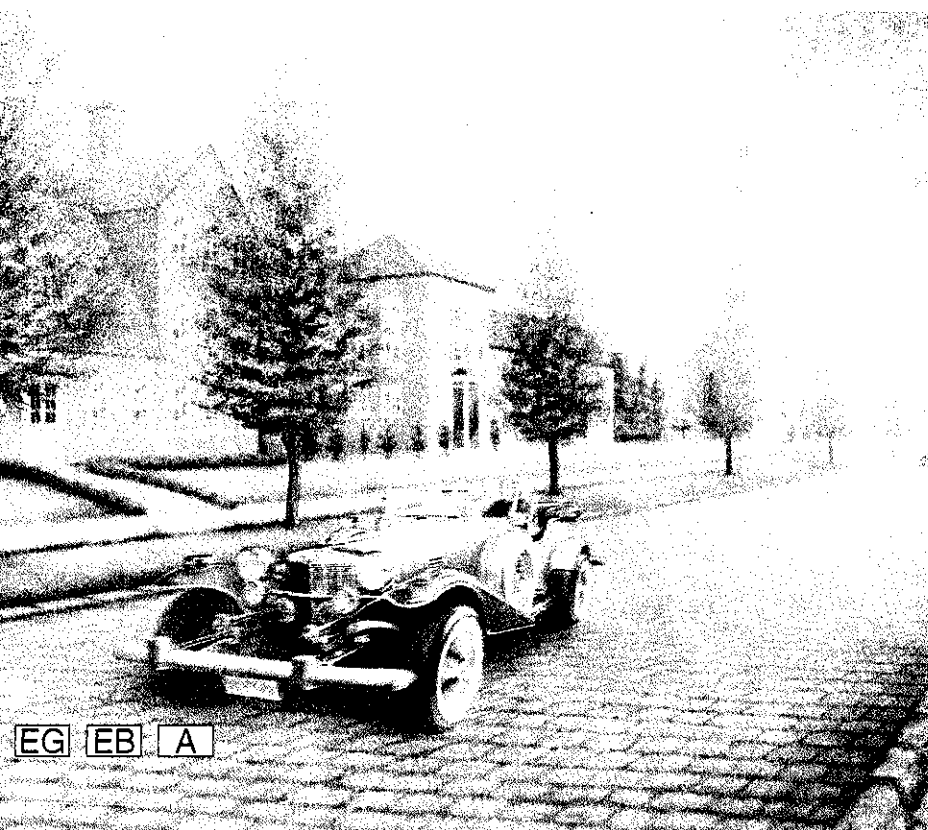

Panasonic

For the United Kingdom and Continental Europe

■ Region number supported by this player

Region numbers are allocated to DVD players and software according to where they are sold.

- The region number of this player is "2".
- The player will play DVDs marked with labels containing "2" or "ALL".

Example:



For Australia and N.Z.

■ Region number supported by this player

Region numbers are allocated to DVD players and software according to where they are sold.

- The region number of this player is "4".
- The player will play DVDs marked with labels containing "4" or "ALL".

Example:



Only for the United Kingdom

Note

The "EB" indication shown on the packing case indicates the United Kingdom.

Before connecting, operating or adjusting this product, please read these instructions completely. Please keep this manual for future reference.

VQT8633

EG EB A

Dear Customer

Thank you for purchasing this product.
For optimum performance and safety, please read these instructions carefully.

These operating instructions are applicable to models DVD-RV40 and DVD-RV20.

These operating instructions, however, are intended primarily for model DVD-RV40.

DVD-RV40: indicates features applicable to DVD-RV40 only.

DVD-RV20: DVD-RV20 only.

Accessories



Please check and identify the supplied accessories.

Use numbers indicated in parentheses when asking for replacement parts.

Remote control 1
(VEQ2380)



Batteries 2
for remote control

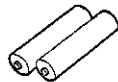

AC mains lead 1

(For the United Kingdom)



(VJA0940)

(For Continental Europe)



(VJA0664-1)

(For Australia and N.Z.)

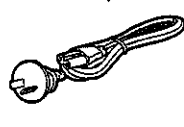

(VJA0754)

Audio/video cable 1
(VJA1062 or VJA0788-D)

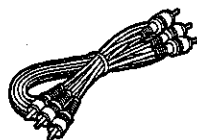

Note

• The included AC mains lead is for use with this unit only. Do not use it with other equipment.

Table of contents

Getting Started

Accessories	2
SAFETY INFORMATION	3
SAFETY PRECAUTIONS	3
Caution for AC Mains Lead	4
SCART and S video terminal information	5
Disc information	6
Remote control preparations	7
Control reference guide	8
Connection to a television	9

Basic Operations

Basic play	13
Stopping play	14
Other methods of play	15
Still picture (Pause)	15
Skipping chapters or tracks	15
Frame advance (Frame reverse)	15
Slow-motion play	15
Rapid advance (Rapid reverse)	16
Canceling playback control	16
Using menus to play	16

Advanced Operations

Advanced operations	17
Changing soundtrack language	17
Changing subtitle language	18
Viewing from another angle	18
Changing picture quality for movie viewing DVD-RV40	19
Raising dialogue volume	19
Reproducing an Advanced Virtual Surround Sound (V.S.S.) effect	20
Repeat play	21
Repeating sections between two specific points (A-B repeat)	21
Program play	22
Random play	22
Using GUI screens	23
Common procedures	23
Detailed descriptions of each icon	24
Changing initial settings	26
Common procedures	26
1 Disc Languages	27
2 Ratings	28
3 Menu Language	29
4 On-Screen Messages	29
5 FL Display	29
9 Other Settings	30
How different kinds of software appear on your television	31

Home Theater

Home theater	32
Connecting an amplifier with 5.1-channel audio input terminals DVD-RV40	33
Connecting a subwoofer DVD-RV20	34
Connecting audio equipment with 2-channel audio input terminals	34
Connecting an amplifier with a built-in decoder	35
Connecting audio equipment with digital audio input terminals	36
Selecting digital output	37
Speaker setting DVD-RV40	39

For Your Reference

Troubleshooting Guide	41
Disc handling	43
Maintenance	43
Specifications	Back cover

SAFETY INFORMATION

Note

This player can be used only where the power supply is AC 220-240 V, 50 Hz. It cannot be used else where.

CAUTION:

DVD/VIDEO CD/CD PLAYER IS A CLASS 1 LASER PRODUCT. HOWEVER, THIS DVD/VIDEO CD/CD PLAYER USES A VISIBLE LASER BEAM WHICH COULD CAUSE HAZARDOUS RADIATION EXPOSURE IF DIRECTED. BE SURE TO OPERATE THE DVD/VIDEO CD/CD PLAYER CORRECTLY AS INSTRUCTED.

WHEN THIS DVD/VIDEO CD/CD PLAYER IS PLUGGED TO THE WALL OUTLET, DO NOT PLACE YOUR EYES CLOSE TO THE OPENING OF THE DISC TRAY AND OTHER OPENINGS TO LOOK INTO THE INSIDE OF THIS PLAYER.

USE OF CONTROLS OR ADJUSTMENTS OR PERFORMANCE OF PROCEDURES OTHER THAN THOSE SPECIFIED HEREIN MAY RESULT IN HAZARDOUS RADIATION EXPOSURE.

DO NOT OPEN COVERS AND DO NOT REPAIR YOURSELF. REFER SERVICING TO QUALIFIED PERSONNEL.

WARNING:

TO REDUCE THE RISK OF FIRE OR ELECTRIC SHOCK, DO NOT EXPOSE THIS PLAYER TO RAIN OR MOISTURE.

TO REDUCE THE RISK OF FIRE OR ELECTRIC SHOCK, AND ANNOYING INTERFERENCE, USE THE RECOMMENDED ACCESSORIES ONLY.

THIS PLAYER IS INTENDED FOR CONTINUOUS OPERATION!

CAUTION	-LASER RADIATION WHEN OPEN. DO NOT STARE INTO BEAM.
ATTENTION	-RAYONNEMENT LASER EN CAS D'OUVERTURE. NE PAS REGARDER DANS LE FAISCEAU.
VORSICHT	-LASERSTRAHLUNG, WENN ABDECKUNG GEÖFFNET. NICHT IN DEN STRAHL BLICKEN.
ADVARSEL	-LASERSTRÅLING VED ÅBNING. SE IKKE IND I STRÅLEN.
ADVARSEL	-LASERSTRÅLING NÅR DEKSEL ÅPNES. STIR IKKE INN I STRÅLEN.
VARNING	-LASERSTRÅLNING NÅR DENNA DEL ÄR ÖPPNAD. STIRRA EJ IN I STRÅLEN.
VARO!	-AVATTAESSA OLET ALTTIINA LASERSÄTEILYLLE. ÄLÄ TUJOTA SÄTEESEEN.
注意	- 当打开这里会出现激光, 请不要直视激光。
注意	- ここを開くとレーザー光が出ます。 レーザー光をのぞきままないでください。

(Inside of player)

SAFETY PRECAUTIONS

Placement

Set the unit up on an even surface away from direct sunlight, high temperatures, high humidity, and excessive vibration. These conditions can damage the cabinet and other components, thereby shortening the unit's service life.

Place it at least 15 cm away from wall surfaces to avoid distortion and unwanted acoustical effects.

Do not place heavy items on the unit.

Voltage

Do not use high voltage power sources. This can overload the unit and cause a fire.

Do not use a DC power source. Check the source carefully when setting the unit up on a ship or other place where DC is used.

AC mains lead protection

Ensure the AC mains lead is connected correctly and not damaged. Poor connection and lead damage can cause fire or electric shock. Do not pull, bend, or place heavy items on the lead.

Grasp the plug firmly when unplugging the lead. Pulling the AC mains lead can cause electric shock.

Do not handle the plug with wet hands. This can cause electric shock.

Foreign matter

Do not let metal objects fall inside the unit. This can cause electric shock or malfunction.

Do not let liquids get into the unit. This can cause electric shock or malfunction. If this occurs, immediately disconnect the unit from the power supply and contact your dealer.

Do not spray insecticides onto or into the unit. They contain flammable gases which can ignite if sprayed into the unit.

Service

Do not attempt to repair this unit by yourself. If sound is interrupted, indicators fail to light, smoke appears, or any other problem that is not covered in these instructions occurs, disconnect the AC mains lead and contact your dealer or an authorized service center. Electric shock or damage to the unit can occur if the unit is repaired, disassembled or reconstructed by unqualified persons.

Extend operating life by disconnecting the unit from the power source if it is not to be used for a long time.

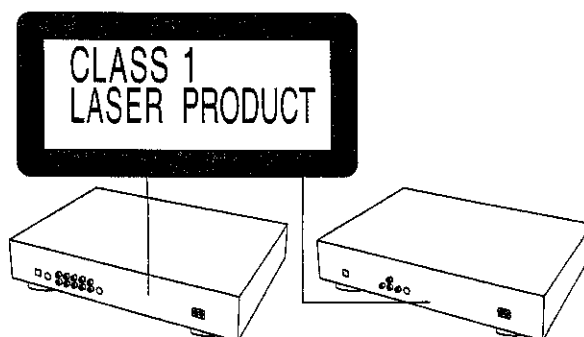

(Back of player)

DVD-RV40

(Back of player)

DVD-RV20

Getting Started



Caution for AC Mains Lead **Only for the United Kingdom**

For your safety please read the following text carefully

This appliance is supplied with a moulded three pin mains plug for your safety and convenience.

A 5 amp fuse is fitted in this plug.

Should the fuse need to be replaced please ensure that the replacement fuse has a rating of 5 amps and that it is approved by ASTA or BSI to BS 1362.

Check for the ASTA mark  or the BSI mark  on the body of the fuse.

If the plug contains a removable fuse cover you must ensure that it is refitted when the fuse is replaced.

If you lose the fuse cover the plug must not be used until a replacement cover is obtained.

A replacement fuse cover can be purchased from your local Panasonic Dealer.

IF THE FITTED MOULDED PLUG IS UNSUITABLE FOR THE SOCKET OUTLET IN YOUR HOME THEN THE FUSE SHOULD BE REMOVED AND THE PLUG CUT OFF AND DISPOSED OF SAFELY.

THERE IS A DANGER OF SEVERE ELECTRICAL SHOCK IF THE CUT OFF PLUG IS INSERTED INTO ANY 13 AMP SOCKET.

If a new plug is to be fitted please observe the wiring code as shown below.

If in any doubt please consult a qualified electrician.

IMPORTANT

The wires in this mains lead are coloured in accordance with the following code:

Blue: Neutral

Brown: Live

As the colours of the wires in the mains lead of this appliance may not correspond with the coloured markings identifying the terminals in your plug, proceed as follows:

The wire which is coloured BLUE must be connected to the terminal in the plug which is marked with the letter N or coloured BLACK.

The wire which is coloured BROWN must be connected to the terminal in the plug which is marked with the letter L or coloured RED.

Under no circumstances should either of these wires be connected to the earth terminal of the three pin plug, marked with the letter E or Earth Symbol .

How to replace the Fuse

• There are two types of the AC Mains Lead: (A) or (B) supplied with the player as shown below.

1 Open the fuse compartment with a screwdriver.

2 Replace the fuse and fuse cover.

TYPE (A)

1

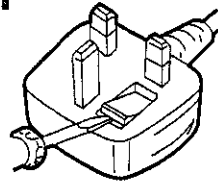

2

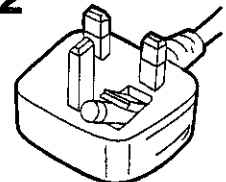

TYPE (B)

1

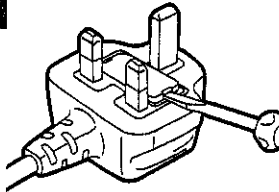

2

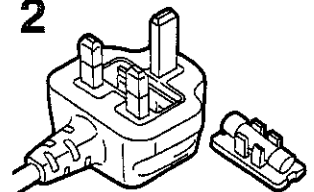

21-pin SCART terminal

Pin NO	AV1 (Video)/ AV2 (Playback)	AV1 (S video)	AV1 (Standby)/ AV2 (Standby)
1	Audio Output (R)	Audio Output (R)	Audio Output (R)
2	Audio Input (R)	Audio Input (R)	Audio input (R)
3	Audio Output (L)	Audio Output (L)	Audio Output (L)
4	Audio GND	Audio GND	Audio GND
5	No Connection	No Connection	Blue GND
6	Audio Input (L)	Audio Input (L)	Audio Input (L)
7	No Connection	No Connection	Blue
8	Switching Voltage	Switching Voltage	Switching Voltage
9	No Connection	No Connection	Green GND
10	Through AV1 to AV2	Through AV1 to AV2	Through AV1 to AV2
11	No Connection	No Connection	Green
12	No Connection	No Connection	No Connection
13	No Connection	S video (C) Output GND	Red GND
14	Blanking GND	Blanking GND	Blanking GND
15	No Connection	S video (C) Output	Red
16	Blanking	Blanking	Blanking
17	Video Output GND	S video (Y) Output GND	Video Output GND
18	Video input GND	Video Input GND	Video Input GND
19	Video Output	S video (Y) Output	Video Output
20	Video Input	Video Input	Video Input
21	GND	GND	GND

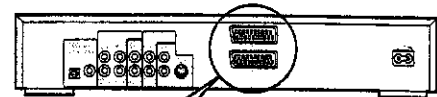

These figures show DVD-RV40.

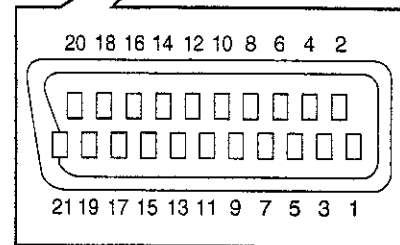

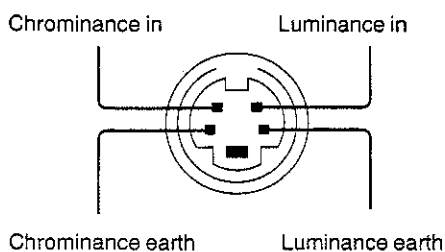

- You can select "Video" or "S-Video" at the "6 AV1 Output" of the initial settings "9 Other Settings" (⇒ page 30).
- DVD-RV20 has a single SCART terminal, labeled AV, and equates AV1.

S video 4-pin terminal



Disc information

Getting Started

✓ Discs supported by this player	✗ Discs not supported by this player
DVD-Video  8 cm disc/ 12 cm disc	<ul style="list-style-type: none"> ● Do not try to play Photo CD or CD-R. (Data on the disc may be damaged.) ● DVD with region number other than the region number of this player or "ALL" ● CD-G ● DVD-ROM ● DVD-R ● DVD-RW ● CVD ● CDV etc. ● Divx Video Disc ● CD-RW ● DVD-Audio ● DVD+RW ● DVD+ROM ● SVCD ● SACD ● VSD
Video CD  8 cm disc/ 12 cm disc	
Audio CD  8 cm disc/ 12 cm disc	

For the purpose of these operating instructions, "DVD" stands for DVD-Video and "CD" stands for Audio CD.

Region number supported by this player

For the United Kingdom and Continental Europe:

Region numbers are allocated to DVD players and software according to where they are sold.

- The region number of this player is "2".
- The player will play DVDs marked with labels containing "2" or "ALL".

Example:



For Australia and N.Z.

Region numbers are allocated to DVD players and software according to where they are sold.

- The region number of this player is "4".
- The player will play DVDs marked with labels containing "4" or "ALL".

Example:



Playing DVDs and Video CDs

The producer of the material can control how these discs are played. This means that you may not be able to control play of a disc with some operations described in these operating instructions. Read the disc's instructions carefully.

- Example:**
- "⊙" appears when you press the skip buttons to move to the next section.
 - Resume, repeat play, and markers may not work during play of interactive DVDs and menu play of Video CDs with playback control.
 - After showing the Karaoke menu, tracks are played successively without returning to the menu (Video CD with playback control).

"Copy Protection"

Some DVD discs contain a "Copy Protection" signal which can affect the video signal if the output of the player is fed through a VCR to the TV. The picture may become unstable or the picture contrast may change drastically. It is therefore very important to connect this DVD/VIDEO CD/CD player according to the diagram in these Operating Instructions.

Marks used in these operating instructions

DVD: indicates features applicable to DVD only.

Video CD: Video CD only.

CD: CD only.

Compatible with PAL DVD/Video CD and NTSC DVD/Video CD

This player can play discs recorded in either PAL or NTSC format. However, the player must be connected to a Multi-system television or PAL television which is capable of receiving PAL 525/60 system to play both PAL DVD/Video CD and NTSC DVD/Video CD. The use of a Multi-system television is recommended.

Type of disc for the type of television

DVD and Video CDs are recorded using either PAL or NTSC. Refer to this table to select discs suitable for your television.

- ✓ Clear images are shown on the screen.

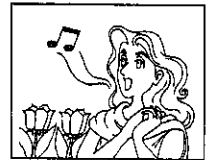

- ✗ No clear images shown on the screen.



TV type	Disc	TV Monitor
Multi-system TV	PAL	✓
	NTSC	✓#1
NTSC	PAL	✗
	NTSC	✗
PAL	PAL	✓
	NTSC	✓#2

#1 If you select "2 NTSC" in "7 NTSC Disc Output" in "9 Other settings", the picture may be clearer (→page 30).

#2 In "9 Other settings" — "7 NTSC Disc Output", select "1 PAL 60" (→page 30).

Note

- The bottom part of the picture may be cut off if the Video CD played does not comply with standards.

Remote control preparations

Terms used in these operating instructions

• Title/Chapter **DVD**

DVDs are divided up into large sections, titles, and smaller sections, chapters. The numbers allocated to these sections are called title numbers and chapter numbers.

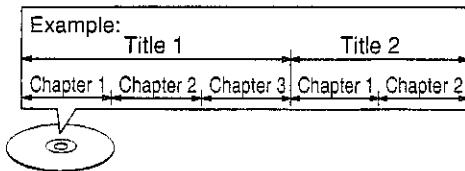

• Track **CD**

Video CDs and CDs are divided up into sections called tracks, and the numbers allocated to these sections are called track numbers.

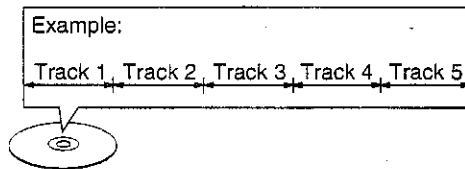

• Playback control **VCD**

If a Video CD has "playback control" written on its disc or jacket, it means that particular scenes or information can be selected for viewing interactively with the TV monitor using the menu screen. This player can play Video CDs with playback control. Using menus to control play of a Video CD is called "menu play" in these operating instructions.

Display during menu play of a Video CD with playback control

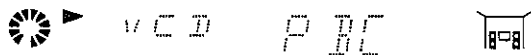

• Interactive DVD **DVD**

An interactive DVD is DVD software which includes multiple angles, multiple plot endings, etc. The elapsed play time of some of these DVDs is not shown.

Display during play of an interactive DVD

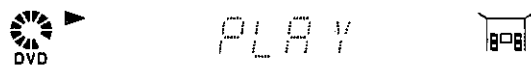

Battery installation

Use of batteries

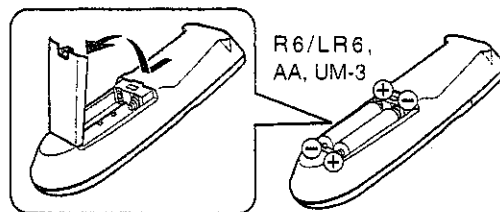

- Align the poles (+ and -) properly when inserting the batteries.
- Do not mix old and new batteries or different types of batteries.
- Do not recharge ordinary dry cell batteries.
- Do not heat or disassemble the batteries. Do not allow them to contact flame or water.
- Remove the batteries if the unit is not to be used for a long time.
- Do not keep together with metallic objects such as necklaces.
- Do not use rechargeable type batteries.
- Do not use batteries if the covering has been peeled off.

Mishandling of batteries can cause electrolyte leakage which can damage items the fluid contacts and may cause a fire. If electrolyte leaks from the batteries, consult your dealer. Wash thoroughly with water if electrolyte comes in contact with any part of your body.

Correct method of use

Operation notes

Remote control signal sensor

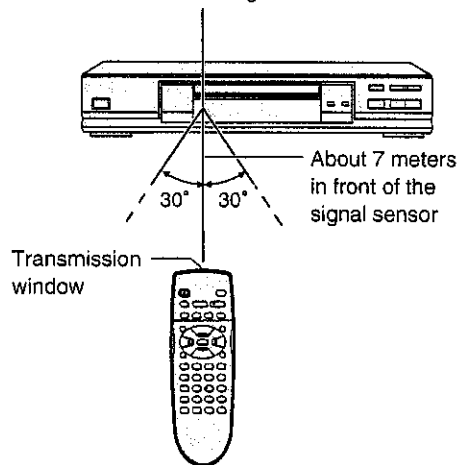

- Do not place obstacles between the remote control signal sensor and remote control unit.
- Do not expose the remote control signal sensor to direct sunlight or to the bright light of a fluorescent light.
- Take care to keep the remote control signal sensor and end of the remote control unit free from dust.
- If this system is installed in a rack with glass doors, the glass doors' thickness or colour might make it necessary to use the remote control a shorter distance from the system.

To prevent damage

- Never place heavy items on top of the unit.
- Do not disassemble or reconstruct the unit.
- Do not spill water or other liquids into the unit.

Control reference guide

Getting Started

DVD-RV40

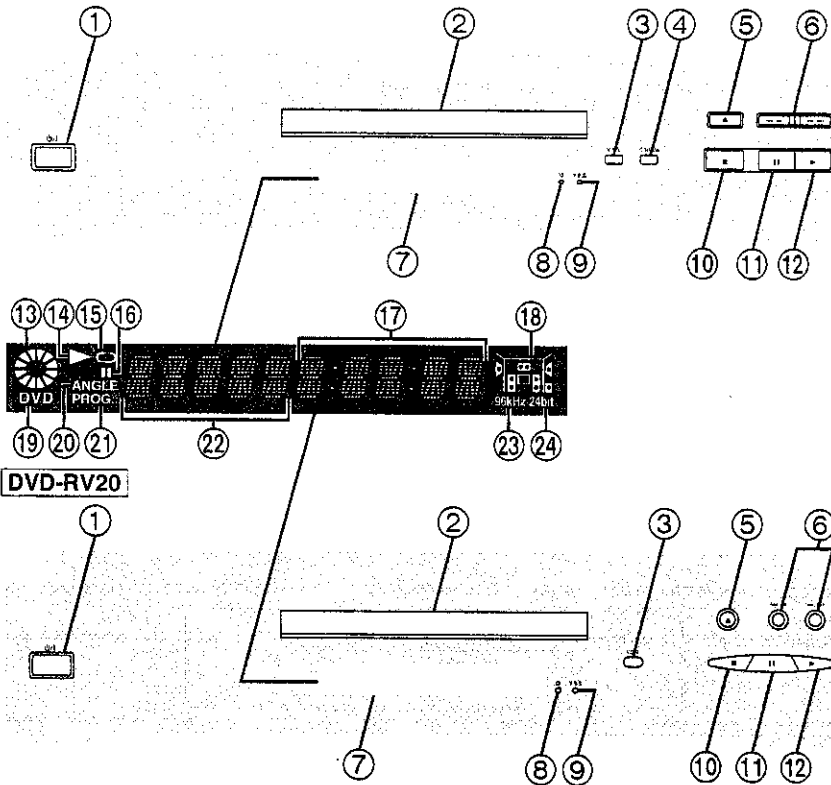

Buttons such as ❶ function in exactly the same way as the buttons on the player.

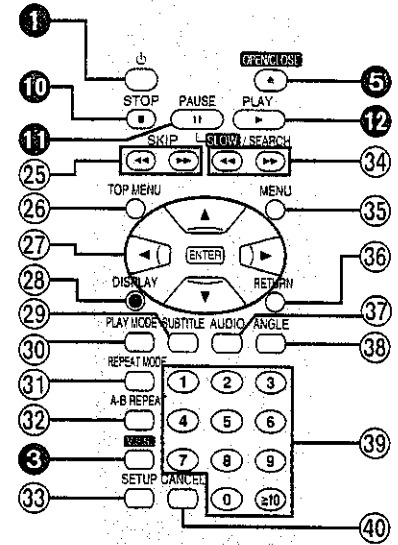

Player

Page

- ❶ **Standby/on switch (⏻/⏻)** 13
Press to switch the unit from on to standby mode or vice versa. In standby mode, the unit is still consuming a small amount of power.
- ❷ **Disc tray** 13
- ❸ **Virtual Surround Sound button (V.S.S.)** 20
- ❹ **DVD-RV40 Cinema button (CINEMA)** 19
- ❺ **Disc tray open/close button (⏏)** 13
- ❻ **Skip/Search buttons (⏮/⏪, ⏩/⏭)** 15
- ❼ **FL display**
- ❽ **STANDBY indicator (⏻)**
When the unit is connected to the AC mains supply, this indicator lights up in standby mode and goes out when the unit is turned on.
- ❾ **Virtual Surround Sound indicator (V.S.S.)** 20
- ❿ **Stop button (■)** 14
- ⓫ **Pause button (⏸)** 15
- ⓬ **Play button (▶)** 13
- ⓭ **Rotates during play.**
Rotates fast clockwise or counterclockwise during rapid advance (reverse).
Rotates slowly clockwise or counterclockwise during slow-motion play. **DVD**
- Illuminates in the stop mode.**
- ⓯ **Illuminates during playback.**
Flashes when the RESUME function is ON.
- ⓰ **Illuminates during repeat play.**
- ⓱ **Illuminates in the still picture (pause) mode.**
- ⓲ **Elapsed playing time from the start of the title/track during play**

- ⓳ **Audio channel information recorded in the disc being played back (e.g. 2ch or 5.1ch)**

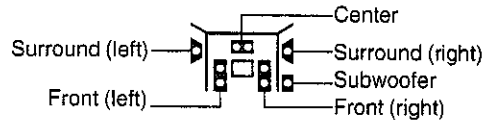

- ⓴ **A DVD is loaded.**
- ⓵ **It is possible to change the angle.** **DVD**
- ⓶ **Illuminates during program play.** **CD**
- ⓷ **Title/chapter number** **DVD**
- Track number** **CD**
- ⓸ **Linear PCM of 96 kHz sampling is being played.**
- ⓹ **Linear PCM of 24 bit is being played.**

Remote control

Page

- ⓺ **Skip buttons (⏮, ⏭ SKIP)** 15
- ⓻ **Top menu button (TOP MENU)** 13
- ⓼ **Cursor buttons (▲, ▼, ◀, ▶)/Enter button (ENTER)** 13
- ⓽ **Display button (DISPLAY)** 23
- ⓾ **Subtitle button (SUBTITLE)** 18
- ⓿ **Play mode button (PLAY MODE)** 22
- ⓿ **Repeat mode button (REPEAT MODE)** 21
- ⓿ **A-B repeat button (A-B REPEAT)** 21
- ⓿ **Setup button (SETUP)** 26
- ⓿ **Slow/Search buttons (⏮, ⏭ SLOW/SEARCH)** 15
- ⓿ **Menu button (MENU)** 13
- ⓿ **Return button (RETURN)** 13
- ⓿ **Audio button (AUDIO)** 17
- ⓿ **Angle button (ANGLE)** 18
- ⓿ **Numeric buttons (1-9, 0, ≥10)** 13
•To select a 2-digit number
Example: To select track 23
Press [≥10], then [2] and [3].
- ⓿ **Cancel button (CANCEL)** 22

Connection to a television

- Ensure that this player and other equipment to be connected are switched to the standby mode or off and disconnect the AC mains lead before commencing connection.
- Do not block ventilation holes of any of the equipment and arrange them so that air can circulate freely.
- Read through the instructions before connecting other equipment.
- Ensure that you observe the colour coding when connecting audio and video cables.
- See page 32 for information about how to upgrade your system with other audio/visual equipment.

Note:

- Additional equipment and cables are not supplied.
- TV volume may be lower when playing DVDs than during television broadcasts. Turn the volume up while playing DVDs and reduce it to the previous level **before** switching the source back to television to avoid sudden changes in volume.
- When you have finished connection, select the appropriate screen type at the initial setting "6 TV Aspect" according to your television (4:3/16:9) (→ page 12). No changes are needed if you connect the player to a conventional television (4:3).

Conserving power

- The unit consumes approximately 4.0 W even when it is turned off with [⏻/I]. To save power when the unit is not to be used for a long time, unplug it from the mains socket.

Connect Your Player Directly To Your Television.

If the player is connected to the television through a video cassette recorder, the picture may not be played back correctly due to the copy guard. So we strongly recommend you do not connect the player to your video cassette recorder when setting up your home entertainment system.

- Connect to the television section if you connect the player to a combined television-video player.

Do not place the player on amplifiers or other equipment which may become hot.

The heat can damage the player.

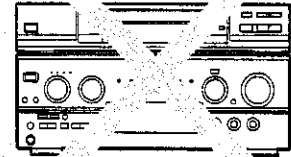

Connecting to a television with video input terminal or S video input terminal For the United Kingdom and Continental Europe

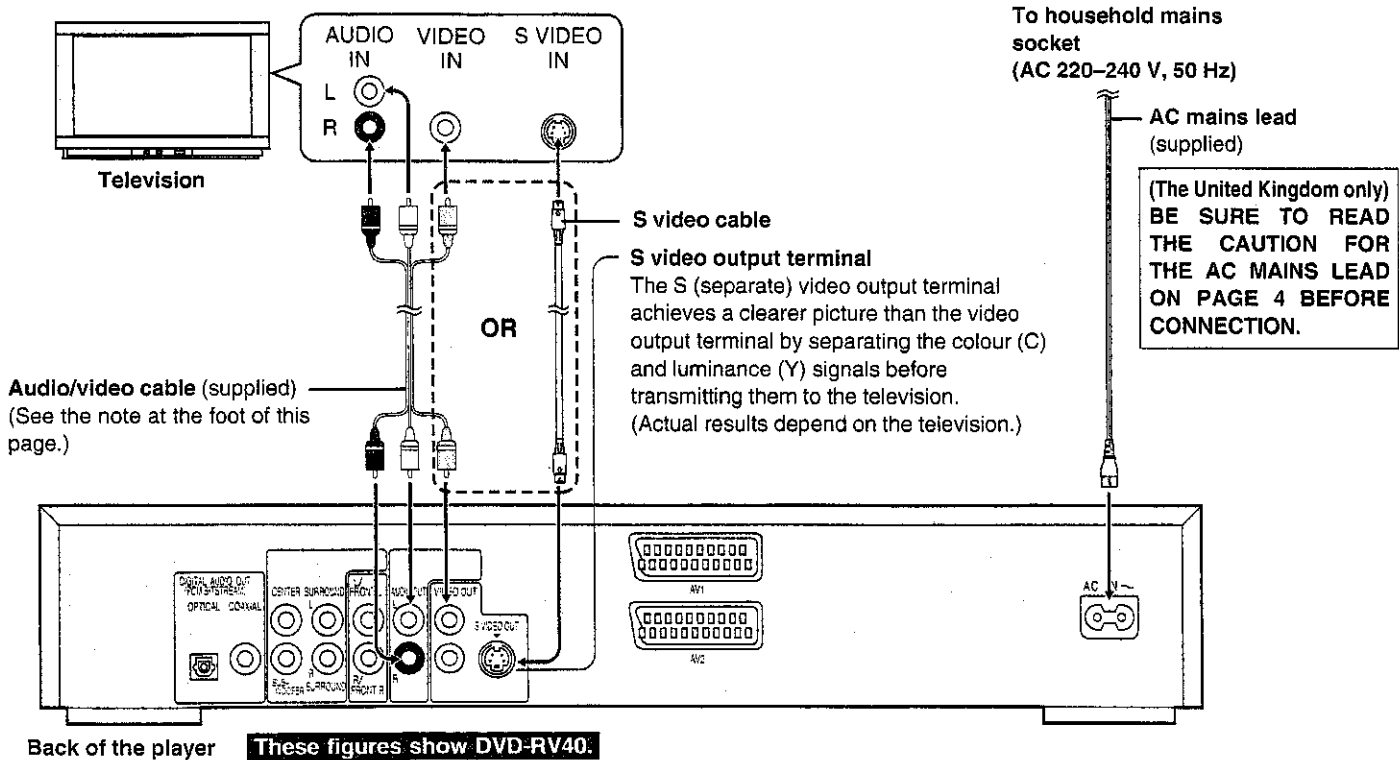

Note:

- DVD-RV20 has 1 VIDEO OUT terminal.
- If your television is monaural, use a stereo-monaural audio cable instead of the supplied audio/video cable. The video part of the cable (yellow) can still be used if required.

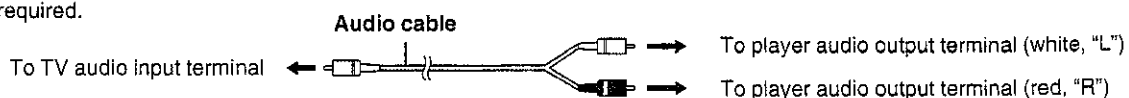

Connection to a television

Getting Started

Connecting to a television and a video cassette recorder with 21-pin SCART terminal For the United Kingdom and Continental Europe

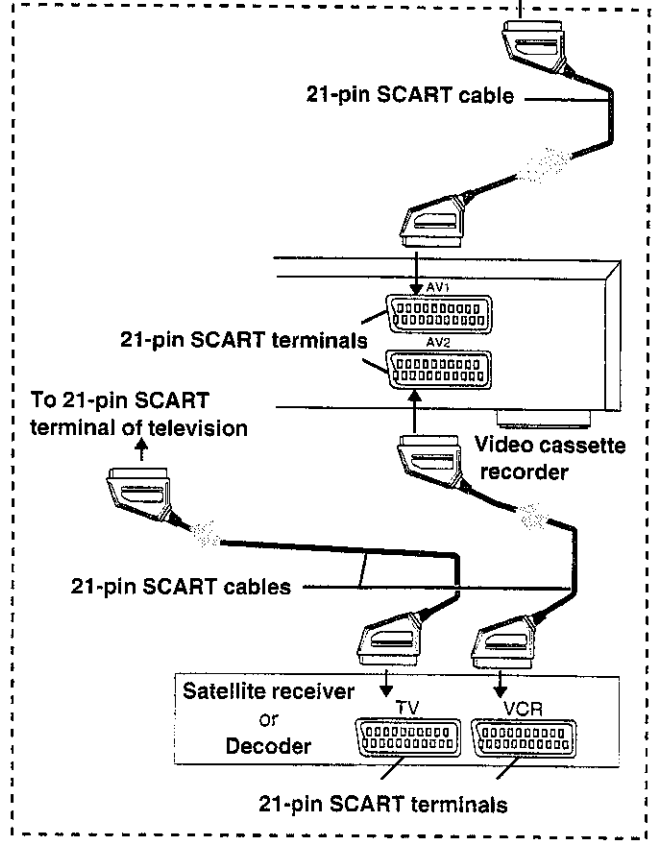
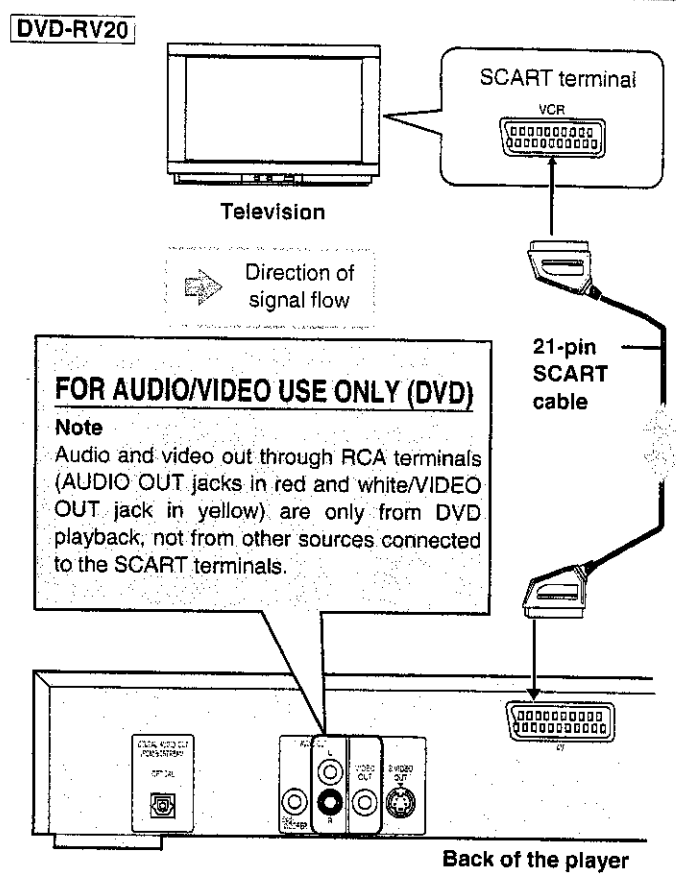
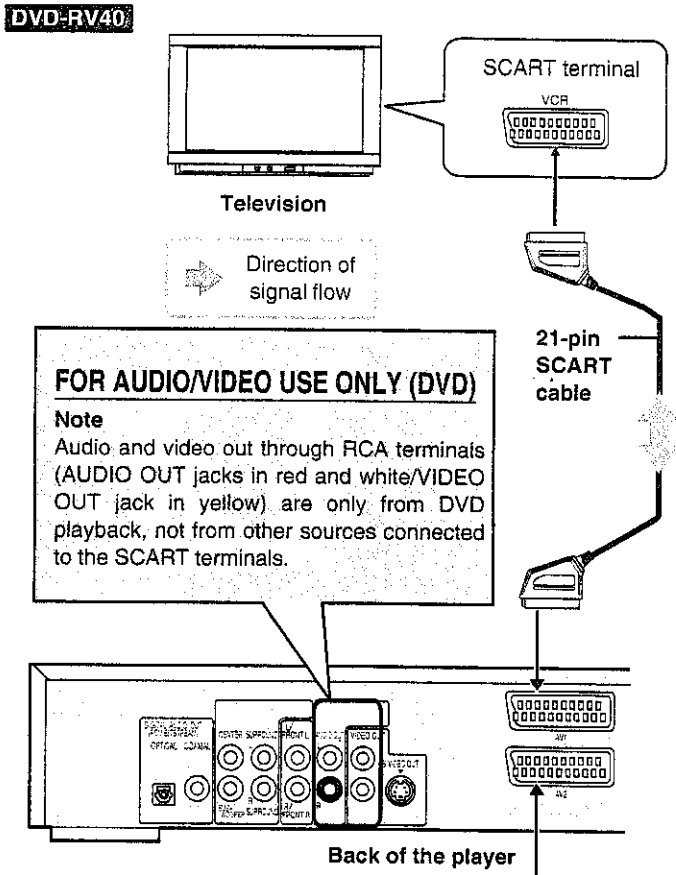

- Note**
- Additional equipment and cables are not supplied.
 - To view pictures from the video cassette recorder, set the player to the standby mode.

Connecting to a television with video input terminal or S video input terminal For Australia and N.Z.

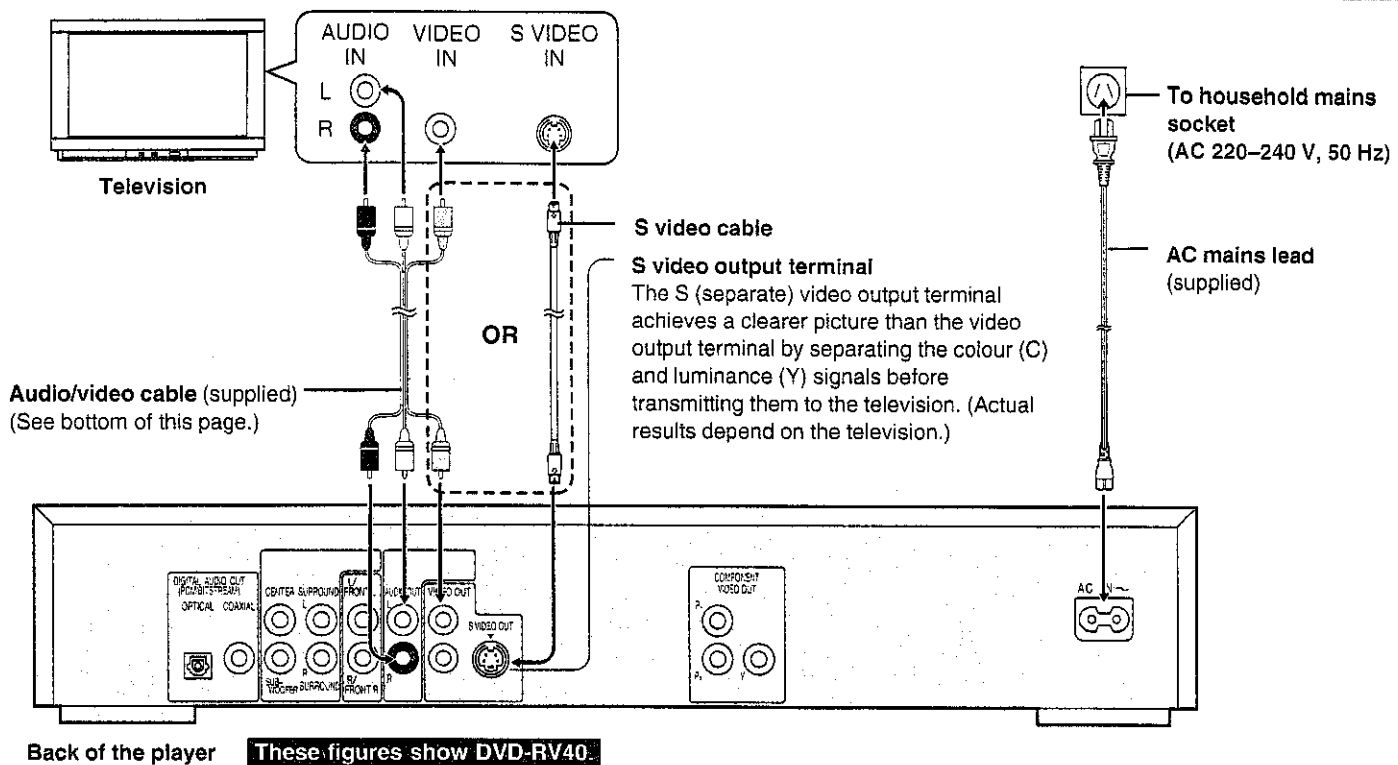

Note

- DVD-RV20 has 1 VIDEO OUT terminal.
- If your television is monaural, use a stereo-monaural audio cable instead of the supplied audio/video cable. The video part of the cable (yellow) can still be used if required.

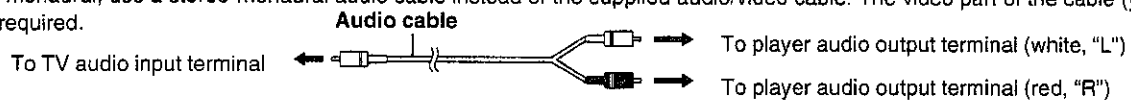

Connecting to a television with component video input terminals For Australia and N.Z.

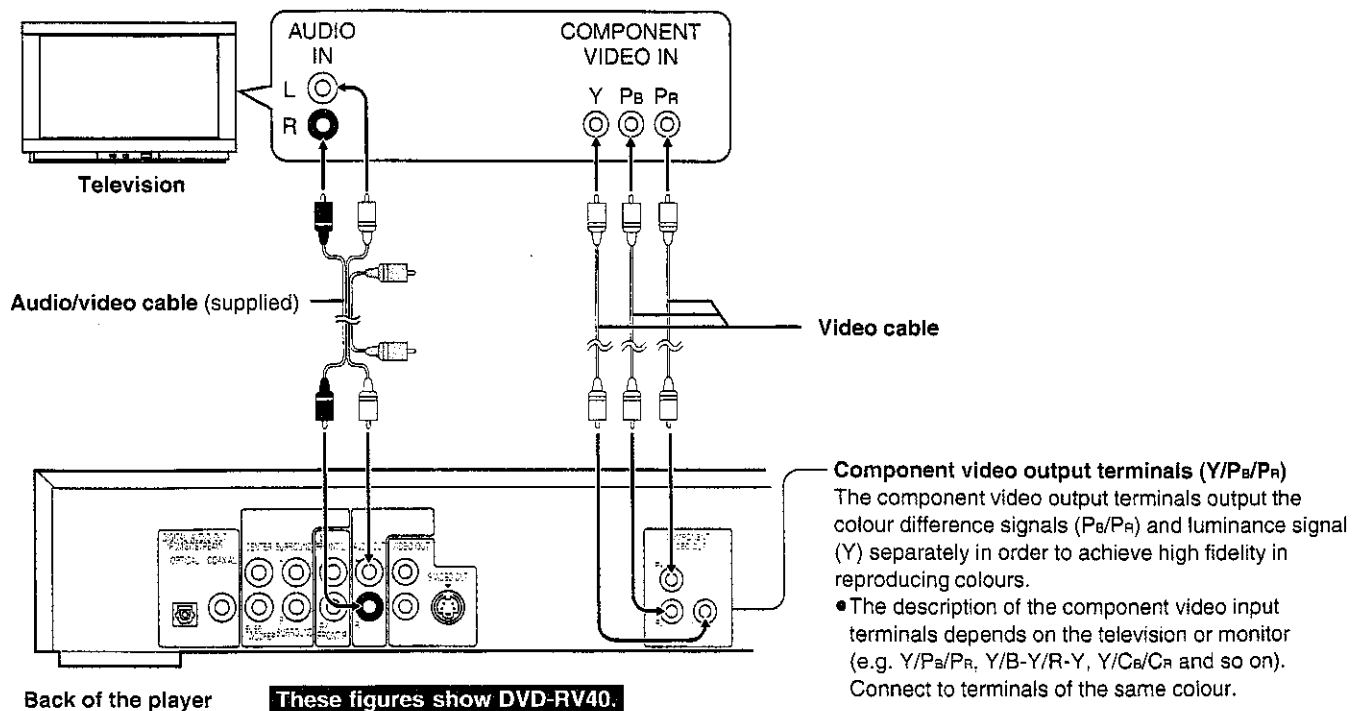

Note

- DVD-RV20 has 1 VIDEO OUT terminal.
- Additional equipment and cables are not supplied.

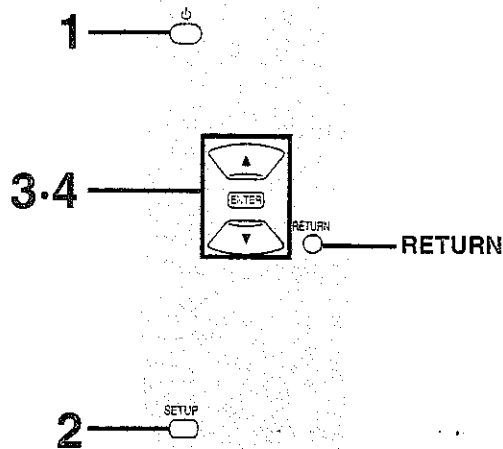

Connection to a television

■ Before enjoying DVD/Video CD/CD

The menu language for this player has been set to English, but you can change the language to French (example) (→ "3 Menu Language", page 29). English has been used in the examples shown.

Selecting TV screen type

Select the TV aspect, conventional size screen (4:3) or wide-screen (16:9), according to your television.

Preparations

- Ensure connections to your television and audio equipment are correct.
- Turn on your television and other equipment.

(For Australia and N.Z.)

- Switch the video input mode on the television to suit the type of connection you have made (e.g. VCR 2).

(For the United Kingdom and Continental Europe)

- Select the Audio/Video (AV) position, e.g. AV1, AV2, which has been connected to the player.

- 1 Press [Power] to switch on the power.**
- 2 Press [SETUP] in the stop mode.**
The initial settings screen is displayed.
- 3 Press the cursor buttons [▲, ▼] to select "6 TV Aspect" and press [ENTER].**
- 4 Press the cursor buttons [▲, ▼] to select the TV aspect and press [ENTER].**
 - 4:3 (Factory preset)**
Select when a conventional television is connected.
 - 16:9**
Select when a wide-screen television is connected.

Setting is finished and the initial settings screen in step 2 is displayed.

To cancel during setup operation

Press [RETURN]. (The previous screen is displayed.)

To exit the initial settings screen

Press [SETUP] or [RETURN].

For your reference

- For further details on the images which appear from the TV screen, see page 31.
- The optimum settings for your television may differ from those shown above.

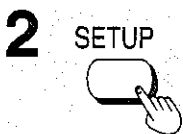
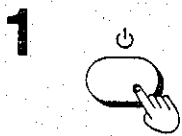

1	Disc Languages	
2	Rating	Level 8
3	Menu Language	English
4	On-Screen Messages	
5	FL Display	Bright
6	TV Aspect	4:3
7	Digital Audio Output	
8	Speaker Setting	2-channel
9	Other Settings	
Press RETURN to exit		

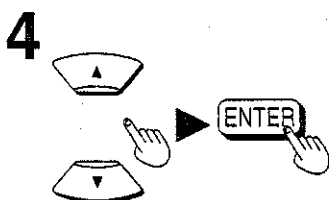
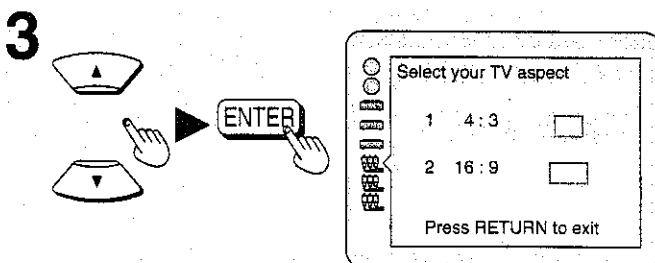

Basic play

Preparations

- Ensure connections to your television and audio equipment are correct.
- Turn on your television and other equipment.

(For Australia and N.Z.)

- Switch the video input mode on the television to suit the type of connection you have made (e.g. VCR 2).

(For the United Kingdom and Continental Europe)

- Select the Audio/Video (AV) position, e.g., AV1, AV2, which has been connected to the player.

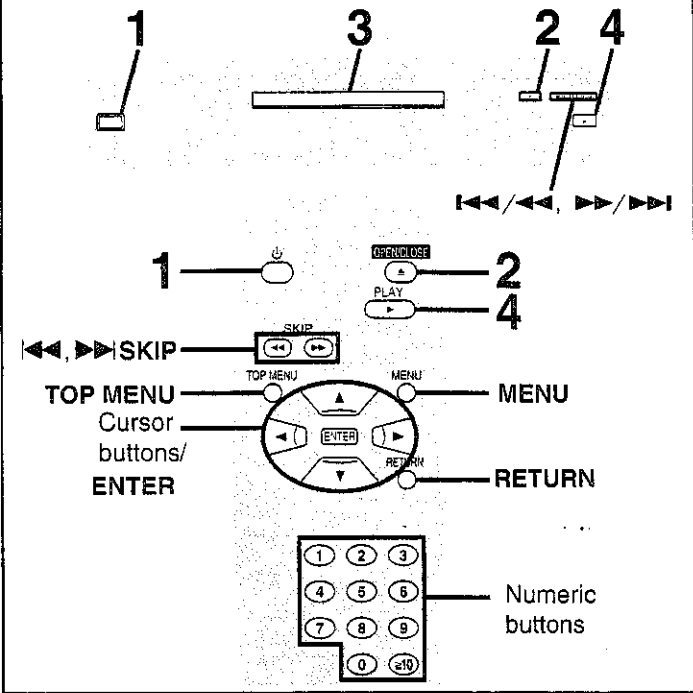

1 Press [⏻/⏻] to switch on the power.

2 Press [▲] to open the disc tray.

3 Place the disc on the disc tray.

- Insert inside the guides.
- Do not load more than one disc.

4 Press [▶].

The disc tray is automatically closed and play begins.

A When a menu screen appears on the TV monitor

Press the cursor buttons [▲, ▼, ◀, ▶] and press [ENTER], or press the numeric buttons, to select the item.

Play of the selected item now begins.

- The cursor buttons are not effective for selecting items for Video CDs.

Other buttons used to operate menus

Read the disc's instructions for further details about operation.

[▶▶/▶▶], [▶▶ SKIP]: Shows the next menu.

[◀◀/◀◀], [◀◀ SKIP]: Shows the previous menu.

[RETURN]: Shows the menu screen.

[TOP MENU]: Shows the first menu screen. [DVD]

[MENU]: Shows the menu screen. [DVD]

Note

- "NO PLAY" is displayed on the FL display if you load the following kinds of discs and they cannot be played:

- DVD for which playback is prohibited by the initial settings "2 Ratings" (⇒ page 28).
- DVD with a region number other than the region number of this player or "ALL" (⇒ page 6).
- If the disc is put in upside down (and it is a single sided disc).
- When "⊘" appears on the TV monitor when a button is pressed, the operation is prohibited by the player or disc.

- When [▶] is pressed immediately after a DVD disc is loaded into the tray, playback will take a little longer to start than when [▶] is pressed from the STOP mode.

It usually takes a little while before picture and sound appear on the television after [▶] is pressed, this is not a malfunction of the player.

- When NTSC DVD/Video CD is played, the picture may roll up or down on some televisions; adjust this using the vertical hold control on the television. Televisions not equipped with a vertical hold control cannot correct this condition. The playback picture may shrink vertically and black bars may appear both on the top and bottom of the screen, or the picture may be in black and white. This does not indicate a malfunction.

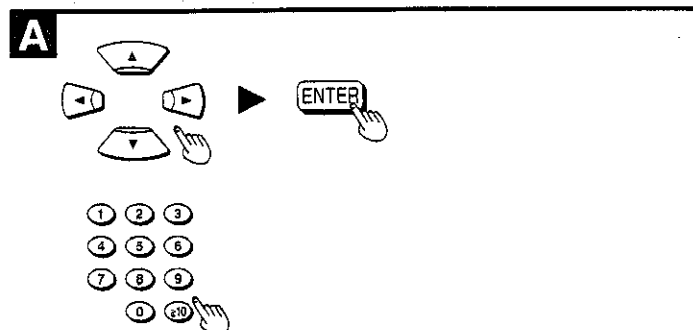
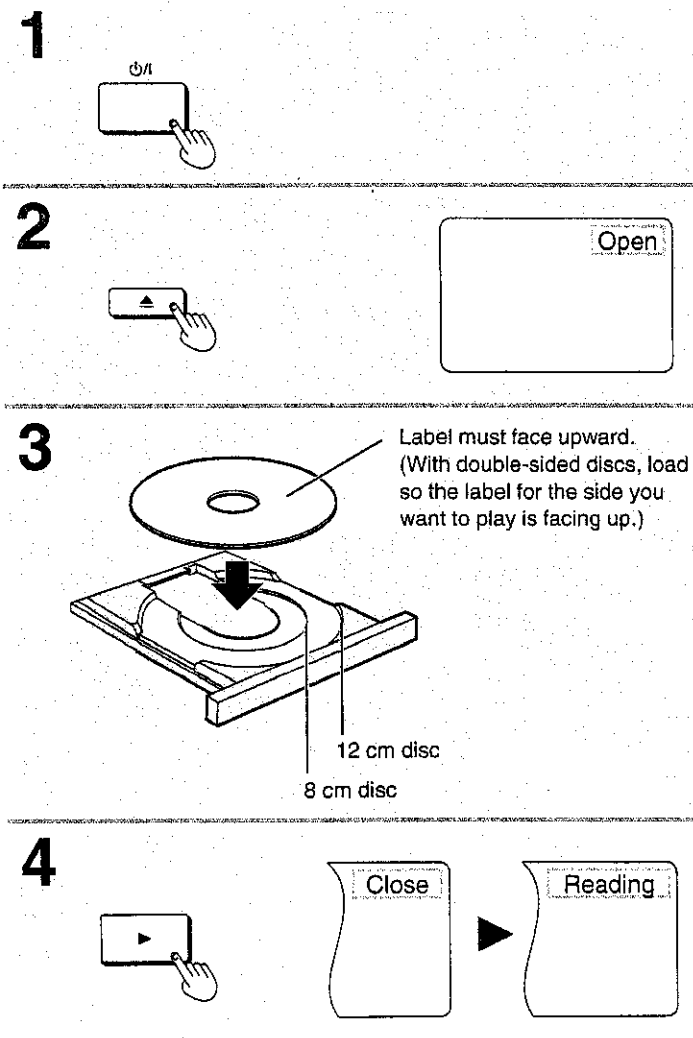

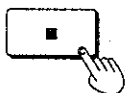
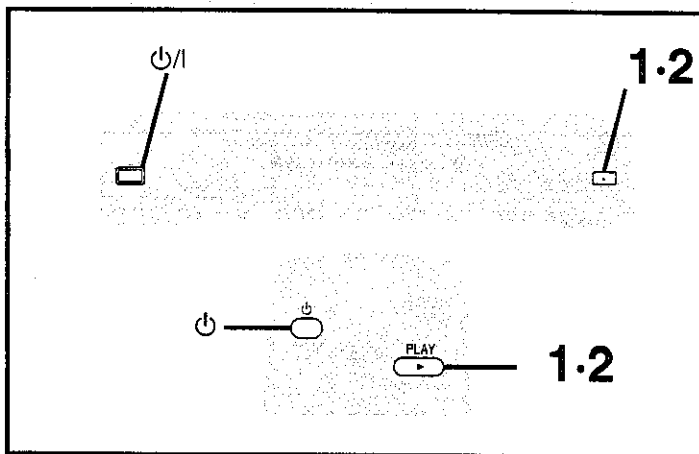
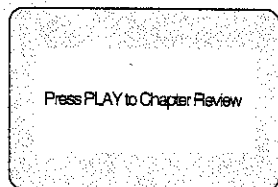
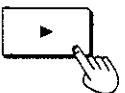
**A****B****C****1****2**

Basic play

A Stopping play

Press [■] during play.

- The player records the point where [■] was pressed during play. ("▷" flashes on the player's FL display.)

B To resume play from where you stopped it (RESUME function)

Press [▶] while "▷" is flashing on the FL display.
Play will resume from the point where [■] was pressed.

To clear the RESUME function

Press [■] again or open the disc tray while "▷" is flashing on the FL display.

Note

- The RESUME function works only with titles for which the elapsed playing time appears on the player's FL display during playback.
- This feature remains active if the player is switched to the standby mode and then turned back ON.

C Chapter review function

DVD

This function plays the first few seconds of each chapter from the beginning of the title up to the point where operation was stopped. This makes it possible to review previous chapters.

1. Press [▶] while "▷" is flashing on the FL display.
(The message illustrated is briefly displayed.)
2. Press [▶] again while the message is displayed on the screen.

Normal playback will commence from the point where operation was stopped.

Note

- Canceling the RESUME function will also clear the chapter review function.
- The chapter review function may not work with some DVDs.

■ After operation

When the player is not in use, remove the disc and press [⏻/⏹] to switch the player to the standby mode.

The player is automatically switched to the standby mode after 30 minutes or so have elapsed in the stop mode.

(Auto power-off function)

Note

- The disc continues to rotate while the menu is displayed even after the player has finished playing a particular item. Stop the player when you finish viewing to preserve the player's motor and prevent screen burn.

Other methods of play

Features on the next few pages are accessed mainly by using the remote control.

A Still picture (Pause)

Press [|| PAUSE] during play.

To return to normal play
Press [▶ PLAY].

B Skipping chapters or tracks

Press [◀◀, ▶▶ SKIP] during play or while paused.

On the player

Press [◀◀/◀◀, ▶▶/▶▶] during play or while paused.

For your reference

- When [◀◀, ▶▶ SKIP] or [◀◀/◀◀, ▶▶/▶▶] on the player is pressed during menu play of Video CDs with playback control, a menu screen may sometimes be recalled.

C Frame advance (Frame reverse)

DVD

Press the cursor buttons [◀, ▶] while paused.

- The disc is advanced (reversed) by one frame each time the cursor buttons [◀, ▶] are pressed.
- When the cursor buttons [◀, ▶] are kept pressed, consecutive frame advance (reverse) works.

To return to normal play

Press [▶ PLAY].

For your reference

- Pressing [|| PAUSE] also activates frame advance.
- Whether the pictures are advanced by a "Frame" or "Field" is automatic, but you can change the initial settings to choose how the picture is advanced (→ "1 Still Mode" in "9 Other Settings", page 30).

D Slow-motion play

DVD

Press [◀◀, ▶▶ SLOW/SEARCH] while paused.

- Each press increases the speed of slow-motion.

On the player

Press and hold [◀◀/◀◀, ▶▶/▶▶] while paused.

- The slow-motion speed increases if the button is held down.

- There are five speeds of slow-motion.

To return to normal play

Press [▶ PLAY].

For your reference

- When [◀◀, ▶▶ SLOW/SEARCH] or [◀◀/◀◀, ▶▶/▶▶] on the player is pressed during menu play of Video CDs with playback control, a menu screen may sometimes be recalled.

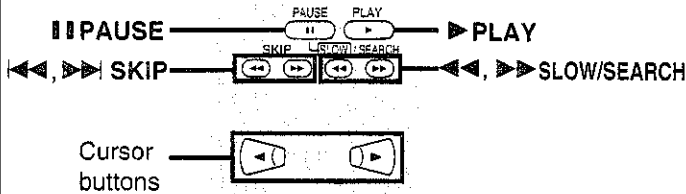
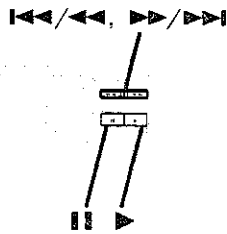

A

PAUSE



B

SKIP

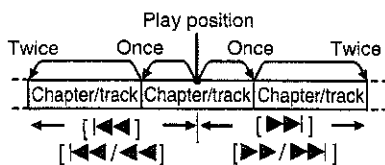
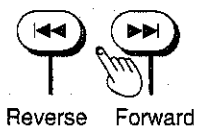

C

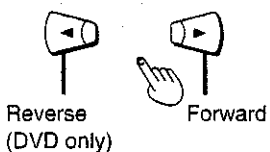

D

SLOW / SEARCH

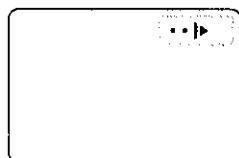
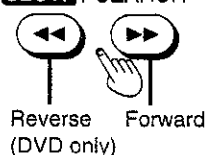

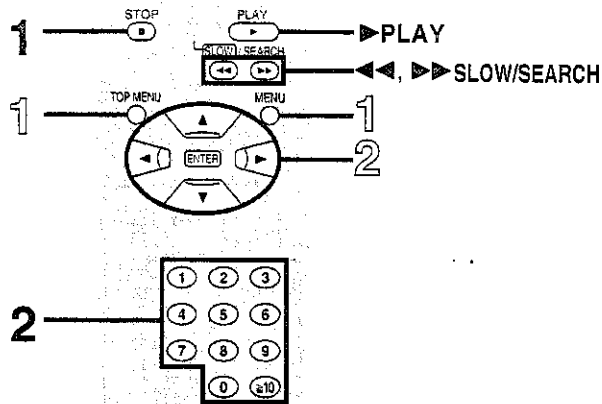
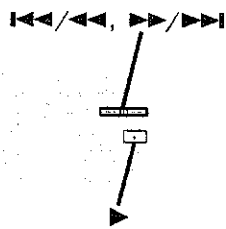

A

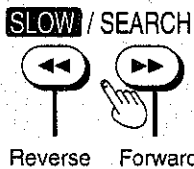

B

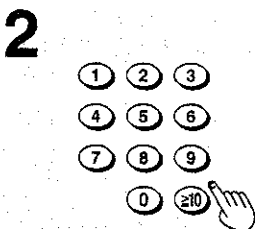
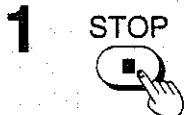

C

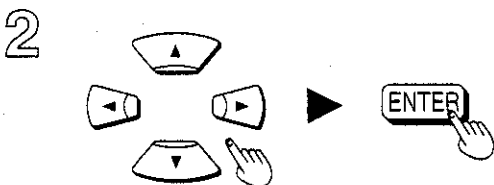

D

Example: If you press the buttons while you are playing title 2

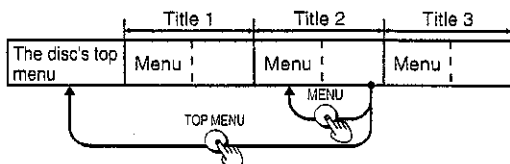

Other methods of play

A Rapid advance (Rapid reverse)

Press [**◀◀, ▶▶ SLOW/SEARCH**] during play.

- Each press increases the speed of the search.

On the player

Press and hold [**◀◀/◀◀, ▶▶/▶▶**] during play.

- The speed of search increases if the button is held down.

- There are five speeds of advance (reverse).

To return to normal play

Press [**▶ PLAY**].

For your reference

- When [**◀◀, ▶▶ SLOW/SEARCH**] or [**◀◀/◀◀, ▶▶/▶▶**] on the player is pressed during menu play of Video CDs with playback control, a menu screen may sometimes be recalled.
- For DVDs and Video CDs, audio will be heard during searching (forward direction only) at the initial search speed. (To turn audio off, → "2 Audio during Search" in "9 Other Settings", page 30.)

B Canceling playback control

1 Press [**■ STOP**] after the menu screen appears (after step 4 on page 13).
"PBC" will be cleared from the player's FL display.

2 Press the numeric buttons to select a track. (→ item ⑨ on page 8 for number entry.)
Play begins.

- Refer to the jacket etc. of the disc concerned for the track numbers.
- Press [1] to start play from the beginning of the disc.

To return to menu play

Press [**■ STOP**] to stop play, press [MENU], and press the numeric buttons to select an item.
"PBC" lights on the player's FL display.

C Using menus to play

DVD

By calling up menus during play, you can start play from a specific title or chapter, or change the soundtrack and subtitle languages.

1 Press [**TOP MENU**] or [**MENU**] during play to display the menu.

- Press again to return to what you were watching.

2 Press the cursor buttons [**▲, ▼, ◀, ▶**] to select an item and press [**ENTER**].

The selected item is confirmed.

- Repeat if other menus are shown.

DVDs can have several menus. The menu displayed when you press [TOP MENU] may be different to the menu displayed when you press [MENU]. **D**

For your reference

- Menu content depends on the disc. These operating instructions describe the basic steps.
- Both buttons take you to the same menu if the disc has only one menu.

Advanced operations

A

Cursor buttons/
ENTER



AUDIO

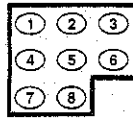

Numeric buttons

AUDIO



Soundtrack language number being played back ("—" indicates a soundtrack is not recorded.)

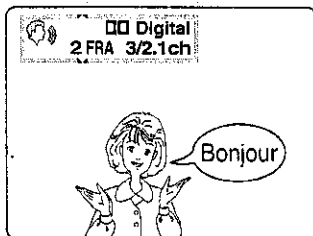
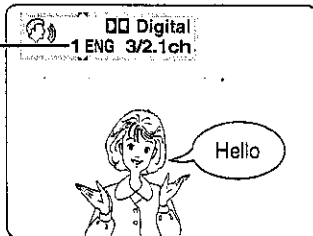

B

1

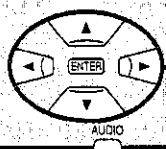

2 • ENTER

1

AUDIO



2

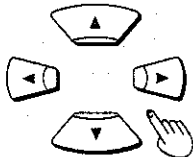

DVD

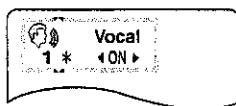

Video CD



AUDIO



A Changing soundtrack language

DVD

Some DVDs have more than one soundtrack language recorded on them, and you can change soundtrack language during play.

Press [AUDIO] during play to display the current language number.

The number changes each time you press the button.

- You can also use the cursor buttons [▲, ▼] or the numeric buttons to change the language number.

To clear the display

Press [ENTER].

For your reference

- You can only select languages or sound formats if they have been recorded on the disc you are playing.
- If RESUME function (⇒ page 14) is canceled or if you stop play of an interactive DVD, the soundtrack languages revert to the initial settings (⇒ page 27).
- Some discs allow changes to soundtrack languages only by using the disc's menus.

B Switching vocals ON or OFF for Karaoke discs

DVD

1. Press [AUDIO] during play.
2. Press the cursor buttons [▲, ▼, ◀, ▶] or press [AUDIO] to change the setting.

DVD Karaoke [◀, ▶]

• Solo

---: Vocal OFF

ON: Vocal ON

• Duet

---: Vocal OFF

1+2: Vocal 1, 2 ON

V1: Vocal 1 only ON

V2: Vocal 2 only ON

- Choose "----" for Karaoke.
- Choose "V1" or "V2" to duet with the player.

Video CD ([▲, ▼] or [AUDIO])

LR: Vocals (Vocals seem to come from the right)

L: No Vocals

R: Vocals (Vocals seem to come from both left and right)

- Choose "L" for Karaoke.

To clear the display

Press [ENTER].

For your reference

- Karaoke discs may show a menu after each track. Some will have a menu that allows you to play all the tracks.
- Some discs require different operations to those described. Read the disc's instructions for detail.

Advanced operations

A Changing subtitle language

DVD

Some DVDs have more than one subtitle language recorded on them, and you can change subtitle language during play.

Press [SUBTITLE] during play to display the current language number.

The number changes each time you press the button.

- You can also use the cursor buttons [▲, ▼] or the numeric buttons to change the language number.

To clear the display

Press [ENTER].

B To clear/display the subtitles

1. Press [SUBTITLE].
2. Press the cursor buttons [◀, ▶] to select "ON" or "OFF".

Note

- In some cases, the subtitle language is not changed to the selected one immediately.

For your reference

- You can only select languages if they have been recorded on the disc you are playing.
- If RESUME function (⇒ page 14) is canceled or if you stop play of an interactive DVD, the subtitle languages revert to the initial settings (⇒ page 27).
- Some discs allow changes to subtitle languages only by using the disc's menus.

C Viewing from another angle

DVD

Some DVDs allow you to view the same scene from different angles. "ANGLE" lights on the FL display to indicate that the feature is available.

Press [ANGLE] during play to display the current angle number.

The number changes each time you press the button.

- You can also use the cursor buttons [▲, ▼] or the numeric buttons to change the angle.

To clear the display

Press [ENTER].

For your reference

- You can only select angles if they have been recorded on the disc you are playing.
- Some discs allow you to set angles before multi-angle scenes are played.
- Some discs allow changes to angles only by using the disc's menus.

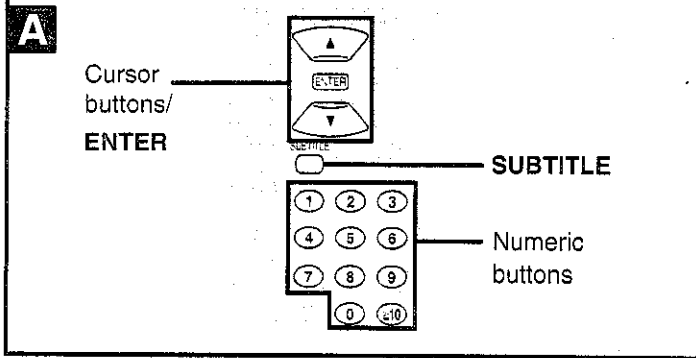

SUBTITLE
Subtitle language number being played back ("—" indicates subtitles are not recorded)

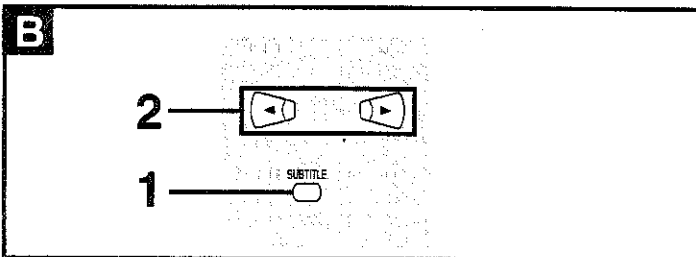
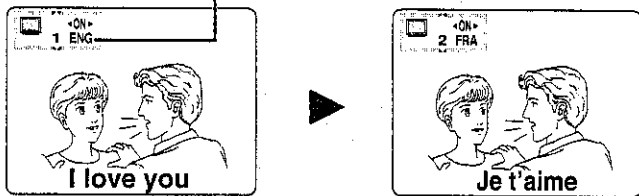

1
SUBTITLE

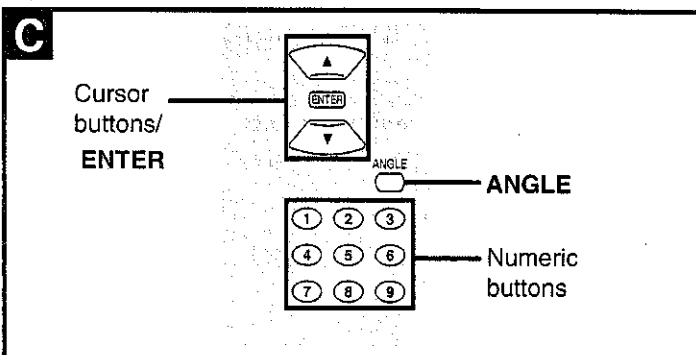
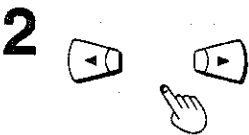

ANGLE
Angle number being played back

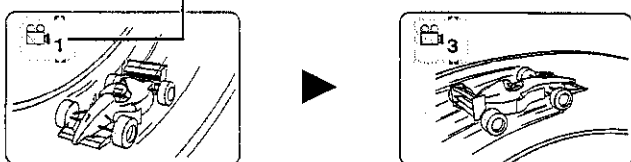

CINEMA

A



Advanced operations

A Changing picture quality for movie viewing DVD-RV40

DVD

Press [CINEMA] on the player while a disc is loaded.

Mellows movies and enhances detail in dark scenes.

To restore the standard picture mode

Press [CINEMA].

For your reference

You can also change with the GUI screens. (→ "Cinema mode", page 25)

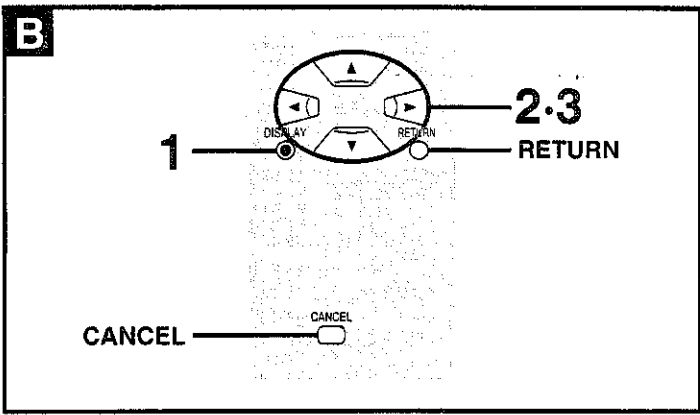

B Raising dialogue volume

DVD

This mode makes the dialogue in movies easier to hear.

(→ "Dialogue Enhancer", page 25)

This function is effective with Dolby Digital, three channels or over, where the dialogue is recorded in the center channel.

1 Press [DISPLAY] twice during play.

The GUI screen for player information (→ page 25) is displayed.

2 Press the cursor buttons [◀, ▶] to select the icon.

3 Press the cursor buttons [▲, ▼] to select the mode.

OFF: Normal volume

ON: Louder volume for dialogue

To clear the GUI screens

Press [RETURN] or [CANCEL].

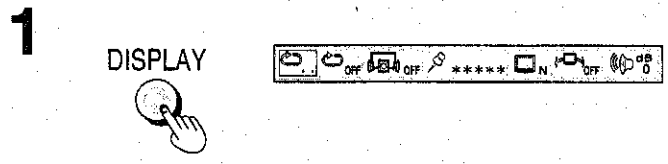

Advanced Operations

Advanced operations

A Reproducing an Advanced Virtual Surround Sound (V.S.S.) effect

DVD (Dolby Digital, 2-channel or over only)

Use this feature to enjoy a surround-like effect if you are using two front speakers.

Press [V.S.S.] during play.

Each time this button is pressed, the player's FL display changes:

- Ⓐ V.S.S. 1 (Natural effect)
- Ⓑ V.S.S. 2 (Emphasized effect)
- Ⓒ V.S.S. is canceled

- The V.S.S. indicator lights up green when the V.S.S. function is activated.

Note:

- V.S.S. effect does not work with Karaoke DVDs.
- V.S.S. will not work or will have less effect with some discs.
- Turn off the TV surround sound and other surround sound effects when using this effect.
- Sound will only come from the two front speakers if V.S.S. is on.

For your reference

- For optimum effect, it is recommended that the distance between the television and the listening position be about 3 to 4 times the distance between the right and left front speakers. **B**
- You can also change the V.S.S. level with the GUI screen (⇒ "① Virtual Surround Sound (V.S.S.)", page 25).

• V.S.S. effects

	V.S.S. 1	V.S.S. 2
Stereo discs	The front speakers sound farther apart.	The surround-like effect in V.S.S. 1 is increased.
Surround signal recorded discs	Surround sound seems to come from the side.	

V.S.S. indicator

V.S.S.

V.S.S.

A

V.S.S.

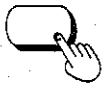

Ⓐ



VSS 1



Ⓑ



VSS 2



Ⓒ



VSS OFF

B

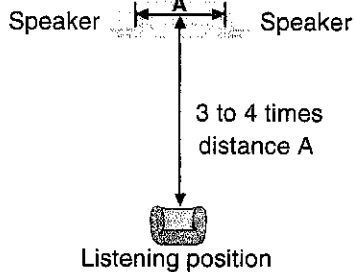

Advanced operations

A Repeat play

Press [REPEAT MODE] during play.

Each time this button is pressed, the TV monitor changes as illustrated and the disc will repeat a chapter or title (DVD) or a track (Video CD/CD).

Repeat play starts when the display changes.

•DVD

- Ⓐ Normal play
- Ⓑ Repeat of chapter being played
- Ⓒ Repeat of title being played
- Ⓓ Cancel repeat mode (Normal play)

•Video CD/CD

- Ⓐ Normal play
- Ⓣ Repeat of track being played
- Ⓐ Repeat of entire disc contents
- Ⓜ Cancel repeat mode (Normal play)

To return to normal play

Press [REPEAT MODE] until "OFF" is displayed.

Note

- Repeat play may not work correctly with some DVDs.
- Repeat play does not work with an interactive DVD or during menu play of a Video CD with playback control.
- There is no mode for repeating the whole DVD.

B To enjoy program repeat play

CD

If [REPEAT MODE] is pressed during program play (→ page 22), the display changes as illustrated.

- Ⓣ Program play
- Ⓣ Repeat of track being played
- Ⓚ Repeat of all programmed tracks
- Ⓜ Cancel repeat mode (Program play)

To return to program play

Press [REPEAT MODE] until "OFF" is displayed.

C Repeating sections between two specific points (A-B repeat)

1 Press [A-B REPEAT] during play at the point where repeat play is to start (A).

2 Press [A-B REPEAT] at the point where repeat play is to be concluded (B).

Repeat play of the section between points A and B starts.

To return to normal play

Press [A-B REPEAT] until "••" is displayed.

Note

- A-B repeat play does not work with an interactive DVD.
- Some subtitles recorded around point A or B may fail to appear (DVD).
- A-B repeat play works only within a title (DVD) or a track (Video CD/CD).

For your reference

- The end of a track or title is automatically determined as point B.

REPEAT MODE

A

REPEAT MODE

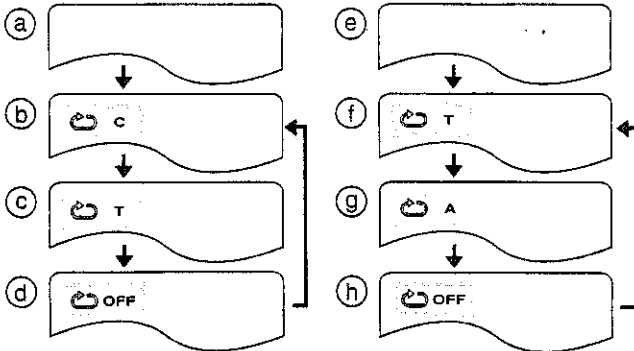

B

REPEAT MODE

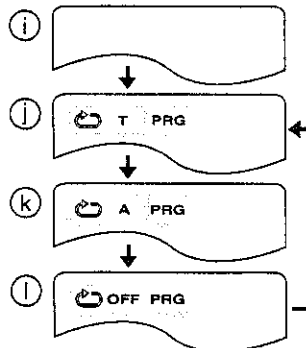

C

1.2 A-B REPEAT

1

A-B REPEAT

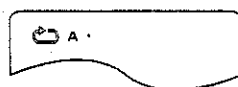

2

A-B REPEAT

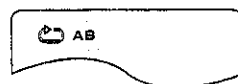

Advanced operations

A Program play

CD

The player plays the tracks on the disc in an order you specify. Up to 32 tracks can be programmed.

1 Press [PLAY MODE] while stopped until the illustrated screen appears.

- If "O" appears on the television, press [STOP] to cancel RESUME function, then press [PLAY MODE].

2 Press the numeric buttons to select the track. (→ item ⑨ on page 8 for number entry.)

The selected track is stored in the memory.

- If you press [ENTER], you can use the cursor buttons [▲, ▼] to select a track. Press [ENTER] to register the track number.

- Repeat step 2 to select another track.

- If you enter over 32 tracks, the last programmed track is replaced with the new one.

3 Press [▶ PLAY].

Play now begins in the programmed sequence.

To exit the screen

Press [PLAY MODE] twice.

To add tracks

1. Press [STOP] twice during program play to show the program play screen.
2. Select the available item with the cursor buttons [▲, ▼], then repeat step 2.

- Press [◀, ▶ SLOW/SEARCH] to turn the page of program to make selections quicker.

To return to normal play

1. Press [STOP] twice during program play. (Program play is suspended.)
2. Press [PLAY MODE] twice.
3. Press [▶ PLAY].

- The program is retained in the memory.

Operation by observing the unit's FL display

- Use the numeric buttons to enter track numbers.

- To check the program, press the cursor buttons [▲, ▼].

Clearing the program

When the program play screen is displayed

• To clear the programmed tracks one by one

- Select the track, move to "Clear" with the cursor buttons [▲, ▼, ◀, ▶] and press [ENTER]. (Selecting the track and pressing [CANCEL] also clears the programmed track.)

• To clear the whole program

- Move to "Clear all" with the cursor buttons [▲, ▼, ◀, ▶] and press [ENTER]. (The program is also cleared when the player is switched to the standby mode or turned off, or the disc tray is opened.)

B Random play

CD

The player plays the tracks on the disc in random order.

1 Press [PLAY MODE] while stopped until the illustrated screen appears.

- If "O" appears on the television, press [STOP] to cancel RESUME function, then press [PLAY MODE].

2 Press [▶ PLAY].

Play now begins in random order.

To exit the screen

Press [PLAY MODE] once.

To return to normal play

1. Press [STOP] twice during random play. (Random play is suspended.)
2. Press [PLAY MODE] once.
3. Press [▶ PLAY].

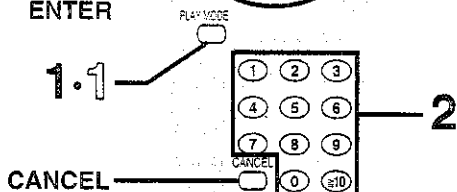
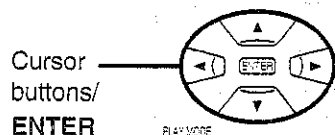

A
1 PLAY MODE

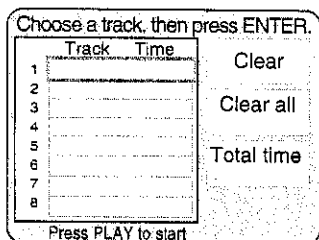

FL display (e.g. CD)

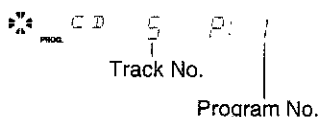
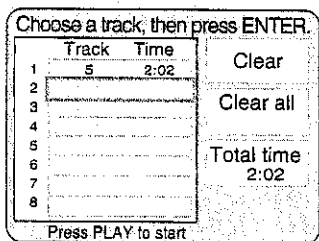
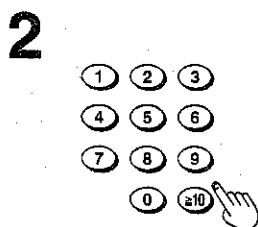

B
1 PLAY MODE

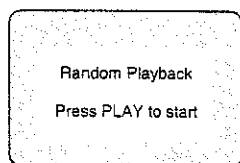

Using GUI screens

GUI screens

GUI screens are long thin menus that contain information about the disc or player. These menus allow you to perform operations by changing this information.

Examples of GUI screens **A**

The screens depend on the disc contents. (Display examples are from DVD-RV40.)

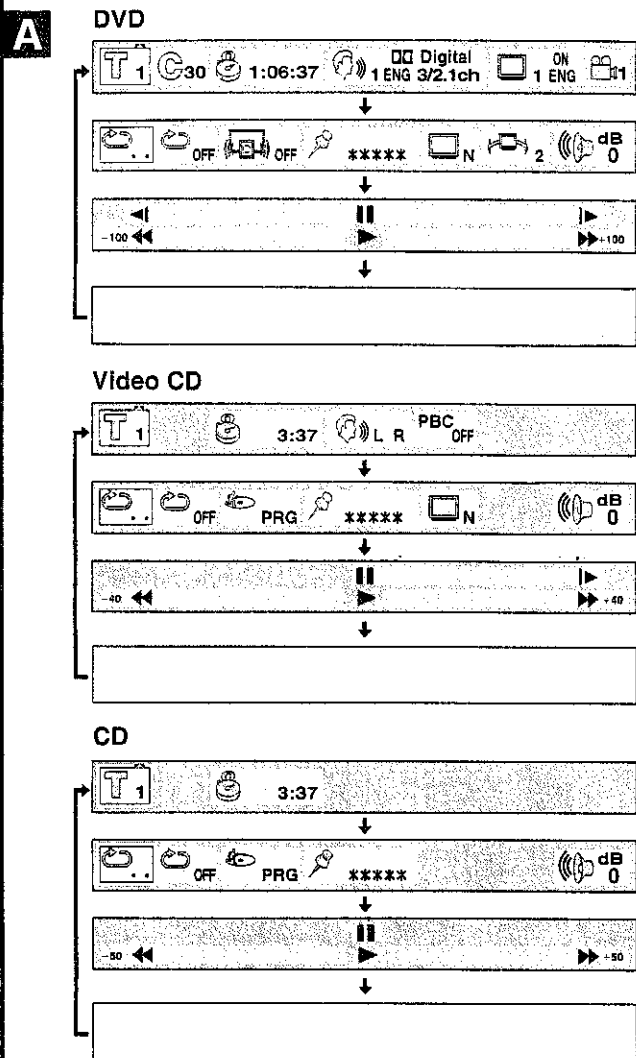

B Common procedures

1 Press [DISPLAY] during play or in the stop mode.

Each time this button is pressed, the TV monitor changes as shown below.

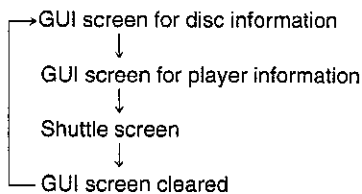

•Some functions cannot be accessed from the stop mode.

2 Press the cursor buttons [◀, ▶] to select the item.

The item is highlighted in yellow.

3 Press the cursor buttons [▲, ▼] to select the setting.

- For some functions, the setting will be registered immediately; for others, [ENTER] or [▶ PLAY] must be pressed.
- When numbers are displayed (e.g. title No.), the numeric buttons are also effective for setting instead of the cursor buttons [▲, ▼]. When numbers are entered with numeric buttons, press [ENTER] to register the setting.

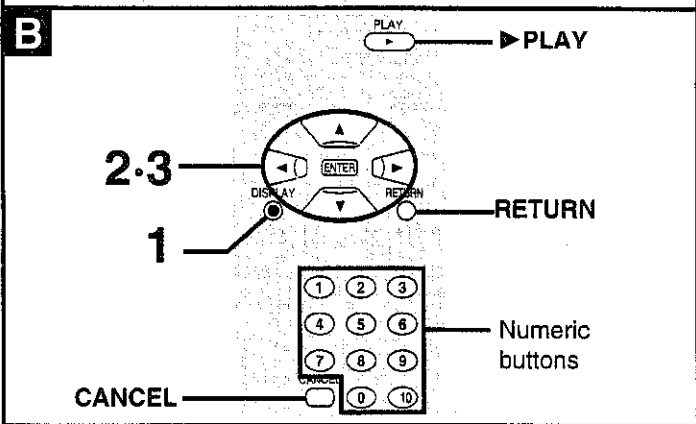

1 DISPLAY

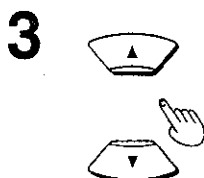
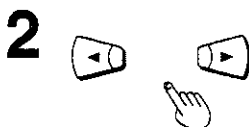

To clear the GUI screens

Press [RETURN] or [CANCEL].

For your reference

- The GUI screens may not be displayed when playing some kinds of DVD software, or if the television's automatic picture zoom function is on. Change the position of the GUI screens in "4 On-Screen Messages" if this occurs (⇒ page 29).
- The colour (blue, violet or green) of the GUI screens can be changed (⇒ page 29).
- "▲, ▼" around the icon means that the item can be changed using the cursor buttons [▲, ▼].

Detailed descriptions of each icon

Screen for disc information

DVD

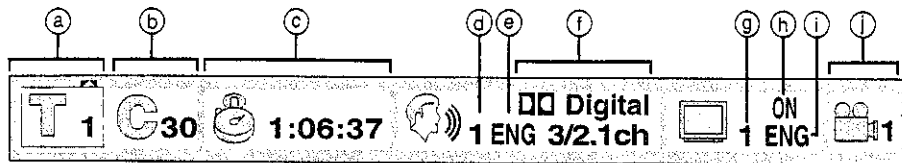

- a Title No.**
Change the No. with the cursor buttons [▲, ▼] or the numeric buttons and press [ENTER].
- b Chapter No.**
Change the No. with the cursor buttons [▲, ▼] or the numeric buttons and press [ENTER].
- c Time**
(hour:minute:second)
Enter the time from which you want to start play and press [ENTER].
Example: To specify "1 hour 6 min. 37 sec.", enter "10637".
- d Soundtrack language No.**
Change the No. with the cursor buttons [▲, ▼] or the numeric buttons.
- e Soundtrack language**

ENG: English	SVE: Swedish	CHI: Chinese
FRA: French	NOR: Norwegian	KOR: Korean
DEU: German	DAN: Danish	MAL: Malay
ITA: Italian	POR: Portuguese	VIE: Vietnamese
ESP: Spanish	RUS: Russian	THA: Thai
NLD: Dutch	JPN: Japanese	*: Others

- f Audio attribute**
Shows the audio attributes of the selected soundtrack (cannot be changed).
LPCM/Digital/DTS/MPEG: Signal type
k: Sampling frequency (kHz)
b: Number of bits (bit)
ch: Number of channels**
Vocal: Vocals indication
•You can switch vocals ON or OFF with the cursor buttons [▲, ▼].
[DVD Karaoke (Solo)]: --- (OFF) or ON
[DVD Karaoke (Duet)]: --- (OFF), V1+V2, V1 or V2
- g Subtitle language No.**
Change the No. with the cursor buttons [▲, ▼] or the numeric buttons.
- h Subtitle on/off**
Select "ON" or "OFF" with the cursor buttons [▲, ▼].
OFF: Subtitle is cleared.
ON: Subtitle is displayed.
- i Subtitle language**
See the table under the item e.
- j Angle No.**
Change the No. with the cursor buttons [▲, ▼] or the numeric buttons.

Video CD/CD

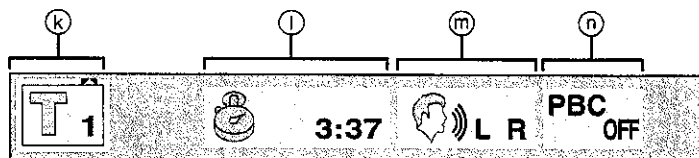

- k Track No.**
Change the No. with the cursor buttons [▲, ▼] or the numeric buttons and press [ENTER].
- l Time**
(minute:second)
Display is changed each time the cursor buttons [▲, ▼] are pressed. The times cannot be changed.
Elapsed playing time ←————→ Remaining time of the track
←————→ Remaining time of the disc ←————→

- m Audio mode**
Change the mode with the cursor buttons [▲, ▼].
LR: Left channel sound is output from the left speaker (L), and right channel sound is output from the right speaker (R).
L: Left channel sound only is output from the speakers (L/R).
R: Right channel sound only is output from the speakers (L/R).
- n Playback control**
Shows whether menu play is on or off (cannot be changed here).
OFF: Menu play is OFF.
ON: Menu play is ON.

Note

- The information actually displayed depends on the disc.
- During program and random play of Video CDs and CDs, the remaining time of the disc is not displayed.

※ Example:

3/2 .1ch

.1:	Subwoofer signal (not displayed if there is no subwoofer signal)
0:	No surround
1:	Mono surround
2:	Stereo surround (left/right)
1:	Center
2:	Front left+Front right
3:	Front left+Front right+Center

Screen for player information

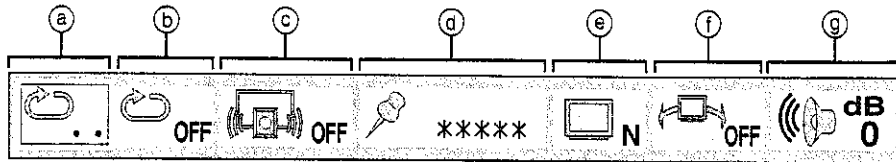

a A-B repeat play

Press [ENTER] during play to store location A and press [ENTER] again to store location B. Repeat play between the two locations starts. Press [ENTER] again to return to normal play.

b Repeat play

Select the mode during play with the cursor buttons [▲, ▼].

DVD

OFF: Normal play

C: Chapter repeat play

T: Title repeat play

CD

OFF: Normal play

T: Track repeat play

A: Disc repeat play

c Dialogue Enhancer

DVD

Select the mode during play with the cursor buttons [▲, ▼].

OFF: Normal volume

ON: Louder volume for dialogue

Play mode

CD (⇒ page 22.)

The current play mode is shown (cannot be changed here).

PRG: Program play

RND: Random play

---: Normal play

d Marker (Marking parts you want to watch or listen to again)

Press [ENTER] during play and press [ENTER] again at the preferred point to store a marker. (Marker No. replaces "*"). Up to 5 markers can be stored in memory.

To store the next marker, press the cursor button [▶].

•To recall a marker

Select the marker no. with the cursor buttons [◀, ▶] and press [ENTER].

•To clear a marker

Select the marker no. with the cursor buttons [◀, ▶] and press [CANCEL].

•Some subtitles recorded around the marker may fail to appear.

•All the markers are cleared when the player is switched to the standby mode or turned off, or the disc tray is opened.

e Cinema mode **DVD-RV40**

DVD

Select the mode with the cursor buttons [▲, ▼] while a disc is loaded.

N: Normal mode

C: Cinema mode (Cinema position): Picture for viewing movies.

f Virtual Surround Sound (V.S.S.)

DVD (Dolby Digital, 2-channel or over only) (⇒ page 20)

Select the level during play with the cursor buttons [▲, ▼].

OFF: V.S.S. off

1: V.S.S. natural effect

2: V.S.S. emphasized effect

g Master volume **DVD-RV40**

Adjust the master volume with the cursor buttons [▲, ▼].

−∞ or −127 to 0 (dB)

Turning subwoofer output on and off **DVD-RV20** (⇒ page 34)

Select "ON" or "OFF" with the cursor buttons [▲, ▼].

ON: if you have connected a subwoofer

OFF: if you have not connected a subwoofer

Note

- A-B repeat play does not work with an interactive DVD.
- Repeat play and marker functions do not work with an interactive DVD or during menu play of a Video CD with playback control.
- Dialogue Enhancer is effective with Dolby Digital, three channels or over, where the dialogue is recorded in the center channel.

Shuttle screen

Maximum speed
 DVD: −100
 Video CD: −40
 CD: −50

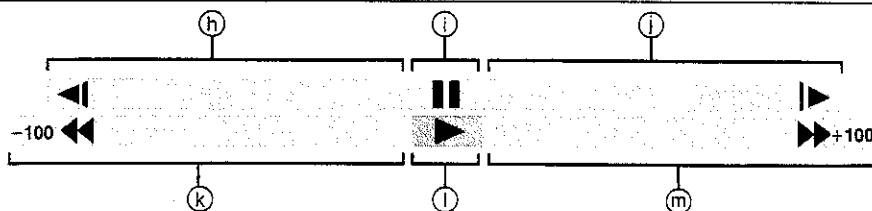

Maximum speed
 DVD: +100
 Video CD: +40
 CD: +50

h Slow-motion play (Backward) **DVD**

Press the cursor buttons [▲]→[◀].

i Still/Pause

Press the cursor button [▲].

j Slow-motion play (Forward) **DVD**

Press the cursor buttons [▲]→[▶].

k Rapid reverse

Press the cursor buttons [▼]→[◀].

l Play

Press the cursor button [▼].

m Rapid advance

Press the cursor buttons [▼]→[▶].

For your reference

- Each time the cursor buttons [◀, ▶] are pressed, the speed of rapid reverse/advance and slow-motion play increases up to 5 steps.

Changing initial settings

Change the initial settings to suit your preference and to suit the player to the environment in which it is being used. (Examples are from DVD-RV40.)

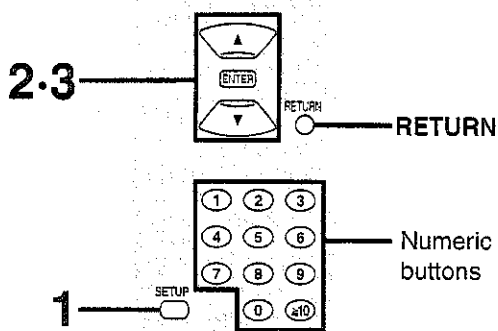

Common procedures

- 1 Press [SETUP] in the stop mode.**
The initial settings screen is displayed.
- 2 Press the cursor buttons [▲, ▼] to select the item and press [ENTER].**
Each item that can be modified is displayed.

- 1 Disc Languages (⇒ page 27)**
Change the soundtrack language, subtitle language and the language used in the disc's menu to be used for every disc played back.
- 2 Ratings (⇒ page 28)**
Change the ratings level to prevent play of discs, skip violent scenes, or replace scenes with others by entering a password. This is also called a parental lock.
- 3 Menu Language (⇒ page 29)**
Change the language used for the on-screen displays and initial settings menus.
- 4 On-Screen Messages (⇒ page 29)**
Choose whether "Play", "Still" and other displays will be displayed or not, and the colour and position of these displays as well as GUI screens.
- 5 FL Display (⇒ page 29)**
Change the brightness for the FL display.
- 6 TV Aspect (⇒ page 12)**
Change the settings to suit the type of television you have connected.
- 7 Digital Audio Output (⇒ page 37)**
Change the settings to suit the type of digital equipment you have connected.
- 8 Speaker Setting (⇒ page 39) DVD-RV40**
Change the settings to suit the speakers you have connected.
- 9 Other Settings (⇒ page 30)**
Choose the kind of picture shown when play is paused, and various other settings to enhance your viewing experience.

- 3 Press the cursor buttons [▲, ▼] to select the setting and press [ENTER].**

•Some items require additional steps. (See the respective page.)

Setting is finished and the initial settings screen is displayed.

To cancel during setup operation

Press [RETURN]. (The previous screen is displayed.)

To exit the initial settings screen

Press [SETUP] or [RETURN].

For your reference

•The numeric buttons can also be used instead of the cursor buttons [▲, ▼] for selecting items or settings. Pressing [ENTER] is not necessary.

1

SETUP

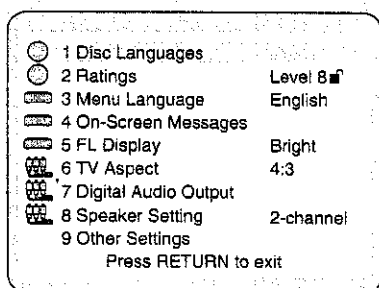

2

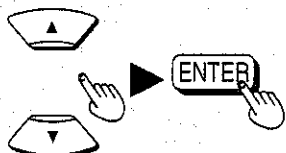

3

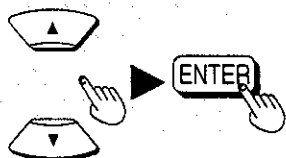

1 Disc Languages

DVD

See page 26 for operation.

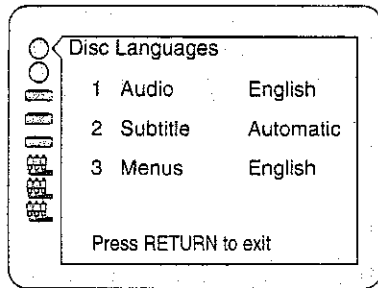

1 Audio	1 English (Factory preset) 2 French 3 German 4 Italian 5 Spanish 6 Original The original language of each disc will be selected. 7 Other ×××× Another language can be selected.*
2 Subtitle	1 Automatic (Factory preset) Subtitle language will automatically be selected in accordance with the soundtrack language. ● If the language selected for the "1 Audio" is actually used during playback, the subtitles will not appear. ● If another language is used during playback, the subtitles will appear in the language selected at the setup "1 Audio". 2 English 3 French 4 German 5 Italian 6 Spanish 7 Other * * * * Another language can be selected.*
3 Menus	1 English (Factory preset) 2 French 3 German 4 Italian 5 Spanish 6 Other * * * * Another language can be selected.*

* Enter the language code if you select "Other". (See the language code list below.) Press [CANCEL] if you enter the wrong number.

Note

● If the language selected is not available on the disc, the language designated by each disc will be selected. There are cases where the selected language is recorded but the disc designates another language.

Language code list

6565: Afar	6890: Bhutani	7285: Hungarian	7679: Laotian	8084: Portuguese	8471: Tajik
6566: Abkhazian	6976: Greek	7289: Armenian	7684: Lithuanian	8185: Quechua	8472: Thai
6570: Afrikaans	6978: English	7365: Interlingua	7686: Latvian, Lettish	8277: Rhaeto-Romance	8473: Tigrinya
6577: Ameharic	6979: Esperanto	7378: Indonesian	7771: Malagasy	8279: Romanian	8475: Turkmen
6582: Arabic	6983: Spanish	7383: Icelandic	7773: Maori	8285: Russian	8476: Tagalog
6583: Assamese	6984: Estonian	7384: Italian	7775: Macedonian	8365: Sanskrit	8479: Tonga
6588: Aymara	6985: Basque	7387: Hebrew	7776: Malayalam	8368: Sindhi	8482: Turkish
6590: Azerbaijani	7065: Persian	7465: Japanese	7778: Mongolian	8372: Serbo-Croatian	8484: Tatar
6665: Bashkir	7073: Finnish	7473: Yiddish	7779: Moldavian	8373: Singhalese	8487: Twi
6669: Byelorussian	7074: Fiji	7487: Javanese	7782: Marathi	8375: Slovak	8575: Ukrainian
6671: Bulgarian	7079: Faroese	7565: Georgian	7783: Malay	8376: Slovenian	8582: Urdu
6672: Bihari	7082: French	7575: Kazakh	7784: Maltese	8377: Samoan	8590: Uzbek
6678: Bengali; Bangla	7089: Frisian	7576: Greenlandic	7789: Burmese	8378: Shona	8673: Vietnamese
6679: Tibetan	7165: Irish	7577: Cambodian	7865: Nauru	8379: Somali	8679: Volapük
6682: Breton	7168: Scots Gaelic	7578: Kannada	7869: Nepali	8381: Albanian	8779: Wolof
6765: Catalan	7176: Galician	7579: Korean	7876: Dutch	8382: Serbian	8872: Xhosa
6779: Corsican	7178: Guarani	7583: Kashmiri	7879: Norwegian	8385: Sundanese	8979: Yoruba
6783: Czech	7185: Gujarati	7585: Kurdish	7982: Oriya	8386: Swedish	9072: Chinese
6789: Welsh	7265: Hausa	7589: Kirghiz	8065: Punjabi	8387: Swahili	9085: Zulu
6865: Danish	7273: Hindi	7665: Latin	8076: Polish	8465: Tamil	
6869: German	7282: Croatian	7678: Lingala	8083: Pashto, Pushto	8469: Telugu	

Changing initial settings

2 Ratings

DVD

See page 26 for operation.

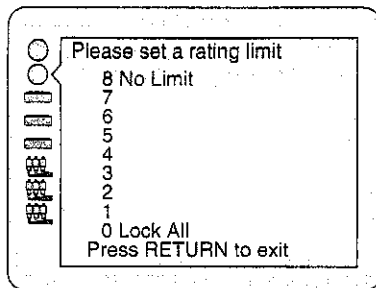

Level 8 (Factory preset)
All DVDs can be played.

Level 7 to 1

Prevents play of DVDs with ratings recorded on them (those that contain adult or violent scenes).

Level 0

Playback of all DVDs is prohibited (e.g. to prohibit playback of DVDs for adults which are not encoded with rating information).

Note

- The rating method differs from disc to disc. There are discs designed for adults that do not have these ratings recorded on them. These discs can be played as normal. To prevent play of these discs, set the rating limit to "0 Lock All".

Setting ratings (When the level is "8")

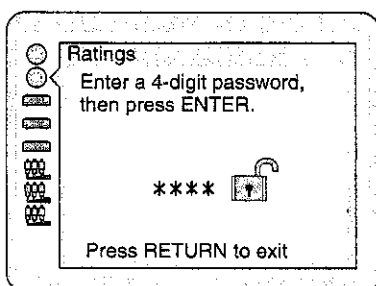

1 Select the level with the cursor buttons [▲, ▼] and press [ENTER].

2 Enter a 4-digit password with the numeric buttons and press [ENTER].

- Press [CANCEL] if you enter the wrong number.

The lock symbol appears closed to show the rating is locked.
Do not forget your password.

3 Press [ENTER].

Setting is finished and the initial settings screen is displayed.

Now when you insert a DVD that exceeds the ratings limit you set, a message appears on the television. If you want to play the disc, select "Yes" and enter your password. The unit will unlock temporarily, locking again when the disc tray is opened or the unit is turned off.

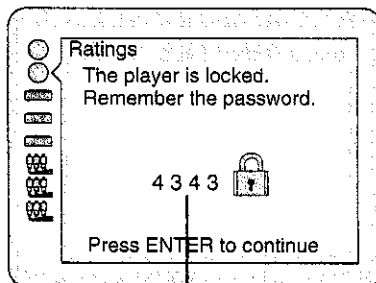
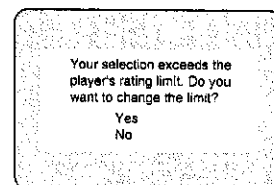

Example: "4343"

Changing ratings (When the level is "0" to "7")

Changes to the settings also requires a password.

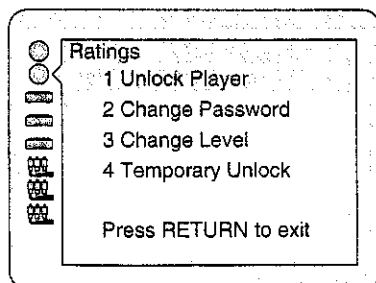

1 Press the cursor buttons [▲, ▼] to select "2 Ratings" in the initial settings screen and press [ENTER].

2 Enter your 4-digit password with the numeric buttons and press [ENTER].

3 Press the cursor buttons [▲, ▼] to select the item.

To unlock the player (the rating level returns to 8)
Select "1" and then press [ENTER].

To change the password

Select "2" and press [ENTER]. Enter a new 4-digit password and press [ENTER], then press [ENTER] again.

To change the rating level

Select "3" and press [ENTER]. Select a new level with the cursor buttons [▲, ▼], then press [ENTER].

To unlock the player temporarily

Select "4" and then press [ENTER].

- The rating is unlocked temporarily for the current disc. The player is locked again when the disc tray is opened or the player is switched to the standby mode or turned off.

3 Menu Language

See page 26 for operation.

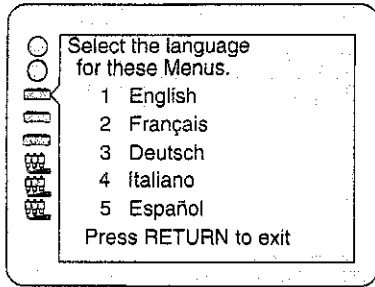

- 1 English (Factory preset)
- 2 Français
- 3 Deutsch
- 4 Italiano
- 5 Español

Example: If you selected "2 Français"

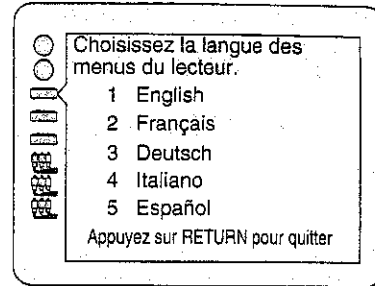

4 On-Screen Messages

See page 26 for operation.

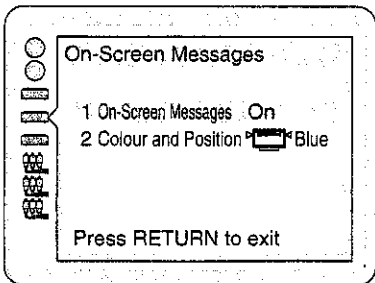

1 On-Screen Messages	1 On (Factory preset) 2 Off
2 Colour and Position	<ul style="list-style-type: none"> 1 Blue (Factory preset) 2 Violet 3 Green 4 Blue 5 Violet 6 Green <p>Shown slightly lower. Select if the top of the screen is cut off.</p>

5 FL Display

See page 26 for operation.

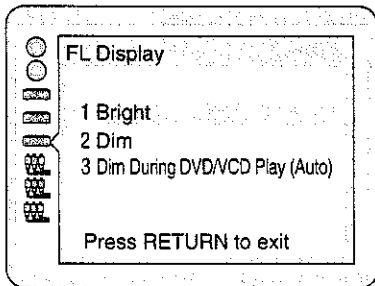

- 1 Bright (Factory preset)
- 2 Dim
- 3 Dim During DVD/VCD Play (Auto) **DVD-RV40**
The FL display will be dimmed during playback of DVDs and Video CDs. The display resumes brightness when a button for special play such as [◀◀, ▶▶ SLOW/SEARCH] or [⏸ PAUSE] is pressed.

Changing initial settings

9 Other Settings

See page 26 for operation.

For the United Kingdom and Continental Europe

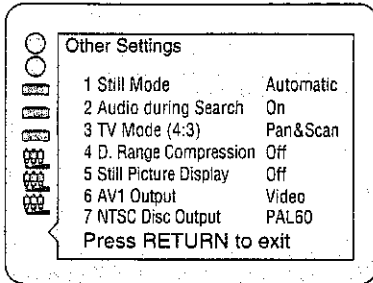

For Australia and N.Z.

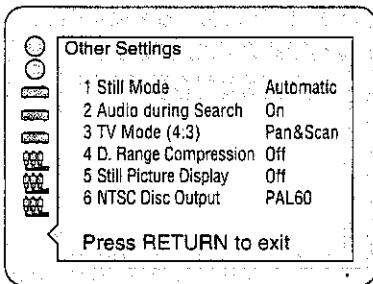

<p>1 Still Mode Select either "Field still" or "Frame still" in the still picture mode.</p>	<p>1 Automatic (Factory preset) 2 Field Select this setting when jittering occurs in the still picture mode when "1 Automatic" is selected. 3 Frame Select if small text or fine patterns cannot be seen clearly in the still picture mode when "1 Automatic" is selected.</p>
<p>2 Audio during Search To select whether audio is heard or not during search (forward direction) at the initial search speed.</p>	<p>1 On (Factory preset) 2 Off</p>
<p>3 TV Mode (4:3) To select whether wide-screen material is played in the pan and scan style or in the letterbox style on a conventional TV (4:3).</p>	<p>1 Pan & Scan (Factory preset) Wide-screen video material will be played in the pan and scan style (the picture is shown with either one or both sides cut off) on a conventional television (4:3). ● Video material not formatted in the pan and scan style will be played back in the letterbox style. 2 Letterbox Wide-screen video material will be played in the letterbox style (black bands appear at the top and bottom of the screen) on a conventional television (4:3).</p>
<p>4 D.(Dynamic) Range Compression To compress the dynamic range (the difference between the loudest sound and the softest sound), making it easier to hear dialogue even at low volume. This function only works with Dolby Digital DVD.</p>	<p>1 Off (Factory preset) The dynamic range remains as it was recorded on the disc. 2 On Dynamic range is compressed by increasing soft sounds and reducing loud sounds. Select when viewing discs at low volume, such as late at night.</p>
<p>5 Still Picture Display To display the picture type (DVD), I, P or B in the still picture mode.</p>	<p>1 Off (Factory preset) 2 On</p> <div data-bbox="1075 1317 1310 1435" style="border: 1px solid black; padding: 5px; text-align: center;"> </div> <p style="text-align: center;">Example: P-picture</p>
<p>(For the United Kingdom and Continental Europe) 6 AV1 Output DVD-RV40 AV Output DVD-RV20 To select the signal format (Video or S-Video) to be output from the AV1 (AV for DVD-RV20) SCART terminals.</p>	<p>1 Video (Factory preset) Composite video signals will be output. 2 S-Video S video signals will be output.</p>
<p>7 NTSC Disc Output[*] To select whether PAL 60 signals or NTSC signals will be output during playback of NTSC discs.</p>	<p>1 PAL 60 (Factory preset) Select when the player is connected to a PAL TV which is capable of receiving PAL 525/60 system. 2 NTSC Select when the player is connected to a Multi-system television.</p>

*For Australia and N.Z., "7 NTSC Disc Output" is on "6".

Note

- Audio is heard at any speed when playing CDs, regardless of any settings at "2 Audio during Search".
- Audio is not heard at any speed when playing CDs encoded with DTS, regardless of any settings at "2 Audio during Search".
- It is recommended that "1 PAL 60" is selected in "7 NTSC Disc Output" when a PAL TV is connected; however, the images shown below will appear on the TV screen. The picture may be compressed vertically.



For your reference

•I/P/B

To efficiently store video on DVD, common elements among frames are used in common, and different elements are recorded with each individual frame. The frame that contains the common elements is called an I-picture, a complete frame in itself. A P-picture is calculated from past I or P-pictures. The frame that fills in the spaces between the I-and P-pictures is called the B-picture. I-pictures have the best picture quality, so they should be used when making picture adjustments.

•Frame

Individual images in a video or on the television are called frames.

•Field

Half of the video information (video signal) in a frame is called a field. With conventional TV systems, a single frame (a single screen) consists of two fields.

•Frame still

The two fields are displayed alternately on the TV screen, so the image may be blurry. However, the image quality is better than field images.





















•Field still

Only one field (half of the video information) is displayed on the TV screen, so the apparent resolution is low. However, there is no blurring on the screen.

How different kinds of software appear on your television

DVD software is recorded in a variety of picture formats, and how they appear on your TV depends on the software, the kind of TV you have, and the picture mode your TV is set to.

- Letterbox refers to pictures where black bands appear at the top and bottom.
- Pan and scan refers to pictures where part of the picture is cut off so it fills the whole screen.

Television and picture mode \ Software format	4:3	16:9 full mode	16:9 zoom mode	16:9 auto mode
Wide-screen, pan and scan 	Edges cut off 	Full screen 	Top and bottom cut off 	Full screen 
Wide-screen, non-pan and scan 	Letterbox 			
Regular (4:3) 	Full screen 	Screen stretched horizontally 	Top and bottom cut off 	Full screen with black bands at right and left 
Regular (4:3) letterbox 	Letterbox 	Letterbox with screen stretched horizontally 	Full screen 	Letterbox with extremities of picture stretched 

The names given to the television picture modes depends on the make of your television. There may also be slight differences in how the pictures appear on the screen. Refer to your television's operating instructions for details.

Home theater

■ Upgrading your audio equipment

Setup chart					
Equipment and settings Types of connection	Equipment	Speakers	Settings in "8 Speaker Setting" ^{*1}	Settings in "7 Digital Audio Output"	Page
To enjoy the 5.1-channel surround sound found on DVDs using the unit's built-in decoder ^{*1}	Amplifier with 5.1-channel audio input terminals	<ul style="list-style-type: none"> ● Front speakers (L/R) ● Subwoofer ● Surround speakers (L/R) ● Center speaker 	Select "1 Multi-channel" <ul style="list-style-type: none"> ● Speaker presence ⇒ Set speakers you have connected to "Yes" ● Set delay time if necessary ● Correct output balance if necessary 	PCM Down Conversion ⇒ "No"	A 33
To add bass to the sound from your television ^{*2}	_____	Subwoofer	No settings required	PCM Down Conversion ⇒ "No"	B 34
To enjoy stereo and added bass ^{*2}	Analogue amplifier or system component with 2-channel audio input terminals	<ul style="list-style-type: none"> ● Front speakers (L/R) ● Subwoofer 	No settings required	PCM Down Conversion ⇒ "No"	C 34
To enjoy stereo through an analogue amplifier ^{*3}		Front speakers (L/R)	Select "2 2-channel"	PCM Down Conversion ⇒ "No"	C 34
To enjoy the 5.1-channel surround sound found on DVDs using the decoder in another unit	Amplifier with built-in decoder or a separate decoder-amplifier combination ^{*4}	<ul style="list-style-type: none"> ● Front speakers (L/R) ● Subwoofer ● Surround speakers (L/R) ● Center speaker 	Select "2 2-channel"	<ul style="list-style-type: none"> ● PCM Down Conversion ⇒ "Yes" ● Dolby Digital/DTS Digital Surround/MPEG ⇒ settings depend on your decoding equipment 	D 35
To enjoy stereo through a digital amplifier ^{*3}	Audio equipment with digital audio input terminals	Front speakers (L/R)	Select "2 2-channel"	<ul style="list-style-type: none"> ● PCM Down Conversion ⇒ "Yes" ● Dolby Digital ⇒ "PCM" ● DTS Digital Surround ⇒ "Off" ● MPEG ⇒ "PCM" 	E 36

*1 DVD-RV40 only.

*2 DVD-RV20 only.

*3 If you have connected a Dolby Pro Logic amplifier, you may need to connect center and surround speakers.

*4 Connect speakers if necessary and make the speaker settings on the amplifier.

■ Upgrading your television

- You can connect CRT projectors, LCD projectors, and projection televisions.
- See "Connection to a television" (⇒ pages 9 to 11) for details on connection.

Note

- The equipment connections described are examples. The illustrations on pages 33, 35 and 36 use DVD-RV40 as an example, and on pages 34 use DVD-RV20 as an example.
- Additional equipment and cables are not supplied.

Manufactured under license from Dolby Laboratories. "Dolby", "Pro Logic" and the double-D symbol are trademarks of Dolby Laboratories. Confidential unpublished works. © 1992-1997 Dolby Laboratories, Inc. All rights reserved.

For your reference

- Dolby Digital is a digital sound compression technique developed by Dolby Laboratories. Supporting 5.1-channel surround sound, as well as stereo (2-channel) sound, this technique enables a large quantity of sound data to be efficiently recorded on a disc.
- DTS Digital Surround is a 5.1-channel surround sound system, which is widely used in movie theaters around the world. The separation between channels is good and provides a very real surround effect.
- Linear PCM is an uncompressed digital audio signal. While a CD is recorded in 44.1 kHz/16 bit, a DVD is recorded in 48 kHz/16 bit up to 96 kHz/24 bit. Therefore, the sound reproduced with these signals is potentially better than that found on CDs. This player reproduces linear PCM in 2-channel.
- Bitstream is a compressed digital audio signal. This signal can be decoded into different channels to produce, for instance, 5.1-channel surround sound.
- The digital audio output terminal (optical) converts electrical signals into optical signals and transfers them to an amplifier. These optical signals are immune to electrical interference, and they also have minimal effect on other equipment.

A Connecting an amplifier with 5.1-channel audio input terminals DVD-RV40

This unit can decode Dolby Digital. Connect an amplifier with 5.1-channel discrete input terminals to enjoy surround sound.

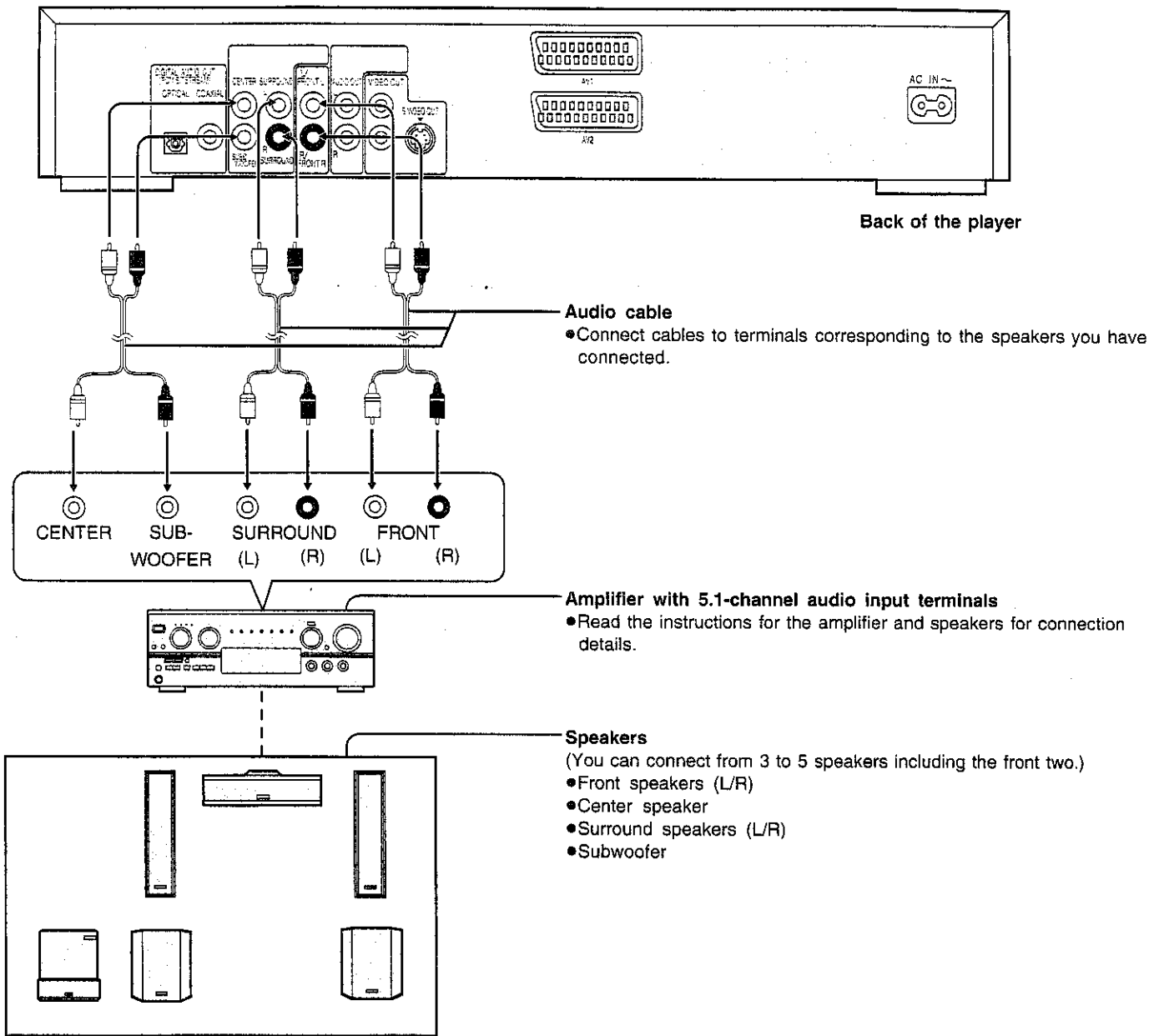

When you have finished connection

• In "8 Speaker Setting", select "1 Multi-channel" and make changes to suit your speakers (⇒ page 39).

Speaker presence: Select "Yes" if the corresponding speaker is connected.

Select "No" if the corresponding speaker is not connected.

Center and surround speaker delay time (Dolby Digital DVD only): Adjust if you cannot place your speakers in the optimum position.

Channel balance: Adjust the output level of the speakers to make up for differences in volume caused by different types of speaker or distance.

• Go to "7 Digital Audio Output" and set "1 PCM Down Conversion" to "No" (⇒ page 37).

Note

• Turn off V.S.S. (⇒ page 20) if you have connected a subwoofer, center speaker, or surround speakers as well as the front speakers. Sound will not come from the other speakers if V.S.S. is on.

• Additional equipment and cables are not supplied.

B Connecting a subwoofer DVD-RV20

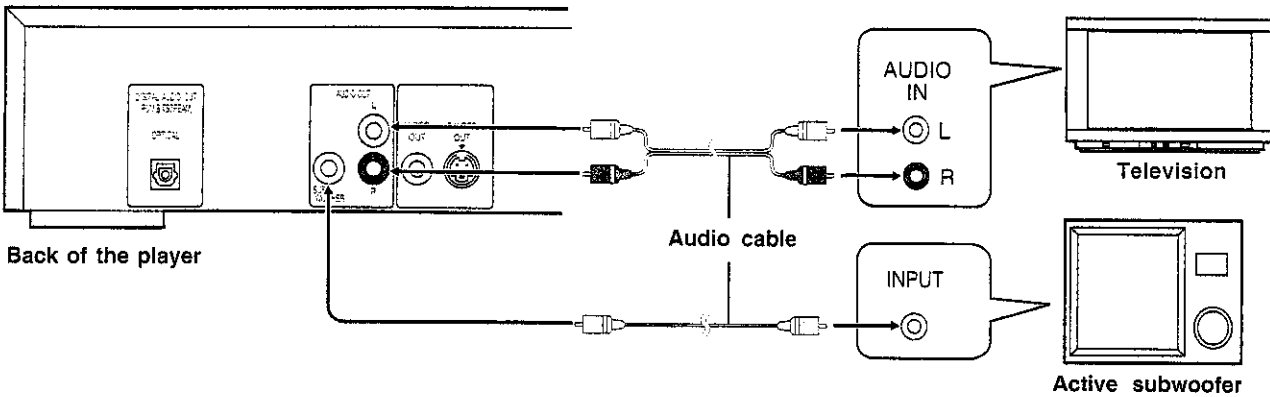

- Use the GUI screens to turn subwoofer output on (⇒ item ④ on page 25).
- Place the subwoofer as close as possible to the front center.
- Adjust the volume of the subwoofer to suit your preference.

When you have finished connection

- Go to "7 Digital Audio Output" and set "1 PCM Down Conversion" to "No" (⇒ page 37).

Note

- Additional equipment and cables are not supplied.

C Connecting audio equipment with 2-channel audio input terminals

You can enjoy stereo sound if you connect an amplifier or system component that has 2-channel audio input terminals. By connecting a subwoofer, you can also enjoy powerful bass.

■ Connecting the amplifier or system component

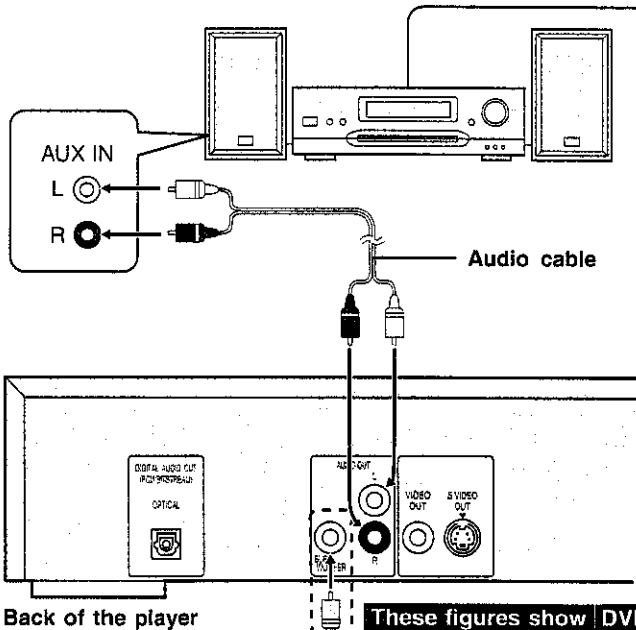

Amplifier and speakers or system component

- Read the instructions for the amplifier and speakers or system component for connection details.

Dolby Pro Logic amplifiers

- If you connect a Dolby Pro Logic amplifier, you will also need to connect center and surround speakers to enjoy surround sound. Read the instructions for the equipment for connection details.
- Turn off V.S.S. (⇒ page 20) and subwoofer output (⇒ item ④ on page 25). Dolby Pro Logic will not function correctly if they are on.

Back of the player **These figures show DVD-RV20.**

■ Connecting a subwoofer DVD-RV20

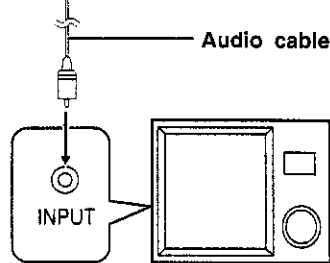

Active subwoofer

- Use the GUI screens to turn subwoofer output on (⇒ item ④ on page 25).
- Place the subwoofer as close as possible to the front center.
- Adjust the volume of the subwoofer to suit your preference.

When you have finished connection

- Go to "7 Digital Audio Output" and set "1 PCM Down Conversion" to "No" (⇒ page 37).
- In "8 Speaker Setting", select "2 2-channel" (⇒ page 39). **DVD-RV40**

Note

- Additional equipment and cables are not supplied.

D Connecting an amplifier with a built-in decoder

You can enjoy the multi-channel surround sound found on DVD recorded with Dolby Digital, DTS Digital Surround or MPEG by connecting an amplifier with a built-in decoder or a separate decoder-amplifier combination.

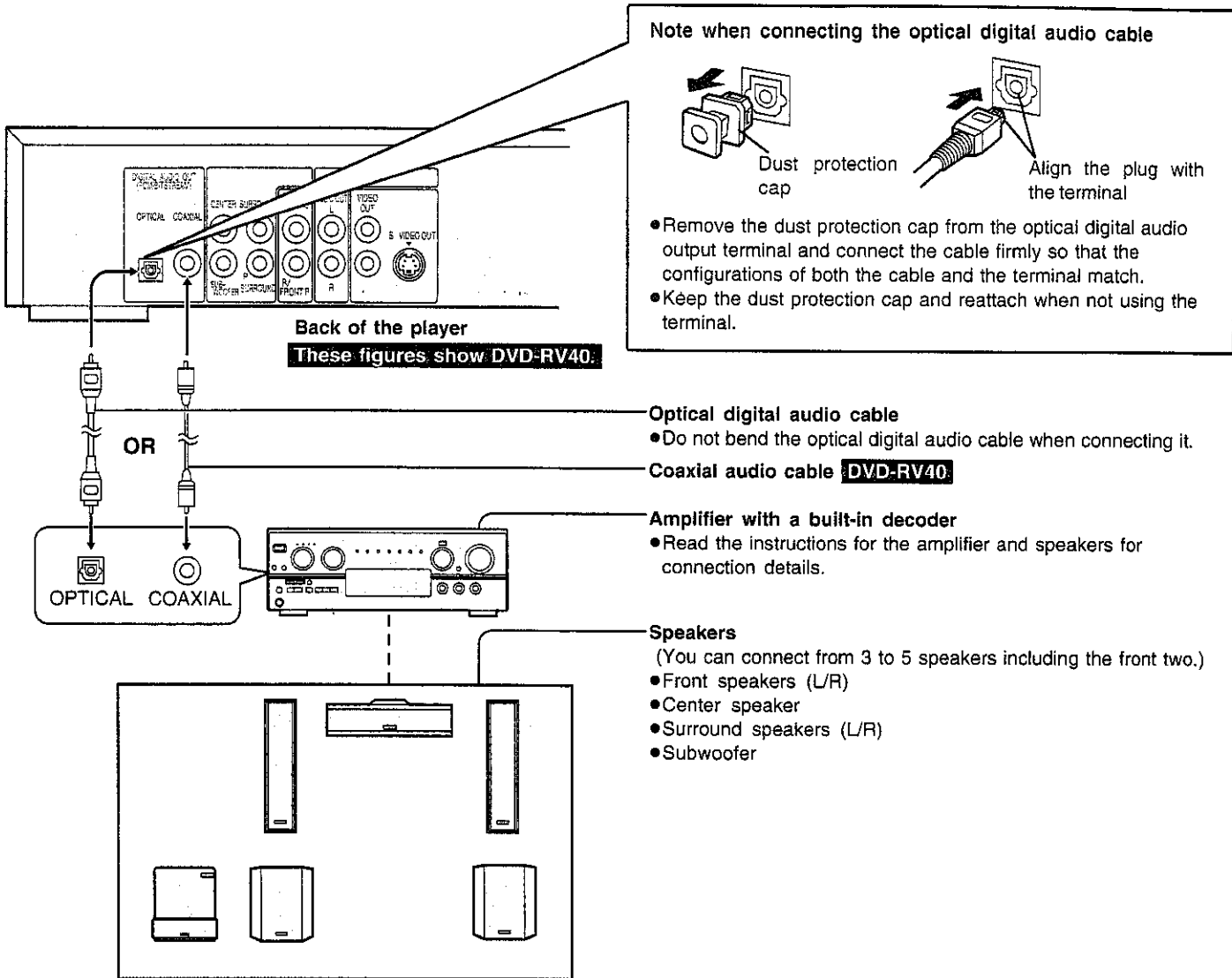

When you have finished connection

• Make changes to "7 Digital Audio Output" to suit your decoder (⇒ page 37).

Item	Decoder			
	Dolby Digital decoder	DTS Digital Surround decoder	Dolby Digital/ DTS Digital Surround decoder	Dolby Digital/ DTS Digital Surround / MPEG audio decoder
PCM Down Conversion	Yes [※]	Yes [※]	Yes [※]	Yes [※]
Dolby Digital	Bitstream	PCM	Bitstream	Bitstream
DTS Digital Surround	Off	Bitstream	Bitstream	Bitstream
MPEG	PCM	PCM	PCM	Bitstream

※ If this is set to "No", no audio will be output when DVDs recorded in 96 kHz linear PCM are played. (Audio will be output as it is if the DVD does not have copyright protection recorded on it.)

• These changes to digital audio output must be made, otherwise bitstream signals the decoder cannot handle will be output. If these signals are output, "noise" will be output which can cause harm to your ears and speakers.

• In "8 Speaker Settings", select "2 2-channel" (⇒ page 39). **DVD-RV40**

The sound for speakers other than the front left and right speakers will not be heard if you do not select "2 2-channel".

Note

- You cannot use DTS Digital Surround decoders not suited to DVD.
- Additional equipment and cables are not supplied.

E Connecting audio equipment with digital audio input terminals

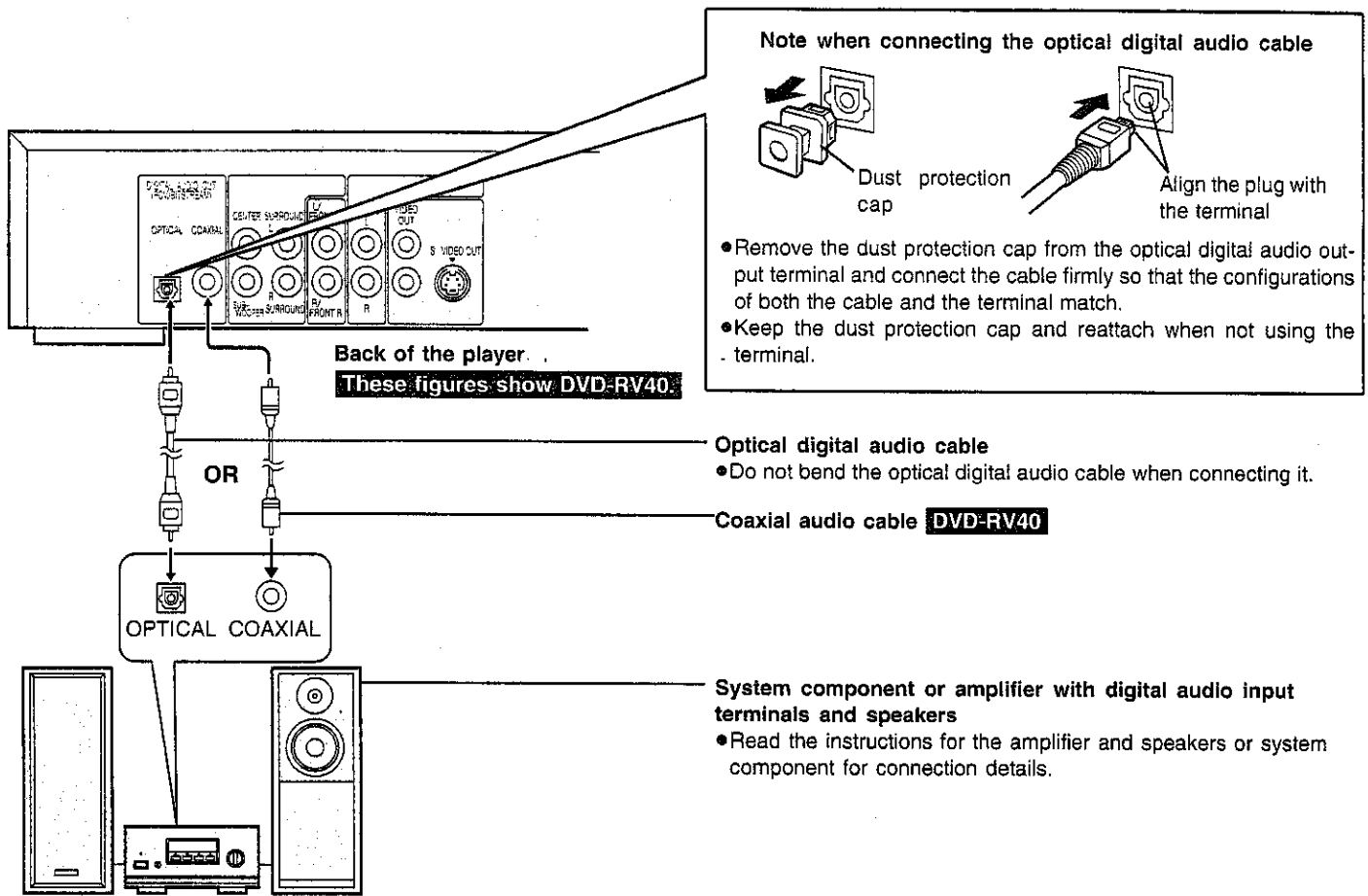

When you have finished connection

- Make changes to "7 Digital Audio Output" as shown (⇒ page 37).

PCM Down Conversion	Yes*
Dolby Digital	PCM
DTS Digital Surround	Off
MPEG	PCM

* If this is set to "No", no audio will be output when DVDs recorded in 96 kHz linear PCM are played. (Audio will be output as it is if the DVD does not have copyright protection recorded on it.)

- These changes to digital audio output must be made, otherwise signals the equipment cannot handle, bitstream, will be output. If the signals are output as bitstream, "noise" will be output which can cause harm to your ears and speakers.

- In "8 Speaker Settings", select "2 2-channel" (⇒ page 39). **DVD-RV40**
 The sound for speakers other than the front left and right speakers will not be heard if you do not select "2 2-channel".

Note

- Additional equipment and cables are not supplied.

2.3.4

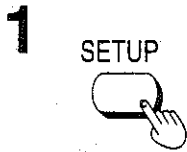
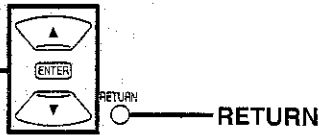

1	Disc Languages	
2	Platings	Level 8
3	Menu Language	English
4	On-Screen Messages	
5	FL Display	Bright
6	TV Aspect	4:3
7	Digital Audio Output	
8	Speaker Setting	2-channel
9	Other Settings	

Press RETURN to exit

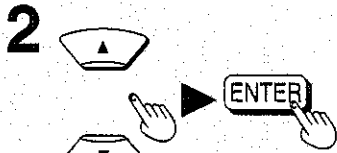

Digital Audio Output		
1	PCM Down Conversion No.	
2	Dolby Digital	Bitstream
3	DTS Digital Surround	Off
4	MPEG	PCM

Press RETURN to exit

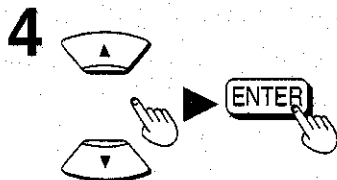
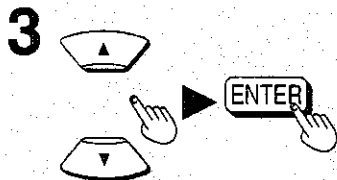

Selecting digital output

Select the digital output to be output from the optical or coaxial (DVD-RV40 only) digital audio output terminal of the player.

- 1 Press [SETUP] in the stop mode.**
The initial settings screen is displayed.
- 2 Press the cursor buttons [▲, ▼] to select "7 Digital Audio Output" and press [ENTER].**
- 3 Press the cursor buttons [▲, ▼] to select the item and press [ENTER].**

- 1 PCM Down Conversion**
Select whether to output audio on DVD recorded in 96 kHz linear PCM as is (No) or to convert it to 48 kHz for output (Yes).
- 2 Dolby Digital**
To select the signal format (Bitstream or PCM) to be output from the optical digital or coaxial (DVD-RV40 only) audio output terminal during playback of DVDs recorded in Dolby Digital.
- 3 DTS Digital Surround**
To select whether DTS Digital Surround bitstream is output from the optical digital or coaxial (DVD-RV40 only) audio output terminal or no digital audio is output during playback of DVDs recorded in DTS Digital Surround.
- 4 MPEG**
To select the signal format (PCM or Bitstream) to be output from the optical digital or coaxial (DVD-RV40 only) audio output terminal during playback of the DVD recorded in MPEG audio.

- 4 Press the cursor buttons [▲, ▼] to select the setting and press [ENTER].**

When "1 PCM Down Conversion" is selected

- 1 No (Factory preset)**
No digital audio is output during playback of DVDs recorded in 96 kHz linear PCM.
● If the DVD is recorded in 48 kHz linear PCM, digital audio converted to 48 kHz/16 bit is output irrespective of the setting.
● Audio will be output using the original audio recording system if the DVD has not been copyright-protected.
- 2 Yes^{#1}**
During playback of DVDs recorded in 48 kHz or 96 kHz linear PCM, digital audio converted to 48 kHz/16 bit is output.
(Digital output of PCM audio is restricted to 48 kHz/16 bit or below for copyright protection.)

When "2 Dolby Digital" is selected

- 1 Bitstream^{#2} (Factory preset)**
Dolby Digital bitstream (1ch-5.1ch) is output during playback of DVDs recorded in Dolby Digital.
- 2 PCM**
Digital audio converted to 48 kHz/16 bit PCM (2ch) is output during playback of DVDs recorded in Dolby Digital.

When "3 DTS Digital Surround" is selected

- 1 Off (Factory preset)**
No digital audio is output during playback of DVDs recorded in DTS Digital Surround.
- 2 Bitstream^{#2}**
DTS Digital Surround bitstream (1ch-5.1ch) is output during playback of DVDs recorded in DTS Digital Surround.

(Continued on next page)

Home theater

When "4 MPEG" is selected

- 1 **PCM** (Factory preset)
Digital audio converted to 48 kHz/16 bit PCM (2ch) is output during playback of DVDs recorded in MPEG audio.
- 2 **Bitstream***2
MPEG audio bitstream (1ch-7.1ch) is output during playback of DVDs recorded in MPEG audio.

The screen illustrated in step 2 is displayed.

To cancel during setup operation

Press [RETURN]. (The previous screen is displayed.)

To exit the initial settings screen

Press [SETUP] or [RETURN].

Recommended setting of "Digital Audio Output"

Adjust settings as shown in the table below depending on the kind of equipment that is connected to the optical digital or coaxial (DVD-RV40 only) audio output terminal.

Type of equipment connected	Recommended setting			
	1 PCM Down Conversion	2 Dolby Digital	3 DTS Digital Surround	4 MPEG
No equipment is connected	<u>No</u>	<u>Bitstream</u>	<u>Off</u>	<u>PCM</u>
Digital audio equipment (no decoder) (⇒ page 36)	Yes*1	PCM*2	<u>Off</u> *2	<u>PCM</u> *2
Dolby Digital decoder (⇒ page 35)	Yes*1	<u>Bitstream</u>	<u>Off</u>	<u>PCM</u>
DTS Digital Surround decoder (⇒ page 35)	Yes*1	PCM	Bitstream	<u>PCM</u>
Dolby Digital/DTS Digital Surround decoder (⇒ page 35)	Yes*1	<u>Bitstream</u>	Bitstream	<u>PCM</u>
Dolby Digital /DTS Digital Surround/ MPEG audio decoder (⇒ page 35)	Yes*1	<u>Bitstream</u>	Bitstream	Bitstream

• Underlined items are factory preset.

*1 If it is set to "Yes", the player converts linear PCM to 48 kHz even during analogue output.
Do the following if you wish to take advantage of high quality 96 kHz sound.
Select "No" and connect this player's audio output terminal to an amplifier's audio input terminal with the audio/video cable (supplied) or an audio cable (not supplied).

*2 When connecting an amplifier (with an optical digital or coaxial input terminal) which does not contain a Dolby Digital, DTS Digital Surround or MPEG audio decoder, be sure to select "PCM" at the "2 Dolby Digital", "Off" at the "3 DTS Digital Surround" and "PCM" at the "4 MPEG". If "Bitstream" is selected, any attempt to play DVDs (or CDs encoded with DTS) may cause such a high level of noise that can injure your ears and damage your speakers.

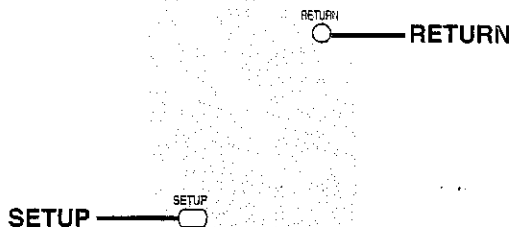

2.3.4.5

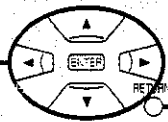

RETURN

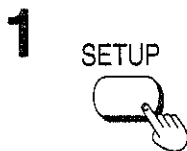

1	Disc Languages	
2	Ratings	Level 8
3	Menu Language	English
4	On-Screen Messages	
5	FL Display	Bright
6	TV Aspect	4:3
7	Digital Audio Output	
8	Speaker Setting	2-channel
9	Other Settings	

Press RETURN to exit

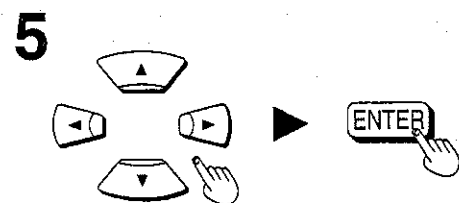
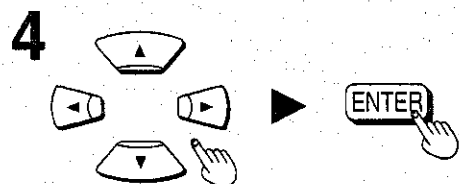
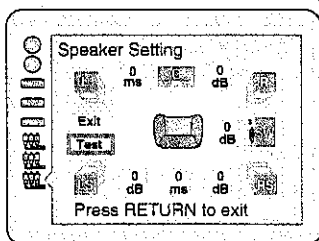
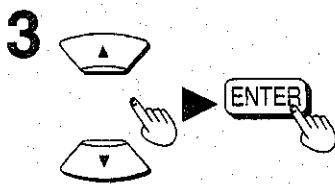
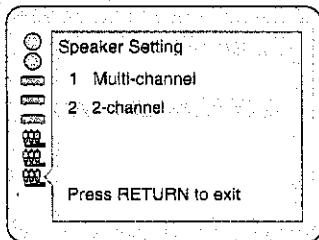
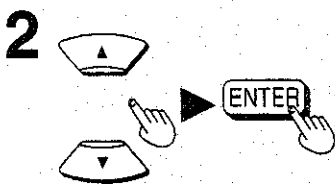

Speaker setting DVD-RV40

Here you can change the settings for the built-in Dolby Digital decoder. These changes will have no effect if you connect the player to other equipment through the digital audio output terminal. Make changes to the settings on the equipment you have connected.

Common procedure

- 1 Press [SETUP] in the stop mode.**
The initial settings screen is displayed.
- 2 Press the cursor buttons [▲, ▼] to select "8 Speaker Setting" and press [ENTER].**
- 3 Press the cursor buttons [▲, ▼] to select the item and press [ENTER].**
 - 1 Multi-channel**
If you have connected three or more speakers. (Proceed to step 4.)
 - 2 2-channel (Factory preset)**
If you have connected 2 speakers. (You will return to the menu shown in step 1. Settings are not necessary.)
- 4 Change settings to suit your speakers and the listening position (→ page 40).**
 - **Setting the size and presence of your speakers**
Choose "Yes" for speakers you have connected. Sound will not be output if you choose "No".
 - **Delay time**
Allows you to make up for differences in distance if you cannot place your speakers in the optimum position. (Dolby Digital DVD only)
 - **Channel balance**
Allows you to adjust the output level of the speakers to make up for differences in volume caused by different types of speaker or distance.
- 5 Press the cursor buttons [▲, ▼, ◀, ▶] to select "Exit" and press [ENTER].**

The screen illustrated in step 2 is displayed.

To cancel during setup operation
Press [RETURN]. (The previous screen is displayed.)

To exit the initial settings screen
Press [SETUP] or [RETURN].

(Continued on next page)

A

Front (L) Large/Small Center Large/Small/No Front (R) Large/Small

Surround (L) Large/Small/No Surround (R) Large/Small/No

Subwoofer Yes/No

• Underlined items are factory preset.

In case of surround speaker (L)
 No Large/Yes Small/Yes

B

Center delay time (0 ms)

Surround delay time (0 ms)

• Underlined items are factory preset.

Place all your speakers within this circumference

C

Center channel balance (0 dB)

Surround (L) channel balance (0 dB)

Surround (R) channel balance (0 dB)

Subwoofer channel balance (0 dB)

• Underlined items are factory preset.

Home theater

A **Setting the size and presence of your speakers**

1. Press the cursor buttons [▲, ▼, ◀, ▶] to select the item and press [ENTER].
 2. Press the cursor buttons [▲, ▼] to select the setting and press [ENTER].
- Large speaker icon
If the speaker supports low-frequency (under 100 Hz) reproduction
 - Small speaker icon
If the speaker does not support low-frequency reproduction.
 - If you do not connect a subwoofer, it is preferable to connect front speakers (L/R) capable of producing bass of less than 100 Hz.

B **Delay time**

- DVD** (Dolby Digital only)
1. Press the cursor buttons [▲, ▼, ◀, ▶] to select the item and press [ENTER].
 2. Press the cursor buttons [▲, ▼] to adjust the delay time and press [ENTER].
- Center speaker
Set delay time to "0 ms" (factory preset) if D_f is less than or equal to D_c .

If $D_f - D_c =$	then set to
approx. 50 cm	1.3 ms
approx. 100 cm	2.6 ms
approx. 150 cm	3.9 ms
approx. 200 cm	5.3 ms

- Surround speaker
Set delay time to "0 ms" (factory preset) if D_f and D_s are equal.

If $D_f - D_s =$	then set to
approx. 200 cm	5.3 ms
approx. 400 cm	10.6 ms
approx. 600 cm	15.9 ms

C **Channel balance**

1. Press the cursor buttons [▲, ▼, ◀, ▶] to select "Test" and press [ENTER].
A test signal is output from one speaker at a time, starting with the front left speaker and proceeding clockwise.

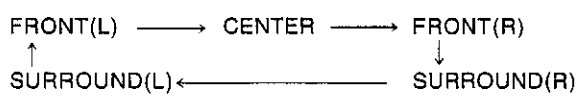

2. While listening to the test signal, press the cursor buttons [▲, ▼] to adjust the volume of the center and surround speakers so they are the same apparent volume as the front speakers. (The front speakers cannot be adjusted here.)
3. Press [ENTER]. (The test signals are stopped.)

Note
 • A test signal is not output from the subwoofer. To adjust its volume, play something, then return to this screen to adjust to your taste.

Troubleshooting Guide

Before requesting service for this player, check the chart below for a possible cause of the problem you are experiencing. Some simple checks or a minor adjustment on your part may eliminate the problem and restore proper operation.

If you are in doubt about some of the check points, or if the remedies indicated in the chart do not solve the problem, consult your dealer for instructions.

Reference pages are shown as black circled numbers ❸.

Common Problems

<p>No power.</p> <p>The player is automatically switched to the standby mode.</p> <p>Play fails to start even when [▶ PLAY] is pressed.</p> <p>Play starts but then stops immediately.</p>	<p>Insert the AC mains lead securely into the household mains socket. ❸</p> <p>To conserve power, the player automatically switches to the standby mode after approx. 30 minutes elapse in the stop mode (Auto power-off function). Turn the power back to ON.</p> <p>Condensation has formed: Wait about 1 to 2 hours for it to evaporate.</p> <p>This player cannot play discs other than DVD, Video CD and CD. ❹</p> <p>DVDs with a region number other than the region number of this player or "ALL" cannot be played.</p> <p>DVDs with multiple region numbers including the region number of this player can be played. ❺</p> <p>The disc may be dirty and may require cleaning. ❻</p> <p>Ensure that the disc is installed with the label of the side to be played facing upwards. ❼</p>
<p>No picture.</p>	<p>Ensure that the equipment is connected properly. ❸-❶</p> <p>Ensure that the input setting for the television is Audio/Video (AV) position. (e.g. For the United Kingdom and Continental Europe: AV1, AV2; For Australia and N.Z.: Video)</p>
<p>No sound.</p> <p>Distorted sound.</p>	<p>Ensure that the equipment is connected properly. ❸-❶ ❷-❸</p> <p>Ensure that the input settings for the television and stereo system are correct.</p> <p>Adjust the master volume using the GUI screen for player information. DVD-RV40 ❷</p>
<p>Picture is distorted during rapid advance or rapid reverse.</p>	<p>The picture will be somewhat distorted at times: This is normal.</p>
<p>No key operation (by the player and/or the remote control) is effective.</p>	<p>Some operations may be prohibited by the disc.</p> <p>Press [⏻/⏹] to switch the player to the standby mode and then back to ON. Alternatively, press [⏻/⏹] to switch the player to the standby mode, disconnect the AC mains lead and then reconnect it. (The player may not be operating properly due to lightning, static electricity or some other external factor.)</p> <p>Go to the initial settings menu "6 TV Aspect" and change the setting to suit your television. You may also need to change the screen mode on the television itself. ❶ ❷</p>
<p>The picture shown on the television is not normal. (The sides of the picture are cut off or black bands appear at the top and bottom of the screen.)</p>	
<p>No on-screen display.</p>	<p>The "Off" setting is selected for "1 On-Screen Messages" in "4 On-Screen Messages": Select "On". ❷</p>
<p>GUI screens not displayed or only partially displayed on the TV screen.</p>	<p>Change the position of the GUI screens using "2 Colour and Position" in "4 On-Screen Messages" of the initial settings. ❷</p>
<p>The language for the player's menus and on-screen messages is wrong.</p>	<p>Go to the initial settings menu "3 Menu Language" and change the language. ❷</p>
<p>No operations can be performed with the remote control.</p>	<p>To conserve power, the player is automatically switched to the standby mode after approx. 30 minutes elapse in the stop mode (Auto power-off function). Turn the power back to ON.</p> <p>Check the batteries are installed with the correct polarities (+ and -). ❷</p> <p>The batteries are depleted: Replace them with new ones. ❷</p> <p>Point the remote control at the remote control sensor and operate. ❷</p> <p>Operate the remote control at a distance of not more than 7 m from the remote control sensor. ❷</p> <p>Remove the obstacles between the remote control and remote control sensor. ❷</p>

<p>No subtitles.</p> <p>Alternative soundtrack (or subtitle) languages fail to be selected.</p> <p>Angle cannot be changed.</p> <p>Soundtrack and/or subtitle language is not the one selected at the initial settings.</p> <p>The disc's menu is displayed in French (example).</p> <p>Sound does not come from a speaker.</p> <p>The password for rating level has been forgotten.</p> <p>Reset all the settings to Factory Preset.</p> <p>The vocals cannot be turned off.</p> <p>There are no vocals while playing Karaoke DVD.</p> <p>A menu is shown after playing each song on a Karaoke DVD.</p>	<p>Subtitles appear only with discs which contain them. Subtitles are cleared from the TV monitor. Display the subtitles. 13 24</p> <p>An alternative language is not selected with discs which do not contain more than one language. In the case of some discs, the alternative language cannot be selected by operating the [AUDIO] or [SUBTITLE]. Try selecting it from the disc's menu if one is available. 16</p> <p>This function is dependent on software availability. Even if a disc has a number of angles recorded, these angles may be recorded for specific scenes only (when "ANGLE" lights up on the player's FL display).</p> <p>If the soundtrack and/or subtitle language does not exist on the disc, the language selected at the initial settings will not be seen/heard.</p> <p>The setup "3 Menus" of "1 Disc Languages" is set to French: Select English. 27</p> <p>Check the connections. 3-11 32-35</p> <p>If you have connected this player to an amplifier through the audio output terminals, go to the initial settings menu "8 Speaker Setting" and change the settings to suit your speakers. Select "Yes" for all the speakers you have connected. DVD-RV40 15</p> <p>If you have a subwoofer connected to this player, use the GUI screens with the remote control to turn subwoofer output on. DVD-RV20 25</p> <p>If you have connected this player to an amplifier (with built-in decoder) through the digital audio output terminal, go to the initial settings menu "7 Digital Audio Output" and change the settings to "Bitstream" for "2 Dolby Digital" or "3 DTS Digital Surround". 37</p> <p>No surround sound is output when the Virtual Surround Sound (V.S.S.) effect is activated. Turn V.S.S. off. 20</p> <p>While stopped, press and hold [◀◀/▶▶] and [⏏] on the player and then also press and hold [▲] on the player until "Initialized" disappears from the television (after about 3 seconds). All initial settings will return to the default values.</p> <p>You have selected an audio channel that includes a vocal channel. Read the disc's jacket to choose the correct channel. 17</p> <p>When you have connected this player to other equipment through a DIGITAL AUDIO OUTPUT terminal, go to "7 Digital Audio Output" in the initial settings and change the setting for "2 Dolby Digital" to "PCM". 32 45-48</p> <p>Most Karaoke DVDs are designed to do this. Some discs have an item in the menu that allows you to play all the songs.</p>
--	--

Video CD

<p>No menu play.</p>	<p>This function works only for Video CDs with playback control. 7</p>
-----------------------------	---

Self-diagnosis display function

When an error or trouble is detected during operation, a message appears in the FL display. When a message has appeared, check the details given below.

Message	Player status	Remedy
CHECK THE DISC	Disc is dirty.	Wipe the disc clean.
<p>H <input type="checkbox"/> <input type="checkbox"/></p> <p><input type="checkbox"/> <input type="checkbox"/> stands for a number.</p>	Trouble is likely to have occurred. The number following "H" differs depending on the status of the player.	Press [⏏] to switch the player to the standby mode and then back to ON. Alternatively, press [⏏] to switch the player to the standby mode, disconnect the AC mains lead, and then reconnect it.

● If the message fails to be cleared, even when remedial action is taken, ask a service technician to repair the player.

Disc handling

Choose discs with these marks:



However, do not use irregularly shaped discs, such as heart-shaped. (Discs of this sort can damage the player.)

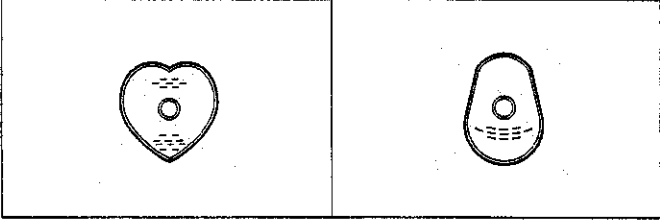

■ How to hold a disc

Do not touch the recorded surface.

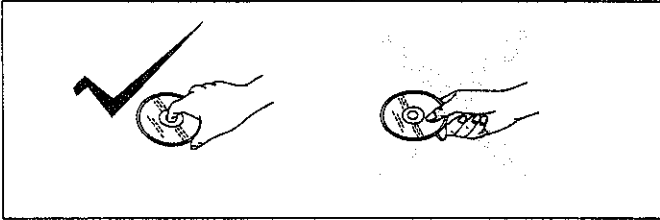

■ If the surface is dirty

Wipe it with a damp cloth and then wipe dry.

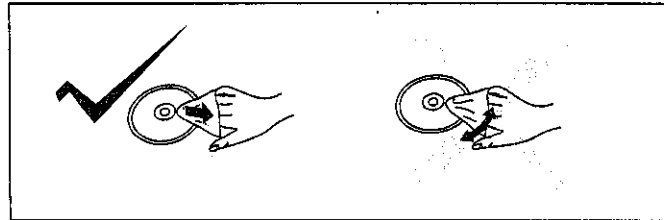

■ If the disc is brought from a cold to a warm environment, moisture may form on the disc

Wipe with a soft, dry, lint-free cloth before using the disc.

■ Handling precautions

- Do not write on the label side with a ball-point pen or other writing instrument.
- Do not use record cleaning sprays, benzine, thinner, static electricity prevention liquids or any other solvent.
- Do not attach labels or stickers to discs. (Do not use discs with exposed adhesive from tape or left over peeled off stickers.)
- Do not use scratch-proof protectors or covers other than those specified for use with this player.

■ Do not place or store discs in the following places

- Locations exposed to direct sunlight
- Humid or dusty locations
- Locations directly exposed to a heat vent or heating appliance

Maintenance

To clean this unit, wipe with a soft, dry cloth.

If the surfaces are extremely dirty, use a soft cloth dipped in a soap-and-water solution or a weak detergent solution.

- Never use alcohol, paint thinner or benzine to clean this unit.
- Before using chemically treated cloth, read the instructions that came with the cloth carefully.

Specifications

Power requirements: AC 220–240 V, 50 Hz
Power consumption: 14 W
Dimensions:
DVD-RV40: 430 (W)×273 (D)×82 (H) mm (excluding protrusions)
DVD-RV20: 430 (W)×269 (D)×82 (H) mm (excluding protrusions)
Mass: 2.9 kg
Signal system: PAL 625/50, PAL 525/60, NTSC
Operating temperature range: +5 to +35 °C
Operating humidity range: 5–90 % RH (no condensation)
Discs played:

- (1) **DVD-Video disc:**
 12 cm single-sided, single-layer
 12 cm single-sided, dual-layer
 12 cm double-sided, single-layer
 8 cm single-sided, single-layer
 8 cm single-sided, dual-layer
 8 cm double-sided, single-layer

- (2) **Compact disc (CD-DA, Video CD):**
 12 cm disc
 8 cm disc

Video output:
 Output level: 1 Vp-p (75 Ω)
 Output terminal:

	DVD-RV40	DVD-RV20
Australia and N.Z.	Pin jack (2 systems)	Pin jack (1 system)
The United Kingdom and Continental Europe	RCA (2 systems), AV1/AV2	RCA (1 system), AV

S video output:
 Y output level: 1 Vp-p (75 Ω)
 C output level:
 NTSC: 0.286 Vp-p (75 Ω)
 PAL: 0.300 Vp-p (75 Ω)
 Output terminal:
 Units for Australia and N.Z.: S terminal (1 system)
 Units for the United Kingdom and Continental Europe: S terminal (1 system)/AV1

Units for Australia and N.Z.
Component video output:

Y output level: 1 Vp-p (75 Ω)
 Ps output level: 0.7 Vp-p (75 Ω)
 Pr output level: 0.7 Vp-p (75 Ω)
 Output terminal: Pin jack
 (Y: green, Ps: blue, Pr: red)

Audio output:
 Output level: 2 Vrms (1 kHz, 0 dB)
 Output terminal:
DVD-RV40:

	Mixed output (L/R)	5.1ch discrete output
Australia and N.Z.	Pin jack (1 system)	Pin jack (1 system)
The United Kingdom and Continental Europe	RCA (1 system), AV1/AV2	RCA (1 system)

DVD-RV20:

	Mixed output (L/R)	Subwoofer output
Australia and N.Z.	Pin jack (1 system)	Pin jack (1 system)
The United Kingdom and Continental Europe	RCA (1 system), AV	RCA (1 system)

Audio signal output characteristics:

- (1) Frequency response:
 •DVD (linear audio): 4 Hz–22 kHz (48 kHz sampling)
 4 Hz–44 kHz (96 kHz sampling)
 4 Hz–20 kHz (EIAJ)
 •CD audio: 115 dB (EIAJ)
 (2) S/N ratio:
 •CD audio: 115 dB (EIAJ)
 (3) Dynamic range:
 •DVD (linear audio): 102 dB
 •CD audio: 98 dB (EIAJ)
 (4) Total harmonic distortion:
 •CD audio: 0.0025 % (EIAJ)

Digital audio output:
 Optical digital output: Optical terminal

DVD-RV40:
 Coaxial audio output: Pin jack

Pickup: Wave length: 665 nm
 Laser power: CLASS 2

Power consumption in standby mode: approx. 4.0 W

Note
 Specifications are subject to change without notice.
 Mass and dimensions are approximate.

This product incorporates copyright protection technology that is protected by method claims of certain U.S. patents and other intellectual property rights owned by Macrovision Corporation and other rights owners. Use of this copyright protection technology must be authorized by Macrovision Corporation, and is intended for home and other limited viewing uses only unless otherwise authorized by Macrovision Corporation. Reverse engineering or disassembly is prohibited.

Matsushita Electric Industrial Co., Ltd.
 Osaka 542-8588, Japan

En

© 2000 Matsushita Electric Industrial Co., Ltd.

VQT8633
 F0200MH1030