

## 6. DVD VIDEO SYSTEM

DVD video is a high-quality digital video source that provides crisp and clear images. One 12 cm disc contains either one film or four hours of music. The built-in 5.1 channel surround and the Dolby digital 5.1 channel surround let you enjoy a realistic sound that emulates the sound of a movie theater.

### DVD Video Features

This unit provides the following functions in addition to the high image quality and sound quality of DVD video.

#### Notes:

- The functions described in the section, "Features", for example, the recorded language, subtitles, angles, etc. differ with the DVD video disc. Refer to the instructions provided with the DVD video.
- Some disc functions may operate differently than described in this manual.

#### Multi-sound function

DVD video can store up to 8 languages for one film; select the language of your preference.

- The languages stored on the disc are indicated by the icon shown below.



#### Multi-angle function

A DVD video that is filmed from multiple angles allows you to select the angle of choice.

- The number of recorded angles are indicated by the icon shown below.



#### Subpicture (subtitles) function

A DVD video can record subtitles for up to 32 languages and you can select the language of the subtitles you wish to see.

- The number of recorded subtitle languages are indicated by the icon shown below.



#### Multi-story function

When a DVD video contains more than one story for a film, you can select the story you wish to enjoy. The operation procedures vary with the disc; observe the instructions for selecting a story provided during playback.

#### Dolby digital

Dolby digital enables up to 5.1 independent multi-channel audio reproduction, the same type of surround system that is also used in movie theaters.

#### DTS

DTS (Digital Theater System) is a sound system that differs from the Dolby digital system. DTS provides a larger amount of data than Dolby digital enabling high-quality surround playback and incorporates a DTS-CD software for music like a DVD software allows 5.1 channel independent multi-channel audio reproduction.

#### Menu screens

Menus can be called up during DVD video playback to perform menu setting.

Example showing menu display

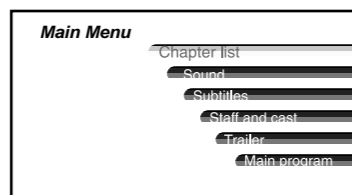

## 2. PRECAUTIONS

### WARNING

For your safety, the driver should not watch the TV or operate the controls while driving. Please note that watching and operating the TV while driving are prohibited by law in some countries. Also, while driving, keep the volume to a level at which external sounds can be heard.

- When the inside of the car is very cold and the player is used soon after switching on the heater, moisture may form on the disc or the optical parts of the player and proper playback may not be possible. If moisture forms on the disc, wipe it off with a soft cloth. If moisture forms on the optical parts of the player, do not use the player for about one hour. The condensation will disappear naturally allowing normal operation.
- Driving on extremely bumpy roads which cause severe vibration may cause the sound to skip.
- This unit uses a precision mechanism. Even in the event that trouble arises, never open the case, disassemble the unit, or lubricate the rotating parts.

This equipment has been tested and found to comply with the limits for a Class B digital device, pursuant to Part 15 of the FCC Rules. These limits are designed to provide reasonable protection against harmful interference in a residential installation. This equipment generates, uses, and can radiate radio frequency energy and, if not installed and used in accordance with the instructions, may cause harmful interference to radio communications. However, there is no guarantee that interference will not occur in a particular installation. If this equipment does cause harmful interference to radio or television reception, which can be determined by turning the equipment off and on, the user is encouraged to consult the dealer or an experienced radio/TV technician for help.

1	MODEL	<b>DVS9755z</b> Clarion
		12V  GROUND
THIS DEVICE COMPLIES WITH PART 15 OF THE FCC RULES. OPERATION IS SUBJECT TO THE FOLLOWING TWO CONDITIONS: (1) THIS DEVICE MAY NOT CAUSE HARMFUL INTERFERENCE, AND (2) THIS DEVICE MUST ACCEPT ANY INTERFERENCE RECEIVED, INCLUDING INTERFERENCE THAT MAY CAUSE UNDESIRABLE OPERATION.		
THIS PRODUCTION COMPLIES WITH FCC PART 15.21 CFR SUBCHAPTER J APPLICABLE AT DATE OF MANUFACTURE.		
Apparatus Claims of U.S. Patent Nos. 4,631,603, 4,577,216, 4,819,098, and 4,907,093 licensed for limited viewing uses only.		
Manufactured under license from Dolby Laboratories. "Dolby," "Pro Logic" and the double-D symbol are trademarks of Dolby Laboratories, Confidential Unpublished Works, © 1992-1997 Dolby Laboratories, Inc. All rights reserved.		
Manufactured under license from Digital Theater Systems, Inc. US Pat. No. 5,451,942, 5,956,674, 5,974,380, 5,978,762 and other world-wide patents issued and pending. "DTS" and "DTS Digital Surround" are registered trademarks of Digital Theater Systems, Inc. © 1996, 2000 Digital Theater Systems, Inc. All Rights Reserved.		
CLARION CO., LTD. 50 KAMITODA, TODA-SHI, SAITAMA-KEN, JAPAN.		
MANUFACTURED:		
SERIAL No.	285-0439-00	Clarion Co., Ltd.
FE-2359B		MADE IN JAPAN

### INFORMATION FOR USERS:

CHANGES OR MODIFICATIONS TO THIS PRODUCT NOT APPROVED BY THE MANUFACTURER WILL VOID THE WARRANTY AND WILL VIOLATE FCC APPROVAL.

## 3. HANDLING DISCS

To remove the disc from its storage case, press down on the centre of the case and lift the disc out, holding it carefully by the edges.

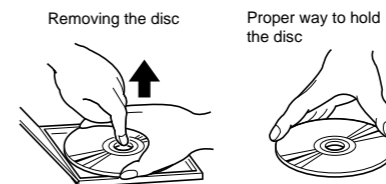

Always handle the disc by the edges. Never touch the surface.

To remove fingermarks and dust, use a soft cloth, and wipe in a straight line from the centre of the disc to the circumference.

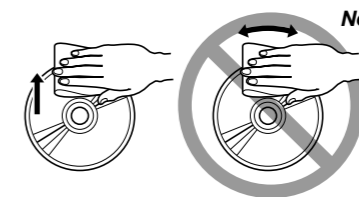

New discs may have some roughness around the edges. The unit may not work or the sound may skip if such discs are used. Use a ball-point pen, etc. to remove roughness from the edge of the disc.

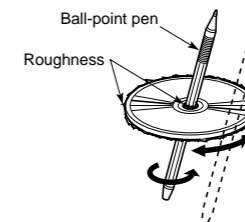

#### Note:

- Do not use commercially available disc protection sheets or discs equipped with stabilizers, etc. These may get caught in the internal mechanism and damage the disc.

#### Note on Discs

Never stick labels on the surface of the disc or mark the surface with a pencil or pen.

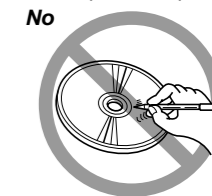

Do not use any solvents such as commercially available cleaners, anti-static spray, or thinner to clean discs.

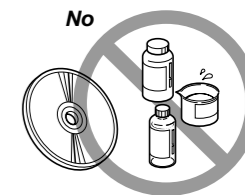

Do not use discs that have large scratches, are misshapen, or cracked, etc. Use of such discs will cause misoperation or damage.

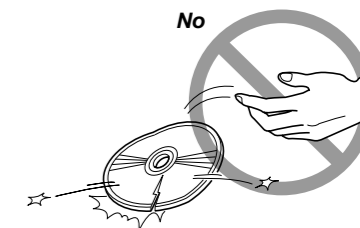

Do not expose discs to direct sunlight or any heat source.

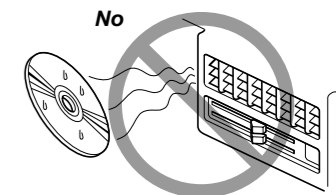

Be sure to unfold and read the next page. / Veuillez déplier et vous référer à la page suivante. / Cerciórese de desplegar y de leer la página siguiente.

## 4. CONTROLS / LES COMMANDES / CONTROLES

### Control unit / Module des touches / Unidad de control

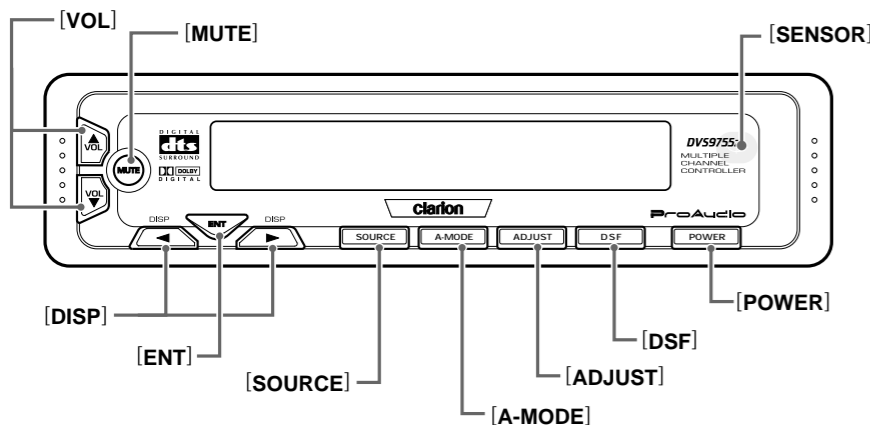

- Remote control unit
- Télécommande
- Unidad de control remoto

(These buttons are available when the cover is open.)  
(Pour pouvoir utiliser ces touches, ouvrez le couvercle.)  
(Estos botones están disponibles cuando la tapa está abierta.)

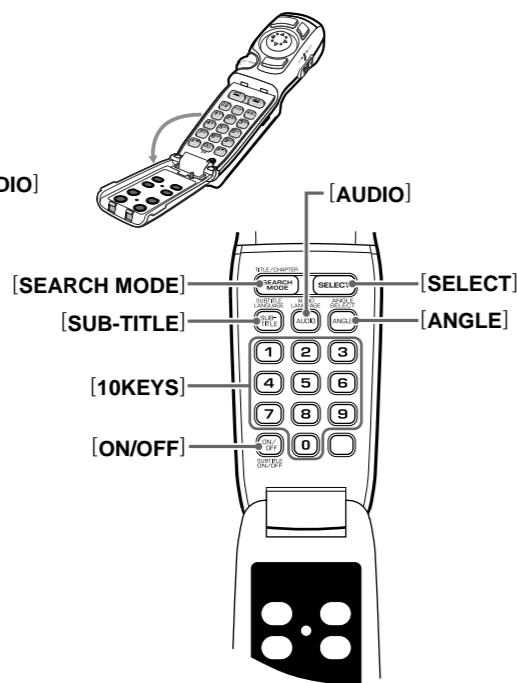
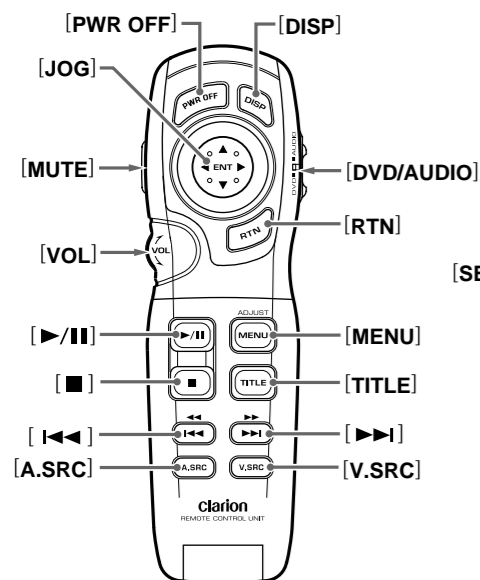

## 5. NOMENCLATURE

### Names of Buttons

#### Control Unit

**[VOL]** button:  
•Raises and lowers the volume.  
•Changes the adjustment values in the ADJUST MODE and AUDIO MODE.

**[MUTE]** button:  
•Turns off the sound.

**[DISP]** button:  
•Changes the display.  
•Changes set items in the ADJUST MODE.

**[ENT]** button:  
•Determines the adjustment setting in the ADJUST MODE.

**[SOURCE]** button:  
•Switches the input source.

**[A-MODE]** button:  
•Adjusts the volume balance in each speaker.

**[ADJUST]** button:  
•Invokes the ADJUST MODE to set speakers and other equipment.

**[DSF]** button:  
•Changes the sound characteristics in the car.

**[POWER]** button:  
•Turns the power on and off.

**[SENSOR]**: Remote control signal receiver

#### Remote Control Unit

**[PWR OFF]** button:  
•Turns off the power.

**[JOG]** button:  
•Press the top, bottom, right or left to select menu displayed on the monitor.  
•Press the center to enter the selection.

**[MUTE]** button:  
•Turns mute on and off.

**[VOL]** knob:  
•Turn the knob clockwise or counterclockwise to adjust the sound volume.

**[▶/||]** button:  
•Temporarily stops video and audio playback. Press the button once again to resume playback.

**[■]** button:  
•Stops video and audio playback.

**[◀◀]** button:  
•Locates the beginning of video or audio sections in reverse direction and performs fast reverse playback.

**[A.SRC]** button:  
•Switches audio inputs.

**[DISP]** button:

•Displays playback status of track no. or chapter no. Press the button once again to return to the original display.

**[DVD/AUDIO]** switch:\*  
•Set the switch to DVD for normal use.  
•Set it to AUDIO when the center unit is to be used.

\*When the DVD/AUDIO switch on the remote control unit is set to AUDIO, some of the functions of the remote control unit change allowing you to control some of the source unit functions.

•◀▶ of the [JOG] button:  
performs search UP/DOWN.

•▲▼ of the [JOG] button:  
increases/decreases the volume level.

•[ENT] of the [JOG] button:  
functions as the play/pause button.

•[DISP] button:  
selects the function mode.

•[MENU] button:  
functions as the mute button.

•[RTN] button:  
switches the band.

Note that when the DVD/AUDIO switch on the remote control unit is set to AUDIO, functions other than the above are not available.

Refer to the instructions provided with the remote control unit of the source unit for details.

**[RTN]** button:

•Press to return to the menu previously displayed on the monitor.

**[MENU]** button:

•Displays the menus recorded on a DVD video disc.

**[TITLE]** button:

•Displays the title menus recorded on a DVD video disc.

**[▶▶]** button:

•Locates the beginning of video or audio sections in the forward direction and performs fast forward and slow playback.

**[V.SRC]** button:

•Switches video inputs.

\*When the power of this unit is turned off, the unit returns to the video mode of the DVD video player.

(These buttons are available when the cover is open.)

**[SEARCH MODE]** button:

•Locates beginning of a section using title and chapter numbers.

**[SUB-TITLE]** button:

•Switches the language of the subtitles.

**[10KEYS]** button:

•Enters numbers.

**[ON/OFF]** button:

•Turns the subtitle display on and off.

**[SELECT]** button:

•Finalizes a numeric entry.

**[ANGLE]** button:

•Switches the view angle when (2/1) is displayed.

**[AUDIO]** button:

•Switches languages.

### Control Unit Display

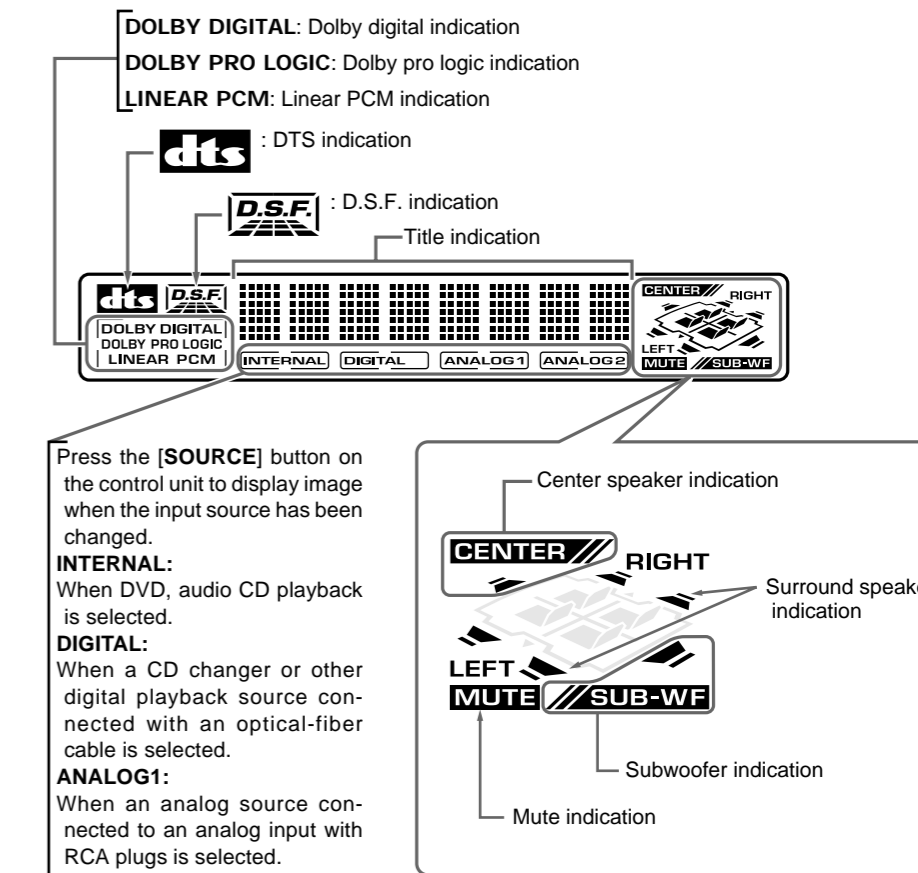

Press the [SOURCE] button on the control unit to display image when the input source has been changed.

**INTERNAL:**  
When DVD, audio CD playback is selected.

**DIGITAL:**  
When a CD changer or other digital playback source connected with an optical-fiber cable is selected.

**ANALOG1:**  
When an analog source connected to an analog input with RCA plugs is selected.

**ANALOG2:**  
When an analog source connected to an analog input with a CeNET cable is selected.

## Discs

### Playable discs

This DVD video player can play the following discs.

Playable disc	Disc size and playback time
DVD video discs 	Audio+video(MPEG-2 format) 12cm:133minutes to 484minutes 8cm:41minutes to 150minutes
Audio CDs 	Audio 12cm:74minutes 8cm:20minutes

### Discs that cannot be played back

This DVD video player cannot play back DVD-R, DVD-RAM, Photo CDs and Video CDs. It may also not be possible to play back CDs recorded on a CD-R unit. CD discs recorded on a CD-RW unit cannot be played back.

See "ERROR DISPLAY" for information on any error message that may be displayed during operation.

### Note on region numbers

The DVD video system assigns a region number to DVD video players and DVD discs by sales area. DVD video players sold in the United States can play back DVD discs with the region number "ALL", "1" or any combination of numbers that also incorporate a "1".

The DVD video region number is marked on the disc jacket as shown below.



### TV color system

This DVD player plays NTSC discs only and cannot be used for playback of PAL or SECAM discs.

## Speaker system

We recommend that you use the type of speaker system described below to fully enjoy the surround function of a DVD video disc system. However, audio CDs do not output any signals to the center speaker and the sub woofer, so you will only hear sound from the front and rear speakers. Contact your dealer for further details.

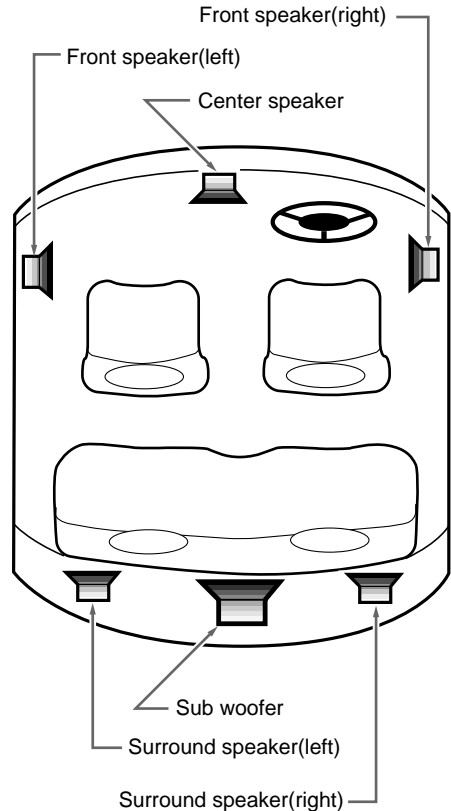

To fully enjoy the audio capability of DVD video, change the initial settings made at shipment as described in the Section, "Changing Settings" (on page20 to page21).

## About the registered marks etc.

• This product incorporates copyright protection technology that is protected by method claims of certain U.S. patents and other intellectual property rights owned by Macrovision Corporation and other rights owners. Use of this copyright protection technology must be authorized by Macrovision Corporation, and is intended for home and other limited viewing uses only unless otherwise authorized by Macrovision Corporation. Reverse engineering or disassembly is prohibited.

• Manufactured under license from Dolby Laboratories.

“Dolby”, “Pro Logic” and duple-D symbol are trademarks of Dolby Laboratories. Confidential Unpublished Works. ©1992-1997 Dolby Laboratories, Inc. All rights reserved.

• Manufactured under license from Digital Theater Systems, Inc. US Pat. No. 5,451,942, 5,956,674, 5,974,380, 5,978,762 and other world-wide patents issued and pending.

“DTS” and “DTS Digital Surround” are registered trademarks of Digital Theater Systems, Inc. © 1996, 2000 Digital Theater Systems, Inc. All Rights Reserved.

## Remote control

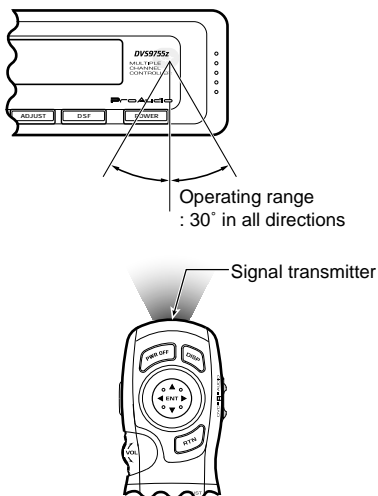

### Replacing the batteries

1. Open the rear battery cover.

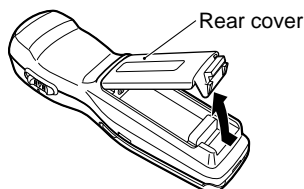

2. Insert the two supplied size AAA batteries orienting the plus and minus poles of the batteries as shown by the ⊕ and ⊖ symbols inside the battery compartment. Close the battery cover.

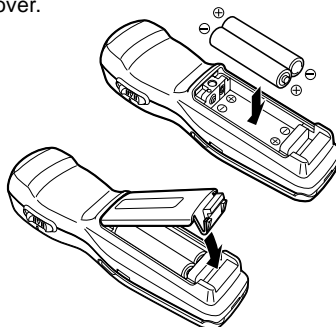

### Notes:

Using batteries improperly can cause them to explode. Take note of the following points:

- When replacing batteries, replace both batteries with new ones.
- Do not short-circuit, disassemble or heat batteries.
- Do not dispose of batteries into fire or flames.
- Dispose of spent batteries properly.

# 7. OPERATION

## Basic Operations

**Note:** Be sure to read this chapter referring to the front diagrams of chapter "4. CONTROLS" on page 5 (unfold).

### ⚠ CAUTION

Be sure to lower the volume before switching off the unit power or the ignition key. The unit remembers its last volume setting. If you switch the power off with the volume up, when you switch the power back on, the sudden loud volume may hurt your hearing and damage the unit.

### Turning on/off the power

#### Note:

• Be careful about using this unit for a long time without running the engine. If you drain the car's battery too far, you may not be able to start the engine and this can reduce the service life of the battery.

1. Press the [POWER] button.
2. The settings are displayed on the control unit display.
3. Press the [POWER] button to turn off the power.

### Switching input source

Change the settings to suit the input signal source.

- The initial setting is [INTERNAL].

Press the [SOURCE] button.

Each time the [SOURCE] button is pressed, the indications change as shown below.

[INTERNAL] → [DIGITAL] → [ANALOG1] → [ANALOG2] → [INTERNAL]

- The original mode is resumed when the button is not pressed during a 7 second interval.

#### ●INTERNAL (Internal):

Use this setting for playing back DVD videos and CDs.

#### ●DIGITAL (Digital):

Use this setting when playing back CD changer media or other digital input sources connected using an optical-fiber cable.

#### ●ANALOG1 (Analog1):

Use this setting when playing back an analog input source connected using RCA plugs.

#### ●ANALOG2 (Analog 2):

Use this setting when playing back an analog input source connected using a CeNET cable.

### Adjusting the sound volume

### ⚠ CAUTION

The sound volume on a DVD video disc can become very loud. For that reason, turn up the sound volume gently when the video image is displayed.

Press the [VOL] buttons on the control unit.



:increases the sound volume.



:decreases the sound volume

You can also turn the [VOL] knob on the remote control unit clockwise or counterclockwise.



:increases the sound volume.

:decreases the sound volume

### Changing display settings

Press the [◀] or [▶] [DISP] button.

Each time the [◀] or [▶] [DISP] button are pressed, the indications change as shown below.

[PROGRAM] → [SS 1] → [SS 2] → [DISP OFF] → [PROGRAM] →

#### ●PROGRAM (Program):

Displays the sound system used for the DVD video disc.

## Basic Operations

- **MONO**: monaural sound
- **STEREO**: stereo sound
- **2/1**: 2 front channels, surround monaural
- **2/2**: 2 front channels, 2 channel surround sound
- **3/0**: sound via the 3 front channels
- **3/1**: 3 front channels, surround monaural sounds
- **3/2**: 3 front channels, 2 channel surround sound
- **3/2 LFE**: 3 front channels, 2 surround channels and sub woofer sound.

### ●SS1: displays a dolphin.

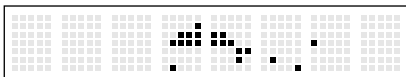

### ●SS2: Displays "CLARION" being scrolled across the display.

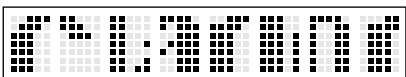

### ●DISP OFF: the display is off.

## DSF setting

DSF (Digital Sound Field) makes it possible through sound simulation to enjoy the acoustic experience you would have in a concert hall or a live performance hall.

- The initial setting is **[DSF OFF]**.

1. Press the **[DSF]** button.

Each time the **[DSF]** button is pressed, the indications change as shown below.

**[DSF OFF]** → **[HALL]** → **[CHURCH]** → **[STADIUM]** → **[LIVE]** → **[JAZZCLUB]** → **[THEATER]** → **[DSF OFF]**

- The original mode is resumed when the button is not pressed during a 7 second interval.
- **HALL**(Hall):Large concert hall.
- **CHURCH**(Church):Church with a vaulted ceiling.
- **STADIUM**(Stadium):Large stadium without roof or walls.
- **LIVE**(Live):Live performance hall, larger than a jazz club.

- **JAZZCLUB**(Jazzclub):Jazz club with a low ceiling.
  - **THEATER**(Theater):Movie or drama theatre.
2. When the **[DSF]** button is held down for 2 seconds, the original mode is resumed.

## Adjusting the sound volume balance of each speaker (AUDIO MODE)

You can adjust the sound image to suit the seating position and number of passengers.

Press the **[A-MODE]** button.

Each time the **[A-MODE]** button is pressed, the indications change as shown below.

**[SW]** → **[CTR]** → **[BAL]** → **[FAD]** → original mode

- The original mode is resumed when the button is not pressed during a 7 second interval.

### ●SW (Sub woofer):

Adjusts sub woofer volume.

The volume is adjusted in the range -6 to +3.

### ●CTR (Center speaker):

Adjusts center speaker volume.

The volume is adjusted in the range -6 to 0.

### ●BAL (Balance):

Adjusts the sound volume in the left and right speakers.

The sound volume is adjusted in the range L13 to R13.

### ●FAD (Fader):

Adjusts the sound volume in the front and rear speakers.

The sound volume is adjusted in the range R12 to F12.

## Mute

Each time you press the **[MUTE]** button, mute is turned on and off.

"**MUTE**" appears when mute is turned on.

# DVD Operations

The operations described in this chapter are performed using the remote control buttons.

## Replacing discs

- Slide the door downwards until a clicking sound is heard. The disc is now automatically ejected.

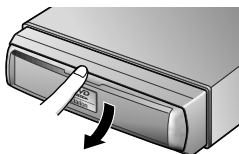

- If the disc is left as is and not removed, it will automatically be retracted into the unit after 15 seconds.
- Insert the DVD video disc in the slot with the label side upwards. When the disc has been inserted halfway, it is automatically pulled inside the unit.
    - When an inserted DVD video disc is not to be automatically played back, press the [▶/||] button.
    - When playing back a double-sided DVD video disc, insert the disc with the top side up, play it back entirely. Then take out the disc and turn it over to play the other side. (The top and back side of a DVD video disc are marked differently on different discs.)
    - Dirt or dust on the data surface may generate read errors. Wipe the disc with a soft cloth before insertion. If errors still occur, remove the disc.
  - Close the door.



- Keep the door closed at all times to prevent dust from entering the unit.

### Note:

- Do not close the door before an ejected DVD video disc has been removed. Should the door be closed without first removing the DVD video disc, the disc will not be ejected and may also be damaged.

## Playing back discs

Press the [▶/||] button to start playback. Pressing the [▶/||] button again stops playback.

- When a menu is displayed, select the desired item in step 2 of the following section, "Selecting menus".

## Selecting menus

- When the [MENU] button is pressed during playback, the DVD video menu is displayed.

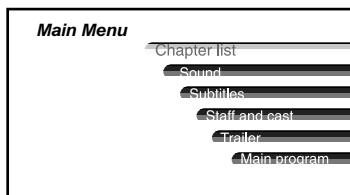

- Press the top or bottom of the [JOG] button to select an item and then press the center of the [JOG] button.

Or, use the [10KEYS] buttons to select the item and press the [SELECT] button.

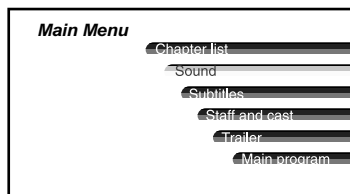

- Note that some DVD video discs do not allow you to select items using the [10KEYS] buttons.
- [JOG] button operations differ with the type of menu used on the disc.
- Also the type of menus that are displayed varies with the DVD video disc.

## Stopping playback

Press the [■] button to stop playback.

- Press the [▶/||] button to start playback from the location where playback was previously stopped.
- When the [■] button is pressed once again after the disc has been stopped and the [▶/||] button is also pressed, the DVD video disc is played back from the beginning.

## DVD Operations

### Pausing playback

Press the [▶/||] button to pause playback. Normal playback is resumed when the [▶/||] button is pressed again.

- The disc is played back at 1/2 normal speed when the [▶/||] button is pressed while disc playback is paused.

### Slow playback

The disc is played back at 1/2 normal speed while the [▶▶] button is held down in pause mode.

- Slow playback cannot be performed in reverse direction. The sound is muted during slow playback.

### Skipping chapters/tracks (To locate the beginning of a track or chapter)

Press the [▶▶] or [◀◀] button during playback. Chapters or tracks corresponding to the number of presses are skipped and playback is resumed.

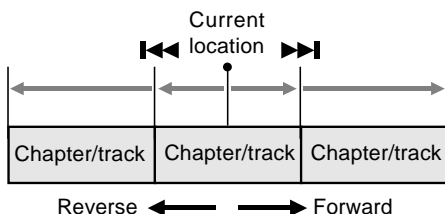

- Press the [▶▶] button to start playback from the beginning of the next chapter or track.
- Press the [◀◀] button to start playback from the beginning of the current chapter or track.

When this button is pressed again within 1 sec, playback starts from the beginning of the previous chapter or track.

- **Chapter:**

DVD video data is divided into smaller sections (chapters).

- The menu may be displayed again when the [▶▶] or [◀◀] button is pressed.

### Fast forward/fast backward

Hold down the [▶▶] or [◀◀] button during playback.

When one of these two buttons are held down, the speed increases after 1 sec. Normal playback speed is resumed when the button is released.

- The sound is muted during fast forward and fast reverse playback.
- The [▶▶] and [◀◀] buttons are also used to locate the beginning of a section. When one of these buttons is held down for 1 sec or less, the beginning of a section is located and playback starts from there.
- Some buttons are not available depending on the DVD video story. The speed of fast forward/backward depends on the disc.
- The menu may be displayed again when the [▶▶] or [◀◀] button is pressed.

### Locating the beginning of a section using title and chapter numbers

This function is used to locate the beginning of a section using the title numbers and chapter numbers recorded on a DVD video disc.

1. Press the [SEARCH MODE] button during playback to display title number input ([T\*\*]). Each press of the button toggles the display between title number input ([T\*\*]) and chapter number input ([C\*\*\*]).

- **Title**

DVD video data is divided into larger sections (titles).

- **Chapter**

DVD video data is divided into smaller sections (chapters).

2. Use the [10KEYS] buttons to enter the number of the title or chapter you wish to play back.
  - The following error message is displayed when a non-existing title number is entered or when the beginning of a section cannot be located using a title number.

INVALID

3. Press the [SELECT] button to start playback from the entered title number or chapter number.



## Using title menus

A DVD disc containing multiple titles can be played back by selecting the desired title from the title menu.

1. Press the **[TITLE]** button during playback to display the title menu.
  - Some DVD video discs do not allow you to display titles using the **[TITLE]** button.
  - Press the **[TITLE]** button again to resume playback from scene where the **[TITLE]** button was pressed.
2. Select items by pressing the top, bottom, right or left of the **[JOG]** button or enter a number using the **[10KEYS]** buttons.
  - The movement of selected items using the **[JOG]** button depends on the disc. Selections using the **[10KEYS]** button also vary with the DVD video disc.
  - Note that some DVD video discs do not allow you to select items using the **[10KEYS]** buttons.
3. Press the center of the **[JOG]** button to enter the selection.

## Selecting a language

A DVD video that contains multiple sound recordings and languages allows you to select a language during playback.

Press the **[AUDIO]** button during playback to change the language.

- Some DVD video discs contain up to 8 languages. Check the disk symbol (Ⓢ): indicates 8 languages).
- When the power is turned on or a DVD video disc is replaced, the disc is played back in the default language. When the selected language is not on the DVD disc, a language on the disc is selected.
- Some DVD video discs do not allow you to change languages at all or not change languages for specific scenes.
- Changing from one language to another may take some time.

## Selecting an angle

A DVD disc where scenes have been recorded from different camera angles allows you to select the desired angle during playback.

Press the **[ANGLE]** button during playback to change the angle.

The angle changes at each press of the button.

- Some DVD video discs record up to 9 different angles. Check the disk symbol (Ⓜ): indicates 2 angles).
- The change between different angles may be smooth on some DVD video discs while on others a still picture is first displayed.
- Some DVD video discs do not allow you to change angles at all or not change angles for specific scenes.
- It may take some time before playback starts from the selected angle.
- Some DVD video discs may play back scenes recorded from multiple angles.

## Turning subtitle display ON/OFF

Press the **[ON/OFF]** button during playback to turn on (subtitle display) or off (no subtitles) this function.

- Some DVD video discs do not turn off the subtitles even when the OFF (no subtitles) setting is selected.

## Changing subtitle language display

A DVD video that contains multiple subtitle languages allows you to select a subtitle language during playback.

Press the **[SUB-TITLE]** button during playback to change the subtitle language.

- Some DVD video discs contain subtitles in up to 32 languages. Check the disk symbol (Ⓜ): indicates subtitles in 8 languages).
- Some DVD video discs do not allow you to change subtitle languages at all or not change the subtitle language for specific scenes.
- Changing from one subtitles in language to another may take some time.



## CD Operations

The operations described in this chapter are performed using the remote control buttons.

### Replacing discs

- Slide the door downwards until a clicking sound is heard.

The disc is now automatically ejected.

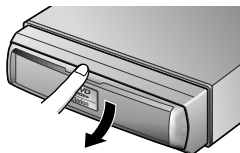

- If the disc is left as is and not removed, it will automatically be retracted into the unit after 15 seconds.
- Insert the disc in the slot with the label side upwards.

When the disc has been inserted halfway, it is automatically pulled inside the unit.

- When an inserted disc is not automatically played back, press the [▶/||] button.
  - Dirt or dust on the data surface may generate read errors. Wipe the disc with a soft cloth before insertion. If errors still occur, remove the disc.
- Close the door.
    - Keep the door closed at all times to prevent dust from entering the unit.

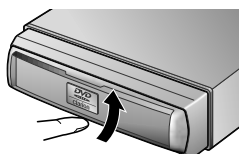

### Playing back discs

Press the [▶/||] button to start playback. Pressing the [▶/||] button again stops playback.



### Stopping playback

Press the [■] button to stop playback.

- Press the [▶/||] button to start playback from the location where playback was previously stopped.
- When the [■] button is pressed again after the disc has been stopped, the disc is played back from the beginning.

### Pausing playback

Press the [▶/||] button to pause playback. Normal playback is resumed when the [▶/||] button is pressed again.

### Skipping tracks (to locate the beginning of a section)

Press the [▶▶] or [◀◀] button during playback. The number of tracks corresponding to the number of presses are skipped and playback is resumed.

- Press the [▶▶] button to start playback from the beginning of the next track.
- Press the [◀◀] button to start playback from the beginning of the current track. When this button is pressed again within 1 sec, playback starts from the beginning of the previous track.

### Fast forward/fast backward

Hold down the [▶▶] or [◀◀] button during playback.

When one of these buttons is held down, fast forward or fast backward starts within 1 sec. Normal playback speed is resumed when the button is released.

- Intermittent sound can be heard during fast forward or fast backward playback.
- The [▶▶] and [◀◀] buttons are also used to locate the beginning of a section. When one of these buttons is held down for 1 sec or less, the beginning of a section is located and playback starts from there.

# Setting acoustic features (ADJUST MODE)

In this chapter, the control unit buttons are used.

## Selecting adjust mode settings

Adjust the settings to suit your sound system.

1. Press the **[ADJUST]** button to enter the ADJUST MODE.
2. Press the **[◀]** or **[▶]** **[DISP]** button to select item to set.

Each time the **[◀]** or **[▶]** **[DISP]** button is pressed, the indications change as shown below.

Adjust automatic sound format identification

**(FORMAT)**



Set speaker to on or off

**(SP-SEL)**



Set speaker filter frequency

**(FILTER)**



Adjust speaker output level

**(SP-GAIN)**



Set speaker delay time

**(DELAY)**



Set Dolby digital

**(Dolby D)**







Set parametric equalizer

**(P.EQ)**



Press the **[ADJUST]** button to return to the original mode.

•A flow chart is shown on the next page.

- \*1. The display shows the settings made in the Section, "Changing display settings" (11 page).
- \*2. When an  is displayed at the end of a setting, press the **[ENT]** button to enter the adjust mode.
- \*3. When the  illustration is shown, press the indicated button (the **[ENT]** button in this example).
- \*4. When  is displayed to the left of the adjusted value, press the **[◀]** or **[▶]** **[DISP]** button to switch the setting.
- \*5. When the **[VOL]** buttons are not used within 1 sec, the adjustment value display is switched.
- \*6. When  is displayed to the left of the adjusted value, press the **[▲]** or **[▼]** **[VOL]** button to switch the adjustment value.
- \*7. The next item is displayed.

Setting acoustic features (ADJUST MODE)

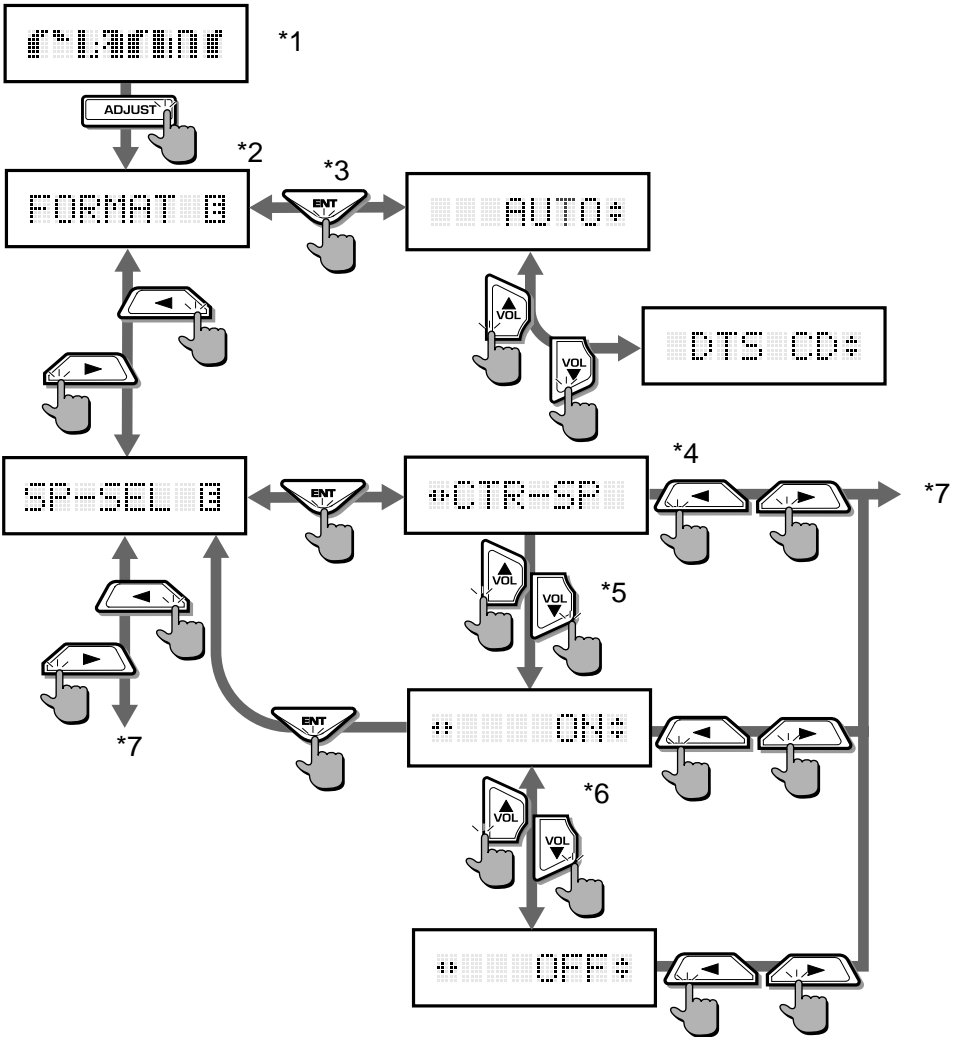

## Setting acoustic features (ADJUST MODE)

### Adjusting automatic sound format identification (FORMAT)

This function automatically identifies the sound format of the inserted disc and plays back the disc accordingly.

- The initial value is [AUTO].
1. Press the [ADJUST] button to enter the ADJUST MODE.
  2. Press the [◀] or [▶] [DISP] button to show the [FORMAT] display.
  3. Press the [ENT] button to display the adjustment item.
  4. Press the [▲] or [▼] [VOL] button to select [AUTO] or [DTS CD].
    - **AUTO**: Dolby and DTS format discs are automatically detected.
    - **DTS CD**: select this mode when a DTS CD cannot be played back in [AUTO] mode.

#### Note:

• When a DTS DVD or CD disc are played back in [AUTO], some noise may be generated until the DTS signal is detected. When this happens, you can use the [DTS CD] setting to avoid noise.

5. Press the [ADJUST] button to return to the original mode.

### Turning speakers on or off (SP-SEL)

The center speaker, surround speakers and sub woofer have to be set to on or off to achieve maximum sound quality.

- The initial value is [ON].
1. Press the [ADJUST] button to enter the ADJUST MODE.
  2. Press the [◀] or [▶] [DISP] button to change to the [SP-SEL] display.
  3. Press the [ENT] button to display the adjustment item.
 

Press the [◀] or [▶] [DISP] button to select [CTR-SP], [SRD-SP] or [SUB-WF].

    - **CTR-SP**: center speaker
    - **SRD-SP**: surround speaker
    - **SUB-WF**: subwoofer
  4. Press the [▲] or [▼] [VOL] button to select [ON] or [OFF].
    - **ON**: Speaker installed
    - **OFF**: Speaker not installed
    - When a sub woofer is used, set [ON+], [ON-] or [OFF]. The normal setting is [ON+],

but use the [ON-] setting when this provides a better effect for low frequency range.

5. Press the [ADJUST] button to return to the original mode.

### Adjusting speaker output level (SP-GAIN)

Use the built-in test tone function of the unit to adjust the speaker output level to the same level.

- The initial value is [0 dB].
  - A speaker that was turned off in the Section, "Turning speakers on or off" is not displayed.
1. Press the [ADJUST] button to enter the ADJUST MODE.
  2. Press the [◀] or [▶] [DISP] button to change to the [SP-GAIN] display.
  3. Press the [ENT] button to display the adjustment item.
    - In the adjustment mode, the test tone is output from the selected speaker.
  4. Press the [◀] or [▶] [DISP] button to select the speaker to adjust.
    - Each time the [DISP] button is pressed, the indications change as shown below.

**FRONT-L**: front left speaker

**CENTER**: front center speaker

**FRONT-R**: front right speaker

**R-SRD**: right surround speaker

**L-SRD**: left surround speaker

**SUB-WF**: rear subwoofer

5. Press the [▲] or [▼] [VOL] button to adjust the gain.
  - The adjustment range is -10 dB to +6 dB.
  - Holding down the [▲] or [▼] [VOL] button to increase or decrease the value in a fast forwarding way.

#### Note:

- The sound may become distorted if the level is set too high. Should this happen, lower the level.
6. Press the [ADJUST] button to return to the original mode.

### Adjusting speaker delay time (DELAY)

The timing when the sound of each speaker reaches the listening position depends on speaker installation and the size of the car. Adjust the delay time of each speaker so that the

## Setting acoustic features (ADJUST MODE)

sound of all speakers reach the listening position at the same time as the sound from the front speakers.

- The initial value is [0 ms].
  - The delay time setting is a Dolby digital and Dolby surround function.
  - A speaker that was turned off in the Section, "Turning speakers on or off" is not displayed.
1. Press the [ADJUST] button to enter the ADJUST MODE.
  2. Press the [◀] or [▶] [DISP] button to change to the [DELAY] display.
  3. Press the [ENT] button to display the [CTR-SP].
  4. Press the [◀] or [▶] [DISP] button to select the speaker to adjust.
    - **CTR-SP**: center speaker
    - **SRD-SP**: surround speaker
  5. Press the [▲] or [▼] [VOL] button to adjust the delay time.
    - The [CTR-SP] adjustment range is 0 to 5 ms.
    - The [SRD-SP] adjustment range is 0 to 15 ms.
    - Holding down the [▲] or [▼] [VOL] button to increase or decrease the value in a fast forwarding way.
  6. Press the [ADJUST] button to return to the original mode.

### Setting speaker filter frequency (FILTER)

This function is used to set a filter frequency that suits the frequency characteristics of the used speakers.

- The initial value is [THRGH] (no filter).
  - A speaker that was turned off in the Section, "Turning speakers on or off" is not displayed.
1. Press the [ADJUST] button to enter the ADJUST MODE.
  2. Press the [◀] or [▶] [DISP] button to change to the [FILTER] display.
  3. Press the [ENT] button to display the [F HPF].
  4. Press the [◀] or [▶] [DISP] button to select the speaker to adjust.
    - **F HPF**: high pass filter for front speakers
    - **CTR HPF**: high pass filter for the center speaker

- **SRD HPF**: high pass filter for the surround speakers
  - **SW LPF**: low pass filter for the subwoofer
5. Press the [▲] or [▼] [VOL] button to select the frequency.
    - In case of [F HPF], [CTR HPF] and [SRD HPF], the frequency is 50 Hz, 80 Hz, 120 Hz and THRGH (no filter).
    - In case of [SW HPF], the frequency is 50 Hz, 80 Hz or 120 Hz.
  6. Press the [ADJUST] button to return to the original mode.

### Setting the Dolby digital functions (Dolby D)

The Dolby digital functions consist of the Dolby Pro Logic on/off function and dynamic range compression switching.

These functions are only available on Dolby digital DVD discs.

- The Dolby Pro Logic function (**Dolby PL**) can process four channel sound (right, left, front, center, monaural surround) recorded in a 2-channel encoded source and decode it in its original 4 channel format.
  - Dynamic range compression function (**D-RANGE**):
    - This function compresses the dynamic range of Dolby digital to maintain low level sounds such as actor conversation and suppress loud sound volumes.
1. Press the [ADJUST] button to enter the ADJUST MODE.
  2. Press the [◀] or [▶] [DISP] button to change to the [Dolby D] display.
  3. Press the [ENT] button to display the [D-RANGE].
  4. Press the [◀] or [▶] [DISP] button to select [D-RANGE] or [Dolby PL].
  5. Press the [▲] or [▼] [VOL] button to select the adjustment value.
    - In [D-RANGE], settings are switched between [MAX], [STD] and [MIN]. The initial value is [MAX].
      - **MAX**: maximum dynamic range mode of the original source
      - **STD**: recommended mode for standard listening
      - **MIN**: the most compressed dynamic range mode that renders even low sounds easy to hear.

## Setting acoustic features (ADJUST MODE)

- This button is used to turn [Dolby PL] mode [ON] and [OFF].
6. Press the [ADJUST] button to return to the original mode.

## Setting parametric equalizer (P.EQ)

The parametric equalizer function allows you to adjust the frequency characteristics to suit the car.

- The initial value provides the following settings for all speakers.  
FREQ = 1kHz, Q = 1, GAIN = 0dB
1. Press the [ADJUST] button to enter the ADJUST MODE.
  2. Press the [◀] or [▶] [DISP] button to change to the [P.EQ] display.
  3. Press the [ENT] button to display [EFFECT].
  4. Press the [◀] or [▶] [DISP] button to select the adjustment value.
    - **EFFECT**: turns P.EQ on or off.
    - **SIGNAL**: selects the adjustment signal.
      - **P-NOIS**: set when pink noise is to be used
      - **MUSIC**: set to use music signals
    - **SP-SEL**: selects the speakers whose P.EQ value is to be adjusted.
      - **FRONT**: front speaker
      - **CENTER**: center speaker
      - **SRD**: surround speaker
    - **BAND**: selects the frequency band (Band 1 to 3) to adjust.
    - **FREQ**: selects the frequency for bands 1 to 3.
      - The range of adjustments is from 20 Hz to 20 kHz.
      - Holding down the [▲] or [▼] [VOL] button to increase or decrease the value continuously.
    - **Q**: sets the Q curve.
      - Larger numbers produce a sharper Q characteristics curve while smaller numbers produce gentler characteristics. Adjustments are made in the range Q1 to Q20.
      - Holding down the [▲] or [▼] [VOL] button to increase or decrease the value continuously.

- **GAIN**: adjusts the output level.
    - Adjustments are made in the range -12 dB to +12 dB.
    - Holding down the [▲] or [▼] [VOL] button to increase or decrease the value continuously.
5. Press the [▲] or [▼] [VOL] button to select the adjustment value.
  6. Press the [ADJUST] button to return to the original mode.



## Making menu language and other settings

This setting menu is displayed on the monitor. The menu can be selected using the supplied remote control unit.

### Selecting monitor menus

1. Press the [■] button to pause playback.
2. Press the [MENU] button to display the main menu.
3. Press the top or bottom of the [JOG] button and select the menu.
4. Press the center of the [JOG] button to display the submenu.
  - Use the top and bottom of the [JOG] button to select items in the submenu.

(Main menu)

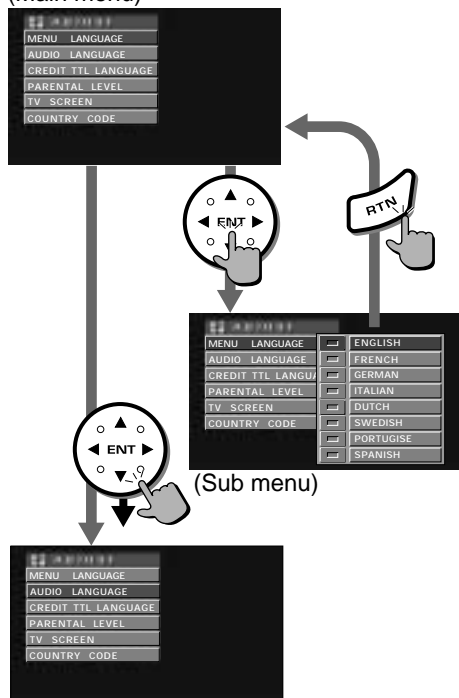

### Setting the menu language

The DVD video menus can be displayed in the language of your choice.

1. Display the [MENU LANGUAGE] submenu according to steps 1 to 4 in the Section, "Selecting monitor menus".
2. Press the top or bottom of the [JOG] button to select a language.



3. Press the center of the [JOG] button to enter the selection.
4. Press the [RTN] button twice to return to the original playback mode.

### Selecting audio language

You can select the language you normally use from the languages recorded on the DVD video to play back the disc in that language.

1. Display the [AUDIO LANGUAGE] submenu according to steps 1 to 4 in the Section, "Selecting monitor menus".
2. Press the top or bottom of the [JOG] button to select a language.
  - This language is the same as the [MENU LANGUAGE].
3. Press the center of the [JOG] button to enter the selection.
4. Press the [RTN] button twice to return to the original playback mode.

### Setting Credit TTL language

The DVD video subtitles can be displayed in the language you normally use.

1. Display the [CREDIT TTL LANGUAGE] submenu according to steps 1 to 4 in the Section, "Selecting monitor menus".
2. Press the top or bottom of the [JOG] button to select a language.
  - This language is the same as the [MENU LANGUAGE].
3. Press the center of the [JOG] button to enter the selection.

## Making menu language and other settings

- Press the [RTN] button twice to return to the original playback mode.

### Setting parental level

The parental level is a function that allows you to restrict the viewing of certain contents. Make this setting in conjunction with the Country code setting. When a DVD video with a parental lock is played back, violent scenes, etc. that you do not want your children to watch are skipped in playback.

- Display the [PARENTAL LEVEL] submenu according to steps 1 to 4 in the Section, "Selecting monitor menus".
- Press the top or bottom of the [JOG] button to select level 1 to 7.
  - Larger numbers indicate a stricter parental level setting.

The relationship between DVD video category codes and parental level are shown in the table below. Use this table when setting the parental level.

<b>LEVEL7</b>	NC-17 (NO ONE 17 AND UNDER ADMITTED)
<b>LEVEL6</b>	R (RESTRICTED)
<b>LEVEL4</b>	PG-13 (PARENTS STRONGLY CAUTIONED)
<b>LEVEL3</b>	PG (PARENTAL GUIDANCE SUGGESTED)
<b>LEVEL1</b>	G (GENERAL AUDIENCES)

- The contents that the parental level restricts varies with the country code.
- Press the center of the [JOG] button to enter the selection.
  - Press the [RTN] button twice to return to the original playback mode.

### Setting screen size

Set the size of the connected TV monitor.

- Display the [MONITOR SETTING] submenu according to steps 1 to 4 in the Section, "Selecting monitor menus".
- Press the top or bottom of the [JOG] button to select a screen size.

- Viewing on a monitor with the traditional aspect ratio (4:3)
  - PAN/SCAN:** the left and right sides are cropped

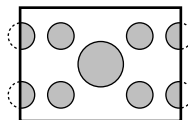

The PAN/SCAN function displays the most important part of the image on the monitor.

- LETTER:** adds a black stripe at the top and bottom of the screen.

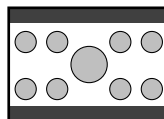

- Viewing on a wide TV monitor (16:9)
  - WIDE:**

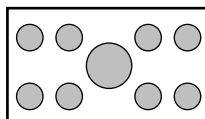

- Press the center of the [JOG] button to enter the selection.
- Press the [RTN] button twice to return to the original playback mode.

## Setting the country code

Enter the country code when the parental level function is to be used.

### Note:

- When the country code setting is changed, eject the DVD video and insert it again.

- Display the [COUNTRY CODE] submenu according to steps 1 to 4 in the Section, "Selecting monitor menus".

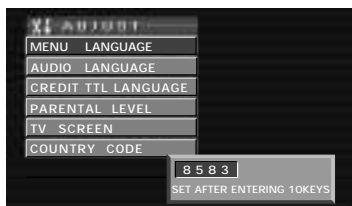

- Open the remote control unit cover.



- Press the [10KEYS] buttons to enter the country code.

### Country code list

Country	Input code
CANADA	6765
UNITED STATES	8583
AMERICAN SAMOA	6583
BERMUDA	6677
PUERTO RICO	8082
ST. PIERRE AND MIQUELON	8077
VIRGIN ISLANDS (U.S)	8673

- Press the [SELECT] button to enter the selection.
- Press the [RTN] button twice to return to the original playback mode.

## 8. IN CASE OF DIFFICULTY

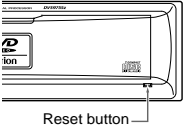
	Problem	Cause	Measure
General	Power does not turn on. (No sound is produced.)	Fuse is blown.	Replace with a fuse 3A of the same amperage. If the fuse blows again, consult your store of purchase.
		Incorrect wiring.	Consult your store of purchase.
		The microprocessor has malfunctioned due to noise, etc.	Press the reset button with a thin rod. 
DVD / CD	Nothing happens when buttons are pressed.	The microprocessor has malfunctioned due to noise, etc.	Press the reset button with a thin rod.
	Disc cannot be loaded.	Another disc is already loaded.	Eject the disc before loading the new one.
	The disc is ejected as soon as it is inserted.	The disc has been inserted upside down.	Insert the disc with the label side up.
	Sound skips or is noisy.	Disc is dirty.	Clean the disc with a soft cloth.
		Disc is heavily scratched or warped.	Replace with a disc with no scratches.
Sound is bad directly after power is turned on.	Water droplets may form on the internal lens when the car is parked in a humid place.	Let dry for about 1 hour with the power on.	

## 9. ERROR DISPLAYS

If an error occurs, one of the following displays is displayed.

Take the measures described below to eliminate the problem.

Error Display	Cause	Measure
<b>ERROR 2</b>	A DVD/CD is caught inside the DVD deck and is not ejected.	This is a failure of DVD deck's mechanism and consult your store of purchase.
<b>ERROR 3</b>	A DVD/CD cannot be played due to scratches, etc.	Replace with a non-scratched, non-warped-disc.
<b>ERROR 6</b>	A DVD/CD is loaded upside-down inside the DVD deck and does not play.	Eject the disc then reload it properly.

If an error display other than the ones described above appears, press the reset button. If the problem persists, turn off the power and consult your store of purchase.

# 10. SPECIFICATIONS

## DVD player section

System: Digital Versatile Disc System with CDDA Capable

Usable Discs: DVD Video Disc, Compact Disc  
Frequency Response: 20 Hz to 20 kHz ( $\pm 1$  dB)  
Signal to Noise Ratio: 100 dB  
Dynamic Range: 100 dB  
Distortion: 0.01% THD  
Channel Separation: 80 dB

## Audio section

S/N: 100 dB (digital input)  
100 dB (analog input)  
Frequency characteristics: 20 Hz to 20 kHz  
( $\pm 1$  dB)  
Separation: 90 dB (digital input)  
80 dB (analog input)  
High frequency distortion: 0.01% (digital input)  
0.01% (analog input)  
Analog output :4.0 Vrms (VOL Max)  
Analog input :2.0 Vrms (Max)  
Digital input :44.1 kHz sampling,  
16-bit digital audio data  
DSF : 6 modes  
P.EQ : 3 bands x 2 (front/rear independent)  
Fo; 20 Hz to 20 kHz  
1/3 octave steps  
Q; 1 to 20  
G;  $\pm 12$  dB  
Preset front; 6 types  
Rear; 7 types  
Subwoofer voltage gain; +12 dB  
(M.VOL MAX)  
LPF Fo; 50 Hz, 80 Hz, 120 Hz  
LPF slope; 12, 18, 24 dB/oct

## General

### Source unit

Power Supply Voltage:  
14.4 V DC (10.8 to 15.6 V allowable)  
Ground:Negative  
Current Consumption : Less than 3 A  
Weight: 3.5lb. (1.6 kg)  
Dimensions:  
7" Width X 2" Hight X 6-5/8" Depth  
(178 mmWidth X 50 mm Hight 165mm Depth)

## Remote control unit

Weight: 1oz. (30 g) (including battery)

Dimensions:

1-7/8" Width X 5-9/16" Hight X 1-1/4" Depth  
(47 mm Width X 142 mm Hight 32 mm Depth)

### Note:

- Specifications and design are subject to change without notice for further improvement.

## List of accessories

1. DVD disc unit ..... 1
2. Control unit ..... 1
3. Owner's manual ..... 1
4. Warranty ..... 1
5. Control unit cord ..... 1
6. Power supply harness ..... 1
7. Parts bag (1)
  - Set screws (M2.6 x 4) ..... 1
  - Cord clamps (small) ..... 1
  - Double sided tape for securing brackets ... 2
  - Cord clamps (large) ..... 3
  - Cord holders ..... 2
  - Velcro tape (large A) ..... 2
  - Velcro tape (small B) ..... 2
  - Set screws (M5 wing nuts) ..... 4
  - Installation bolts (M5 x 6) ..... 4
  - Double sided tape for securing the remote control holder ..... 1
  - Installation bolts (M5 x 6 counter sunk) .... 4
8. Parts bag (2)
  - Hook plate ..... 2
  - Spring ..... 2
  - Rubber cap ..... 1
  - Special screw ..... 1
  - Screw (M5 x 6) ..... 1
9. Bracket with bolt ..... 2
10. Main unbracket ..... 2
11. Batteries (type AAA) for remote control .... 2
12. Remote control ..... 1
13. Remote control holder ..... 1
14. Installation ..... 1
15. Universal mounting bracket ..... 1
16. Strap ..... 1
17. Outer escutcheon ..... 1

