

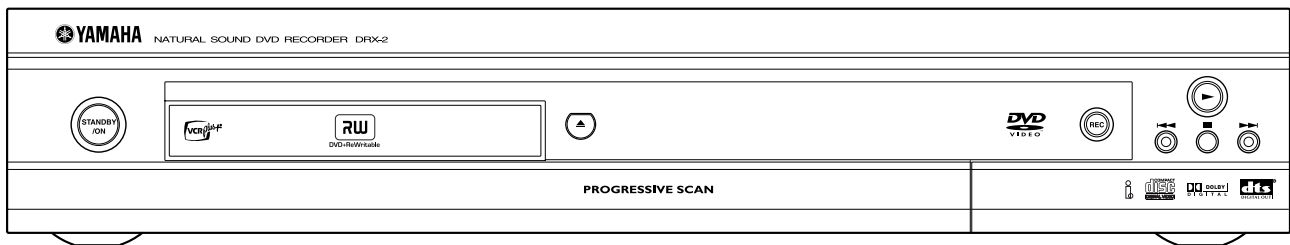

DVD Recorder
Enregistreur DVD

DRX-2

OWNER'S MANUAL
MODE D'EMPLOI



General information



This "bolt of lightning" indicates uninsulated material within your unit may cause an electrical shock. For the safety of everyone in your household, please do not remove product covering.



The "exclamation point" calls attention to features for which you should read the enclosed literature closely to prevent operating and maintenance problems.

IMPORTANT SAFETY INSTRUCTIONS

1. Read Instructions — All the safety and operating instructions should be read before the appliance is operated.

2. Retain Instructions — The safety and operating instructions should be retained for future reference.

3. Heed Warnings — All warnings on the appliance and in the operating instructions should be adhered to.

4. Follow Instructions — All operating and use instructions should be followed.

5. Cleaning — Unplug this product from the wall outlet before cleaning. Do not use liquid cleaners or aerosol cleaners. Use a damp cloth for cleaning.

Exception: A product that is meant for uninterrupted service and that for some specific reason, such as the possibility of the loss of an authorization code for a CATV converter, is not intended to be unplugged by the user for cleaning or any other purpose, may exclude the reference to unplugging the appliance in the cleaning description otherwise required in item 5.

6. Attachments — Do not use attachments not recommended by the video product manufacturer as they may cause hazards.

7. Water and Moisture — Do not use this video product near water - for example, near a bath tub, wash bowl, kitchen sink, or laundry tub, in a wet basement, or near a swimming pool, and the like.

8. Accessories — Do not place this video product on an unstable cart, stand, tripod, bracket, or table. The video product may fall, causing serious injury to a child or adult, and serious damage to the appliance. Use only with a cart, stand, tripod, bracket, or table recommended by the manufacturer or sold with the video product. Any mounting of the appliance should follow the manufacturer's instructions and should use a mounting accessory recommended by the manufacturer.

8A.  An appliance and cart combination should be moved with care. Quick stops, excessive force, and uneven surfaces may cause the appliance and cart combination to overturn.

9. Ventilation — Slots and openings in the cabinet are provided for ventilation, to ensure reliable operation of the video product, and to protect it from overheating. These openings must not be blocked or covered. The openings should never be blocked by placing the video product on a bed, sofa, rug, or other similar surface. This video product should never be placed near or over a radiator or heat register. This video product should not be placed in a built-in installation such as a bookcase or rack unless proper ventilation is provided or the manufacturer's instructions have been adhered to.

10. Power Sources — This video product should be operated only from the type of power source indicated on the marking label. If you are not sure of the type of power supply to your home, consult your appliance supplier or local power company. For video products intended to operate from battery power, or other sources, refer to the operating instructions.

11. Polarization — This product may be equipped with a polarized alternating-current line plug (a plug having one blade wider than the other). This plug will fit into the power outlet only one way. This is a safety feature. If you are unable to insert the plug fully into the outlet, try reversing the plug.

If the plug should still fail to fit, contact your electrician to replace your obsolete outlet. Do not defeat the safety purpose of the polarized plug.

12. Power-Cord Protection — Power supply cords should be routed so that they are not likely to be walked on or pinched by items placed upon or against them, paying particular attention to cords at plugs, convenience receptacles, and the point where they exit from the appliance.

13. Outdoor Antenna Grounding — If an outside antenna or cable system is connected to the video product, be sure the antenna or cable system is grounded so as to provide some protection against voltage surges and built-up static charges.

Section 810 of the National Electrical Code, ANSI/NFPA 70, provides information with regard to proper grounding of the mast and supporting structure, grounding of the lead-in wire to an antenna discharge unit, size of grounding conductors, location of antenna-discharge unit, connection to grounding electrodes, and requirements for the grounding electrode. See Fig.A.

WARNING:
TO PREVENT FIRE OR SHOCK HAZARD, DO NOT EXPOSE THIS EQUIPMENT TO RAIN OR MOISTURE.

CAUTION:
To prevent electric shock, match wide blade of plug to wide slot, and fully insert.

ATTENTION:
Pour éviter les chocs électriques, introduire la lame la plus large de la fiche dans la borne correspondante de a prise et pousser jusqu'au fond.

Fig.A.

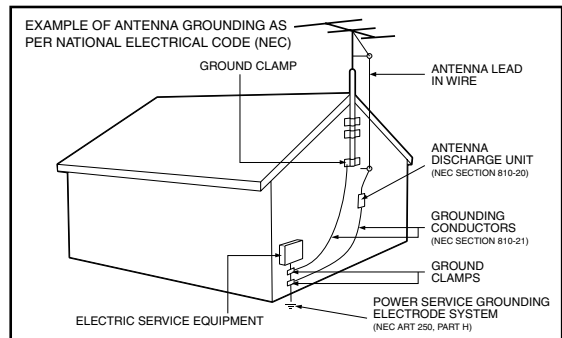

14. Lightning — For added protection for this product during a lightning storm, or when it is left unattended and unused for long periods of time, unplug it from the wall outlet and disconnect the antenna or cable system. This will prevent damage to the product due to lightning and power surges.

15. Power lines — An outside antenna system should not be located in the vicinity of overhead power lines or other electric light or power circuits, or where it can fall into such power lines or circuits. When installing an outside antenna system, extreme care should be taken to keep from touching such power lines or circuits as contact with them might be fatal.

16. Overloading — Do not overload wall outlets and extension cords as this can result in a risk of fire or electric shock.

17. Object and Liquid Entry — Never push objects of any kind into this product through openings as they may touch dangerous voltage points or short-out parts that could result in a fire or electric shock. Never spill liquid of any kind on the product.

18. Servicing — Do not attempt to service this product yourself, as opening or removing covers may expose you to dangerous voltage or other hazards. Refer all servicing to qualified service personnel.

19. Damage Requiring Service — Unplug this product from the wall outlet and refer servicing to qualified service personnel under the following conditions:

- When the power-supply cord or plug is damaged.
- If liquid has been spilled on, or objects have fallen into the product.
- If the product has been exposed to rain or water.
- If the product does not operate normally by following the operating instructions. Adjust only those controls that are covered by the operating instructions as an improper adjustment of other controls may result in damage and will often require extensive work by a qualified technician to restore the product to its normal operation.
- If the product has been dropped or the cabinet has been damaged.
- When the product exhibits a distinct change in performance - this indicates a need for service.

20. Replacement Parts — When replacement parts are required, be sure the service technician has used replacement parts specified by the manufacturer or which have the same characteristics as the original part. Unauthorized substitutions may result in fire, electric shock or other hazards.

21. Safety Check — Upon completion of any service or repairs to this product, ask the service technician to perform safety checks to determine that the product is in proper operating condition.

22. Carts and Stands — The appliance should be used only with a cart or stand that is recommended by the manufacturer.

23. Heat — The product should be situated away from heat sources such as radiators, heat registers, stoves, or other products that produce heat.

For Customer Use:

Enter below the Serial No. which is located on the rear of the cabinet. Retain this information for future reference.

Model No. **DRX-2**

Serial No. _____

Laser safety

This unit employs a laser. To prevent possible eye injury, only a qualified service person should remove the cover or attempt to service this device.

CAUTION

Use of controls or adjustments or performance of procedures other than those specified herein may result in hazardous radiation exposure.

VISIBLE AND INVISIBLE LASER RADIATION WHEN OPEN. AVOID EXPOSURE TO BEAM.

ATTENTION

L'emploi de commandes, de réglages ou un choix de procédures différents des spécifications de cette brochure peut entraîner une exposition à d'éventuelles radiations pouvant être dangereuses.

RAYONNEMENT LASER VISIBLE ET INVISIBLE EN CAS D'OUVERTURE EXPOSITION DANGEREUSE AU FAISCEAU

LASER

Type	InGaAlP semiconductor laser (DVD) AlGaAs semiconductor laser (CD)
Wavelength	660 nm (DVD) 780 nm (CD)
Output Power (out of objective)	20 mW (DVD writing) 0.8 mW (DVD reading) 0.3 mW (CD reading)
Beam divergence	82 degrees (DVD) 54 degrees (CD)

CAUTION: Visible and invisible laser radiation when open. Avoid exposure to beam.

**CLASS 1
LASER PRODUCT**



COMPLIANCE INFORMATION STATEMENT (DECLARATION OF CONFORMITY PROCEDURE)

Responsible Party : Yamaha Electronics Corporation
 Address : 6660 Orangethorpe Avenue
 Buena Park, CA90620
 Telephone : 714-522-9105
 Fax : 714-670-0108
 Type of Equipment : DVD Recorder
 Model Name : DRX-2

This device complies with Part 15 of the FCC Rules. Operation is subject to the following conditions:
 1) this device may not cause harmful interference, and
 2) this device must accept any interference received including interference that may cause undesired operation.
 See the user manual instructions if interference to radio reception is suspected.

FCC INFORMATION (for US customers)

- IMPORTANT NOTICE: DO NOT MODIFY THIS UNIT!**
 This product, when installed as indicated in the instructions contained in this manual, meets FCC requirements. Modifications not expressly approved by Yamaha may void your authority, granted by the FCC, to use the product.
- IMPORTANT:** When connecting this product to accessories and/or another product use only high quality shielded cables. Cable/s supplied with this product **MUST** be used. Follow all installation instructions. Failure to follow instructions could void your FCC authorization to use this product in the USA.
- NOTE:** This product has been tested and found to comply with the requirements listed in FCC Regulations, Part 15 for Class "B" digital devices. Compliance with these requirements provides a reasonable level of assurance that your use of this product in a residential environment will not result in harmful interference with other electronic devices. This equipment generates/uses radio frequencies and, if not installed and used according to the instructions found in the users manual, may cause interference harmful to the operation of other electronic devices. Compliance with FCC regulations does not guarantee that interference will not occur in all installations. If this product is found to be the source of interference, which can be determined by turning the product "OFF" and "ON", please try to eliminate the problem by using one of the following measures:
 Relocate either this product or the device that is being affected by the interference.
 Utilize power outlets that are on different branch (circuit breaker or fuse) circuits or install AC line filter/s.
 In the case of radio or TV interference, relocate/reorient the antenna. If the antenna lead-in is 300 ohm ribbon lead, change the lead-in to coaxial type cable.
 If these corrective measures do not produce satisfactory results, please contact the local retailer authorized to distribute this type of product. If you can not locate the appropriate retailer, please contact Yamaha Electronics Corp., 6600 Orangethorpe Ave. Buena Park, CA90620.
 The above statements apply **ONLY** to those products distributed by Yamaha Corporation of America or its subsidiaries.

THIS DIGITAL APPARATUS DOES NOT EXCEED THE CLASS B LIMITS FOR RADIO NOISE EMISSIONS FROM DIGITAL APPARATUS AS SET OUT IN THE RADIO INTERFERENCE REGULATIONS OF THE CANADIAN DEPARTMENT OF COMMUNICATIONS.

CET APPAREIL NUMÉRIQUE N'ÉMET PAS DE BRUITS RADIOÉLECTRIQUES DÉPASSANT LES LIMITES APPLICABLES DANS LA RÈGLEMENT SUR LE BROUILLAGE RADIOÉLECTRIQUES ÉDICTÉ PAR LE MINISTÈRE DES COMMUNICATIONS DU CANADA.

NOTE TO CABLE TV SYSTEM INSTALLER:

This reminder is provided to call the Cable TV (CATV) system installer's attention to Article 820-40 of the NEC (National Electrical Code) that provides guidelines for proper grounding and, in particular, specifies that the cable ground shall be connected to the grounding system of the building, as close to the point of cable entry as practical.



Simple programming system for DVD recorders. Simply enter the number code associated with your television program. This number is located in your television listings magazine.

Manufactured under license from Dolby Laboratories. "Dolby", "Pro Logic" and the double-D symbol are trademarks of Dolby Laboratories. Confidential Unpublished Works. ©1992-1997 Dolby Laboratories, Inc. All rights reserved.

"DTS" and "DTS Digital Out" are trademarks of Digital Theater Systems, Inc.

This product incorporates copyright protection technology that is protected by method claims of certain U.S. patents and other intellectual property rights owned by Macrovision Corporation and other rights owners.

Use of this copyright protection technology must be authorized by Macrovision Corporation, and is intended for home and other limited viewing uses only unless otherwise authorized by Macrovision Corporation. Reverse engineering or disassembly is prohibited.

Caution

Read this before operating your unit.

- 1 To assure the finest performance, please read this manual carefully. Keep it in a safe place for future reference.
- 2 The recommended operating temperature range for the Recorder is from 15°C-35°C (Celsius). Exceeding these ranges may cause unstable recording results. Do not expose this unit to sudden temperature changes from cold to hot, nor locate this unit in an environment with high humidity (i.e., a room with a humidifier) to prevent condensation inside this unit, which may cause an electrical shock, fire, damage to this unit, and/or personal injury.
- 3 Locate this unit away from other electrical appliances, motors, or transformers to avoid humming sounds.
- 4 Install this unit in a well ventilated, cool, dry, clean place — away from direct sunlight, heat sources, vibration, dust, moisture, or cold. In a cabinet, allow about 2.5cm (1 inch) of free space all around this unit for adequate ventilation.
- 5 Avoid installing this unit in a location where foreign objects may fall onto this unit or where this unit may be exposed to liquid dripping or splashing. On the top of this unit, do not place:
 - Other components, as they may cause damage and/or discoloration on the surface of this unit.
 - Burning objects (i.e., candles), as they may cause fire, damage to this unit, and/or personal injury.
 - Containers with liquid in them, as they may fall, spilling the liquid and causing an electrical shock to the user and/or damage to this unit.
- 6 Do not cover this unit with a newspaper, tablecloth, curtain, etc. in order not to obstruct heat radiation. If the temperature inside this unit rises, it may cause fire, damage to this unit, and/or personal injury.
- 7 Do not plug in this unit to a wall outlet until all connections are complete.
- 8 Do not operate this unit upside-down. It may overheat, possibly causing damage.
- 9 Do not use excessive force on switches, knobs and/or cords.
- 10 When disconnecting the power cord from the wall outlet, grasp the plug; do not pull the cord.
- 11 Do not clean this unit with chemical solvents; this might damage the finish. Use a clean, dry cloth.
- 12 Use only the voltage specified on this unit. Using this unit with a higher voltage than specified is dangerous and may cause fire, damage to this unit, and/or personal injury. YAMAHA will not be held responsible for any damage resulting from use of this unit with a voltage other than as specified.
- 13 To prevent damage by lightning, disconnect the power cord from the wall outlet during an electrical storm.
- 14 Do not attempt to modify or fix this unit. Contact qualified YAMAHA service personnel when any service is needed. The cabinet should never be opened for any reason.
- 15 When not planning to use this unit for long periods of time (i.e., vacation), disconnect the AC power plug from the wall outlet.
- 16 Be sure to read the "Before you call an engineer" section on common operating errors before concluding that this unit is faulty.
- 17 Before moving this unit, press STANBY/ON to set the unit in standby mode, then disconnect the AC power plug from the wall outlet.

The unit is not disconnected from the AC power source as long as it is connected to the wall outlet, even if this unit itself is turned off. This state is called the standby mode. In this state, this unit is designed to consume a very small quantity of power.

FOR CANADIAN CUSTOMERS

To prevent electric shock, match wide blade of plug to wide slot and fully insert.

This Class B digital apparatus complies with Canadian ICES-003.

This digital apparatus does not exceed the Class B limits for radio noise emissions from digital apparatus as set out in the Radio Interference Regulations of the Canadian Department of Communications.

Features

Digital Home Cinema

Introducing YAMAHA DVD recorder in your home theater environment! Dolby Digital and DTS are supported. You can enjoy super dynamic theatrical sound by connecting to AV receiver/amplifier.

Dolby Digital

Dolby Laboratories standard for transmitting 5.1 channels. Five full-value channels are transmitted in this acoustic playback system. A further channel is used for low frequencies (effects). The loudspeakers are arranged front left, front middle, front right, rear left and rear right. This system is currently the most common system and is used in cinemas. With this DVD recorder each sound track in 2-channel Dolby Digital is recorded onto a DVD+RW.

DTS digital out

Transmission standard for 5.1 channels from Digital Theatre Systems Inc. This is the second most wide-spread system after Dolby Digital.

Linear PCM Audio Recording

M1 & M2 recording modes offer high quality picture and sound enabled by linear PCM recording.

Six Recording Modes

You have six recording modes to choose from: M1, M2, M2x, M3, M4, M6. Select the one best suited for your need.

Six Hours of Recording Time

You can record up to six hours in M6 recording mode.

Fit to Space Recording

Your DVD recorder calculates the best suitable bit rates from your programmed recording time and an available disc space.



Simple programming system for DVD recorders. Simply enter the programming number associated with your television programme. You will find this number in your favorite listings magazine.

Safe Record

Normally a recording is made at the current disc position. This is the same as for a video cassette, in the middle of the tape for example. By holding down the **REC ●** button, the recording will be made at the end of all the other recordings to avoid overwriting previous recordings. New recordings on DVD+R discs are always added after all existing recordings.

Index Picture Screen

This screen tells you what's on the disc. Each index screen represents a recording. On the right hand side of the screen you can also see a disc indicator that shows the position and length of the current recording on the disc in a graphic format. You can choose and make your own index pictures from the title in playback.

EDIT

DVD makes it so easy to delete titles, split titles, insert chapters automatically and manual, and do many more things. It enables you to simply delete commercials and unwanted scenes.

Many Playable Disc Types

The following types of disc are supported: DVD-Video, DVD-R, DVD-RW, CD, SVCD, VCD, CD-R, and CD-RW.



Your DVD recorder can play back pre-recorded DVDs and CDs. DVDs recorded using this DVD recorder can be played back on current and future DVD players.

MP3-CD PLAYBACK

MP3 files are highly compressed music files. The data is compressed to 1/10 of the volume of the original audio material using a special process. This means that 10 hours of music can be stored on a single CD.

These music CDs can be played on this machine.

ID3 Tag

When playing MP3, your DVD recorder will display on TV the name of the albums, tracks, and artists if ID3 Tag information is recorded on the disc.



This connector is also known as a "FireWire" or "IEEE 1394". This connector is used to transmit wide digital broadband signals that are used for digital video camcorders. Using this connector, you can so easily capture and save video onto DVD from your digital video camera.

Table of contents

A quick preview3

The remote control.....	3
Additional TV functions.....	4
Front of the device.....	5
Back of the unit.....	6
The symbols on your DVD recorder display.....	7
Messages in the DVD recorder display.....	7

1. Introduction.....9

Common questions.....	9
Discs you can use.....	10
Regional code.....	11
Accessories.....	11
Cleaning the discs.....	11

2. Connecting your DVD recorder.....12

Preparing the remote control.....	12
Connection notes.....	12
Connecting your antenna.....	12
Connecting your TV to get the best picture.....	13
Connecting a VCR.....	15
Connecting your camcorder.....	15

3. Connecting an AV receiver ..16

Basic playback connections.....	16
Surround sound connections.....	17
Recording connections.....	18
Power supply.....	19
Switching on.....	19

4. Installing your DVD recorder.....20

Initial installation.....	20
Automatic TV channel search.....	22
Adding and clearing TV channels manually.....	23
Setting the language.....	24
Assigning the VCR Plus+® Guide channel numbers.....	25
Setting the time and date automatically.....	26
Manually setting the time & date.....	27

5. On-screen information..... 28

Symbols in the menu bar.....	28
Field for temporary messages.....	28
Status field.....	29
Tuner information box.....	30
Timer information box.....	30

6. Playback..... 31

General notes on playback.....	31
Inserting a disc.....	31
Playing a DVD video disc.....	32
Playing a DVD+RW/ +R disc.....	32
Playing an audio CD.....	33
Playing an MP3 CD.....	33
Playing a (Super) Video CD.....	34

7. Additional playback features 35

Changing to another title/chapter.....	35
Searching a disc.....	35
Still picture.....	36
Slow motion.....	36
Search by time.....	36
Repeat play.....	37
Shuffle.....	37
Scan feature.....	37
Camera angle.....	38
Zoom feature.....	38
Select the audio language.....	39
Subtitles.....	39

8. Manual recording..... 40

General.....	40
Recording without automatic switch-off.....	41
Interrupt recording (Pause).....	42
Recording with automatic switch-off (OTR one-touch-recording).....	43
Preventing accidental erasing of discs.....	44
Lining up recordings within a title (assemble cut).....	45
Selecting the recording type (Quality).....	46

9. Managing the disc contents47

General.....	47
EDIT.....	47
Editing recording titles (name).....	50
Playing the entire title.....	50
Deleting recordings/titles.....	50
Disc settings.....	51

10. Programming a recording (TIMER)53

General.....	53
Programming recordings with the VCR Plus+® System.....	54
Programming recordings without the VCR Plus+® System.....	55
How to change or delete a programmed recording (TIMER).....	56
Problem solving for programmed recordings.....	57

11. User preferences58

Picture settings.....	58
Sound settings.....	59
Language settings.....	60
Additional settings.....	60
Disc feature menu.....	61

12. Access control (Child Lock).....62

Child lock (DVD and VCD).....	62
Parental level control (DVD video only).....	63
Changing the PIN code.....	64

13. Before you call an engineer65

Appendix68





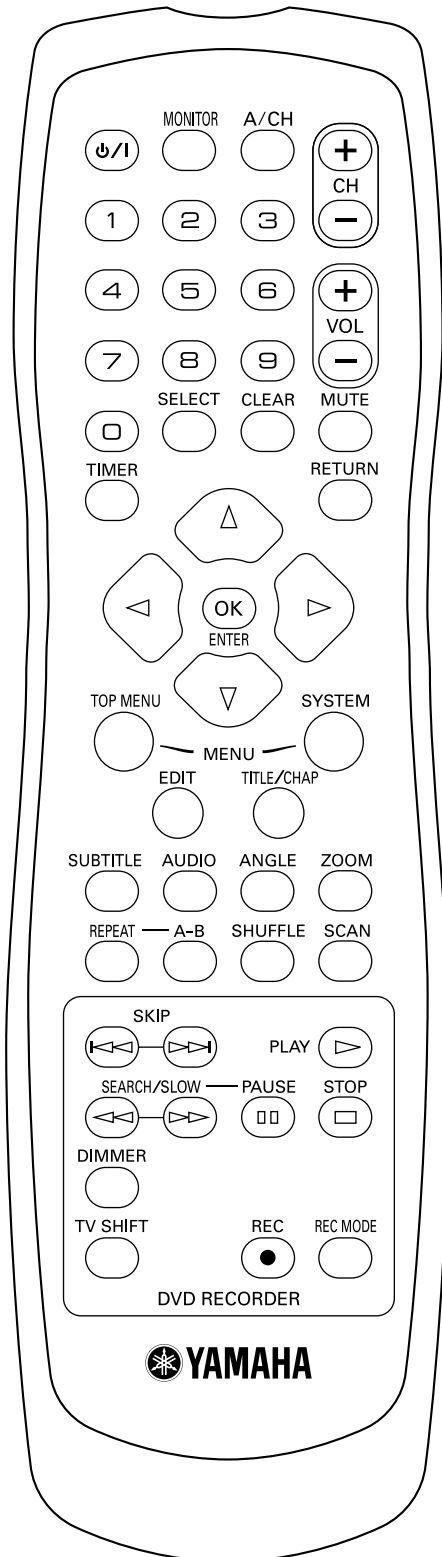

Using DRX-2 remote control for your TV set.....	68
Specifications.....	70

A quick preview

The remote control



⏻/⏻	Switch on or off: Press to switch set on or off, interrupt menu function, interrupt a programmed recording (TIMER)
MONITOR	This button lets you switch between the TV receiver (internal tuner) in the DVD recorder (TV picture on the TV set) and playback on the DVD recorder
A/CH (Alternate Channel)	Switches to the previous TV channel
CH +/-	Turns programs and inputs
0-9	Numerical key pad
VOL +/-	TV volume up/down
SELECT	Switches between different values in a menu
CLEAR	Deletes last entry/clear timer and programmed recordings
MUTE	TV Mute ON/OFF
TIMER	Press to make a TIMER programming with VCR Plus+® /without VCR Plus+® or to alter or clear a programmed TIMER
▼▲▶▶	Down/up/left/right cursor movement
ENTER/OK	Confirms menu selection
TOP MENU	Displays DVD disc menu or Index Picture Screen
EDIT	Displays Edit menu for DVD+RW or DVD+R disc
SYSTEM MENU	Displays recorder system menu bar
TITLE/CHAP	Selects title Selects chapter
SUBTITLE	Subtitle language selector
AUDIO	Audio language selector
ANGLE	Selects DVD camera angle
ZOOM	Enlarges video image
REPEAT	Repeats chapter, track, title, disc
A-B	Repeats a specific segment
SHUFFLE	Plays tracks in random order
SCAN	Playback of the first 10 seconds of each chapter within a title (DVD) or the first 10 seconds of each track on a disc (VCD/CD)
⏮ SKIP	Selects previous title/search backwards : Briefly press the button during playback: Goes to previous chapter/film or previous title Hold down the button: Searches backwards Hold down the button during still picture: Slow motion backwards

 SKIP	Selects next title/search forwards : Briefly press the button during playback: Goes to next chapter/ film or next title Hold down the button: Searches forwards Hold down the button during still picture: Slow motion forwards
 PLAY	Starts playback
 SEARCH/ SLOW	Searches backward Slow motion
 SEARCH/ SLOW	Searches forward Slow motion
 PAUSE	If this button is pressed during playback, the DVD recorder switches to pause. You will see a still picture. If this button is pressed during recording, the DVD recorder will also switch to pause.
 STOP	Stops playback/recording, except with programmed recordings (TIMER) Hold down button, opens and closes the disc tray
DIMMER	Changes brightness settings of the display
TV SHIFT	Press and hold while using other buttons to work the TV
 REC	Direct recording of the currently selected programme
REC MODE	Switches recording modes

Additional TV functions

This remote control can also operate TV set made by different manufacturers. For more information, see "Using DRX-2 remote control for your TV set".

VOL+	Increase TV volume
VOL -	Reduce TV volume For the following functions you need to hold down the button at the side TV/SHIFT and then select the function you need with the appropriate button.
 I	Turns the TV on / off
0..9	Number buttons: 0 - 9
CH+	Turns up the programme in numeric order To select a higher programme number
CH-	Turns down the programme in numeric order To select a lower programme number
MUTE	TV Mute on / off

Front of the device

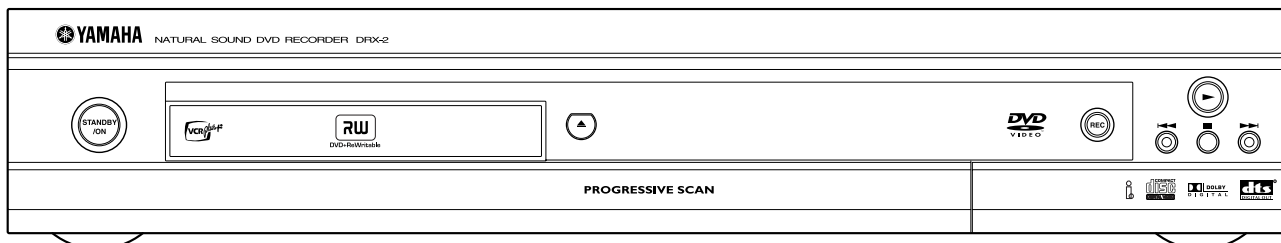

STANDBY/ON	Switches the unit on or off, interrupt a function, interrupt a programmed recording (TIMER)
▲ (Open/Close)	Open/close disc tray
REC	Records the current TV channel
▶	Plays a recorded disc
◀◀	Selects previous title/search backwards
▶▶	Selects next title/search forwards
■	Interrupt playback/recording

Auxiliary jacks on the front panel

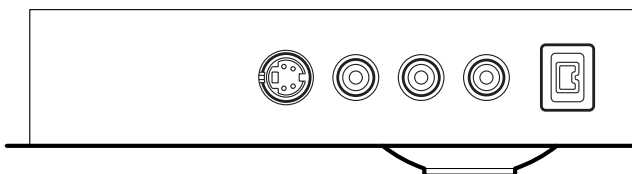

S-VIDEO	S Video jack: Connection of SVHS/Hi8 camcorders or SVHS/Hi8 video recorders (programme number "CAM1")
Yellow jack VIDEO	Video input jack: Connection of camcorders or video recorders (programme number "CAM1")
White/red jack left AUDIO right	Audio input jack left/right : Connection of camcorders or video recorders (programme number "CAM1")
DV IN	i Link/DV jack (digital video input, IEEE 1394, FireWire): Connecting a digital camcorder or other suitable device (programme number "CAM2").

Tip

Switching between the **S-VIDEO** and **VIDEO** jacks takes place automatically. If both jacks are in use, the signal at the **S-VIDEO** jack has priority.

Back of the unit

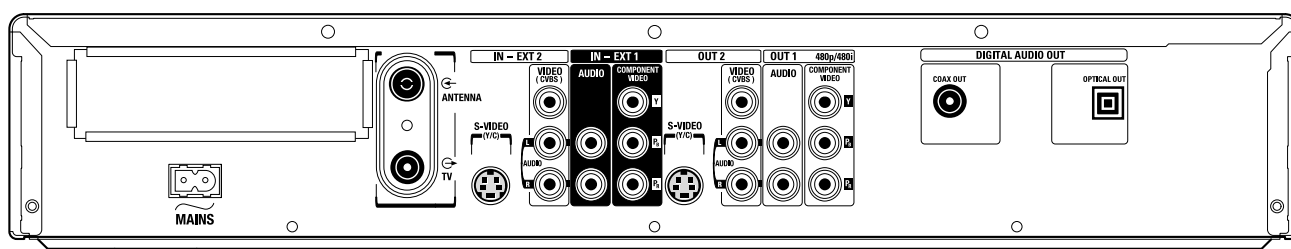

~ **MAINS** **Mains jack:** Connection to the mains supply (120V/60Hz)

ANTENNA ⚡ **Aerial input :** Connection of the aerial

TV → **Aerial output :** Connection of the TV set

Input (IN-EXT2)

S-VIDEO IN **S-Video input:** Connection for an additional device (channel number “EXT2”). Switching between jack S-VIDEO IN and Video in is done automatically.

Video in **Video input (yellow):** Connection for an additional device (channel number “EXT2”)

IN L AUDIO R **Analog audio input (red/white)** underneath jack **Video in.**
Audio for jack Video in : Connection for an additional device (channel number “EXT2”)

Input (IN-EXT1)

IN AUDIO LR **Analog audio input (red/white)** next to jack **IN COMPONENT VIDEO:** Connection for an additional device. Audio input for component video (channel number “EXT1”)

IN COMPONENT VIDEO **Component video input (red/blue/green):** Connection for an additional device with component video output (channel number “EXT1”)

Output (OUT-2)

S-VIDEO OUT **S-Video output:** Connection for a S-video-compatible TV

OUT VIDEO (CVBS) **Video output (yellow):** Connection to a TV with video input (CVBS, Composite Video)

OUT L AUDIO R **Analog audio output (red/white)** underneath jack **Video in.**
Audio for jack OUT VIDEO (CVBS) : Connection for an additional device

Output (OUT-1 480p/480i)

OUT AUDIO LR **Analog audio output (red/white):** Connection for an additional device. Audio output for component video/progressive scan

OUT COMPONENT VIDEO **Component video output (red/blue/green):** Connection for an additional device with component video/progressive scan output

Output (DIGITAL AUDIO OUT)

COAXIAL OUTPUT	Connection of a digital audio device (amplifier/receiver) using a coaxial digital cable
OPTICAL OUTPUT	Connection of a digital audio device (amplifier/receiver) using a fiber optic cable

The symbols on your DVD recorder display

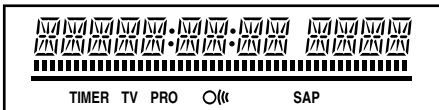

The following symbols may appear on your DVD Recorder display:



Multifunction display/text line

-) Clock
-) Disc/Title play time
-) OTR time
-) Title name
-) Display of the TV channel number / playing time / function
-) Display of information, warnings



Disc bar: Displays the current position on the disc (disc pointer).

Record: single flashing segment at the current position.

Pause: flashing segment on both sides of the current position.

Stop: flashing segment at the current position.

TIMER	A recording (Timer) has been programmed
TV	Modulator is switched off (NAFTA). The antenna signal (RF signal) is only connected to the TV when the modulator is switched off.
PRO	Component Video output set to "Progressive Scan". If this is not displayed, the Component Video output is set to "Interlaced".
	Remote control command has been sent
SAP	Second audio program from the tuner is selected (NAFTA)

Messages in the DVD recorder display

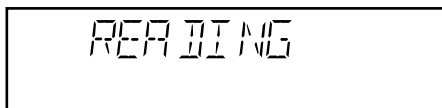

The following messages may appear in your DVD recorder display:

ISTV ON?	The DVD recorder is in initial installation mode. Switch the TV on, then read the paragraph on "Initial installation" in "Installing your DVD recorder".
NO SIGNAL	No input signal available (signal inadequate or unstable)
MENU	The menu on the screen is active
OPENING	Disc tray opening
TRAY OPEN	Disc tray open
CLOSING	Disc tray closing

READING	Disc being read
MENU UPDT	Once recording has been successfully completed the table of contents is created
INIT MENU	The menu structure is created after the first recording has been made on a new disc
COPY PROT	You have tried to copy a copy-protected DVD/video cassette
WAIT	Please wait until this message disappears. The DVD recorder is busy performing a task
NO DISC	A disc has not been inserted for recording. If a disc has been inserted, it cannot be read
INFO	Information about the inserted DVD is displayed on the screen
BUSY	The DVD recorder is processing to make the disc DVD compatible
ERASING	The entire information of the disc is erased
EMPTYDISC	The disc inserted is either new or has been completely erased (not recorded)
PROTECTED	The disc is protected against recording
MAX TITLE	The maximum number of titles per disc has been reached. The maximum number of titles per disc is 48
MAX CHAP	The maximum number of chapters per title/disc has been reached. The maximum number of chapters per title is 124
DISC FULL	The disc is full. There is no space for new recordings
PAL DISC	A disc with PAL recordings has been inserted. The machine is trying to record an NTSC signal. Insert a new disc or one that contains NTSC recordings
NTSC DISC	A disc with NTSC recordings has been inserted. The machine is trying to record a PAL signal. Insert a new disc or one that contains PAL recordings
RECORDING	An illegal action (e.g. ▲ Open/Close button) was attempted during recording
FREETITLE	Playback was started for an empty title or the following title is empty
DISC LOCK	An attempt has been made to record during playback of a protected disc. This message appears if an attempt is made to insert a chapter marker (EDIT button)
DISC ERR	An error occurred when writing the title. If this error keeps occurring, please clean the disc or use a new one For instructions on how to clean a disc, read the section on "Cleaning the discs" in the next chapter
DISC WARN	An error occurred when writing the title. Recording was continued; the error was skipped
SETUP	After the automatic search the menu for setting the date/time will appear on the screen
WAIT 01	During the automatic search the TV channels found are counted
BLOCKED	The disc tray cannot be closed/opened
SAFE REC	The new recording will be added at the end of all the other recordings (SAFE RECORD)

1 • Introduction

Common questions

What is a DVD?

DVD (Digital Versatile Disc) is a new storage medium that combines the convenience of the compact disc with the latest digital video technology. DVD video uses modern MPEG2 data compression technology that enables an entire feature film to be stored on a single five inch disc.

How good is the resolution of DVD compared with VHS?

The razor-sharp digital images have a resolution of more than 500 lines of 720 pixels per line. This is more than twice as high as VHS and is even better than the laser disc. Its picture quality is easily comparable to the digital masters produced in recording studios.

What can DVD+RW do?

DVD+ReWritable uses phase change media, the same technology on which rewritable CDs are based. A high-performance laser is used to change the reflective properties of the recording layer; this process can be repeated more than a thousand times.

What can the DVD+R do?

DVD+R (write-once DVD). Unlike a DVD+RW disc, this disc can only be written once. If it is not finalized after a recording, further recordings can be added to it. Old recordings can be deleted but can no longer be overwritten. The deleted titles are marked "Deleted title".

Before this disc can be played in a DVD player, it must be finalized in the DVD recorder. Once this process is complete, no further recordings can be added.

What can my DVD recorder do?

Your DVD recorder is a machine for recording and playing back digital video discs with "two-way" compatibility with the universal DVD video standard. This means:

-) existing DVD video discs can be played on the recorder.
-) Recordings made on your DVD recorder can be played on other DVD video players and DVD ROM drives.

Discs you can use

The following discs can be used in your DVD recorder for playback and recording:

Playback and recording



DVD+ReWritable

DVD+RW (Digital Versatile Disc + rewritable)



DVD+R

DVD+R (Digital Versatile Disc + Recordable)



DVD Video (Digital Versatile Disc)



DVD-R (DVD-Recordable)



DVD-RW (DVD-Rewritable) These discs can only be played back if the recording was made in video mode and the recording was finalised.



Audio CD (Compact Disc Digital Audio)



SUPER AUDIO CD

Super Audio CD (Only plays the CD layer of a hybrid SACD disc)



Video CD (Format 1.0, 1.1, 2.0)



Super Video CD



CD-R (CD-Recordable) Audio/MP3 content



CD-RW (CD-Rewritable) Audio/MP3 content

Regional code

Because DVD films are usually not released at the same time in all regions of the world, all DVD players are keyed to a specific region code. Discs can be assigned an optional region code. If the region codes of the player and disc do not coincide, playback is not possible.



This device will only play Region 1 DVDs or DVDs manufactured to be played in all regions (“ALL”).

DVDs from other regions cannot be played in this DVD Recorder.

The number within the globe represents the region of the world.

Region 1 represents:

U.S, Canada, upper regions of North America, Bermuda, U.S. Virgin Islands and smaller regions near Australia.

Accessories

Remote control and batteries

Power cable

Component video cable

Video cable

Antenna cable

Audio cable

DVD + RW disc

Cleaning the discs

Some malfunctions (frozen or distorted picture and broken sound for example) are due to dirt on the disc. To avoid such problems you should clean your discs regularly.

- 1 Dirty discs should be cleaned with a soft cloth. Always wipe from the middle to the edge.
- 2 Do not use any solvents such as benzine, thinners, commercially available cleaning agents or antistatic sprays designed for vinyl records.

Question

Can I use a CD lens cleaner in the DVD recorder?

This optical unit (laser) of the DVD recorder operates at a higher power level than the ones in normal DVDs and CD players so CD lens cleaner discs may actually damage it.

CD lens cleaner discs should therefore not be used.

2. Connecting your DVD recorder

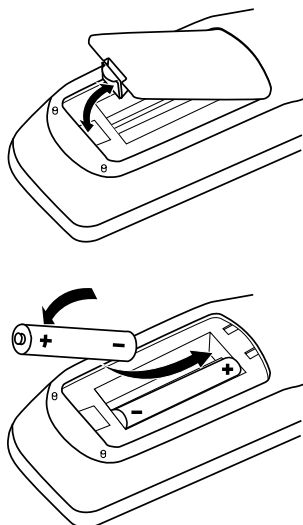

Preparing the remote control

You must install the supplied batteries into the remote control before you can use it.

1. Unpack the remote control and the two AA (LR-6) batteries.
2. Open the battery compartment, insert the batteries in accordance with the polarity markings, and then close the battery compartment.

The remote control is now ready to use.

The remote control has a range of approximately 5 to 10 meters.

Caution

Do not mix old and new batteries. Never mix different types of batteries (standard, alkaline, etc.). Doing so may reduce the life of the batteries.

Connection notes

- Before connecting your TV, VCR, AV amp, or any other equipment to your DVD recorder, refer to the relevant manuals first.
- Do not connect the power cord until all connections are complete.
- For the best results when playing DVDs, connect the DVD recorder's video output directly to your TV. If you connect your TV via your VCR, the DVD copy protection system may affect the picture quality.
- To enjoy the surround sound capabilities offered by DVD (Dolby Digital, DTS, MPEG-2), you need to connect one of the DVD recorder's digital audio outputs to an AV amp with an appropriate surround-sound decoder built-in. See "Surround sound connections" on page 17.
- For synchronized recordings to other components connected with digital audio cables, the length of each track and track numbers of the recorded materials may become different from the originals. Occasionally, it does not start recording.

Caution

Do not connect the DVD recorder's audio outputs to your audio system's turntable (phono) inputs. Doing so may damage your equipment.

Connecting your antenna

Connecting your antenna as shown will allow you to record a program on your DVD recorder while watching another program on your TV.

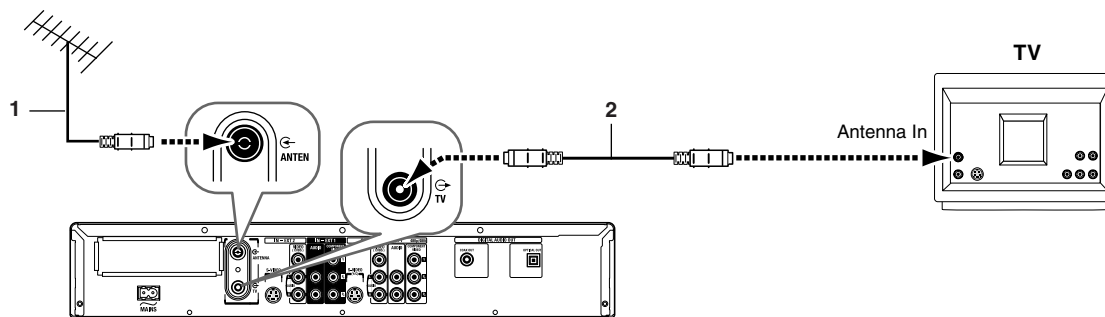

1. Disconnect the antenna plug (1) from your TV and connect it to the DVD recorder's **ANTENNA** socket.
2. Using the supplied antenna cable (2), connect the DVD recorder's **TV** socket to your TV's antenna input.

Connecting your TV to get the best picture

To enjoy the best picture quality when playing DVDs, you need to connect the DVD recorder to your TV using one of the following connection (the connection you choose will most likely depend on the connections supported by your TV).

COMPONENT VIDEO (best picture quality)

Component video connections offer the best picture quality, so if your TV has a COMPONENT VIDEO input, use it.

S-Video (very good picture quality)

S-Video connections offer better picture quality than composite video, so if your TV has an S-Video input, use it.

Composite video (good picture quality)

If your TV has neither COMPONENT VIDEO nor S-Video inputs, use a composite video connection.

Using a Component video cable

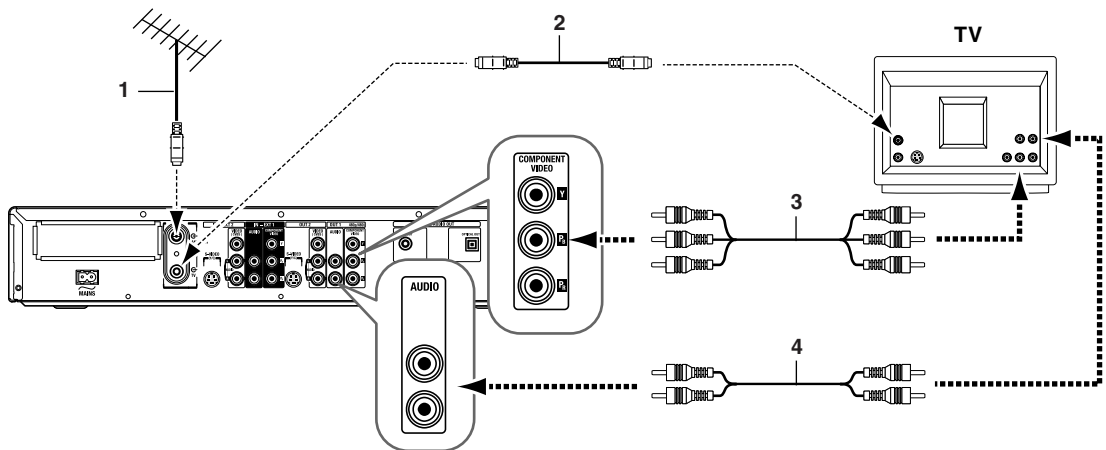

- 1 Connect the supplied Component video cable (3) to the DVD recorder's **COMPONENT VIDEO** outputs socket.
- 2 Connect the other end of the Component video cable to a **COMPONENT VIDEO** input on your TV.
- 3 Using the supplied AUDIO L/R cable (4), connect the DVD recorder's **AUDIO L/R** outputs to the analog audio inputs on your TV. (Connect white-to-white and red-to-red).

Using an S-Video cable

Since S-Video cables carry only video signals, separate audio connections are necessary.

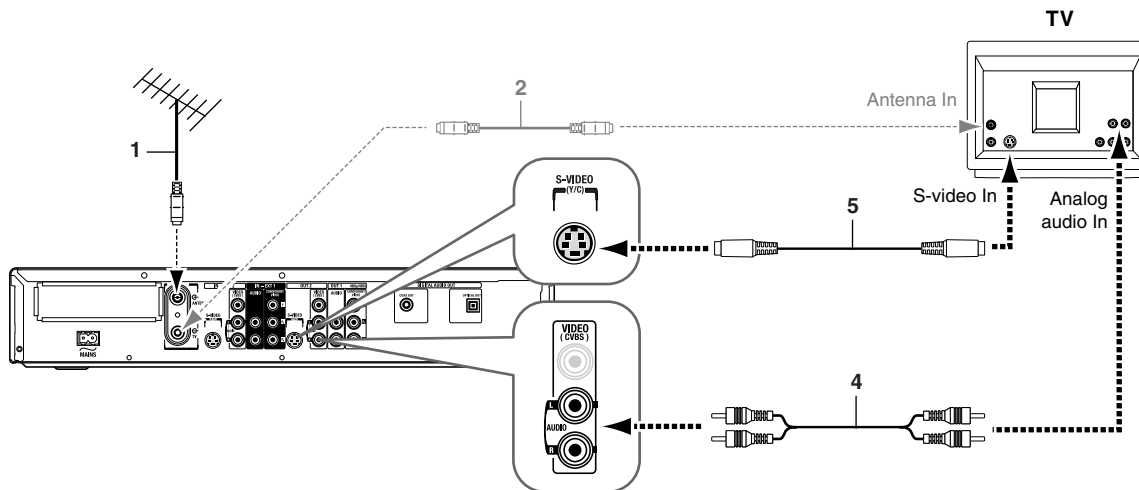

- ❶ Using an S-Video cable (5), connect the DVD recorder's **S-VIDEO** output to an S-Video input on your TV.
- ❷ Using the supplied AUDIO L/R cable (4), connect the DVD recorder's **AUDIO L/R** outputs to the analog audio inputs on your TV. (Connect white-to-white and red-to-red).

Using a composite video cable

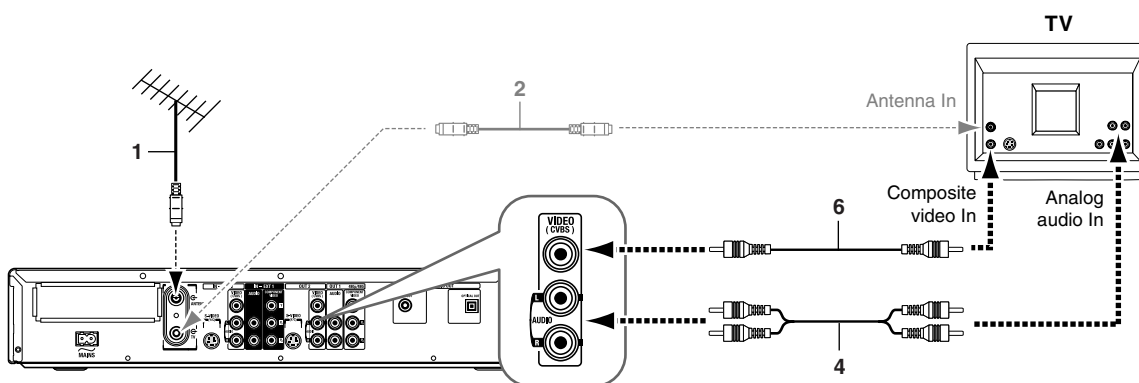

- ❶ Using the supplied composite video cable (6), connect the DVD recorder's **VIDEO (CVBS)** output to a composite video input on your TV.
- ❷ Using an AUDIO L/R cable (4), connect the DVD recorder's **AUDIO L/R** outputs to the analog audio inputs on your TV. Connect white-to-white and red-to-red).

Connecting a VCR

You can connect a VCR to the DVD recorder's **IN-EXT 2** and **OUT 2** sockets.

If you have an S-VHS VCR, you could connect the DVD recorder's **S-VIDEO** output to an S-Video input on the VCR, and connect the DVD recorder's **AUDIO L/R** outputs to analog audio inputs on the VCR.

Notes

Most prerecorded video cassettes and DVDs are copy protected. If you try to copy them, the message "COPY PROT" will appear on the DVD recorder's display.

If the DVD recorder displays the message "NO SIGNAL" when copying a video cassette:

- Check that the cables are connected securely.
- Try adjusting the VCR's tracking function.
- The DVD recorder may not recognize the video signal if it's weak or does not conform to normal video standards.

When copying DVD-Video discs or prerecorded video cassettes, the picture is fuzzy and the brightness changes continuously?

- This happens when you copy a DVD or video cassette that uses copy protection. Playback of the original is OK, but the DVD+R(W) recording will be unwatchable. This is normal with copy-protected DVDs and video cassettes.

Connecting your camcorder

You can transfer your home movies to DVD by connecting your camcorder to the AV sockets on the DVD recorder's front panel, as shown.

Best picture quality

If you have a DV or Digital 8 camcorder, using its i-link cable (**7**), connect the camcorder's i-link DV output to the DVD recorder's **DV** input.

During the transfer, the original recording dates and times of your home movies will be recorded on the DVD as subtitles. During DVD playback, you can view this information by using the Subtitle function.

Very good picture quality

If you have a Hi-8 or S-VHS-C camcorder, using an S-Video cable (**5**), connect the camcorder's S-Video output to the DVD recorder's **SVIDEO** input. And, using an AUDIO L/R cable (**4**), connect the camcorder's analog audio outputs to the DVD recorder's **AUDIO L/R** inputs.

Good picture quality

If your camcorder only has a composite video output, using a composite video cable, connect the camcorder's composite video output to the DVD recorder's **VIDEO** input. And, using an AUDIO L/R cable (**4**), connect the camcorder's analog audio outputs to the DVD recorder's **AUDIO L/R** inputs.

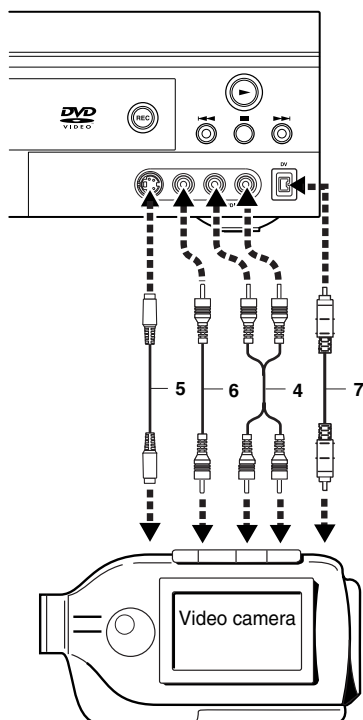

3. Connecting an AV receiver

Basic playback connections

The following connections allow you to enjoy DVD playback via your AV receiver.

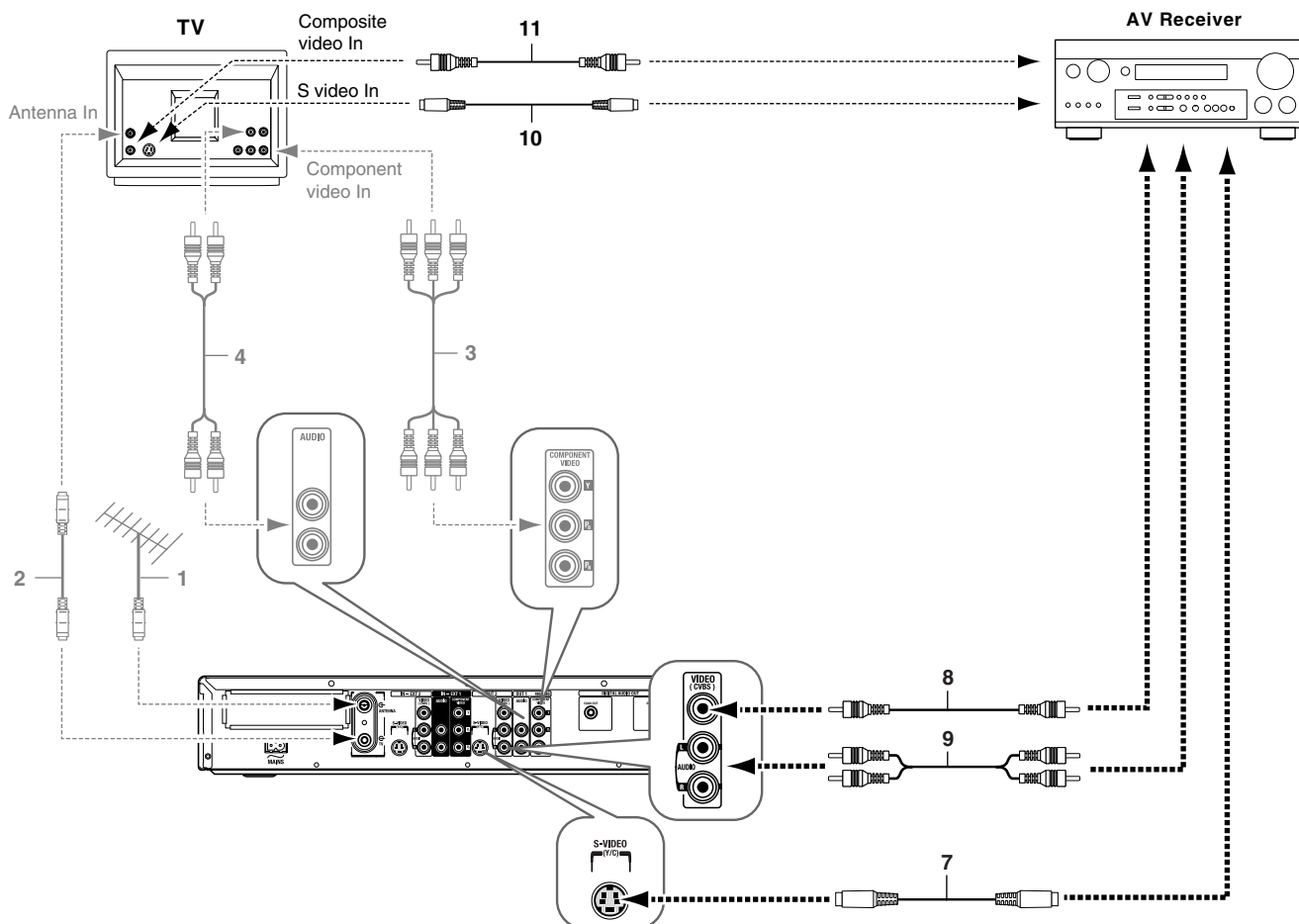

- 1 Connect an S-Video cable (7) from the DVD recorder's **S-VIDEO** output to an S-Video input on your AV receiver.
- 2 Connect a composite video cable (8) from the DVD recorder's **VIDEO (CVBS)** output to a composite video input on your AV receiver.
- 3 Connect an AUDIO L/R cable (9) from the DVD recorder's **AUDIO L/R** outputs to a pair of analog audio inputs on your AV receiver.
- 4 If your AV receiver has an S-Video output and your TV has an S-Video input, connect an S-Video cable (10) from the AV receiver's output to an S-Video input on your TV.
- 5 If your AV receiver has no S-Video output or your TV has no S-Video input, connect a composite video cable (11) from the AV receiver's composite video output to a composite video input on your TV.

Note

If your AV amp has several video inputs and outputs, you can connect your VCR, set-top box, LD player, etc., to its video inputs and connect your TV to its video output. Then you can select your various video sources by using the input selector on your AV amp.

Surround sound connections

To enjoy surround sound (Dolby Digital, DTS, MPEG-2), you need to connect one of the DVD recorder's digital audio outputs to a multichannel AV amp with an appropriate surround-sound decoder built-in.

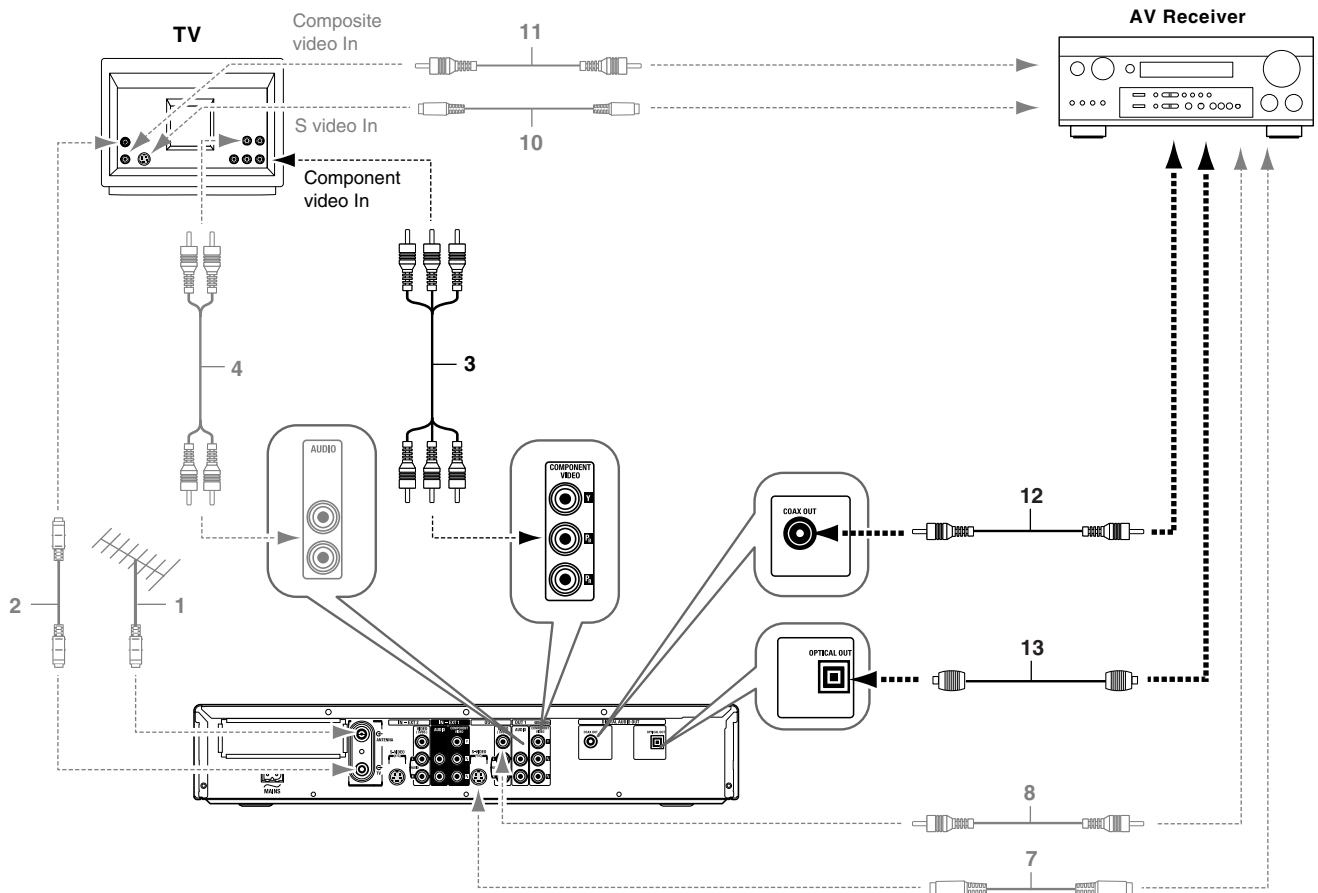

Your DVD recorder has both coaxial and optical digital audio outputs. The format you choose will most likely depend on the formats supported by your AV amp. You don't need to connect both cables, and their sound quality is identical.

- 1 Connect a coaxial (12) or optical (13) digital audio cable from the DVD recorder's **COAX OUT** or **OPTICAL OUT** to a coaxial or optical digital audio input on the AV receiver.

You can use a composite video cable instead of a dedicated coaxial digital audio cable.

Note

An unpleasant digital noise may be heard if you select a DVD soundtrack that uses an audio format that is not supported by your AV amp. For example, you select a DTS soundtrack and your AV amp does not support DTS. The format of the currently selected soundtrack can be displayed onscreen in the menu bar. Six-channel (5.1) surround-sound playback is only possible with a multichannel AV amp that supports Dolby Digital, DTS, or MPEG-2.

Recording connections

The following connections allow you to record programs from your VCR or set-top box to your DVD recorder via your AV receiver.

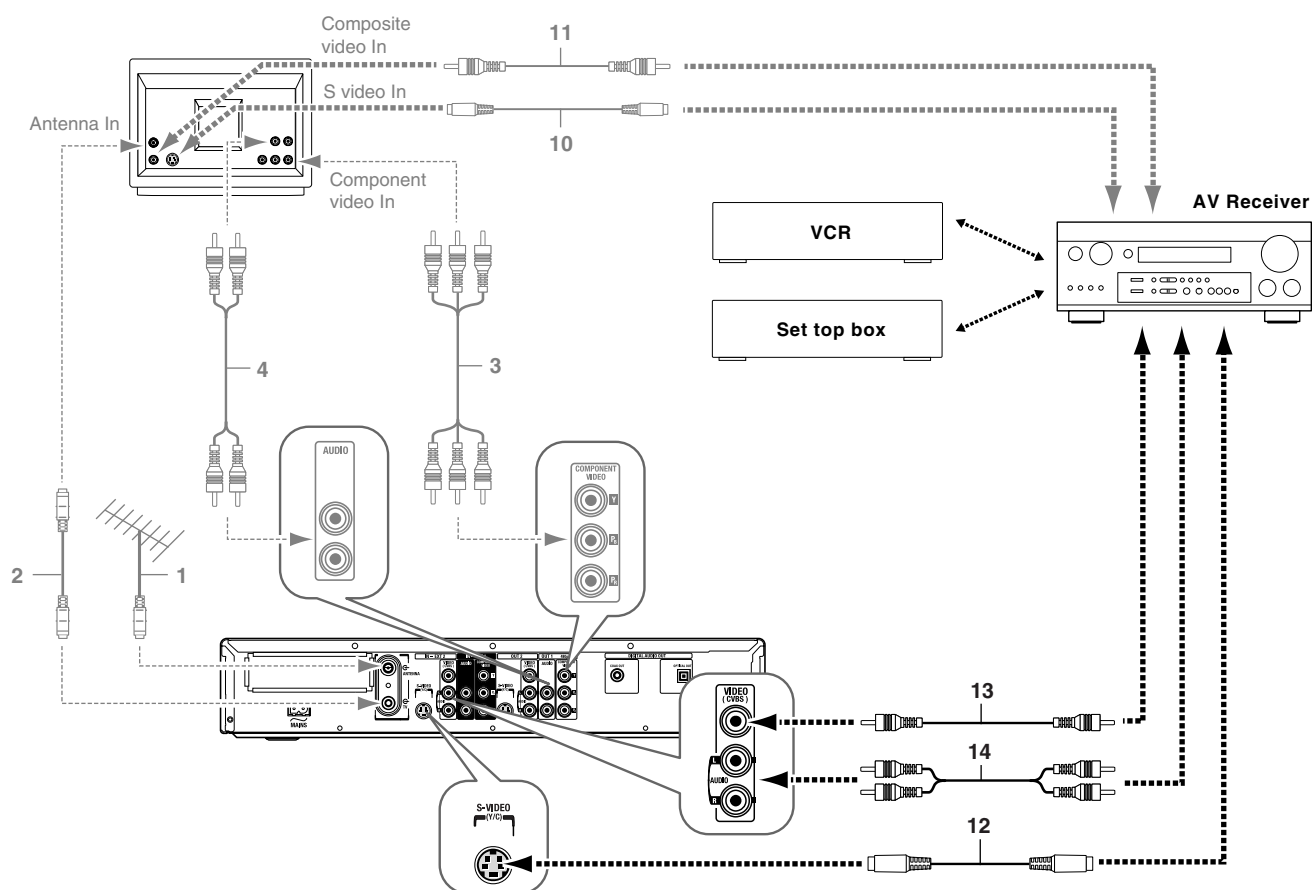

- ❶ If your VCR or set-top box is connected to your AV receiver with an S-Video cable, connect an S-Video cable (10) from your AV receiver's S-Video output to the S-Video input on your TV.
- ❷ If your VCR or set-top box is connected to your AV receiver with a composite video cable, connect a composite video cable (11) from the AV receiver's composite video output to the composite video input on your TV.

You don't need to connect both the S-Video and composite video cables to your TV. S-Video offers better picture quality.

- ❶ Using the supplied composite video cable (13), connect the DVD recorder's **VIDEO (CVBS)** input to a composite video output on your AV receiver.
- ❷ Using an AUDIO L/R cable (14), connect the DVD recorder's **AUDIO L/R** inputs to the analog audio outputs on your AV receiver. (Connect white-to-white and red-to-red).
- ❸ Using an S-Video cable (12), connect the DVD recorder's **S-VIDEO** input to an S-Video output on your AV receiver.

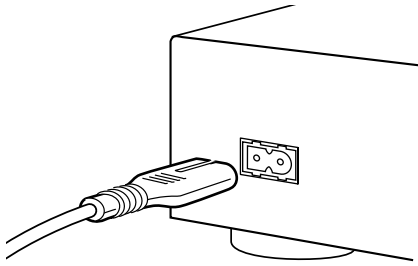

Power supply

- Make sure that all necessary connections are made before connecting the DVD recorder to the power supply.
- Plug the power cable supplied into the Power connector on the rear of the recorder.
- Plug the mains plug into an AC outlet.

Note

*Always check if the local mains voltage matches the required 100V - 120V.
When the recorder is in the Standby position, it is still consuming some power.
If you wish to disconnect your DVD recorder completely from the mains, withdraw the plug from the AC Outlet.*

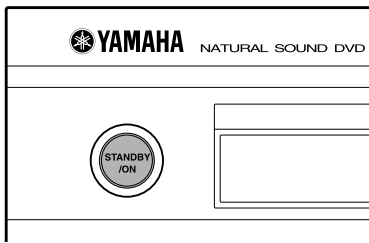

Switching on

- Switch on the TV set and select the programme number that you have chosen for video playback (see operating manual for your TV set).
- Press **STANDBY/ON**.
 - The recorder display lights up. If you have not yet installed your DVD recorder, it will enter 'Initial Setup mode.' In this mode you will have to set your personal preferences.

4. Installing your DVD recorder

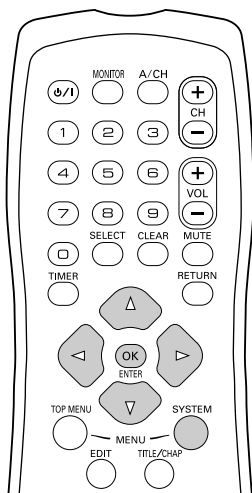

Initial installation

After successfully connecting your DVD recorder to the TV set and other additional devices as described in the previous chapters, this chapter will show you how to start the initial installation.

The DVD recorder automatically seeks out and stores all available TV channels.

Tip

Connecting additional devices

If you have connected additional devices such as a satellite receiver to the aerial cable, switch them on. The automatic channel search will recognise it and save it.

No aerial connected

Even if you only want to use the DVD recorder to play back or have only connected a satellite receiver, you must still complete the initial installation.

This is necessary so that the basic settings are stored correctly. Once initial installation is complete you can use the DVD recorder as normal.

Initial Setup

Menu Language

- English
- Español
- Français

Press OK to continue

- 1 Select the desired language for the on-screen menu by pressing ▼ or ▲.

Question

What is an on-screen menu?

The multi-language on-screen menu takes the mystery out of using your new DVD recorder. All settings and/or functions are displayed on your TV screen in the relevant language.

Initial Setup

Audio Language

- English
- Español
- Français
- Português
- Italiano

Press OK to continue

- 2 Confirm with **ENTER/OK**.
- 3 Select the desired audio language using ▼ or ▲.

Question

What is an audio language?

The DVD audio will play in the selected language if it is available. If this language is not available on the DVD, the audio will play in the first language on the DVD. The DVD disc menu will appear in the selected language if it is available on the disc.

Initial Setup

Subtitle Language

- English
- Español
- Français
- Português
- Italiano

Press OK to continue

- 4 Confirm with **ENTER/OK**.
- 5 Select the desired language for the subtitles by pressing ▼ or ▲.

Question

What is the subtitle language?

DVD subtitles will be in the selected language if it is available. If this language is not available, subtitles will be in the first language on the DVD.

- 6 Confirm with **ENTER/OK**.

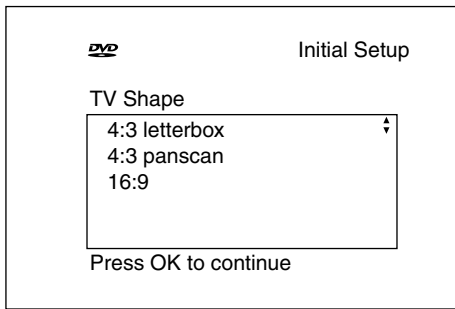

- 7 Select the desired screen format position using ▼ or ▲.
These settings will only be used if you insert a DVD that contains this information.

Question	
Which screen formats can I select?	
"4:3 letterbox"	for a "wide-screen" (cinema format) picture with black bars at the top and bottom.
"4:3 panscan"	for a full-height picture with the sides trimmed.
"16:9"	for a wide-screen TV set (screen edge ratio 16:9)

- 8 Confirm with **ENTER/OK**.
- 9 After you connect the aerial (or cable TV, satellite receiver, etc.) to the DVD recorder, press **ENTER/OK**.
The automatic TV channel search starts. "WAIT" will appear on the display.

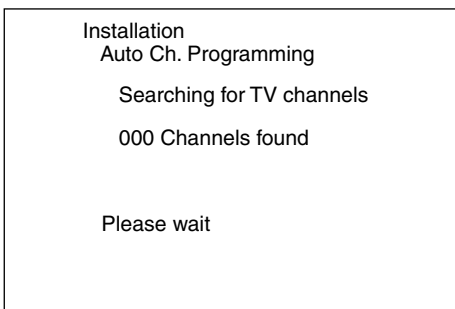

Problem	
✗ The DVD recorder cannot find any TV stations	
✓	Select channel 1 on the TV set. Can you see the stored TV channel on the TV set? If not, check the cable connection from the aerial (aerial jack) to the DVD recorder and to the TV set.
✓	Please have patience. The DVD recorder searches the entire frequency range in order to find and save the largest possible number of TV channels.
✓	If you have not connected an aerial, go through all the basic settings right to the end and then, if you wish, start the automatic search (see "Automatic TV station search").

- 10 When the automatic TV channel search is complete after several minutes of wait, "**Auto ch. search complete**" will appear on the TV screen.
- 11 To remove the menu, press the **SYSTEM-MENU** button on the recorder's remote control.

The initial installation is now complete.

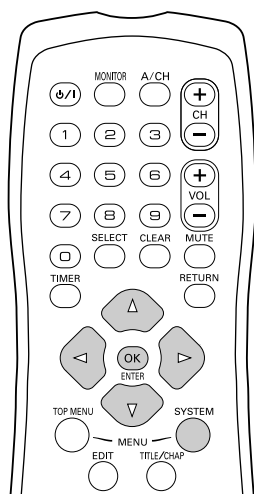

Installation
Auto Ch. Programming
Searching for TV channels
000 Channels found

Please wait

Automatic TV channel search

During installation, all available TV channels are searched for and stored. If the channel assignments of your cable or satellite TV provider change or if you are reinstalling the DVD recorder, e.g. after moving house, you can start this procedure again. This will replace the stored TV channels with the new ones.

- 1 Switch on the TV set. If required, select the programme number for the DVD recorder.
- 2 Switch on the DVD recorder using O/I .
- 3 Press **SYSTEM-MENU** on the remote control. The menu bar appears.
- 4 Select " T " symbol with \blacktriangleleft or \blacktriangleright .
- 5 Select "*Installation*" using \blacktriangledown or \blacktriangleup and confirm with \blacktriangleright .
- 6 Select "*Auto Ch. Programming*" using \blacktriangledown or \blacktriangleup .
- 7 Press \blacktriangleright .
- 8 The automatic TV channel search starts. This allows the DVD recorder to save all available TV channels. This procedure may take several minutes.
- 9 When all the TV channels have been found, "*Auto ch. search complete*" will appear on the TV screen.
- 10 To end, press **SYSTEM-MENU**.

You can read about how to search for a TV channel manually in "Adding and clearing TV channels manually".

Question

Cannot select " T "?

You need to stop the disc to select " T ".

Problem

✗ Very few TV channels were found

✓ During "Automatic channel search" the DVD Recorder detects whether an antenna or a cable TV signal is connected. If you have connected a cable TV signal but found very few TV channels, you must search the channels manually.

- 1 To do so, select "*Cable/Antenna*" instead of line "*Auto Ch. Programming*" in step 6 and confirm with \blacktriangleright .
- 2 If you select "*Cable*", channels 1-125 will be available.
If you select "*Anten.*", channels 2-69 will be available.
Select your type of connection by pressing \blacktriangleright repeatedly:
"*Anten.*", "*Cable*" or "*Auto.*" automatically detects which one you have.
- 3 Confirm the setting with **OK**.
- 4 Press **SYSTEM-MENU** to go to the next menu. Press **OK** to start channel search as prompted by the on-screen message. When the channel search is complete, press **SYSTEM-MENU** repeatedly to remove all the menus.

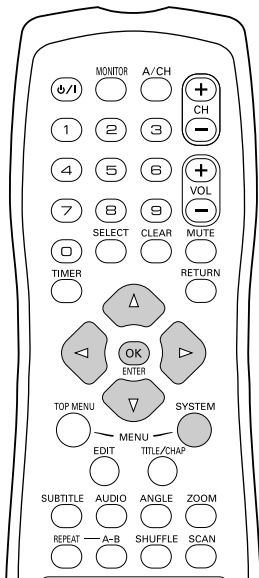

Adding and clearing TV channels manually

After you have performed the automatic channel search you may not agree with the sequence in which the individual TV channels have been allocated to the programme positions (programme numbers). You can use this function to rearrange the TV channels already stored or to delete TV channels you don't want or those with poor reception.

- 1 Switch on the TV set. If required, select the programme number for the DVD recorder.
- 2 Switch on the DVD recorder. Press the **SYSTEM-MENU** button on the remote control. The menu bar appears.
- 3 Select “**⏏**” symbol with ◀ or ▶.
- 4 Select “**Installation**” using ▼ or ▲ and confirm with ▶.
- 5 Select “**Add/Delete Channels**” using ▼ or ▲ and confirm with ▶.
- 6 Using ▲ or ▼ select the TV channel that you want to add or delete.
- 7 Confirm with ▶.

Installation Add/Delete Channels

- Channel 001 Add
- Channel 002 Add
- Channel 003 Delete
- Channel 004 Delete
- Channel 005 Delete
- Channel 006 Delete
- ...

To exit press
SYSTEM MENU

Tip

Deleting TV channels

Unwanted channels or those with poor reception can be deleted using **CLEAR**. Proceed at step 6 to continue or at 8 to finish.

- 8 To store, press **ENTER/OK**.
- 9 To end, press **SYSTEM-MENU**.

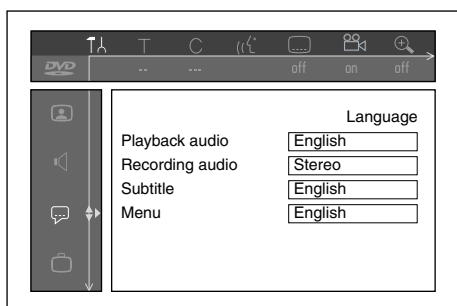
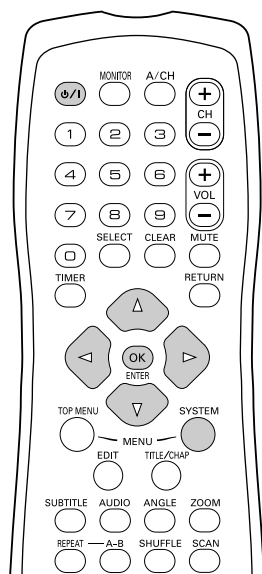

Setting the language

You can select the country and, for DVD playback, the language for the subtitles and the audio language. Please note that with some DVDs the audio language and/or subtitle language can be changed only via the DVD menu.

Moreover, when recording the sound of a TV channel, you can switch between stereo and an additional language (SAP - Secondary Audio Program). See the following section on “Switching audio recording (stereo, SAP)”.

You also have the option of setting one of the displayed languages for the on-screen menu (OSD). However, the DVD recorder display will only display English text regardless of this setting.

- 1 Switch on the TV set. If required, select the programme number for the DVD recorder.
- 2 Switch on the DVD recorder using **⏻/I**.
- 3 Press **SYSTEM-MENU** on the remote control. The menu bar appears.
- 4 Select “**T**” symbol with **◀** or **▶**.
- 5 Select line “**Language**” with **▼** or **▲** and confirm with the **▶** button.
- 6 Select the appropriate line and confirm with **▶**.

Tip

Which settings can I choose?

Playback audio: language of the playback (audio language)

Recording audio: Type of audio recording “Stereo” or “SAP”

Subtitle: Subtitle language

Menu: Language of the OSD menu

- 7 Select the appropriate setting using **▼** or **▲** and confirm with **ENTER/OK**.
- 8 To end, press **SYSTEM-MENU**.

Switching audio recording (Stereo, SAP)

Some TV programs broadcast additional audio (SAP - Secondary Audio Program). In most cases this means that an additional language is available. For example, if a program is available in English and Spanish, Spanish can be broadcast as the additional audio program (SAP).

To record TV programs in stereo or SAP, you can select Stereo or SAP as the default setting.

This setting does not become active until the sound of a TV program is transmitted in Stereo or SAP.

When you playback the recording, you can playback the sound only in the setting you selected for recording (a recording in SAP can be played back only in SAP).

- 1 Switch on the TV set. If required, select the programme number for the DVD recorder.
- 2 Switch on the DVD recorder using **⏻/I**.
- 3 Press **SYSTEM-MENU** on the remote control. The menu bar appears.
- 4 Select “**T**” symbol with **◀** or **▶**.
- 5 Select line “**Language**” with **▼** or **▲** and confirm with the **▶** button.
- 6 Select line “**Recording audio**” and confirm with **▶**.

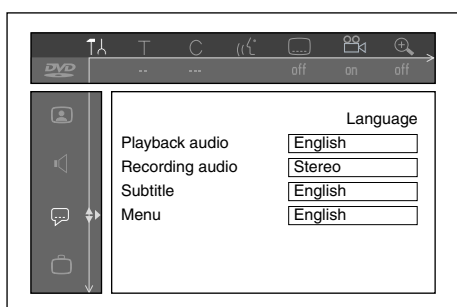

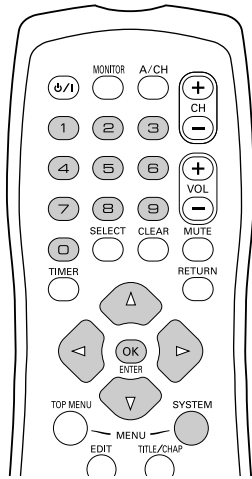

- 7 Select “**Stereo**” or “**SAP**” with ▼ or ▲ and confirm with **ENTER/OK**.
- 8 To end, press **SYSTEM-MENU**.

Assigning the VCR Plus+® Guide channel numbers

If you intend to use the VCR Plus+® programming system, you must first assign Guide channel numbers to the TV channels.

- 1 Press **SYSTEM-MENU** on the remote control. The menu bar will appear.
- 2 Select “**⏏**” using ◀ or ▶.
- 3 Select line “**Installation**” using ▼ or ▲ and confirm with ▶.
- 4 Select the line “**VCR Plus+ Ch.**” using ▼ or ▲ and confirm with ▶.
- 5 Use ▼ or ▲ to select the Guide channel number you want to assign to a TV channel.
- 6 Use ◀ or ▶, or use the number buttons **0..9** to select the TV channel corresponding to this Guide channel number. An overview of guide numbers/TV channels can be found in your daily newspaper or in your TV listings.
- 7 Confirm the allocation with **ENTER/OK**.
- 8 To end, press **SYSTEM-MENU**.

Installation

VCR Plus+ Ch.

VCR Plus+ Ch.	Channel
...	---
001	---
002	---
003	---
004	---
005	---
...	---
To exit press SYSTEM MENU	

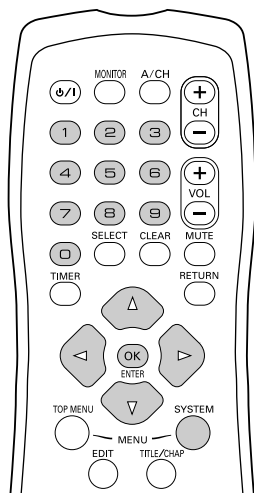

Time/date
Automatic

PBS Channel	Auto.
Daylight Saving	Off
Time Zone	Auto.

To exit press
SYSTEM MENU

Setting the time and date automatically

This function uses the information sent via the local PBS channel to automatically set the time/date. For this reason, you must enter the PBS channel that sends this additional information.

When the DVD Recorder chooses a wrong PBS channel or the displayed time/date is wrong, you must manually set the date/time (see section "Manually setting the time & date").

- 1 Press **SYSTEM-MENU** on the remote control. The menu bar appears.
- 2 Select "⌚" symbol with ◀ or ▶.
- 3 Select "**Installation**" using ▼ or ▲ and confirm with ▶.
- 4 Select "**Time/date**" using ▼ or ▲ and confirm with ▶.
- 5 Select "**Automatic**" with ▼ or ▲ and confirm with ▶.
- 6 Select the corresponding line with ▼ or ▲.
- 7 Select the channel which sends the time/date information in the line "PBS Channel" and confirm with **ENTER/OK**. The DVD Recorder will check whether or not the information transfer is possible.

Problem

- ✗ "**Clock not set, check channel**" will appear on the TV screen
 - ✓ No time/date data can be received from this TV channel.
 - Select a different channel or "Auto." in line "PBS Channel".

- 8 Select one of the following settings in line "**Daylight Saving**":
 - "**On**": The time set corresponds to summer time (summer time activated)
 - "**Off**": The time set corresponds to the winter time (summer time is off)
- 9 In the line "**Time Zone**", select your time zone if the PBS channel entered was for a different time zone. This is the only way to set the time correctly, or, if necessary, to correct it.
If you want to use the time zone of the PBS channel, select "**Auto.**".
- 10 Confirm the changes with **ENTER/OK**.
- 11 To end, press **SYSTEM-MENU**.

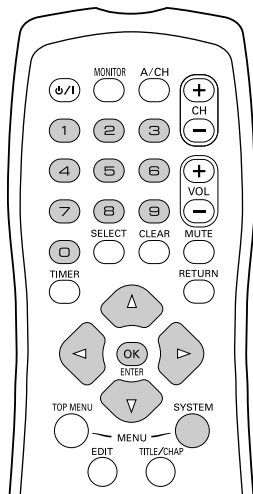

Manually setting the time & date

If the time is incorrect, this could be due to a weak or disrupted TV signal. If this is the case, switch off the automatic function.

- 1 Press **SYSTEM-MENU** on the remote control. The menu bar will appear.
- 2 Select “**↑↓**” using **◀** or **▶**.
- 3 Select line “**Installation**” using **▼** or **▲** and confirm with **▶**.
- 4 Select line “**Time/date**” using **▼** or **▲** and confirm with **▶**.
- 5 Select “**Manual**” with **▼** or **▲**.
- 6 Confirm with **ENTER/OK**.
- 7 Change the time in line “**Time**” using the number buttons **0..9** on your remote control.
- 8 Check “**AM/PM**”, “**Year**”, “**Month**”, and “**Date**” in the same way. To select between the fields, use **▼** or **▲**. Change the information with **◀, ▶** or the number buttons **0..9**.
- 9 Select one of the following settings in line “**Daylight Saving**”:
 “**On**”: The time set corresponds to the summer time (summer time is on)
 “**Off**”: The time set corresponds to the winter time (summer time is off)
- 10 When all settings are correct, confirm with **ENTER/OK**.
- 11 To end, press **SYSTEM-MENU**.

Time/date
Manual

Time	09:02
AM/PM	AM
Year	01
Month	01
Date	01
Daylight Saving	Off

To exit press
SYSTEM MENU

If the setting has been confirmed with OK the automatic system is disabled.

5. On-screen information

You can check or change many of the functions and settings of your DVD recorder via the system menu bar. The menu bar cannot be displayed during recording.





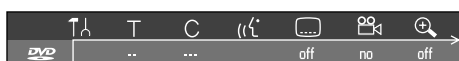

Symbols in the menu bar

Press **SYSTEM-MENU** to open and close the menu bar (main menu). Use ◀ and ▶ to select the relevant function. Use ▼ to confirm the function and go either to another menu or execute the function directly.

Some functions may not be available, depending on the disc inserted.







Menu bar 1

	User preferences
	Title/track
	Chapter/index
	Audio language
	Subtitle language
	Camera angle
	Zoom







Menu bar 2









While menu bar 1 is being displayed you can go to menu bar 2 by pressing ▶ again.

	Sound
	Frame advance
	Slow motion
	Fast forward
	Search by time

Field for temporary messages

The top left corner of the menu line contains a field for temporary messages relating to the various operating modes. This information appears briefly on the screen when certain disc functions have been activated:

	Shuffle
	Scan
	Repeat entire disc
	Repeat title

	Repeat track
	Repeat chapter
	Repeat from A to the end
	Repeat from A to B
	Camera angle
	Child lock enabled
	Resume playback
	Illegal action

Status field

The status field shows the current operating mode (status) of the DVD recorder and the type of disc inserted. This display can be disabled.

Disc type symbols



	DVD+RW
	DVD+R
	DVD-Video
	Video-CD
	No disc
	Error

Operating mode symbols

	Recording
	Stop
	Playback
	Playback-Pause
	Record-Pause
	Search forwards (8x speed)
	Search backwards (8x speed)
	Slow motion

Tuner information box



This field is located in the bottom left-hand corner of the screen. The aerial signal, the TV channel and the TV channel name for the selected programme are displayed.

	Current channel/selected input jack
	No signal The TV channel is not available/the additional device is not connected or it is switched off
	Copy-protected signal

Timer information box

This box appears above the tuner information box. When a timer recording is set, it shows the timer icon and the start time or date of the first programme to be recorded. If no timer recording is scheduled, the current time is displayed.

This box disappears during playback of a disc or after a recording starts. However, you can access it during an OTR recording by pressing **SYSTEM-MENU**.

	Timer starts on the day shown
	OTR recording runs until the stop time displayed
	Current time No timer event programmed

6. Playback

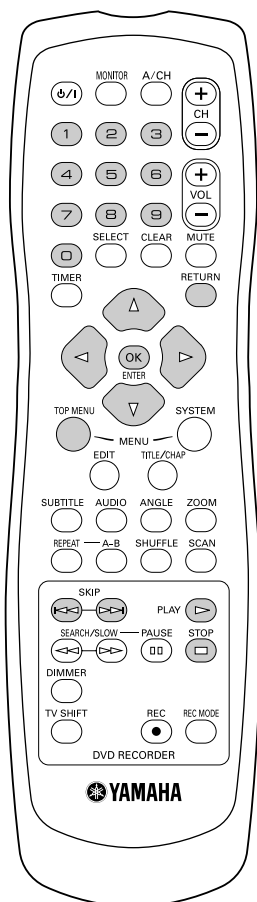

General notes on playback

With this DVD recorder you can play back the following systems:

-) DVD Video
-) (Super) Video CD Disc
-) DVD+RW Disc
-) DVD+R Disc
-) DVD-RW (video mode, finalized)
-) DVD-R
-) CD-R
-) CD-RW
-) Audio CD
-) MP3 CD

You can operate the video recorder using the remote control or the buttons on the front of the DVD recorder.

Problem

✗ The display will read "PIN"

- ✓ The child lock has been activated for the inserted disc. Read the sections on "Child lock" and "Releasing a disc" in the chapter on "Access control (child lock)".

✗ The menu on the screen is showing an "X"

- ✓ Some DVD discs can be manufactured so that certain steps are required before the disc can be played, or so that only limited operation is possible during playback. When an "X" appears on the screen the selected feature is not possible.

✗ The screen is showing regional code information

- ✓ Since DVD films are not normally released in all parts of the world at the same time, all DVD players have a specific regional code. Discs can be given a regional code. If the regional codes differ between the player and the disc, playback is not possible.
- ✓ The regional code is shown on the label on the back of the machine.
- ✓ The regional code does not apply to recordable DVD discs.

Inserting a disc

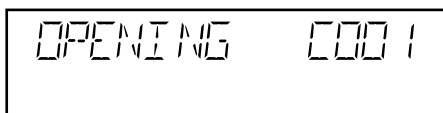

- 1 Press the **▲ (Open/Close)** button on the front. The disc tray will open. While the disc tray is opening, "OPENING" and then "TRAY OPEN" when the tray is fully open.
- 2 Carefully place the disc in the tray with the label facing up and press **PLAY▷** or **▲ (Open/Close)** "CLOSING" and then "READING" will appear in the display. The information on the disc will be read.

Question

How do I insert a double-sided DVD?

Double-sided discs do not have labelling over the whole surface. The labelling for each side is in the centre of the disc. To play a side its label must be facing up.

Tip

Opening/closing the tray using the remote control

You can open and close the disc tray using the remote control.

Press and hold the **STOP□** button on the remote control until the dialog box shows "OPENING" or "CLOSING".

- 3 Playback starts automatically.



DVD+ReWritable



A menu may appear when a DVD is played back. If the titles and chapters are numbered, press a number button on the remote control. You can also use the ◀, ▶, ▲, ▼ buttons or number buttons 0..9 to select a menu item and confirm with **ENTER/OK**. You can also access the menu using **TOP-MENU** on the remote control. For further information see “Playing a DVD video disc”.

When a DVD+RW is played back the index overview appears. Using ▼, ▲, ◀◀, ▶▶ select the title you want to play back.

Confirm with **ENTER/OK**.

For further information see “Playing back a DVD+RW/+R Disc”.

If playback does not start automatically, press **PLAY▷**.

For further information see “Playing an audio CD”.

If the “■” symbol appears in the display, start playback by pressing **PLAY▷**.

If a menu appears on the screen, use the remote control buttons indicated on the screen to select the menu option you want (PREV=◀◀, NEXT=▶▶) or with the number buttons 0..9.

For further information see “Playing a (Super) Video CD”.

Playing a DVD video disc

- 1 If playback does not start automatically, press **PLAY▷**. This will appear on the display: title, chapter, elapsed time.
- 2 To stop playback, press **STOP□** on the remote control or **■** on the DVD recorder.
- 3 To eject the disc, press **▲ (Open/Close)** on the front of the DVD recorder.

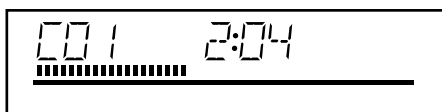

Playing a DVD+RW/ +R disc

- 1 If the disc is write-protected or a finalised DVD+R disc, playback starts automatically.
- 2 If playback does not start automatically, use the ▼ or ▲ button to select the title you want to play on the index screen. You can also use the ◀◀ or ▶▶ button on the front.
- 3 Press the **PLAY▷** button. This will appear on the display: title number, recording quality.



Problem

✘ I can see the message “EMPTYDISC”

✓ The disc does not contain any recordings.

- 4 To stop playback, press **STOP□** on the remote control or **■** on the DVD recorder.
- 5 To eject the disc, press **▲ (Open/Close)** on the front of the DVD recorder.

Question

What should I note when playing back different recording types (qualities)?

The correct recording quality “**M1, M2, M2x, M3, M4, M6, FR**” will automatically be selected during playback.

For more information see the section on “Selecting the recording type (quality)” in the chapter on “Manual recording”.

Playing an audio CD

You can also use the DVD recorder to play audio CDs

- 1 Insert an audio CD. Playback starts automatically.

Tip

Audio CD display

If the TV is on, the audio CD screen appears automatically.

During playback, the current track number and its elapsed playing time will show on the TV screen and on the recorder display.

- 2 Stop playback using **STOP** . The number of tracks and the total time are displayed.

Playing an MP3 CD

MP3 (MPEG1 Audio Layer-3) files are highly compressed music files. Using this technology the data volume can be compressed by a factor of 10. This means it is possible to record 10 hours of music in CD quality on a single CD-ROM.

When creating MP3 CDs please note the following:

File system: ISO9660

Directory structure: maximum of 8 levels

Formats: *.mp3

Filenames: maximum of 12 characters (8+3)

Maximum of 32 albums, 999 titles

Supported sampling frequencies: 32, 44.1, 48 (kHz). Music with sampling frequencies other than these will be skipped.

Supported bit rates: 32, 64, 96, 128, 192, 256 (kbit/s)

ID3 Tag: Version 1, 1.1. In later versions the directory name is displayed as the album and the filename as the title.

Important notes for playback:

In accordance with SDMI (Secure Digital Music Initiative), the digital audio output is turned off during MP3 playback.

Only the first session of a multi-session CD will play back.

- ① Insert an MP3 CD. Playback starts automatically.

Tip**MP3 CD display**

If the TV is on, the MP3 CD screen appears automatically.

During playback, the current track number and its elapsed playing time will show on the TV screen and on the recorder display.

Further information on the album, track and artist will also be displayed if included in the ID tag.

- ② Stop playback using **STOP** □. The number of albums is displayed in the display.

Tip**Additional playback features**

Using ◀◀ or ▶▶ select the next or previous title.

You can also use the **TITLE/CHAP** button to select titles and albums.

- 1 Press the **TITLE/CHAP** button and use the ▶ or ◀ button to select the “T” symbol for title or “C” for chapter.
 - 2 Use the ▼ or ▲ buttons or the number buttons **0..9** on the remote control to select the number of the title/chapter.
- You can also use the repeat functions (**REPEAT** button).

Playing a (Super) Video CD

(Super) Video CDs may be equipped with PBC (Play Back Control). This means that special playback functions (menus) can be directly selected. The video CD must be PBC compatible (see CD case). When PBC is active, no information will be shown on the DVD recorder display.

“PBC” is active in the default settings.

- ① Insert a (Super) Video CD.
If the “□” symbol appears in the display, start playback by pressing **PLAY** ▷.
- ② If a menu appears on the screen, use the remote control buttons indicated on the screen to select the menu option you want (PREV=◀◀, NEXT=▶▶) or with the number buttons **0..9**.
If a PBC menu consists of a list of titles, you can select a title directly.
- ③ Use **RETURN** to go back to the previous menu.
- ④ Stop playback using **STOP** □.

7. Additional playback features

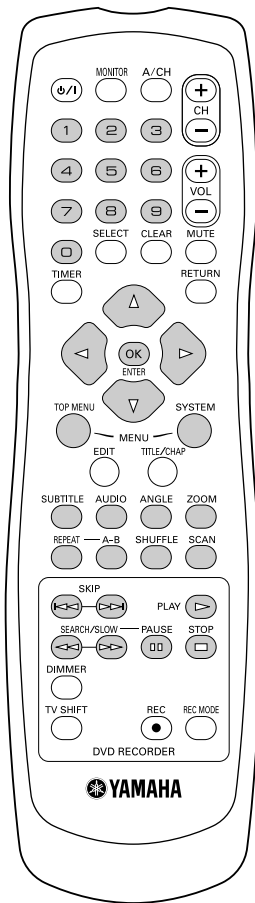

Changing to another title/chapter

If there is more than one title or chapter on a disc you can change to another title or chapter as follows. However if there are several chapters within a title, these will be selected. The title can then still be selected via the menu bar.

- 1 During playback, press \blacktriangleright to go to the next title/chapter. Press \blacktriangleleft to return to the start of the current title/chapter. Press \blacktriangleleft twice to return to the start of the previous title/chapter.

Tip

Use the **TITLE/CHAP** (title/chapter) button

- 1 Press **TITLE/CHAP** (title/chapter) and then use \blacktriangle or \blacktriangledown to select the appropriate title. Make sure the symbol "T" (title) is selected in the menu bar.
- 2 Use **TITLE/CHAP** to select chapters within a title. Press **TITLE/CHAP** and use \blacktriangleright to select the "C" symbol (chapter). Now select the appropriate chapter with \blacktriangle , \blacktriangledown or digit keys **0..9**.

Searching a disc

You can search the disc at 4x or 32x playback speed. Other speeds can only be selected via the menu bar (" \blacktriangleright ").

- 1 During playback, press and hold \blacktriangleleft (reverse) or \blacktriangleright (forwards) to switch to the search feature. You can switch between the playback speeds using $\blacktriangleleft/\blacktriangleright$.
- 2 To continue playback, press **PLAY** \blacktriangleright at your chosen location.

Problem

X No sound

- ✓ The sound is switched off in search mode. This is not a fault in your machine.

Tip

Search feature via menu bar

- 1 During playback press **SYSTEM-MENU** on the remote control. The menu bar will appear at the top of the screen.
- 2 Select the " \blacktriangleright " symbol using \blacktriangleright or \blacktriangleleft and confirm with \blacktriangledown .
- 3 You can now use the \blacktriangleleft or \blacktriangleright button to select different forward and backward search speeds.
- 4 If necessary, switch the menu bar off with the **SYSTEM-MENU** button.
- 5 To continue playback, press **PLAY** \blacktriangleright .

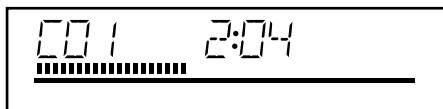

Still picture

- 1 During playback, press **PAUSE** to stop playback and display a still picture. It will proceed to a next frame when you press **PAUSE** again.

Tip

Frame advance via menu bar

- 1 During a still picture press **SYSTEM-MENU** on the remote control. The menu bar will appear at the top of the screen.
- 2 Select the “◀▶” symbol using ▶ or ◀ and confirm with ▼.
- 3 You can now use the ◀ or ▶ button to go forwards or backwards one frame at a time.
- 4 If necessary, switch the menu bar off with the **SYSTEM-MENU** button.

- 2 To continue playback, press **PLAY**.

Slow motion

- 1 During playback press **PAUSE** on the remote control. Now press ◀◀ or ▶▶ to switch to slow motion.
- 2 You can switch between different speeds using ◀◀ or ▶▶.

Tip

Slow motion via menu bar

- 1 During playback press **PAUSE** and then **SYSTEM-MENU** on the remote control. The menu bar will appear at the top of the screen.
- 2 Select the “▶” symbol using ▶ or ◀ and confirm with ▼.
- 3 You can now use the ◀ or ▶ button to select different forward and backward slow motion speeds.
- 4 If necessary, switch the menu bar off with the **SYSTEM-MENU** button.

- 3 To continue playback, press **PLAY**.

Search by time

Using this feature you can select where playback should start (select elapsed time).

- 1 During playback press **SYSTEM-MENU** on the remote control. The menu bar will appear at the top of the screen.
- 2 Select the “⌚” symbol using ▶ or ◀ and confirm with ▼. Playback is stopped and a box appears on the screen showing the elapsed time.
- 3 Enter the start time with the digit keys **0..9** from where playback should start.
- 4 Confirm with **ENTER/OK**.





Problem

- ✗ **The time entered will flash on the screen**
- ✓ The selected title is shorter than the time entered. Enter a new time.

- 5 Playback starts at the time you entered.



Repeat play

You can mark entire sections or the whole disc for endless playback. Depending on the type of disc (DVD video, DVD+RW, video CD) you can select a chapter, title or the entire disc. DVD+RW and DVD+R cannot repeat an entire disc.

- 1 Select the desired chapter, title or the entire disc and start playback.
- 2 During playback, press **REPEAT**. By pressing **REPEAT** recurrently you can make a choice from the following options:
 -) “” : repeat chapter (DVD only)
 -) “” : repeat track/title
 -) “” : repeat entire disc
 -) Display disappears: no repeat
- 3 To end the repeat, press the **STOP**  button.
You can also keep pressing the **REPEAT** button until the displays disappear.

Repeating a passage (A-B)

To repeat or loop a sequence in a title:

- 1 Press **A-B** at your chosen starting point;
 appears on screen.
- 2 Press **A-B** again at your chosen end point;
 repeat appears on screen, and the repeat sequence begins.
- 3 To exit the sequence, press **A-B**.

Shuffle

DVD Discs

This shuffles the playing order of chapters within a title, if the title has more than one chapter.

- 1 Press **SHUFFLE** during playback.
- 2 To return to normal playback, press **SHUFFLE** again.

Video CDs

This shuffles the playing order of tracks within a disc, if the disc has more than one tracks.

- 1 Press **SHUFFLE** during playback.
- 2 To return to normal playback, press **SHUFFLE** again.

Scan feature

This feature plays back the first 10 seconds of each chapter (DVD) or track (CD).

- 1 During playback, press **SCAN**.
- 2 After 10 seconds the DVD recorder switches to the next chapter/index. To start playback at the relevant chapter/index press **PLAY** .

Camera angle

If the disc contains sequences recorded from different camera angles, the angle box appears, showing the number of available angles, and the angle being shown. You can then change the camera angle if you wish.

- ① Press **ANGLE**.
- ② Use ▼ or ▲ to select the required angle in the angle box.
- ③ To go to any angle directly, enter the angle number using the numerical keys **0..9**. After a small delay, play changes to the selected angle. The angle box remains displayed until multiple angles are no longer available.

Tip

You can also use this function through an on-screen menu (a system menu bar).

Zoom feature

The Zoom function allows you to enlarge the video image and to pan through the enlarged image.

- ① Press **Zoom**.
- ② Press ▼ or ▲ to activate the Zoom function and select the required zoom factor; 1.33 or 2 or 4.
The recorder will go into pause mode.
The selected zoom factor appears below the Zoom icon in the system menu bar and “**Press OK to pan**” appears below the system menu bar.
The picture will change accordingly.
- ③ Press **ENTER/OK** to confirm the selection.
The panning icons appear on the screen.
- ④ Use ▲, ▼, ►, ◀ to pan all over the screen.
- ⑤ When **ENTER/OK** is pressed only the zoomed picture will be shown on the screen.
- ⑥ Press ▷ to exit zoom mode.

Tip

You can access to Zoom function by an on-screen menu (a system menu bar).

Select the audio language

Many pre-recorded DVD discs have more than one audio language. The language initially selected for playback will be the one you selected when you first set up the DVD recorder. However you can change the audio language of the inserted disc at any time. You can change the audio language either using the menu of the inserted disc (**TOP MENU** button) or the **AUDIO** button. The audio languages for DVD playback in the two menus may be different. Please note that with some DVDs the audio language and/or subtitle language can be changed only via the DVD menu.

- 1 During playback press **AUDIO**.
- 2 Select the required audio language by pressing **AUDIO** repeatedly.
- 3 Play continues in the new audio language.

Tip

You can select an audio language in an on-screen menu (a system menu bar).

Subtitles

Many pre-recorded DVD discs have more than one subtitle language. The language initially selected for playback will be the one you selected when you first set up the DVD recorder.

However you can change the subtitle language of the inserted disc at any time. The subtitle languages in the menus may differ.

- 1 During playback press **SUBTITLE**.
- 2 Select the required subtitle language by pressing **SUBTITLE** repeatedly.
- 3 Playback continues in the new subtitle language.

Tip

An access to **SUBTITLE** function through the on-screen menu

- 1 During playback press **SYSTEM-MENU** and select the “

Tip

An access to **SUBTITLE** function through the top menu of the disc

- 1 Press **TOP MENU** to go to the top menu of the disc.
- 2 Follow the disc's instruction.

8. Manual recording

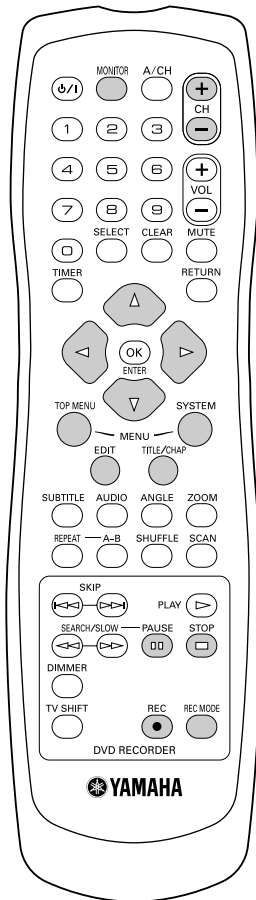

General

Question

Which discs can I use for recording?

With this DVD recorder, you can record on two types of DVD:

DVD+RW

This disc can be written to and then the contents deleted.

DVD+R

This type of disc can only be recorded once.

If you want to play this DVD in a DVD player it must be finalized using the **“Finalise disc”** function. It is not possible to make further recordings using this disc.

If this disc is to be played in a DVD recorder it must not be finalised.

Recordings can be added and deleted. The disc space (playback time) from the deleted recording cannot be recovered for further recordings

Use the “Manual recording” function to spontaneously start recording (e.g. to record a TV show already in progress).

In the “index display” select the title to be overwritten or **“Empty title”** with **▼, ▲**.

If you insert recordings between existing recordings, check the lengths of the old and new recordings. If the new recording is too long the subsequent recording (title/chapter) will be overwritten.

Tip

Insert new recordings at the end of all existing recordings (Safe Record)

To add a new recording at the end of the last recording on the disc, hold down the **REC ●** button until the message “SAFE REC” appears on the display.

For DVD+R discs each new recording is always added at the end of all previous recordings as existing recordings cannot be overwritten.

End of disc is reached

If the end of a disc is reached during recording, recording will stop and the Recorder will turn itself off automatically.

Please refer to section **“Recording without automatic switch-off”**, if you want to manually start and stop your own recording.

If you want to start a recording manually but have it stopped automatically, read the section **“Recording with automatic switch-off”**. (e.g. not to record to the end of the disc)

Read the section **“Direct record”** if you want to record a programme currently being shown.

Recording without automatic switch-off

- ❶ Switch on the TV set and select the programme number for the DVD recorder.
- ❷ Insert a disc on which the recording is to be made. This disc is then checked for content and system. "READING" will appear on the display.

Problem

✗ Index display

✓ A DVD+RW disc has been inserted that already contains recordings. Use the ▲ or ▼ button to select the point where the recording is to start.

✗ The message "EMPTYDISC" appears in the display

✓ The disc inserted is a blank DVD disc.

✗ A dialog box appears asking you whether you want to delete the contents or eject the disc

✓ The disc inserted is a DVD+RW but its contents are not DVD video-compatible (e.g. a data disc). Recordings on this disc can only be made if the entire disc is first deleted with the **REC ●** button.

✗ The message "Too many titles" appears on the screen if a recording is to be made

✓ A disc may contain a maximum of 48 titles (including blank titles). Delete titles or change the disc.

- ❸ If necessary, use the **MONITOR** button on the remote control to switch to the internal tuner in the DVD recorder.
- ❹ Use **CH+** or **CH-** to select the programme number (station name) you want to record. This will appear on the display:



Tip

Programme number of the external inputs:

"EXT2" SVHS jack (Y/C) **S-VIDEO IN** Video jack (CVBS) **Video in**, Audio jack **IN AUDIO R** for SVHS-jack and Video jack.
Switching between jack **S-VIDEO IN** and **Video in** is done automatically. In case both jacks are occupied, the signal at jack **S-VIDEO IN** is given priority.

"EXT1" Component Video jacks on the back **IN COMPONENT VIDEO**, Audio jacks **IN AUDIO LR** for Component Video

"CAM1" SVHS-/Audio front jacks **S-VIDEO / left AUDIO right**

"CAM1" Video/Audio front jacks **A/V VIDEO / left AUDIO right** Switching between jack **S-VIDEO** and **VIDEO** is done automatically. In case both jacks are occupied, the signal at jack **S-VIDEO** is given priority

"CAM2" Digital video (i.Link) front jack **DV IN**

- ❺ To start recording, press **REC ●** on the remote control or **REC** on the DVD recorder.

If you want to start the recording at the end of the existing recordings, hold down the **REC ●** button until the message "SAFE REC" appears on the display.

For DVD+R discs each new recording is always added at the end of all previous recordings as existing recordings cannot be overwritten.

This will, for example, appear in the display:

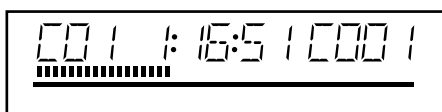

Tip

Insert chapter markers

During recording you can mark scenes so you can find them or hide them later. During recording, press **EDIT** at the start point. "**Inserting chapter marker**" appears on the TV screen. In the display, the number of the "CHAPTER" increases by one.

For further information on titles and chapters, see the section on "Changing to another title/chapter" in "Additional playback features".

- ⑥ Use the **STOP** button on the remote control or on the machine to stop the recording. "MENU UPDT" will appear on the display. The DVD recorder is writing the list of contents. Wait until the message disappears from the display. The recording is then complete.

Problem

✗ The display will read "DISC ERR"

- ✓ Recording could not be completed correctly because of a disc error. Check the disc and clean it if necessary.

Tip

Making recordings on DVD+R discs compatible

If you want to play back the recording on a DVD player, you need to finalise the disc in the DVD recorder. You can prepare your DVD for use in a DVD player using the "**Finalising**" feature. See "Finalising DVD+R discs" in "Managing the disc contents".

Interrupt recording (Pause)

- ① During recording press **PAUSE** , for example to avoid recording the commercials.
- ② To continue recording, press **REC** ●.

Tip

End recording

To end the recording, press the **STOP** button. Wait until "MENU UPDT" disappears from the display.

Recording with automatic switch-off (OTR one-touch-recording)

- 1 Insert a disc.
- 2 If necessary, use the **MONITOR** button on the remote control to switch to the internal tuner in the DVD recorder.
- 3 Use **CH+** or **CH-** to select the programme number (channel name) you want to record.
- 4 Press **REC ●** on the remote control.
- 5 Each time you press **REC ●** you will add 30 minutes to the recording time.

Question

How can I cancel the recording time I have just entered?

To delete an entry, press **CLEAR** while the display shows the recording time.

How can I check the remaining recording time?

Press **SYSTEM-MENU** while an OTR is in progress. The time at which the recording will end will appear on the TV screen in the timer info box.

Preventing accidental erasing of discs

To ensure you don't accidentally delete a recording you can protect the entire disc. You can only ever protect the entire disc. You cannot protect individual recordings.

Question

What happens with DVD+R discs?

As long as these discs are not finalised, they can be protected against accidental erasure in the same way as DVD+RW discs.

- ① Insert the disc to be protected.
- ② Press **DISC-MENU**. The index screen will appear.
- ③ While the index screen is displayed press **STOP** on the remote control. The first title is highlighted.
- ④ Press **▲**. This takes you to the disc info screen.
- ⑤ Press the **▶** button.
Select the "**Protection**" line.
Confirm with **▶**.
- ⑥ Select "**Protected**" with the **▼** button and confirm with **ENTER/OK**.
- ⑦ Press **◀** and then **TOP MENU** to terminate.

The entire disc is now protected.

If an attempt is made to record on a protected disc, "DISC LOCK" will appear on the display and "**Disc locked**" will appear on the screen.

Tip

If you later decide to record on the disc, follow these steps but select "**Unprotected**" at step ⑥.

Lining up recordings within a title (assemble cut)

On a recorded DVD+RW disc you can add another recording to an existing title. This recording is added to the title as a “chapter”. The existing information will be overwritten starting from this point. Titles will also be overwritten that follow the current title depending on the length of the new recording. The recording type (Quality) will be taken from the current title.

To play back this recording, press **SYSTEM-MENU** and use the ► button to select the “C” (Chapter) symbol. You can also use the **TITLE/CHAP** key.

For further information, see “Changing to another title/chapter” in “Additional playback features”.

Question

What happens with DVD+R discs?

New recordings on “DVD+R” discs can only be added after existing recordings. It is not possible to overwrite existing recordings on “DVD+R” discs.

- 1 In the index display, find the title to which the new recording is to be added.
- 2 Look at the last minute of the old recording.
- 3 Press **PAUSE** [] on the remote control at the position where the new recording is to go. “■■” will appear on the screen.
- 4 To monitor the recording you can press **MONITOR** to switch to the internal tuner.
- 5 Now start recording as usual by pressing **REC** ● on the remote control. The new recording will be inserted.
- 6 Stop recording with **STOP** [] .

Selecting the recording type (Quality)

You can select the picture quality of the recording using the recording quality feature and hence the maximum recording time per disc.

You can check the quality by changing the recording mode and then watching the picture from the built-in tuner (**MONITOR** button).

When you playback the recorded material, the adequate playback mode for the selected recording type will apply automatically.

- 1 Switch on the TV set. If required, select the programme number for the DVD recorder.
Select the record mode with the button **REC MODE** on the remote control.

Tip

Which recording types can I choose?

“**M1**”: High Quality offers the best picture and sound quality and a recording time of 1 hour.

“**M2**”: This mode offers the best quality audio and standard play (close to pre-recorded DVD) quality video.

“**M2x**”: Standard Play plus (better than S-VHS quality) offers standard picture quality and a recording time of 2.5 hours.

“**M3**”: Long Play (S-VHS picture quality). Recording time of 3 hours.

“**M4**”: Extended Play (better than VHS picture quality). Recording time of 4 hours.

“**M6**”: Super Long Play (VHS picture quality). Recording time of 6 hours.

Can I select the recording type via a menu as well?

- 1 Press the **SYSTEM-MENU** button.
- 2 Select “**T**” symbol with ◀ or ▶.
- 3 Select “**Record settings**” using ▲ or ▼ and confirm with ▶.
- 4 In the line “**Record mode**” select the recording type with ◀ or ▶.
- 5 Confirm using **ENTER/OK** and **SYSTEM**.
- 6 If you have selected the recording mode “**M4**” or “**M6**”, you can select the settings “**Stndrd**” (Standard) or “**Sport**” (for rapid movements) in the “**Filter mode**” line.

9. Managing the disc contents

General

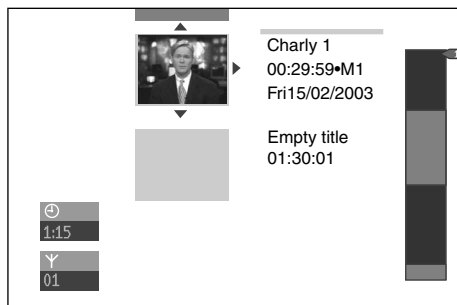

When a recording is made to disc, the following additional information is also stored at the beginning of the recording:

-) Name of the recording
-) Length of the recording
-) Record type (Quality)
-) Date of the recording
-) Index picture of the recording

If the TV station does not transmit a name, only the channel number and time will be stored as the name

A marker will be set every 5-6 minutes if the “**Auto chapters**” function is activated in the “**Record settings**” menu. This marker is known as a “chapter”. These markers can be changed when the recording has finished.

Question

Can markers be set on a DVD+R disc?

Markers can be set on these discs if they have not been finalised.

It is also possible to add “chapters” later. This means that scenes you do not want to see during playback, such as commercials, can be hidden or skipped. During playback you can watch your recording as a continuous sequence without the hidden chapters.

Select from the following chapters:

“EDIT”,

to divide the title into chapters or to manage the chapters.

“Editing recording titles (name)”,

to change the recording names.

“Play complete title”,

to play the entire title including the hidden chapters.

“Delete recording/title” to delete the relevant title and therefore also the recording.

“Disc settings” to change the general settings of the disc.

EDIT

In this menu you can adapt a title to suit your particular needs.

You can insert/delete chapter markers, hide chapters, select a new index, or split up a title.

Insert chapter markers

During playback, you can set or delete chapter markers within a title.

The maximum number of chapters per disc is 124 and 99 per title. If one of these limits is reached the following message will appear on the screen: **“Too many chapters”**. You need to delete some markers before you can insert new ones or make recordings.

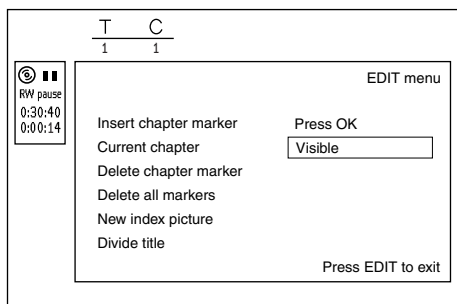

- 1 During playback, press **EDIT** on the remote control at the appropriate point. The **“EDIT”** menu appears on the TV screen.
- 2 Press **▲** or **▼** to select **“Inserting Chapter marker”** and confirm with **ENTER/OK**. **“Inserting chapter marker”** appears on the TV screen.

Tip

“X” will appear on the screen:

This DVD is write-protected or the disc is a finalised DVD-R. Subsequent changes cannot be made.

- 3 To stop this function, press **EDIT**.

Hiding chapters

Initially, all the chapters are visible. You can hide chapters for playback (e.g. advertisements) or make them visible again. In editing mode, hidden chapters are shown as dimmed.

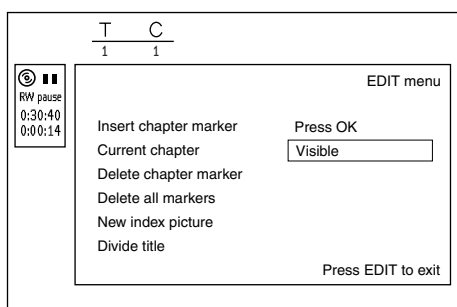

- 1 While the relevant chapter is playing, press **EDIT** on the remote control. The **“EDIT menu”** appears on the TV screen.

Tip

How can I select different chapters?

- 1 Press the **TITLE/CHAP** button on the remote control. Titles and chapters are displayed at the top of the screen.
- 2 Select title (T) or chapter (C) with **▶** or **◀**.
- 3 Use **▲** or **▼** to select the title/chapter channel you want to edit.

- 2 Select **“Current chapter”** using **▼**.
- 3 Using **▶** select **“Hidden”**. The picture is shown darker.

Tip

Switching quickly

You can switch between show chapters (**“Visible”**) and hide chapters (**“Hidden”**) quickly and easily using **SELECT**.

- 4 To end, press **EDIT**.

During playback this chapter will be skipped.

If the chapter is not visible, select **“Visible”** in step 3 with **▶**.

Deleting chapter markers

Within a title you can delete either all markers or individual markers.

- 1 While the relevant chapter is playing, press **EDIT** on the remote control. The “**EDIT menu**” appears on the TV screen.

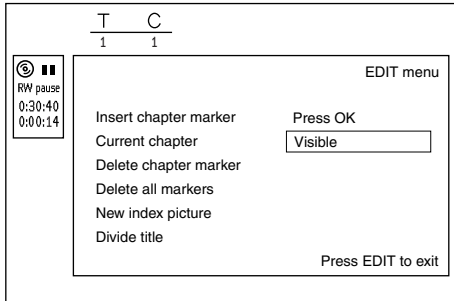

Tip

How can I select different chapters?

- 1 Press the **TITLE/CHAP** button on the remote control. Titles and chapters are displayed at the top of the screen.
 - 2 Select title (T) or chapter (C) with **▶** or **◀**.
 - 3 Use **▲** or **▼** to select the title/chapter channel you want to edit.
- 2 Use **▼** to select either “**Delete chapter marker**” for this chapter or “**Delete all markers**” for all chapters within the selected title.
 - 3 Confirm with **ENTER/OK**.
 - 4 To end, press **EDIT**.

Changing the index picture

As an index picture, the first picture of a recording is normally used, however, you can choose any picture from the recorded material.

- 1 During playback, search for location of the new index picture. Press the **PAUSE** button.
- 2 Press the **EDIT** button. The “**EDIT menu**” appears on the TV screen.
- 3 Select line “**New index picture**” and confirm with **ENTER/OK**.
- 4 Start the change with **ENTER/OK**. “**Updating menu**” appears on the TV screen.

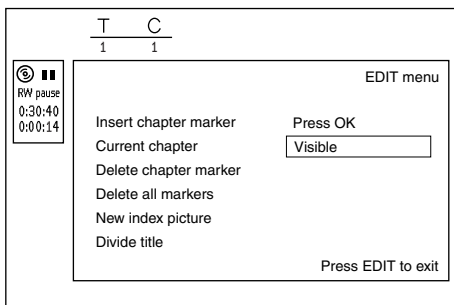

Once the revision has been completed successfully the DVD recorder reverts to the index overview.

Splitting titles

You can split a title into several sections (titles) of any size. Each of these sections (titles) is identified by its own index.

Note: This split cannot be undone.

Question

Can I split titles on DVD+R discs?

As recordings on DVD+R discs cannot be overwritten, it is not possible to split titles.

- 1 While the relevant title is playing, press **EDIT** on the remote control. The “**EDIT menu**” appears on the TV screen.
- 2 Select “**Divide title**” and confirm with the **ENTER/OK** button.
- 3 If you are sure, press **ENTER/OK** to start the process. “**Dividing title**” appears on the TV screen.
- 4 Wait until the new title is displayed with an index picture in the index picture overview.

The process of splitting the title is now complete.

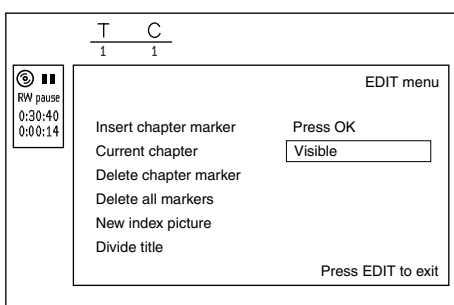

Editing recording titles (name)

Some TV stations transmit the title (name) of a programme. In this case, the name will be included automatically (e.g. "ROCKY"). Otherwise, the only the programme number (programme name) and the time are stored as the name of the recording. The name of the recording can only be changed after the recording has been completed.

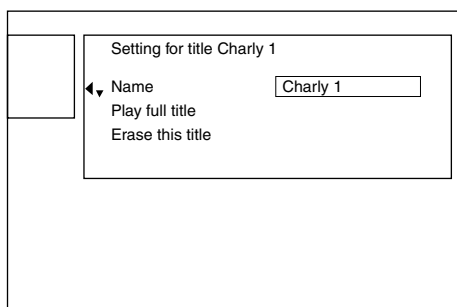

- 1 Press the **STOP** button to stop playback if necessary.
- 2 Using **▲** or **▼** select the title whose name you want to edit and confirm with **▶**. The menu for editing names appears.
- 3 Select "**Name**" using **▲** or **▼** and confirm with **▶**.
- 4 Using **▶** or **◀** select the position where the letter/number/icon is to be changed/re-entered.
- 5 Change the icon using **▲** or **▼**. You can switch between upper and lowercase using **SELECT**. You can delete the character using **CLEAR**.
- 6 Repeat 4 and 5 until you have made the changes you want.
- 7 Save the new name with **ENTER/OK**. "**Storing name**" appears on the TV screen for confirmation.
- 8 To end, press **◀**.

Playing the entire title

If you have hidden certain sections (chapters) of a title, this setting lets you watch the entire title including the hidden sections. To do this, proceed as follows:

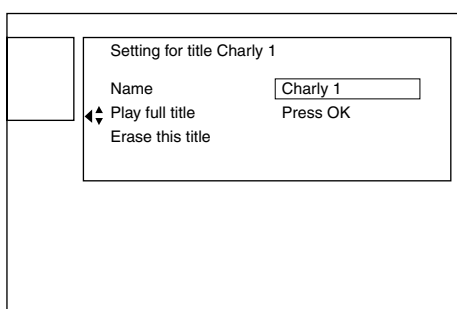

- 1 Press the **STOP** button or during playback press **TOP MENU**.
- 2 Using **▲** or **▼** select the title you want to play entirely and confirm with **▶**. The title editing menu will appear.
- 3 Select "**Play full title**" using **▲** or **▼** and confirm with **ENTER/OK**.
- 4 Playback starts automatically. The full title plays, including the hidden chapters.

Deleting recordings/titles

You can delete specific recordings from a disc. To do this, proceed as follows:

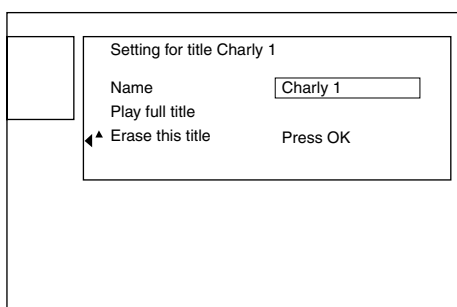

- 1 Press the **STOP** button or during playback press **TOP MENU**.
- 2 Using **▲** or **▼** select the title you want to delete and confirm with **▶**. The title editing menu will appear.
- 3 Select "**Erase this title**" using **▲** or **▼** and confirm with **ENTER/OK**. "**This will completely erase this title**" appears on the TV screen.
- 4 If you want to delete this title, press **ENTER/OK** to confirm. Otherwise press **◀**.
- 5 "**Erasing title**" may appear on the TV screen.
- 6 At this point "**Empty title**" may appear in the "index picture display". A new recording can now be made here. If the deleted title was very short (less than 1 minute) "**Empty title**" will not appear at this point.

Question

Can titles be deleted from a DVD+R disc?

Titles on DVD+R discs are only marked as deleted. “**Deleted title**” will appear in the display instead of “**Empty title**”. During playback the “deleted” title is skipped. The space used for this title cannot be used again as the title has not been physically deleted. Once the disc has been finalised no further changes can be made.

Disc settings

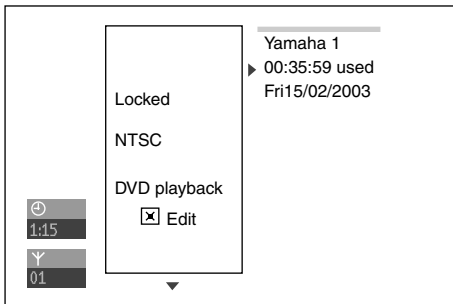

This screen appears **before** the first title and contains general information about the current disc.

You can:

- change the name of the disc
- activate or deactivate write protection on the disc
- Finish editing (make the disc DVD compatible)
- finalise a DVD+R
- delete a DVD+RW

To get to this display, proceed as follows:

- 1 Press the **STOP** button or during playback press **TOP MENU**.
- 2 Select the first title with **▲** or press **STOP** .
- 3 Press the **▲** button. The disc info display will appear.

Changing the disc name

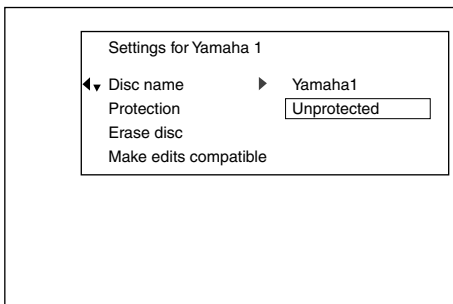

- 1 In the “Disc info display” press **▶**. The “**Settings for**” menu appears on the TV screen.
- 2 Select “**Disc name**” using **▲** or **▼** and confirm with **▶**.
- 3 Using **▶** or **◀** select the position where the letter/number/icon is to be changed/re-entered.
- 4 Change the icon using **▲** or **▼**. You can switch between upper and lowercase using **SELECT**. You can delete the character using **CLEAR**.
- 5 Repeat 3 and 4 until you have made the changes you want.
- 6 Save the new title with **ENTER/OK**. “**Storing name**” appears on the TV screen for confirmation.
- 7 To end, press **◀**.

Finishing editing

If one or more titles have been edited a DVD player may still display the original titles. You can prepare your disc in such a way that a DVD player will be able to play the edited version.

- 1 In the “Disc info display” press **▶**. The “**Settings for**” menu appears on the TV screen.
- 2 Select “**Make edits compatible**” using **▲** or **▼** and confirm with **ENTER/OK**.

Problem

X “Make edits compatible” does not appear

- ✓ Your disc is already compatible. There is no need for conversion.
To end, press **SYSTEM-MENU**.

- ③ The screen displays “**This will take**” to show how long the process will last.
- ④ To confirm press **ENTER/OK**. “**Working**” appears on the TV screen. A bar will move from left to right indicating progress.

Finalising DVD+R discs

This feature is required to play back a DVD+R disc in a DVD player. Once the disc has been finalised no further recordings or changes can be made.

- ① In the “Disc info display” press **▶**. The “**Settings for**” menu appears on the TV screen.
- ② Select “**Finalise disc**” using **▲** or **▼** and confirm with **ENTER/OK**.

Problem

X “Finalise disc” does not appear

- ✓ Either there is no DVD+R disc inserted or the disc is already finalized.
To end, press **SYSTEM-MENU**.

X The “Settings for” menu does not appear

- ✓ The menu may not appear if the disc has been recorded on another DVD recorder. In this case, use the “**Finalise disc**” feature in the “**▶**” menu, under “**Disc features**”.

- ③ When finalizing is complete, you will return to index picture screen.

Delete DVD+RW discs

- ① In the “Disc info display” press **▶**. The “**Settings for**” menu appears on the TV screen.
- ② Select “**Erase disc**” using **▲** or **▼** and confirm with **ENTER/OK**. “**This will erase all titles**” appears on the TV screen. Press **ENTER/OK** to confirm. Otherwise press **◀**.
- ③ “**Erasing disc**” appears on the TV screen.
- ④ After deletion, the index picture display shows the free space on the disc.

Tip

If the disc is empty already, you cannot select “**Erase disc**”.

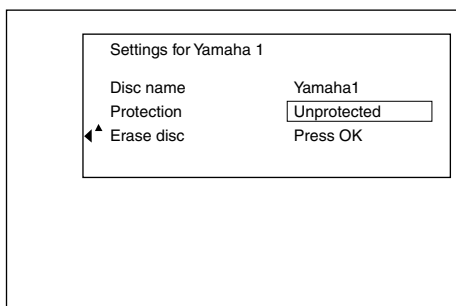

10. Programming a recording (TIMER)

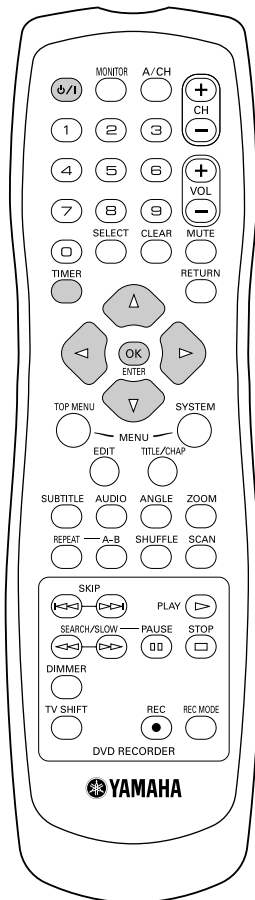

General

Use "Programming a recording (TIMER)", to automatically start and stop a recording at a later date.

The DVD recorder will switch to the right programme number and begin recording at the correct time.

With this DVD recorder, you can pre-programme up to six recordings within a period of one month.

To make a programmed recording, your DVD recorder needs to know:

- * the date you want to make the recording
- * the programme number of the TV channel
- * the start and stop time of the recording
- * the recording mode ("**M1/M2/M2x/M3/M4/M6/FR**")

This information is saved in a "TIMER block".

Before you begin, make sure the clock is set. If the clock is not set, the "**Time/Date**" menu will appear when you press the **TIMER** button.

Question

What is "FR mode"?

FR mode is used when you want to record a certain length of program but you don't know how much room remaining on the recording disc. By using this mode, this unit automatically selects the best suitable recording mode for the length of the program. You cannot select FR mode, when you set the recording timer of Mo-Fr/Weekly, and when you set PDC/VPS on. We strongly recommend that you do not use this function combined with VPS/PDC. In such a condition this DVD recorder may not perform the task properly.

Programming recordings with the VCR Plus+® System

Thanks to this programming system, you no longer need to tediously enter the date, TV channel, start and end times. All the information needed for programming is contained in the PlusCode programming number. This 8-digit PlusCode number is found in most TV listings for magazines.



- ❶ Switch on the TV. Select the channel number for the DVD Recorder (channel 3 or 4 or the Audio/Video In channel).
- ❷ With the Recorder on, press **TIMER** on the remote control. The programming method selected last is marked.
- ❸ Select line "**VCR Plus+ system**" using **▼** or **▲** and confirm with **▶**.
- ❹ Enter the entire PlusCode number. This number is up to 9 digits long and can be found next to the start time of the TV program in your TV listings magazine.
e.g.: 5-234-89 or 5 234 89
Enter 523489 for the PlusCode number.
If you make a mistake, you can clear the entry with **CLEAR**.

Timer VCR Plus+system	
PlusCode number -----	
Mo-Fr/Weekly Press SELECT	To store Press OK

Tip

Selecting daily/weekly recordings

Using **SELECT**, select from the following options:

"**Mo-Fr**": Repeated daily recordings (Monday to Friday).

"**Weekly**": Repeated weekly recordings (every week on the same day).

- ❺ Confirm with **ENTER/OK**.

Problem

✗ The following message appears on the screen: "**Please enter channel number**"

✓ The channel number of the TV channel has not yet been assigned to the PlusCode number. Using **▶**, **◀** or the number buttons **0..9** on the remote control, select the corresponding channel number (name) of the TV channel and confirm with **ENTER/OK**.

✗ The following message appears on the screen: "**PlusCode number wrong**"

✓ The entered PlusCode number is incorrect. Repeat your entry or cancel using the **SYSTEM-MENU** button.

✓ Check the time/date (see "Setting the time & date" in "Installing your DVD recorder").

✗ The following message appears on the screen: "**Date does not match Mon-Fri**"

✓ A daily recording was entered for the wrong day. Daily programming can only be used for recordings to be made from Monday to Friday.

- ❻ The decoded data appears after confirmation. You can go back and change the data. Select the appropriate input field with **▶** or **◀**. If required, make changes using **▼**, **▲** or the number buttons **0..9**.

Timer VCR Plus+system				
Date	Ch.	Start	End	Rec Mode
01/22	001	08:30AM	10:00PM	M1
To store Press OK				

Tip

Change "AM/PM"

Use the SELECT button to select "AM" or "PM" in the input fields "Start" and "End".

Changing the recording mode

Select "RecMode" using ►.

Using ▼, select the recording mode "M1, M2, M2x, M3, M4, M6, FR".

- 7 If all information is correct, press the **ENTER/OK** button. The programming information is stored in a **TIMER** block.
- 8 To end, press **TIMER**.
- 9 Insert a recordable disc (one without write protection). The disc you have inserted will be checked.
- 10 Switch the DVD recorder off with **⏻/⏷**. The programmed recording will only function properly if the DVD recorder has been **switched off** using the **⏻/⏷** button.

If any of the **TIMER** blocks are in use, "**TIMER**" will light up on the recorder display.

Programming recordings without the VCR Plus+® System

- 1 Switch on the TV set. If required, select the programme number for the DVD recorder.
- 2 Press **TIMER** on the remote control. The programming method selected last is marked.
- 3 Select line "**Timer programming**" with ▼ or ▲, and confirm with the ► button. The information will appear on the screen.
- 4 Select the input field with ◀ or ▶.
- 5 Enter information with ▼ or ▲ or with the number buttons **0..9**.

Timer				
Timer programming				
Date	Ch.	Start	End	Rec Mode
01/22	01	08:30AM	10:00PM	M1

Mo-Fr/Weekly
Press SELECT

To store
Press OK

Tip

Selecting daily/weekly recordings

In "**Date**" use SELECT to select from the following options:

"**Mo-Fr**": Repeated daily recordings from Monday to Friday

"**Mo**": Repeated weekly recordings (every week on the same day, e.g. Monday).

Program numbers of the "EXT1" and "EXT2" cinch jack

You can also program recordings from external sources via **S-VIDEO IN, Video in ("EXT1")** or **IN COMPONENT VIDEO ("EXT2")**.

Change "AM/PM"

Use the **SELECT** button to select "AM" or "PM" in the input fields "Start" and "End".

Changing the recording quality

Select the "**RecMode**" input field using ►.

Use ▼, ▲ to select the recording mode.

- 6 If all information is correct, press the **ENTER/OK** button. The programming information is stored in a **TIMER** block.
- 7 To end, press **TIMER**.
- 8 Insert a DVD (one without write protection). The disc you have inserted will be checked.

- 9 Switch off with $\text{\textcircled{I}}$.
The programmed recording will only function properly if the DVD recorder has been **switched off** using the $\text{\textcircled{I}}$ button.

If any of the TIMER blocks are in use, "**TIMER**" will light up on the recorder display.

How to change or delete a programmed recording (TIMER)

- 1 Switch on the TV set. If required, select the programme number for the DVD recorder (channel 3 or 4).
- 2 Press **TIMER** on the remote control.
The programming mode selected last is marked.
- 3 Select "**Timer List**" using \blacktriangledown or \blacktriangle and confirm with \blacktriangleright .
- 4 Select the programmed recording (TIMER) you want to check, change or delete with \blacktriangledown or \blacktriangle .

Timer		Timer List			Rec
Date	Ch.	Start	End	Mode	
01/22	01	04:25PM	06:05PM	M2	
--/--	----	--:--	--:--	---	
Total record time: 01:40					
To change			To exit		
Press >			Press TIMER		

Tip

Delete programmed recording

- 1 Press the **CLEAR** button.
- 2 Confirm with **ENTER/OK**. "**Timer Cleared**" will briefly appear on the TV screen.
"-- --" appears rather than the displayed values
- 3 To end, press **TIMER**.

- 5 Press \blacktriangleright .
Select the input field with \blacktriangleleft or \blacktriangleright .
If required, change the information with \blacktriangle , \blacktriangledown or the number buttons **0..9**.
- 6 Confirm with **ENTER/OK**.
- 7 To end, press **TIMER**.
- 8 Switch off with $\text{\textcircled{I}}$.

Problem solving for programmed recordings

PROBLEM

SOLUTION

The DVD recorder is not responding

- ✓ While a programmed recording is being made, you cannot operate your DVD recorder manually. If you want to cancel the programmed recording, press **⏻/⏸**.

“Switch off, timer recording” flashes on the TV screen.

- ✓ The DVD recorder was switched on several minutes before the start of a programmed recording. Switch off the DVD recorder using **⏻/⏸**. A programmed recording (timer) will only function if the DVD recorder is switched off (**⏻/⏸** button).

Error message: “Insert recordable disc”

- ✓ Either a disc has not been inserted or the disc cannot be used for recording. Insert a disc on which recordings can be made. Switch off the DVD recorder using **⏻/⏸**.

The error message “Disc locked” appears briefly on the screen.

- ✓ A write-protected disc has been inserted. Undo the write protection (see “Preventing accidental erasing of discs” in “Manual recording”) or insert a different disc.

Error message: “Memory full”

- ✓ If this error message appears after pressing **TIMER**, then all **TIMER** blocks are already programmed. No more recordings can be programmed. Press the **▶** button. If you want to clear or check a programmed recording (**TIMER** block), select it with **▲** or **▼**.

The “Data error” message appears on the screen.







- ✓ The data for the recording could not be transferred. Please check date, start time and end time of the programmed recording.

The “Collision” message appears on the screen.

- ✓ Two programmed recordings overlap.
- ✓ If you ignore this error message the show with the earlier start time will be recorded first. The start of the second show will not be recorded.
- ✓ Change the setting for either of the two recordings.
- ✓ Clear either of the two recordings

11. User preferences

In this section you will learn how to set your user preferences on the DVD recorder. The symbols have the following meanings:

	Picture settings
	Sound settings
	Language settings
	Additional settings
	Disc settings
	Recording settings
	Installation

- 1 Switch on the TV set. If required, select the programme number for the DVD recorder.
- 2 Press **SYSTEM-MENU** on the remote control. The menu bar appears.
- 3 Select “ ” using ◀ or ▶ and confirm with ▼.
- 4 Select the appropriate function with ▼ or ▲ and confirm with ▶.
- 5 Select the appropriate line using ▼ or ▲ and confirm with ▶.
- 6 Select the appropriate function using ▼ or ▲ or the setting with ◀ or ▶.
- 7 Confirm the new setting by pressing **ENTER/OK**.
- 8 To close the menu item, press ◀.

Picture settings

You can choose the following features in this menu:

“TV Shape”

The picture signal from your DVD Recorder can be set to match your TV screen.
“**4:3 letterbox**”: for a “wide-screen” picture with black bars at the top and bottom
“**4:3 panscan**”: for a full-height picture with the sides trimmed.
“**16:9**”: for a wide-screen TV set (screen edge ratio 16:9)

“Black level shift”

Adapts the colour dynamics for NTSC playback

“Video shift”

Use this feature to adjust the position of the picture on your TV left or right using ◀▶ to suit your TV set.

“EXT1 video attenuation”

Adjusts the brightness level for recording when connected with YPbPr.

“Optimize video output”

This allows you to switch the Component Video signal between “**Interlaced**” and “**Progressive Scan**”.

Warning: If your TV has separate connections for “**Interlaced**” and “**Progressive Scan**” or it does not switch automatically between the two, it is possible that no picture will appear on the TV after it is switched from one to the other.

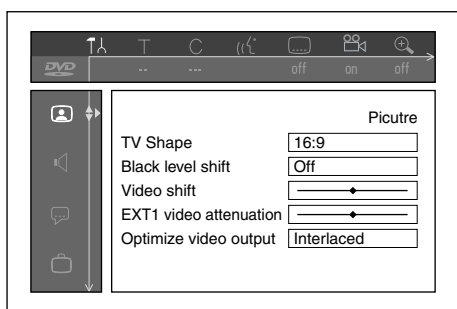

Problem

X No picture appears on the TV after switching

Check the display of your DVD recorder.

“**PRO**”: “**Progressive Scan**” is on

No display: “**Interlaced**” is on. Switch your TV to the corresponding input jack or select the corresponding connection. You can also switch the Component video output signal as follows:

- 1 Disconnect the recorder’s power cord.
- 2 Hold down \llcorner on the DVD Recorder while reconnecting the power cord. “**PRO**” (progressive scan) appears on the display.
- 3 If you want to switch back, repeat steps 1 and 2. “**PRO**” disappears from the display. The DVD Recorder is switched to “**Interlaced**.”

Sound settings

Depending on which audio outputs are used, you can select the settings in this menu. If you only use the analogue audio output (**AUDIO L, R**), select the settings “**Off**” in the “**Digital output**” menu.

“**Digital output**”

For devices connected to the **DIGITAL AUDIO OUT** jack, you can select from the following settings.

“**All**”: Unaltered signals of Dolby Digital and DTS are fed to the digital output. MPEG-2 multi-channel signals are converted to PCM (Pulse Code Modulation).
For receivers/amplifiers **with digital multi-channel sound decoders**.

“**PCM only**”: Dolby Digital and MPEG-2 multi-channel signals are converted to PCM (Pulse Code Modulation).
For receivers/amplifiers **without digital multi-channel sound decoders**.

“**Off**”: Digital output switched off.
For devices **with analogue audio input**.

“**Analog output**”

For devices connected to the analogue audio output (**AUDIO L, R**), you can select from the following settings.

“**Stereo**”: For devices without Dolby Surround, use this setting if the DVD recorder is only connected to a stereo TV set.

“**Surround**”: Dolby Digital and MPEG-2 multi-channel are mixed down to a Dolby surround-compatible two-channel output signal. For devices **with Dolby Surround Pro Logic decoder**.

“**Night mode**”

Night mode optimises the sound for playback at low volume. You are therefore less likely to disturb your neighbours. This only works for Dolby Digital audio on DVD video discs.

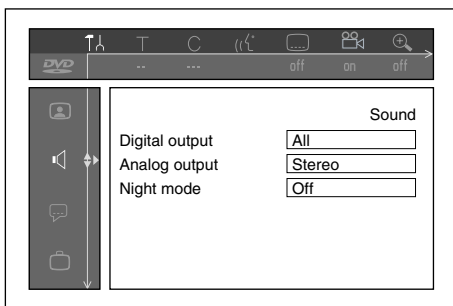

Language settings

You can choose the following settings in this menu:

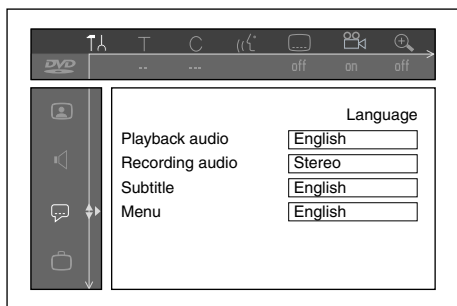

“Playback audio”

Playback audio language

“Recording audio”

A choice between Stereo and SAP

“Subtitle”

Subtitle language

“Menu”

Screen menu language

Additional settings

You can select the following functions in this menu:

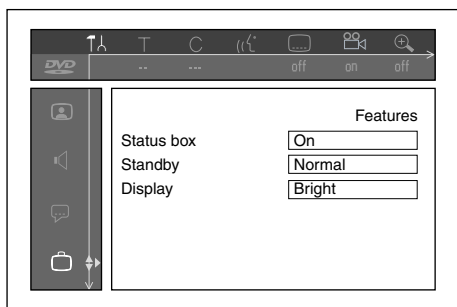

“Status box”

Along with the on screen menu, the OSD (On Screen Display) also displays information on the current operating status (counter, playback, recording, TV channel, etc.) on the TV screen.

You can switch off the information about the operating status so that the on screen display (OSD) is not recorded during copying.

“On”: The OSD information appears in every selected mode for a few seconds and disappears again.

“Off”: The OSD information is switched off. It is **no longer** displayed on the screen.

“Standby”

To save power, you can switch off the clock display on the DVD recorder. Programmed (TIMER) recordings will still take place.

In addition, you can present the most important features of the DVD recorder in scrolling text in the display (demo).

“Low power”: If the DVD-Recorder is switched off (button \odot/II), the clock display is also switched off.

“Normal”: If the DVD-Recorder is switched off (button \odot/II), the clock display is visible.

“Demo mode”: If the DVD recorder is switched off with the \odot/II button, a list of the most important features is shown in the display.

“Display”

You can change the brightness of the display on the DVD recorder. This setting only affects the DVD recorder when it is switched on.

“Bright”: The display appear with normal brightness.

“Dimmed”: The display appears less bright.

“Off”: The display is switched off.

Disc feature menu

In this menu you can make the changes that relate to the disc:

“Access control”

Please read the next chapter on “Access control (child lock)”.

“Auto resume”

If playback of a pre-recorded DVD video disc or video CD is interrupted (button **STOP**  or **▲ Open/Close**) when the disc is reloaded (disc is started) playback starts at the precise location where it stopped. This applies not only to the current disc but to the last 20 discs played.

This feature can be switched off if not required.

“PBC”

This line appears only if a VCD is loaded.

This function lets you activate or deactivate the PBC menu (Playback Control) for video CDs.

See “Playing a (Super) Video CD”.

“Finalise disc”

This feature allows you to finalise DVD+R discs. If the disc has already been finalised this line will appear darker.

“Adapt disc format”

If a DVD+RW has been recorded in a computer drive or in another DVD recorder the index screen may not be displayed correctly.

This feature allows you to change the format of the disc.

It is therefore only visible if the disc format is different.

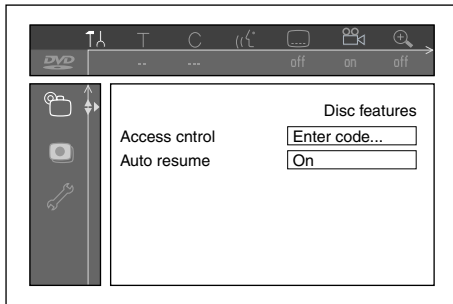

12. Access control (Child Lock)

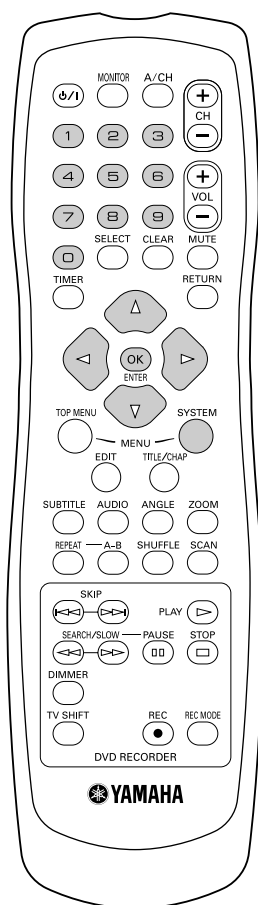

Child lock (DVD and VCD)

This feature enables discs to be locked for children.

When Child Lock is on, a 4-digit code (PIN) needs to be entered before a disc can be played.

You can also decide whether the inserted disc should always be played or should be played only once, despite the child lock

•) “Play always”:

This disc is stored in a memory with space for 50 child-safe discs. If more than 50 discs are stored, the last disc in the list is removed and the new disc is added. The screen shows “Child safe” at the start of playback.

•) “Play once”:

This disc is only authorised for single playback. If the recorder is switched off, the PIN code must be re-entered.

Activating/deactivating child lock

- 1 Switch on the TV set. If required, select the programme number for the DVD recorder.
- 2 Switch on the DVD recorder using /I.
- 3 Press **SYSTEM-MENU**. The menu bar appears.
- 4 Select the “” icon using or .
- 5 Select “ (Disc features)” using or and confirm with .
- 6 Confirm “**Access control**” using .
- 7 Enter a 4-digit code of your choice. If the code is new, you may have to enter the code a second time as confirmation.
- 8 Select “**Child lock**” using or and confirm with .
- 9 Select the “” icon using or .
- 10 Confirm with **ENTER/OK**.
- 11 Quit the feature using and **SYSTEM-MENU**.

Unauthorised discs can only be played by entering the four-digit PIN code.

To deactivate the child lock, select the “” icon in 9.

Authorising a disc

- 1 Insert a disc. The access control box will appear after a short delay.
- 2 Using or select “**Play once**” or “**Play always**”.
- 3 Enter your PIN code using the number buttons **0..9**.

Double-sided DVDs may have a different ID for each side. For these discs, each side must be authorised. Multi-volume video CDs may have a different ID for each volume. For these CDs, each volume must be authorised.

Locking unlocked discs

To lock a disc that was formerly authorised follow the instructions below.

- 1 Insert a disc. Playback starts automatically. If the playback does not start automatically, press **PLAY**▶.
- 2 Press the **STOP**□ button while the “safe” icon is visible. The icon changes to “locked”. The disc is now locked.

Parental level control (DVD video only)

Films on pre-recorded DVD discs may contain scenes not suitable for children. Therefore, some discs may contain “Parental Control” rating information that applies to the entire disc or to certain scenes on the disc.

The appropriate scenes have filter values that reach from 1-8. If such a scene is detected during playback, the filter value set on the DVD recorder is compared to the scene. If the filter value is higher than the setting, an alternative scene will be played (if available).

Most DVDs apply the rating to an entire DVD. Therefore, if certain scenes exceed the rating you select, the entire disc will be blocked from viewing.

Activating/deactivating parental level control

- 1 Switch on the TV set. If required, select the programme number for the DVD recorder.
- 2 Switch on the DVD recorder using **⏻/I**.
- 3 Press **SYSTEM-MENU**. The menu bar appears.
- 4 Select the “**⏻**” icon using **◀** or **▶**.
- 5 Select “**⏻** (Disc features)” using **▼** or **▲** and confirm with **▶**.
- 6 Confirm “**Access control**” using **▶**.
- 7 Enter a 4-digit code of your choice. If the code is new, you may have to enter the code a second time as confirmation.
- 8 Select the “**Parental level**” using **▲** or **▼** and confirm with **▶**. A bar appears to select the parental level.
- 9 Select the appropriate rating using **▼**, **▲** or the number buttons **0..9**.

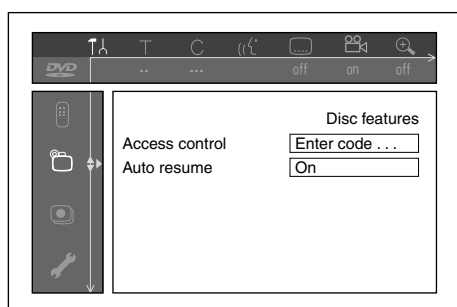

Tip

What do the ratings mean?

Rating 0 (displayed as “-”) parental control not active.

Rating 1 (suitable for children)

Rating 8 (only suitable for adults)

What happens if a DVD scene contains a higher level than the rating set?

If the recorder does not find a suitable alternative, playback will stop and you must enter the four-digit code.

- 10 Confirm with **ENTER/OK**. Quit using **◀** and **SYSTEM-MENU**.

Changing the country

The set filter values depend on the respective country. It is therefore necessary to enter the country to which these filter values apply.

- ❶ Switch on the TV set. If required, select the programme number for the DVD recorder.
- ❷ Switch on the DVD recorder using O/I .
- ❸ Press **SYSTEM-MENU**. The menu bar appears
- ❹ Select the “ $\uparrow\downarrow$ ” icon using \blacktriangleleft or \blacktriangleright .
- ❺ Select line “ Disc features ” using \blacktriangledown or \blacktriangleup and confirm with \blacktriangleright .
- ❻ Confirm the line “**Access control**” using \blacktriangleright .
- ❼ Enter your four-digit code. If the code is new, you may have to enter the code a second time as confirmation.
- ❽ Select “**Change country**” using \blacktriangledown or \blacktriangleup and confirm with \blacktriangleright .
- ❾ Select the corresponding country using \blacktriangleup or \blacktriangledown and confirm with **ENTER/OK**.
- ❿ To end, press \blacktriangleleft and then **SYSTEM-MENU**.

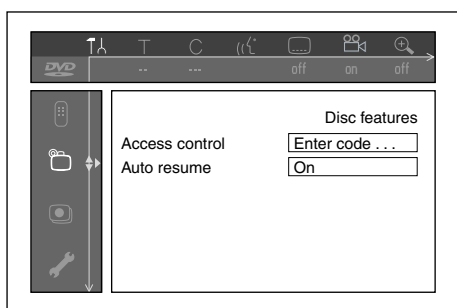

Changing the PIN code

- ❶ Switch on the TV set. If required, select the programme number for the DVD recorder.
- ❷ Switch on the DVD recorder using O/I .
- ❸ Press **SYSTEM-MENU**. The menu bar appears
- ❹ Select the “ $\uparrow\downarrow$ ” icon using \blacktriangleleft or \blacktriangleright .
- ❺ Select “ Disc features ” using \blacktriangledown or \blacktriangleup and confirm with \blacktriangleright .
- ❻ Confirm “**Access control**” using \blacktriangleright .
- ❼ Enter your four-digit PIN code. If the code is new, you may have to enter the code a second time as confirmation.
- ❽ Select “**Change code**” using \blacktriangleup or \blacktriangledown and confirm with \blacktriangleright .
- ❾ Enter the new code using the number buttons **0..9**. Enter the same code again as confirmation.
- ❿ Quit using \blacktriangleleft and **SYSTEM-MENU**.

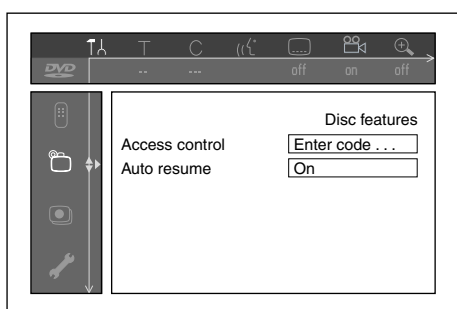

Tip

I have forgotten my code

Press **STOP** \square four times (step ❷), then press **ENTER/OK**. Access control is now switched off. You can now enter a new code as described above.

13. Before you call an engineer

If you have any problems using this DVD recorder, the reason may be one of the following. You can also call the **customer service centre** in your country.

If the problem is not listed below, or if the instructions fail to help, turn off the power to the unit, disconnect the power cable, and contact the nearest authorized YAMAHA dealer or service center.

PROBLEM

SOLUTION

Your recorder does not respond to any button being pressed and the display shows "IS TV ON?":

- ✓ Recorder in initial installation mode: Switch on the TV, switch over to the DVD recorder jack. Now the menu for language selection should appear. Please read paragraph "Initial Installation" in the chapter "Installing your DVD Recorder".

The device does not react when you press a button, although the remote control works:

- ✓ "Dealer-Mode" is switched on: All buttons on the front of the set are locked. Switch off the function:
 - 1 Pull out the mains plug from the wall outlet.
 - 2 Press and hold down **■** and **▲** (**Open/Close**) and put back the mains plug into the wall outlet.
 - 3 As soon as the time or "--:--" appears in the display (ca. 6 - 10 seconds), release **■** and **▲** (**Open/Close**).

Your DVD recorder does not respond to any button being pressed:

- ✓ There is no power supply: check the power supply
- ✓ A programmed recording (Timer) is currently being made: If desired, cancel the programmed recording (Timer) with **⏏/II**.
- ✓ There is a technical problem: disconnect from the mains power supply for 30 seconds, then connect again. If this doesn't help, you can reset your DVD recorder to the default factory settings.

Resetting the machine to the default factory settings:

- ✓ **Important:** All the information stored (TV channels, time and date, TIMER) will be lost.
 - 1 Disconnect from the mains power supply.
 - 2 Press and hold down the **⏏/II** button on the device and reconnect to the mains power supply.
 - 3 Release the **⏏/II** button when "IS TV ON?" appears on the display. All the information stored (TV channels, time and date, TIMER) will be lost. Please read paragraph "Initial Installation" in the chapter "Installing your DVD Recorder".

Remote control does not work:

- ✓ Remote control not pointed toward the DVD recorder: Point the remote control at the machine. See if the "o((((" appears on the display briefly each time you press a remote control button. If it does, the Recorder is receiving information from the remote correctly.
- ✓ There is a technical problem: Take out the batteries, wait for 10 seconds and put them in again.
- ✓ Batteries are flat: Change the batteries.

No playback on DVD recorder:

- ✓ There is no recording on the disc: Change disc.
- ✓ You inserted the wrong disc type: Your recorder can play back the following disc types: DVD Video, (Super) Video CD, DVD+R(W), Audio CD, MP3-CD's
- ✓ You inserted the disc the wrong way: Insert the disc with the label facing upwards
- ✓ Disc is dirty: Clean the disc
- ✓ Wrong region code: The region code of the DVD and the DVD recorder must match.
- ✓ Parental control is on: Read chapter "Access control (child lock)"
- ✓ You have selected the wrong programme number for the DVD recorder on the TV: on the TV, select the correct programme number for the DVD recorder.
- ✓ The cable connecting the TV set and the DVD recorder has come loose: check the cable.

PROBLEM	SOLUTION
I cannot playback (Super) Video CDs	<ul style="list-style-type: none"> ✓ It is possible that this (Super) Video CD contains a menu and the "PBC" is switched off. You can see this in status field "PBC OFF". To activate this function, proceed as follows: <ol style="list-style-type: none"> 1 Press SYSTEM-MENU while the (Super) Video-CD is inserted. 2 Select "PA" using ◀ or ▶. 3 Select line "Features" using ▼ or ▲ and confirm with ▶. 4 Select "On" in line "PBC" using ▼ or ▲. 5 Confirm with ENTER/OK and end with SYSTEM-MENU.
Poor playback on DVD recorder: (distorted picture/distorted sound)	<ul style="list-style-type: none"> ✓ Your TV set is not properly adjusted. ✓ Disc is dirty: Clean the disc ✓ Sometimes the picture may be temporarily distorted. This is not a defect of your DVD recorder.
No recording possible:	<ul style="list-style-type: none"> ✓ The TV channel you want to record is not stored or you selected the wrong programme number: Check TV channels stored. ✓ Disc write-protected (recording protected): Remove write-protection or change the disc. For more information, please see "Preventing accidental erasing of discs" in chapter "Manual Recording". ✓ An already finalised DVD+R has been inserted: Change disc.
Programmed recording does not work:	<ul style="list-style-type: none"> ✓ You have programmed the wrong time or date: Check time/date. ✓ You have not set the TIMER properly: Check the programmed recordings (TIMER block). ✓ Locked disc inserted: Remove disc lock. ✓ An already finalised DVD+R has been inserted: Change disc.
The wrong TV channel was decoded (entered) after you programmed a recording using VCR Plus+ System.	<ol style="list-style-type: none"> 1 Enter the VCR Plus+ programming number of the TV channel you want. 2 Confirm with ENTER/OK. 3 Check the programme number/channel name in the "Prog." input field. 4 If this does not correspond to the desired TV channel, select the input field and change the programme number/channel name. 5 Confirm with ENTER/OK.
There is picture or sound interference on TV reception:	<ul style="list-style-type: none"> ✓ Have your aerial checked. ✓ You will find information on how to change the TV system in "Manual TV channel search" in "Installing your DVD recorder".
Distorted sound coming from a connected hi-fi amplifier	<ul style="list-style-type: none"> ✓ The DVD recorder is connected to the "Phono-input" of your amplifier: This jack is provided only for record players without a preamplifier. Select a different audio input.
The picture is distorted or black-and-white during playback	<ul style="list-style-type: none"> ✓ The TV system of the disc does not match that of your TV set (PAL/NTSC). ✓ The recording can be made in colour only when the TV channels or the connected additional device send a colour signal. Black-and-white signals containing no color information (colour subcarriers) cannot be recorded.
No sound signal at the digital output	<ul style="list-style-type: none"> ✓ Check whether the sound settings match the selected inputs and connected additional devices.

PROBLEM

A DVD+RW disc cannot be played on certain DVD players

SOLUTION

- ✓ If a recording is too short, it is possible that a DVD player cannot detect it: Please observe the following "Minimum recording times":
Recording mode "**M1**": 5 minutes, "**M2**": 10 minutes, "**M2x**": 13 minutes, "**M3**": 15 minutes, "**M4**": 20 minutes, "**M6**": 30 minutes
- ✓ Some DVD players cannot play back DVD+RW recordings. You can solve this problem by using a special function:
 - 1** Open the disc tray with **▲ (Open/Close)**. Insert the disc but do not close the tray.
 - 2** Hold down the number button **2** on the remote control until the tray closes. The disc is modified.
 - 3** If this fails to produce the desired result, repeat the procedure using the number button **3** on the remote control.
 - 4** You can restore the disc to its original condition by pressing **1**.

Warning!

There is a risk that you can no longer play the disc on other DVD players after this procedure.

Therefore, apply this function with particular care.

Other disc errors

- ✓ If it is impossible to play back a disc, you can try and repair it for new recordings using the following function. This will only prepare the disc for erasing. It will not be erased, however, until the recording has been completed.
 - 1** Clean the disc
 - 2** Open the disc tray with **▲ (Open/Close)**. Insert the disc but do not close the tray.
 - 3** Hold down **CLEAR** on the remote control until the tray closes. The disc is prepared for erasing.
 - 4** Start recording as with an empty disc.

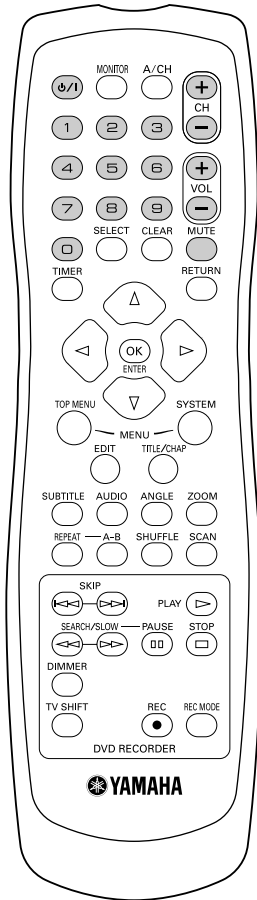

Using DRX-2 remote control for your TV set

Your DVD recorder remote control can transmit several commands to TV sets of different brands.

The following keys will operate the TV set:

- **VOL +** increase TV volume
- **VOL -** decrease TV volume
- **MUTE** mute TV

Some other keys normally operate the DVD recorder, but will operate the TV set when you keep **TV SHIFT** pressed:

- **CH +** next TV programme number
- **CH -** previous TV programme number
- **0..9** choose TV channel
- **⏻/⏷** switch TV set to standby

If your TV set does not respond to the remote control, you can re-programme your remote control. Below you will find a list of all available remote control codes for various TV brands. The following procedure re-programmes your remote control:

- ① Look up the set-up code for your TV set in the code list in the following page.
- ② Press and hold the ◀ and ▶ simultaneously for at least 3 seconds.
- ③ Release both keys.
- ④ Enter, within 30 seconds, the correct four-digit code with the digit keys **0..9**.
- ⑤ If the selected code does not work with your TV set, or if the brand of your TV set is not in the list, try out the codes one after the other.

Remote control set-up codes for television

Abex	1066
Admiral	1013, 1028, 1075
Aiko	1012
Akai	1005
Alaron	1022
American Action	1023
Anam	1023, 1079
AOC	1003, 1005, 1048
Audiovox	1012, 1023, 1027, 1029
Baysonic	1023
Belcor	1003
Bell & Howell	1016, 1075
Bradford	1023
Brocksonic	1024, 1028
Brockwood	1003
Candle	1005, 1009
Carnivale	1005
Carver	1000
Celebrity	1001
Cineral	1012, 1027
Citizen	1005, 1009, 1010, 1012, 1044, 1046, 1064
Concerto	1009
Contec	1023, 1063, 1065
Craig	1023
Crosley	1000
Crown	1023, 1064
Curtis Mathes	1000, 1005, 1006, 1007, 1009, 1010, 1013, 1014, 1016, 1019, 1027, 1034, 1036, 1046, 1064
CXC	1023
Daewoo	1003, 1012, 1027, 1029, 1030, 1064
Daytron	1003, 1064
Denon	1014
Dumont	1002, 1003
Electroband	1001
Electrohome	1079
Emerson	1003, 1016, 1021, 1022, 1023, 1024, 1026, 1028, 1029, 1030, 1044, 1045, 1063, 1064, 1067, 1068, 1069
Envision	1005
Fisher	1016, 1055, 1056
Fujitsu	1022, 1032
Funai	1020, 1022, 1023
Futuretech	1023
GE	1004, 1006, 1007, 1013, 1021, 1026, 1027, 1034, 1036, 1047, 1060, 1061, 1062, 1079
Gibraltar	1002, 1003, 1005, 1063
Goldstar	1003, 1005, 1009, 1021, 1064, 1066
Gradiente	1008, 1009
Grundig	1064
Grunpy	1022, 1023
Hallmark	1021
Harvard	1023
Harley Davison	1022
Harman Kardon	1000
Hitachi	1009, 1014, 1063, 1065
Infinity	1000, 1077
Inteq	1002
JBL	1000, 1077
JCB	1001
JVC	1008, 1060, 1063, 1065
JVC RMC383	1043
KEC	1023
Kenwood	1003, 1005
Kloss	1057, 1058, 1059
KTV	1005, 1023, 1044, 1064
LG	1009
Loewe	1077
Luxman	1009
LXI	1000, 1006, 1016, 1017, 1021, 1077
Magnavox	1000, 1005, 1022, 1049, 1050, 1057, 1058, 1059, 1077
Marantz	1000, 1005, 1077
Matsushita	1025
Megatron	1014, 1021
Memorex	1009, 1015, 1016, 1021, 1025, 1028, 1075
MGA	1003, 1005, 1015, 1021, 1056
Midland	1002, 1006, 1007, 1060, 1064, 1066
Minutz	1004
Mitsubishi	1003, 1013, 1015, 1021, 1056
Motorola	1013, 1079
MTC	1003, 1005, 1009, 1010, 1046
Multitech	1019, 1023
NAD	1017, 1021
NEC	1003, 1005, 1009, 1079
Nikko	1005, 1012, 1021
NTC	1012
Onwa	1023
Optimus	1016, 1019, 1025
Optonica	1013, 1018
Orion	1022, 1024, 1028
Panasonic	1007, 1025, 1060, 1077, 1079
Penney	1003, 1004, 1005, 1006, 1007, 1009, 1010, 1017, 1021, 1036, 1046, 1060, 1063, 1064, 1066, 1076
Philco	1000, 1003, 1005, 1014, 1028, 1049, 1057, 1058, 1059, 1059, 1077, 1079
Philips	1000, 1049, 1050, 1057, 1058, 1063, 1073, 1077, 1079
Pilot	1003, 1005, 1064
Pioneer	1019, 1031
Price Club	1046
Portland	1003, 1012, 1064
Prism	1007, 1060
Proscan	1006
Proton	1021, 1063
Pulsar	1002, 1003
Quasar	1007, 1018, 1025, 1060, 1079
Radio Shack	1003, 1005, 1006, 1009, 1016, 1018, 1021, 1023, 1063, 1064, 1066
RCA	1003, 1006, 1007, 1011, 1013, 1033, 1034, 1035, 1036, 1037, 1038, 1048, 1052, 1071, 1072, 1079
Realistic	1003, 1005, 1009, 1016, 1018, 1021, 1023, 1063, 1064
Runco	1002, 1005
Sampo	1005, 1064, 1066
Samsung	1003, 1005, 1009, 1010, 1021, 1046, 1063, 1064, 1066, 1078
Samsunx	1064
Sansei	1027
Sansui	1028
Sanyo	1016, 1055
Scimitsu	1003
Scotch	1021, 1063
Scott	1003, 1021, 1022, 1023, 1024
Sears	1000, 1006, 1009, 1016, 1017, 1020, 1021, 1022, 1053, 1055, 1056, 1065
Semivox	1023
Semp	1017
Sharp	1013, 1018, 1031, 1051, 1063, 1064
Shogun	1003
Signature	1075
Sony	1001, 1042
Sounddesign	1021, 1022, 1023
Squareview	1020
SSS	1003, 1023
Starlite	1023
Supreme	1001
Sylvania	1000, 1005, 1049, 1050, 1054, 1058, 1059, 1077
Symphonic	1020
Tandy	1013
Tatung	1079
Technics	1007, 1025, 1060, 1063
Technol Ace	1022
Techwood	1007, 1009, 1060
Teknika	1000, 1003, 1009, 1010, 1012, 1015, 1022, 1023, 1046, 1064, 1065
Telecaption	1074
Telefunken	1009
Thomson	1039
TMK	1009, 1021
Toshiba	1010, 1016, 1017, 1040, 1041, 1046, 1054, 1070, 1074
Totevision	1064
Vector Research	1005
Victor	1008
Vidikron	1000
Vidtech	1003, 1021
Wards	1000, 1003, 1004, 1005, 1009, 1018, 1021, 1022, 1049, 1050, 1054, 1057, 1058, 1075, 1077
White Westinhouse	1029, 1028, 1030
Yamaha	1003, 1005
Zenith	1002, 1012, 1028

Specifications

Disc Formats Supported

Disc type	Playback	Recording
DVD+RW	•	•
DVD+R	•	•
DVD-RW (Video mode)	•	–
DVD-R	•	–
DVD-Video	•	–
Super Video CD	•	–
Video CD	•	–
Audio CD	•	–
CD-R	•	–
CD-RW	•	–

Recordable Disc Formats

Medium	DVD+RW: Phase-Change ReWritable DVD+R: dye-based		
Diameter	12 cm		
Capacity (single side)	4.7 Gbyte		
Recording time	M1	60'	9.72 Mbit/s
	M2	120'	5.07 Mbit/s
	M2x	150'	4.06 Mbit/s
	M3	180'	3.38 Mbit/s
	M4	240'	2.54 Mbit/s
	M6	360'	1.69 Mbit/s

TV Standard	PAL	NTSC
Scan Frequency	50Hz	60Hz
Number of lines	625	525
Playback	•	•
Recording	•	•
Internal tuner	•	–

Video RESOLUTION	50Hz	60Hz
DVD-Video/DVD+RW/DVD+R (M1/M2/M2x)		
-Horiz. Resolution	720 pixels ¹	720 pixels ¹
-Vertical Resolution	576 lines	480 lines
DVD+RW/DVD+R (M3/M4/M6)		
-Horiz. Resolution	360 pixels ²	360 pixels ²
-Vertical Resolution	576 lines	480 lines
VCD		
-Horiz. Resolution	352 pixels	352 pixels
-Vertical Resolution	288 lines	288 lines

1 equivalent to 500 lines on your TV

2 equivalent to 250 lines on your TV

Video Performance

DA Converter	10-bit
AD Converter	9-bit
Signal handling	Components
Video Output	1 Vpp into 75 Ohm
S-video Output	Y: 1 Vpp into 75 Ohm C: 0.286 Vpp into 75 Ohm
Component Output	Y: 1 Vpp into 75 Ohm Pb: 0.7 Vpp into 75 Ohm Pr: 0.7 Vpp into 75 Ohm

Audio format

Compressed Digital	Playback	Recording
-Dolby Digital	Multi-channel (AC-3)	2-channel 16-bit, fs 48 kHz
-DTS	Multi-channel	–
-MPEG1	2-channel SPdif	–
-PCM	2-channel 16, 20, 24 bit fs 48 kHz	2-channel 16-bit, fs 48 kHz

Audio Performance

DA Converter	24-bit	
AD Converter	16-bit	
DVD	fs 96 kHz	4 Hz - 44 kHz
	fs 48 kHz	4 Hz - 22 kHz
Video CD	fs 44.1 kHz	4 Hz - 20 kHz
Audio CD	fs 44.1 kHz	4 Hz - 20 kHz

Front Connections

i.LINK DV	IEEE 1394 4-pin
S-video Input	Hosiden 4-pin
Video Input	Cinch (yellow)
Audio Left/Right Input	Cinch (white/red)

Rear Connections

Component Video In	Cinch (green/blue/red)
Component Video Out	Cinch (green/blue/red)
S-video In	Hosiden 4-pin
S-video Out	Hosiden 4-pin
Video In	Cinch (yellow)
Video Out	Cinch (yellow)
Audio L/R In	Cinch (white/red)
Audio L/R Out	Cinch (white/red)
Digital Audio Out	1 coaxial, 1 optical IEC958 for CDDA / LPCM IEC1937 for MPEG2, Dolby Digital
RF Antenna In	Coaxial 75 ohms
RFTV Out	Coaxial 75 ohms
Power	Standard (IEC type)

Power Supply

Power Inlet	120V, 60 Hz	
Power consumption	Operation	27 W
	Low-power Standby	3 W

Cabinet

Dimensions (w x h x d)	435 x 82 x 347 mm
Net Weight	4.0 kg

Operating environment

Operating position	maximum 10 degree inclination in all directions
Ambient temperature	15 C - 35 C
Humidity	25% - 75%



YAMAHA ELECTRONICS CORPORATION, USA 6660 ORANGETHORPE AVE., BUENA PARK, CALIF. 90620, U.S.A.
YAMAHA CANADA MUSIC LTD. 135 MILNER AVE., SCARBOROUGH, ONTARIO M1S 3R1, CANADA
YAMAHA ELECTRONIK EUROPA G.m.b.H. SIEMENSSTR. 22-34, 25462 RELLINGEN BEI HAMBURG, F.R. OF GERMANY
YAMAHA ELECTRONIQUE FRANCE S.A. RUE AMBROISE CROIZAT BP70 CROISSY-BEAUBOURG 77312 MARNE-LA-VALLÉE CEDEX02, FRANCE
YAMAHA ELECTRONICS (UK) LTD. YAMAHA HOUSE, 200 RICKMANSWORTH ROAD WATFORD, HERTS WD18 7GO, ENGLAND
YAMAHA SCANDINAVIA A.B. J A WETTERGRENS GATA 1, BOX 30053, 400 43 VÄSTRA FRÖLUNDA, SWEDEN
YAMAHA MUSIC AUSTRALIA PTY, LTD. 17-33 MARKET ST., SOUTH MELBOURNE, 3205 VIC., AUSTRALIA

YAMAHA CORPORATION
3139 246 13152 (IP) Printed in Hungary