

SONY®

HD DIGITAL VIDEOCASSETTE RECORDER

HDW-F500

PARALLEL INTERFACE KIT

BKDW-509

HD-SD CONVERTER BOARD

HKDV-501A

HD LINE CONVERTER BOARD

HKDV-502

HD DIGITAL VIDEO CONTROLLER

HKDV-503

SDTI BOARD

HKDV-506A

HD PULL DOWN BOARD

HKDV-507/507D



 Tele-File

The 'Tele-File' logo consists of a stylized graphic of three slanted parallel lines to the left of the text 'Tele-File' in a bold, sans-serif font.

OPERATION MANUAL English

1st Edition (Revised 3)

Serial No. 10101 and Higher

WARNING

To prevent fire or shock hazard, do not expose the unit to rain or moisture.

To avoid electrical shock, do not open the cabinet. Refer servicing to qualified personnel only.

THIS APPARATUS MUST BE EARTHED.



This symbol is intended to alert the user to the presence of important operating and maintenance (servicing) instructions in the literature accompanying the appliance.

WARNING: THIS WARNING IS APPLICABLE FOR USA ONLY.

If used in USA, use the UL LISTED power cord specified below.

DO NOT USE ANY OTHER POWER CORD.

Plug Cap Parallel Blade with ground pin (NEMA 5-15P Configuration)

Cord Type SJT, three 16 or 18 AWG wires

Length Less than 2.5m(8 ft 3 in)

Rating Minimum 10 A, 125 V

Using this unit at a voltage other than 120V may require the use of a different line cord or attachment plug, or both. To reduce the risk of fire or electric shock, refer servicing to qualified service personnel.

For the customers in U.S.A.

This equipment has been tested and found to comply with the limits for a Class A digital device, pursuant to Part 15 of the FCC Rules. These limits are designed to provide reasonable protection against harmful interference when the equipment is operated in a commercial environment. This equipment generates, uses, and can radiate radio frequency energy and, if not installed and used in accordance with the instruction manual, may cause harmful interference to radio communications. Operation of this equipment in a residential area is likely to cause harmful interference in which case the user will be required to correct the interference at his own expense.

You are cautioned that any changes or modifications not expressly approved in this manual could void your authority to operate this equipment.

The shielded interface cable recommended in this manual must be used with this equipment in order to comply with the limits for a digital device pursuant to Subpart B of Part 15 of FCC Rules.

For the customers in Europe

This product with the CE marking complies with both the EMC Directive (89/336/EEC) and the Low Voltage Directive (73/23/EEC) issued by the Commission of the European Community.

Compliance with these directives implies conformity to the following European standards:

- EN60065: Product Safety
- EN55103-1: Electromagnetic Interference (Emission)
- EN55103-2: Electromagnetic Susceptibility (Immunity)

This product is intended for use in the following Electromagnetic Environment: E4 (Controlled EMC environment ex. TV studio).

AVERTISSEMENT

Afin d'éviter tout risque d'incendie ou d'électrocution, ne pas exposer cet appareil à la pluie ou à l'humidité.

Afin d'écarter tout risque d'électrocution, garder le coffret fermé. Ne confier l'entretien de l'appareil qu'à un personnel qualifié.

CET APPAREIL DOIT ÊTRE RELIÉ À LA TERRE.

Pour les clients européens

Ce produit portant la marque CE est conforme à la fois à la Directive sur la compatibilité électromagnétique (EMC) (89/336/CEE) et à la Directive sur les basses tensions (73/23/CEE) émises par la Commission de la Communauté européenne.

La conformité à ces directives implique la conformité aux normes européennes suivantes:

- EN60065: Sécurité des produits
- EN55103-1: Interférences électromagnétiques (émission)
- EN55103-2: Sensibilité électromagnétique (immunité)

Ce produit est prévu pour être utilisé dans l'environnement électromagnétique suivant:

E4 (environnement EMC contrôlé ex. studio de télévision).

VORSICHT

Um Feuergefahr und die Gefahr eines elektrischen Schlages zu vermeiden, darf das Gerät weder Regen noch Feuchtigkeit ausgesetzt werden.

Um einen elektrischen Schlag zu vermeiden, darf das Gehäuse nicht geöffnet werden. Überlassen Sie Wartungsarbeiten stets nur qualifiziertem Fachpersonal.

DIESES GERÄT MUSS GEERDET WERDEN.

Für Kunden in Europa

Dieses Produkt besitzt die CE-Kennzeichnung und erfüllt sowohl die EMV-Direktive (89/336/EEC) als auch die Directive Niederspannung (73/23/EEC) der EG-Kommission.

Die Erfüllung dieser Direktiven bedeutet Konformität für die folgenden Europäischen Normen:

- EN60065: Produktsicherheit
- EN55103-1: Elektromagnetische Interferenz (Emission)
- EN55103-2: Elektromagnetische Empfindlichkeit (Immunität)

Dieses Produkt ist für den Einsatz unter die folgende elektromagnetische Bedingung ausgelegt:

E4 (kontrollierter EMV-Bereich, z.B. Fernsehstudio).

Table of Contents

Chapter 1 Overview

1-1 Features	1-1
1-1-1 Features of the HDW-F500	1-1
1-1-2 Features of the Control Panel	1-3
1-2 Optional Accessories	1-5

Chapter 2 Locations and Functions of Parts and Controls

2-1 Control Panel	2-1
2-1-1 Upper Control Panel	2-2
2-1-2 Lower Control Panel (Menu Operations Section)	2-5
2-1-3 Lower Control Panel (Editing Operations Section)	2-7
2-1-4 Lower Control Panel (Tape Transport Operations Section) ...	2-9
2-1-5 Lower Control Panel (Search Operations Section)	2-11
2-2 System Set-Up Panel	2-13
2-3 Connector Panel	2-14

Chapter 3 Setting Up the VTR

3-1 Connecting External Equipment	3-1
3-1-1 Making Digital Connections	3-1
3-1-2 Making HD Analog Connections	3-2
3-1-3 Making NTSC/PAL Digital Connections	3-3
3-1-4 Cascade connection	3-4
3-2 Reference Signals for Video Output and Servo System	3-5
3-2-1 Reference Signals for Output Video	3-5
3-2-2 Reference Signals Connections	3-6
3-3 Handling Cassettes	3-8
3-3-1 Recommended Cassettes	3-8
3-3-2 Inserting and Ejecting Cassettes	3-8
3-3-3 Preventing Accidental Erasure	3-9

Chapter 4 Menu Settings

4-1 Registering and Storing Menu Settings	4-1
4-1-1 Menu Configuration	4-1
4-1-2 Changing Menu Settings	4-2
4-1-3 Registering Items to the PF1/2 Menus	4-3
4-1-4 VTR Memory Bank Function	4-4
4-1-5 Memory Card Function	4-6
4-1-6 Adding Titles to the Data	4-11
4-1-7 Details on VTR Memory Bank and Memory Card Functions	4-12
4-1-8 Memory Card Data Compatibility	4-13
4-2 HOME Menu	4-14
4-2-1 Selecting the Output Signals(PB/EE)	4-16
4-2-2 Record Inhibit Mode (REC INH)	4-16
4-2-3 Selecting the Edit Mode and Edit Channel (ASSEMBLE or INS CUE)	4-17
4-2-4 Pre-read Settings (PRE READ)	4-17
4-2-5 Still-Picture Output (FREEZE)	4-17
4-2-6 Selecting the Capstan Servo Lock Mode (CAP LOCK)	4-18
4-2-7 Setting the Preroll Time (PREROLL TIME)	4-18
4-2-8 Selecting DMC Playback (DMC)	4-19
4-2-9 Recalling Edit Points (LAST EDIT)	4-19

(Continued)

Chapter 4 Menu Settings

4-3 TC Menu	4-20
4-3-1 Setting the Time Data (TIMER SEL/RESET/SET/HOLD)	4-21
4-3-2 Setting the Time Code Reader (TCR SEL)	4-24
4-3-3 Setting the Time Code Generator (TCG SOURCE/MODE)	4-25
4-3-4 Selecting the Time Code Running Mode (RUN MODE)	4-25
4-3-5 Selecting the Drop Frame Mode (DF/NDF)	4-25
4-3-6 Inserting VITC input source (VITC)	4-26
4-3-7 Selecting CTL Display Mode (TAPE TIMER)	4-26
4-3-8 Presetting Pull Down Time Code (PDPSET MENU) (when HKDV-507/507D is installed)	4-26
4-3-9 Presetting for Conversion From 24-frame Into 25-frame Time Code (TCCONV MENU)	4-27
4-3-10 Conversion of Time Code During Playback in 25F Mode (TC CONV)	4-29
4-3-11 Displaying the Pull Down Time Code (when HKDV-507/507D is installed)	4-29
4-3-12 Superimposition of Character Information (PD CHARA/CHARA SUPER/H-POS/V-POS)	4-30
4-3-13 Setting the VITC Insertion Line (VITC POS-1/POS-2)	4-32
4-3-14 Presetting for Conversion From 25-frame Into 24-frame Time Code (TCCONV MENU)	4-33
4-3-15 Conversion of Time Code During Playback in 24F Mode (TC CONV)	4-34
4-4 CUE Menu	4-35
4-4-1 Selecting a Multi-Cue Mode	4-36
4-4-2 Registering Cue Points	4-36
4-4-3 Erasing Cue Point Data	4-38
4-4-4 Prerolling to a Cue Point	4-39
4-4-5 Changing a Cue Point Into an Edit Point	4-40
4-4-6 Backspace Editing	4-40
4-4-7 TELE FILE Menu	4-41
4-5 PF1 Menu (Factory Settings)	4-55
4-5-1 Selecting the Input Video Signal (VIDEO IN)	4-56
4-5-2 Selecting the Reference Signal (SERVO REF)	4-56
4-5-3 Adjusting the Output Video Signal (MASTER LEVEL to FINE)	4-56
4-6 PF2 Menu (Factory Settings)	4-59
4-6-1 Selecting the Audio Input Signal (A-IN CH-1~CH4)	4-60
4-6-2 Setting Emphasis (EMPHASIS)	4-60
4-6-3 Selecting the Monitor Output Signal (MON-L SEL/MON-R SEL)	4-60
4-7 SET UP Menu	4-61
4-7-1 VTR SETUP Menu	4-63
4-7-2 PANEL SETUP Menu	4-65

Chapter 5 Recording/Playback

5-1 Preparing for Recording	5-1
5-1-1 Setting Switches and Menus	5-1
5-1-2 Selecting Audio Signals	5-2
5-1-3 Adjusting the Audio Recording Level	5-3
5-1-4 Simultaneously Monitoring Playback of Video and Audio Signals Being Recorded	5-4
5-1-5 Recording Analog Audio	5-4
5-2 Recording	5-5
5-3 Preparing for Playback	5-6
5-3-1 Setting Switches and Menus	5-6
5-3-2 Adjusting the Audio Playback Level	5-6
5-3-3 Selecting the HD-SD Conversion Mode (when HKDV-501A is installed)	5-7
5-3-4 Selecting the Conversion Mode of the Effective Scanning Line Number (when HKDV-502 is installed)	5-8
5-3-5 Improving the Vertical Resolution during Slow-Motion Playback (when HKDV-502 is installed)	5-9
5-4 Playback	5-11
5-4-1 Normal-Speed Playback	5-11
5-4-2 Variable Speed Playback	5-11
5-4-3 Capstan Override Playback	5-14
5-4-4 DMC Playback	5-14
5-4-5 Playing Back Non-audio Data	5-16
5-4-6 Output of Pull Down Signal	5-16

Chapter 6 Editing

6-1 Basic Automatic Editing	6-1
6-1-1 Overview of Automatic Editing	6-1
6-1-2 Setting Switches and Menus	6-2
6-1-3 Selecting the Edit Mode	6-3
6-1-4 Setting Edit Points	6-3
6-1-5 Editing Non-audio Data	6-7
6-1-6 Confirming Edit Points	6-8
6-1-7 Cuing Up and Prerolling	6-8
6-1-8 Previewing	6-9
6-1-9 Modifying Edit Points	6-10
6-1-10 Performing Automatic Editing	6-12
6-2 Advanced Automatic Editing	6-15
6-2-1 Performing DMC Editing	6-15
6-2-2 Animation Editing	6-17
6-2-3 Performing Preread Editing	6-18
6-3 Manual Editing	6-19

Table of Contents

Appendix

Maintenance	A-1
Head Cleaning	A-1
Moisture Condensation	A-1
Specifications	A-2
Operation Information Display	A-6
Error Messages and Warning Messages	A-8
Error Messages	A-8
Warning Messages	A-10
Error Log Menu	A-11
Glossary	A-13
Menu List	A-15
Items Related to the Hours Meter (H01~)	A-15
Items Related to VTR Operations (001~)	A-16
Items Related to Operation Panels (101~)	A-20
Items Related to Remote Interface (201~)	A-23
Items Related to Editing (301~)	A-24
Items Related to Prerolling (401~)	A-27
Items Related to Recording Protection (501~)	A-28
Items Related to the Time Code (601~)	A-29
Items Related to the Video Control (701~)	A-34
Items Related to the Audio Control (801~)	A-39
Items Related to Digital Processing (901~)	A-42
Items Related to the Pull Down Control (A01~)	A-44
Other Items (T01~)	A-46
Index	I-1
Table of Functions (Factory Default Settings)	Last page

1-1 Features

1-1-1 Features of the HDW-F500

The HDW-F500 is a HD digital videocassette recorder using the HDCAM¹⁾ format. Comparable to a conventional digital Betacam in size, weight, and ease-of-use, the HDW-F500 is a small, lightweight HD digital VTR using integrated circuit technology.

HDCAM Format

The HDCAM format was developed from the digital Betacam format, and retains the same ease of use of digital Betacam, while yielding high performance HD digital recording and playback. The HDCAM format uses the following technologies:

- Pre-filtering and a new coefficient recording system, compressing the data by a factor of seven.
- Powerful error-correcting codes
- High-performance, high-accuracy heads and drum with dynamic tracking (DT)TM, together with a new auto-tracking technique, yielding highly reliable narrow track recording and playback.

Together, these technologies allow 120 minutes of recording on a (large size) 1/2-inch HDCAM cassette, the same size as a conventional digital Betacam cassette.

Digital Signal Processing

In an HDCAM VTR, the signal processing takes a 4:2:2 component signal which has been quantized according to ITU-R709/SMPTE 274M/SMPTE 260M(BTA S-002B) standards, and subjects it to pre-filter, and then further applies data compression by using a coefficient recording system. Audio signals are processed using full bit processing based on the AES/EBU format.

Input interface

The input interface is based on the SMPTE 291M/292M/299M(BTA S-004B/-005B/-006B) /ARIB STD B-4 HD component SDI(Serial Digital Interface) format, allowing a single BNC coaxial cable to carry one component video signal, four digital audio channels, and time code in time division multiplex; this is separated for conversion to parallel data. The interface can be used to record audio data from an AES/EBU digital interface or digitally converted analog signals.

Bit rate reduction encoder

The component video signal data is compressed by a factor of about four by a process in which it is subjected to frame shuffling, blocking, DCT (discrete cosine transform), quantizing adjustment, and variable length word encoding. This is the core of the newly developed coefficient recording system.

ECC encoder

The outer ECC (Error Correction Code) is added to the compressed video and audio data, followed by the inner ECC, ID data, and sync data. The Reed-Solomon code is employed in this error correction system.

Channel coding

Video and audio data with the ECC added is recorded in the form of serial data. The HDCAM format adopts a scrambled NRZI channel coding system for off-track and noise characteristics.

Playback signal processing

The playback digital data is equalized by equalizer circuits and error-corrected by powerful inner and outer ECC, which can correct most data disturbed by noise and dropouts in the reproduced signal. Data that cannot be completely corrected in this way is passed through a bit reduction decoder and corrected by an error concealment circuit.

Output interface

Component video data are converted into serial data and multiplexed with audio data and time code, then output in the HD SDI format.

By installing an HD-SD Converter Board (HKDV-501A; optional accessory), D1 SDI or D2 SDI and analog composite outputs are also available.

Audio output can be data from the AES/EBU digital interface or analog audio converted from digital signals.

1) HDCAM is a trademark of Sony Corporation.

Advanced Recording and Playback Functions

High-quality digital recording

The HDCAM system uses a component system to record video signals. An AES/EBU format with a wide dynamic range is used for 4-channel audio recording. A unique and powerful error correction circuit and concealment circuit are used in digital signal processing.

Accurate, stable video signal output is made possible by setting and adjusting an internal digital video processor.

8 kinds of record/playback modes

As the record/playback mode, you can select from the following 8 modes.

59.94i/60i/50i/23.98PsF/24PsF/25PsF/29.97PsF/30PsF

HD pull down

By installing an optional HD Pull Down Board HKDV-507/507D, the HD SDI output (to which the audio signal and VITC are multiplexed) of 59.94i or 60i mode are also available when the unit is operated in the 23.98PsF or 24PsF mode.

Noiseless playback with DT heads

Using the playback DT heads, you can perform noiseless playback at 51 speeds ranging from -1 to +2 times normal speed, including still-picture playback.

Video and audio confidence heads

Video and audio (channels 1 through 4) signals can be recorded and simultaneously played back to check the recording.

Internal time code generator and reader

The internal time code generator allows you to record time code (LTC or user bits) together with video and audio signals. Time codes (LTC or user bits) can be read during playback using the time code reader.

Computer servo system

Computer-controlled servo motors provide direct drive for the drum, capstan, and two reels, enabling quick and accurate tape access.

Capstan override function

You can adjust the playback speed by $\pm 15\%$ to ensure synchronization between, for example, two VTRs playing back the same program.

Independent level controls

The recording and playback levels of each of the four audio channels can be adjusted independently while peak values on all four audio channels are monitored.

Tele-File¹⁾ memory label system

The HDW-F500 incorporates the Tele-File memory label system to allow users to write and update videocassette management information and cue point data on optional MLB-1B-100 memory labels, providing greater efficiency in cassette management and editing.

Features for Ease of Operation

Compact, lightweight, low power consumption

The VTR is small and light enough to be used in outside broadcast vans or in EFP (Electronic Field Production) assignments.

Remote control operation

The VTR has a serial RS-422A 9-pin connector to allow control of the VTR by an external control unit through RS-422A communications.

The VTR also comes with 9-pin REMOTE1-IN(9P) and OUT(9P) connectors to support bridge connection of multiple HDW-F500 units or other VTRs equipped with 9-pin remote connectors for simultaneous operation.

Furthermore, by using the optional BKDW-509 Parallel (50-pin) Interface Kit, you can control the VTR from an external control unit with a parallel interface.

Digital hours meter

Three different hour displays and one cycle count display are supported, showing total elapsed time since the VTR was turned on, total drum revolution time, total tape running time and total number of threadings and unthreadings.

1) A contact-free system for writing, reading, and modifying video cassette-related information on IC memory-bearing labels. Tele-File is a trademark of Sony Corporation.

Self-diagnosis

This function allows the VTR to perform self diagnostics when a malfunction occurs. An error message is displayed and a history of all errors that have occurred is recorded.

Easy-to-maintain plug-in boards

The VTR uses plug-in circuit boards to simplify servicing and inspection.

Mountable in standard 19-inch rack

The unit can be mounted in an EIA-standard 19-inch rack.

For rack mounting, refer to the Maintenance Manual.

1-1-2 Features of the Control Panel

The BKDW-515 Control Panel provides six menu screens corresponding to the six operation modes to allow fast and easy adjustment of necessary settings, as well as the ability to store menu settings to a memory card for later recall.

Menu-driven operations for a variety of purposes

Six menus are displayed on the 90 × 72 mm (3 ⁵/₈ inches × 2 ⁷/₈ inches) screen and are set using the 10 function keys.

HOME menu

Use this menu to make the basic settings for recording, playback, and editing operations, and to select channels to be edited during insert editing.

TC menu

Use this menu to make time code settings.

CUE menu

Use this menu to set up to 100 cue points. In page mode, 10 cue points per page can be set on a total of 10 pages. In TELE FILE menu, you can change the setting for the memory label system Tele-File.

PF1/PF2 (Personal Function) menus

Use these menus to register up to 40 of the most frequently used items from the other menus (up to ten items each can be registered to PF1, ALT+PF1, PF2 and ALT+PF2). Menu items that may be registered can be displayed by pressing the **[F4]** (PF1&2 ASSIGN) button in the SET UP menu.

SET UP menu

- The VTR BANK menu allows up to eight pages of menu settings to be saved.
- Use the MEMORY CARD menu to store current settings of the VTR and up to 8 pages of the contents of the VTR memory bank to a memory card.
- Use the scrollable PF1&2 ASSIGN menu to display the items that can be registered in the PF1/PF2 menus, and to select and register the most frequently used menu items.
- Use the scrollable VTR SETUP menu to display the items necessary for making initial settings, and to directly change settings without registering them with the function buttons for each menu.
- Use the PANEL SETUP menu to set control panel operations, such as the keyboard sound output.

MAINTENANCE menu

Use this menu to access the maintenance functions.

For details, refer to the Maintenance Manual.

A full complement of storage/recall functions

These functions allow you to use titles to store and recall menu settings in either the VTR's internal memory banks or memory cards.

VTR memory banks

These memory banks allow you to store up to eight pages of VTR settings in addition to the current VTR settings. Factory settings are also stored here, allowing the VTR to be reset to these values at any time.

Memory cards

Each memory card can hold the current VTR settings as well as up to eight pages of settings. A single memory card thus allows you to store and recall the entire contents of the VTR memory banks.

Title function

This function allows you to add titles when storing data to the VTR memory bank or memory card, thus facilitating data retrieval and management.

Write protect function

Setting pages stored in VTR memory banks or memory cards can be write protected on an individual basis.

Display of duration between edit points

The duration between any two of IN, OUT, AUDIO IN, or AUDIO OUT points can be displayed by simultaneously pressing two buttons corresponding to those edit points.

Digital time counter

The time counter display shows CTL and time codes (LTC/VITC¹⁾), or user bits data for precise setting of edit points.

A full range of editing functions

Two HDW-F500 units can be connected allowing automatic or manual assembly and insertion. The VTR also features a full range of editing functions, including preview, review, preroll, and the setting or changing of edit points.

Quick access to edit points

The following methods are provided for the setting of edit points:

- Multi-cuing for up to 100 edit points
- Search dial with shuttle and jog functions
- Direct input through numeric buttons

DMC (Dynamic Motion Control) editing

Using the DT[®] (Dynamic Tracking) heads, you can play back a section of an edit at speeds between -1 and +2 times normal speed and store the speed variation in memory for later use in automatic editing.

Split editing

In insert mode, audio and video edit points can be set separately.

Preread editing

Video and audio signals that have been pre-read can be externally processed and simultaneously re-recorded.

A variety of audio editing modes

You can select cut-in editing, cross-fade editing, and fade in/out editing for the audio signals.

1) LTC (Longitudinal Time Code)

Time code recorded on a longitudinal track

VITC (Vertical Interval Time Code)

Time code recorded on a video track during the vertical blanking interval

1-2 Optional Accessories

The following accessories can be used with the HDW-F500.

BKDW-509 Parallel (50-pin) Interface Kit

A 50-pin parallel interface makes the HDW-F500 compatible with different broadcast station systems.

HKDV-501A HD-SD Converter Board

Allows you to output an NTSC/PAL component or composite signal.

HKDV-502 HD Line Converter Board

- Allows you to convert an effective scanning line number from 1035 to 1080 or from 1080 to 1035.

Note

- This function is operative only when the frame frequency of the VTR is set to 29.97Hz or 30Hz.
- Allows you to smooth the picture motion and improve the vertical resolution during slow-motion playback. Note that this function does not work when this VTR is operated in PsF mode.

HKDV-503 HD Digital Video Controller

This allows you to remotely control the parameters for video signals and image enhancement.

HKDV-506A SDTI Board

This board allows the input and output of special non-degrading SDTI¹⁾ (270Mbps) signals.

HKDV-507/507D HD Pull Down Board

This board allows the output of 2-3 pull down HD signal of 59.94i or 60i mode when this unit is operated with the frame frequency of 23.98 or 24 Hz. The 2-3 pull down sequence is as follows.

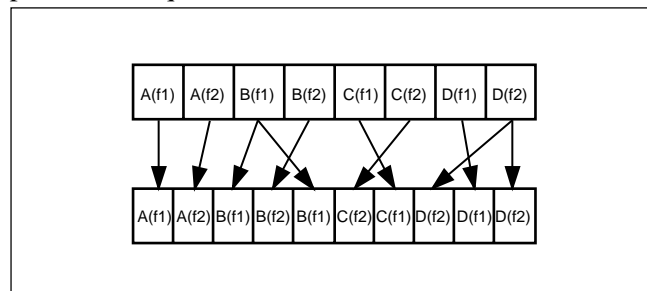

Note

The 2-3 pull down sequence is guaranteed only when this VTR is in normal play mode.

References

In addition to this Operation Manual, the following manuals are available:

- Maintenance Manual Part 1
Provides information necessary for users to maintain the VTR.
- Maintenance Manual Part 2 (sold separately)
Provides additional information to fully maintain the HDW-F500. Contains details on electrical adjustments, circuit diagrams, and other items.

1) SDTI (Serial Data Transport Interface)

SDTI is defined as SMPTE-305M.

2-1 Control Panel

The control panel consists of the following sections:

- Upper control panel
- Lower control panel: menu operations section,

memory card insertion slot, editing operations section, tape transport operations section and search operations section

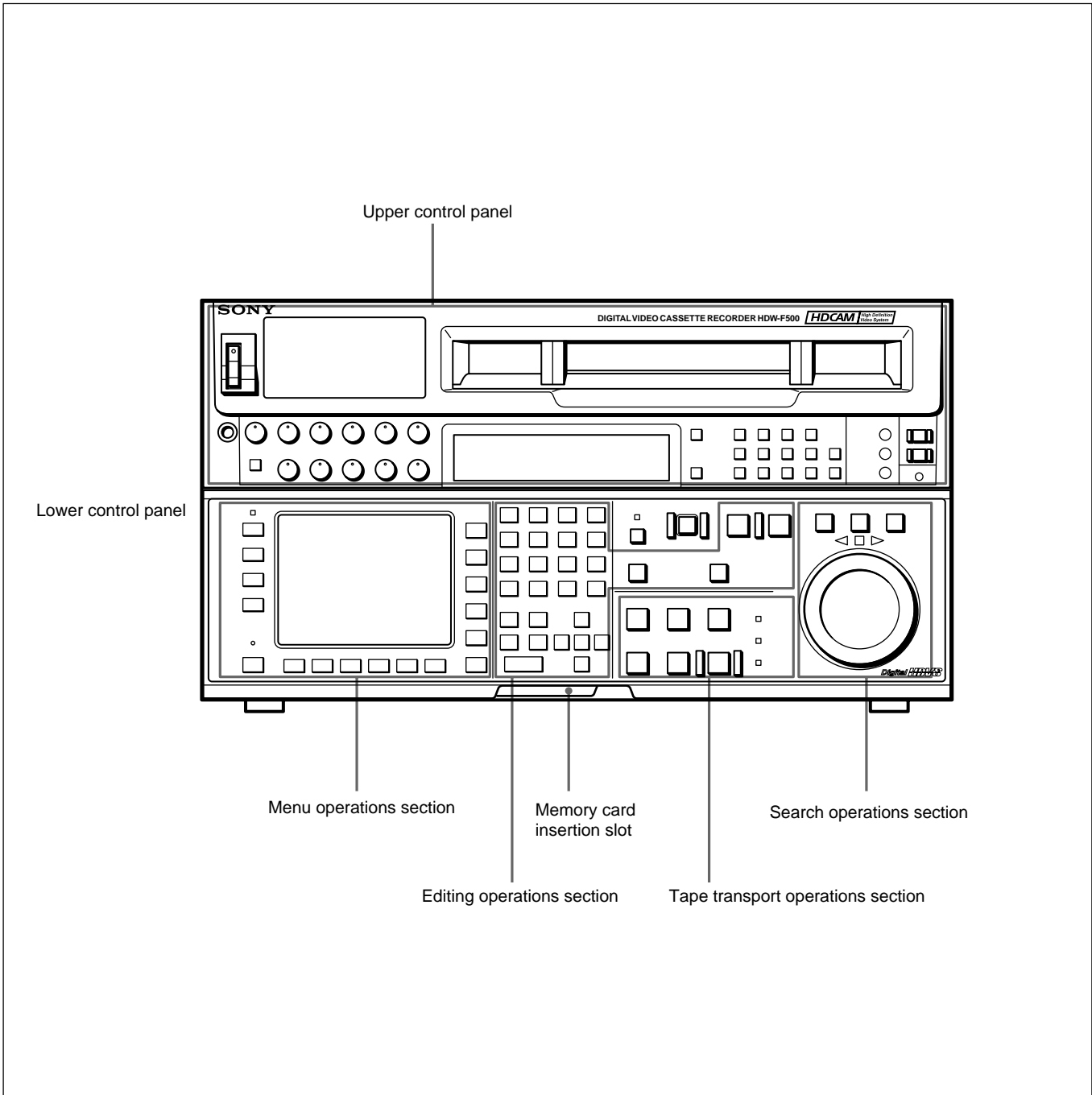

Control panel

2-1 Control Panel

2-1-1 Upper Control Panel

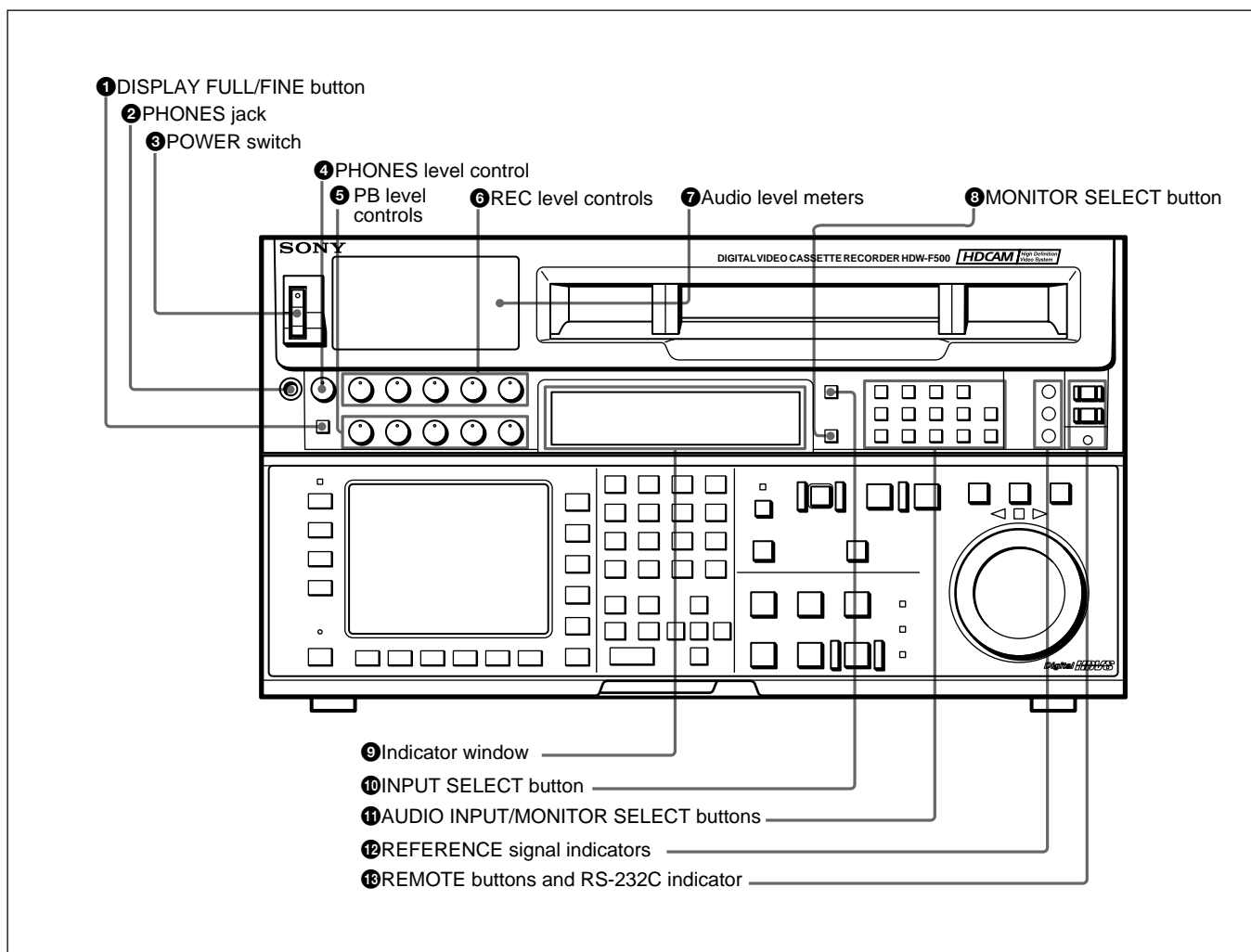

Upper control panel

1 DISPLAY FULL/FINE button

Changes the display range of the audio level meters.

FULL: Display range is -60 to 0 dB (peak level = 0 dB) or -40 to $+20$ dB (peak level = $+20$ dB).

Use 814. LEVEL METER SCALE in the VTR SETUP menu to select the range.

FINE: Displays the audio level in 0.25 dB increments. The center LED lights up in each meter as a signal level reference. When the level exceeds the maximum display value, the top LED flashes. When the level falls below the minimum display value, the bottom LED flashes.

2 PHONES jack

Connects stereo headphones with 8Ω impedance for audio monitoring during recording, playback, and editing. Adjust the headphone output level with the PHONES level control.

3 POWER switch

Turns on the power. When the power is turned on, the audio level meters and menu display in the lower control panel light up.

4 PHONES level control

Adjusts the output level to the PHONES jack. You can enable this control to simultaneously adjust the output level to the MONITOR OUTPUT connectors on the connector panel.

For details, see Section 5-1-2, “Selecting Audio Signals” on page 5-2.

5 PB (playback) level controls

Adjust the level of the audio output for channels 1 to 4 and the cue channel.

Pull out the controls during playback to adjust the audio output for each channel. Push in again for factory-set levels (+4 dB output for a signal recorded at a reference level of 0 dB). When pushed in, the controls cannot adjust the audio output level.

6 REC (recording) level controls

Adjust the recording level for channels 1 to 4 and the cue channel.

Pull out the controls to adjust the recording level for each channel in E-E mode¹⁾. Push in again for the factory-set recording level (0 dB reference level for an input of +4 dB). When pushed in, the controls cannot adjust the recording level.

7 Audio level meters

Indicate the recording level in recording or E-E mode or the playback level in playback or CONF mode. The display range can be changed by pressing the DISPLAY FULL/FINE button. The reference level is factory set at -20 dB, and the peak level at 0 dB.

8 MONITOR SELECT button

Selects the audio signal to be output at the MONITOR OUTPUT L/R connector(s). Press to light the button up, then press the AUDIO INPUT/MONITOR SELECT button(s) to specify which channel(s) are to be monitored at the MONITOR OUTPUT L or R connector. If you specify more than one channel to the same MONITOR OUTPUT connector, a mixed audio signal is output from that connector. This specification can also be done with setting the VTR SETUP menu 807~808 AUDIO MONITOR L~R select .

For details, see Section 4-6-3, “Selecting the Monitor Output Signal (MON-LSEL/MON-RSEL)” on page 4-58.

1) E-E mode

An abbreviation for Electric-to-Electric mode. In this mode, video or audio input signals are passed and output

9 Indicator window

The following indicators light up to indicate the VTR’s status.

Indicators and corresponding VTR status

Indicator	Status
CHANNEL CONDITION	Indicates the playback signal condition. Green: Playback signal is good. Yellow: Playback signal is less than good, but still reproducible. Red: Playback signal is poor. Head cleaning or internal inspection is necessary if the indicator lights up continuously.
INTERLACE	Lights when the VTR is operating under the interlace mode(50i/59.94i/60i).
PsF	Lights when the VTR is operating under the PsF mode(23.98PsF/24PsF/25PsF/29.97PsF/30PsF).
23.98	Lights when the VTR is operating with a frame frequency of 23.98 Hz.
24	Lights when the VTR is operating with a frame frequency of 24 Hz.
25	Lights when the VTR is operating with a frame frequency of 25 Hz.
29.97	Lights when the VTR is operating with a frame frequency of 29.97 Hz.
30	Lights when the VTR is operating with a frame frequency of 30 Hz.
ADV. AUDIO	Lights when item 821.AUDIO ADVANCE MODE in the VTR SETUP menu is set to “on.” When edit preset is set to “ON”, the HDW-F500 operates internally with “off” setting, so this indicator lights off.

For more information about the selection of the frame frequency, refer to the supplied Maintenance Manual.

only through the VTR’s internal circuitry, and not through the magnetic conversion system comprising tape and heads.

2-1 Control Panel

⑩ INPUT SELECT button

Selects the type and channel for the audio input signal. Press to light the button up, then press one of the AUDIO INPUT/MONITOR SELECT buttons to select the type and the channel of the audio signal.

HD SDI (CH-1 to CH-4): Selects the input signal from the HD SDI INPUT or SDTI (OPTION) IN connector.

AES/EBU (CH-1 to CH-4): Selects signal input to the AUDIO INPUT (AES/EBU) connectors.

ANALOG (CH-1 to CH-4): Selects signal input to the AUDIO INPUT connectors.

The INPUT SELECT button will flash if there is no incoming signal and HD SDI or AES/EBU is selected. This setting can also be done with setting the VTR SETUP menu 802~805 AUDIO INPUT select CH1~CH4.

Notes

- When the signal input to the SDTI (OPTION) IN connector is selected for the input video signal, the signal input to the SDTI (OPTION) IN connector is automatically selected for the input audio signal as well.
- When the audio signal input to the SDTI (OPTION) IN connector is selected for the input audio signal, only the INPUT SELECT button lights.

For details, refer to “4-6-1 Selecting the Audio Input Signal” on page 4-58.

⑪ AUDIO INPUT/MONITOR SELECT buttons

Select the audio input signal when the INPUT SELECT button is lit, or the audio signal to be monitored when the MONITOR SELECT button is lit.

⑫ REF SYNC (reference signal) indicators

These indicate the signal selected as the reference signal. If there is no reference signal input to the selected connector, the STOP button flashes.

EXT SD: Is lit when the video signal input to the REF. IN SD connector is acting as the reference signal.

EXT HD: Is lit when the video signal input to the REF. IN HD connector is acting as the reference signal.

INPUT VIDEO: Is lit when the video signal input to the HD SDI INPUT or SDTI (OPTION) IN connector is acting as the reference signal.

⑬ REMOTE buttons and RS-232C indicator

Press these buttons to select external equipment to be used to remotely control the VTR.

1(9 pin): Press to select the unit connected to the REMOTE1-IN(9P)/OUT (9P) connectors. The button lights up.

2(50 pin): Press to select the unit connected to the PARALLEL I/O (50P) connector (with optional BKDW-509). The button lights up.

RS-232C indicator: Lights up when the VTR is communicating with the external equipment connected to the RS-232C connector.

Note

When the VTR is being controlled by external equipment connected to the REMOTE1-IN (9P) or PARALLEL I/O (50P) connector, all tape transport buttons and edit operation buttons are disabled, except the STOP and EJECT buttons. You may also specify the disabling or enabling of all buttons by setting 008.LOCAL FUNCTION ENABLE in the VTR SETUP menu.

2-1-2 Lower Control Panel (Menu Operations Section)

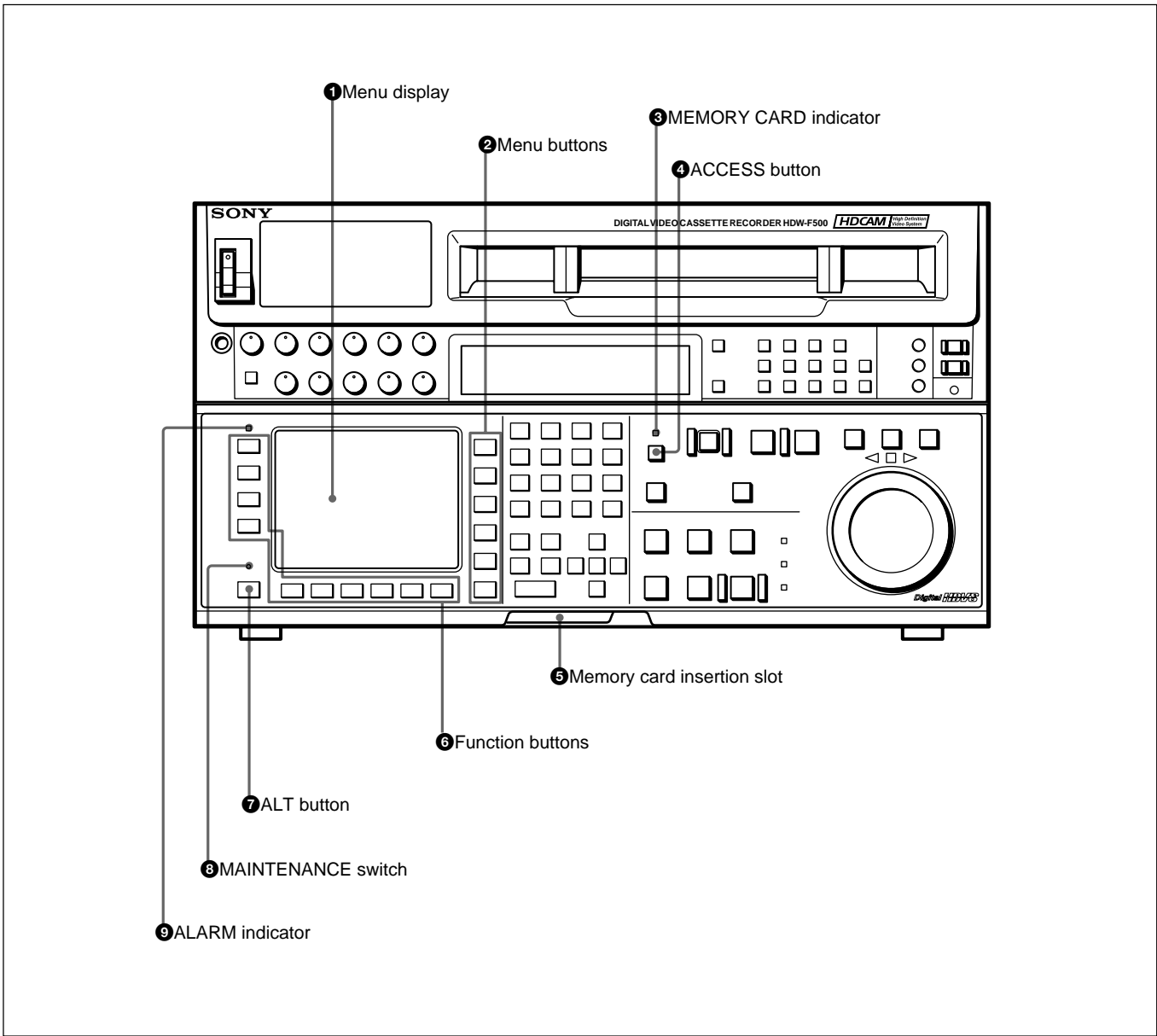

Lower control panel (menu operations section)

2-1 Control Panel

❶ Menu display

Menus selected by pressing the menu buttons appear here.

Each menu shows the functions assigned to each function button ([F1] to [F10]) and information necessary for making settings, such as time codes.

❷ Menu buttons

Press to activate the respective menu.

HOME button: Activates the HOME menu.

Settings for basic or editing operations are made in the HOME menu.

TC button: Activates the TC (time code) menu. In the TC menu, you can switch between LTC and VITC and between DF and NDF, and make settings for time code displays on an external monitor.

CUE button: Activates the CUE menu. In the CUE menu, you can register 10 cue points per page for a total of 100 cue points.

PF1 button: Activates the PF (Personal Function) 1 menu. In the PF1 menu, you can register frequently used settings in other menus. Settings for video input/output signals are factory set.

PF2 button: Activates the PF (Personal Function) 2 menu. In the PF2 menu, you can register frequently used settings in other menus. Settings for audio input/output signals are factory set.

SET UP button: Activates the SET UP menu. Use the SET UP menu to restore settings to the VTR memory banks or IC memory card, register functions to the PF1/2 menus, and set items in the VTR SETUP menu.

❸ Memory card insertion slot

Insert memory cards here. VTR settings can be stored on cards and used to configure the VTR and control panel at a later date, thus reducing the time required for set up.

Press the button beside the insertion slot to eject the memory card.

❹ Function buttons

Activates the functions in each menu.

❺ ALT (alternative) button

Press to change the functions of the current menu. Press again to return to the original functions.

❻ MAINTENANCE switch

Activates the MAINTENANCE menu.

To operate this switch, push it in using the tip of a pen or some other pointed object while holding down the SFT button.

❼ ALARM indicator

Flashes when the communication between the VTR and the control panel is abnormal.

For details, see Chapter 4, "Menu Settings" on page 4-1.

❸ MEMORY CARD indicator

Lights up when the memory card is inserted.

The indicator will flash when the memory card is improperly inserted or when the memory card battery is dead.

❹ ACCESS button

Press this button to directly activate the MEMORY CARD menu. Flashes when the control panel is accessing the memory card.

Note

Do not eject the memory card while the ACCESS button is flashing as this may damage the contents of the memory card.

2-1-3 Lower Control Panel (Editing Operations Section)

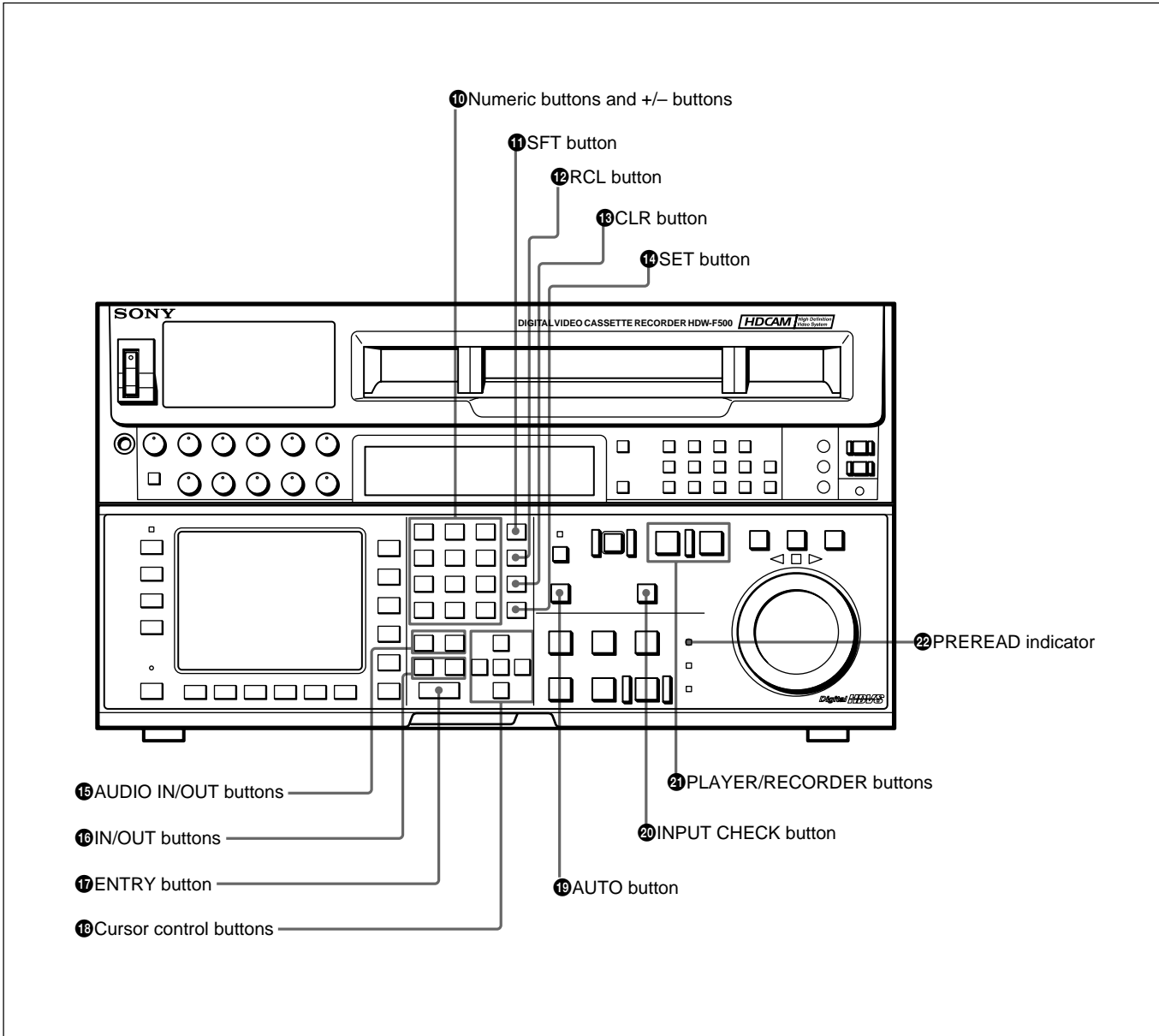

Lower control panel (editing operations section)

2-1 Control Panel

10 Numeric buttons and +/- buttons

Press to input time data or edit points data at the cursor position in menu display. Press buttons 0 to 5 while holding down the SFT button to input A to F (hexadecimal figures) for user bits. Use the +/- buttons to increase or decrease settings.

11 SFT (shift) button

Press buttons 0 to 5 while holding down this button to input A to F (hexadecimal figures) for user bits. Use also in combination with other buttons to perform other operations.

12 RCL (recall) button

Press to call up a previously entered value.

13 CLR (clear) button

Press to clear input data.

14 SET button

Press to finalize data.

15 AUDIO IN/OUT buttons

Press to set AUDIO IN and OUT points during insert mode. Press either AUDIO IN or OUT button while holding down the ENTRY button to set an audio edit point.

16 IN/OUT buttons

Press to set an IN or OUT point during editing. Press either button while holding down the ENTRY button to set an edit point.

17 ENTRY button

Press to enter an edit or cue point. While holding down this button, press either the AUDIO IN or OUT button, or the IN or OUT button.

18 Cursor control buttons

Press to move the cursor in the menu display. Move the cursor as required to enter a value using the numeric buttons, or to change a menu setting.

19 AUTO button

When this button is pressed, it lights up and auto edit mode is activated.

20 INPUT CHECK button

While you hold down this button, the input signal is output from the monitor output connector, so that you can monitor the input video and audio.

When the LTC/VITC time code is shown on the display, you can check the time code generator.

Note

When the optional HKDV-501A HD-SD Converter Board is installed in the unit and VTR SETUP menu item 776 DOWNCONVERTER INPUT CHECK ENABLE is set to "enable", you can monitor downconverter output. When you press the INPUT CHECK button, the input video and audio is output from all HD-SD converter output connectors.

21 PLAYER/RECORDER buttons

Select which VTR is to be controlled by this VTR's control panel during editing when this VTR is used as a recorder and an external VTR is connected to the REMOTE1-IN(9P)/OUT(9P) connectors as a player.

PLAYER: The tape transport buttons and editing operation buttons on the control panel control the external player VTR.

RECORDER: The tape transport buttons and editing operation buttons on the control panel control the recorder VTR (this VTR).

The PLAYER/RECORDER buttons have no effect when using this VTR alone.

22 PREREAD indicator

Lights up during preread mode.

For more information about PREREAD, see "6-2-3 Performing Preread Editing" on page 6-18.

2-1-4 Lower Control Panel (Tape Transport Operations Section)

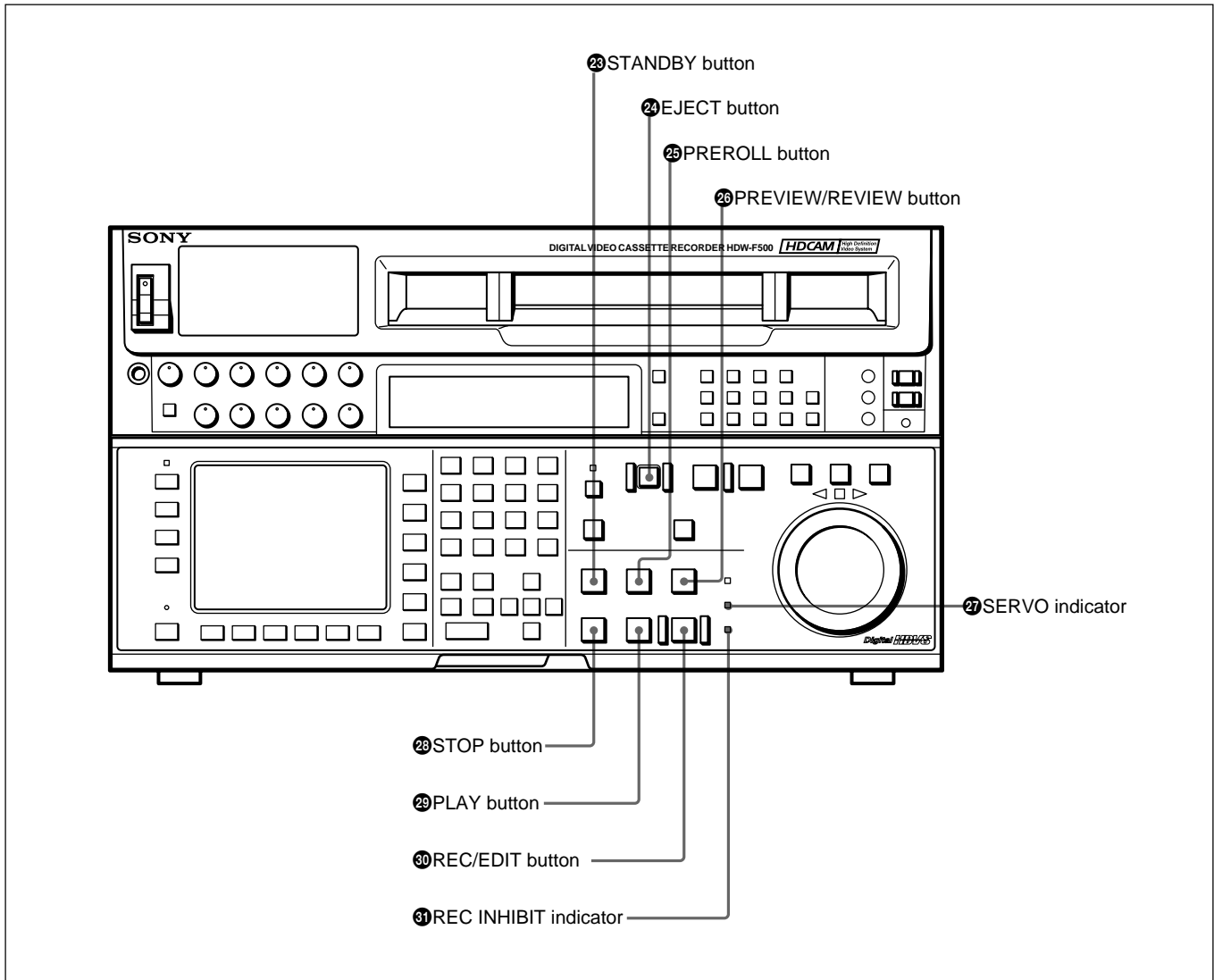

Lower control panel (tape transport operations section)

23 STANDBY button

Press this button in other than standby mode to make it light up and place the VTR in standby mode. The head drum rotates in standby mode, thereby shortening the time required for the tape to start. Press this button while in standby mode to turn the button off and cancel standby mode. The head drum stops rotating and the tape tension is released. If the VTR remains in standby mode for more than eight minutes (factory setting), standby mode is automatically canceled in order to safeguard the tape.

24 EJECT button

Press to eject the cassette. When the button is pressed, the tape is automatically unthreaded and the cassette is ejected in a few seconds. Resets the display when CTL codes appear in the menu display in the lower control panel.

2-1 Control Panel

25 PREROLL button

Press to position the tape to the preroll point (a position factory set to five seconds before the IN point).

Press this button while holding down the IN, OUT, AUDIO IN or AUDIO OUT button to cue up the tape at the edit point of the respective button.

For details on changing the preroll time, refer to “4-2-7 Setting the Preroll Time (PREROLLTIME)” on page 4-18.

26 PREVIEW/REVIEW button

After edit points are set, press this button to preview, on the monitor connected to the recorder, the effect of the edit before it is performed. In this operation, the tape runs, but no editing is carried out.

If you press this button after carrying out an edit, the results of the edit are played back on the monitor connected to the recorder.

27 SERVO indicator

Lights up when the drum servo and capstan servo are locked.

28 STOP button

When you insert the cassette, the VTR automatically enters stop mode.

The STOP button flashes when the **[F2]** (SERVO REF) button in the PF1 menu is set to input but there is no video input signal, when the **[F2]** (SERVO REF) button in the PF1 menu is set to ext but there is no external reference video signal, or when the input signal is out of sync with the external reference video signal. If you want, you can set 102. REFERENCE SYSTEM ALARM in the VTR SETUP menu so that the STOP button will not flash under the above conditions.

29 PLAY button

Starts playback.

Press this button while holding down the REC button to start recording.

Pressing this button during recording or manual editing changes the VTR to playback mode.

30 REC/EDIT (recording/edit) button

Press this button while holding down the PLAY button to start recording.

If you press this button in play mode manual editing begins. After setting edit points, if you press this button while the AUTO button is lit, automatic editing is performed.

31 REC INHIBIT indicator

The status of this indicator depends on the setting of the ALT button and **[F2]** (REC INH) button in the HOME menu and the state of the record-protect plug on the cassette.

Status of the REC INHIBIT indicator

Setting of the ALT and [F2] (REC INH) buttons in the HOME menu	State of the record-protect plug on the cassette	REC INHIBIT indicator
all	Recording disabled	Lit/flashing ^{a)}
	Recording allowed	Lit
crash REC, video/CTL, audio/CTL	Recording disabled	Lit/flashing ^{a)}
	Recording allowed	Unlit
off	Recording disabled	Lit/flashing ^{a)}
	Recording allowed	Unlit ^{a)}

a) Toggle between lit/flashing settings is possible using the 104.REC INHIBIT LAMP FLASHING setting in the VTR SETUP menu.

Recording, editing, and selection of assemble and insert modes are possible only when the indicator is off.

2-1-5 Lower Control Panel (Search Operations Section)

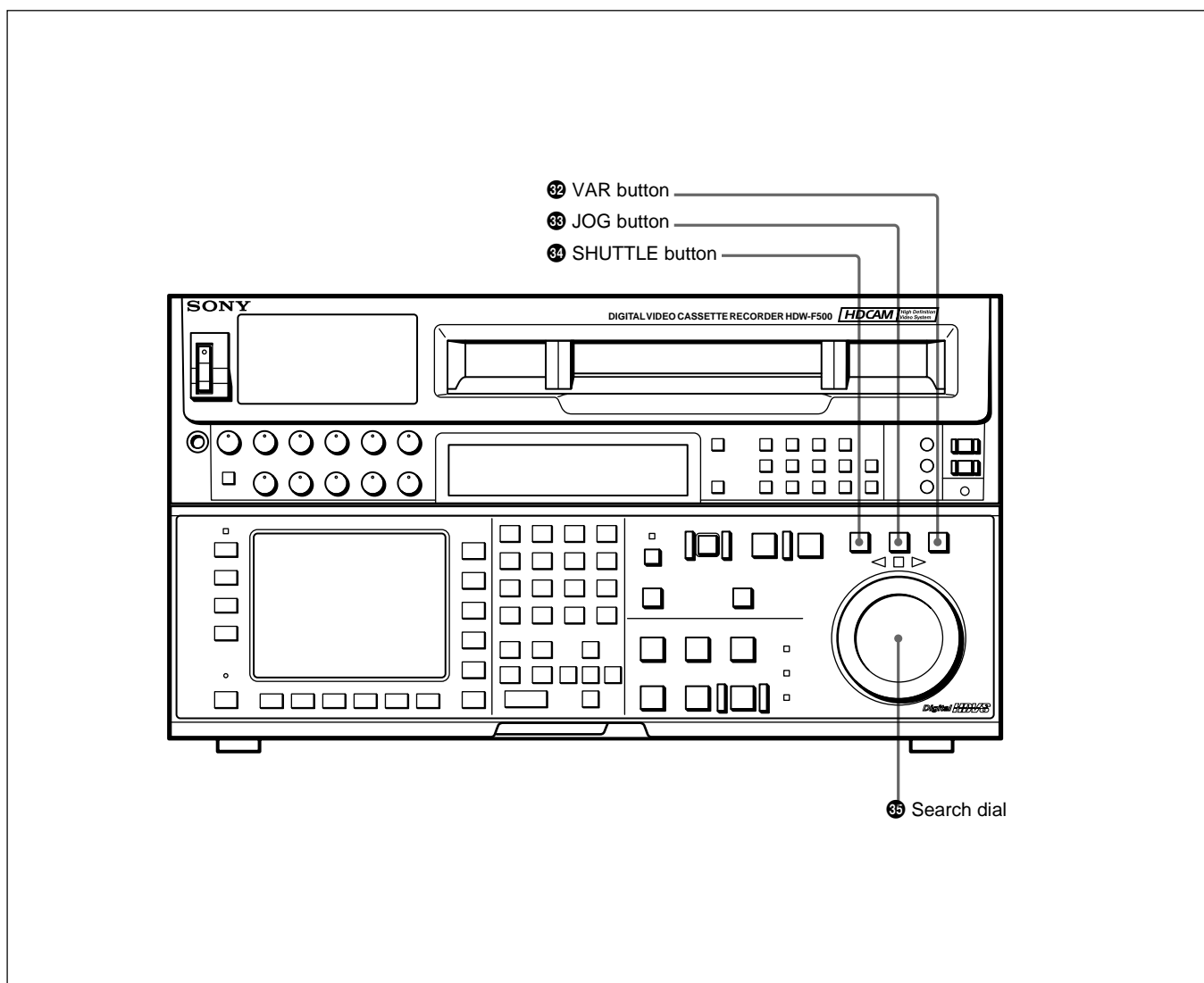

Lower control panel (search operations section)

32 VAR button

Press to select variable speed playback mode for noiseless playback in a maximum range of -1 to $+2$ times normal playback speed, in 51 steps. Playback exceeding this speed range is not possible. The search dial clicks at the positions for still-picture and normal playback speed.

33 JOG button

Press to select jog mode. In this mode, the button lights up and playback at -1 to $+1$ or -2 to $+2$ times normal playback speed is possible (determined by the 107. JOG DIAL RESPONSE setting in the VTR SETUP menu). In this mode, the search dial does not click.

34 SHUTTLE button

Press to enter shuttle mode. In this mode, the button lights and playback corresponding to the angle of rotation of the search dial. The playback speed is different depending on the frame frequency of the unit. In this mode, the search dial clicks at the positions for 0 (still-picture), -10 and $+10$ times normal playback speed.

Frame frequency	Playback speed
23.98/24 Hz	Ranging from -60 to $+60$
25 Hz	Ranging from -58 to $+58$
29.97/30 Hz	Ranging from -50 to $+50$

2-1 Control Panel

35 Search dial

Rotate to search for edit points. Rotate the dial clockwise for forward playback (the ► indicator lights up) or counterclockwise for reverse playback (the ◀ indicator lights up). The ■ indicator lights up while the VTR is in stop mode.

Shuttle mode: The playback speed is different depending on the frame frequency of the unit. (See item 34 SHUTTLE button.) The dial clicks at the positions corresponding to 0 (still-picture), -10 and +10 times normal playback speed.

Jog mode: The playback speed corresponds to the rotational speed of the dial (-1 to +1 or -2 to +2 times normal playback speed depending on the 107.JOG DIAL RESPONSE setting in the VTR SETUP menu). The dial does not click.

Variable speed playback mode: Noiseless playback at -1 times normal speed when the dial is rotated fully counterclockwise, and +2 times normal speed when rotated clockwise. The dial clicks at the positions of still-picture and normal playback speed.

Capstan override mode: Rotating the dial while holding down the PLAY button changes the playback speed by up to ±15%.

After turning the power on, always set the search dial at the center position (where the ■ indicator lights up).

2-2 System Set-Up Panel

Lift the lower control panel up to its horizontal position to access the system set-up panel.

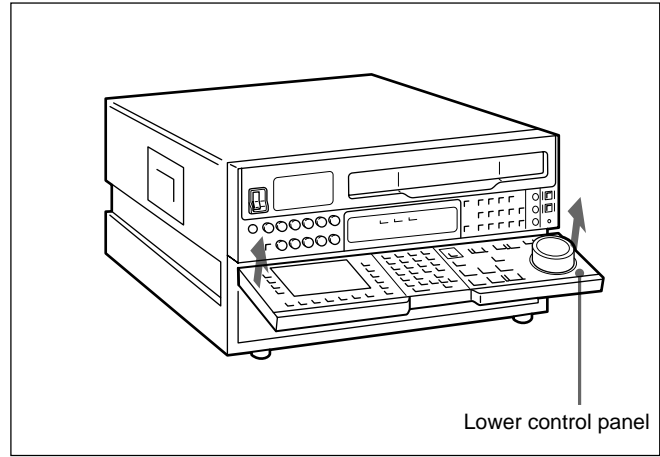

Accessing the system set-up panel

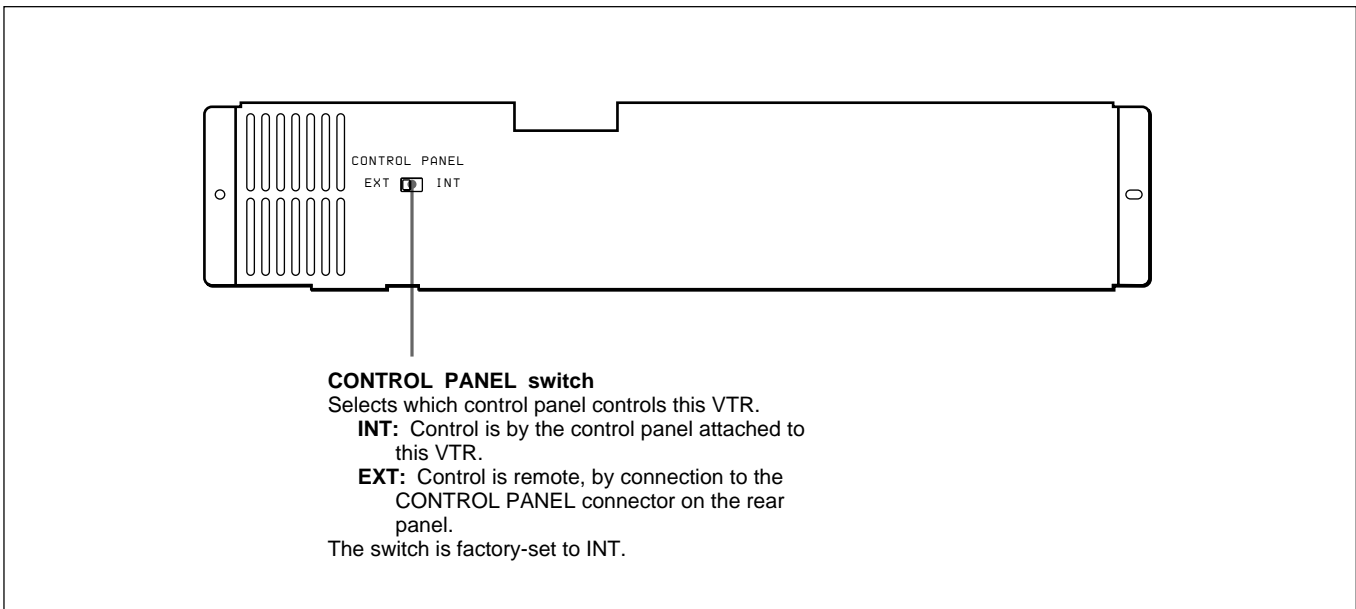

System set-up panel

2-3 Connector Panel

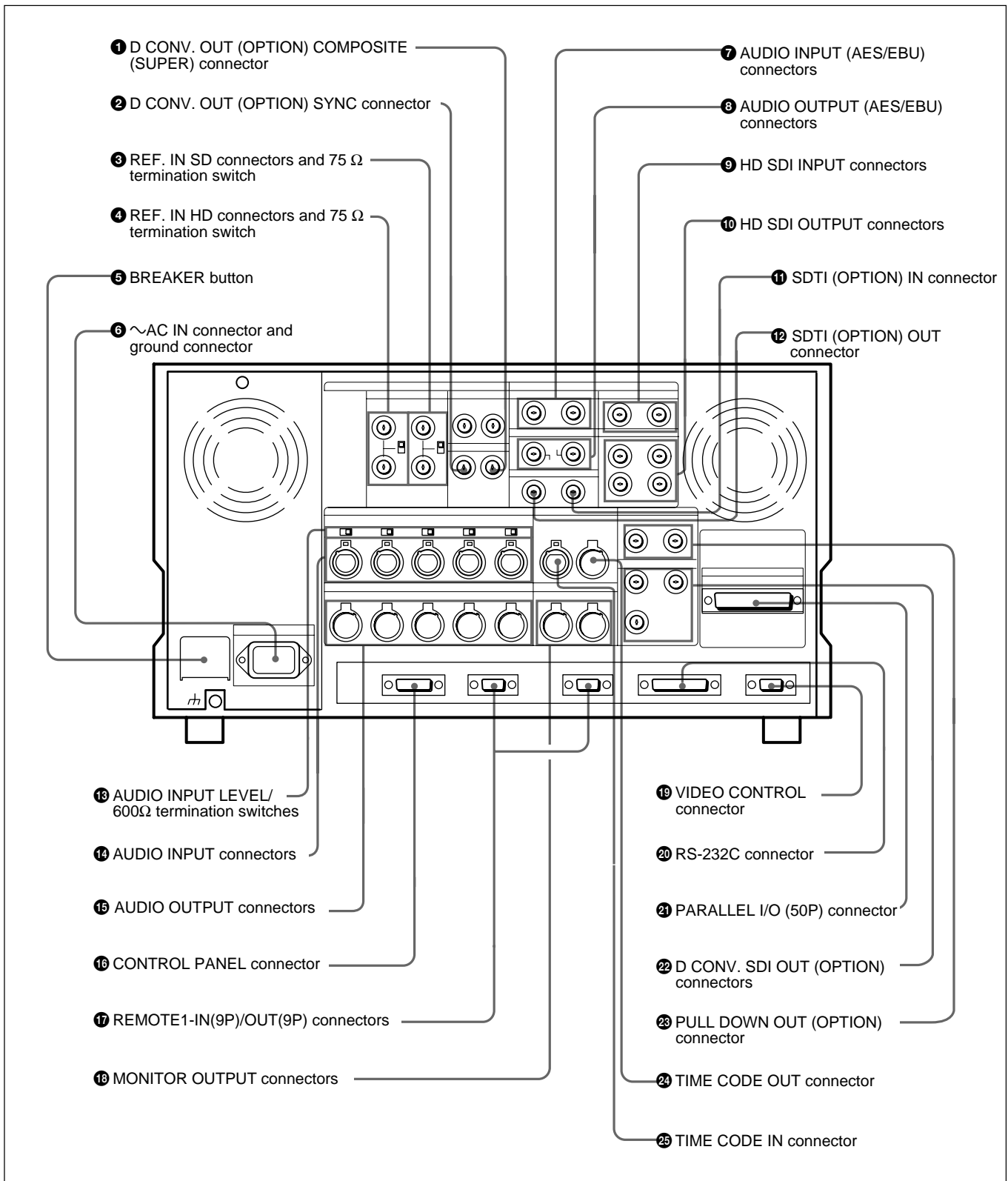

Connector panel

Note

For the AUDIO INPUT CH1/2/3/4 CUE connectors, AUDIO OUTPUT CH1/2/3/4/CUE connectors, as well as the TIME CODE IN/OUT (XLR, 3 pins)

connectors, the type (male or female) of input/output connectors used overseas are opposite of those used in Japan. To use this unit with audio equipment outside of Japan, you must use male/female adapters.

❶ D CONV. OUT (OPTION) COMPOSITE (SUPER) connector (BNC)

Outputs an analog composite signal for a video monitor. When the ALT/[F6] (CHARA SUPER) setting in the TC menu is on, character signals such as time codes are superimposed on the output.

Note

This connector is operative only when the optional HKDV-501A HD-SD Converter Board is installed.

❷ D CONV. OUT (OPTION) SYNC connector (BNC)

Outputs an NTSC external sync signal.

Notes

- This is effective only when the optional HKDV-501A HD-SD Converter Board is installed.
- The phase is the same as the phase of the composite signal output from the COMPOSITE (SUPER) of D CONV. OUT (OPTION) connector. Because the output phase changes with the operation mode of the VTR, use this to synchronize with the video monitor.

❸ REF. IN SD connectors (BNC) and 75 Ω termination switch

Inputs for a reference video signal (NTSC or PAL) of the selected field frequency. Use a video signal with chroma burst (VBS) or a monochrome video signal (VS).

A loop-through connection is possible. Set the 75 Ω termination switch to OFF if you are using a loop-through connection and set it to ON if you are not using a loop-through connection.

❹ REF. IN HD connectors (BNC) and 75 Ω termination switch

Inputs for a reference video signal (HD) of the selected field frequency. Use a trilevel SYNC signal for the external synchronization. A loop-through connection is possible. Set the 75 Ω termination switch to OFF if you are using a loop-through connection and set it to ON if you are not using a loop-through connection.

❺ BREAKER button

Primary circuit breaker for the AC power circuit.

❻ \sim AC IN connector and connector

Connects to an AC outlet using the power cord supplied with the VTR.

❼ AUDIO INPUT (AES/EBU) connectors (BNC)

Inputs for digital signals in AES/EBU format for channels 1 to 4.

❽ AUDIO OUTPUT (AES/EBU) connectors (BNC)

Outputs digital signals in AES/EBU format for channels 1 through 4.

❾ HD SDI (SDI video/audio) INPUT connectors (BNC)

The left connector accepts HD SDI video/audio signals.

Note

The INPUT MONITOR connector is for use with an input monitor and does not follow the standards for output.

❿ HD SDI (SDI video/audio) OUTPUT connectors (BNC)

Outputs up to four (1 to 4) HD SDI video/audio signal lines.

Character data such as time codes are superimposed on the signal from the MONITOR connector when the ALT/[F6] (CHARA SUPER) setting in the TC menu is set.

⓫ SDTI (OPTION) IN connector (BNC)

Outputs a video/audio SDTI signal.

Note

This connector is operative only when the optional HKDV-506A SDTI Board is installed.

⓬ SDTI (OPTION) OUT connector (BNC)

Inputs a video/audio SDTI signal.

Note

This connector is operative only when the optional HKDV-506A SDTI Board is installed.

2-3 Connector Panel

13 AUDIO INPUT LEVEL/600Ω termination switches

The termination switches should be set for in ANALOG AUDIO INPUT connector according to the audio input level and input impedance.

Use OFF for low input levels when:

Audio input level is -60 dBu (microphone input) and audio input impedance is high (approximately 20 kΩ)

Use OFF for high input levels when:

Audio input level is +4 dBu (line input) and audio input impedance is high (approximately 20 kΩ)

Use ON for high input levels when:

Audio input level is +4 dBm (line input) and audio input impedance is 600Ω

14 ANALOG AUDIO INPUT connectors (XLR-3-32)

Accepts up to five analog audio signal lines (channels 1 to 4 and cue).

15 ANALOG AUDIO OUTPUT connectors (XLR-3-31)

Outputs up to five analog audio signal lines (channels 1 to 4 and cue).

16 CONTROL PANEL connector (15-pin)

Connects the control panel through the 15-pin cable when using the control panel is used as a remote controller.

17 REMOTE1-IN (9P)/OUT (9P) connectors (D-sub 9-pin)

Used with the included 9pin remote control cable to connect two HDW-F500 VTRs, or a second HD VTR when a BVE900/910/2000/9000/9100 series BVE Editing Control Unit is used for editing. Used when you edit using two VTRs and the BVE-900/910/2000/9000/9100 Editing Control Unit. The REMOTE1-IN and OUT connectors can be used to make a bridge connection.

18 MONITOR OUTPUT connectors (XLR-3-31)

Outputs signals for audio monitoring. These connectors output two signal lines: L and R. Select the signals to be output with the MONITOR SELECT buttons and the AUDIO INPUT/MONITOR SELECT buttons on the upper control panel. A setting can be made so that volume can be controlled with the PHONES volume knob.

For details, see Section 5-1-2, "Selecting Audio Signals" on page 5-2.

19 VIDEO CONTROL (Digital Video Processor Control) connector (D-sub 9-pin)

Connects to the optional HKDV-503 HD Digital Video Controller to enable remote control of the internal digital video processor. Turn off the power before connecting the remote controller.

20 RS-232C connector (RS-232C serial interface) (D-sub 25-pin)

Receives or transmits RS-232C serial remote control signals and/or VTR status data from/to external equipment. When this connector is being used for communication, the RS-232C indicator on the upper control panel will be lit.

21 PARALLEL I/O (50P) connector (D-sub 50-pin, with optional BKDW-509)

Inputs an external remote control signal.

For details, refer to the Maintenance Manual.

22 D CONV. SDI (D1/D2 SDI video/audio) (OPTION) OUT connectors (BNC)

Outputs up to three sets of video/audio signals. When the ALT/[F8] (CHARA SUPER) key of the TC menu is set to ON, text data such as time codes are superimposed on the output of connector 3 (SUPER). Selection of D1/D2 output is made using the [F9] (OTHERS CHECK)/[F9] (SYSTEM)/[F3] (D-CONV SDI) button in the MAINTENANCE menu.

Note

This connector is operative only when the optional HKDV-501A HD-SD Converter Board is installed.

23 PULL DOWN OUT (OPTION) connectors (BNC)

Outputs two sets of 2-3 pull down video/audio signals. When the ALT/[F5] (PD CHARA) key of the TC menu is set to ON, text data such as time codes are superimposed.

Note

This connector is operative only when the optional HKDV-507/507D HD PULL DOWN Board is installed.

24 TIME CODE OUT connector (XLR-3-31)

Outputs the following time codes according to the VTR operation mode.

In playback mode: Playback time codes

In recording mode: Time codes generated by the internal time code generator, or time codes input to the TIME CODE IN connector.

To select the output signal for the TIME CODE OUT connector, use the 613.TC OUTPUT SIGNAL IN REGEN MODE setting in the VTR SETUP menu.

Setting	Description
off tape	In playback mode, playback time codes are selected, and in recording mode, TCH time code signals are used.
regene	Playback time codes are regenerated and output only in playback mode when the servo is locked. In all other cases, output is the same as for the "off tape" setting.
through	The time code signal from the TIME CODE IN connector is output as is. (Used during cascade connections.) <i>(For more information about cascade connections, see 3-1-4 Cascade Connections on page 3-4.)</i>

25 TIME CODE IN connector (XLR-3-32)

Accepts external time codes for recording to tape. Connect to the time code output connector of the external equipment.

3-1 Connecting External Equipment

3-1-1 Making Digital Connections

This example shows how to connect the HDD/HDDP-1000 1 inch HD Digital VTR and use it as the player

with the HDW-F500 acting as the recorder in the 59.94i or 60i mode.

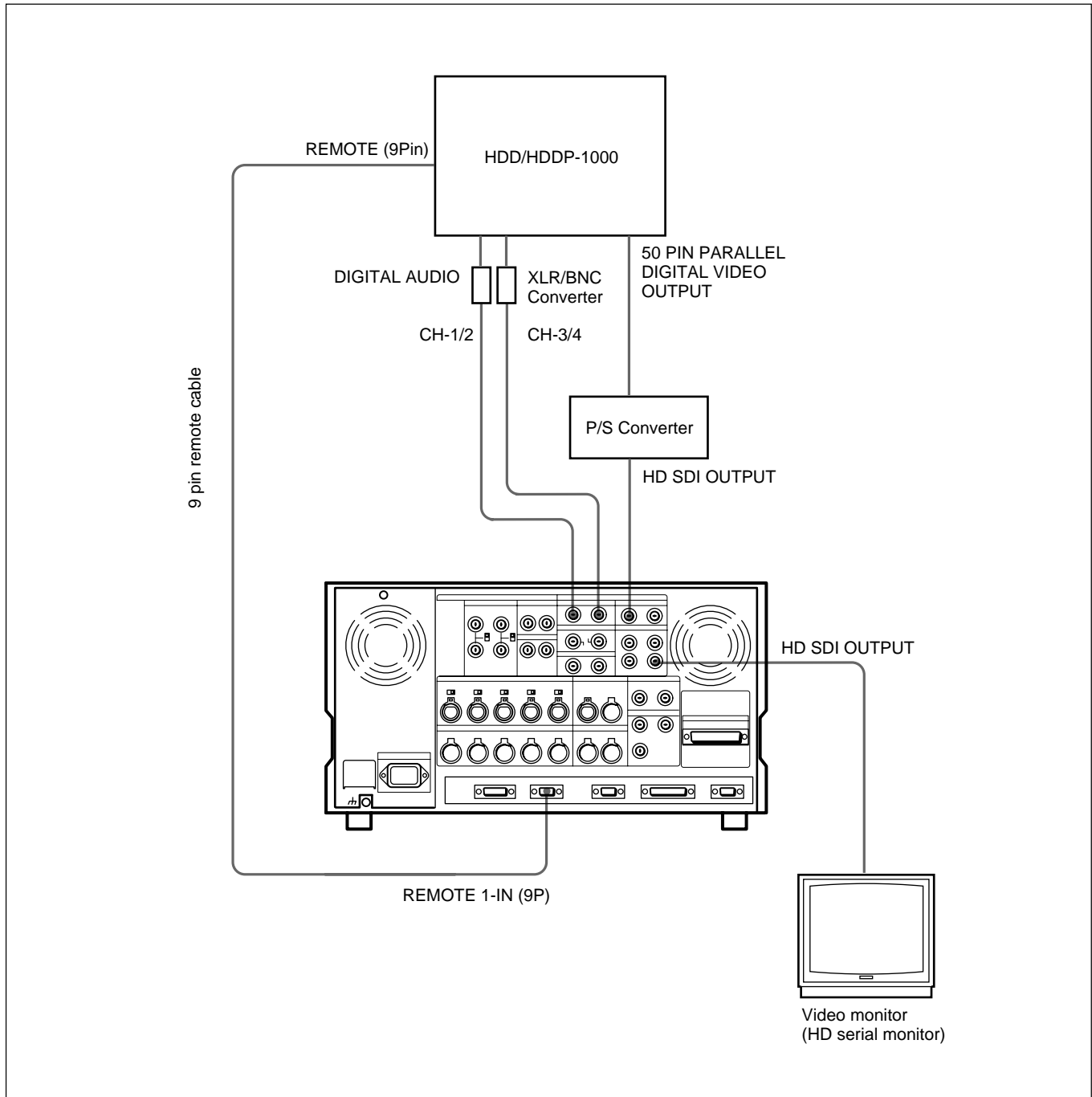

Making digital connections

Refer to the "Specifications" section in the appendix (page A-2) for recommended XLR/BNC and P/S converters.

3-1 Connecting External Equipment

3-1-2 Making HD Analog Connections

This example shows how to connect the VTR when using HD analog audio and video signals in the 60i mode.

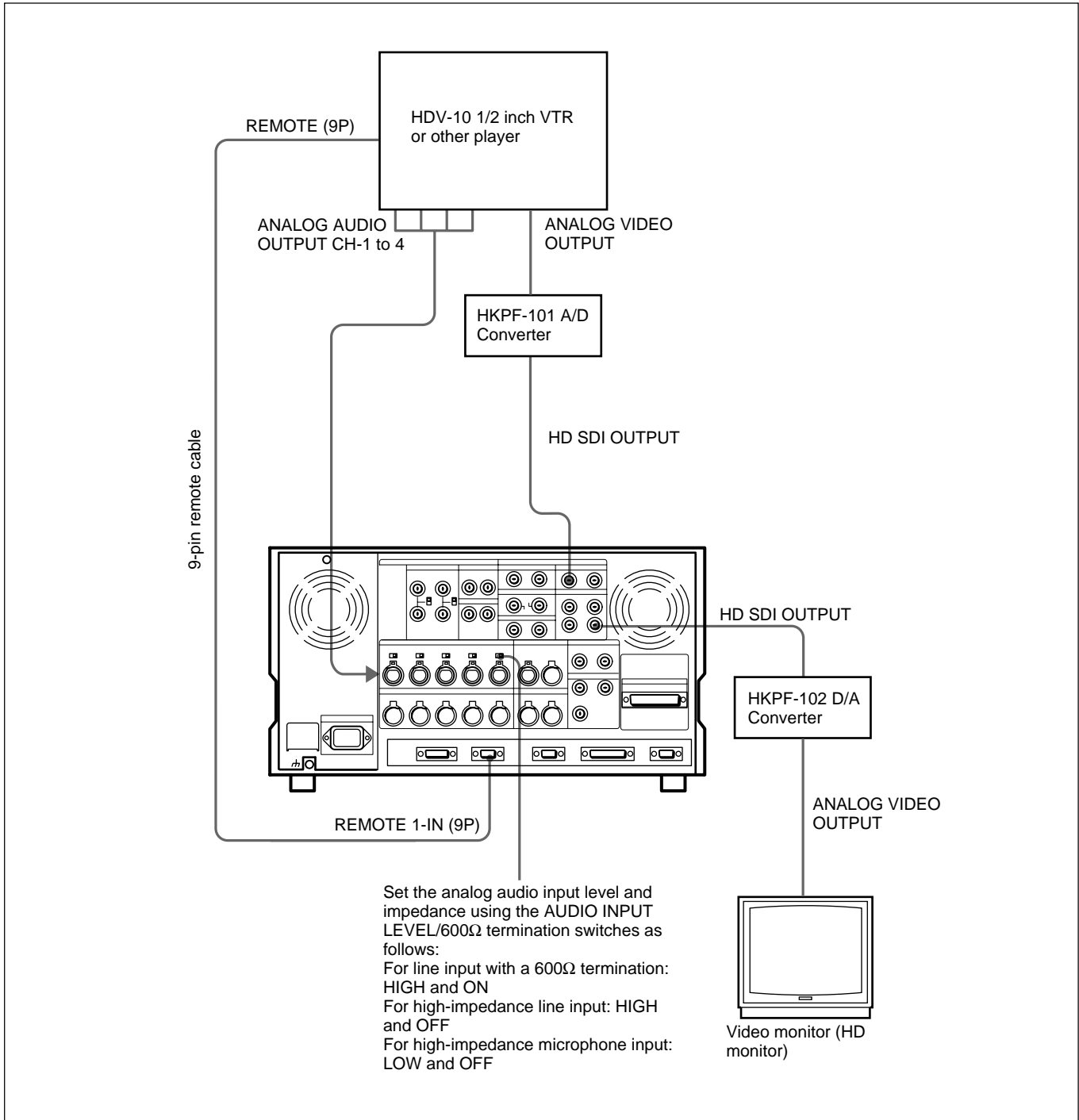

3-1-3 Making NTSC/PAL Digital Connections

This example shows how to connect two VTRs together, using an HDW-F500 as the players and a DVR-2100 D-1 Component Digital VTR as the recorder.

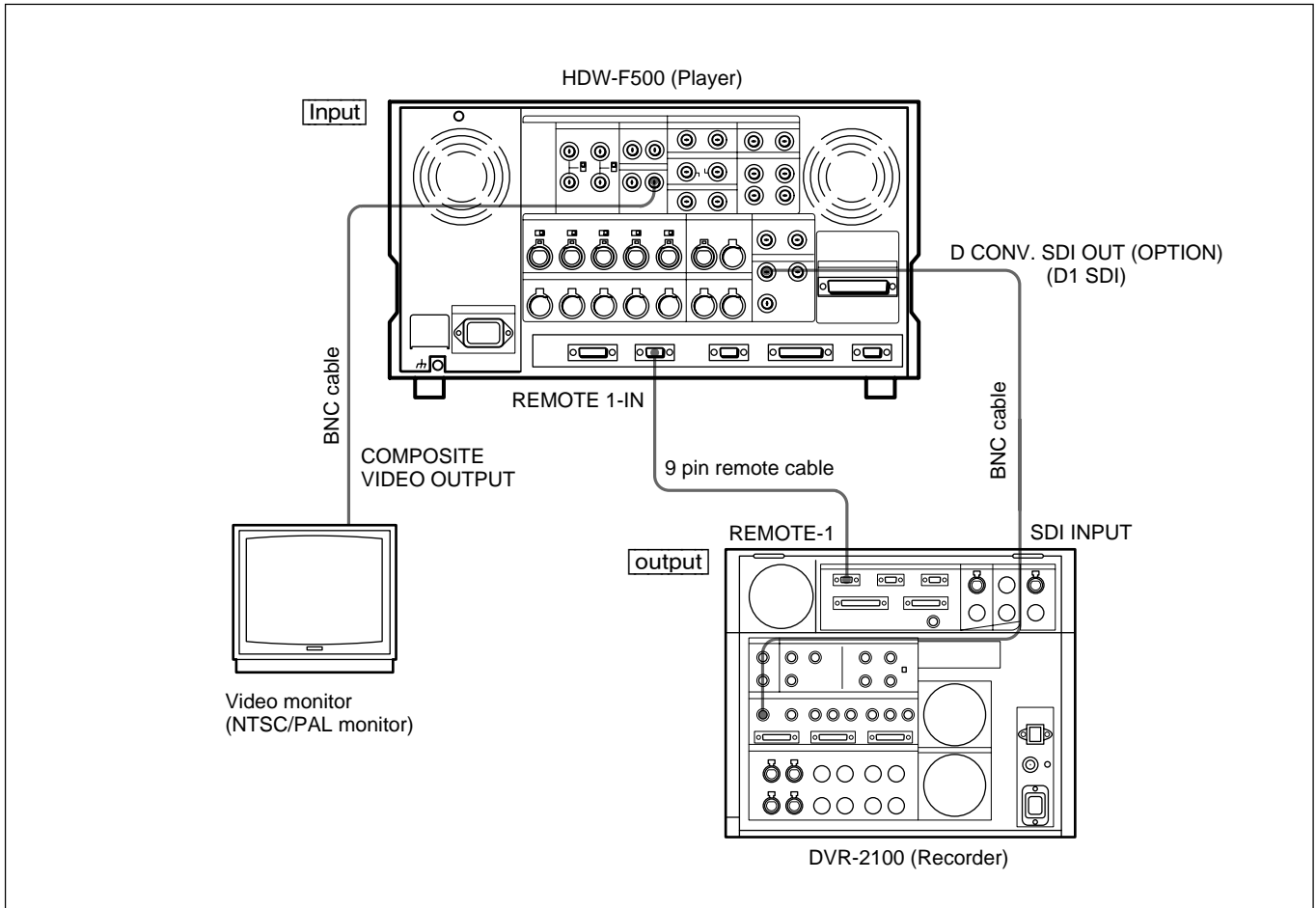

Note

For color frame editing using the HDW-F500 as the player and an NTSC/PAL digital device as the recorder, set 005.SERVO/AV REFERENCE select in the VTR SETUP menu to external and set 006.EXTERNAL REFERENCE select to extern SD.

3-1 Connecting External Equipment

3-1-4 Cascade connection

This example shows how to connect multiple HDW-F500 VTRs together for simultaneous recording.

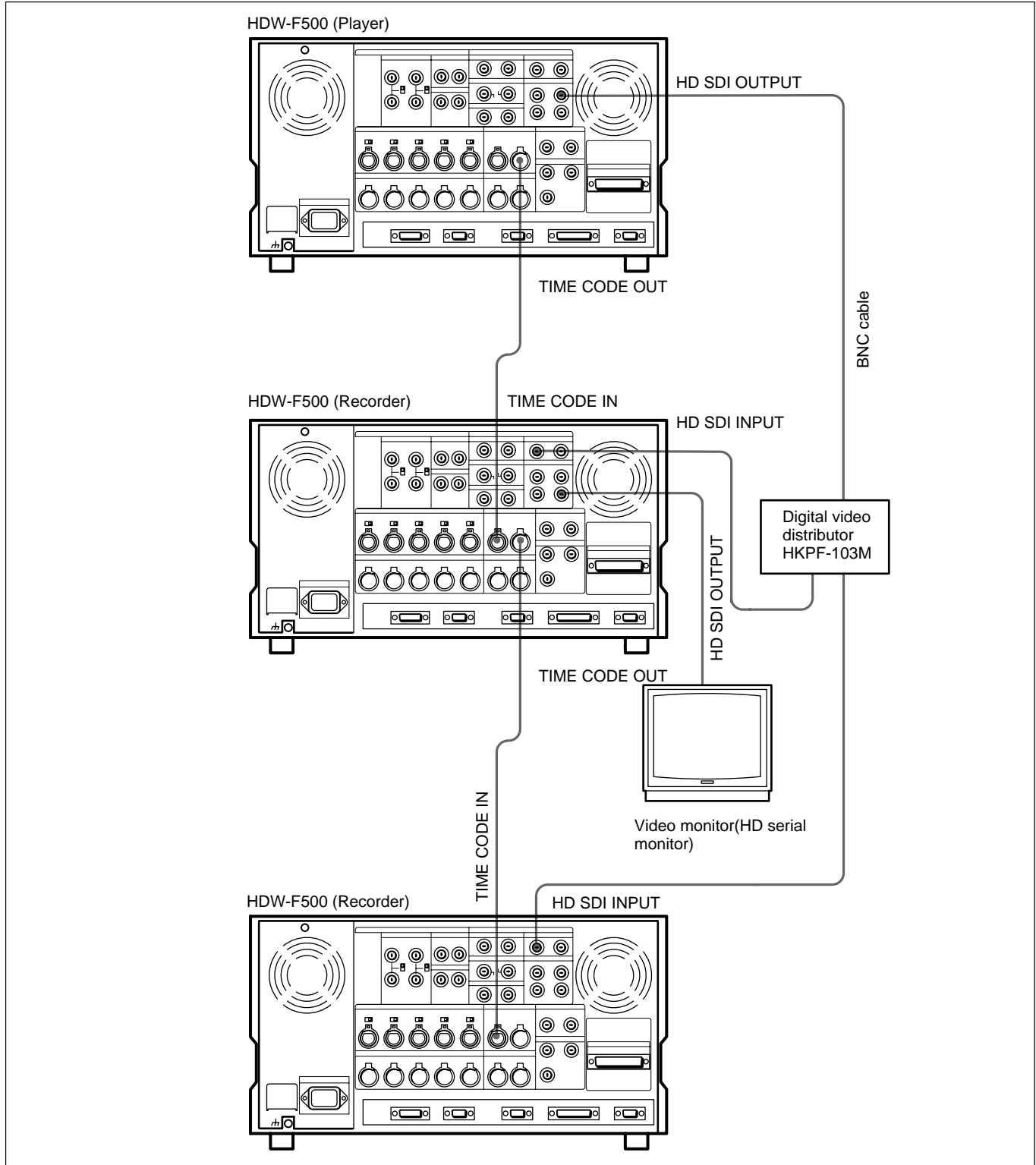

Note

On the recording VTRs, set 613.TC OUTPUT

SIGNAL IN REGENE MODE in the VTR SETUP menu to through.

3-2 Reference Signals for Video Output and Servo System

This section describes how reference signals for the video output and servo system are selected.

3-2-1 Reference Signals for Output Video

Depending on the operating condition, VTR SETUP menu setting, and the input signal, the video output signal from the VTR can be synchronized as follows.

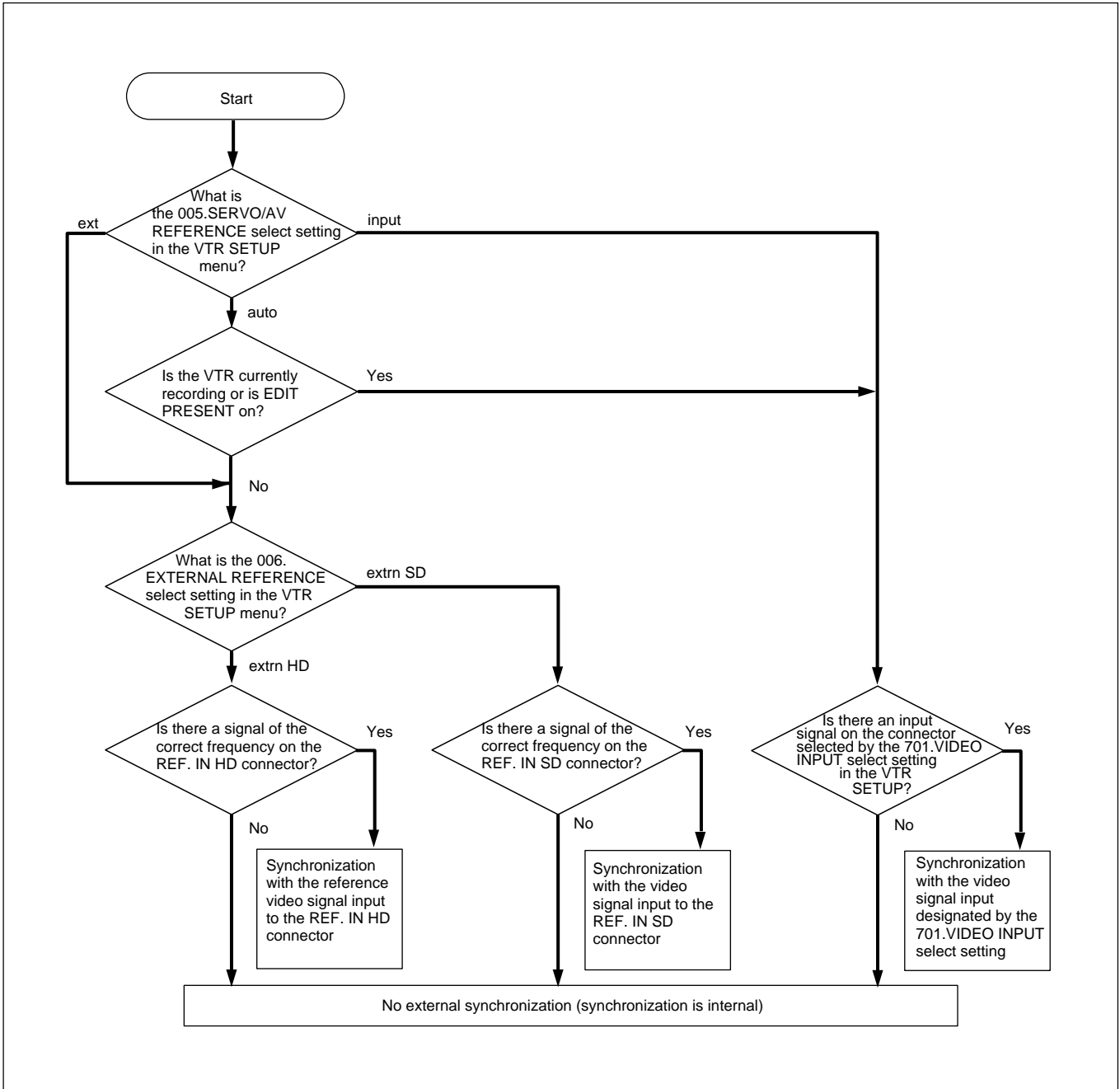

3-2 Reference Signals for Video Output and Servo System

3-2-2 Reference Signals Connections

Make the reference signal connections as follows, according to your recording or playback requirements.

Reference signal connections

For recording signals from a switcher or signal generator

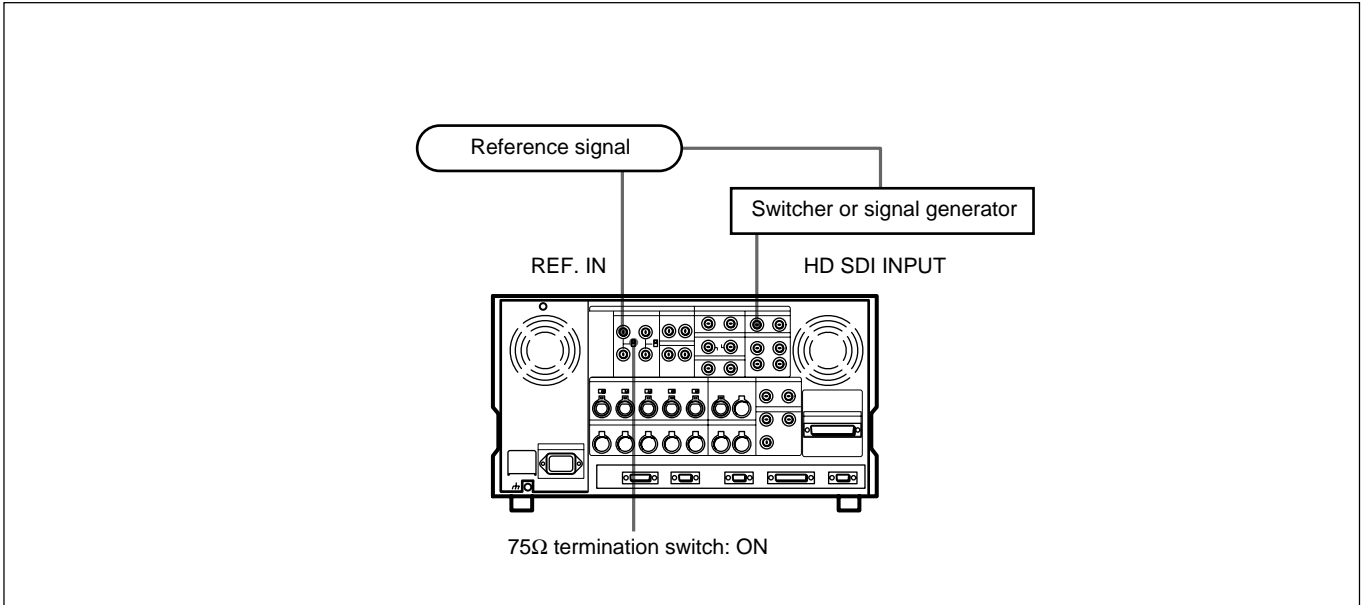

For recording signals from a switcher or signal generator

For recording signals from a HD VTR

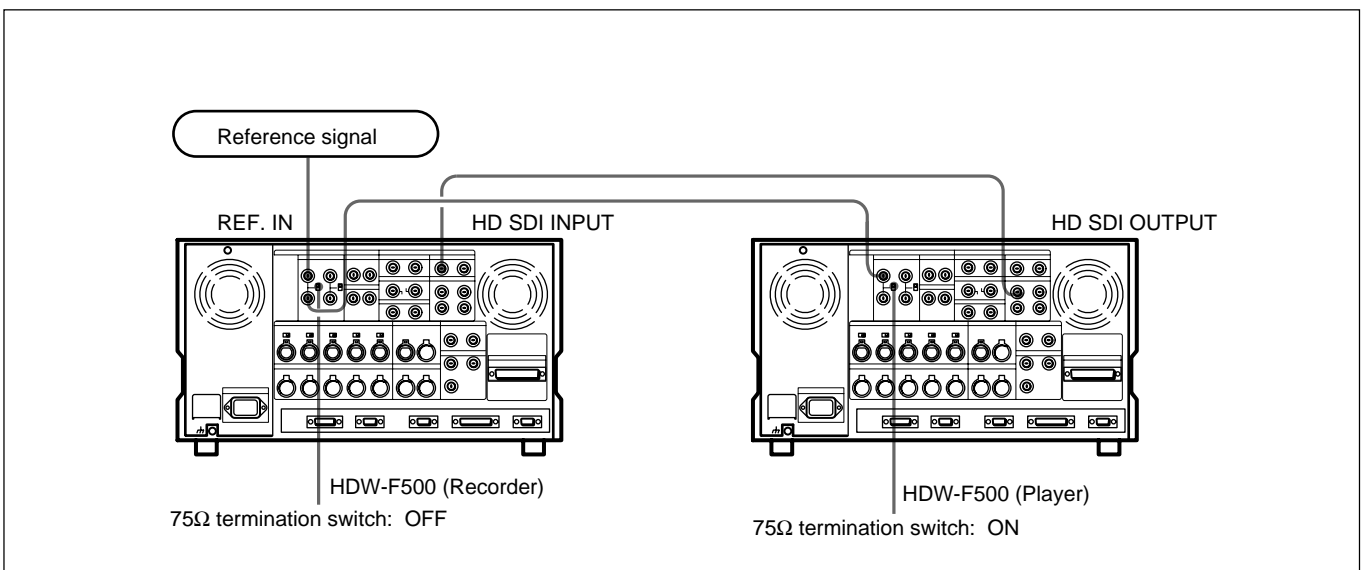

For recording signals from a HD VTR

For playback

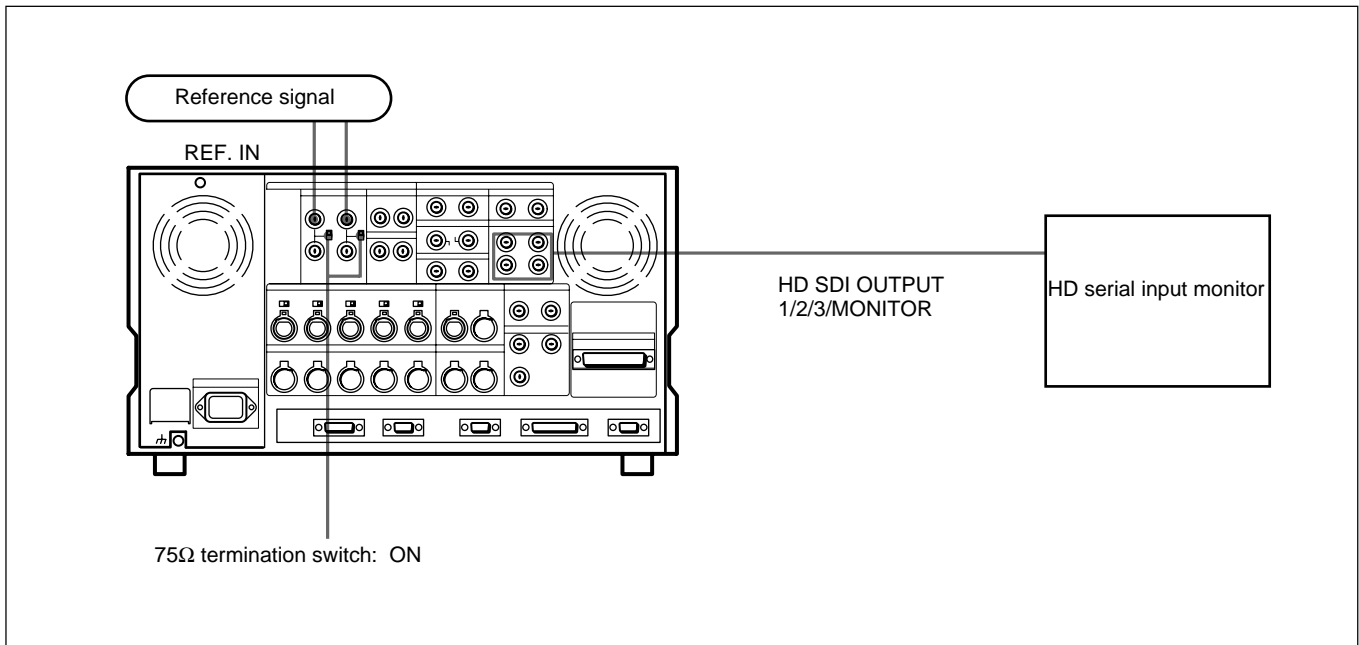

Note

The following signals can be used as a reference signal.

- HD trilevel SYNC signal of an appropriate field frequency for the external synchronization
- Black burst signal of 525/59.94 Hz
- Black burst signal of 625/50 Hz

Input the signal of the appropriate field frequency for your system.

3-3 Handling Cassettes

3-3-1 Recommended Cassettes

Use 1/2 inch HDCAM cassettes.
The maximum recording time is as shown in the following table.

System frequency HDCAM cassette	29.97/30 Hz	25 Hz	23.98/24 Hz
S-size cassette	40 minutes	48 minutes	50 minutes
L-size cassette	124 minutes	149 minutes	155 minutes

Note

Digital Betacam cassettes cannot be used.

Storage of cassettes

Store your cassettes at room temperature and normal humidity.

3-3-2 Inserting and Ejecting Cassettes

Always turn on the VTR before attempting to insert or eject cassettes.

Inserting a cassette

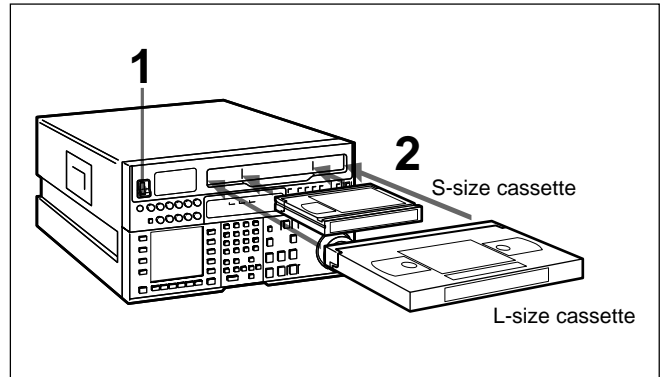

Inserting a cassette

- 1 Turn the POWER switch to ON.
- 2 Before inserting a cassette, check the following points:
 - There is no slack in the tape.
 - An error message does not appear in the menu display.
 - The window of the cassette is facing up.

If there is any slack in the tape, refer to “Removing slack in the tape” on next page.

When inserting an S-size cassette, make sure it is aligned with the marks on the cassette insertion slot.

The cassette is loaded automatically, and the tape is wound around the drum.

Removing slack in the tape

Press one of the reels in slightly, then carefully rotate it in the direction of the arrow until it stops.

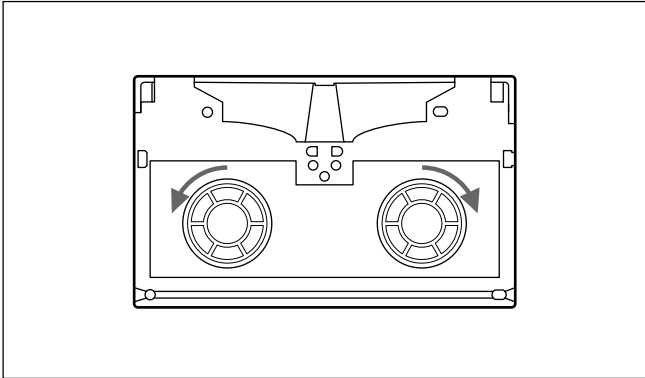

Removing slack in the tape

Preventing double cassette inserting

When a cassette is loaded, an orange lock-out bar appears in the cassette insertion slot to prevent users from attempting to load another cassette.

Ejecting the cassette

Press the EJECT button.

The tape is unthreaded and the cassette is automatically ejected. This operation takes a few seconds.

To cancel ejecting a cassette

Press any operation button before the cassette is completely ejected. The cassette is loaded again and the operation corresponding to the button you pressed starts.

3-3-3 Preventing Accidental Erasure

To prevent accidental erasure of material recorded on a tape, push in the record-protect plug.

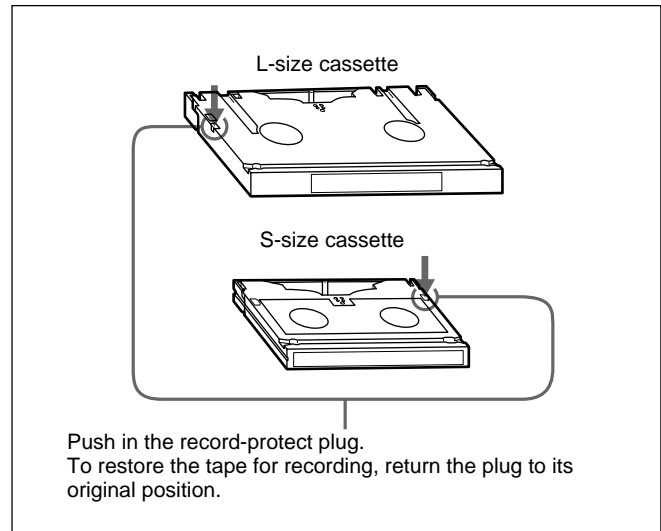

Push in the record-protect plug.
To restore the tape for recording, return the plug to its original position.

Preventing accidental erasure

When a cassette with this plug pushed in is inserted into the VTR, the REC INHIBIT indicator on the lower control panel lights up and recording will not start, even if you press the REC button. To restore the tape for recording, return the plug to its original position.

4-1 Registering and Storing Menu Settings

The operating conditions of the VTR are set using the menu operation section on the lower control panel.

Menu items are divided among six different menus (HOME, TC, CUE, PF1, PF2, SET UP).

Of these menus, the PF1/PF2 (Personal Function) menus can be used to register frequently used menu items from the other menus, allowing faster setting of VTR operating conditions. Eight VTR memory banks are provided for storing up to eight sets of menu settings. The contents of the eight VTR memory banks can, in turn, be stored on a memory card for later recall.

4-1-1 Menu Configuration

This VTR has two kinds of menus.

PF1&2 ASSIGN menu

This menu contains items that can be registered to the PF1/2 menus.

Press the **[F4]** (PF1&2 ASSIGN) button in the SET UP menu to display this menu.

For details on registering items in the PF1&2 ASSIGN menu to the PF1/2 menus, see Section 4-1-3, "Registering Items to the PF1/2 Menus" on page 4-3.

VTR SETUP menu

This menu contains items that specify the initial operating conditions of the VTR. You can change these settings directly without registering the items to the PF1/2 menus.

Press the **[F6]** (VTR SETUP) button in the SET UP menu to display this menu.

For details on setting operating conditions of the VTR, see Section 4-7-1, "VTR SETUP Menu" on page 4-61.

The menu configuration of the VTR is shown in the figure below,

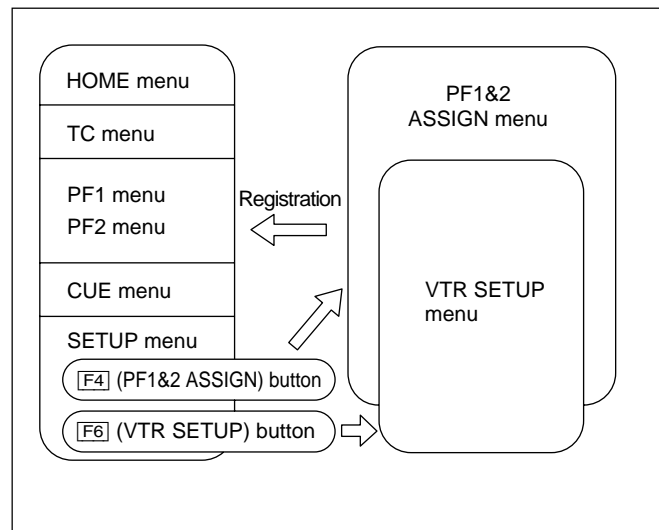

Menu configuration

- All items in the HOME, TC, and CUE menus can be duplicated and registered to the PF1/2 menus.
- Most items in the VTR SETUP menu can be registered to the PF1/2 menus.

4-1 Registering and Storing Menu Settings

4-1-2 Changing Menu Settings

To activate the HOME, TC, CUE, PF1, PF2, or SET UP menu, press the respective menu button. Menu items are assigned to function buttons (F1 to F10) in each menu. When two items are registered to the same function button, you can display the second item by pressing the ALT button. The example below describes the procedure for changing the setting specified by the ALT button and F5 (CAP LOCK) button in the HOME menu.

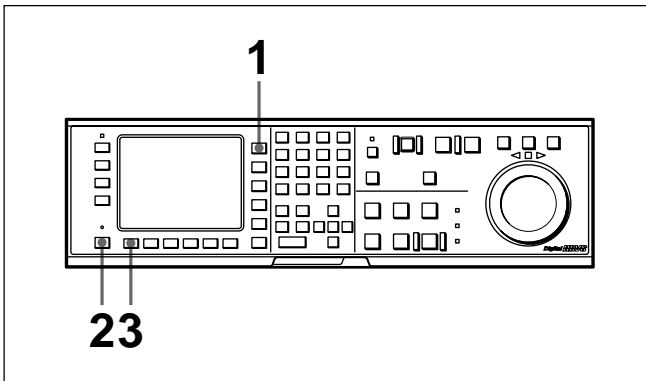

Changing menu settings

- 1 Press the HOME button. The first page of the HOME menu appears in the display.

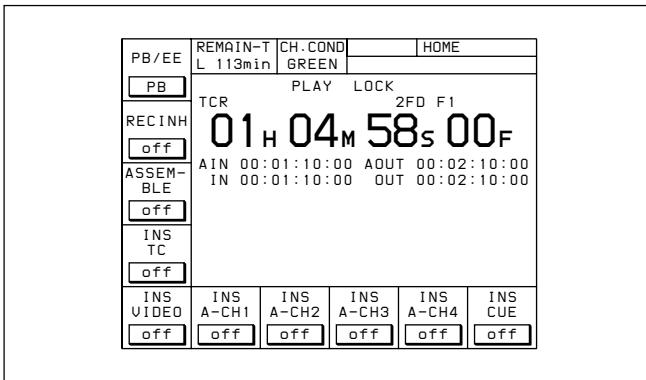

- 2 Press the ALT button. The second page of the HOME menu appears in the display.

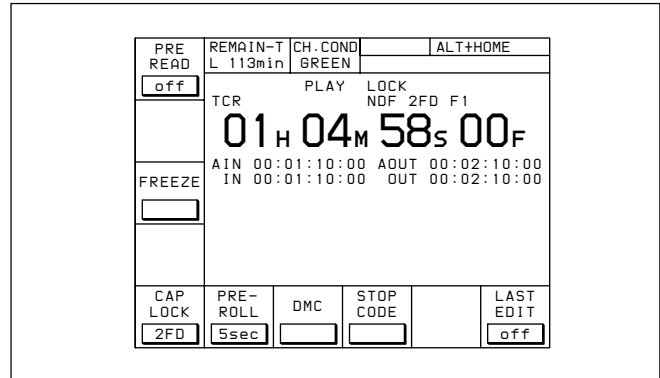



To return to the first page

Press the ALT button again.

- 3 Press the F5 (CAP LOCK) button to change the capstan servo lock mode setting. Each time the button is pressed, the setting changes.

Changing menu settings using the cursor control buttons

You may also use the cursor control buttons to select menu items and change menu settings by moving the on-screen cursor. For settings which cannot be made by the function buttons alone, the following icons appear in the bottom-right of the menu to indicate the use of the cursor control buttons:

-  : All cursor control buttons
-  : Cursor control buttons for horizontal direction
-  : Cursor control buttons for vertical direction

In addition to operations using the cursor control buttons, some menus allow you to change a value by using the / buttons.

4-1-3 Registering Items to the PF1/2 Menus

You can register up to 40 items to the PF (Personal Function) 1/2 menus, including items that are displayed when the ALT button is pressed. The registration of items from different menus to the PF1/2 menu eliminates the need for changing menus in order to change a given VTR operating condition.

For details on the factory-set PF1/2 menus, see Section 4-5, "PF1 Menu (Factory Settings)" on page 4-53 and 4-6, "PF2 Menu (Factory Settings)" on page 4-57.

Registering items to the PF1/2 menus

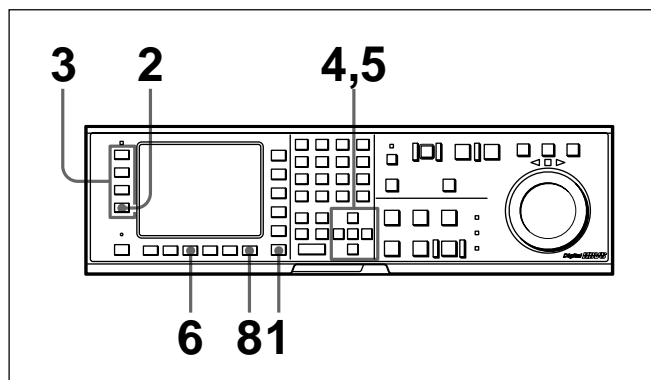

Registering items to the PF1/2 menus

- 1 Press the SET UP button.
The SET UP menu appears in the display.
- 2 Press the [F4] (PF1&2 ASSIGN) button.
The PF1&2 ASSIGN menu appears in the display.
- 3 Press the [F1], [F2], [F3] or [F4] button to select the PF menu where you wish to register an item.
The selected PF menu appears and the items currently registered to the menu appear at the left of the display.
- 4 Press the [▲] or [▼] button to move the cursor (▶) to the function button where the item is to be registered.
The selected function button is highlighted and the current setting is displayed.

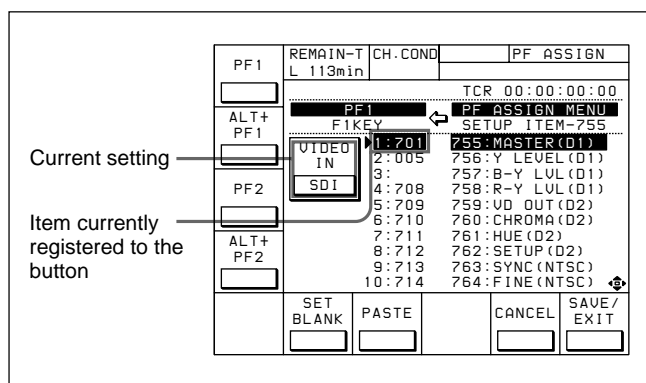

To unregister the selected item

Press the [F6] (SET BLANK) button.

- 5 Press the [▶] button to move the cursor (▶) to the PF1&2 ASSIGN menu, then press the [▲] or [▼] button to move the cursor to the menu item to be registered to the function button.

To scroll the menu faster

Press the [▲] or [▼] button while holding down the SFT button.

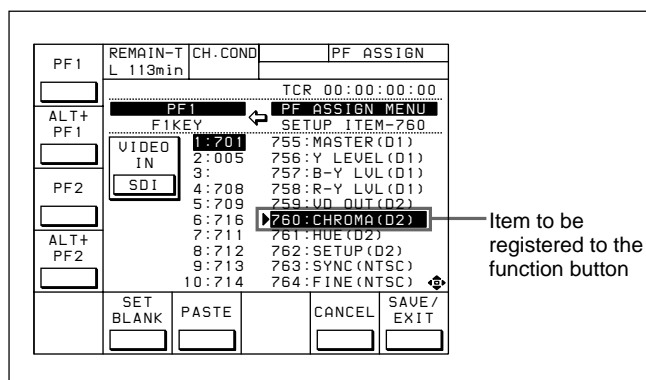

- 6 Press the [F7] (PASTE) button to register the item.
The new item is registered to the function button.
- 7 Repeat Steps 3 to 6 to register more items.

To cancel the registration of all new items

Press the [F9] (CANCEL) button.

- 8 Press the [F10] (SAVE/EXIT) button to save the newly registered items.
The registration is completed and the SET UP menu appears in the display again.

4-1 Registering and Storing Menu Settings

4-1-4 VTR Memory Bank Function

Eight VTR memory banks are provided for storing up to eight sets of menu settings including items registered to the PF1/2 menus with titles. The contents of all eight VTR memory banks can be stored on a memory card.

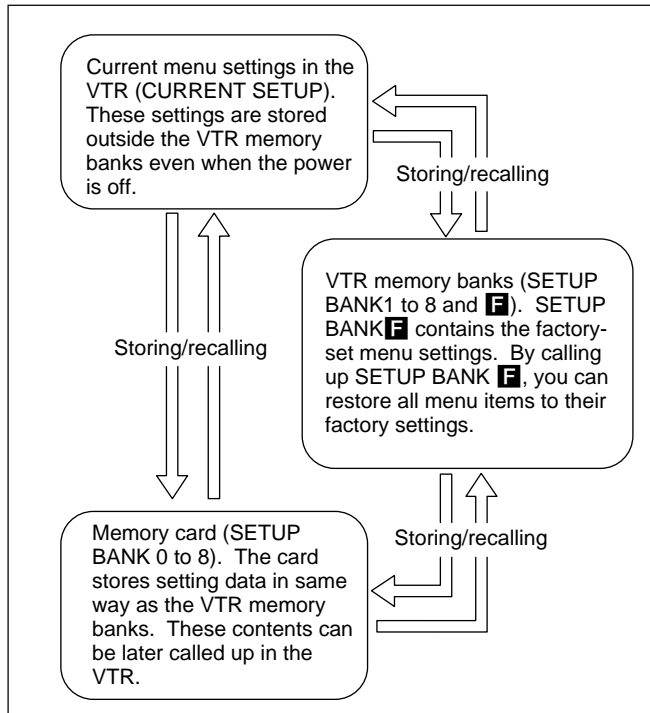

VTR memory bank function

For details on memory card use, refer to “4-1-5 Memory Card Function” on page 4-6.

For details on adding titles to the contents of the VTR memory bank, refer to “4-1-6 Adding Titles to the Data” on page 4-11.

Note

The contents of SETUP BANK **F** cannot be changed.

Storing the current VTR menu settings to a VTR memory bank

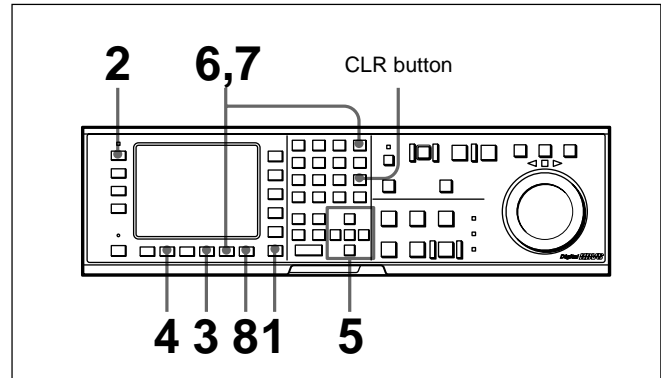

Storing the current VTR menu settings to a VTR memory bank

- 1 Press the SET UP button.
The SET UP menu appears in the display.
- 2 Press the [F1] (VTR BANK) button.
The VTR BANK menu appears in the display.

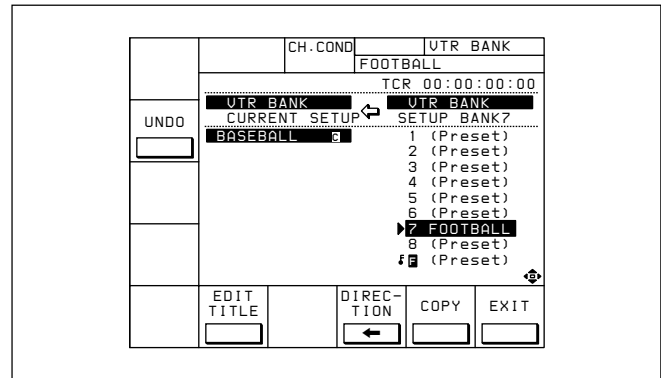

- 3 Press the [F8] (DIRECTION) button or press the or buttons twice to select the direction.
- 4 Press the button to move the cursor (▶) to CURRENT SETUP[C], then press the [F6] (EDIT TITLE) button to add a title to the current menu settings of the VTR.

For details, refer to “4-1-6 Adding Titles to the Data” on page 4-11.

- 5 Press the button to move the cursor (▶) to SETUP BANK, then press the or button to move the cursor to the number of the VTR memory bank to be used for saving the current menu settings.

- 6** Press the **[F9]** (COPY) button.
A message appears in the display asking you to confirm the operation.

To cancel the storage operation

Press the CLR button.

- 7** Press the **[F9]** (COPY) button while holding down the SFT button.
The current menu settings are stored to the VTR memory bank.

To add or change a title for VTR settings after storing them to the VTR memory bank

Move the cursor (▶) to the number of the VTR where the settings are stored, then press the **[F6]** (EDIT TITLE) button.

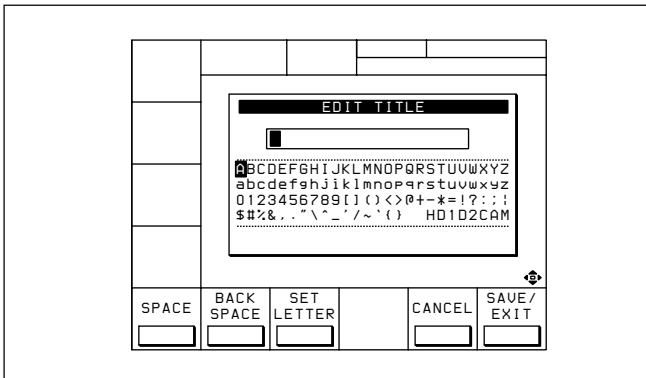

For more information, refer to “4-1-6 Adding Titles to the Data” on page 4-11.

Recovering previous settings after new settings have been saved

Press the **[F2]** (UNDO) button to recover the previous settings.

Preventing accidental erasure after saving settings

Move the cursor to the memory bank to be protected and press ALT/**[F2]** (PROTECT) buttons. A ⚡ will appear next to the selected bank.

- 8** Press the **[F10]** (EXIT) button.
The SET UP menu appears again.

Recalling menu settings from a VTR memory bank

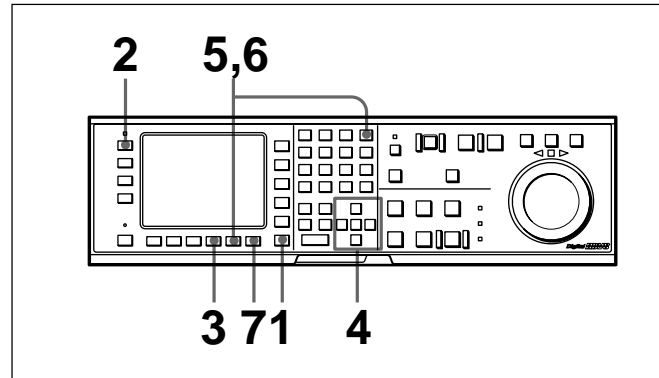

Recalling menu settings from a VTR memory bank

- 1 Press the SET UP button.
The SET UP menu appears in the display.
- 2 Press the **[F1]** (VTR BANK) button.
The VTR BANK menu appears in the display.

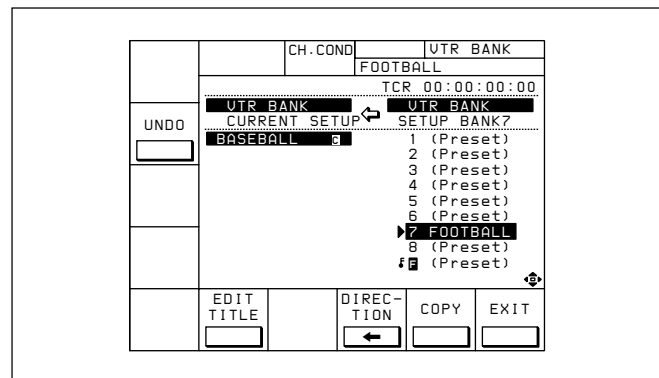

- 3 Press the **[F8]** (DIRECTION) button or press the **[◀]** or **[▶]** buttons twice to select the **[◀]** direction.
- 4 Press the **[▲]** or **[▼]** button to move the cursor (▶) to the number of the VTR memory bank to be recalled.
- 5 Press the **[F9]** (COPY) button.
A message asking you to confirm the operation appears in the display.

To cancel the recalling operation

Press the CLR button.

(Continued)

4-1 Registering and Storing Menu Settings

- 6** Press the **[F9]** (COPY) button while holding down the SFT button.

The menu settings are recalled from the selected VTR memory bank.

When the recalling process has been completed, the title of the VTR bank appears under CURRENT SETUP in the display.

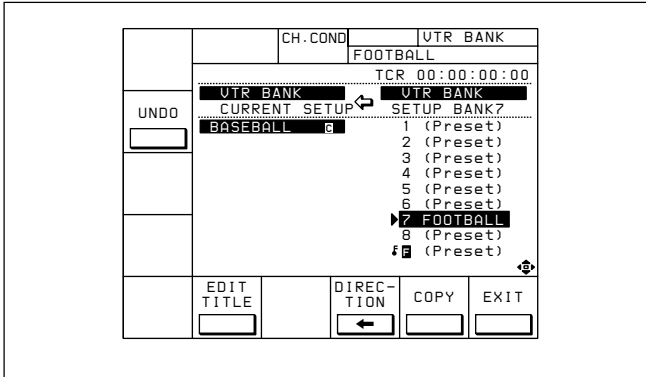

- 7** Press the **[F10]** (EXIT) button.
The SET UP menu appears again.

4-1-5 Memory Card Function

You can store menu settings in the VTR memory banks and cue point data to an memory card for recall later.

The MEMORY CARD indicator lights up when you insert a memory card.

You can then access the MEMORY CARD menu directly from other menus (HOME/TC/CUE/PF1/PF2) by pressing the ACCESS button.

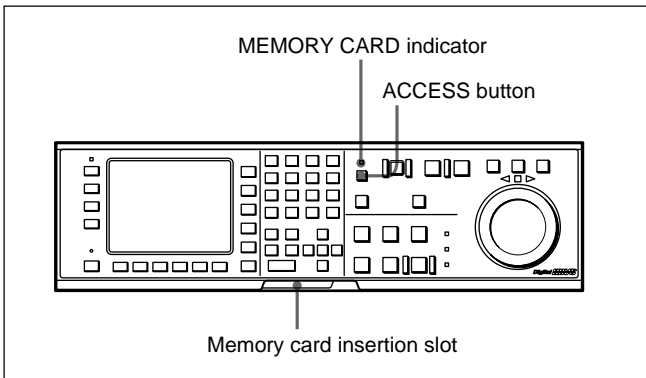

To eject the memory card

Press the button on the right side of the insertion slot.

Notes

- Be sure to insert the memory card fully. If the memory card is not inserted properly, the MEMORY CARD indicator will flash. If this happens, reinsert the memory card.
- If the battery in the memory card is dead, the MEMORY CARD indicator will flash. If this happens, replace the battery in the memory card.
- The ACCESS button flashes while the VTR is writing to or reading from a memory card. Do not eject the memory card while the indicator is flashing.

Formatting a memory card

The supplied memory card or other memory cards must be formatted before you can use them.

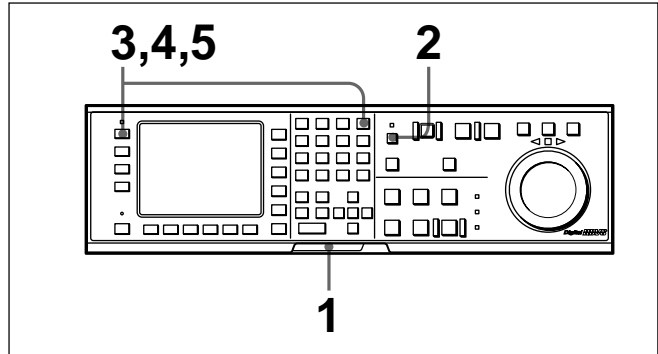

Formatting a memory card

- 1** Insert the memory card.
The MEMORY CARD indicator lights up.
- 2** Press the ACCESS button.
MEMORY CARD menu appears in the display.

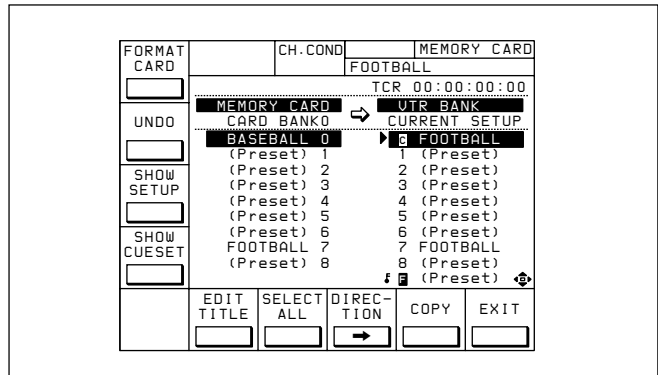

- 3** Press the **[F1]** (FORMAT CARD) button.
A message asking you to confirm the operation appears in the display.

- 4** Press the **[F1]** (FORMAT CARD) button while holding down the SFT button.

A message asking you to confirm the operation appears in the display again.

- 5** Press the **[F1]** (FORMAT CARD) button while holding down the SFT button.

The VTR starts formatting the card.

To cancel formatting

Press the CLR button while the confirmation message appears in the display.

Storing the contents of the VTR memory banks to a memory card

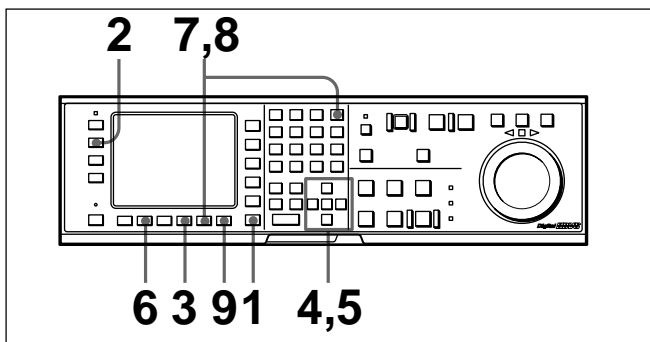

Storing the contents of the VTR memory banks to a memory card

- 1** Press the SET UP button.
The SET UP menu appears in the display.
- 2** Press the **[F2]** (MEMORY CARD) button.
The MEMORY CARD menu appears in the display.
You can access the MEMORY CARD menu directly by pressing the ACCESS button.

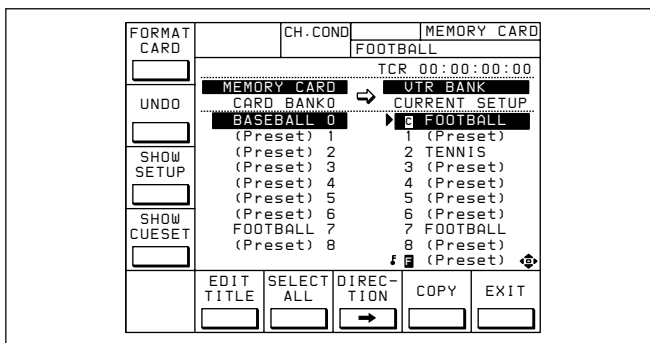

- 3** Press the **[F8]** (DIRECTION) button or press the **<** or **>** buttons twice to select the **←** direction.

- 4** Move the cursor to the VTR side using the **>** button and use the **↑** and **↓** buttons to move the cursor to the memory bank where the data is to be saved.

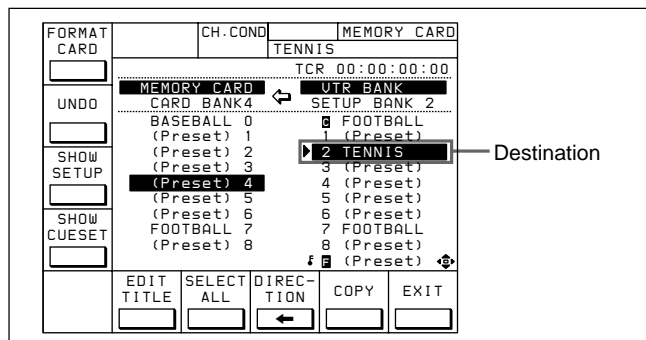

To store the current VTR menu settings

Move the cursor (▶) to the **[C]** (CURRENT SETUP) position.

To store all VTR memory banks

Press the **[F7]** (SELECT ALL) button.

- 5** Move the cursor to the MEMORY CARD side using the **>** button, and use the **↑** and **↓** buttons to move the cursor (▶) to the bank number (MEMORY CARD side) where the data is to be saved.

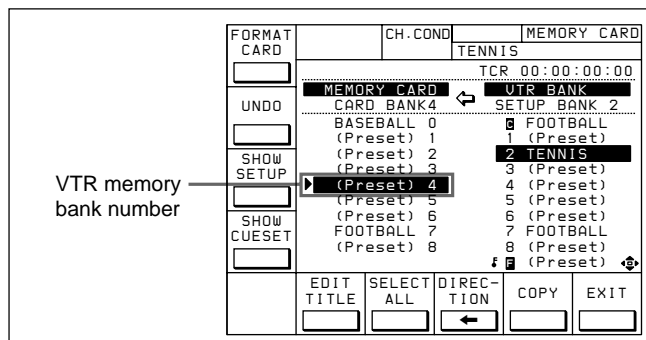

- 6** To change the title of the bank, press the **[F6]** (EDIT TITLE) button.

For details, refer to “4-1-6 Adding Titles to the Data” on page 4-11.

- 7** Press the **[F9]** (COPY) button.
A message asking you to confirm the operation appears in the display.

(Continued)

4-1 Registering and Storing Menu Settings

- 8** Press the **[F9]** (COPY) button while holding down the SFT button.
The control panel stores the specified VTR memory bank to the IC memory card.
After the storage is complete, the title of the VTR memory bank appears under the MEMORY CARD indication.

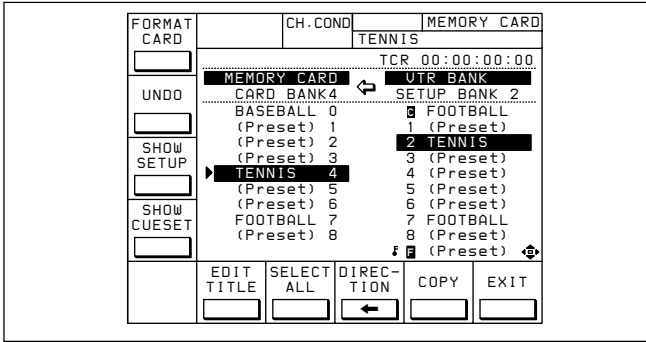

Preventing accidental erasure after saving settings

Press ALT/**[F2]** (PROTECT) buttons and a **f** symbol will appear to the right of the memory card bank number

- 9** Press the **[F10]** (EXIT) button.
The SET UP menu or the menu displayed before you pressed the ACCESS button appears again.

Storing cue point lists to a memory card

You can store up to 8 pages of cue point lists to a memory card along with titles.

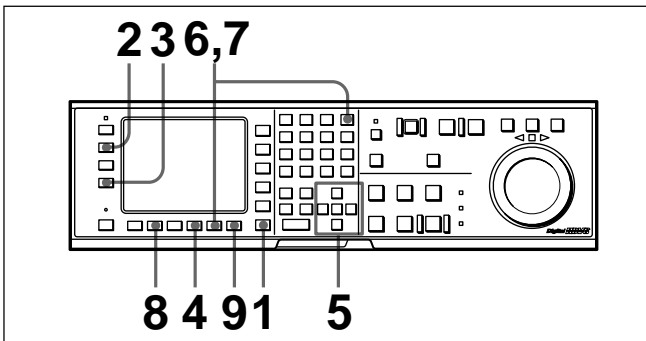

Storing cue point lists to an IC memory card

- 1** Press the SET UP button.
The SET UP menu appears in the display.

- 2** Press the **[F2]** (MEMORY CARD) button.
The MEMORY CARD menu appears in the display.
You can access MEMORY CARD menu directly from any menu screen by pressing the ACCESS button.

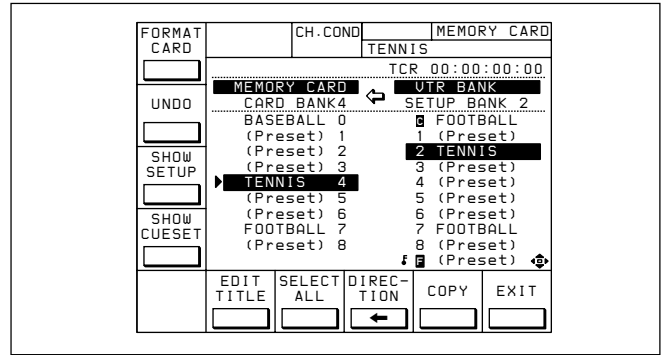

- 3** Press the **[F4]** (SHOW CUESET) button.
The display for storing cue point lists appears.

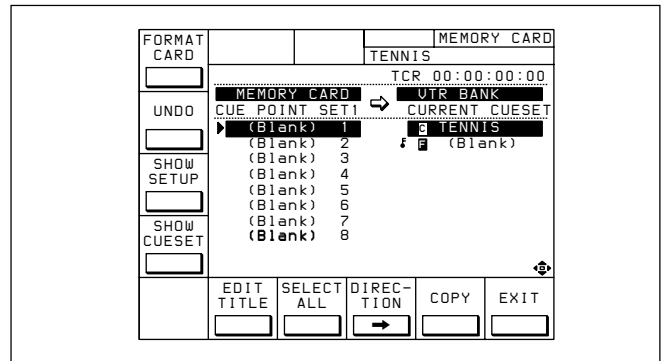

To return to the MEMORY CARD menu

Press the **[F3]** (SHOW SETUP) button.

- 4** Press the **[F8]** button or press the **[<]** or **[>]** buttons twice to select the **[←]** direction.
- 5** Press the **[Δ]** or **[∇]** button to move the cursor (**[▶]**) to the number of the memory bank in the memory card where you want to store the cue point list.

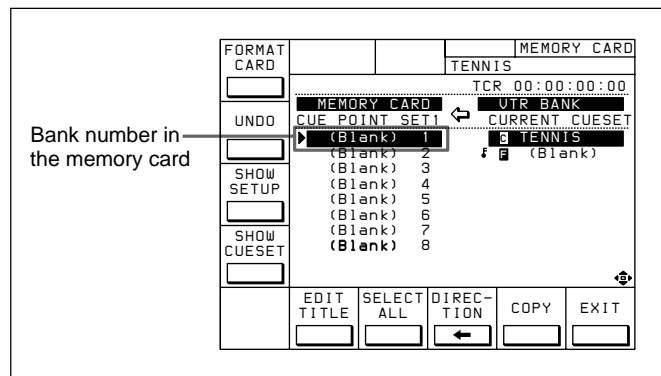

- 6 Press the **[F9]** (COPY) button.
A message asking you to confirm the operation appears in the display.
- 7 Press the **[F9]** (COPY) button while holding down the SFT button.
The VTR stores the cue point list to the memory card.
- 8 Press the **[F6]** (EDIT TITLE) button to add a title to the cue point list.

For details, refer to “4-1-6 Adding Titles to the Data” on page 4-11.

Preventing accidental erasure after saving settings

Move the cursor (▶) to the cue point set number you wish to save and press ALT/**[F2]** (PROTECT) buttons. A **f** symbol will appear to the right of the cue point set number.

- 9 Press the **[F10]** (EXIT) button.
The SET UP menu or the menu displayed before you pressed the ACCESS button appears again.

Recalling the contents of a memory card

The contents stored in a memory card can be recalled to the current VTR memory bank.

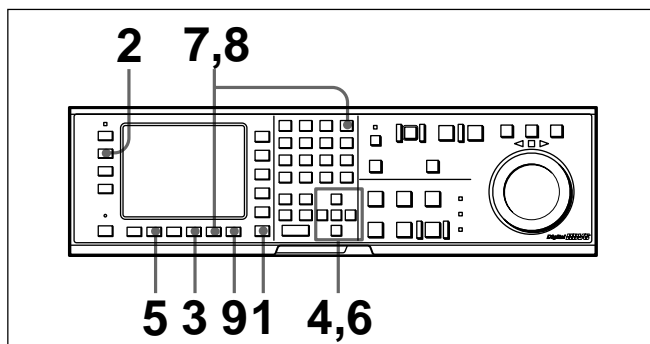

Recalling the contents of an IC memory card

- 1 Press the SET UP button.
The SET UP menu appears in the display.
- 2 Press the **[F2]** (MEMORY CARD) button.
The MEMORY CARD menu appears in the display.
You can access MEMORY CARD menu directly from any menu screen by pressing the ACCESS button.

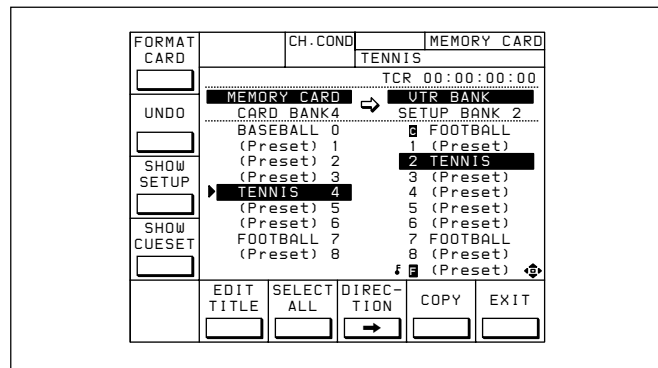

- 3 Press the **[F8]** (DIRECTION) button or press the **<** or **>** buttons twice to select the **➔** direction.
- 4 Move the cursor to the memory card side using the **<** button and use the **▢** or **▣** buttons to place the cursor (▶) by the memory bank where the settings were saved.

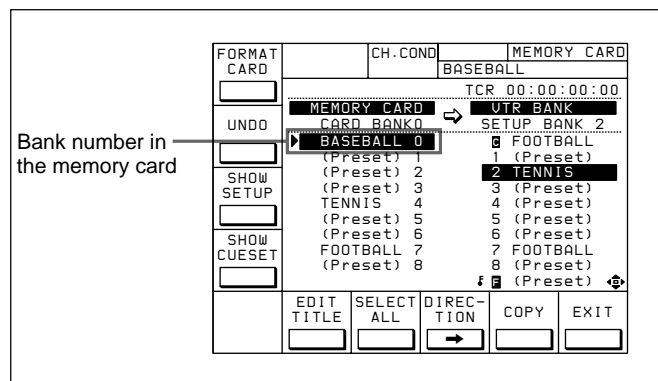

- 5 To change the title of the memory bank, press the **[F6]** (EDIT TITLE) button.
The title can be also be changed after the settings are recalled.

For details, refer to “4-1-6 Adding Titles to the Data” on page 4-11.

(Continued)

4-1 Registering and Storing Menu Settings

- 6 Press the \square button to move the cursor (\blacktriangleright) to the VTR side, then press the \square or \square button to move the cursor to the VTR memory bank number where the recalled data are to be stored.

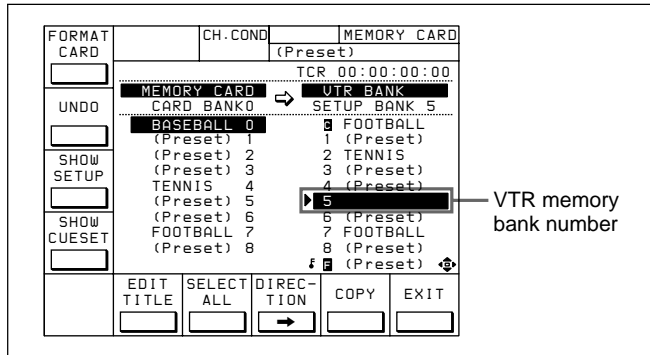

To change the current VTR menu settings

Move the cursor (\blacktriangleright) to \square (CURRENT SETUP).

To replace all VTR memory bank contents with memory card data

Press the \square (SELECT ALL) button.

- 7 Press the \square (COPY) button.
A message asking you to confirm the operation appears in the display.
- 8 Press the \square (COPY) button while holding down the SFT button.
The VTR recalls the contents of the memory card. After the recalling process is complete, the title of the memory bank of the memory card appears under the VTR indication.
- 9 Press the \square (EXIT) button.
The SET UP menu or the menu displayed before you pressed the ACCESS button appears again.

Recalling a cue point list from a memory card

Recalling a cue point list from a memory card replaces the current VTR cue point list with the recalled data.

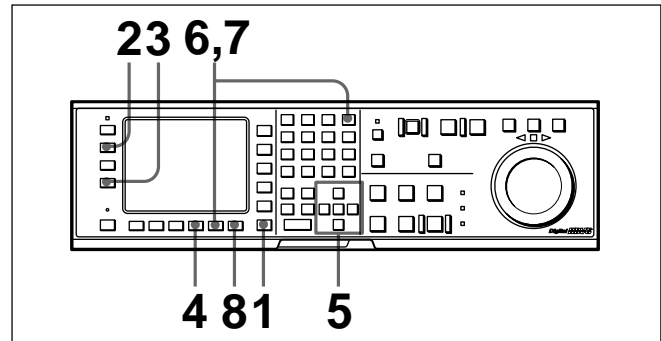

Recalling a cue point list in a memory card

- 1 Press the SET UP button.
The SET UP menu appears in the display.
- 2 Press the \square (MEMORY CARD) button.
The MEMORY CARD menu appears in the display.
You can access MEMORY CARD menu directly by pressing the ACCESS button.

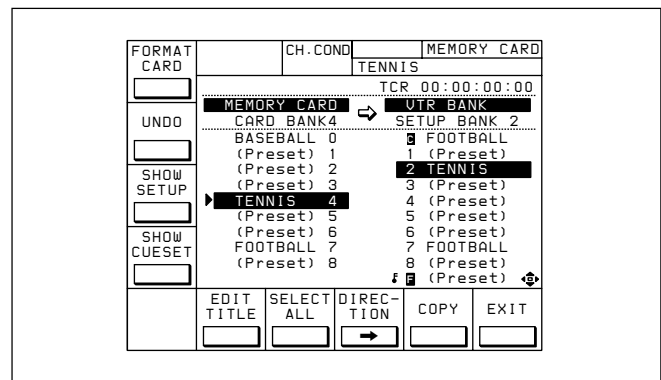

- 3 Press the \square (SHOW CUESET) button.
The menu for storing cue point lists appears.

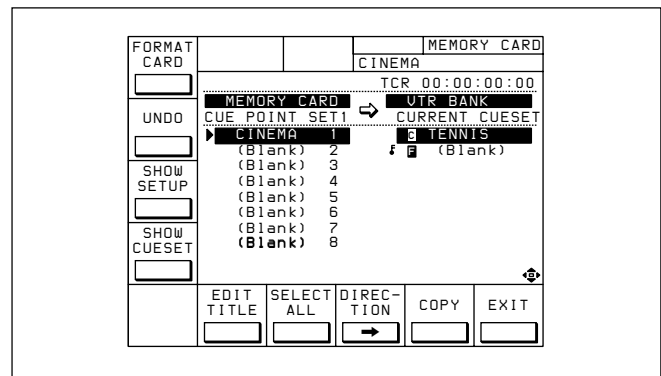

To return to the MEMORY CARD menu

Press the **[F3]** (SHOW SETUP) button again.

- 4 Press the **[F8]** (DIRECTION) button or press the **[<]** or **[>]** buttons twice to select the **→** direction.
- 5 Press the **[▲]** or **[▼]** button to move the cursor (**▶**) to the number of the memory bank in the memory card.

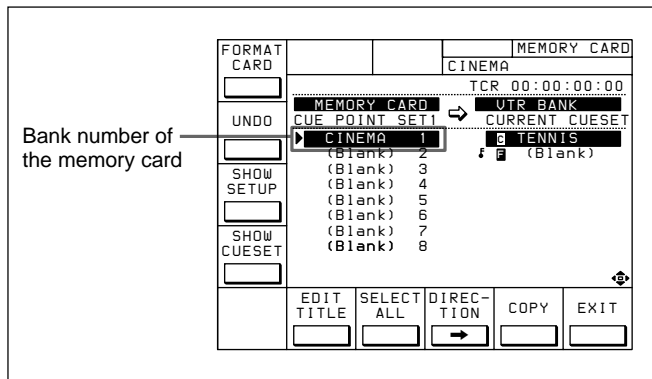

- 6 Press the **[F9]** (COPY) button.
A message asking you to confirm the operation appears in the display.
- 7 Press the **[F9]** (COPY) button while holding down the SFT button.
The VTR recalls the cue point list in the memory card.
After the recalling process is completed, the name of the cue point list appears under the CURRENT CUESET indication.
- 8 Press the **[F10]** (EXIT) button.
The SET UP menu or the menu displayed before you pressed the ACCESS button appears again.

4-1-6 Adding Titles to the Data

When storing data to a memory bank in a memory card or the VTR, you can add a title to the data to make data management easier.

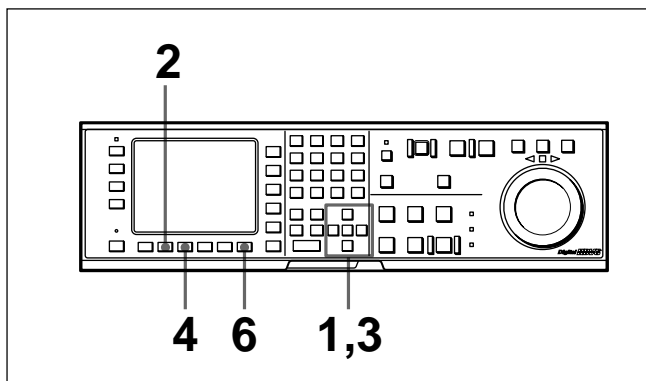

Adding titles to the data

- 1 Move the cursor (**▶**) to item to be filled.
- 2 Press the **[F6]** (EDIT TITLE) button to display the EDIT TITLE window.

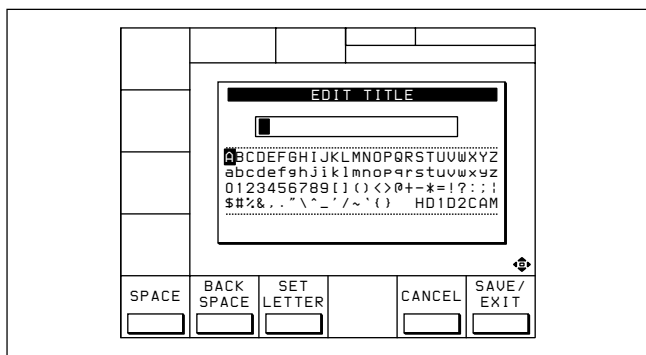

- 3 Press the **[<]** or **[>]** button to select a letter.

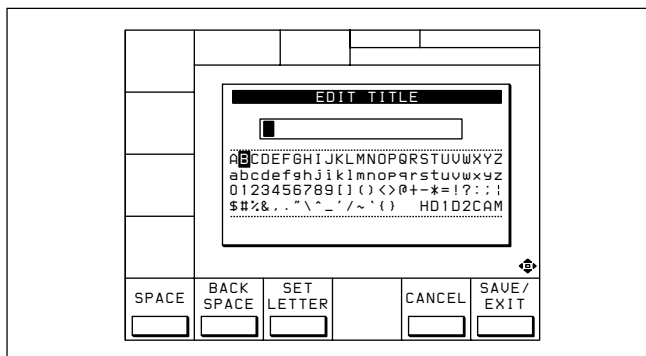

(Continued)

4-1 Registering and Storing Menu Settings

- 4** Press the **[F7]** (SET LETTER) button .
The selected letter is entered.

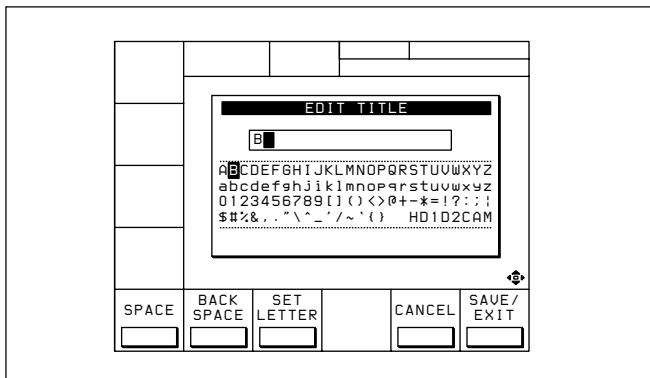

- 5** Repeat Steps **3** and **4** to enter more characters.

To enter a space

Press the **[F5]** (SPACE) button.

If you enter a wrong character

Press the **[F6]** (BACK SPACE) to go back, then reenter a character.

To cancel the procedure to start again

Press **[F9]** (CANCEL) button to start over.

To change a character

Press the **[<]** button to move the cursor to the title box, then press the **[↑]** or **[↓]** buttons to move the text insertion position.)

- 6** Press the **[F10]** (SAVE/EXIT) button.
The entered title is set and the menu displayed before you pressed the EDIT TITLE button appears again.

4-1-7 Details on VTR Memory Bank and Memory Card Functions

Most setting of most items can be stored to a VTR memory bank or a memory card, with the exception of the settings described below:

Data that can be stored to/recalled from a VTR memory bank or a memory card

- Settings of items in the VTR SETUP menu (with the exceptions listed below)
- Contents of the PF1/2 menus
- VTR memory bank titles

Data that cannot be stored to/recalled from a VTR memory bank or a memory card

- Items related to the hours meter (H01 to H14)
- Current settings are always maintained for these items.

4-1-8 Memory Card Data Compatibility

Data copied onto a memory card can be used on control panels connected to other HDW-F500 VTRs. Although data is completely compatible between VTRs with different optional equipment, take note of the following.

Consider data copied from VTR A to VTR B and then to VTR C

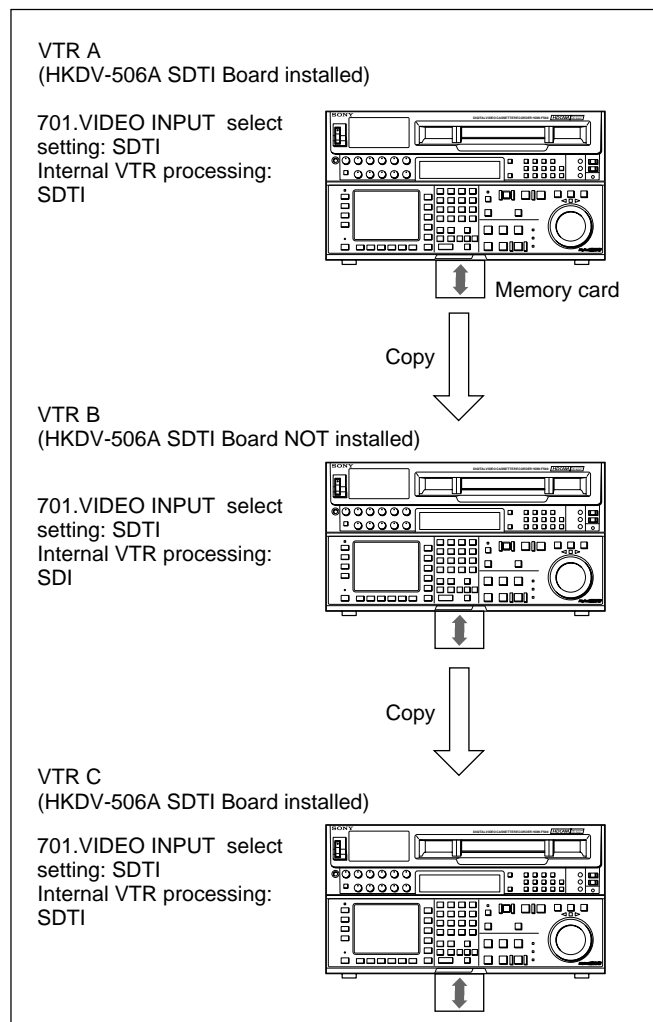

- Even though the optional equipment is different in VTRs A and B, the VTR SETUP menu settings are preserved.
- Even though the VTR SETUP menu settings are copied to VTR C after being copied to VTR B, the settings from VTR A are copied to VTR C
- Even though settings are copied for optional equipment that is not present, the settings are adjusted and processed by the VTR internally.

4-2 HOME Menu

The HOME menu sets the basic VTR operation conditions for recording, playback, and editing. The HOME, TC, PF1 and PF2 menus show information that includes the VTR operation mode, time code of the current position, and time code type, etc.

To activate the HOME menu
Press the HOME button.

To change the HOME menu page
Press the ALT button.

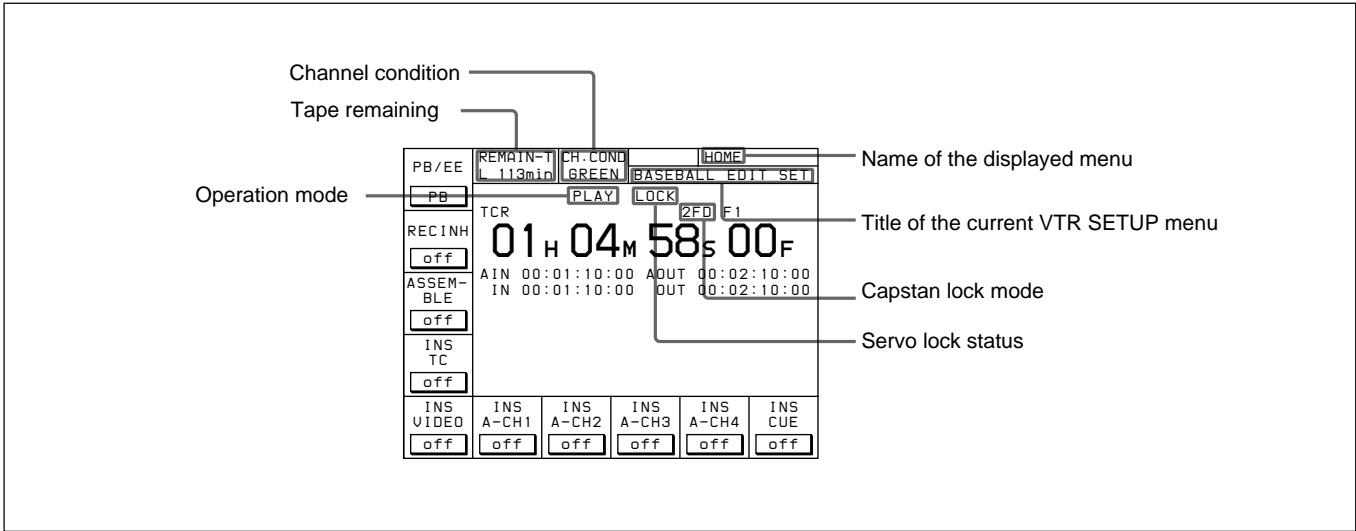

HOME menu display

For details on time codes, refer to “4-3 TC Menu” on page 4-20.

HOME menu

Button	Indication	Function	Settings
[F1]	PB/EE	Selection of output signals	PB, EE
[F2]	REC INH	Disables recording	off, < all, crash REC, video/CTL, audio/CTL >, [casst] Note The [casst] indicator is only displayed when the record-protect plug is set to prevent recording. This setting cannot be selected.
[F3]	ASSEMBLE	Selects edit mode and edit channel	on, off
[F4]	INS TC		
[F5]	INS VIDEO		
[F6]	INS A-CH1		
[F7]	INS A-CH2		
[F8]	INS A-CH3		
[F9]	INS A-CH4		
[F10]	INS CUE		
ALT/[F1]	PRE READ	Setting for pre-reading	off, video, audio, a/v
ALT/[F3]	FREEZE	Selects still-picture output.	
ALT/[F5]	CAP LOCK	Selects CAP LOCK (capstan servo lock) mode.	2FD, 4LOCK, 4HOLD
ALT/[F6]	PREROLL	Sets the preroll time.	0 to 30 s
ALT/[F7]	DMC	Selects DMC playback.	
ALT/[F10]	LAST EDIT	Restores the last edit point set.	

4-2 HOME Menu

4-2-1 Selecting the Output Signals(PB/EE)

The audio/video output signals from the line output and monitor output connectors can be temporarily changed from their current settings to another set of settings by pressing the **[F1]** (PB/EE) button. The video, digital audio, and analog cue channel output signals are toggled to the other set of settings while the button is pressed.

Output Signal Selection

Output signal selection is made using the 017.PB/EE SELECT MENU. Output signal types for different operation modes of this VTR are shown below.

VTR Operation Mode	Video/Audio		
Standby off	EE/EE	PB/MU	
Standby on	PB/MU	EE/EE	EE/MU
Playback	PB/PB ¹⁾		
Record	EE/EE	PB/PB	
Edit	EE/EE	PB/PB	
Shuttle ³⁾	PB/MU	EE/EE	PB/PB
Jog	PB/PB	PB/MU	
Variable	PB/PB	PB/MU	
INPUT CHECK button	INPUT ²⁾		

- 1) Output signals during playback are PB/PB only. Output signals cannot be selected with 017.PB/EE SELECT MENU.
- 2) When the INPUT CHECK button is held down, the INPUT signals (audio and video) are output. Output signals cannot be selected with 017.PB/EE SELECT MENU. When the INPUT signals are output, only monitor output is changed. Line output signals are not changed.
- 3) Pressing the **[F1]** (PB/EE) button changes the output signals during shuttle mode in the following ways.

VTR SETUP MENU 017. PB/EE SELECT MENU settings	Output signals while the [F1] (PB/EE) button is held down
PB/MU	EE/EE
PB/PB	EE/EE
EE/EE	PB/MU

Note

When PB/PB is selected during shuttle mode, audio output is muted for playback speeds of more than -1 or +2 times normal speed.

4-2-2 Record Inhibit Mode (REC INH)

Record inhibit mode is selected by pressing the **[F2]** (REC INH) button. Every time the button is pressed, the setting toggles between off and <all, crash REC, video/CTL, audio/CTL>.

The record inhibit area is selected using the 003.REC INHIBIT AREA select setting in the VTR SETUP menu.

all: All recording is prohibited. (The REC INHIBIT indicator will be lit.)

crash REC: The normal record mode is disabled.

Use this setting when you want to record only during assemble editing or insert editing.

video/CTL: Video and CTL signal recording is inhibited.

Audio/CTL: Audio and CTL signal recording is inhibited.

[casst]: This is displayed when recording is inhibited because the record-protect plug is set. This setting cannot be selected.

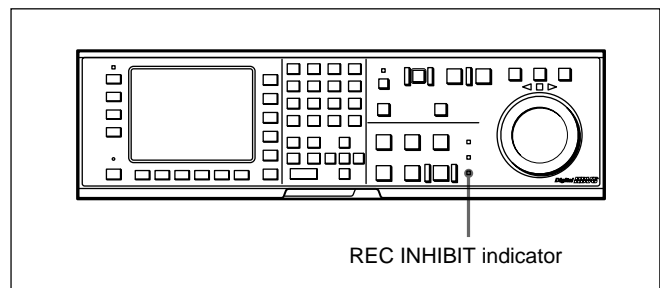

4-2-3 Selecting the Edit Mode and Edit Channel (ASSEMBLE or INS CUE)

Select assemble or insert edit mode.

Selecting assemble edit mode

Press **[F3]** (ASSEMBLE) in the HOME menu.

Selecting the insert edit mode

Press one of the following buttons in the HOME menu:

[F4] (INS TC), **[F5]** (INS VIDEO), **[F6]** (INS A-CH1), **[F7]** (INS A-CH2), **[F8]** (INS A-CH3), **[F9]** (INS A-CH4), **[F10]** (INS CUE).

For more information about editing operations, refer to “Chapter 6 Editing” on page 6-1.

4-2-4 Preread Settings (PRE READ)

This setting allows pre-reading (reading before writing) in insert edit mode. To select pre-reading, press the ALT/**[F1]** (PRE READ) button. Pressing the button, cycles the settings from off, video, audio, a/v.

off: No pre-reading

video: Pre-read the video signals (PREREAD indicator will be lit)

audio: Pre-read the audio signals (PREREAD indicator will be lit)

a/v: Pre-read both audio and video signals (PREREAD indicator will be lit)

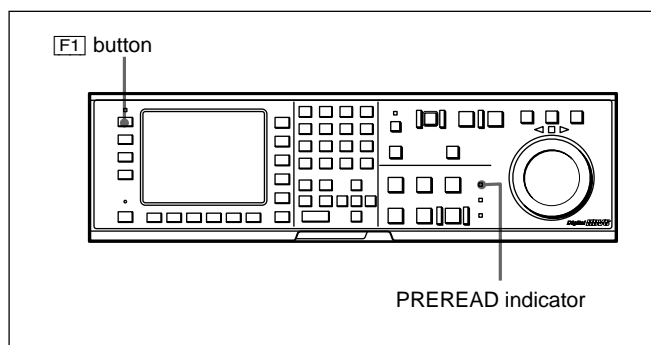

The pre-read function can be used for pre-read editing.

4-2-5 Still-Picture Output (FREEZE)

For stillpicture output, press the ALT/**[F3]** (FREEZE) button. The picture that was playing just before the button was pressed will be frozen on the screen. Make the field or frame selection using the 902.FREEZE MODE setting in the VTR SETUP menu.

To maintain the still-picture

Set 903. FREEZE CONTROL FROM KEY PANEL in the VTR SETUP menu to latch.

The still-picture output is maintained until the **[F3]** (FREEZE) button is pressed again.

To temporarily output a still-picture

Set 903. FREEZE CONTROL FROM KEY PANEL in the VTR SETUP menu to momentary. A still-picture is output as long as you hold down the **[F3]** (FREEZE) button.

Stop-freeze function

To automatically output a still-picture when the VTR is changed to stop mode, set 905. STOP FREEZE CONTROL in the VTR SETUP menu to enable.

Note

Regardless of the setting of 902.FREEZE MODE in the VTR SETUP menu, stop-freeze is always a field-freeze picture.

4-2 HOME Menu

4-2-6 Selecting the Capstan Servo Lock Mode (CAP LOCK)

Press the ALT button, then the **[F5]** (CAP LOCK) button to select the capstan servo lock mode when you edit or play a tape with composite signals.

2FD: The capstan servo is locked every 2 fields. The color framing operation is disabled. This is the normal setting for editing or playback of HD or D1 signals.

4LOCK: The capstan servo is locked to the color frame every 4 fields. If color frames occur intermittently during playback, the capstan servo is locked when the next color frame appears.

4HOLD: The capstan servo is locked to the color frame every 4 fields. If color frames occurs intermittently during playback, the capstan servo stays locked to that color frame.

Notes

- This setting is only active only when the frame frequency of the unit is 29.97 Hz or 30 Hz.
- To lock composite signal output to four fields on this VTR, select the signal input to the REF. IN SD connector as a reference signal.
- Composite signal output cannot be locked to eight fields on this VTR.

4-2-7 Setting the Preroll Time (PREROLL TIME)

Set the preroll time by pressing the ALT button, then press the **[F6]** (PREROLL TIME) button. You can set a preroll time of 0 to 30 seconds in 1-second units. During editing on this VTR, a preroll time of 5 seconds or more is recommended.

Setting the preroll time

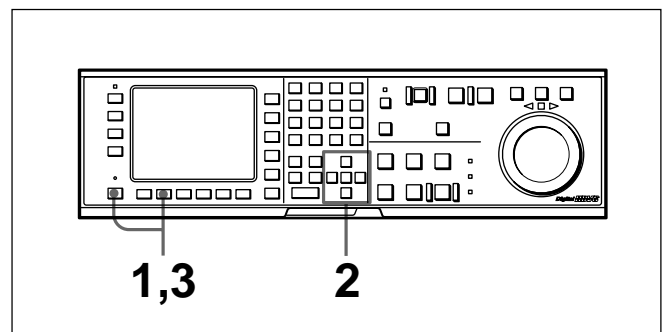

Setting the preroll time

- 1** Press the ALT button, then the **[F6]** (PREROLL TIME) button. A data entry window appears.
- 2** Change the setting with the **[Δ]** and **[▽]** buttons. You may also use the + and – buttons.
- 3** Press the **[F6]** (PREROLL TIME) button. The data entry window disappears.

4-2-8 Selecting DMC Playback (DMC)

In DMC (Dynamic Motion Control) playback mode, the VTR plays back a tape segment at a specified variable speed of -1 to +2 times normal playback speed, memorizes the speed, then plays the segment back at a later time at the memorized speed. DMC playback is useful during on-the-spot telecasts of sporting events for immediate playback and broadcast of highlight scenes for which starting and ending points have been set during recording.

For detail on the procedure for DMC playback, see Section 5-4-4, "DMC Playback" on page 5-14.

During tape editing using two HDW-F500 VTRs, you can use DMC playback to control the playback speed of the player VTR for editing at variable speeds (DMC editing).

For detail on the procedure for DMC editing, see Section 6-2-1, "Performing DMC Editing" on page 6-15.

4-2-9 Recalling Edit Points (LAST EDIT)

While editing, you can recall the last edit points by pressing the ALT button, then the **[F10]** (LAST EDIT) button.

The edit points appear in the display.

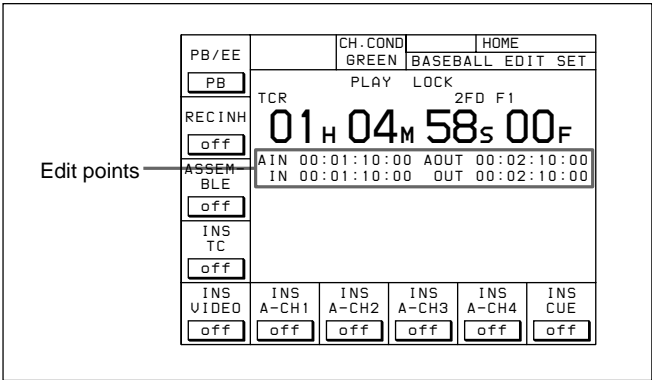

Recalling edit points (LAST EDIT)

Button	Indication	Function	Settings
ALT/[F6]	CHARA SUPER	Specifies superimposition of character information to the HD SDI output and HD-SD converter output.	on, off
ALT/[F7]	CHARA H-POS	Changes the superimposition position (horizontal).	0-15
ALT/[F8]	CHARA V-POS	Changes the superimposition position (vertical).	0-23
ALT/[F9]	VITC POS-1	Selects the VITC insertion line in the HD-SD converter output.	12-20(NTSC) 9-22(PAL)
ALT/[F10]	VITC POS-2		12-20(NTSC) 9-22(PAL)

4-3-1 Setting the Time Data (TIMER SEL/RESET/SET/HOLD)

The display shows the following types of time data:

Indication	Superimposed display	Time data type
TCR LTC	TCR	The LTC ¹⁾ value read by the time code reader during playback.
TCR VITC	TCR.	The VITC ¹⁾ value read by the time code reader during playback.
TCG	TCG	The value generated by the time code generator during recording.
CTL	CTL	The number of CTL signals ²⁾ on the tape during recording/playback.
UBR LTC	UBR	The user bits ³⁾ value read by the time code reader (LTC) during playback.
UBR VITC	UBR.	The user bits value read by the time code reader (VITC) during playback.
UBG	UBG	The user bits value generated by the time code generator during recording.
DUR	DUR	Appears whenever a duration between any two edit points (IN, OUT, AUDIO IN or AUDIO OUT points) is displayed.

Time data for IN, OUT, AUDIO IN and AUDIO OUT points are also displayed.

1) LTC and VITC

LTC cannot be read when the tape speed is very slow or is changed suddenly. VITC, on the other hand, can be read more accurately than LTC when the VTR is stopped or the tape speed is very low. VITC, however, cannot be read when the tape speed is very fast.

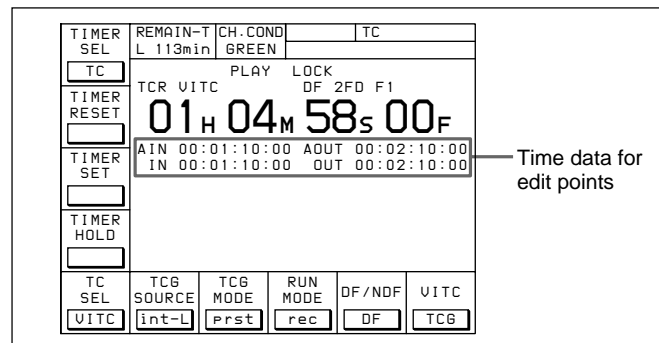

Time data for edit points

Selecting the time data display

Press the [F1] (TIMER SEL) button repeatedly to select the desired time data display.

CTL: Counts the CTL signals on the playback tape or the CTL signals being recorded on the tape, and displays the tape running time in hours, minutes, seconds, and frames.

TC: Displays the value read by the time code reader or the value generated by the time code generator. To switch between VITC and LTC, press the [F5] (TCR SEL) button.

UBIT: Displays user bits data inserted in time code being played back, or the user bits data inserted in time code being recorded. To switch between VITC and LTC, press the [F5] (TCR SEL) button.

2) CTL signals

CTL (control) signals are pulse signals that are recorded horizontally in each frame.

3) User bits

Comprising a part of the time code, user bits record supplementary information and consist of an eight-digit number or hexadecimal A to F.

4-3 TC Menu

Selecting the time code and the user bits to be recorded

Use the **[F6]** (TCG SOURCE), **[F7]** (TCG MODE), **[F9]** (DF/NDF), and **[F10]** (VITC) buttons in the TC menu to specify the time code and the user bits to be recorded. The specifications for the various button settings are shown in the following table.

[F10] (VITC)	[F7] (TCG MODE)	[F6] (TCG SOURCE)	[F9] (DF/NDF)	Time code and user bits recorded
V IN				Records the time code and the user bits input from the HD SDI INPUT or SDTI (OPTION) IN ¹⁾ connector to the video signal AUX data area. The time code value generated by the time code generator specified by the [F6] and [F7] buttons and the user bits value generated by the user bits generator are recorded longitudinally on the tape.
TCG	prst		DF/NDF/ auto ²⁾	The time code value generated by the time code generator and the user bits value generated by the user bits generator are recorded. Any time code can be specified for the time code generator and the user bits generator. The running mode for the recorded time code data conforms to that specified by the [F9] button.
	regene ³⁾	int-LTC		The time code value generated by the time code generator and the user bits value generated by the user bits generator are recorded. The time code generator and the user bits generator lock to the time data recorded longitudinally on the tape.
		int-VITC		The time code value generated by the time code generator and the user bits value generated by the user bits generator are recorded. The time code generator and the user bits generator lock to the time data recorded in the video signal AUX data area on the tape.
		ext-LTC		The time code value generated by the time code generator and the user bits value generated by the user bits generator are recorded. The time code generator and the user bits generator lock to the time data input from the TIME CODE IN connector.
		ext-VITC		The time code value generated by the time code generator and the user bits value generated by the user bits generator are recorded. The time code generator and the user bits generator lock to the time data input from the HD SDI INPUT or SDTI (OPTION) IN ¹⁾ connector.
auto			"regene/int-LTC" is set in assemble or insert mode and "prst" is set in other modes.	

- 1) The SDTI (OPTION) IN connector is operative only when the optional HKDV-506A SDTI Board is installed and 701.VIDEO INPUT select in the VTR SETUP menu is set to SDTI.
- 2) The DF/NDF setting on the **[F9]** button is applied to the time code only when prst is specified by the **[F7]** button; the DF/NDF setting is always applied for the CTL timer.
- 3) Specify the signal to be regenerated with 608.TCG/UBG REGENE MODE in the VTR SETUP menu. Signals not specified by this menu item are automatically set to Preset mode, regardless of the **[F7]** button setting.

Setting time codes

To set time codes, select prst with the **[F7]** (TCG MODE) button in the TC menu and then follow the steps below.

Note

- Set the **[F8]** (RUN MODE) button to rec before setting the time data for recording. When you select rec, time data advances from a set value only during recording. When you select free, time code advances in real time after the initial value has been set.
- During recording, VITC is always written to the AUX data area of the video signal.

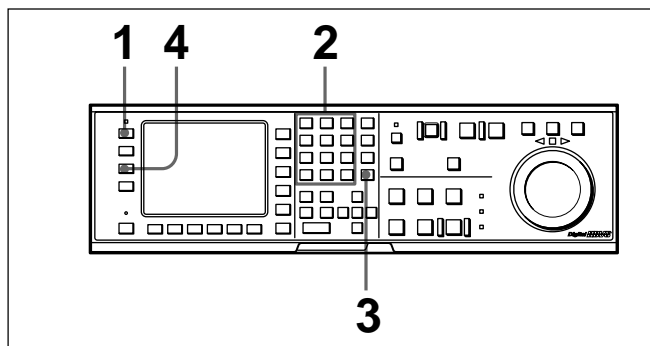

Setting time codes

- 1 Press the **[F1]** (TIMER SEL) button to select the TC (time code) to be set.
- 2 Enter the new setting in the data entry window with the numeric buttons.
For example, to enter 01H00M30S00F, press 1, 0, 0, 3, 0, 0, 0. (The leading 0 is not required. When the entered value is less than eight digits, the leading digit(s) is (are) set to 0 when you press the SET button.)

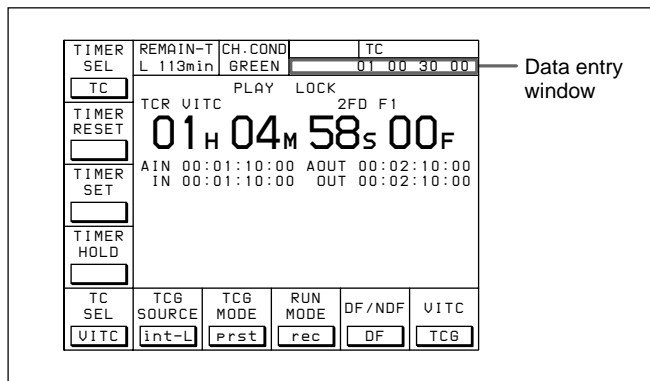

To cancel entered values

Press the CLR button.

- 3 Press the SET button to set the entered value.
If you pressed the + or – button, then entered a value, the result of calculation appears in the display.

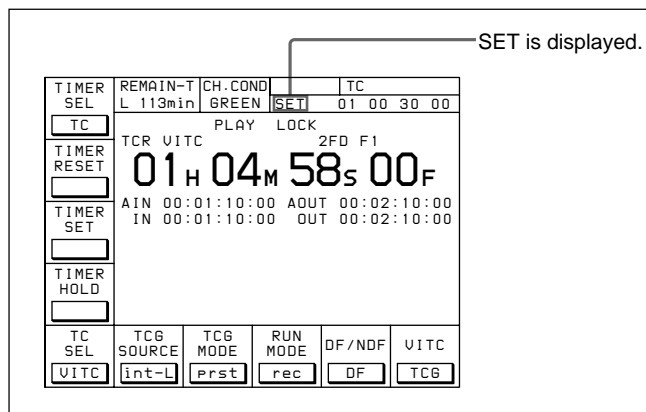

- 4 Press the **[F3]** (TIMER SET) button.
The input value is set as the time code and appears in the time data display section.

Notes

- Time codes from an external time code generator cannot be set.
- Time codes cannot be set when the internal time code generator is locked to external time codes or to time codes read by the time code reader.

4-3 TC Menu

Setting the CTL timer

- 1 Select CTL using the **[F1]** (TIMER SEL) button.
- 2 Enter data in the data entry window using the number buttons.
- 3 Press the SET button to set the data.
- 4 Press **[F3]** (TIMER SET).

Note

When $\pm 12H$ is selected in the 604.TAPE TIMER DISPLAY setting in the VTR SETUP menu and a value of 10H or more is entered, the first digit will be dropped.

Resetting time data

Press the **[F2]** (TIMER RESET) button.
The internal time code generator is reset according to the setting of the **[F1]** (TIMER SEL) button.

Resetting TC or UBIT data

The internal time code generator is reset and the time data display becomes 00H00M00S00F (TC) or 00 00 00 00 (UBIT). Edit points are not affected.

Notes

- Time data read by the time code reader cannot be reset.
- Time data cannot be reset when the internal time code generator is locked to external time codes or to time codes read by the time code reader.

Setting the user bit value

- 1 Select UBIT by pressing the **[F1]** (TIMER SEL) button.
- 2 Enter the desired user bit value in hexadecimal notation using the numeric buttons.
(Press the 0 to 5 buttons while holding down the SFT button to enter the letters A to F.)
- 3 Press the **[F3]** (TIMER SET) button.

Recording the current time

- 1 Select DF by pressing the **[F9]** (DF/NDF) button.
- 2 Select free by pressing the **[F8]** (RUN MODE) button.
- 3 Enter the target time with the numeric buttons while verifying the data in the data entry window.
- 4 When the target time arrives, press the **[F3]** (TIMER SET) button.
The time code generator starts operating from the specified time.

To pause the current time

Press the **[F4]** (TIMER HOLD) button.
The time is paused only while the button is held down.

4-3-2 Setting the Time Code Reader (TCR SEL)

Press the **[F5]** (TCR SEL) button to select the time code to be read by the time code reader during playback.

VITC: Reads VITC.

auto: Reads VITC when the playback speed is $\pm 1/2$ to 2 times normal speed or less, and LTC when it is greater than $\pm 1/2$ times normal speed.

LTC: Reads LTC.

Depending on the time code recorded on a tape, VITC or LTC appears on the display.

Note

Time codes that are read by the time code reader or played back are output from the TIME CODE OUT connector.

4-3-3 Setting the Time Code Generator (TCG SOURCE/MODE)

There are two ways to record time codes on the VTR. One way is to record the output of the VTR's internal time code generator. The other is to directly record time codes that are input from an external time code generator.

The output from the internal time code generator can either be set to a specified initial value, or synchronized with an external time code generator. The internal time code generator time code settings are made with the **[F6]** (TCG SOURCE)/**[F7]** (TCG MODE) buttons. Menu selections and settings are shown below.

TCG	Menu	[F6] (TCG SOURCE)	[F7] (TCG MODE)	Setting
Internal TCG (Preset)			prst	Time codes can be freely set using the internal time code generator
Internal TCG (Regenerate)	int-LTC		regene	Lock to the time data recorded on the time code tracks
	int-VITC		regene	Lock to the time data recorded as video AUX data on the tape
	ext-LTC		regene	Lock to the time data on the TIME CODE IN connector
	ext-VITC		regene	Lock to the time data in the video signal on the HD SDI INPUT connector
			auto	"int-LTC/regene" is set in assemble or insert mode and "prst" is set in other modes

Note

1) Drop frame mode

In order to compensate for differences between time code values from the time code generator and the actual time that occurs when the field frequency of this unit is 59.94 Hz, the drop frame mode causes the time code generator to omit the first two frames (frame 00 and 01) in each minute except the tenth.

Regenerated signals are selected using the 608.TCG/UBG REGENE MODE setting in the VTR SETUP menu.

To check the running of the internal time code generator

Press the INPUT CHECK button.

4-3-4 Selecting the Time Code Running Mode (RUN MODE)

Press the **[F8]** (RUN MODE) button to select the time code running mode.

free: The time code advances when the power is on regardless of the VTR's operation mode.

rec: The time code advances only during recording.

4-3-5 Selecting the Drop Frame Mode (DF/NDF)

Press the **[F9]** (DF/NDF) button to select the running mode for the CTL counter and the time code generator.

DF: Drop frame mode¹⁾ (DF is displayed.)

NDF: Non-drop frame mode²⁾ (NDF is displayed.)

auto: The unit switches to drop frame mode when the field frequency is 59.94 Hz, and switches to non-drop frame mode when the field frequency is 60 Hz.

Note

- This setting is only active when the frame frequency of the unit is 29.97 Hz or 30 Hz.
- When the **[F7]** (TCG MODE) button is set to regene, the drop frame mode is inoperative since the time code generator is synchronized to the playback time code.

2) Non-drop frame mode

In this mode, drop frame mode processing is not performed. Since there is no frame cutting, a discrepancy of about 86 seconds occurs each day (in the case of a field frequency of 59.94 Hz).

4-3 TC Menu

4-3-6 Inserting VITC input source (VITC)

Press the **[F10]** (VITC) button to select the VITC source to be written in the video signal AUX data area.

TCG: Inserts values generated by the internal time code generator into the VITC.

V IN: Inserts the VITC from the video input signal directly.

4-3-7 Selecting CTL Display Mode (TAPE TIMER)

Press the ALT button, then the **[F1]** (TAPE TIMER) button to select a 12-hour or 24-hour clock for the CTL display.

+/-12H: 12-hour clock

24H: 24-hour clock

4-3-8 Presetting Pull Down Time Code (PDPSET MENU) (when HKDV-507/507D is installed)

To preset the pull down time code when this VTR is operated in 23.98PsF/ 24PsF mode, follow the steps below.

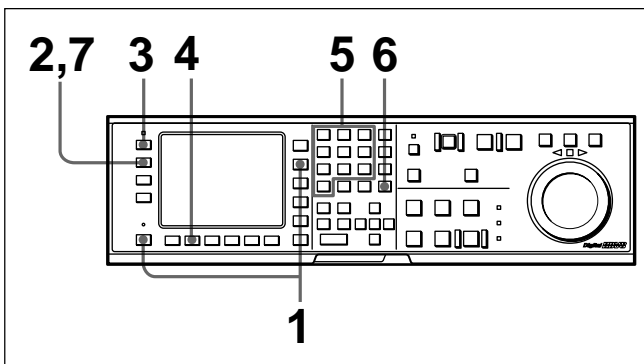

1 Press the TC button, then press the ALT button.

The ALT+TC menu appears.

2 Press the **[F2]** (PDPSET MENU) key.

The PDPSET menu appears.

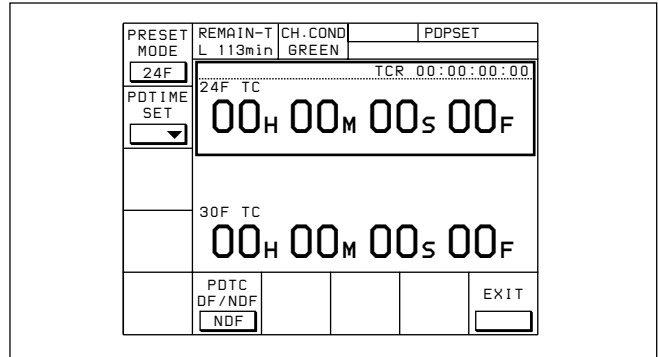

3 Press the **[F1]** (PRESET MODE) key to select 24F or 30F time code to be preset. The selected time code is framed with the thick line.

24F: Presets the 24 frames time code. The A frame of the pull down sequence is preset.

30F: Presets the 30 frames time code. The A frame of the pull down sequence is preset.

4 •When **30F** is selected in the step 3,

Press the **[F6]** (PDTC DF/NDF) key to select DF or NDF.

This selection is effective only for 30F time code.

DF: Drop frame mode

NDF: Non-drop frame mode

auto: The unit switches the running mode (DF/NDF) automatically according to the frame frequency of the unit. When the frame frequency is 23.976 Hz, the unit switches to the drop frame mode and switches to the non-drop frame mode when it is 24 Hz.

•When **24F** is selected in the step 3,

Skip this step.

5 Enter the time code data in the data entry window with numeric keys.

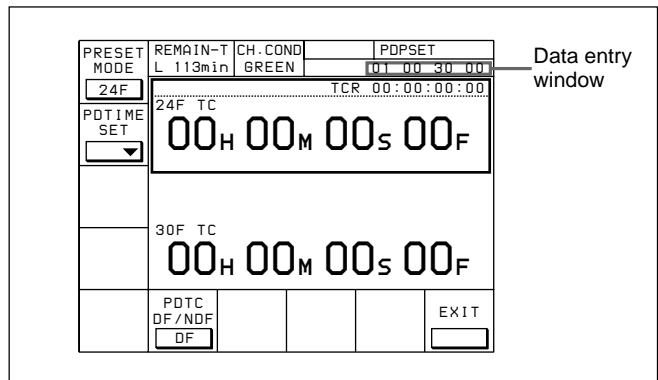

6 Press the SET button to set the input data.

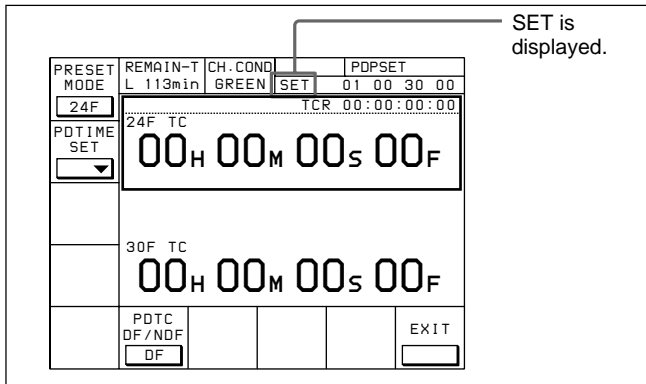

7 Press the [F2] (PDTIME SET) key.

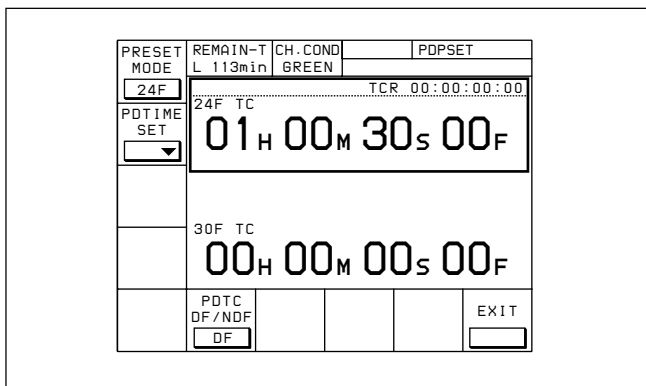

Notes

- Once the time code is preset, it cannot be reverted.
- Operation information display cannot be displayed while the pull down time code appears.
- The pull down time code cannot be displayed while the machine-to-machine editing display appears.

4-3-9 Presetting for Conversion From 24-frame Into 25-frame Time Code (TCCONV MEMU)

When the VTR is operated in 25PsF/50i mode, follow the steps below to make the settings for 25-frame converted time code.

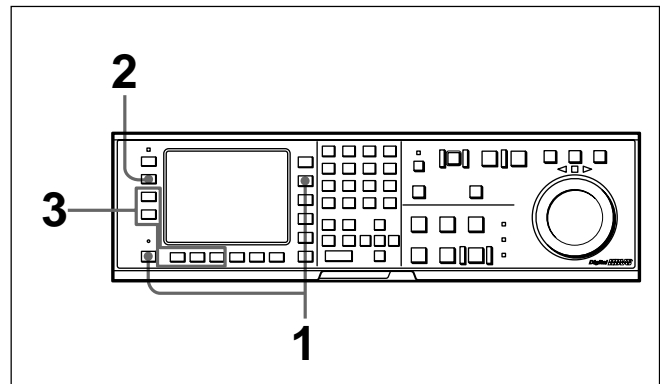

- 1 Press the TC button, and then press the ALT button.
The ALT+TC menu appears.
- 2 Press the [F3] (TCCONV MENU) button.
The TC CONVERT menu appears.

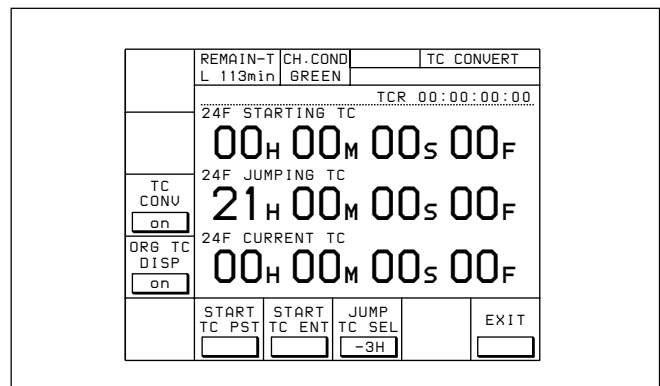

24F STARTING TC: Time code used as a reference when converting 24-frame time code into 25-frame time code.

24F JUMPING TC: The loopback point for converting 24-frame time code to 25-frame time code with 24F STARTING TC as the reference and the conversion done in both forward and reverse directions. Note that the part of the 25-frame time code before 24F JUMPING TC is not consecutive with the part after 24F JUMPING TC.

(Continued)

4-3 TC Menu

The table below shows an example of how the 25-frame time code is not consecutive when 24F STARTING TC is set to 01:00:00:00 and 24F JUMPING TC is set to 22:00:00:00 (i.e., JUMP TC SEL is set to -3H).

	24 Frames TC	25 Frames TC
JUMPING TC	22:00:00:00	20:09:36:00
	:	:
	01:00:01:01	01:00:01:00
Forward direction	01:00:01:00	01:00:00:24
↑	:	:
STARTING TC	01:00:00:00	01:00:00:00
↓	00:59:59:23	00:59:59:24
Reverse direction	:	:
	22:00:00:01	22:07:12:01
JUMPING TC	22:00:00:00	21:09:36:00

Non-consecutive part

- 3** If necessary, use the function buttons to change the settings.
For details on the settings made by these buttons, see the table below.

TC CONVERT menu

Button	Indication	Function
[F3]	TC CONV	Specifies whether the time code is converted to 25-frame time code or not.
[F4]	ORG TC DISP	Specifies whether the 24-frame time code is displayed or not on two lines in the HOME, TC, and PF menus along with the converted time code.
[F6]	START TC PST	Press to preset the 24F STARTING TC using the numeric buttons.
[F7]	START TC ENT	Press to enter the current time code as the 24F STARTING TC.
[F8]	JUMP TC SEL	Selects the 24F JUMPING TC as an interval from 24F STARTING TC. Selectable values: -3H, -2H, -1H, +1H, +2H, +3H, 0H
[F10]	EXIT	Select to exit the TC CONVERT menu.

To preset the 24F STARTING TC using the numeric buttons

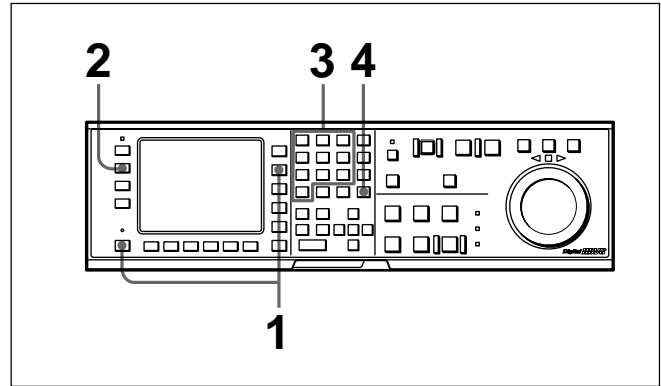

- Press the TC button, and then press the ALT button.
The ALT+TC menu appears.
- Press the [F3] (TCCONV MENU) button.
The TC CONVERT menu appears.
- Enter the time code in the data entry window with the numeric buttons.

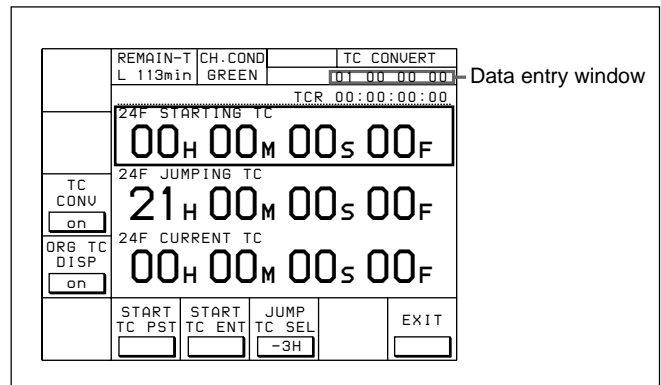

- Press the SET button to set the time code.

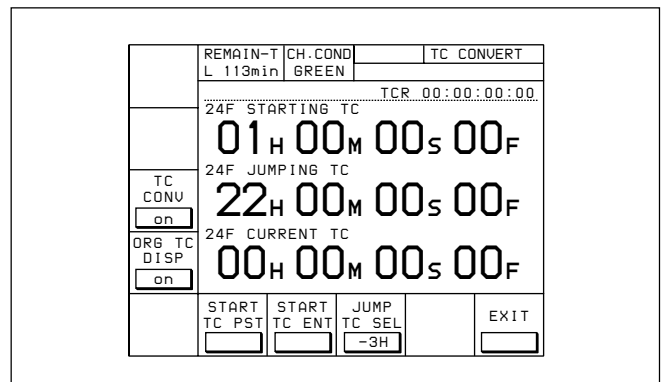

4-3-10 Conversion of Time Code During Playback in 25F Mode (TC CONV)

When the cassette tape recorded in 24F mode is played back in 25F mode (off-speed playback), it is possible to convert 24-frame time code to the 25-frame time code.

To convert the time code, follow the steps below.

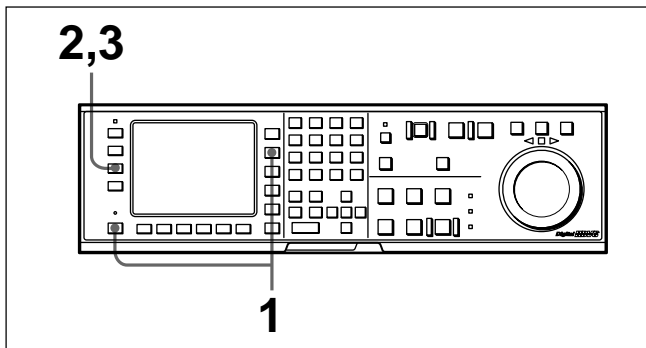

- 1 Press the TC button, and then press the ALT button.
The ALT+TC menu appears.
- 2 Press the **[F3]** (TCCONV MENU) button.
The TC CONVERT menu appears.
- 3 Press the **[F3]** (TC CONV) button to select “on.”
Each time you press the button, “on” and “off” alternate.
 - on:** 24-frame time code is converted to 25-frame time code.
 - off:** 24-frame time code is not converted to 25-frame time code.

Notes

- This setting is only active when the frame frequency of the unit is 25PsF or 50i.
- This setting is effective only for the VITC and time code of SONY 9PIN protocol. From the TIME CODE OUT connector, 24 frames time code is output.

4-3-11 Displaying the Pull Down Time Code (when HKDV-507/507D is installed)

To display the pull down time code, follow the steps below.

- 1 Press the TC button, then press the ALT button.

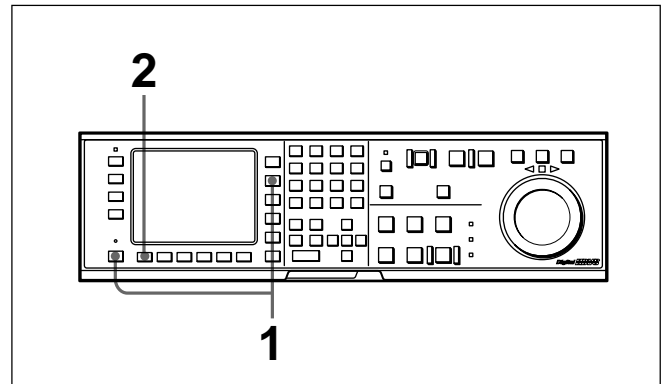

- 2 Press the **[F4]** (PDTC DISP) key to select “on”.
on: Displays the pull down time code.
off: Does not display the pull down time code.

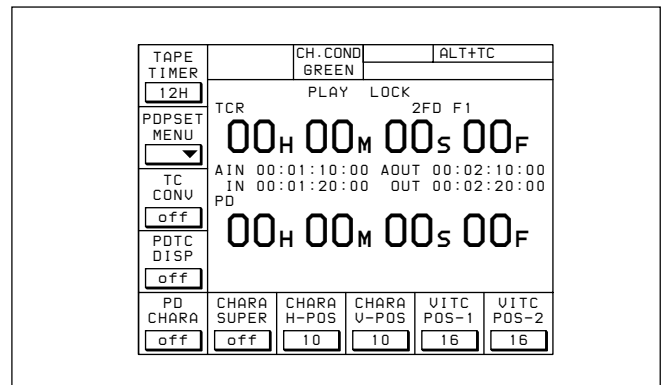

4-3-12 Superimposition of Character Information (PD CHARA/CHARA SUPER/H-POS/V-POS)

To superimpose the characters representing time code data and operation mode information on the output signals, use the [F4] (PD CHARA) and [F6] (CHARA SUPER) buttons.

Button	Setting	Connector to which the characters are superimposed
ALT/[F4]	on	PULL DOWN OUT connector (on two connectors)
ALT/[F6]	on	<ul style="list-style-type: none"> •HD SDI MONITOR connector •COMPOSITE (SUPER) connector of D CONV. OUT(OPTION) •3(SUPER) of connector D CONV. SDI OUT(OPTION)

Contents of superimposed data

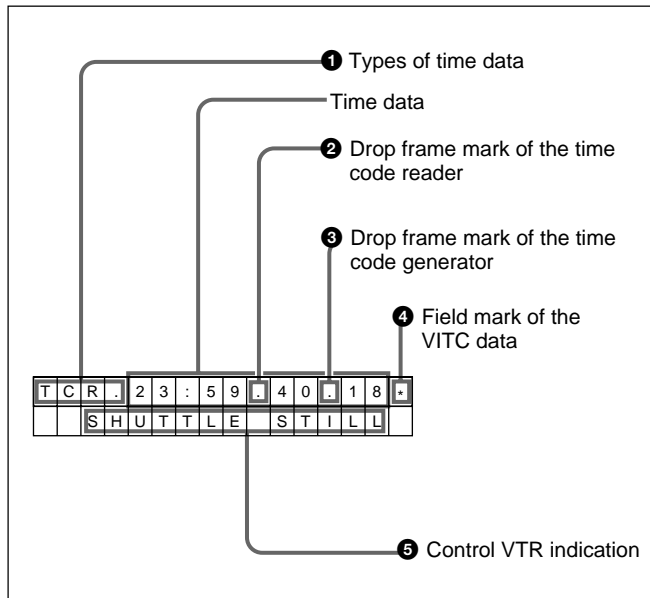

Contents of superimposed data

Note

The example above shows the factory-set contents of data. By changing the 626.DISPLAY INFORMATION select setting in the VTR SETUP menu, different types of information can also be displayed on the second line.

1 Types of time data

Symbol	Meaning
CTL	CTL counter data
TCR	LTC reader time code data
UBR	LTC reader user bit data
TCR.	VITC reader time code data
UBR.	VITC reader user bit data
TCG	Time code data from the time code generator
UBG	User bit data from the time code generator

Note

When time data or user bits are not read correctly, a “*” will be displayed in this block so that the symbols become “T*R”, “U*R”, etc.

2 Time code reader drop frame marks

- “•” : drop frame mode
- “:” : non-drop frame mode

3 Time code generator drop frame marks

- “•” : drop frame mode
- “:” : non-drop frame mode

4 VITC data field marks

- “ ” : (blank space) fields 1 and 3
- “*” : fields 2 and 4

5 Operation mode

The contents are divided into blocks A and B as shown below.

- A block indicates the operation mode.
- B block indicates the tape speed or servo lock status.

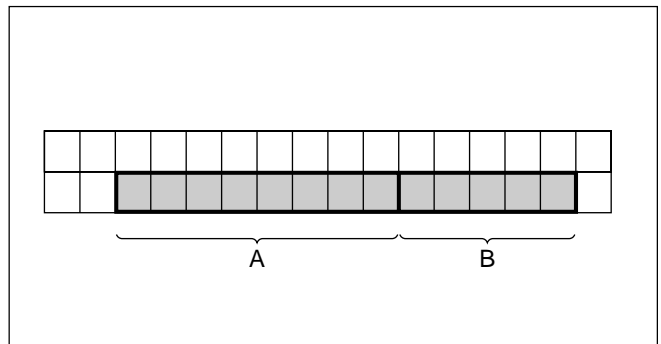

Operation modes

Display		Operation mode
A block	B block	
TAPE UNTHREAD		Cassette not inserted
STANDBY OFF		Standby off mode
T.RELEASE		Tension release mode
STOP		Stop mode
PREROLL		Preroll mode
PLAY		Playback mode (servo unlocked)
PLAY	LOCK	Playback mode (servo locked)
PLY-SPD	Speed shift from normal speed (%)	Capstan override mode
REC		Record mode (servo unlocked)
REC	LOCK	Record mode (servo locked)
EDIT		Edit mode (servo unlocked)
EDIT	LOCK	Edit mode (servo locked)
JOG	STILL	Still-picture jog mode
JOG	FWD	Forward jog (▶ is lit)
JOG	REV	Reverse jog (◀ is lit)
SHUTTLE	(speed)	Shuttle mode
VAR	(speed)	Variable mode
DMC	(speed ^{a)})	DMC memorize mode
D-PREV	(speed ^{a)})	DMC edit preview mode
DMC EDIT		DMC edit mode
DMC-SPD	(speed)	DMC initial speed setting
PREVIEW		Preview mode
AUTO EDIT		Auto edit mode
REVIEW		Review mode

a) Initial speed or memorized speed

To display a warning message

For details about the warning messages, see “Warning Messages” on page A-10.

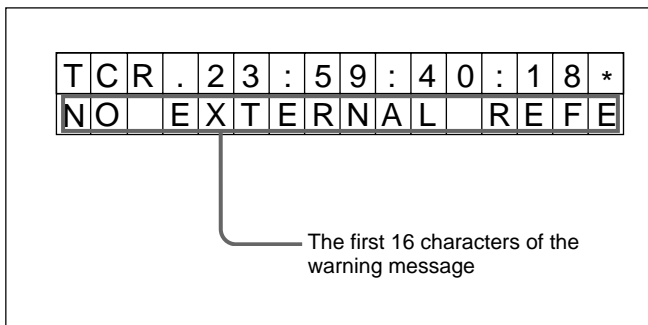

When there are multiple warning messages, each message flashes twice before it is replaced by the next message. When there is no warning message, the items set in 626. DISPLAY INFORMATION select in the VTR SETUP menu flashes on the second line instead.

Set 626. DISPLAY INFORMATION select in the VTR SETUP menu to any setting other than time data only and set 627. CHAR WARNING DISPLAY at dual line mode in the VTR SETUP menu to on. The first 16 characters of the warning message flashes on the second line.

4-3 TC Menu

To display remaining time on the tape

Use the 628.REMAIN TIME DISPLAY to display remaining time on the tape.

off: Do not display remaining time.

10min: Display remaining time when it is 10 minutes or less.

on: Always display remaining time.

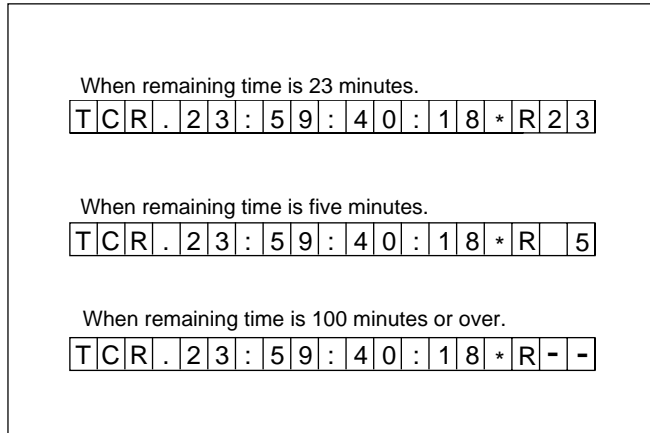

Examples of remaining time display

Changing the superimpose position

The superimpose position can be set to 16 different positions in the horizontal directions (0-15) and 24 different positions in the vertical directions (0-23).

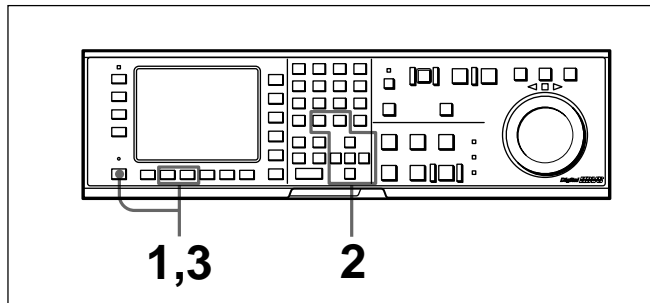

- 1 Press the ALT/**F7** (CHARA H-POS) button to change the horizontal position and the **F8** (CHARA V-POS) button to change the vertical position. The setting display part is lit.
- 2 Use the **<** and **>** buttons to change the value. The + and - buttons can also be used.
- 3 Press the ALT/**F7** (CHARA H-POS) button or the **F8** (CHARA V-POS) button. The positions are set and the setting display disappears. The positions are also set if another menu is selected.

4-3-13 Setting the VITC Insertion Line (VITC POS-1/POS-2)

VITC signals can be inserted at two positions in the output signal from the HD-SD converter.

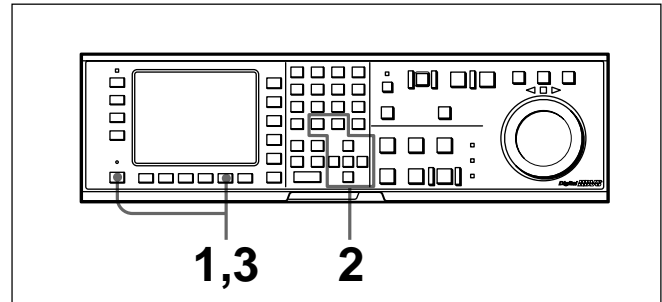

Setting the VITC insertion line (VITC POS-1/POS-2)

- 1 Press the ALT button, then the **F9** (VITC POS-1) button. The setting display part is lit.
- 2 Press the **▲** or **▼** button to change the value. You can also use the + or - button.
- 3 Press the **F9** (VITC POS-1) button. The data setting is completed and the setting display disappears. Switching to another menu also completes the setting display disappears.

Following the same steps but using the **F10** (VITC POS-2) button, VITC can be inserted on another line.

4-3-14 Presetting for Conversion From 25-frame Into 24-frame Time Code (TCCONV MENU)

When the VTR is operated in 23.98PsF/24PsF mode, follow the steps below to make the settings for 24-frame converted time code.

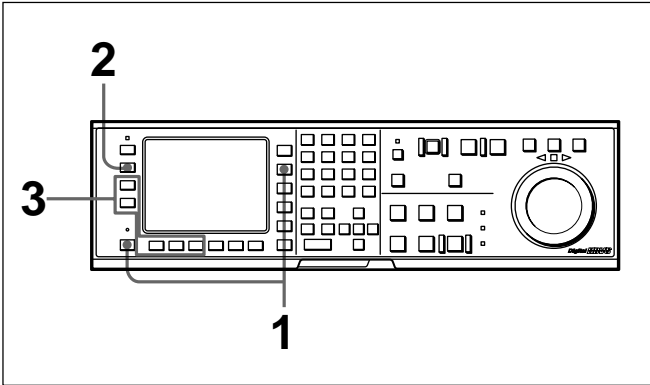

- 1** Press the TC button, and then press the ALT button. The ALT+TC menu appears.
- 2** Press the [F3] (TCCONV MENU) button. The TC CONVERT menu appears.

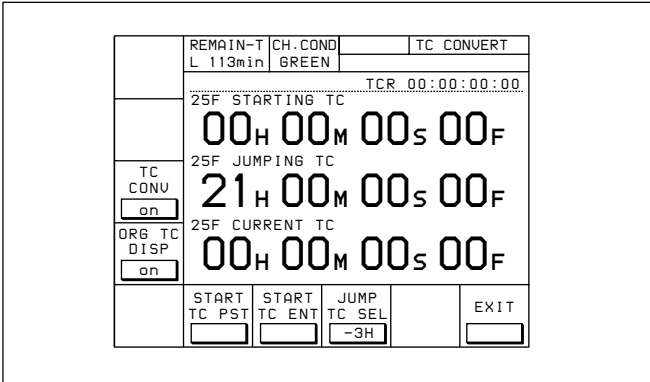

25F STARTING TC: Time code used as a reference when converting 25-frame time code into 24-frame time code.

25F JUMPING TC: The loopback point for converting 25-frame time code to 24-frame time code with 25F STARTING TC as the reference and the conversion done in both forward and reverse directions. Note that the part of the 24-frame time code before 25F JUMPING TC is not consecutive with the part after 25F JUMPING TC.

The table below shows an example of how the 24-frame time code is not consecutive when 25F STARTING TC is set to 01:00:00:00 and 25F JUMPING TC is set to 22:00:00:00 (i.e., JUMP TC SEL is set to -3H).

	25 Frames TC	24 Frames TC
JUMPING TC	22:00:00:00	22:52:30:00
	:	:
Forward direction	01:00:01:24	01:00:01:00
	:	:
STARTING TC	01:00:00:00	01:00:00:00
Reverse direction	00:00:59:24	00:00:59:23
	:	:
JUMPING TC	22:00:00:01	21:52:30:01
	22:00:00:00	22:52:30:00

Non-consecutive part

- 3** If necessary, use the function buttons to change the settings. For details on the settings made by these buttons, see the table below.

TC CONVERT menu		
Button	Indication	Function
[F3]	TC CONV	Specifies whether the time code is converted to 24-frame time code or not.
[F4]	ORG TC DISP	Specifies whether the 25-frame time code is displayed or not on two lines in the HOME, TC, and PF menus along with the converted time code.
[F6]	START TC PST	Press to preset the 25F STARTING TC using the numeric buttons.
[F7]	START TC ENT	Press to enter the current time code as the 25F STARTING TC.
[F8]	JUMP TC SEL	Selects the 25F JUMPING TC as an interval from 25F STARTING TC. Selectable values: -3H, -2H, -1H, +1H, +2H, +3H, 0H
[F10]	EXIT	Select to exit the TC CONVERT menu.

4-3 TC Menu

To preset the 25F STARTING TC using the numeric buttons

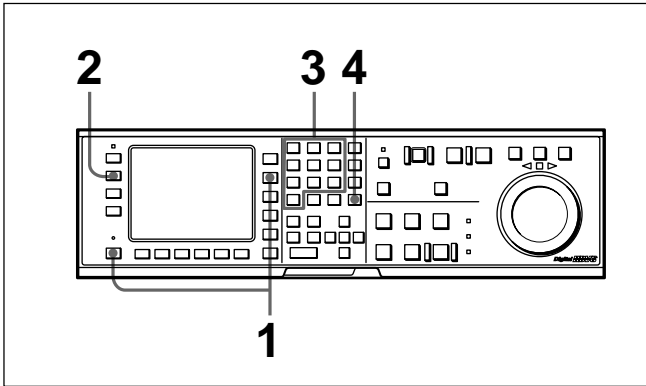

- 1 Press the TC button, and then press the ALT button.
The ALT+TC menu appears.
- 2 Press the **[F3]** (TCCONV MENU) button.
The TC CONVERT menu appears.
- 3 Enter the time code in the data entry window with the numeric buttons.

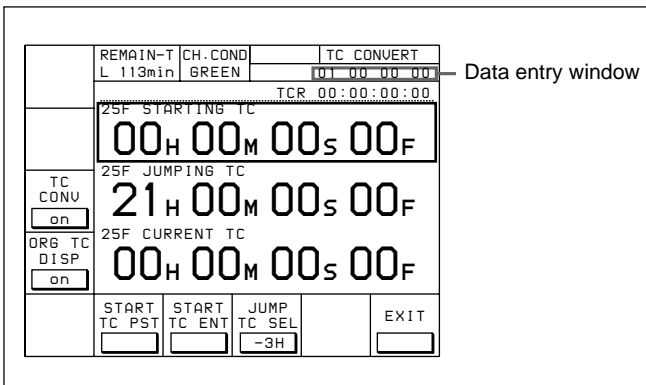

- 4 Press the SET button to set the time code.

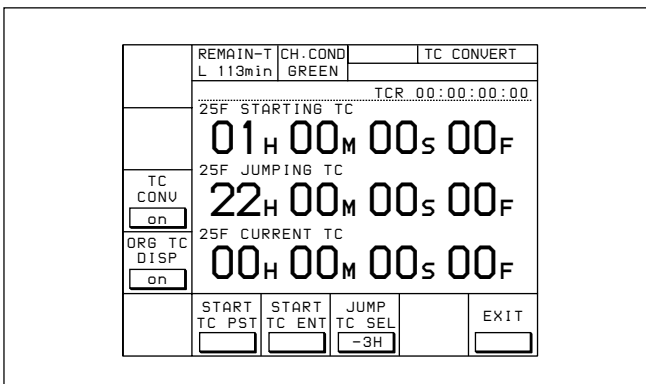

4-3-15 Conversion of Time Code During Playback in 24F Mode (TC CONV)

When the cassette tape recorded in 25F mode is played back in 24F mode (off-speed playback), it is possible to convert 25-frame time code to the 24-frame time code.

To convert the time code, follow the steps below.

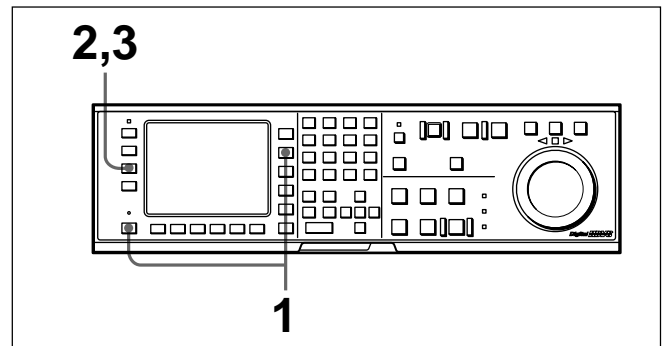

- 1 Press the TC button, and then press the ALT button.
The ALT+TC menu appears.
- 2 Press the **[F3]** (TCCONV MENU) button.
The TC CONVERT menu appears.
- 3 Press the **[F3]** (TC CONV) button to select “on.”
Each time you press the button, “on” and “off” alternate.
 - on:** 25-frame time code is converted to 24-frame time code.
 - off:** 25-frame time code is not converted to 24-frame time code.

Notes

- This setting is only active when the frame frequency of the unit is 23.98PsF or 24PsF.
- This setting is effective only for the VITC and time code of SONY 9PIN protocol. From the TIME CODE OUT connector, 25 frames time code is output.

4-4 CUE Menu

The HDW-F500 allows you to register up to 100 cue points (0 to 99), and to manage cue points in groups of 10 (per page).

Cue point settings, deletions, and page settings are done through the CUE menu.

For details on storing cue point data, refer to “4-1-5 Memory Card Function” on page 4-6.

To activate the CUE menu

Press the CUE button.

Note

Cue point data is factory set to be erased when a cassette is inserted.

To select whether to erase cue point data when a cassette is inserted.

Press the **[F10]** (M-CUE CLEAR) button to select whether to erase cue point data when a cassette is inserted.

on: Erase cue point data.

off: Do not erase cue point data.

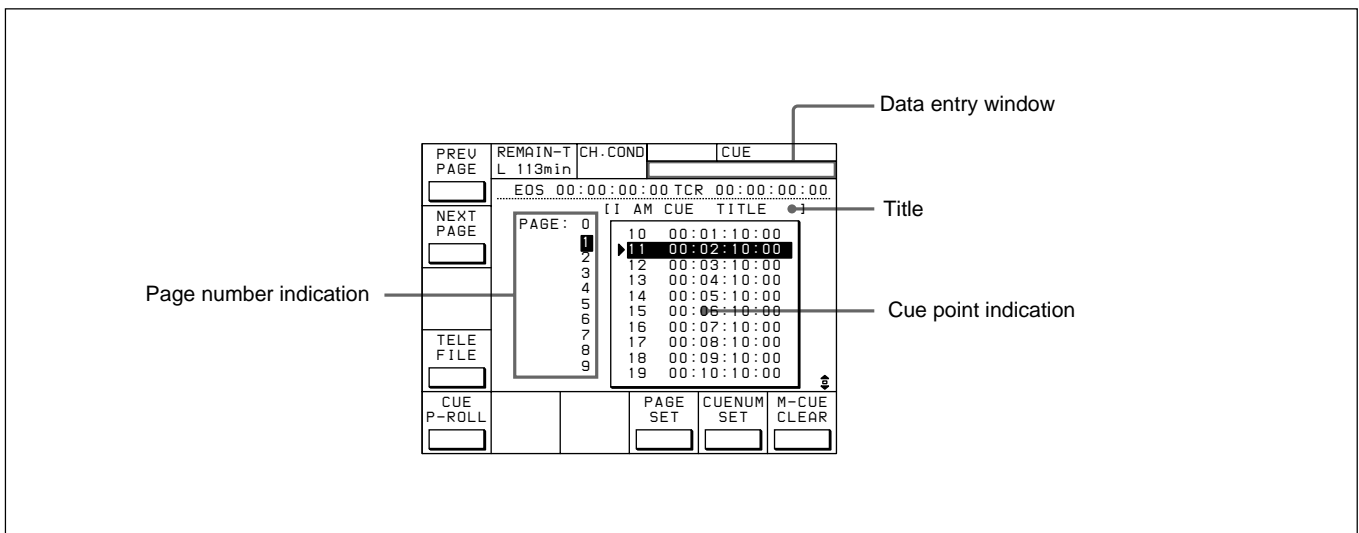

CUE menu display

CUE menu

Button	Indication	Function	Settings
[F1]	PREV PAGE	Shows the previous page.	
[F2]	NEXT PAGE	Shows the next page.	
[F4]	TELE FILE	Opens the TELE FILE menu.	
[F5]	CUE P-ROLL	Specifies the preroll time to a cue point.	0 to 30 s
[F8]	PAGE SET	Specifies the page number.	
[F9]	CUENUM SET	Specifies the cue number.	
[F10]	M-CUE CLEAR	Erases cue point data when a cassette is inserted.	on, off
ALT/ [F8]	PAGE MODE	Selects PAGE mode.	
ALT/ [F9]	EXTEND MODE	Selects EXTEND mode.	

4-4 CUE Menu

4-4-1 Selecting a Multi-Cue Mode

The HDW-F500 has the following two multi-cue modes.

PAGE mode

Press the ALT button, then the **[F8]** (PAGE MODE) button.

In PAGE mode, cue point data can be accessed by page number, thus speeding up cue point registration and cueing operations.

Display

Cue points are displayed in groups of 10, number 0 to 9, 10 to 19, etc. Each display is a page.

Selecting a page

There are the three following ways to select a page:

- Press the **[F1]** (PREV PAGE) button.
The previous page is shown.
- Press the **[F2]** (NEXT PAGE) button.
The next page is shown.
- Enter the desired page number with the numeric button, then press the **[F8]** (PAGE SET) button.
If you enter 1, for example, page one appears, containing cue point numbers 10 to 19.

EXTEND mode

Press the ALT button, then the **[F9]** (EXTEND MODE) button.

In EXTEND mode, you can do operations that cannot be done in page units, such as the consecutive registration of more than 10 cue points.

Display

The screen displays a list of 100 consecutive cue points which can be scrolled. Press the **[▲]** or **[▼]** button to scroll the list. Page columns are not displayed.

To quickly scroll through a list

Press the **[▲]** or **[▼]** button while holding down the SFT button.

4-4-2 Registering Cue Points

There are two ways to register cue points: (1) by direct registration of the tape address when the ENTRY button is pressed, and (2) by the entry of cue point data with the numeric buttons.

Registering cue points by pressing the ENTRY button

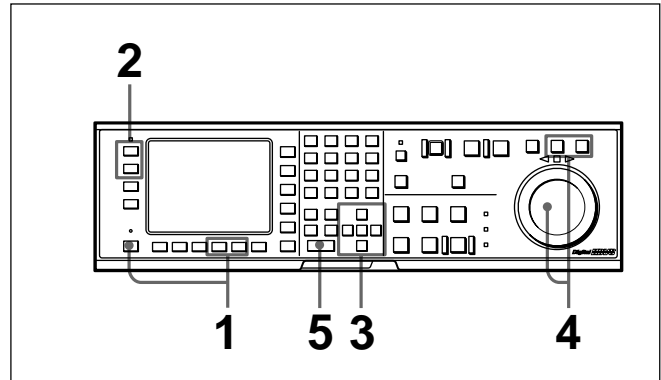

Registering cue points by pressing the ENTRY button

- 1 Press the ALT button, then the **[F8]** (PAGE MODE) button or the **[F9]** (EXTEND MODE) button.
- 2 If you selected PAGE mode, press the **[F1]** (PREV PAGE) button or **[F2]** (NEXT PAGE) button (or use the numeric buttons to enter the page number in the data entry window, then press the **[F8]** (PAGE SET) button).
- 3 Press the **[▲]** or **[▼]** button to move the cursor (▶) to the cue number to be registered.

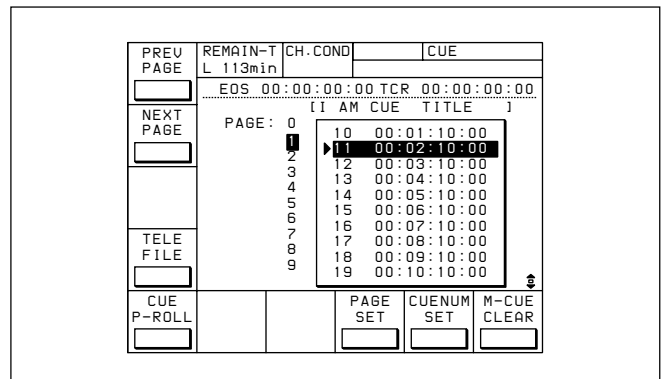

To select the cue number directly by numeric buttons

Enter the cue number in the data entry window with the numeric buttons, then press the **[F9]** (CUENUM SET) button.

- 4 Press the JOG or VAR button, then rotate the search dial to find the position where you want to register the cue point.
- 5 Press the ENTRY button at the selected position. The current tape address of the position where the button is pressed is registered as a cue point. Press the ENTRY button repeatedly to register the cue point repeatedly. The cue number will automatically increment by one each time.

PREV PAGE	REMAIN-T	CH.COND	CUE
	L 113min		
EOS 00:00:00:00 TCR 00:00:00:00			
NEXT PAGE	PAGE: 0	[I AM CUE TITLE]	
	1	10 00:01:10:00	
	2	▶ 11 00:02:10:00	
	3	12 00:03:10:00	
	4	13 00:04:10:00	
	5	14 00:05:10:00	
	6	15 00:06:10:00	
	7	16 00:07:10:00	
	8	17 00:08:10:00	
	9	18 00:09:10:00	
		19 00:10:10:00	
TELE FILE			
CUE P-ROLL		PAGE SET	CUENUM SET M-CUE CLEAR

Note

In PAGE mode, the cue number advances only within the current page when the ENTRY button is pressed repeatedly. For example, after cue number 19 is registered and the ENTRY button is pressed, the cue point 10 comes up as the next cue point. In EXTEND mode, if you press the ENTRY button after registering, for example, cue point No.99, the next cue point is registered to cue point No.99 again.

Registering cue points by the numeric buttons

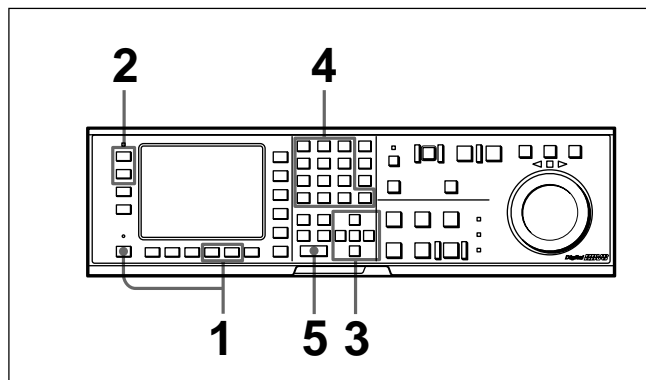

Registering cue points by the numeric buttons

- 1 Press the ALT button, then the **[F8]** (PAGE MODE) button or the **[F9]** (EXTEND MODE) button.
- 2 If you selected PAGE mode, press the **[F1]** (PREV PAGE) button or **[F2]** (NEXT PAGE) button (or use the numeric buttons to enter the page number in the data entry window, then press the **[F8]** (PAGE SET) button).
- 3 Press the **[▲]** or **[▼]** button to move the cursor (▶) to the cue number to be registered.

PREV PAGE	REMAIN-T	CH.COND	CUE
	L 113min		
EOS 00:00:00:00 TCR 00:00:00:00			
NEXT PAGE	PAGE: 0	[I AM CUE TITLE]	
	1	10 00:01:10:00	
	2	▶ 11 00:02:10:00	
	3	12 00:03:10:00	
	4	13 00:04:10:00	
	5	14 00:05:10:00	
	6	15 00:06:10:00	
	7	16 00:07:10:00	
	8	17 00:08:10:00	
	9	18 00:09:10:00	
		19 00:10:10:00	
TELE FILE			
CUE P-ROLL		PAGE SET	CUENUM SET M-CUE CLEAR

To select the cue number directly by the numeric buttons

Enter the cue number in the data entry window with the numeric buttons, then press the **[F9]** (CUENUM SET) button.

(Continued)

4-4 CUE Menu

- 4** Enter the cue point data in the data entry window with the numeric buttons, then press the SET button.

For example, to enter 00:01:30:00, press 0, 0, 1, 3, 0, 0, 0. (The leading 0 is not required. When the entered value is less than eight digits, the leading digit(s) is (are) set to 0 when you press the SET button.)

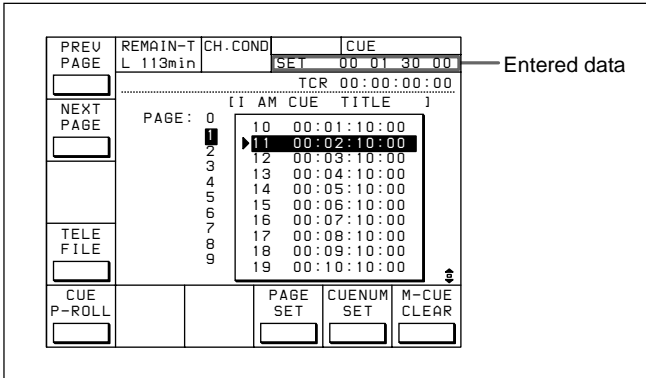

To modify current cue point data

Press the + or – button, enter the value to be added or subtracted, then press the SET button. The computation is performed and the results appear in the data entry window.

- 5** Press the ENTRY button to set the entered data. The data are registered in the cue point data indication.

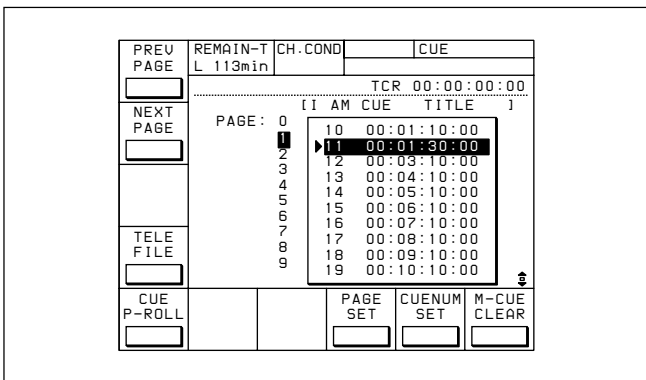

4-4-3 Erasing Cue Point Data

To erase any cue point data, blank out the data entry window, then do the cue point registration procedure.

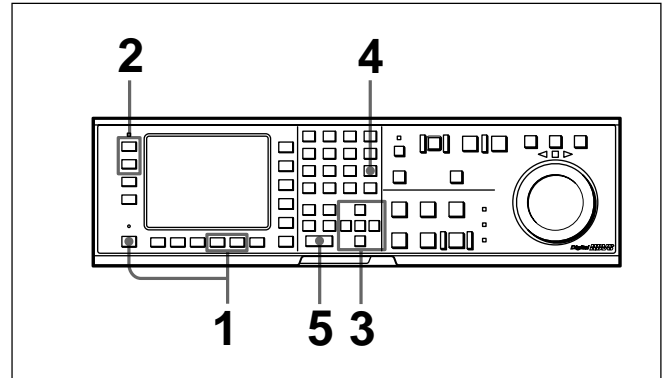

Erasing cue point data

- 1 Press the ALT button, then the **[F8]** (PAGE MODE) button or the **[F9]** (EXTEND MODE) button.
- 2 If you selected PAGE mode, press the **[F1]** (PREV PAGE) button or **[F2]** (NEXT PAGE) button (or use the numeric buttons to enter the page number in the data entry window, then press the **[F8]** (PAGE SET) button).
- 3 Press the **[Δ]** or **[▽]** button to move the cursor (▶) to the cue number to be erased.

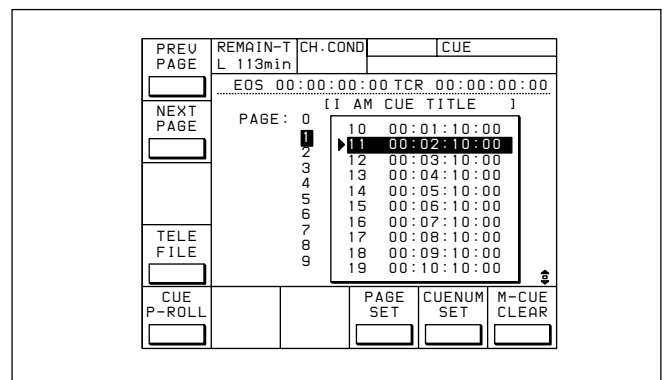

To select the cue number directly by the numeric buttons

Enter the cue number in the data entry window with the numeric buttons, then press the **[F9]** (CUENUM SET) button.

- 4 Press the CLR button then the SET button.
“SET” appears in the data entry window.

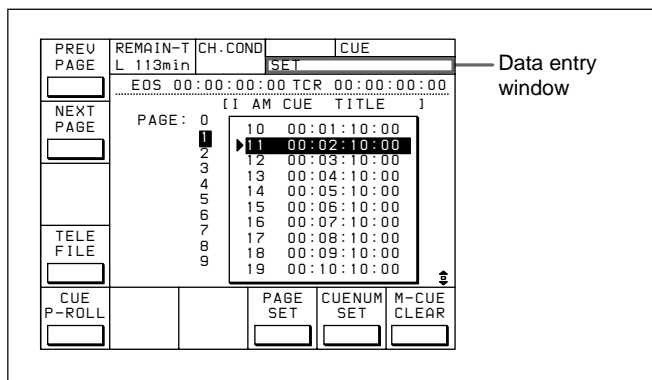

- 5 Press the ENTRY button.
Data for the specified cue number are erased and the data column becomes blank.

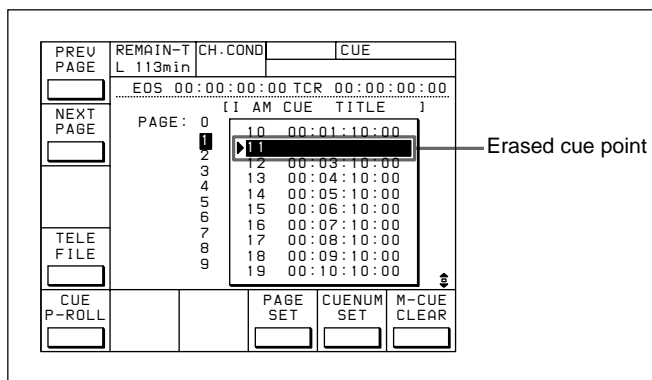

To erase all cue point data

Press the CLR button while holding down the SFT button. A message asking you to confirm the operation appears in the display.

In EXTEND mode, press the CLR button while holding down the SFT button again to erase all data for cue points No. 0 to No. 99.

In PAGE mode, press the CLR button while holding down the SFT button again to erase data for the cue points on the current page.

4-4-4 Prerolling to a Cue Point

Select the preroll time to a cue point with pressing the [F5] button.

You can set a preroll time of 0 to 30 seconds in 1-second units.

Prerolling to a cue point

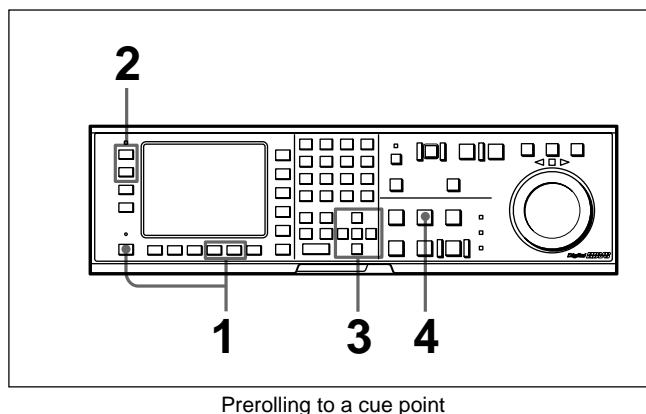

Prerolling to a cue point

- 1 Press the ALT button, then the [F8] (PAGE MODE) button or the [F9] (EXTEND MODE) button.
- 2 If you selected PAGE mode, press the [F1] (PREV PAGE) button or [F2] (NEXT PAGE) button (or use the numeric buttons to enter the page number in the data entry window, then press the [F8] (PAGE SET) button).
- 3 Press the [▲] or [▼] button to move the cursor (▶) to the cue number.

To select the cue number directly by the numeric buttons

Enter the cue number in the data entry window with the numeric buttons, then press the [F9] (CUENUM SET) button.

- 4 Press the PREROLL button.

4-4 CUE Menu

4-4-5 Changing a Cue Point Into an Edit Point

Follow the procedures below to change a selected cue point into an edit point.

To change an edit point into an IN point

Press the SET button while holding down the IN button.

To change an edit point into an OUT point

Press the SET button while holding down the OUT button.

To change an edit point into an AUDIO IN point

Press the SET button while holding down the AUDIO IN button.

To change an edit point into an AUDIO OUT point

Press the SET button while holding down the AUDIO OUT button.

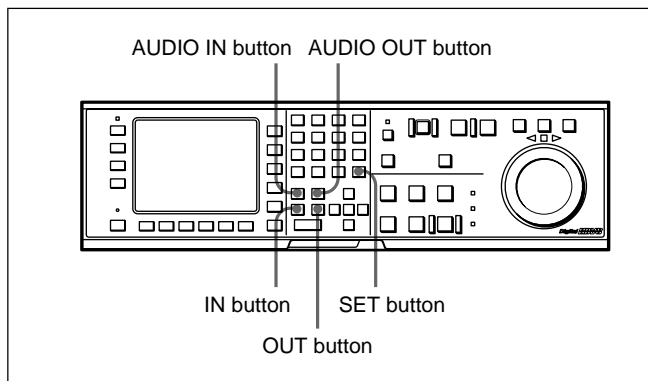

4-4-6 Backspace Editing

You can perform backspace editing with the CUE menu. In backspace editing, assemble editing is performed from the recording end point. Since the data specifying recording end point are cleared when you eject the tape, after inserting a tape, you must record for at least one minute or so on the tape before you can do backspace editing. After recording, the present end of the recorded position becomes the recording end point. When you press the REC/EDIT button afterwards, the VTR automatically prerolls a few seconds before the recording end point and starts assemble editing. If no data for the recording end point exist, backspace editing is not performed.

Note

Cue point data is cleared when a cassette is inserted. However, cue point data recalled from a memory card before a cassette is inserted is not cleared when a cassette is inserted.

4-4-7 TELE FILE Menu

Use the TELE FILE menu to read and update cue point information, log(IN/OUT points) information and cassette-management information on optional MLB-1B-100 memory labels.

Operations through the TELE FILE menu can be carried out from either the control panel of the VTR or a personal computer connected to the VTR. To use the control panel, specify “control panel” for item 123.Tele-File CONTROL MODE in the VTR SETUP menu. To use a personal computer, specify “RS-232C.”

Note

Before you can use the menu to operate the VTR from a personal computer, the optional MLZ-100 memory label application software must be installed in the computer.

For details on the use of a personal computer, refer to the operation manual supplied with the optional MLZ-100 memory label application software.

The explanations of menu operations in this chapter assume the use of the VTR control panel.

Opening the TELE FILE menu

Do one of the following:

- Press the **[F4]** (TELE FILE) button while in the CUE menu.
- Select “on” for item 124.Tele-File MENU auto popup in the VTR SETUP menu. Then, with the HOME, TC, CUE, or SETUP menu open, insert a cassette bearing an optional MLB-1B-100 memory label into the VTR.

To change the information displayed in the TELE FILE menu

Press the **[<]** or **[>]** button.

To display log data (IN or OUT points) in the TELE FILE menu

Do one of the following:

- Press the **[F2]** (ENTRY POINT) button while in the TELE FILE menu. Then select “INPUT.”
- Select “IN/OUT Point” for item 126.Tele-File ENTRY POINT in the VTR SETUP menu.

Exiting the TELE FILE menu

Press the **[F10]** (WRITE/EXIT) button. The entered or modified data is saved to the memory label and the VTR exits the TELE FILE menu.

Note

If TELE FILE menu operations are prohibited (see page 4-39) while the contents of a memory label are being modified, only the data modified prior to the prohibition will be saved to the memory label when the **[F10]**(WRITE/EXIT) button is pressed.

To exit the TELE FILE menu without saving data to a memory label

Press the EJECT button. Or, press the ALT/**[F2]** (UNDO ALL) buttons to display a message (in the control panel display) requesting confirmation of the undoing operation. Then press the **[F2]**(UNDO ALL) button while pressing down the SFT button. All changes to the memory label will be cancelled.

Note

When you press the EJECT button, all controls on the VTR will become inoperable until the cassette is completely ejected.

If you accidentally press the EJECT button before saving data to a memory label

Insert the cassette again within 30 seconds after the ejection and press the **[F10]**(WRITE/EXIT) button. The data that existed before the ejection of the cassette is saved to the memory label.

4-4 CUE Menu

Four levels of information can be displayed in the TELE File menu and the levels can be scrolled to the left or right by pressing the \leftarrow or \rightarrow button.

No.	Time	Mrk	IN
0	00:01:02:03	NG	00:01:01:03
1	00:03:04:03	KP	00:03:03:03
2	00:04:04:03	OK	00:04:03:03
3	00:05:05:03	OK	00:05:04:03
4	00:06:06:03	OK	00:06:05:03
5	---	---	---
6	---	---	---

TELE FILE menu display 1

No.	IN	OUT	Tk	Cut	Scn
1	00:01:02:03	00:01:03:03	1	0015	A01
2	---	---	2	0015	A01
3	00:03:04:03	00:04:05:03	3	0015	A01
4	00:04:04:03	00:05:05:03	1	017~	A01
5	00:05:05:03	00:06:06:03	1		B20
6	00:06:06:03	00:07:05:03	2		B20
7	---	---			

TELE FILE menu display 2

No.	IN	OUT
1	00:01:02:03	00:01:03:03
2	---	---
3	00:03:04:03	00:04:05:03
4	00:04:04:03	00:05:05:03
5	00:05:05:03	00:06:06:03
6	00:06:06:03	00:07:05:03
7	---	---

TELE FILE menu display 3

No.	Comment
1	Noisy
2	Holiday
3	Pretty Good
4	for NG Awards
5	Goal
6	Celebration
7	

TELE FILE menu display 4

1 REC DATE

Displays the date the memory label contents were last modified.

2 TITLE

Displays the cassette title.

3 Time

Displays the time data of the cue point.

4 Mrk

Displays the cue point attribute (OK/NG/KP/no attribute).

5 Recording start point setting

Recording start points are indicated by an @ mark.

6 IN

Displays IN point data.

7 OUT

Displays OUT point data.

8 Tk

Displays the take number of the cue point.

9 Cut

Displays the cut number of the cue point.

10 Scn

Displays the scene number of the cue point.

11 Comment

Displays the comment for a cue point.

TELE FILE menu

Button	Indication	Function
[F1]	CUE SCAN	Specifies the direction of the cursor movement when the PREROLL button is pressed.
[F2]	ENTRY POINT	Specifies whether IN and OUT point data are displayed or not in the TELE FILE menu.
[F3]	COMMNT EDIT	Edits the contents of the Comment section.
[F4]	CHANGE DATA	Modifies the specified data.
[F5]	DEL POINT	Deletes the time data of the cue point.
[F6]	MARK	Changes the data in the Mrk section.
[F7]	PROTECT	Write-protects the cue point data.
[F8]	TAPE INFO	Displays the TAPE INFORMATION window.
[F9]	CUENUM POINT	Moves the cursor to the line specified by the numeric buttons.
[F10]	WRITE/EXIT	Closes the TELE FILE menu after saving changes to the memory label.
ALT/[F1]	FORMAT T-Fil	Formats the memory label.
ALT/[F2]	UNDO ALL	Undoes all changes.
ALT/[F3]	ATTRIB EDIT	Changes the ID, ADMIN, or TITLE data in the TAPE INFORMATION window.
ALT/[F4]	COPY to CUE	Copies the time data of a cue point to another cue point indicated in the CUE menu.
ALT/[F5]	T-Fil MODE	Selects the device to be used for TELE FILE menu operations. Note This setting can be done only when no cassette is inserted in the VTR.
ALT/[F7]	WRITE PRTEC	Prohibits TELE FILE menu operations.
ALT/[F10]	WRITE/EXIT	Closes the TELE FILE menu after saving changes to the memory label.

Formatting a memory label

- 1 Press the ALT/[F1] (FORMAT T-Fil) buttons.
- 2 Press the [F1] (FORMAT T-Fil) button while pressing down the SFT button.
A message appears (in the control panel display) requesting confirmation of the formatting operation.

To cancel the formatting operation

Press the CLR button.

- 3 Press the [F1] (FORMAT T-Fil) button while pressing down the SFT button.
“COMPLETED” appears in the control panel display.

Selecting the device to be used for TELE FILE menu operations

With no cassette inserted, press the ALT/[F5] (T-Fil MODE) buttons to select the device.

232C: The device connected to the RS-232C connector on the VTR is used.

panel: The VTR control panel is used.

Prohibiting TELE FILE menu operations

Press the ALT/[F7] (WRITE PRTEC) buttons.

on: All TELE FILE menu operations are prohibited.

off: All TELE FILE menu operations are permitted.

4-4 CUE Menu

Changing a title

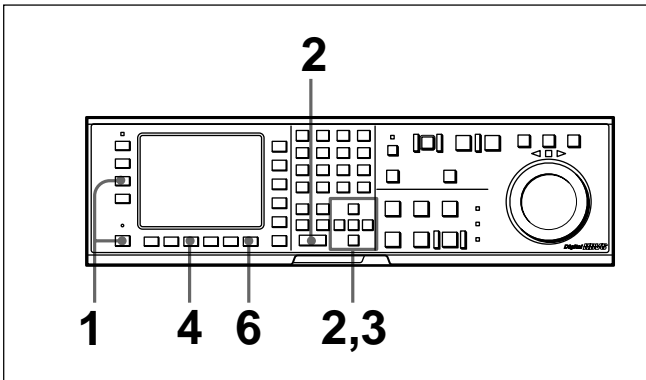

- 1 Press the ALT/[F3] (ATTRIB EDIT) buttons.
- 2 Press the or button to select TITLE, and then press the ENTRY button.

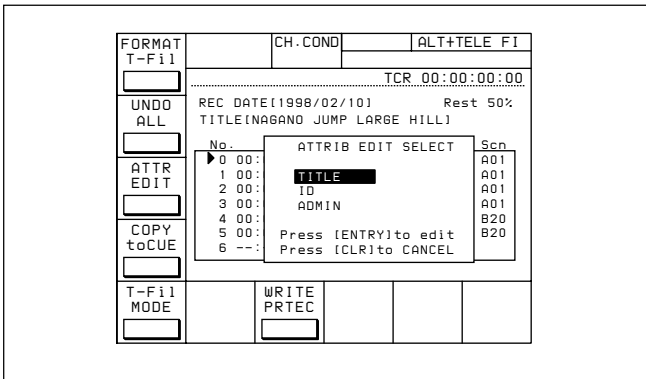

- 3 Press the or button to select a character.

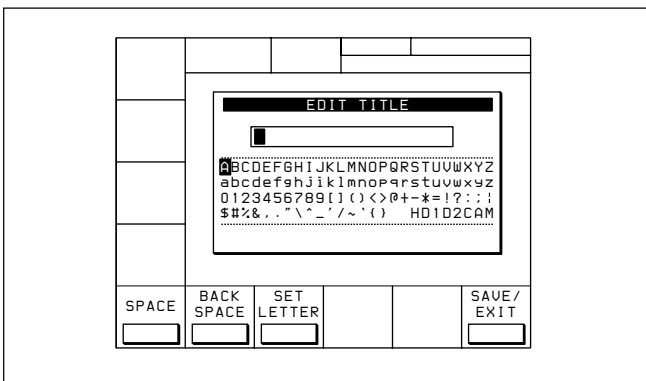

- 4 Press the [F7] (SET LETTER) button or the center cursor button.
The selected character is entered.

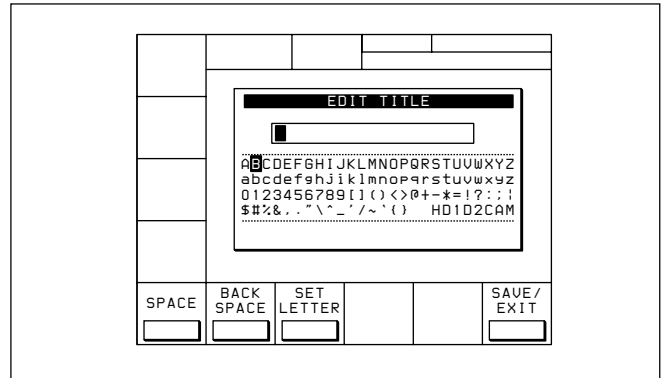

- 5 Repeat steps 3 and 4 to enter more characters.

To enter a space

Press the [F5] (SPACE) button.

If you enter a wrong character

Press the [F6] (BACK SPACE) button to go back.
Then re-enter the character.

To start the procedure over again

Press the [F9] (CANCEL) button to start again.

To change a character

Press the button to move the cursor to the title box. Then press the or button to change the insertion position.

If entered title exceeds the length of the title box

◀ or ▶ appears to the left or right of the box.

- 6 Press the [F10] (SAVE/EXIT) button. The screen that was on before the title was entered is displayed again.

4-4 CUE Menu

To copy time data of a cue point to another cue point specified in the CUE menu

- 1 Press the ALT/[F4] (COPY to CUE) buttons. A message appears (in the control panel display) requesting confirmation of the copy operation.

To cancel the copy operation

Press the CLR button.

- 2 Press the [F4] (COPY to CUE) button while pressing down the SFT button. The time data of the cue point is copied to the cue point indicated in the CUE menu.

Changing Mrk data

Use the cursor buttons to move the cursor to the line with the mark attribute to be changed, and then press the [F6] (MARK) button. Or, move the cursor directly to the mark attribute to be changed, and then press the [F4] (CHANGE DATA) button. In both cases, each press of the button changes the attribute as follows: OK → NG → KP (keep temporarily) → blank (no attribute).

Changing the recording starting point setting

Use the cursor buttons to move the cursor to the recording starting point section. Then press the [F4] (CHANGE DATA) button. Each press of the button turns the setting on (the @ indication appears) or off (the @ indication disappears).

Entering and modifying IN/OUT point data

You can use either the ENTRY button or the numeric buttons to enter and modify IN/OUT point data.

To enter or modify IN/OUT point data using the ENTRY button

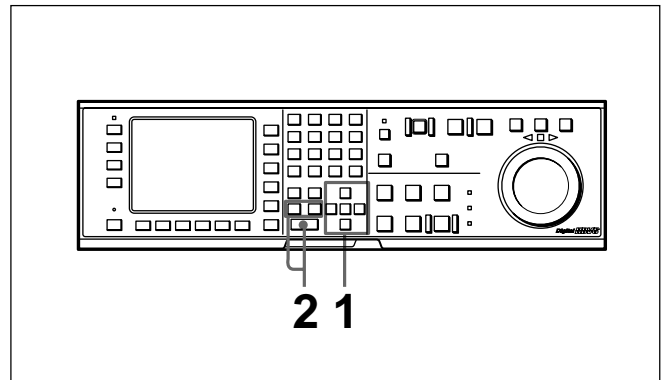

- 1 Use the cursor buttons to move the cursor to the IN/OUT section on which the current time code is to be entered or replaced.

To move the cursor using the numeric buttons

With the cursor specifying Time, Mrk, IN, OUT or the recording starting point section in the TELE FILE menu display, enter the line number using the numeric buttons. Then press the [F9] (CUENUM POINT) button. The cursor will move to the line specified by the numeric buttons.

- 2 Press the IN button (to enter IN point data) or OUT button (to enter OUT point data) while pressing down the ENTRY button.

The current time code is entered as the IN/OUT point data or it replaces the existing IN/OUT point data.

Note

If the cursor is not on the IN/OUT section when pressing the IN/OUT button while pressing down the ENTRY button, the current time code is entered as the Time data or it replaces the existing Time data. When pressing the ENTRY button only, the Time data is entered or replaced regardless of the cursor position.

To enter or modify IN/OUT point data using the numeric buttons

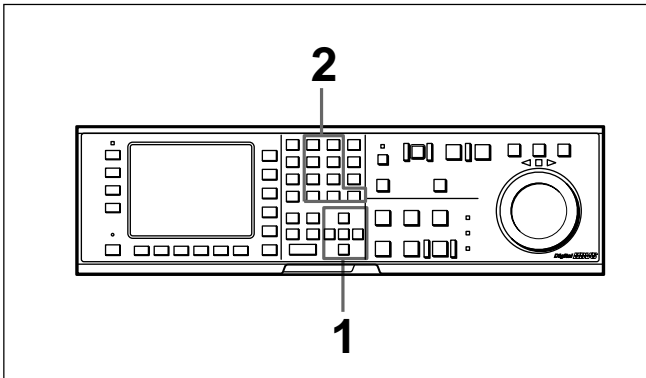

- 1 Use the cursor buttons to move the cursor to the IN/OUT section to be entered or modified.

To move the cursor using the numeric buttons

With the cursor specifying Time, Mrk, IN, OUT or the recording starting point section in the TELE FILE menu display, enter the line number using the numeric buttons. Then press the **[F9]** (CUENUM POINT) button. The cursor will move to the line specified by the numeric buttons.

- 2 Use the numeric buttons to enter the time data in the data entry window, and then press the SET button.

For example, to enter 00:01:30:00, press the numeric buttons as follows: 0, 0, 1, 3, 0, 0, 0. (There is no need to enter the first zero. When you enter a number that is less than eight digits long, the unspecified digits are automatically set to zero when the SET button is pressed.)

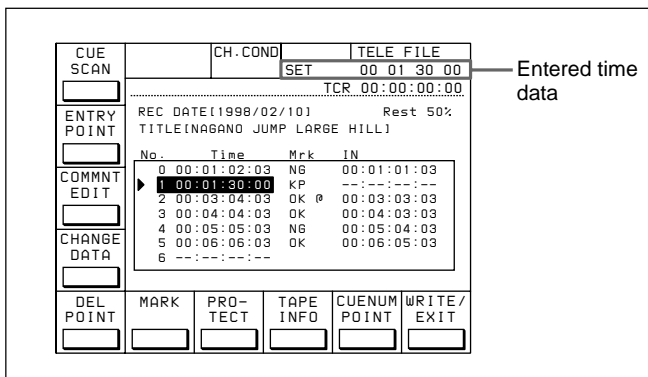

- 3 Press the IN button (to enter IN point data) or OUT button (to enter OUT point data).

The number is entered as the time code or it replaces the existing IN/OUT point data.

To clear the IN/OUT point data

Use the cursor buttons to move the cursor to the IN/OUT section to be cleared, and then press the CLR button while pressing the IN button (to clear IN point data) or OUT button (to clear OUT point data), or press the IN or OUT button (to clear both IN and OUT point data) while pressing the CLR button.

To increase or decrease IN/OUT point data one frame at a time

Use the cursor buttons to move the cursor to the IN/OUT section to be increased or decreased, and then press the + button (to increase the time data) or the - button (to decrease the time data) while pressing the IN button or the OUT button. Each time you press the + or - button, the time data is increased or decreased by one frame, respectively.

To recall IN/OUT point data to the data entry window

Use the cursor buttons to move the cursor to the IN/OUT section to be recalled, and then press the RCL button while pressing the IN button (to recall IN point data) or the OUT button (to recall OUT point data).

4-4 CUE Menu

To enter the current time code continuously

- 1 Set item 127.Tele-File IN OUT input in the VTR SETUP menu to “on.”
- 2 Use the cursor buttons to move the cursor to the IN/OUT section to be entered.

To move the cursor using the numeric buttons

With the cursor specifying Time, Mrk, IN, OUT or the recording starting point section in the TELE FILE menu display, enter the line number using the numeric buttons. Then press the **[F9]** (CUENUM POINT) button. The cursor will move to the line specified by the numeric buttons.

- 3 Press the IN button (to enter IN point data) or OUT button (to enter OUT point data) while pressing down the ENTRY button.

The movement of the cursor is automatic (as described in the table below) and time code is entered continuously.

Input condition	When the IN button is pressed while pressing the ENTRY button	When the OUT button is pressed while pressing the ENTRY button
Only IN point data has been entered	IN point data is modified and the cursor stays on the IN point data.	OUT point data is entered and the cursor moves to the next IN point.
Only OUT point data has been entered	IN point data is entered and the cursor moves to the next IN point.	OUT point data is modified and the cursor stays on the OUT point.
Both IN/OUT point data have not been entered or have been entered	IN point data is entered or modified and the cursor stays on the IN point data.	OUT point data is entered or modified and the cursor stays on the OUT point data.

To display the duration between an IN point and an OUT point

Use the cursor buttons to move the cursor to the IN/OUT section and press the IN button and OUT button at the same time. The duration between two points appears while the buttons are pressed.

To preroll to an IN/OUT point

Use the cursor buttons to move the cursor to the IN/OUT section and press the IN button (to preroll to an IN point) or OUT button (to preroll to an OUT point) while pressing the PREROLL button. The VTR prerolls to the point and stops.

For details on setting the preroll time, see “4-2-7 Setting the Preroll Time” on page 4-18.

Note

If the cursor is not on the IN/OUT section when pressing the IN/OUT button while pressing the PREROLL button, the VTR prerolls to the cue point. When pressing the PREROLL button only, the VTR prerolls to the cue point regardless of the cursor position.

Automatic time data changes during IN/OUT point data entry or modification

The table below shows the automatic changes that occur in time data when either the IN point or OUT point is changed.

When IN point data is entered or modified

Status of input data	IN point	OUT point
The time sequence of the IN/OUT point data is correct.	The data is changed.	The data is unchanged.
The time sequence of the IN/OUT point data is not correct.	The data is changed.	The data is deleted.
The OUT point has not been input.	The data is changed.	The data is unchanged.

When OUT point data is entered or modified

Status of the input data	IN point	OUT point
The time sequence of the IN/OUT point data is correct.	The data is unchanged.	The data is changed.
The time sequence of the IN/OUT point data is not correct.	The data is unchanged.	The data is unchanged.
The IN point has not been input.	The data is unchanged.	The data is changed.

Changing Tk data

Use the cursor buttons to move the cursor to the take data to be changed. Then use the numeric buttons to change the value. Note that only 1-digit or 2-digit values can be entered. Or, move the cursor to the take data, and press the **[F4]** (CHANGE DATA) button or the + button repeatedly to increase the value in increments of 1. Press the – button repeatedly to decrease the value in increments of 1. Note that the value cannot go below 0.

Changing Cut data

Use the cursor buttons to move the cursor to the cut data to be changed, and then enter the new data using the numeric buttons and +/- buttons. Pressing the – button enters the tilde (~). Press the numeric buttons while pressing down the SFT button to enter uppercase letters (A to J). Note that a maximum of four characters can be entered.

Or, do the procedure below to change the data.

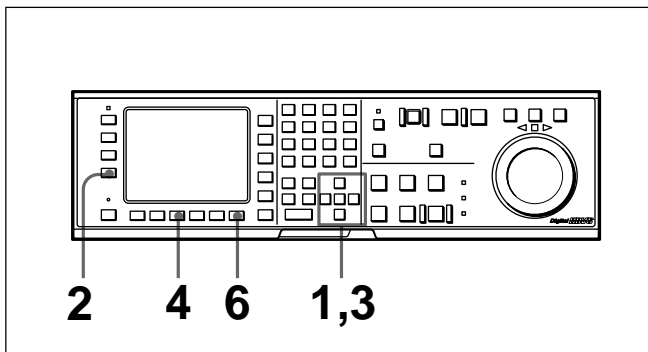

- 1 Press the cursor buttons to move the cursor to the cut data to be changed.

To move the cursor using the numeric buttons

With the cursor specifying Time, Mrk, IN, OUT or the recording starting point section in the TELE FILE menu display, enter the line number using the numeric buttons. Then press the **[F9]** (CUENUM POINT) button. The cursor will move to the line specified by the numeric buttons.

- 2 Press the **[F4]** (CHANGE DATA) button.

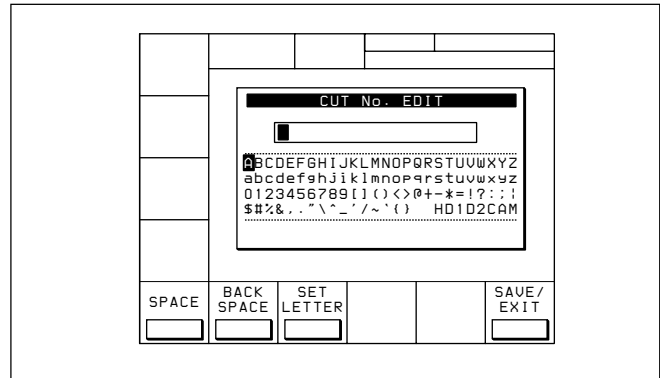

- 3 Press the **[←]** or **[→]** button to select a character.

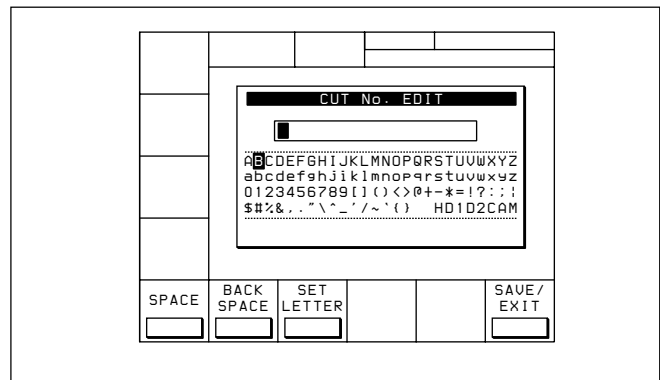

- 4 Press the **[F7]** (SET LETTER) button or the center cursor button. The selected character is entered.

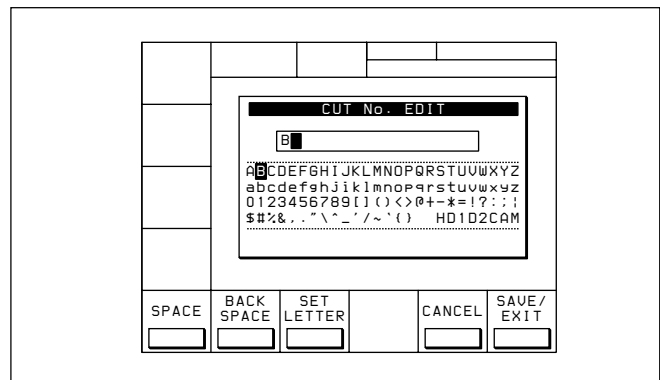

- 5 Repeat steps 3 and 4 to enter more characters.

To enter a space

Press the **[F5]** (SPACE) button.

If you enter a wrong character

Press the **[F6]** (BACK SPACE) button to go back. Then re-enter the character.

(Continued)

4-4 CUE Menu

To start the procedure over again

Press the **[F9]** (CANCEL) button to start again.

To change a character

Press the **[Δ]** button to move the cursor to the cut data to be changed. Then press the **[←]** or **[→]** button to move the insertion position.

6 Press the **[F10]** (SAVE/EXIT) button.

The screen that was on before the cut data was changed is displayed again.

To copy Cut data

Move the cursor to the line to which the copied data is to be pasted. Then press the RCL button. The cut data from the line above is copied to the selected line.

Changing scene data

Use the cursor buttons to move the cursor to the scene data to be changed. Then enter the characters using the numeric buttons and +/- buttons. Press the numeric buttons while pressing down the SFT button to enter uppercase letters (A to J). A maximum of three characters can be entered.

Or, do the procedure below to change the data.

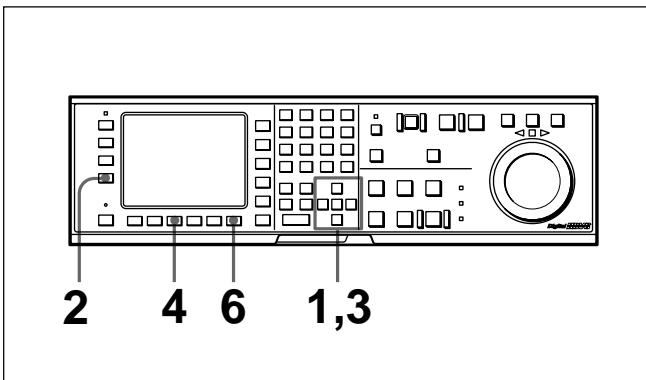

1 Press the cursor buttons to move the cursor to the scene data to be changed.

To move the cursor using the numeric buttons

With the cursor specifying Time, Mrk, IN, OUT or the recording starting point section in the TELE FILE menu display, enter the line number using the numeric buttons. Then press the **[F9]** (CUENUM POINT) button. The cursor will move to the line specified by the numeric buttons.

2 Press the **[F4]** (CHANGE DATA) button.

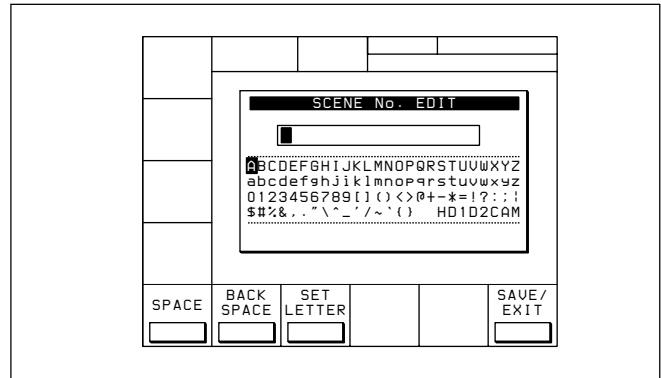

3 Press the **[←]** or **[→]** button to select a character.

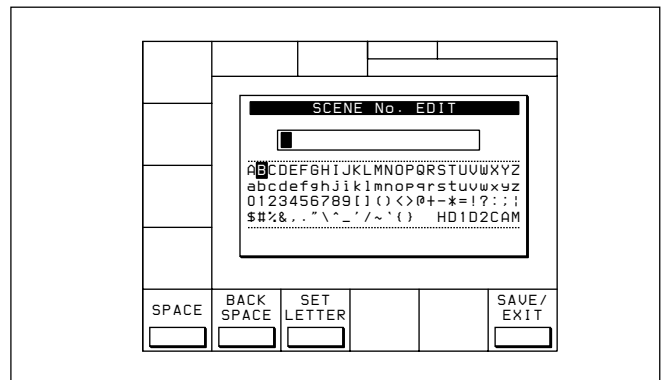

4 Press the **[F7]** (SET LETTER) button or the center cursor button. The selected character is entered.

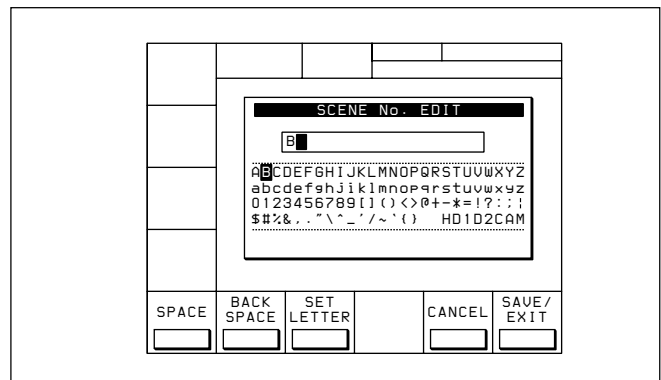

5 Repeat steps 3 and 4 to enter more characters.

To enter a space

Press the **[F5]** (SPACE) button.

If you enter a wrong character

Press the **[F6]** (BACK SPACE) button to go back. Then re-enter the character.

To start the procedure over again

Press the **[F9]** (CANCEL) button to start again.

To change a character

Press the **[Δ]** button to move the cursor to the scene data to be changed. Then press the **[◀]** or **[▶]** button to move the insertion position.

6 Press the **[F10]** (SAVE/EXIT) button.

The screen that was on before the scene data was entered is displayed again.

To copy Scn data

Move the cursor to the line to which the copied data is to be pasted. Then press the RCL button.

The scene data from the line above is copied to the selected line.

Changing Comment data

To display comment data, press the **[>]** button several times.

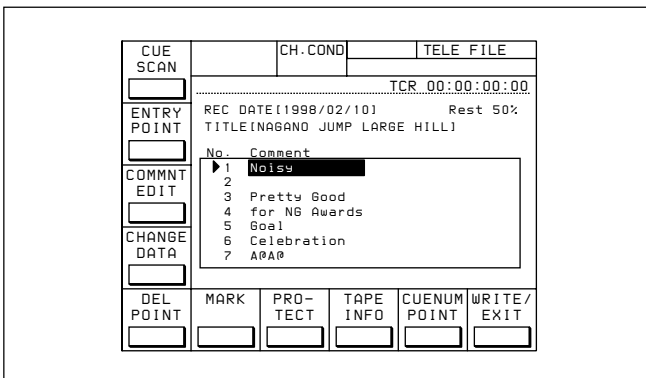

To change Comment data

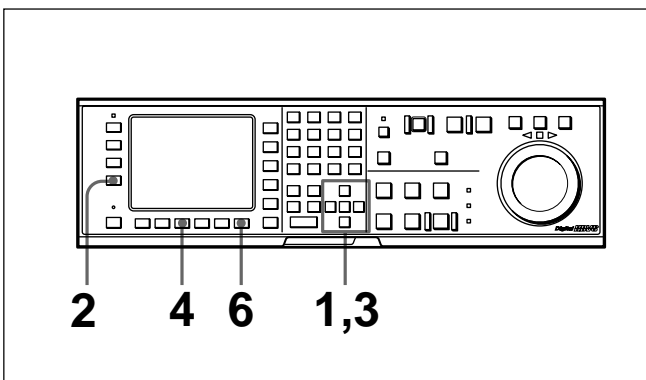

1 Press the cursor buttons to move the cursor to the comment to be changed.

To move the cursor using the numeric buttons

With the cursor specifying Time, Mrk, IN, OUT or the recording starting point section in the TELE FILE menu display, enter the line number using the numeric buttons. Then press the **[F9]** (CUENUM POINT) button. The cursor will move to the line specified by the numeric buttons.

2 Press the **[F3]** (COMMNT EDIT) button.

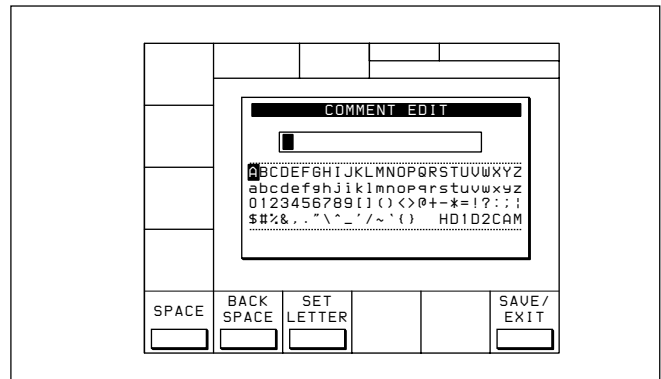

3 Press the **[◀]** or **[▶]** button to select a character.

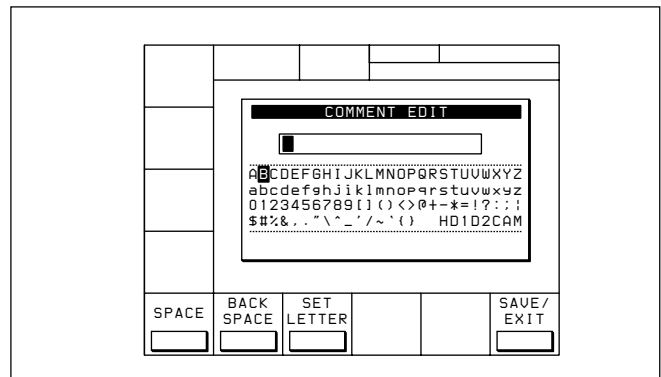

4 Press the **[F7]** (SET LETTER) button or the center cursor button. The selected character is entered.

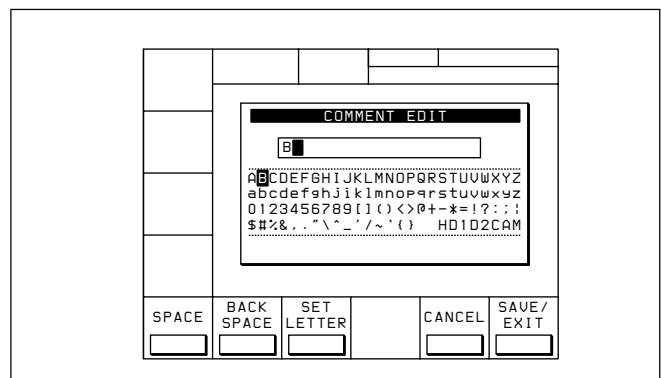

(Continued)

4-4 CUE Menu

- Repeat steps 3 and 4 to enter more characters.
Up to 80 characters can be entered.

Note

If excessive comment data are entered, the input of cue point data may become disabled. To prevent this, press the **[F8]** (TAPE INFO) button to check the available memory.

To enter a space

Press the **[F5]** (SPACE) button.

If you enter a wrong character

Press the **[F6]** (BACK SPACE) button to go back.
Then re-enter the character.

To start the procedure over again

Press the **[F9]** (CANCEL) button to start again.

To change a character

Press the **[A]** button to move the cursor to the comment to be changed. Then press the **[<]** or **[>]** button to move the insertion position.

If the entered text is longer than the comment box

◀ or **▶** appears to the left or right of the box.

- Press the **[F10]** (SAVE/EXIT) button.
The screen that was on before the comment data was changed is displayed again.

Prerolling to a cue point

- Press the **[F1]** (CUE SCAN) button repeatedly to specify the direction in which the cursor moves when the PREROLL button is pressed.
Each press of the button changes the direction as follows: FWD (forward) → REW (reverse) → unspecified.
FWD: Pressing the PREROLL button causes the cursor to move to the next line, and the VTR to preroll to the time code on that line. Invalid time codes are ignored.
REW: Pressing the PREROLL button causes the cursor to move to the previous line, and the VTR to preroll to the time code on that line. Invalid time codes are ignored.

- Press the PREROLL button.

Write-protecting cue point data

Press the cursor buttons to move the cursor to the line that is to be write-protected. Then press the **[F7]** (PROTECT) button. **⏏** appears between the Time and Mrk columns to indicate that the time data, mark data, and recording starting point setting on that line are write-protected.

CUE SCAN	CH.COND	TELE FILE
<input type="text"/>		
ENTRY POINT	TCR 00:00:00:00	
<input type="text"/>	REC DATE(1998/02/10) Rest 50%	
COMMNT EDIT	TITLE(NAGANO JUMP LARGE HILL)	
<input type="text"/>		
CHANGE DATA		
<input type="text"/>		
DEL POINT	MARK	PRO-TECT
<input type="text"/>	<input type="text"/>	<input type="text"/>
	TAPE INFO	CUENUM
	<input type="text"/>	<input type="text"/>
	WRITE/EXIT	<input type="text"/>
	<input type="text"/>	<input type="text"/>

No.	Time	Mrk	IN
0	00:01:02:03	NG	00:01:01:03
1	00:03:04:03	⏏ KP	--:--:--:--
2	00:03:04:03	OK	00:03:03:03
3	00:04:04:03	OK	00:04:03:03
4	00:05:05:03	NG	00:05:04:03
5	00:06:06:03	OK	00:06:05:03
6	--:--:--:--		

To cancel a write-protection

Press the cursor buttons to move the cursor to the line for which write-protection is to be cancelled. Then press the **[F7]** (PROTECT) button. A message appears (in the control panel display) requesting confirmation of cancellation operation. Press the **[F7]** (PROTECT) button while pressing down the SFT button.

Inserting a new line

- 1 Use the cursor buttons to move the cursor to the line that will be under the new line to be inserted.

To move the cursor using the numeric buttons

With the cursor specifying Time, Mrk, IN, OUT or the recording starting point section in the TELE FILE menu display, enter the line number using the numeric buttons. Then press the **[F9]** (CUENUM POINT) button. The cursor will move to the line specified by the numeric buttons.

Note

If the movement of the cursor (▶) is not linked with the cursor buttons, the cursor (▶) will not move when the cursor buttons are pressed.

To link the cursor (▶) with the cursor buttons

Press the center cursor button. Each press of the button alternately links and unlinks the cursor (▶).

- 2 Press the ENTRY button while pressing down the SFT button. A new line is inserted above the line where the cursor (▶) is located, and the current time code is entered on the new line.

Moving a line

Press the cursor buttons to move the cursor to the Time data of the line to be moved. Then press the + or – button. Each press of the + button moves the line up, while each press of the – button moves the line down.

Note

If you perform the procedure above while the cursor is on any other data other than the Time data, only the contents selected by the cursor will be moved. To move the entire line, be sure that the cursor is placed on the Time data.

Deleting a line

Press the cursor button to move the cursor to the line to be deleted, and then press the **[F5]** (DEL POINT) button while pressing down the SFT button. The line is deleted and all proceeding lines move up by one.

Displaying other information saved to the memory label

Press the **[F8]** (TAPE INFO) button. The TAPE INFORMATION window appears, showing other information concerning the videocassette.

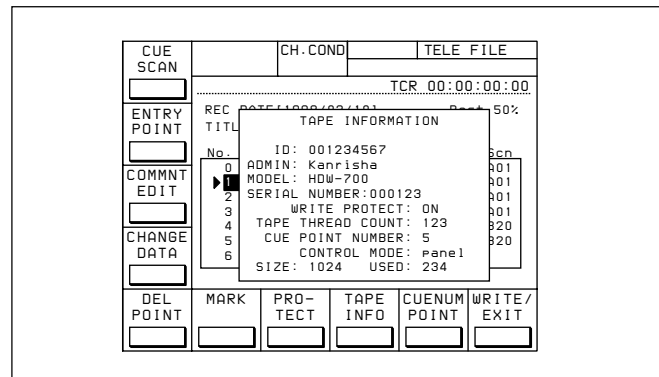

To close the window

Press the **[F8]** (TAPE INFO) button again.

To change ID or ADMIN data

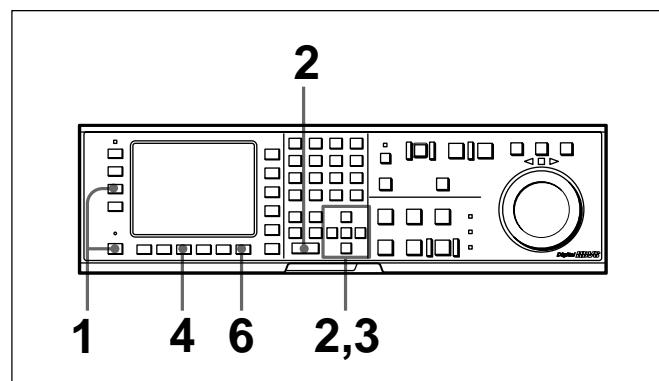

- 1 Press the ALT/**[F3]** (ATTRIB EDIT) buttons.

(Continued)

4-4 CUE Menu

- 2** Press the **[A]** or **g** button to select ID (tape ID) or ADMIN (administrator), then press the ENTRY button.

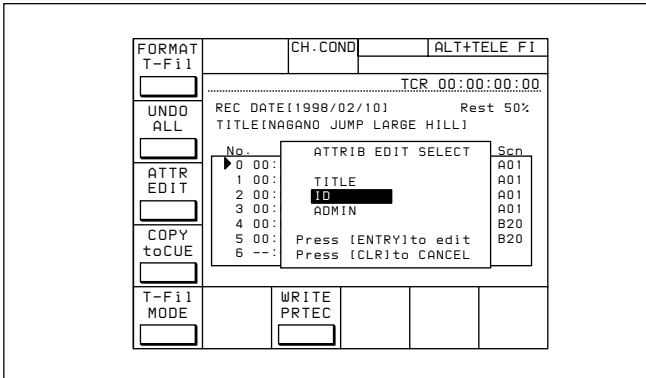

- 3** Press the **[←]** or **[→]** button to select a character.

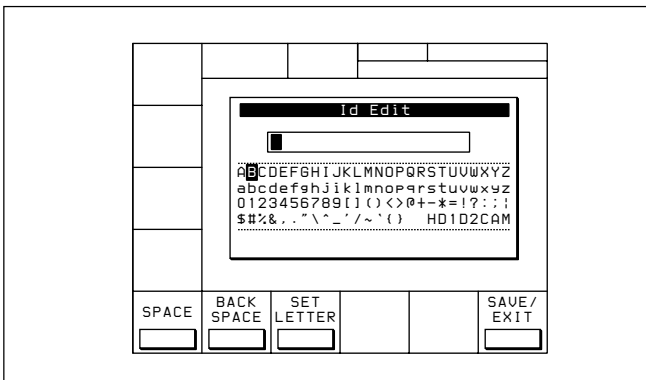

- 4** Press the **[F7]** (SET LETTER) button or the center cursor button.
The selected character is entered.

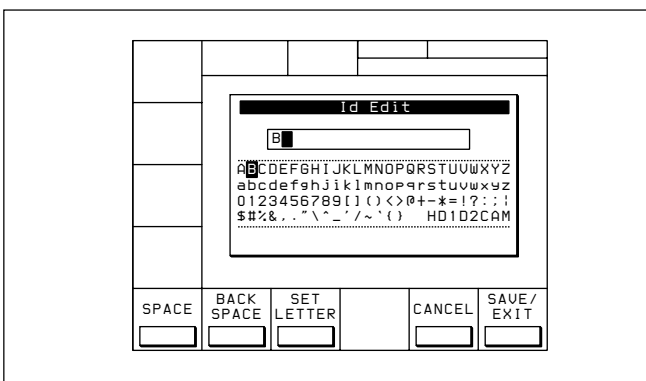

- 5** Repeat steps 3 and 4 to enter more characters.

To enter a space

Press the **[F5]** (SPACE) button.

If you enter a wrong character

Press the **[F6]** (BACK SPACE) button to go back.
Then re-enter the character.

To start the procedure over again

Press the **[F9]** (CANCEL) button to start again.

To change a character

Press the **[A]** button to move the cursor to the data to be changed. Then press the **[←]** or **[→]** button to move the insertion position.

If entered text is longer than the ID or ADMIN box

◀ or ▶ appears to the left or right of the box.

- 6** Press the **[F10]** (SAVE/EXIT) button.

The screen that was on before the cut data was changed is displayed again.

4-5 PF1 Menu (Factory Settings)

The PF (Personal Function) 1 menu is used to register frequently used menu items.

When shipped from the factory, the PF1 menu contains the adjustment menu for video signals. If you later use the PF1 menu to register items from other menus, you can restore the PF1 menu to its original factory settings by recalling SETUP BANK **F** from the VTR memory banks.

For details on registration methods, see Section 4-1-3, “Registering Items to the PF1/2 Menus” on page 4-3, and on restoring factory-set menu items, see Section 4-1-4, “VTR Memory Bank Function” on page 4-4.

To activate the PF1 menu screen

Press the PF1 button.

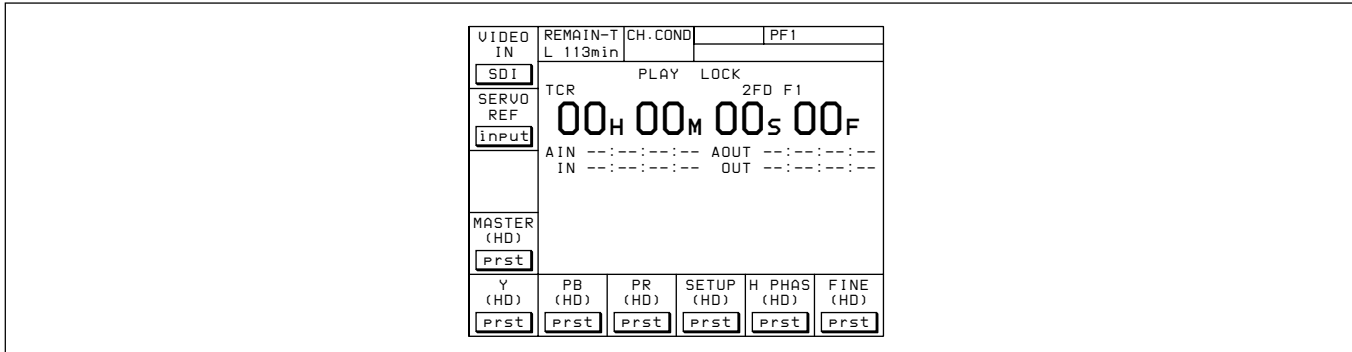

PF1 menu display
PF1 menu (factory settings)

Button	Indication	Function	Settings
[F1]	VIDEO IN	Selects the input video signal.	SDI, SDTI Note The SDTI selection is operative only when the optional HKDV-506A SDTI Board is installed.
[F2]	SERVO REF	Selects the reference signal for output.	ext, input, auto
[F4]	MASTER LEVEL (HD)	Adjusts the Y, P _B , and P _R output levels simultaneously.	prst, 0.0 to 141.3%
[F5]	Y LEVEL (HD)	Adjusts the Y output level.	prst, 0.0 to 141.3%
[F6]	P _B LEVEL (HD)	Adjusts the P _B output level.	prst, 0.0 to 141.3%
[F7]	P _R LEVEL (HD)	Adjusts the P _R output level.	prst, 0.0 to 141.3%
[F8]	SETUP LEVEL (HD)	Adjusts the setup level.	prst, -10.0 to +10.0
[F9]	SYNC PHASE (HD)	Adjusts the sync phase.	prst, -128 to +127
[F10]	FINE (HD)	Fine adjustment of the sync phase	prst, 0 to 1024
ALT/[F1]	MASTER LEVEL (D1)	Adjusts the Y, B-Y, and R-Y output levels simultaneously.	prst, 0.0 to 141.3%
ALT/[F2]	Y LEVEL (D1)	Adjusts the Y output level.	prst, 0.0 to 141.3%
ALT/[F3]	B-Y LEVEL (D1)	Adjusts the B-Y output level.	prst, 0.0 to 141.3%
ALT/[F4]	R-Y LEVEL (D1)	Adjusts the R-Y output level.	prst, 0.0 to 141.3%
ALT/[F5]	VIDEO LEVEL (D2)	Adjusts the video level.	prst, 0.0 to 141.3%
ALT/[F6]	CHROMA LEVEL (D2)	Adjusts the chroma level.	prst, 0.0 to 141.3%
ALT/[F7]	HUE (D2)	Adjusts the hue.	prst, -30 to +30
ALT/[F8]	SETUP LEVEL (D1/D2)	Adjusts the setup level.	prst, 0 to +10.0
ALT/[F9]	SYNC PHASE (SD)	Adjusts the sync phase.	prst, -128 to +127
ALT/[F10]	FINE (SD)	Fine adjustment of the sync phase	prst, 0 to 1024

4-5 PF1 Menu (Factory Settings)

4-5-1 Selecting the Input Video Signal (VIDEO IN)

Press the **[F1]** (VIDEO IN) button repeatedly to select the video signal to input.

SDI: SDI video signal input to the HD SDI INPUT connector

SDTI (Only if the optional HKDV-506A SDTI Board is installed.): Dubbing signal (270 Mbps) input to the SDTI (OPTION) IN connector.

Notes

The time codes to be recorded depend on the settings of the TC menu.

4-5-2 Selecting the Reference Signal (SERVO REF)

Press the **[F2]** (SERVO REF) button to select the signal to be used as the reference signal for VTR operations.

ext: The servoreference signal is forced to be EXT.

input: The signal from the HD SDI INPUT or SDTI (OPTION) IN is used as the reference signal for VTR operations. The **[F1]** (VIDEO IN) button switches the video input signal.

auto: During recording or edit preset, the signal from the HD SDI INPUT or SDTI (OPTION) IN is used as a reference signal. In all other cases, the servo operates using the signal setting of item 006.EXTERNAL REFERENCE select in the VTR SETUP menu. If the signal selected in 006.EXTERNAL REFERENCE select is not present, the servo operates using an internal reference.

4-5-3 Adjusting the Output Video Signal (MASTER LEVEL to FINE)

Adjusting the output video signal

Follow the procedure below to adjust the output video signal.

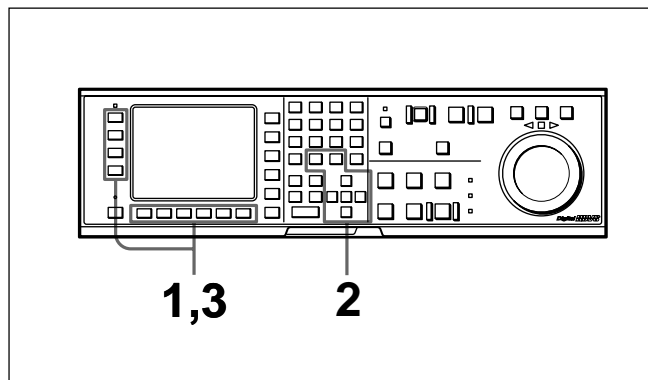

Adjusting the output video signal

- 1** Press the function button (**[F4]** to **[F10]**) whose setting you wish to set.
The setting display section lights up.
 - 2** Change the numerical value by pressing the **[Δ]** or **[▽]** button (or + or – button).
To change the value quickly, press the buttons while holding down the SFT button.
- To set the preset value**
Press the center cursor button.
prst appears over the respective function button.
- 3** Press the function button (**[F4]** to **[F10]**) after adjusting the numerical value.

Adjusting the master output level (HD)

Make this adjustment with the **[F4]** (MASTER LEVEL) button.

	100%(4000H)
	0.0to141.3%
	-∞to+3dB

Adjusting the Y output level (HD)

Make this adjustment with the **[F5]** (Y LEVEL) button.

	0.0to141.3%
	-∞to+3dB

Adjusting the P_B output level (HD)

Make this adjustment with the **[F6]** (PB LEVEL) button.

	100%(4000H)
	0.0to141.3%
	-∞to+3dB

Adjusting the P_R output level (HD)

Make this adjustment with the **[F7]** (PR LEVEL) button.

	100%(4000H)
	0.0to141.3%
	-∞to+3dB

Adjusting the setup level (HD)

Make this adjustment with the **[F8]** (SETUP LEVEL) button.

	0%(0)
	-100to+100
	-10to+10%

Adjusting the sync phase (HD)

Use this setting to precisely match the output phase of the VTR to the reference signal or when using a switcher or other device connected to another VTR to create special effects such as fading, wrapping, and dissolving.

To adjust the output signal sync phase with respect to the reference input, make this adjustment with the **[F9]** (SYNC PHASE) button.

	0(0)
	-128to+127
	-1.4to+1.4H

Fine adjustment of the sync phase (HD)

Make this adjustment with the **[F10]** (FINE) button.

	0(0)
	0to1024
	0to323nsec

Adjusting the master output level (D1)

Make this adjustment with the ALT/**[F1]** (MASTER LEVEL) buttons.

prst: 100% (4000H)

	0.0to141.3%
	-∞to+3dB

Adjusting the Y output level (D1)

Make this adjustment with the ALT/**[F2]** (Y LEVEL) buttons.

	100%(4000H)
	0.0to141.3%
	-∞to+3dB

Adjusting the B–Y output level (D1)

Make this adjustment with the ALT/**[F3]** (B–Y LEVEL) buttons.

	100%(4000H)
	0.0to141.3%
	-∞to+3dB

4-5 PF1 Menu (Factory Settings)

Adjusting the R–Y output level (D1)

Make this adjustment with the ALT/[F4] (R–Y LEVEL) buttons.

	100%(4000H)
	0.0to141.3%
	-∞to+3dB

Adjusting the video output level (D2)

Make this adjustment with the ALT/[F5] (VIDEO LEVEL) buttons.

	100%(4000H)
	0.0to141.3%
	-∞to+3dB

Adjusting the chroma output level (D2)

Make this adjustment with the ALT/[F6] (CHROMA GAIN) buttons.

	100%(4000H)
	0.0to141.3%
	-∞to+3dB

Adjusting the hue (D2)

Make this adjustment with the ALT/[F7] (HUE) buttons.

	0°(0)
	-30to+30
	-30°to+30°

Adjusting the setup level (D2)

Make this adjustment with the ALT/[F8] (SETUP LEVEL) buttons.

	7.5IRE(7.5)
	0to+100
	0to+10.0IRE

Adjusting the sync phase (D1/D2)

Use this setting to precisely match the output phase of the VTR to the reference signal or when using a switcher or other device connected to another VTR to create special effects such as fading, wrapping, and dissolving.

To adjust the output signal sync phase with respect to the reference input, make this adjustment with the ALT/[F9] (SYNC PHASE) buttons.

	0(0)
	-128to+127
	-0.5to+0.5H

Fine adjustment of the sync phase (D1/D2)

Make this adjustment with the ALT/[F10] (FINE) buttons.

	0(0)
	0to1024
	0to296nsec

4-6 PF2 Menu (Factory Settings)

The PF2 menu is used to register frequently used menu items.

When shipped from the factory, the PF2 menu contains the adjustment menu for audio signals. If you later use the PF2 menu to register items from other menus, you can restore the PF2 menu to its original factory settings by recalling SETUP BANK **F** from the VTR memory banks.

For details on registration methods, see Section 4-1-3, “Registering Items to the PF1/2 Menus” on page 4-3, and on restoring factory-set menu items, see Section 4-1-4, “VTR Memory Bank Function” on page 4-4.

To activate the PF2 menu screen

Press the PF2 button.

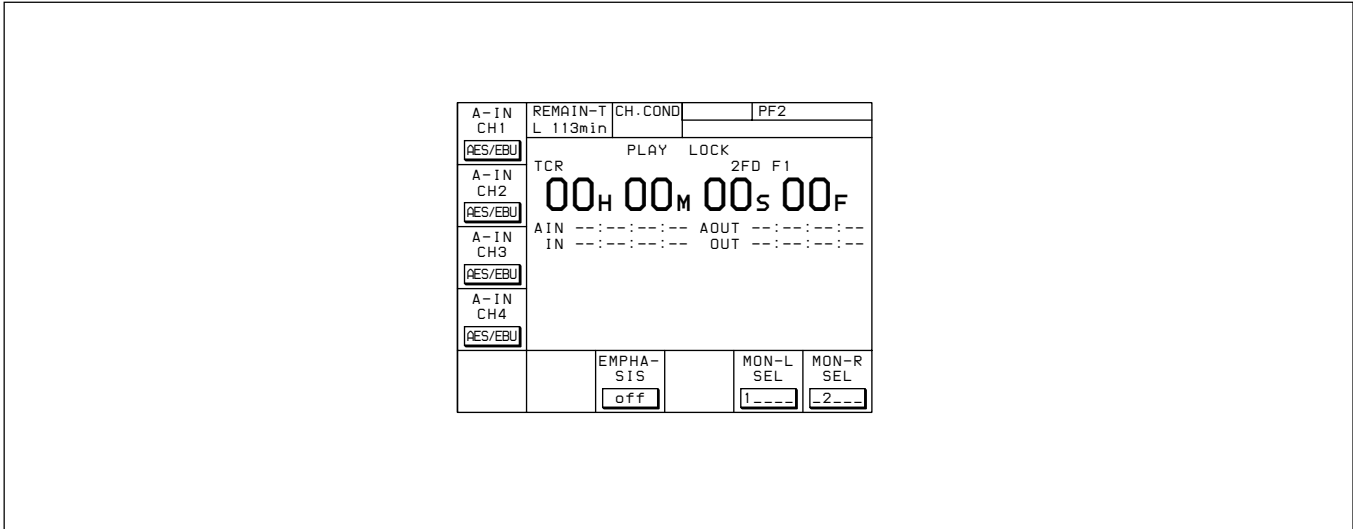

PF2 menu display

PF2 menu (factory settings)

Button	Indication	Function	Settings
[F1]	A-IN CH1	Selects the audio input signal for audio channel 1.	Note When the dubbing signal input to the SDTI (OPTION) IN connector is selected for the input video signal, the SDTI signal input to the SDTI (OPTION) IN connector is automatically selected for the input audio signal as well. The setting can not be changed.
[F2]	A-IN CH2	Selects the audio input signal for audio channel 2.	
[F3]	A-IN CH3	Selects the audio input signal for audio channel 3.	
[F4]	A-IN CH4	Selects the audio input signal for audio channel 4.	
[F7]	EMPHASIS	Sets the emphasis.	off, on
[F9]	MON-L SEL	Selects the monitor output signal for channel L.	Combination of 1, 2, 3, 4, 5
[F10]	MON-R SEL	Selects the monitor output signal for channel R.	Combination of 1, 2, 3, 4, 5

4-6 PF2 Menu (Factory Settings)

4-6-1 Selecting the Audio Input Signal (A-IN CH-1~CH4)

Function buttons **[F1]** (A-IN CH1) to **[F4]** (A-IN CH4) select the audio input signal for the various channels.

SDI: Selects the audio signal input through the HD SDI INPUT connector.

AES/EBU: Selects the audio signal input through the AUDIO INPUT (AES/EBU) connectors.

anlg Selects the audio signal input through the AUDIO INPUT connectors.

[SDTI] (Only when the optional HKDV-506A SDTI Board is installed.): When the SDTI signal input to the SDTI (OPTION) IN connector is selected for the input video signal, the audio signal input to the SDTI (OPTION) IN connector is automatically selected for the input audio signal as well. SDTI is displayed and can not be changed.

4-6-2 Setting Emphasis (EMPHASIS)

To apply emphasis to a digital audio signal that has been converted from an analog input audio signal, set the **[F7]** (EMPHASIS) button to on.

4-6-3 Selecting the Monitor Output Signal (MON-L SEL/MON-R SEL)

The **[F9]** (MON-L SEL) and **[F10]** (MON-R SEL) buttons allow you to specify the audio channel to be output from the left and right MONITOR OUTPUT connectors, respectively.

- 1:** Audio channel 1
- 2:** Audio channel 2
- 3:** Audio channel 3
- 4:** Audio channel 4
- 5:** Analog cue channel

When multiple channels are selected for a single connector, all of the numbers are displayed. Select the output signal to be monitored as follows:

Making the setting

Follow the steps below to set the monitor output signal.

- 1** Press the **[F9]** (MON-L SEL) or **[F10]** (MON-R SEL) button.
The setting display section lights up.
- 2** Press numeric buttons 1 to 4 to select audio channels 1 to 4, or numeric button 5 for the analog cue channel.
Example: Pressing numeric buttons 1 and 2 selects audio channels 1 and 2, leaving audio channels 3 and 4, and the analog cue channel off.
“12...” appears in the display.
- 3** To set the entered audio channels, press the respective function button (**[F9]** or **[F10]**).

4-7 SET UP Menu

In the SET UP menu, you can store and recall menu settings to and from the VTR memory banks and memory card, register items to the PF menu, and set items in the VTR SETUP menu and PANEL SETUP menu.

To activate the SET UP menu

Press the SET UP button.

To change the SET UP menu page

Press the ALT button.

For details on storing and recalling data to or from the VTR memory banks or memory card, and registering items to the PF menus, see Section 4-1, “Registering and Storing Menu Settings” on page 4-1.

“▼” indicates that more than one menu page exists.

UTR BANK	REMAIN-T L 113min	CH. COND	SETUP	
▼			
MEMORY CARD	[F1]UTR BANK: Copy data between current setup and 8 banks.			
▼	[F2]MEMORY CARD: Copy data between UTR and memory card.			
	[F4]PF1&2 ASSIGN: Assign PF1/PF2 menu function keys.			
PF1&2 ASSIGN	[F5]PANEL SETUP: Panel settings			
▼	[F6]VTR SETUP: VTR current setup			
PANEL SETUP	UTR SETUP		REMOTE 9-PIN	REMOTE 50-PIN
▼	▼		off	off

SET UP menu display

SET UP menu

Button	Indication	Function	Settings
[F1]	VTR BANK	See Section 4-1-4, “VTR Memory Bank Function” on page 4-4.	
[F2]	MEMORY CARD	See Section 4-1-5, “Memory Card Function” on page 4-6.	
[F4]	PF1&2 ASSIGN	See Section 4-1-3, “Registering Items to the PF1/2 Menus” on page 4-3.	
[F5]	PANEL SETUP	See Section 4-7-2, “PANEL SETUP Menu” on page 4-63.	
[F6]	VTR SETUP	See Section 4-7-1, “VTR SETUP Menu” on page 4-61.	
[F8]	REMOTE 9-PIN	Selects remote operation through a device connected to the REMOTE1-IN(9P)/OUT(9P) connectors.	on, off
[F9]	REMOTE 50-PIN	Selects remote operation using a device (optional BKDW-509) connected to the PARALLEL I/O(50P) connector.	on, off

4-7 SET UP Menu

Selecting remote operation mode

When operating the VTR with an external device, set the **[F8]** (REMOTE 9-PIN) button or **[F9]** (REMOTE 50-PIN) button to on.

When the **[F8]** (REMOTE 9-PIN) button is set to on

You can operate the VTR with a device connected to the REMOTE1-IN(9P)/OUT(9P) connectors.

When the **[F9]** (REMOTE 50-PIN) button is set to on

You can operate the VTR with a device (optional BKDW-509) connected to the PARALLEL I/O(50P) connector.

Note

When operating the VTR through an external device, all of the tape operation and editing buttons are disabled, with the exception of the STOP and EJECT buttons. You may also set the VTR so that all buttons are enabled or disabled. Perform this setting through 008. LOCAL FUNCTION ENABLE of the VTR SETUP menu. You cannot, however, disable the menu and remote operation mode selection buttons.

4-7-1 VTR SETUP Menu

All menu items required for setting up the VTR operating conditions are displayed in the scrollable VTR SETUP menu.

Items which are frequently used can be registered in the PF1/2 menus. Those items that can be registered in a PF menu are displayed in the scrollable PF1&2 ASSIGN menu.

To activate the VTR SETUP menu

Press the SET UP button, then press the **[F6]** (VTR SETUP) button.

For details on the VTR SETUP menu items, see the Appendix "Menu List" on page A-15.

For details on registering items to the PF1/2 menus, see Section 4-1-3, "Registering Items to the PF1/2 Menu" on page 4-3.

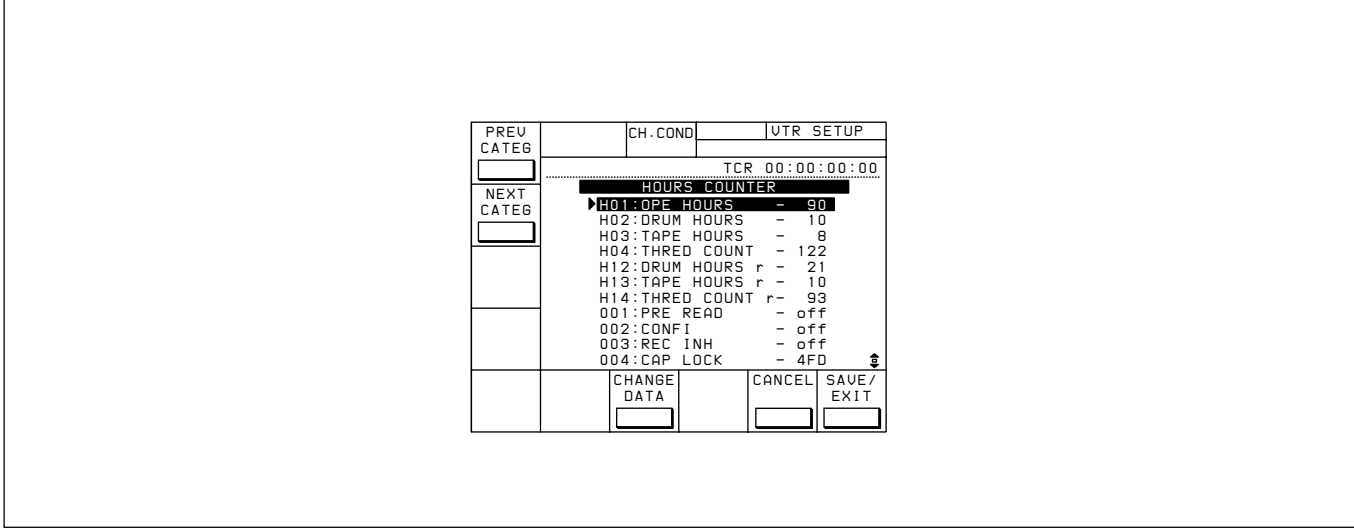

VTR SETUP menu display

VTR SETUP menu

Button	Indication	Function
[F1]	PREV CATEG	Moves to the beginning of the previous category.
[F2]	NEXT CATEG	Moves to the beginning of the next category.
[F7]	CHANGE DATA	Changes the setting.
[F9]	CANCEL	Cancel the setting operation.
[F10]	SAVE/EXIT	Sets the value and exits the VTR SETUP menu.

4-7 SET UP Menu

Scrolling items in the VTR SETUP menu

Press the **[▲]** and **[▼]** to scroll the items in the VTR SETUP menu.

To search the menu by category

Items in the VTR SETUP menu are divided into categories according to type of settings they perform.

Menu number	Category
H01~	Items related to the hours meter
001~	Items related to VTR operations
101~	Items related to operation panels
201~	Items related to remote interface
301~	Items related to editing
401~	Items related to prerolling
501~	Items related to recording protection
601~	Items related to the time code generator
701~	Items related to the video control
801~	Items related to the audio control
901~	Items related to digital process
A01~	Items related to pull down control
T01~	Other

Pressing the **[F1]** (PREV CATEG) button selects the first item of the previous category.

Pressing the **[F2]** (NEXT CATEG) button selects the first item of the next category.

Changing settings

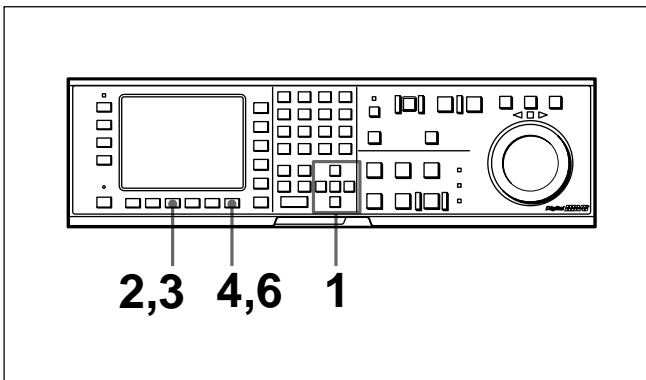

Changing settings

1 Press the **[▲]** or **[▼]** button to move the cursor (▶) to the item to be changed.

2 Press the **[F7]** (CHANGE DATA) button. The window for changing settings appears.

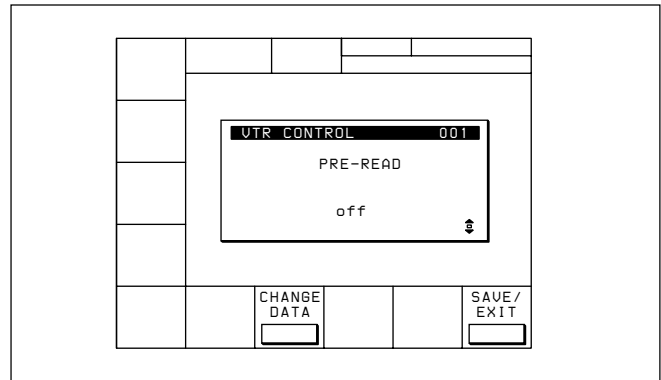

3 Press the **[F7]** (CHANGE DATA) button or the **[▲]** or **[▼]** button repeatedly to select the new setting. When sub-items appear, change the setting as required with the **[▲]** or **[▼]** button, then press the **[F7]** (CHANGE DATA) button repeatedly.

4 Press the **[F10]** (SAVE/EXIT) button. The new value is set and the window for changing settings disappears.

5 Repeat Steps **1** to **4** to change more settings.

6 Press the **[F10]** (SAVE/EXIT) button again. The new settings are saved and the SETUP menu display appears again.

4-7-2 PANEL SETUP Menu

The PANEL SETUP menu is used to set the operation conditions of the upper and lower control panels.

To activate the PANEL SETUP menu
 Press the SET UP button, then press the **[F5]** (PANEL SETUP) button.

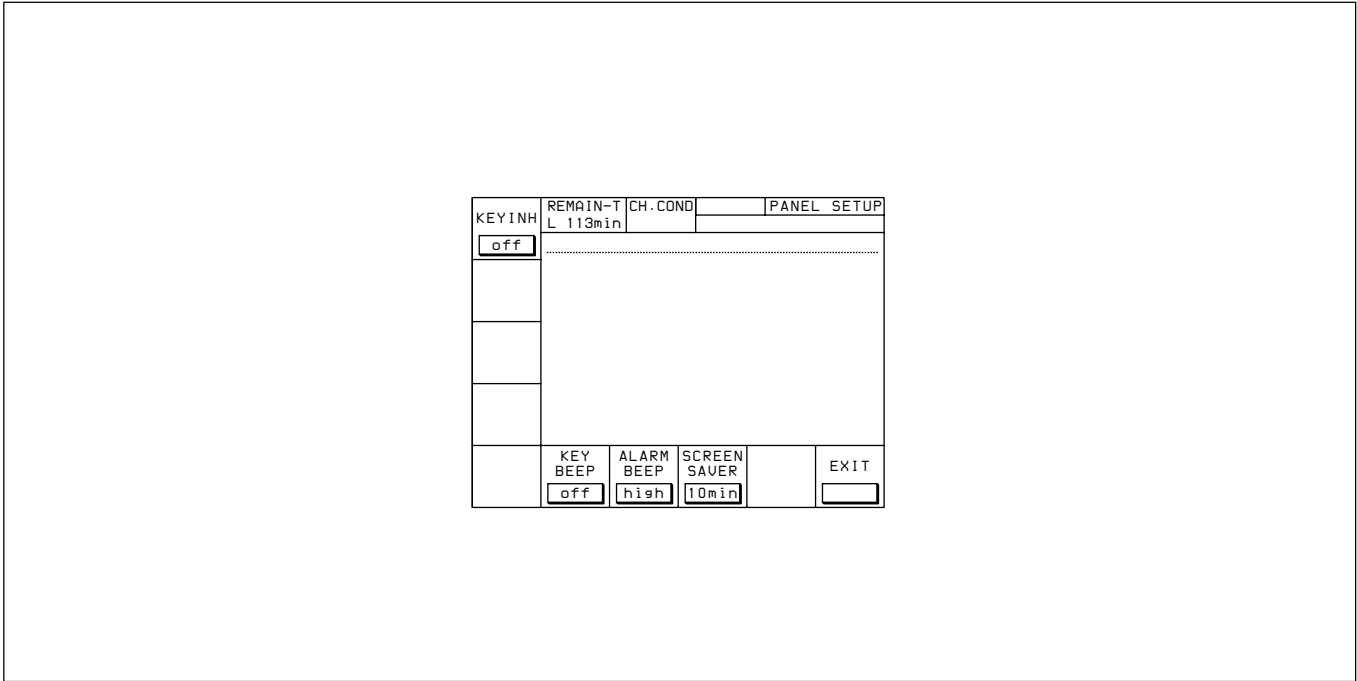

PANEL SETUP menu display

PANEL SETUP menu

Button	Indication	Function	Settings
[F1]	KEYINH	Disables all button operations.	on, off
[F6]	KEY BEEP	Sets the keyboard sound.	high, low, off
[F7]	ALARM BEEP	Sets the alarm.	high, low, off
[F8]	SCREEN SAVER	Sets the screen-saver.	3min, 10min, 60min, off
[F10]	EXIT	Exits the PANEL SETUP menu.	

4-7 SET UP Menu

Disabling the upper and lower control panel buttons

Set the **F1** (KEYINH) button to on.

You can select buttons to be disabled through 110. KEY INHIBIT SWITCH EFFECTIVE AREA in the VTR SETUP menu.

Setting the keyboard sound

Press the **F6** (KEY BEEP) button repeatedly.

high: The keyboard sound is loud.

low: The keyboard sound is weak.

off: The keyboard sound is off.

Setting the alarm

Press the **F7** (ALARM BEEP) button repeatedly.

high: The alarm sound is loud.

low: The alarm sound is weak.

off: The alarm sound is off.

Setting the elapsed time until screen-saver activated time

Press the **F8** (SCREEN SAVER) button repeatedly.

3min: The screen-saver goes on 3 minutes after the last button operation.

10min: The screen-saver goes on 10 minutes after the last button operation.

60min: The screen-saver goes on 60 minutes after the last button operation.

off: The screen-saver function is off.

5-1 Preparing for Recording

5-1-1 Setting Switches and Menus

Before recording, set the switches and menus as shown in the diagram below.

For details, refer to the pages indicated in the parentheses.

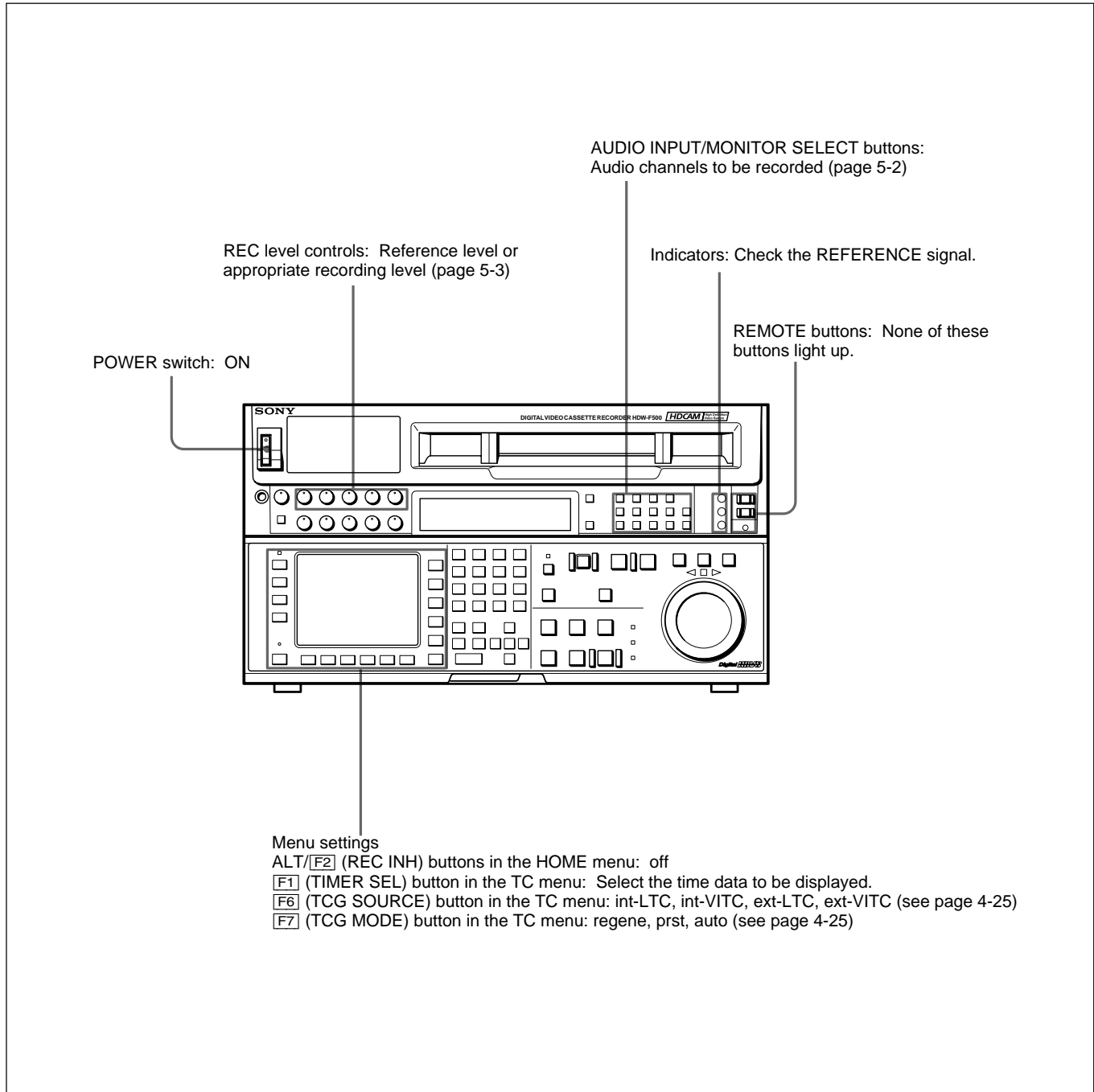

Setting switches and menus

5-1 Preparing for Recording

5-1-2 Selecting Audio Signals

This section describes how to select the audio signals for input and monitoring.

Selecting the audio input signals

Press the AUDIO INPUT/MONITOR SELECT buttons on the upper control panel as follows to select the audio input signal and channels.

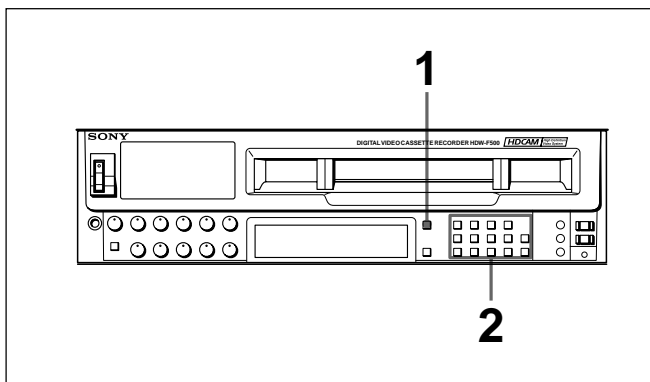

Selecting the audio input signals

- 1 Press the INPUT SELECT button so that it lights up.
The AUDIO INPUT/MONITOR SELECT button(s) light(s) up to indicate the audio input signal type and the currently selected audio channel.
- 2 Select the signals to be input and the channels by pressing the following buttons:
 - HD SDI CH-1 to CH-4 buttons: Select audio input through HD SDI INPUT connector. (Channels 1 through 4)
 - AES/EBU CH-1 to CH-4 buttons: Select audio channels 1 to 4 input through the AUDIO INPUT (AES/EBU) connectors.
 - ANALOG CH-1 to CH-4 buttons: Select audio channels 1 to 4 through the AUDIO INPUT connectors.

This setting can also be made in the VTR SETUP menu using items 802.AUDIO INPUT SELECT channel CH-1 through 805.AUDIO INPUT select CH-4.

Note

If item 701.VIDEO INPUT select in the VTR SETUP menu is set to SDTI, the audio input signal on the SDTI (OPTION) IN connector will automatically be used as the input audio signal and AUDIO INPUT/MONITOR SELECT buttons become unlit. The SDTI setting is operative only when the optional HKDV-506A SDTI Board is installed.

Selecting audio signals to be monitored

Press the AUDIO INPUT/MONITOR SELECT buttons on the upper control panel as follows to select the audio signals output to the PHONES jack and the MONITOR OUTPUT L and R connectors.

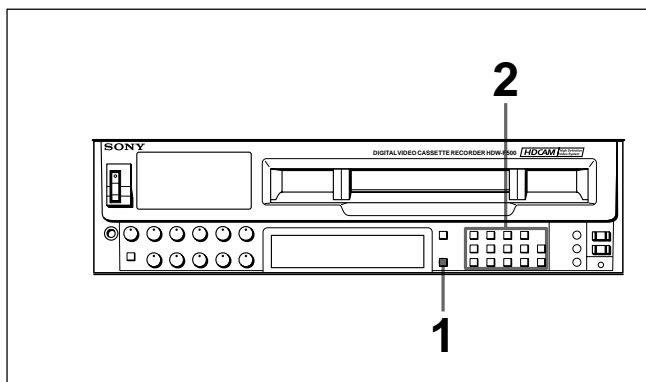

Selecting audio signals to be monitored

- 1 Press the MONITOR SELECT button so that it lights up.
The AUDIO INPUT/MONITOR SELECT button(s) light(s) up to indicate the audio input signal type and the channel(s) being monitored.
- 2 Press the button(s) for the audio signal and the channel(s) to be output to the PHONES jack and the MONITOR OUTPUT L and/or R connector(s).

This setting can also be made in the VTR SETUP menu using items 807.AUDIO MONITOR-L select and 808.AUDIO MONITOR-R select.

To adjust the audio output level of the PHONES jack

Rotate the PHONES level control on the upper control panel.

To adjust the audio output level of the MONITOR OUTPUT connectors

You can make an initial settings to allow the audio output level of the MONITOR OUTPUT connector to be adjusted with the PHONES level control on the upper control panel.

For more information, refer to the supplied Maintenance Manual.

Selecting non-audio data as the audio input signal

Do the procedure below to select non-audio data such as a Dolby¹⁾ E or Dolby Digital (AC-3²⁾) signal as the audio input signal.

- 1 Use item 819.NO AUDIO MODE Select and item 820.NON AUDIO Channel Select to select the audio input signal.

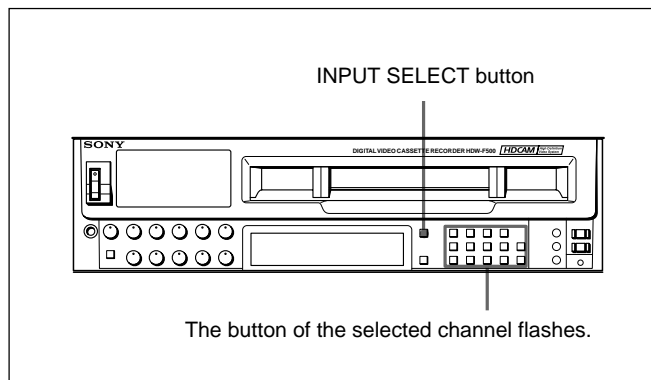

- 2 Press the INPUT SELECT button and verify that the flashing AUDIO INPUT/MONITOR SELECT button matches the channel selected in step 1.

Notes

When you select non-audio data as the audio input signal:

- The audio input signal cannot be switched.
- The “OVER” indication on the audio level meters flashes.
- Analog audio output to the main line, monitor, and the headphones are muted.
- The recording level cannot be adjusted using the REC level controls.

5-1-3 Adjusting the Audio Recording Level

Adjusting the recording level

Recording with the reference level

If the REC level controls on the upper control panel are pushed in, audio signals are recorded at the reference level (0 dB reference level indicated in the audio level meters for +4 dBm input).

Recording with the specific recording level

Pull out the REC level controls for the appropriate channels and rotate them so that the audio level meters indicate approximately 0 dB for the average audio signal input level.

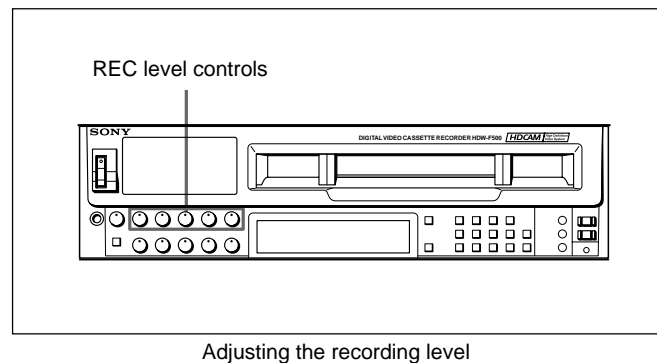

Selecting the display range of the audio level meters

You can switch the range of audio level meters display by pressing the DISPLAY FULL/FINE button on the upper control panel.

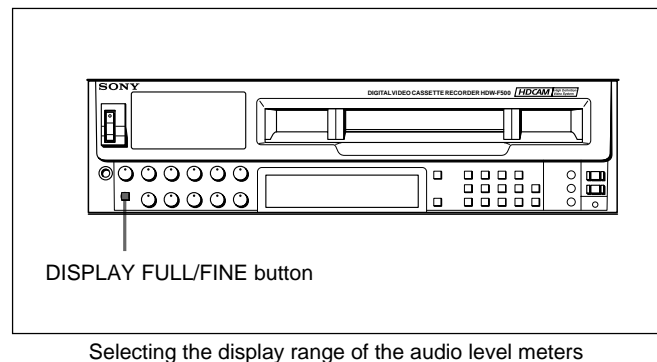

1) Dolby is a trademark of Dolby Laboratories.
2) AC-3 is a trademark of Dolby Laboratories.

5-1 Preparing for Recording

FULL mode: The meter range is -60 to 0 dB or -40 to +20 dB.

FINE mode: The meter scale is enlarged, and the signal level is indicated in 0.25 dB steps, with the reference marker indicated by a lit LED in the middle of each meter.

The display range of the audio level meters in FULL mode can be set with 814.LEVEL METER SCALE in the VTR SETUP menu.

5-1-4 Simultaneously Monitoring Playback of Video and Audio Signals Being Recorded

Monitoring signals being recorded

Using the 017.PB/EE SELECT MENU settings, the audio and video signals currently being recorded can be simultaneously checked.

To check video and audio signals during recording

In the VTR SETUP menu, set 017.PB/EE SELECT MENU to PB/PB. Both audio and video playback signals are output.

To check video and audio signals during editing

In the VTR SETUP menu, set 017.PB/EE SELECT MENU to PB/PB. Both audio and video playback signals are output.

Monitoring previously recorded video and audio signals while recording

To monitor previously recorded audio and video signals while recording (preread function), press the ALT button in the HOME menu, then press the **[F1]** (PRE READ) button.

For details, see Section 4-2-4, "Preread Setting (PRE READ)" on page 4-17.

5-1-5 Recording Analog Audio

Recording with emphasis

You can emphasize analog audio signals that are recorded from the AUDIO INPUT connectors. When the emphasis is removed during playback, high frequency noise is effectively eliminated without affecting the original signal.

To use the emphasis function, set item 806.AUDIO EMPHASIS in the VTR SETUP menu to on. During playback, regardless of this setting, only signals to which emphasis have been applied are automatically de-emphasized.

5-2 Recording

To record, follow the procedure below.

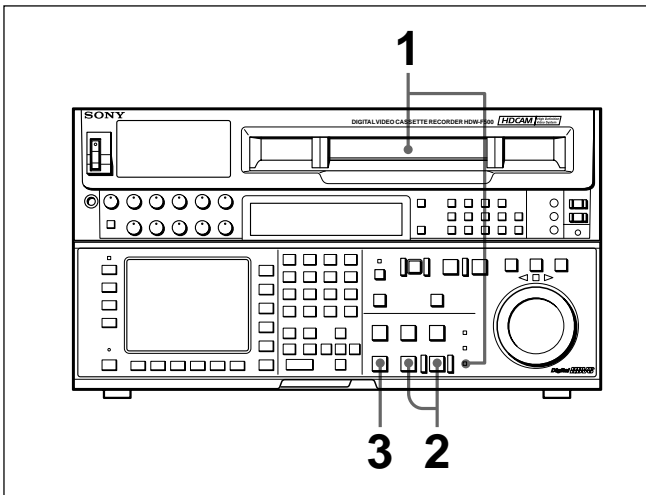

Recording

- 1 Check that the REC INHIBIT indicator is off, then insert a cassette.

For details on inserting a cassette, see Section 3-3-2, "Inserting and Ejecting Cassettes" on page 3-8.

- 2 Press the PLAY button while holding down the REC button.
Recording starts and the SERVO indicator lights up to indicate that the servo is locked.

- 3 Press the STOP button to stop recording.

If the recording continues to the end of the tape

If item 407. AUTO REWIND in the VTR SETUP menu is set to ON, then the tape automatically rewinds to the beginning and stops.

5-3 Preparing for Playback

5-3-1 Setting Switches and Menus

Before starting playback, set the switches and menus as shown in the diagram below.

For details, refer to the pages indicated in the parentheses.

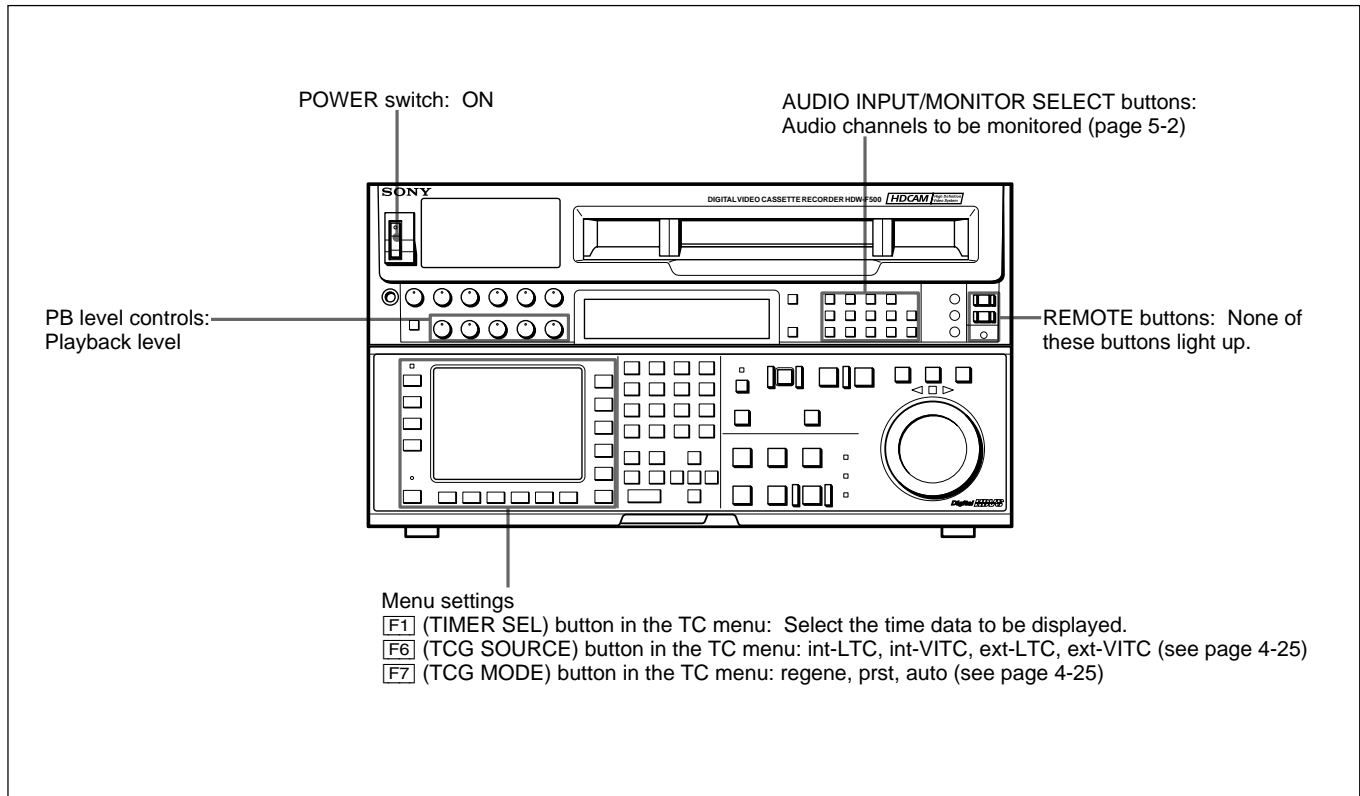

Setting switches and menus

5-3-2 Adjusting the Audio Playback Level

If the PB level controls on the upper control panel are pushed in, audio signals are output at the factory-set level (+4 dBm output for signals recorded at the 0 dB reference level).

For details on changing the factory-set reference output level, refer to the supplied Maintenance Manual.

To adjust the audio playback level manually

Pull and rotate the PB level control for the corresponding channel.

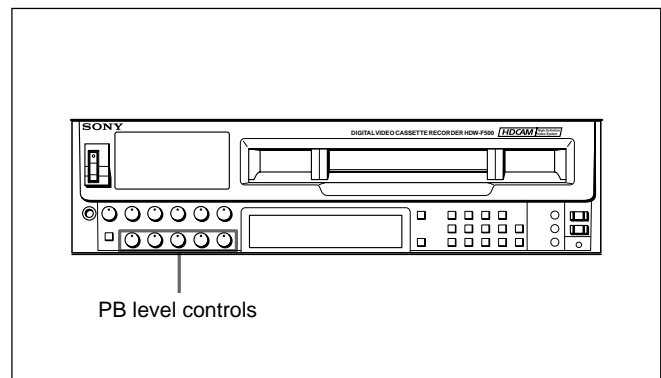

To adjust the audio playback level manually

5-3-3 Selecting the HD-SD Conversion Mode (when HKDV-501A is installed)

When the optional HKDV-501A HD-SD Converter Board is installed in the HDW-F500, the conversion mode can be selected with setting the VTR SETUP menu 754. DOWNCONVERTER MODE.

• Edge crop (CROP)

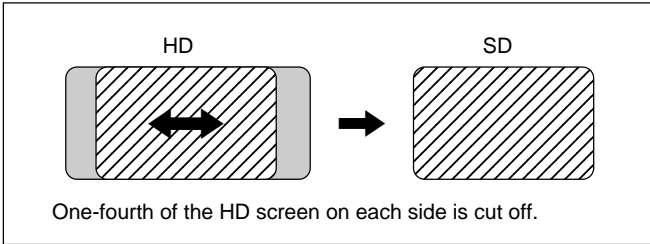

Horizontal adjustment of the edge cropping
Adjust the 766.H CROP POSITION setting in VTR SETUP menu.

• Letter box mode (LETTER BOX)

When the letter box mode is selected, you can select one of the following conversion methods through item 778.LETTER BOX MODE in the VTR SETUP menu.

When 16:9 is selected

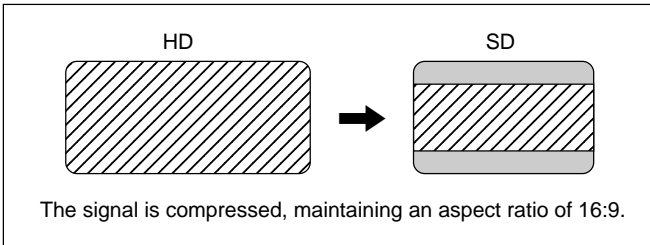

When 14:9 is selected

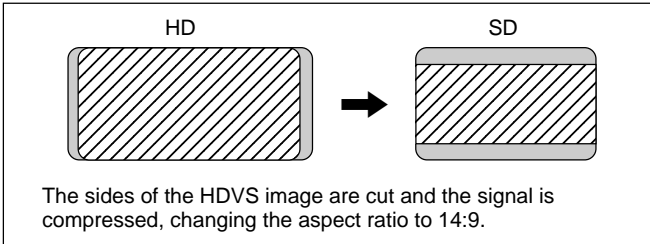

When 13:9 is selected

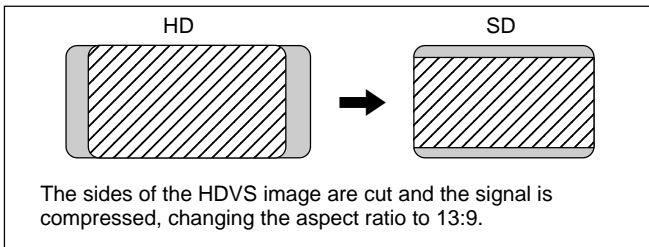

• Squeeze mode (SQUEEZE)

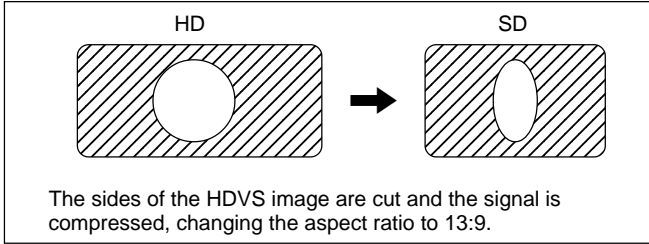

5-3 Preparing for Playback

5-3-4 Selecting the Conversion Mode of the Effective Scanning Line Number (when HKDV-502 is installed)

When the optional HKDV-502 HD Line Converter Board is installed in the HDW-F500, to select the conversion mode, follow the procedure below.

- 1 Press the MAINTENANCE switch using the tip of a small pointed object.

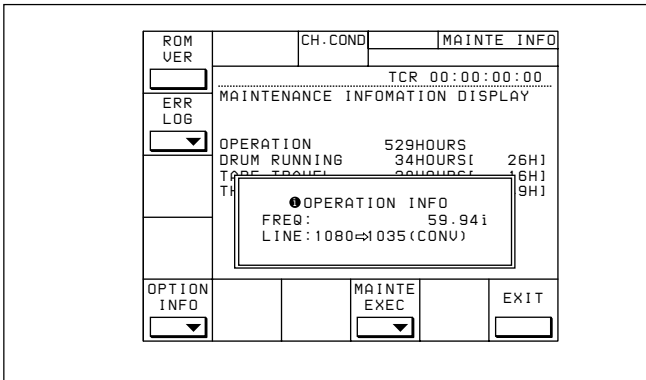

- 2 Press the [F8](MAINTENANCE EXEC) button while holding down the SFT button.

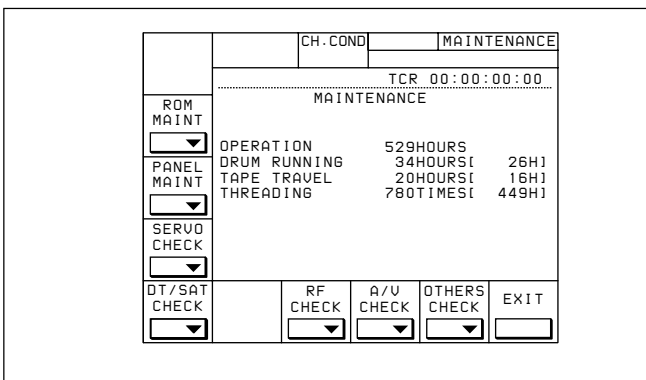

- 3 Press the [F9](OTHERS CHECK) button.

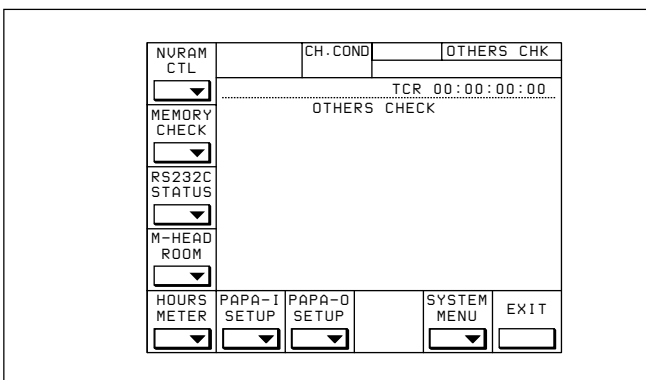

- 4 Press the [F9](SYSTEM MENU) button.

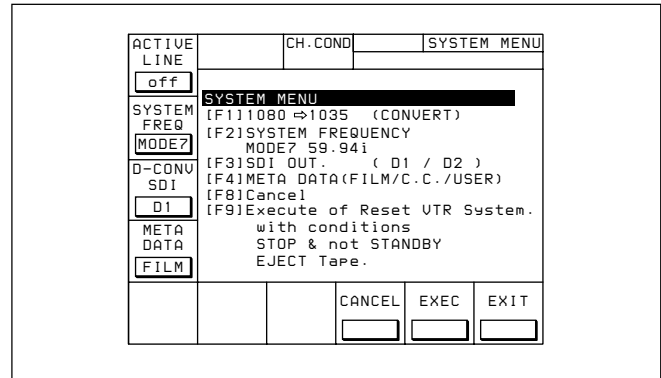

- 5 Press the [F1](ACTIVE LINE) button to select the conversion mode.
Pressing the button cycles the settings from 1035, 1080, off. off is used to activate the function to improve the vertical resolution during slow-motion playback.
1035: Convert the effective scanning line number from 1080 to 1035.
1080: Convert the effective scanning line number from 1035 to 1080.

- 6 Press the [F9](EXEC).
A message asking you to confirm the operation appears in the display.

To cancel the execution

Press the [F8](CANCEL) button.

- 7 Press the [F9](EXEC).
The HDW-F500 is restarted automatically.

- 8 Press the SET UP button.
The VTR SETUP menu appears in the display.

9 Select the conversion mode in the VTR SETUP menu below.

• **When 1035 is selected in the procedure 5.** Select the conversion mode using the 730.ACTIVE LINE 1035 CONVERT MODE setting in the VTR SETUP menu.

1080⇒1035(CONV): Convert the effective scanning line number from 1080 to 1035 preserving the aspect ratio of the image.

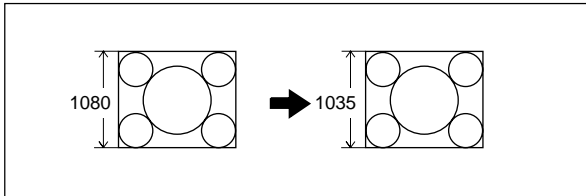

1080⇒1035(CROP): Convert the effective scanning line number from 1080 to 1035. The four sides of the image are cropped, then it is horizontally expanded.

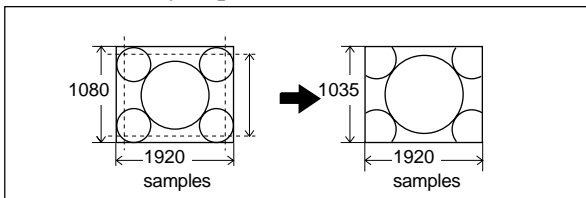

• **When 1080 is selected in the procedure 5.** Select the conversion mode using the 731.ACTIVE LINE 1080 CONVERT MODE setting in the VTR SETUP menu.

1035⇒1080(CONV): Convert the effective scanning line number from 1035 to 1080 preserving the aspect ratio of the image.

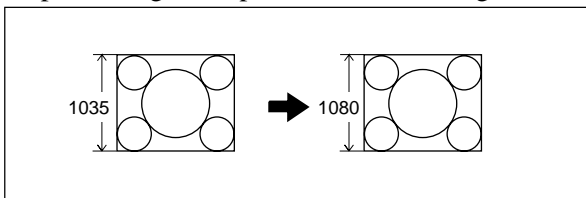

1035⇒1080(PANEL): Convert the effective scanning line number from 1035 to 1080. The 1035 lines of the image are inserted into the 1080 lines of 1080 lines, then it is horizontally compressed.

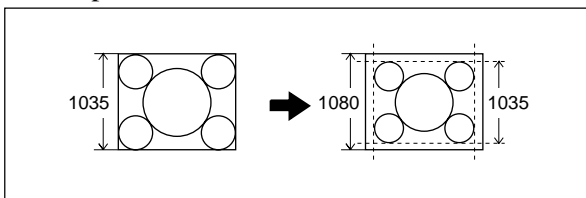

5-3-5 Improving the Vertical Resolution during Slow-Motion Playback (when HKDV-502 is installed)

When the optional HKDV-502 HD Line Converter Board is installed in the HDW-F500, to activate the function to improve the vertical resolution during slow-motion playback, follow the procedure below.

1 Press the MAINTENANCE switch using the tip of a small pointed object.

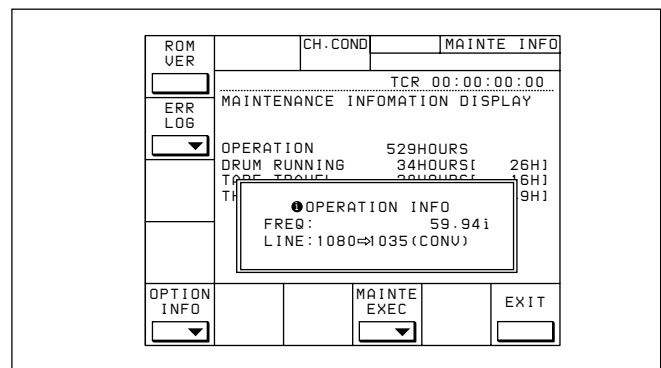

2 Press the [F8] (MAINTEN EXEC) button while holding down the SFT button.

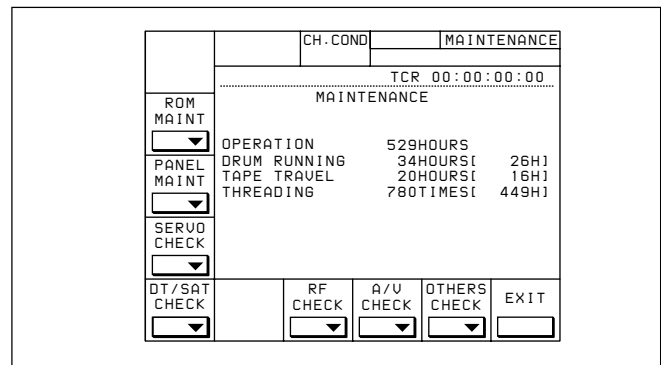

3 Press the [F9] (OTHERS CHECK) button.

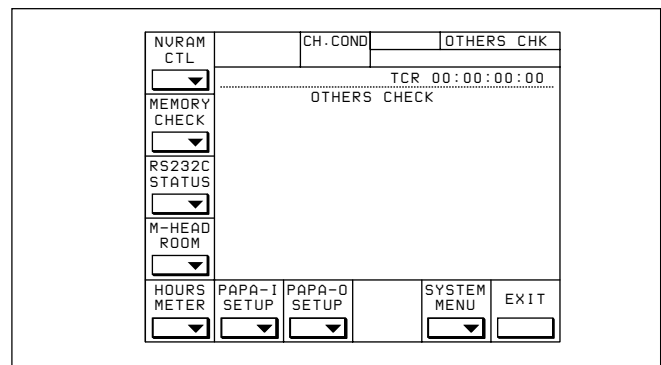

(Continued)

5-3 Preparing for Playback

- 4 Press the **[F9]**(SYSTEM MENU) button.

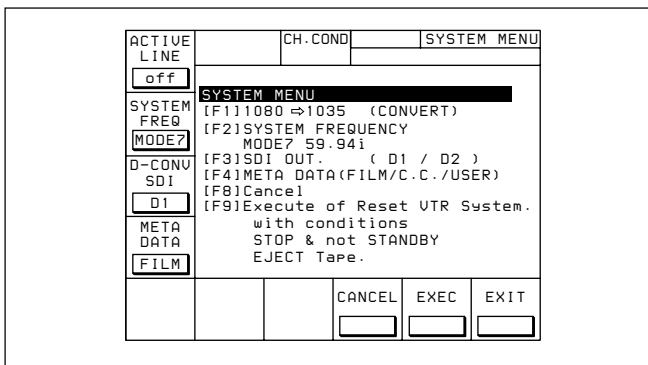

- 5 Press the **[F1]**(ACTIVE LINE) button to select off. Pressing the button cycles the settings from 1035, 1080, off.

1035 and 1080 are used to activate the function to convert the effective scanning line number.

- 6 Press the **[F9]**(EXEC).

A message asking you to confirm the operation appears in the display.

To cancel the execution

Press the **[F8]**(CANCEL) button.

- 7 Press the **[F9]**(EXEC).

The HDW-F500 is restarted automatically.

- 8 Press the SET UP button.

The VTR SETUP menu appears in the display.

- 9 Select on in the 732.SLOW PROCESS MODE of the VTR SETUP menu.

on: Improve the vertical resolution during slow-motion playback.

off: Do not improve the vertical resolution during slow-motion playback.

5-4 Playback

There are four types of playback:

- Normal-speed playback
- Jog/Shuttle/Variable mode playback
- Capstan override playback
- DMC (Dynamic Motion Control) playback

5-4-1 Normal-Speed Playback

Follow the procedure below to play back at normal speed.

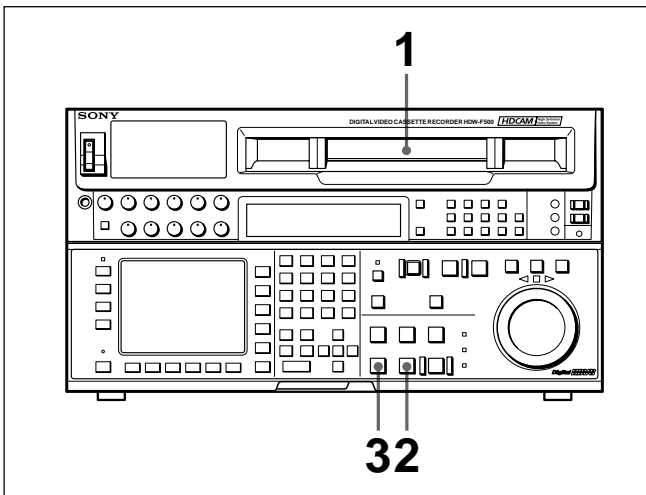

Normal-speed playback

1 Insert a cassette.

For details on inserting a cassette, see Section 3-3-2, "Inserting and Ejecting Cassettes" on page 3-8.

2 Press the PLAY button.
Playback starts and the SERVO indicator lights up to indicate that the servo is locked.

3 Press the STOP button to stop playback.

If playback continues to the end of the tape

If item 407. AUTO REWIND in the VTR SETUP menu is set to ON, then the tape automatically rewinds to the beginning and stops.

5-4-2 Variable Speed Playback

In Jog/Shuttle/Variable modes, you can change the playback speed as follows:

Jog mode: The playback speed corresponds to the rotational speed of the search dial, ranging from -1 to +1 or -2 to +2 times normal playback speed. (The speed setting can be changed in the VTR SETUP menu using item 107.JOG DIAL RESPONSE.)

Shuttle mode: The playback speed corresponds to the angle of rotation of the search dial. The playback speed is different depending on the frame frequency of the unit. The search dial clicks at the positions for still-picture and ± 10 times normal speed playback.

Frame frequency	Playback speed
23.98/24 Hz	Ranging from -60 to +60
25 Hz	Ranging from -58 to +58
29.97/30 Hz	Ranging from -50 to +50

Variable mode: Playback speed is -1 times normal speed when the search dial is rotated fully counterclockwise, and +2 times normal speed when rotated clockwise.



5-4 Playback

Jog mode playback

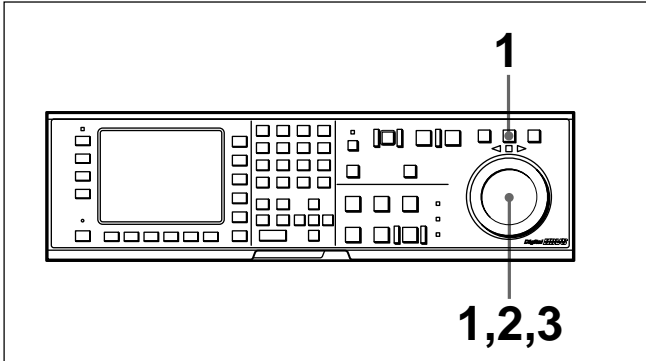
Follow the procedure below to play back in jog mode.



Jog mode playback

- 1** Press the JOG button so that the JOG button lights up. The  indicator lights up and the VTR enters still-picture mode.
- 2** Rotate the search dial in the desired playback direction and to the desired angle. The tape is played back slowly, at a speed corresponding to the rotational speed of the search dial. A direction indicator () lights up to indicate the direction of playback.
- 3** Stop rotating the search dial to stop jog mode playback. The indicator lights up.

Note

You can change the search dial mode selection so that pressing the search dial switches the VTR between jog and shuttle modes.

For details on switching the search dial functions, refer to the supplied Maintenance Manual.

Shuttle mode playback

Follow the procedure below to play back in shuttle mode.

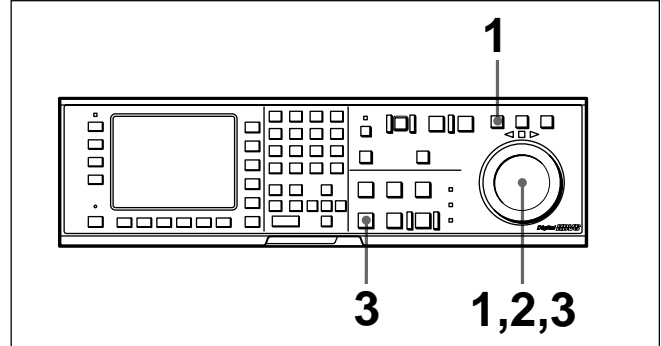

Shuttle mode playback

- 1** Press the SHUTTLE button so that the SHUTTLE button lights up. The  indicator lights up and the VTR enters still-picture mode.
- 2** Rotate the search dial in the desired playback direction and set the angle of rotation as required to obtain the desired playback speed.

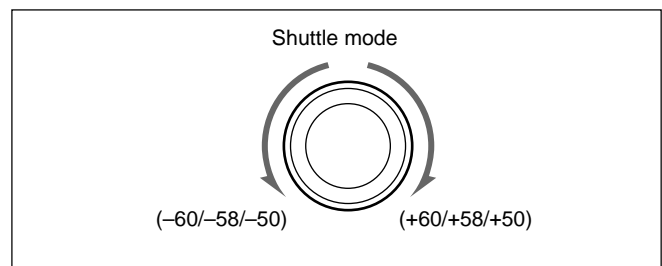

The tape is played back at a speed that corresponds to the angle of the search dial. A direction indicator () lights up to indicate the direction of playback.

The search dial clicks at the positions for still-picture and ± 10 times normal-speed playback.

- 3** Set the search dial to center position for still-picture, or press the STOP button to stop shuttle mode playback.

To return to normal-speed playback

Press the PLAY button.

Note

The audio signal output status is specified by the following settings of 017. PB/EE SELECT MENU in the VTR SETUP menu.

EE: The input audio is output.

MU: The audio output is muted.

PB: The playback audio signal is output for playback speeds of -1 to $+2$ times normal speed, and is muted for playback speeds of more than -1 or $+2$ times normal speed.

Variable mode playback

Follow the procedure below to play back in variable mode.

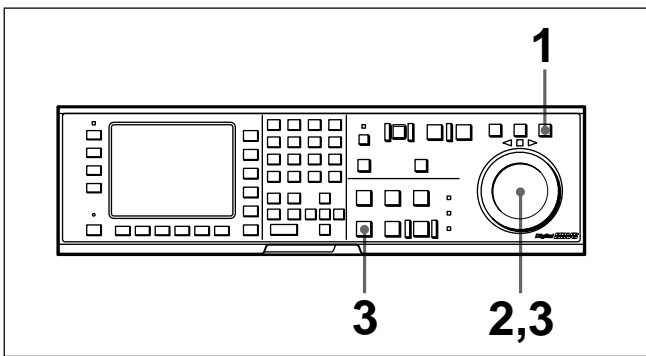

Variable mode playback

- 1** Press the VAR button so that it lights up. The indicator lights up and the VTR enters still-VAR mode.
- 2** Rotate the search dial in the desired playback direction and set the angle of rotation as required to achieve the desired playback speed.

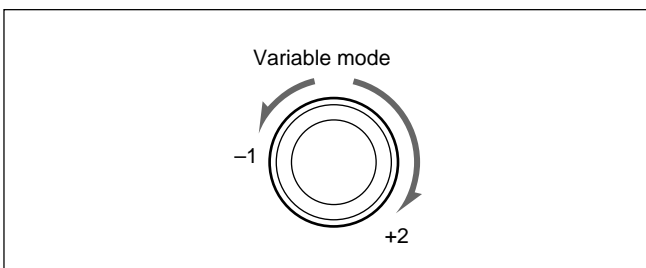

The tape is played back at a speed that corresponds to the angle of the search dial. A direction indicator (◀ or ▶) lights up to indicate the direction of playback.

The search dial clicks at the positions for still-picture and normal-speed playback.

- 3** Set the search dial to center position for still-picture, or press the STOP button to stop variable mode playback.

To return to normal-speed playback

Press the PLAY button.

To alternate between normal-speed playback and variable mode playback

After you have set the search dial to the angle that corresponds to the desired playback speed, pressing the PLAY button or VAR button selects normal-speed playback or variable mode playback, respectively.

To stop or start variable mode playback, press the STOP button or VAR button, respectively.

The VTR is factory set so that pressing the JOG, SHUTTLE, or VAR button is required in order to enter variable-speed playback mode. To change this setting, use item 101. SELECTION FOR SEARCH DIAL ENABLE in the VTR SETUP menu.

5-4 Playback

5-4-3 Capstan Override Playback

When playing back the same program on two VTRs, you can adjust the playback phases of the two VTRs so that they are synchronized.

There are two ways to make this adjustment:

- (A) Using the search dial
- (B) Using the +/- buttons

Note

When using method (A), change the system setup so that jog/shuttle mode playback is inhibited even when the search dial is rotated. Doing so prevents the VTR from accidentally entering jog/shuttle mode during capstan override playback. Make this setting through 101. SELECTION FOR SEARCH DIAL ENABLE in the VTR SETUP menu.

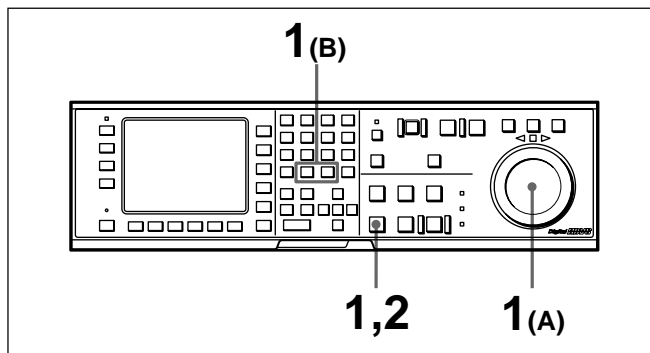

Capstan override playback

- 1** Use either method (A) or (B).
 - (A) Rotate the search dial while holding down the PLAY button to adjust the playback speed. The adjustment range is $\pm 15\%$ (in steps of 1%) of the normal playback speed.
 - (B) Press the + or - button while holding down the PLAY button to adjust the playback speed. Every time the + or - button is pressed, the speed changes using the field number set in the VTR SETUP menu under item 004.CAPSTAN LOCK select.

During playback at increased or decreased speed, the SERVO indicator goes off since the servo is not locked (capstan override).

- 2** Release the PLAY button after you have finished adjusting the phase. The VTR returns to normal-speed playback and the SERVO indicator lights up.

5-4-4 DMC Playback

Overview of DMC playback

DMC (Dynamic Motion Control) playback allows you to vary the playback speed in variable mode (in the DT playback range between -1 and $+2$ times normal speed) for certain sections of the tape, then store the specified speed in memory for later playback.

For example, during a live broadcast of a sporting event, you can set the start and end points of important scenes while recording, and immediately play back and broadcast those scenes using DMC playback.

Storing playback speeds in memory

Follow the procedure below to store playback speeds in memory.

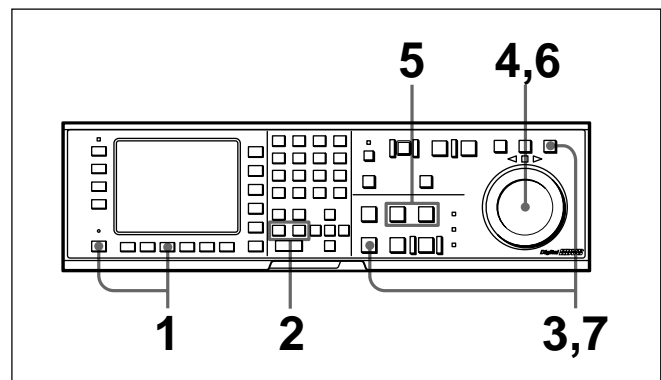

Storing playback speeds in memory

- 1** In HOME menu, press the ALT button, then press the $\boxed{F7}$ (DMC) button to light up DMC on the display.
- 2** Set a start point during recording or on a previously recorded tape by simultaneously pressing the ENTRY button and the IN button.
- 3** Press the STOP button to enter stop mode.
- 4** Rotate the search dial to select the initial playback speed. The selected speeds are shown in the time data display window in the menu display.

Note

If the 101.SELECTION FOR SEARCH DIAL ENABLE setting in the VTR SETUP menu is set to dial direct, initial speed settings cannot be made. Change the 101.SELECTION FOR SEARCH DIAL ENABLE setting to via search key.

- 5 Press the PREROLL button and PREVIEW button simultaneously.
The tape is prerolled and played back at the initial speed from the preroll point to the speed variation start point. The moment the tape passes the speed variation start point, the MEMORY indicator in the display starts flashing.
(The ■ indicator appears in the time data display window, indicating that tape speed memorization in DMC mode is active.)
- 6 Rotate the search dial to the position for the desired playback speed.
The speed variation is stored in memory while the MEMORY indicator is flashing.

- 7 Press the STOP button to stop the tape.

If the MEMORY indicator flashes before the tape reaches the speed variation end point

Memory has been exceeded and the VTR cannot store any more data for playback speed variations.

Notes on the ■ indicator and the MEMORY indicator

The ■ indicator shows that the tape speed memorization in DMC mode is taking place. The MEMORY indicator flashes during playback speed memorization, then stays lit continuously when memorization of the playback speed has been completed.

Performing DMC playback

There are two methods of starting DMC playback.

- Starting playback at the on-air cue from the on-air start point
- Starting playback immediately after prerolling

Note

To avoid operation errors, we recommend that you use the VTR alone when performing DMC playback.

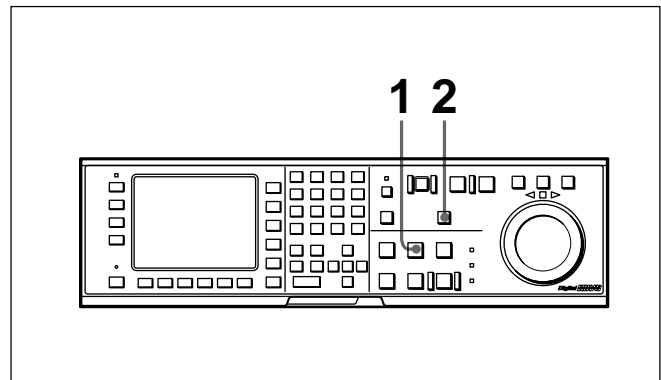

Performing DMC playback

To start playback at the on-air cue from the on-air start point

- 1 Press the PREROLL button.
The PREROLL button lights up and the tape is cued up to the on-air start point.
- 2 Press the PREVIEW button at the moment the on-air cue is given.
The PREVIEW button lights up. When the tape passes the speed variation start point, DMC playback starts and continues at the speed(s) stored in memory. When the tape passes the speed variation end point, normal-speed playback starts and the tape stops at the on-air end point.

To start playback immediately after prerolling

Press the PREVIEW button.
The PREVIEW button lights up. When the tape passes the speed variation start point, DMC playback starts and continues at the speed(s) stored in memory. When the tape passes the speed variation end point, normal-speed playback resumes.

5-4 Playback

To stop the tape during DMC playback

Press the STOP button.

To exit DMC playback mode

Press the ALT/[F7] (DMC) button in HOME menu to go off DMC on the display.

During DMC playback, the tape runs as shown in the diagram below.

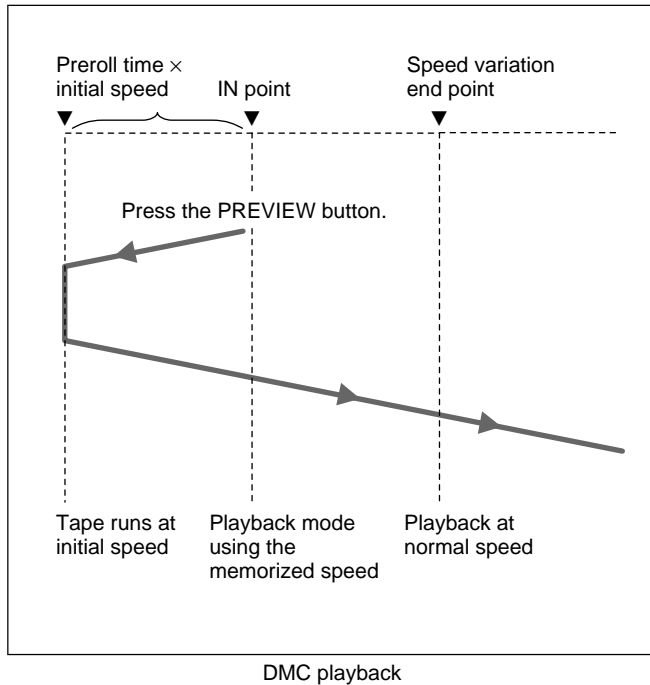

5-4-5 Playing Back Non-audio Data

Non-audio data recorded on a tape is detected automatically and played back.

Note

When non-audio data is being played back:

- The “OVER” indication on the audio level meters flashes.
- Analog audio output to the main line, monitor, and the headphones are muted.
- The playback level cannot be adjusted using the PB audio output level controls.

5-4-6 Output of Pull Down Signal

The explanation of pull down signal output for playback is given below.

Time code multiplexed to pull down signal output

- The value of the time code multiplexed to pull down HD SDI output signal is determined by the time code preset using the PDPSET MENU in the TC menu and converted into 30-frame time code.

Note

- LTC output of this unit is always 24-frame time code which is output from the main output line of this unit.
- When this unit is operated in 24F mode, time code data of the user’s bits area is not included in the pull down signal output. The time code value before conversion (24F mode) and sequence information of conversion contained in user’s bits data are multiplexed to the HD SDI output signal. The following four bits are used for the sequence information to display 0 to 9 repeatedly.

MSB: The first bit of the tens digit of the hour

The second bit of the tens digit of the hour

The first bit of the tens digit of the minute

LSB: The first bit of the tens digit of the second

When the sequence information is masked, the remaining contents of user’s bits data are the same as the time code value before conversion (24F mode).

Note

Since user’s bits data multiplexed to the down-converted output signal are updated frame by frame, 24-frame time code and sequence information of the down-converted output signal differs from those multiplexed to the HD output signal.

Time code area 30F TC	User’s bits area (HD) 24F TC + sequence information
00:00:00:00	00:00:00:00 A frame
00:00:00:00 *	00:00:80:00
00:00:00:01	00:80:00:01
00:00:00:01 *	00:80:80:01
00:00:00:02	40:00:00:01
00:00:00:02 *	40:00:80:02
00:00:00:03	40:80:00:02
00:00:00:03 *	40:80:80:03
00:00:00:04	80:00:00:03
00:00:00:04 *	80:00:80:03
00:00:00:05	00:00:00:04 A frame
00:00:00:05 *	00:00:80:04

} Cycle of conversion

Phase lock for the HD reference signal (23.98PsF) and 525 black burst signal (59.94i mode)

When an optional HKDV-507D HD Pull Down Board is installed and item A05. PD EXT SD REF LOCK MODE in the VTR SETUP menu is set to “lock1” or “lock2” to lock the pull down output signal to the external reference signal, the phase of the external reference signals for 24F mode and 30F mode should be locked as illustrated below.

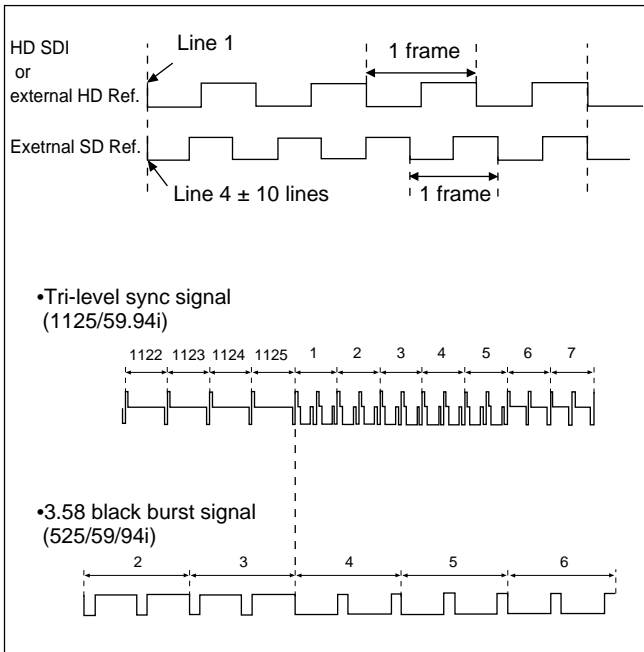

Pull down output phase lock

When an optional HKDV-507D HD Pull Down Board is installed and item A05. PD EXT SD REF LOCK MODE in the VTR SETUP menu is set to “lock2”, the phase of the pull down output signal can be locked as illustrated below.

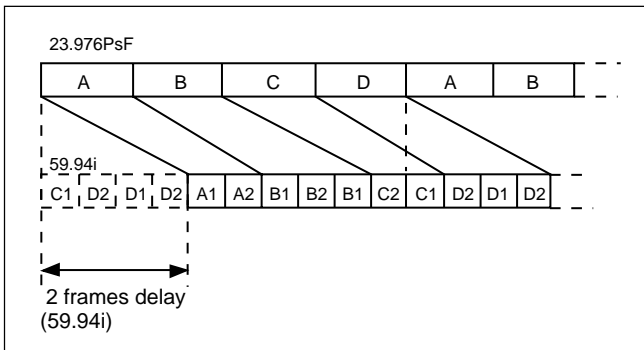

Output delay

When an optional HKDV-507 HD Pull Down Board is installed, or when an optional HKDV-507D HD Pull Down Board is installed and item A05. PD EXT SD REF LOCK MODE in the VTR SETUP menu is set to “off” or “lock1,” the phase of the output delay for conversion is as illustrated below.

However, when the HKDV-507D board is installed and item A05 is set to “lock1,” pull down output is locked to the external reference signal (525 black burst signal).

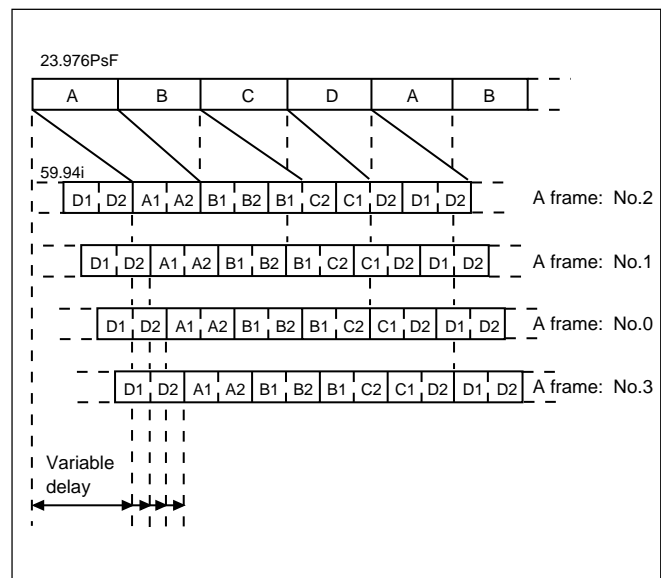

Pull down audio output

Audio signal multiplexed to the pull down HD SDI output signal is delayed so that the audio signal and the video signal are equal in phase as considering the video signal delay due to video signal processing. The pulled down and down-converted SDI output signal is also multiplexed with the delayed audio signal.

Note

The AES/EBU or analog audio output signal and 24-frame video output signal (the main output line of this unit) are equal in phase.

6-1 Basic Automatic Editing

6-1-1 Overview of Automatic Editing

Automatic edit modes

The VTR provides the following two modes for automatic editing:

- **Assemble mode**

New scenes are added to the end of previously recorded scenes.

CTL signals, time codes, video and audio signals on tape in the player are recorded onto tape in the recorder VTR.

- **Insert mode**

New scenes are inserted into the middle of previously recorded scenes. CTL signals on tape in the recorder VTR are not overwritten. Video, digital audio, cue audio, and time code signals can be recorded separately.

Both of these two edit modes support DMC editing. In insert mode, you can also use split editing.

Interpolation of time codes by the CTL counter

To use time codes as addresses of edit points, the time codes must be recorded on the tape in ascending order. As long as they are in ascending order, time codes do not have to be continuous. The CTL counter automatically interpolates data for editing even if there are breaks in the continuity in the time codes.

Steps in automatic editing

The sequence of steps that are taken to do automatic editing with two VTRs is as follows:

Select the edit mode (page 6-3).



Set edit points for the recorder and player VTR (page 6-3).



Preview the edit section (page 6-9).



Perform the edit (page 6-12).



Confirm and modify the edit points (pages 6-8 and 6-10).



Confirm the results of the edit (page 6-13).

Editing precautions

Using an editing control unit

When using an editing control unit to control the VTR, set the edit delay on the control unit so that CUT-IN and CUT-OUT commands are sent to the VTR five frames ahead of the actual edit point.

6-1 Basic Automatic Editing

6-1-2 Setting Switches and Menus

Before editing, set the following switches as shown below.

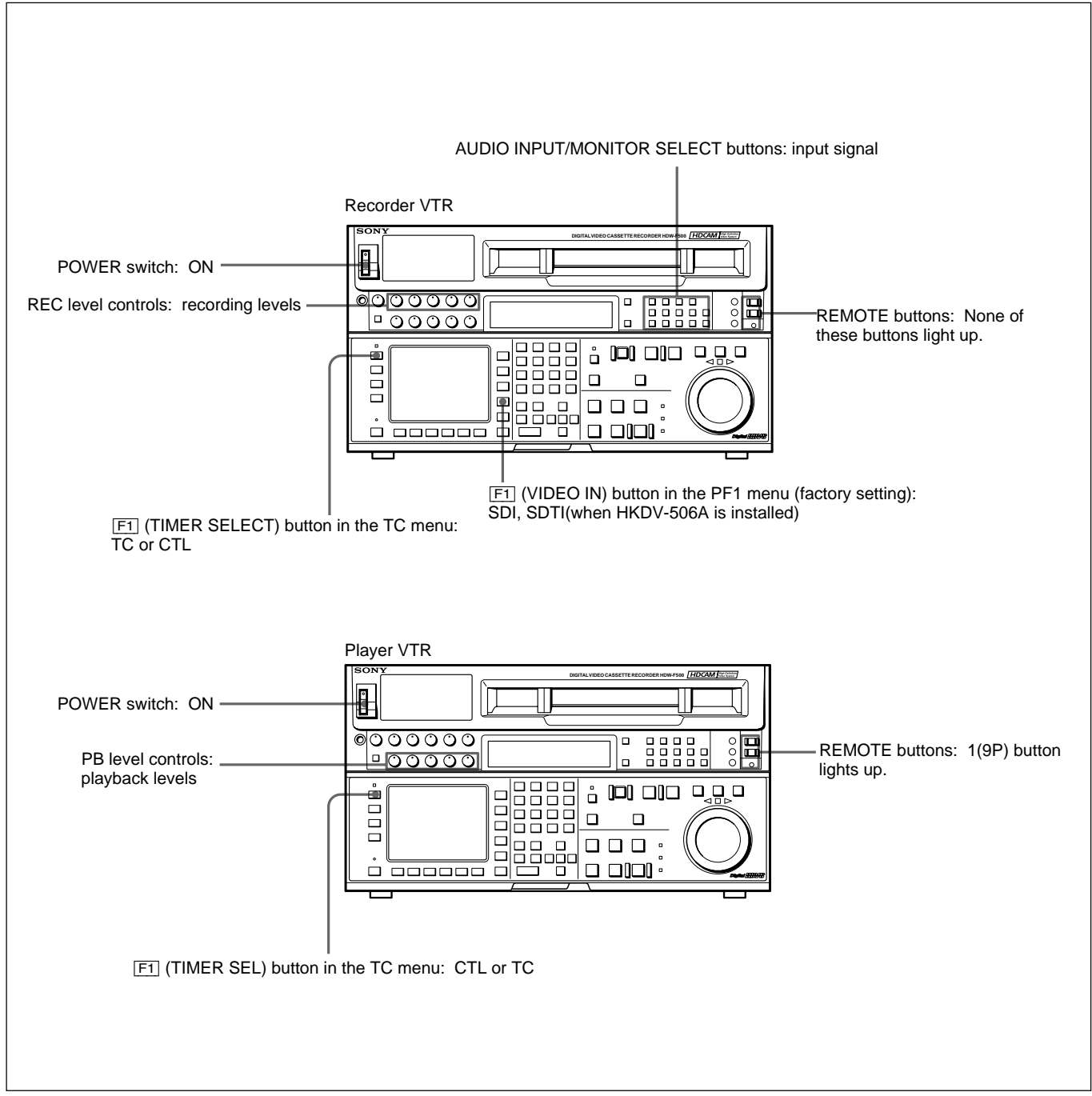

Setting switches and menus

6-1-3 Selecting the Edit Mode

Select assemble or insert mode.

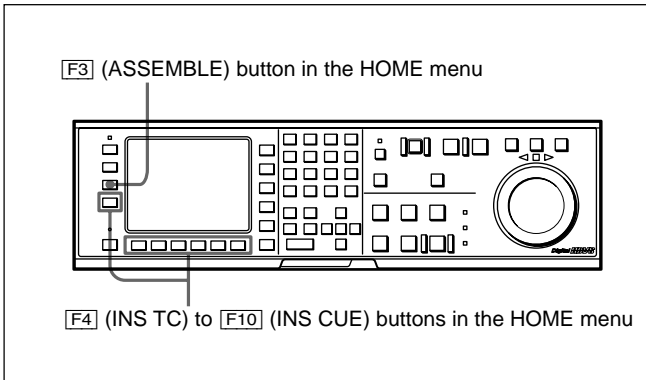

Selecting the edit mode

Press one of the following buttons to select the respective edit mode:

- **Assemble mode:** **F3** (ASSEMBLE) button in the HOME menu
- **Insert mode:** the appropriate INSERT button in the HOME menu (**F4** (INS TC), **F5** (INS VIDEO), **F6** (INS A-CH1), **F7** (INS A-CH2), **F8** (INS A-CH3), **F9** (INS A-CH4), **F10** (INS CUE))

6-1-4 Setting Edit Points

This section describes how to set edit points (IN and OUT points). In insert mode, a technique called split editing allows you to set edit points separately for video and audio.

Positioning and setting edit points

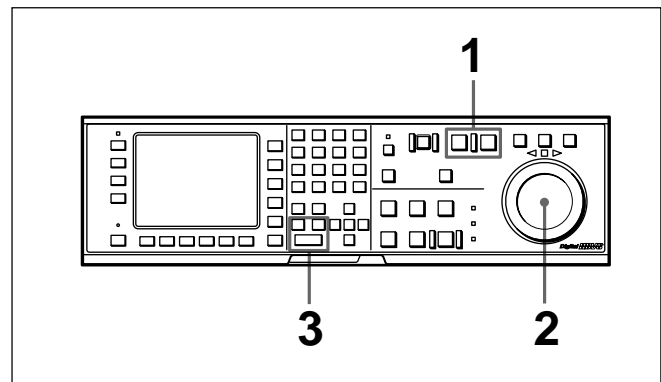

Positioning and setting edit points

- 1** Press the RECORDER or PLAYER button to select the VTR for which edit points are to be set. The button lights up.
- 2** Rotate the search dial in jog or shuttle mode to position the edit point.
For details on jog or shuttle playback, refer to “5-4-2 Variable Speed Playback” on page 5-11.
- 3** Press the IN (or OUT) button while holding down the ENTRY button. The time data for the IN (or OUT) point appears in the menu display.
- 4** Repeat Steps **1** to **3** to set the remaining edit points. Editing can begin when the points are set.

6-1 Basic Automatic Editing

Setting edit points with the numeric buttons

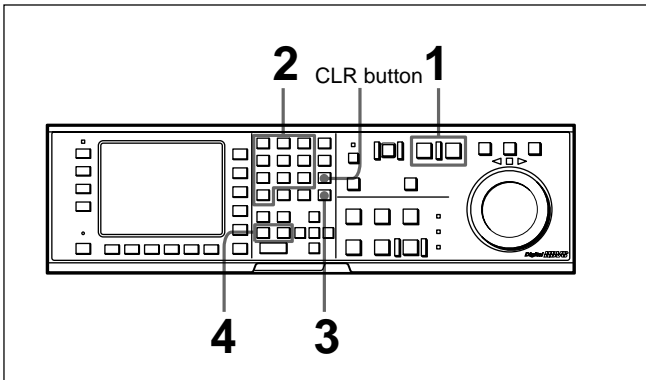

Setting edit points with the numeric buttons

- 1** Press the RECORDER or PLAYER button to select the VTR for which edit points are to be set. The button lights up.
- 2** Enter the edit point data with the numeric buttons. For example, to enter 01H00M30S00F, press 1, 0, 0, 3, 0, 0, 0. (The leading 0 is not required. When the entered value is less than eight digits, the leading digit(s) are set to 0 when you press the SET button.)

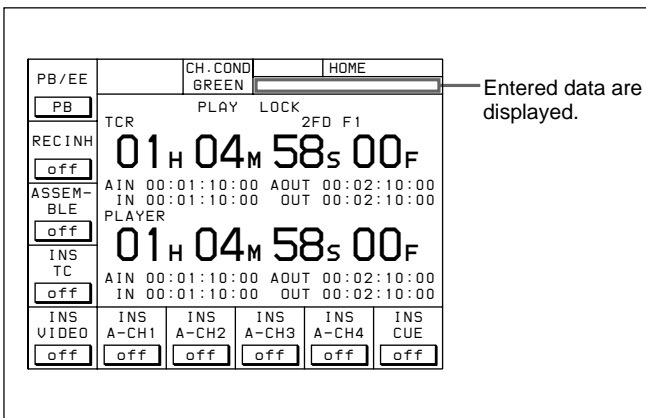

To delete entered data

Press the CLR button.

- 3** Press the SET button to set the input data.

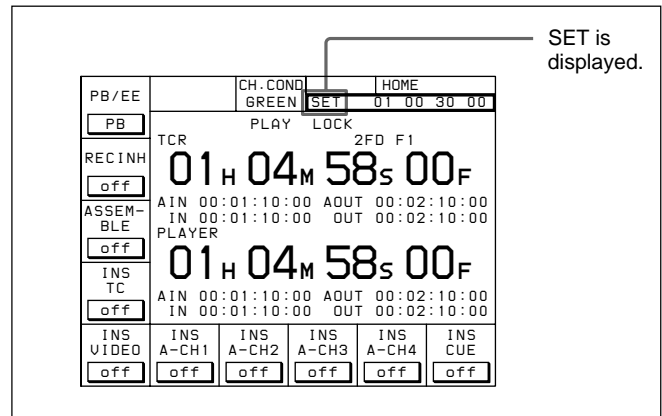

- 4** Press the IN (or OUT) button. The time data for the IN (or OUT) point appears in the menu display.

About automatic edit point setting

Editing requires a total of four edit points: IN and OUT points for both the recorder and player VTRs. However, as soon as you set three edit points, the VTR automatically sets the fourth point. In the figure below, the points enclosed in a box have been set manually, while the OUT point for the player VTR has been set automatically.

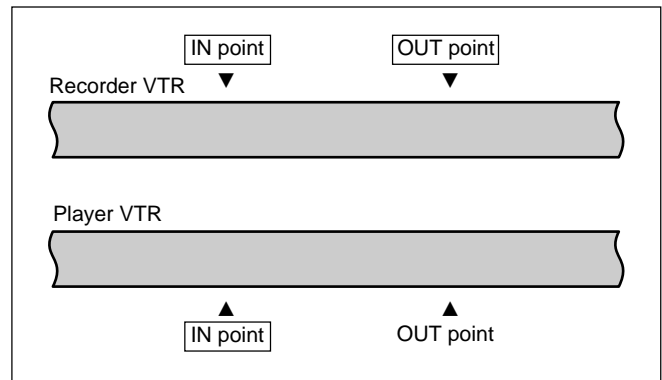

Automatic edit point setting

Whether set manually or automatically, all edit points can be changed or deleted at any time.

Automatic setting of OUT points

When the fourth edit point (OUT point) is set, the edit point data is activated and the invalid point is automatically deleted

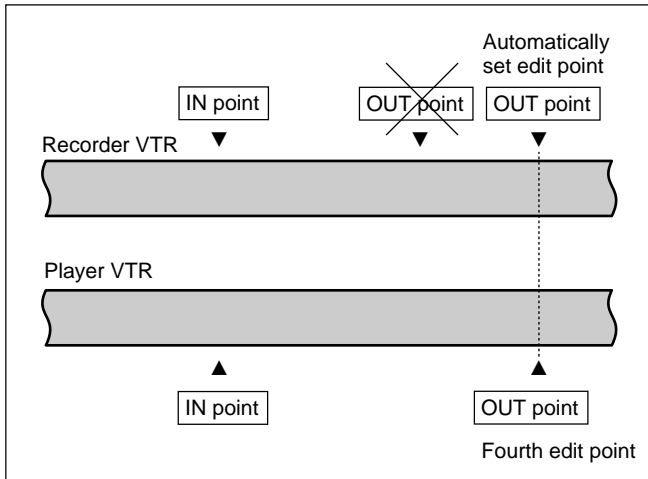

Automatic setting of IN points

When an IN point is corrected, the OUT point is set automatically using the duration of the VTR whose edit points were not changed.

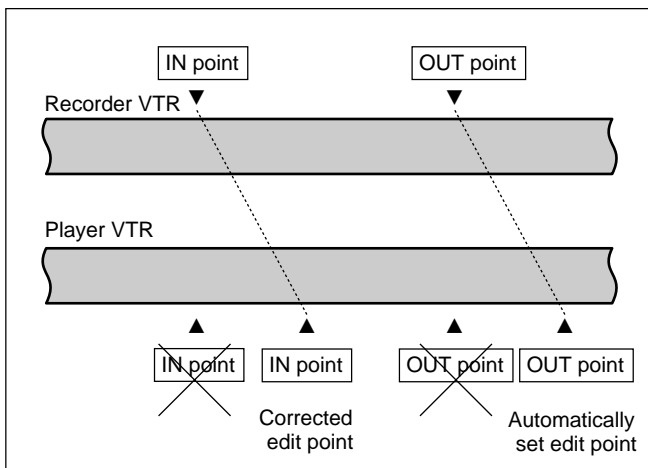

Split editing

Positioning and setting edit points

Split editing allows you to set edit points separately for video and audio. Set audio edit points with the AUDIO IN/OUT buttons and video edit points with the IN/OUT buttons.

Split editing, however, can only be done when the recorder VTR is in insert mode.

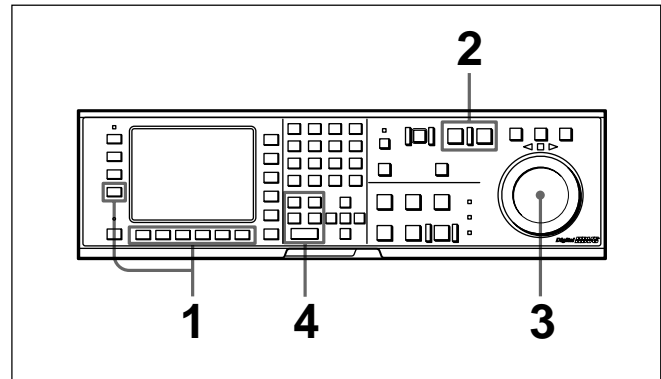

Positioning and setting edit points

- 1** Press the appropriate INSERT button in HOME menu ([F4] (INS TC), [F5] (INS VIDEO), [F6] (INS A-CH1), [F7] (INS A-CH2), [F8] (INS A-CH3), [F9] (INS A-CH4), [F10] (INS CUE)).
- 2** Press the RECORDER or PLAYER button to select the VTR for which edit points are to be set. The button lights up.
- 3** To locate the edit points, rotate the search dial in jog or shuttle mode.
For details on jog/shuttle/variable playback modes, refer to "5-4-2 Variable Speed Playback" on page 5-11.
- 4** Press the IN (OUT, AUDIO IN or AUDIO OUT) button while holding down the ENTRY button.
- 5** Repeat Steps 2 to 4 to set the remaining edit points.

6-1 Basic Automatic Editing

Setting edit points with the numeric buttons

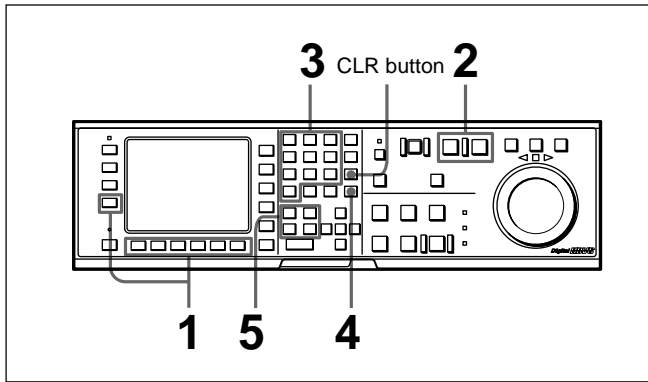

Setting edit points with the numeric buttons

- 1** Press the appropriate INSERT button in HOME menu (**F4** (INS TC), **F5** (INS VIDEO), **F6** (INS A-CH1), **F7** (INS A-CH2), **F8** (INS A-CH3), **F9** (INS A-CH4), **F10** (INS CUE)).
- 2** Press the RECORDER or PLAYER button to select the VTR for which edit points are to be set. The button lights up.
- 3** Enter the edit point data with the numeric buttons. For example, to enter 01H00M30S00F, press 1, 0, 0, 3, 0, 0, 0. (The leading 0 is not required. When the entered value is less than eight digits, the leading digit(s) are set to 0 when you press the SET button.)

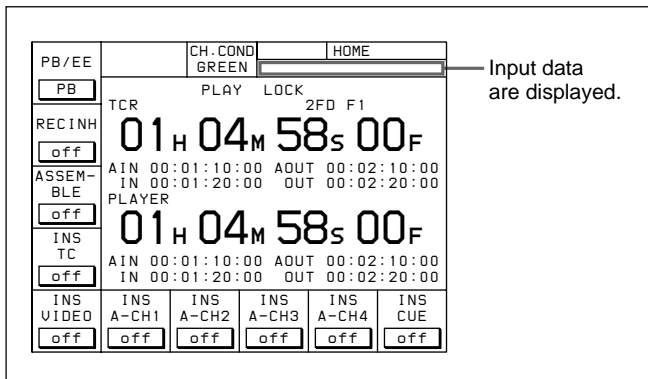

To delete entered data
Press the CLR button.

- 4** Press the SET button to set the input data.

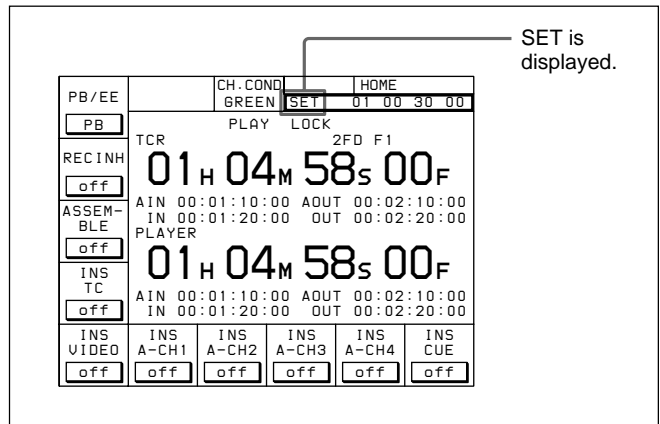

- 5** Press the IN (OUT, AUDIO IN or AUDIO OUT) button. The time data for the IN (OUT, AUDIO IN or AUDIO OUT) point appears in the menu display.

About automatic split edit point setting

Split editing requires a total of eight edit points: four edit points for video editing (IN and OUT points for both the recorder and player VTRs) and four edit points for audio editing (AUDIO IN and OUT points for both the recorder and player VTRs). However, as soon as you set five edit points, the VTR automatically sets the remaining three points. For example, if you set three edit points for video (or audio) and two for audio (or video), the remaining three points are automatically set, regardless of whether these points are for the recorder or player.

In the following example, the points enclosed in a box have been set manually and the AUDIO OUT point for the recorder VTR, and the AUDIO IN and OUT points for the player VTR have been set automatically. Note that whether set manually or automatically, all edit points can be changed or deleted at any time.

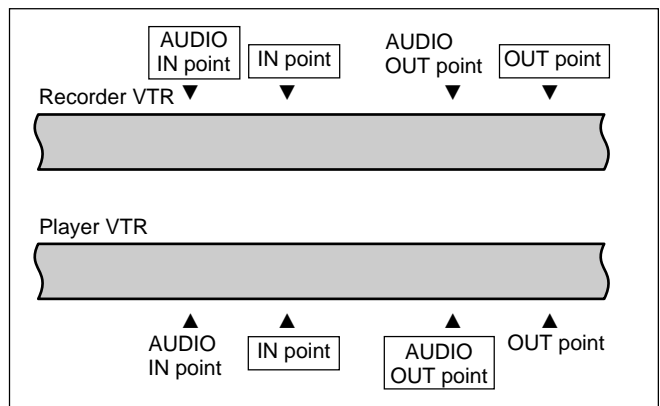

Automatic split edit point setting

Automatic setting of AUDIO OUT points

When the sixth edit point (AUDIO OUT point) is set, the edit point data is activated and the invalid AUDIO OUT points are automatically deleted

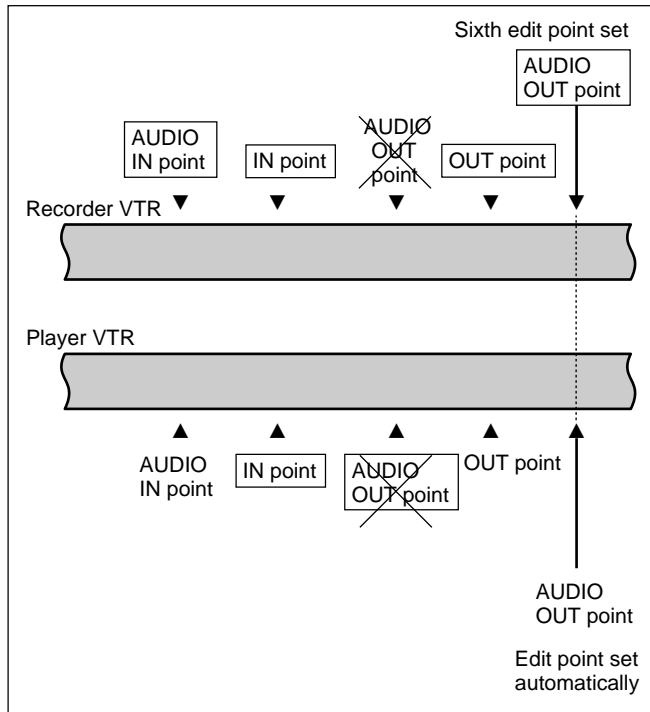

Automatic setting of edit points by correcting IN points

When IN points are corrected, the duration in the uncorrected VTR is used to automatically set OUT points and AUDIO IN/OUT points.

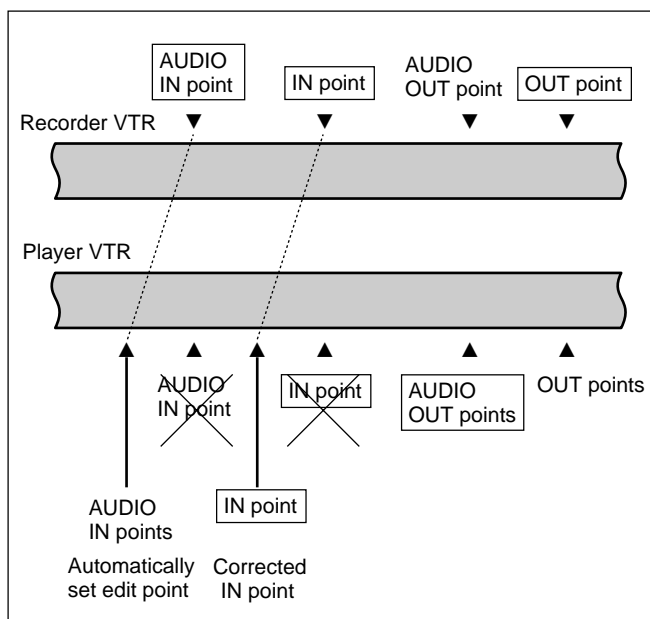

You can select audio cut-in, crossfade, and fade in/out in edits, as well as their duration, in the VTR SETUP menu.

For details, refer to the menu items in the 300 range in the VTR SETUP menu.

Using a VTR without the split editing function

If the player VTR does not support the separate setting of edit points for video and audio, you can set AUDIO IN and AUDIO OUT points on the recorder and three video edit points to enable split editing.

6-1-5 Editing Non-audio Data

Before editing non-audio data, set item 317.AUDIO EDIT MODE in the VTR SETUP menu to “cut edit.”

Note

Noise may be produced during editing of certain non-audio data.

6-1 Basic Automatic Editing

6-1-6 Confirming Edit Points

Displaying the duration between two edit points

The following six kinds of duration can be displayed in the time data display window:

- Between IN and OUT points
- Between IN and AUDIO OUT points
- Between IN and AUDIO IN points
- Between OUT and AUDIO OUT points
- Between OUT and AUDIO IN points
- Between AUDIO IN and AUDIO OUT points

Durations are calculated as follows.

- If both IN and OUT points are set, the duration is the time between the points.
- If one of the edit points is not set, the duration is set to 00:00:00.

1 Press the RECORDER or PLAYER button to select the VTR for which you want to confirm a duration.

The button lights up.

2 Hold down any two IN, OUT, AUDIO IN, or AUDIO OUT buttons.

The duration between the points corresponding to the two buttons is displayed. The value can be negative.

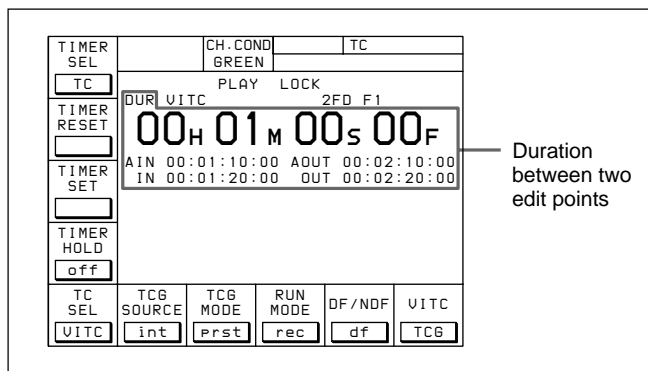

Displaying the duration between two edit points

6-1-7 Cuing Up and Prerolling

You can preroll the tape to a point prior to the edit start point (preroll point), or cue up the tape to any edit point.

Follow the procedure below to cue up or preroll the tape.

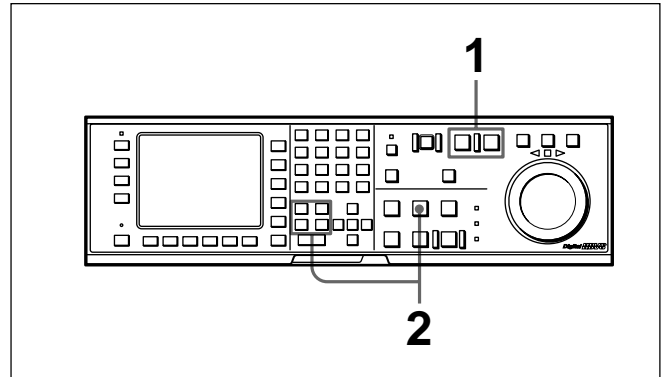

Cuing up and prerolling

1 Press the RECORDER or PLAYER button to select the VTR which you want to operate. The button lights up.

2 To cue up the tape to an edit point

Press the IN, OUT, AUDIO IN, or AUDIO OUT button while holding down the PREROLL button. The tape moves to the edit point corresponding to the button, then stops.

To preroll the tape

Press the PREROLL button.

The tape is rewound to a point before the edit start point by the amount determined by the preroll time setting.

Note

When the [F1] (TIMER SEL) button in the TC menu is set to CTL, cuing up is slightly slower than in TC mode. This is to maintain the accuracy of the CTL signals.

You can set up the VTR so that priority is placed on cuing accuracy or speed. Change the VTR setting through 403. CUEUP BY TC and 404. CUEUP BY CTL in the VTR SETUP menu.

Changing the preroll time

The preroll time is factory set to 5 seconds, but can be set to any time between 0 and 30 seconds, in 1-second steps.

For details, see Section 4-2-7, “Setting the Preroll Time (PREROLL TIME)” on page 4-18.

When changing the preroll time, set it so that the recorded section prior to the edit start point is longer than the preroll time.

The preroll time used in automatic editing is the preroll time set for the recorder.

6-1-8 Previewing

Follow the procedure below to preview the edit

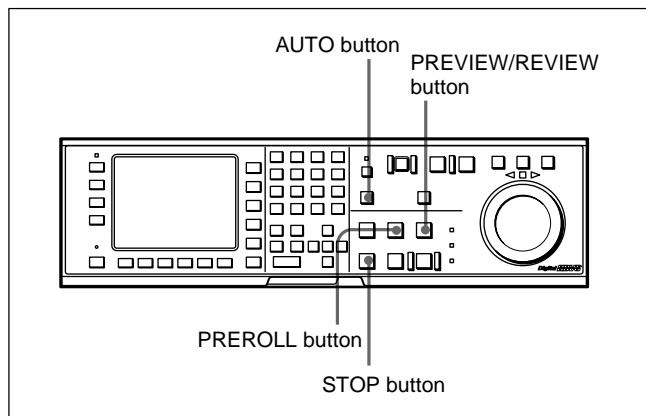

Previewing

To preview the edit, press the AUTO button to switch to AUTO mode, then press the PREVIEW/REVIEW button.

During previewing, the PREVIEW/REVIEW button lights up.

After previewing, correct the edit points as required, then do the preview again.

For details on modifying edit points, refer to “6-1-9 Modifying Edit Points” on page 6-10.

To stop previewing

Press the STOP button.

The tape stops immediately.

To rewind the tape to the preroll point

Press the PREROLL button.

To rewind the tape to the edit point

Press the PREROLL button together with the button corresponding to the edit point.

6-1 Basic Automatic Editing

Monitoring signals during previewing

During previewing, you can monitor the following video and audio signals on a monitor connected to the recorder VTR:

- Between preroll and IN points: Playback signal of the recorder VTR can be monitored.
- Between IN and OUT points: Playback signal of the player VTR can be monitored in E-E mode.
- Between OUT and post-roll points: Playback signal of the recorder VTR can be monitored.

This may be illustrated as shown below:

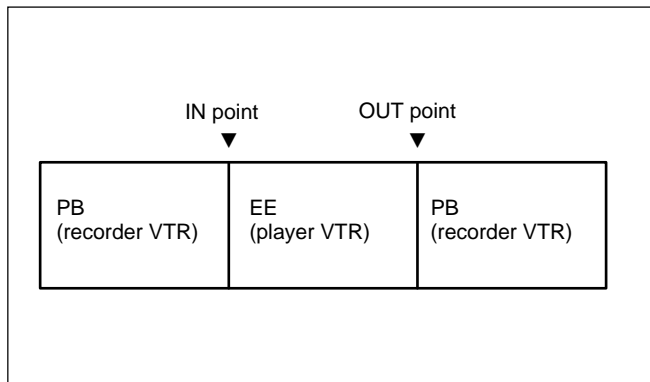

6-1-9 Modifying Edit Points

If an edit point is incorrectly set, for example, if an OUT point is located before an IN point, or the length of an edit section is different for the recorder and player VTRs, the time data for the incorrectly set edit point flash indicating that the VTR cannot perform editing or previewing. In this case, delete the edit point, then set a new one correctly.

You can also move an edit point position in one-frame units.

Deleting edit points

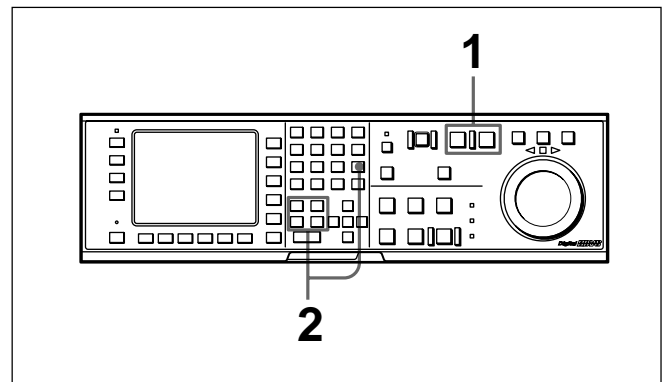

Deleting edit points

- 1** Press the RECORDER or PLAYER button to select the VTR on which to perform the edit point deletion.
The button lights up.
- 2** Press the IN, OUT, AUDIO IN or AUDIO OUT button while holding down the CLR button to delete the corresponding edit point.
The edit point is deleted and --:--:--:-- appears in the menu display.

Moving an edit point position by one frame at a time

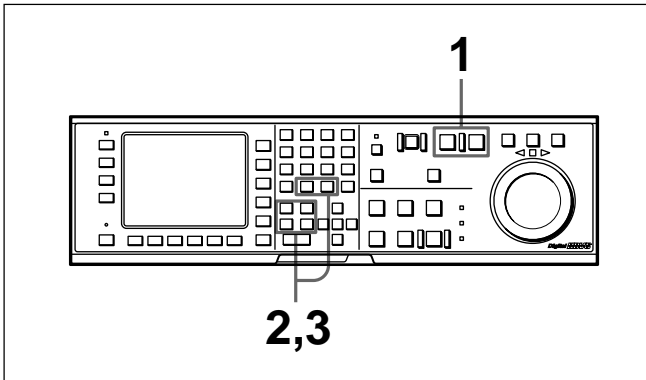

Moving an edit point position by one frame at a time

- 1 Press the RECORDER or PLAYER button to select the VTR on which to modify the edit point. The button lights up.
- 2 Press the + or – button while holding down the IN, OUT, AUDIO IN or AUDIO OUT button. Pressing the + or – button moves the edit point by one frame forward or backward, respectively.
- 3 After making the modification, release the respective edit point button that you have been holding down (IN, OUT, AUDIO IN, or AUDIO OUT button).

Moving an edit point position with the numeric buttons

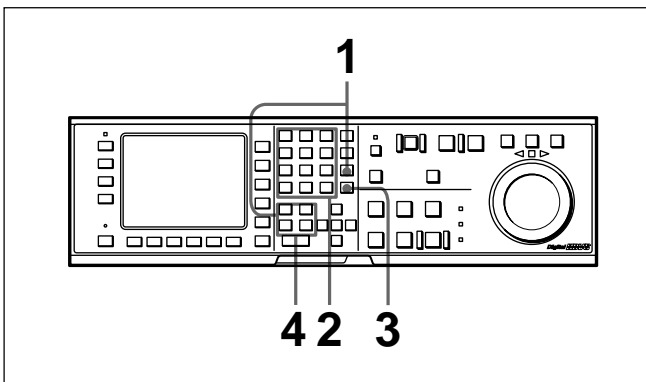

Moving an edit point position with the numeric buttons

- 1 Press the IN, OUT, AUDIO IN, or AUDIO OUT button while holding down the CLR button. Time data for the edit point appears in the data entry window.

- 2 Press the + or – button, then use the numeric buttons to enter the value to be added or subtracted.

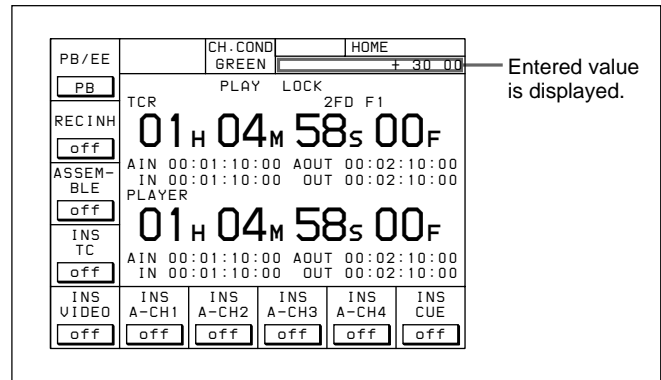

To cancel the entered value

Press the CLR button.

- 3 Press the SET button. The result of the addition or subtraction is entered.

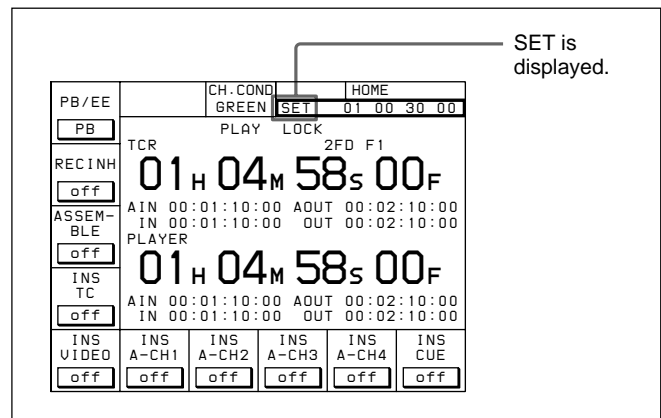

- 4 Press the IN, OUT, AUDIO IN, or AUDIO OUT button. The modified time data for the edit point appears in the menu display.

6-1 Basic Automatic Editing

6-1-10 Performing Automatic Editing

Overview

Once you have set the necessary edit points, the AUTO button lights up to show that the VTR is ready for automatic editing.

During automatic editing, the tape in the recorder VTR and the player VTR move as shown in the diagram below.

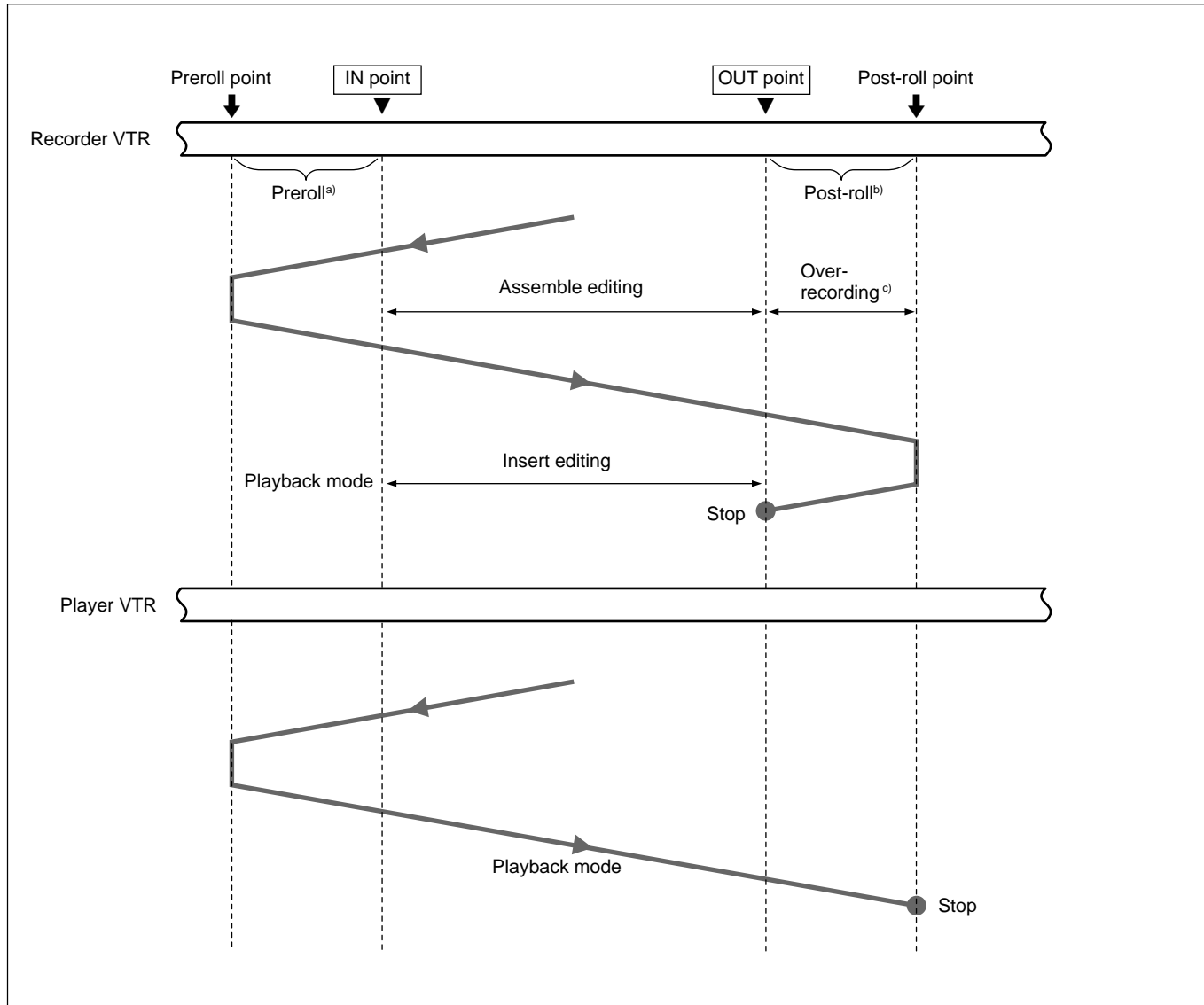

Tape movement during automatic editing

- a) Preroll time: Factory-set to 5 seconds. Can be set from 0 to 30 seconds, in 1-second steps, through the SET UP menu.
- b) The post-roll time can be set between 0 and 30 seconds in units of seconds using the SET UP menu.
- c) Over-recording time: 2 seconds.

Monitoring signals during editing

During editing, you can monitor the following video and audio signals on a monitor connected to the recorder VTR.

- Between preroll and IN points: Playback signal of the recorder VTR can be monitored.
- Between IN and OUT points: Playback signal of the player VTR can be monitored in E-E mode.
- Between OUT and post-roll points: Playback signal of the recorder VTR can be monitored.

The video and audio signals that can be monitored are shown in the diagram below.

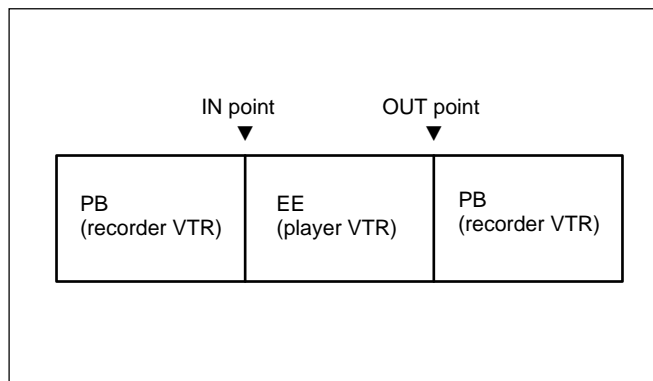

Monitoring signals during editing

In CONF1 mode, you can monitor video and audio signals that are just being edited.

Through a menu setting, you can also monitor signals between preroll and postroll points, including portions between IN and OUT points, through the CONF1 (confidence) heads during editing.

The CONF1 setting is made in item 017.PB/EE SELECT MENU in the VTR SETUP menu.

To perform automatic editing

To carry out automatic editing, press the AUTO button, turning it on, then press the REC/EDIT button. During editing the indicator above the REC/EDIT button lights up, and goes off at the end.

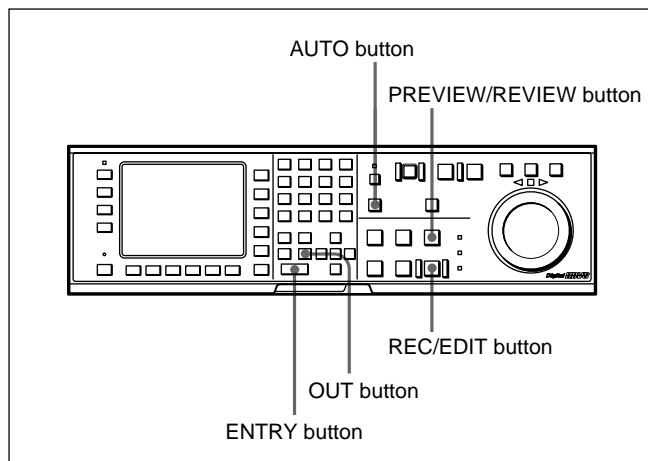

Performing automatic editing

To stop automatic editing

Press the OUT button while holding down the ENTRY button.

The point where the buttons are pressed is treated as an OUT point and editing stops.

To confirm the results of the editing

Press the PREVIEW/REVIEW button to confirm the edit results. When the preview ends, the tape rewinds to the OUT point, then stops.

6-1 Basic Automatic Editing

Modifying edit points for automatic editing later

After you perform automatic editing, the time data of IN, OUT, AUDIO IN or AUDIO OUT points remain stored in memory. The stored data can be later used to modify edit points or to execute automatic editing again.

Follow the procedure below to modify edit points after executing automatic editing.

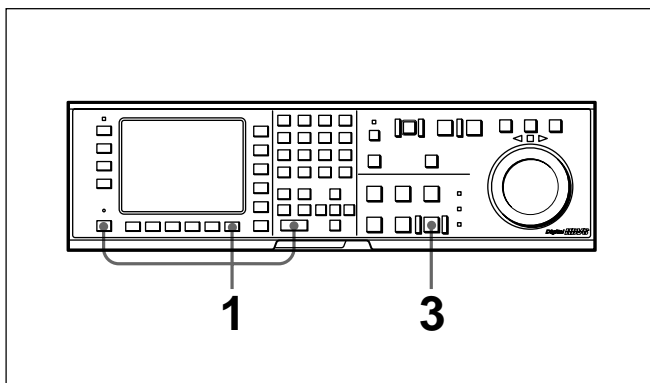

Modifying edit points for automatic editing later

1 In HOME menu, press the ALT button, and then the **[F10]** (LAST EDIT) button.
The edit points used in the last automatic edit are restored.

2 Modify the edit points.

For details on modifying edit points, see Section 6-1-9, "Modifying Edit Points" on page 6-10.

3 Press the REC/EDIT button.
The VTR performs automatic editing.

6-2 Advanced Automatic Editing

This section describes the following advanced editing methods:

- DMC editing
- Animation editing
- Preread editing

6-2-1 Performing DMC Editing

If your player VTR has DT® (Dynamic Tracking) capability, you can perform variable speed editing by controlling the playback speed from the lower control panel. This type of editing is called DMC editing.

Overview of DMC editing

Requirements for DMC editing

- DMC editing may be done during assemble or insert editing, but not during split editing.
- The player VTR must support DT playback.

Tape movement during DMC editing

During DMC editing, the tape moves as shown in the diagram below.

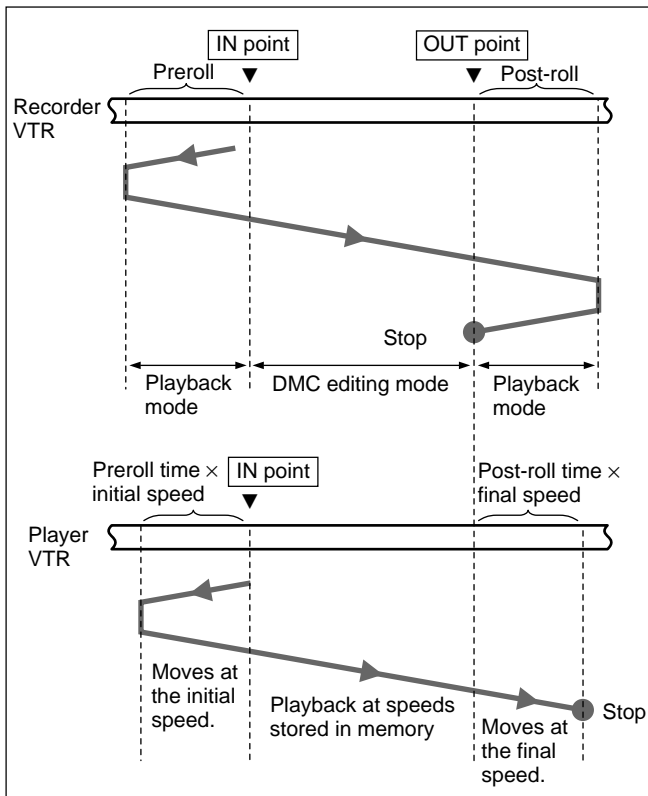

Tape movement during DMC editing

Setting edit points and playback speed

Use the procedure below to set edit points and playback speeds for DMC editing.

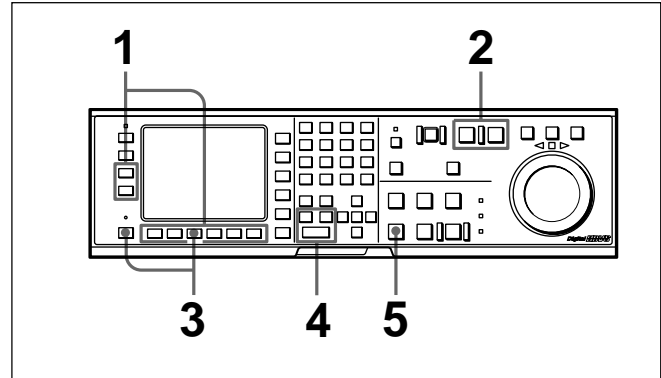

Setting edit points and playback speed

- 1 Press the **F3** (ASSEMBLE) button in the HOME menu, or press the respective INSERT button (**F4** (INSTC), **F5** (INS VIDEO), **F6** (INSA-CH1), **F7** (INSA-CH2), **F8** (INSA-CH3), **F9** (INSA-CH4) or **F10** (INSCUE) button) to select the edit mode that you want.
- 2 Press the **PLAYER** button to set the VTR to act as the player VTR. The **PLAYER** button lights up.
- 3 Press the **ALT/F7** (DMC) buttons in the HOME menu. The button lights up and the VTR enters DMC editing mode.
- 4 Press the **IN** button while holding down the **ENTRY** button to set an edit point.

Note

You cannot set an OUT point for the player VTR for DMC editing.

6-2 Advanced Automatic Editing

- 5** Press the STOP button. The VTR enters STOP mode.

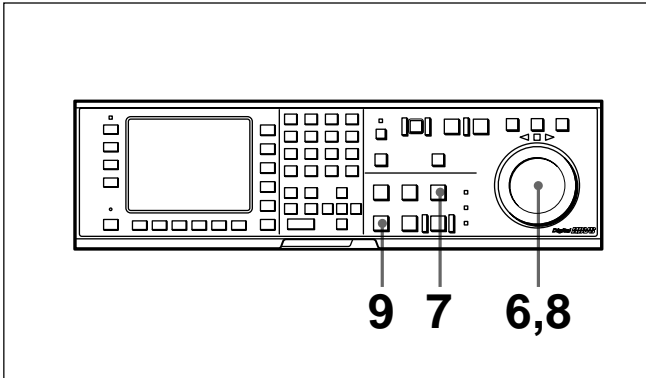

- 6** Turn the search dial to set the initial speed. The selected speed is displayed in the time data display.
- 7** Press the PREVIEW/REVIEW and PREROLL buttons at the same time. The tape prerolls and the player VTR begins playing at the initial speed.
- 8** When the ■ indicator appears with beep indicating that the IN point has been passed, rotate the search dial to the desired playback speed(s). The varying playback speeds are stored in memory while the ■ indicator appears in the display.
- 9** Press the STOP button.

If the ■ indicator goes off before the tape passes the OUT point

The VTR has reached its storage capacity, and cannot store any more playback speed variations.

To exit DMC editing mode

Press the ALT/**F7** (DMC) buttons in HOME menu.

Performing DMC editing

After setting the playback speeds in preview mode, press the RECORDER button and REC/EDIT button. DMC editing is performed at the playback speed(s) stored in memory.

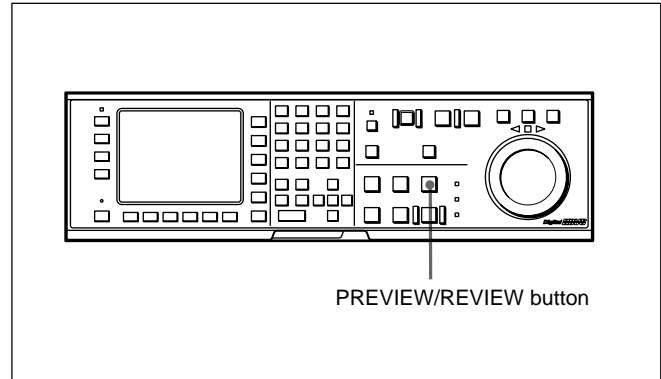

Performing DMC editing

To confirm the results of DMC editing

Press the PREVIEW/REVIEW button.

6-2-2 Animation Editing

Animation editing is a form of insert editing which makes it easier to record a succession of still frames in fixed field or frame units. The procedure for editing after selecting animation editing is exactly the same as for normal insert editing.

To select animation editing, use item 301. EDIT OPERATION MODE in the VTR SETUP menu.

normal: Selects normal insert editing.

CG: Selects editing in frame units, principally for recording computer graphics (CG).

When the edit completes, the OUT point automatically becomes the next IN point, and the next OUT point is set automatically with 1 frame added.

film: Selects editing in field units for film recording.

Since the standard film speed is 24 frames/sec and VTR frame rate is 30 frames/sec when the frame frequency is 29.97 Hz or 30 Hz, the duration must be alternated between 2 and 3 fields when recording films. In the FILM mode, this setting is made automatically. When an edit ends, as in the CG mode, the next IN and OUT points are set automatically.

Note

film is selectable only when the frame frequency of the VTR is 29.97 Hz or 30 Hz.

Follow the procedure below to perform animation editing.

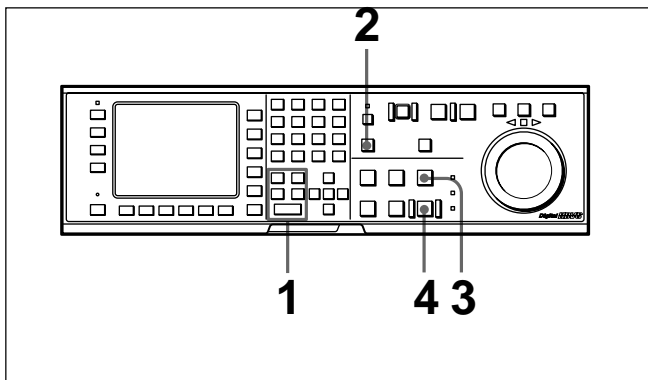

Performing animation editing

- 1** Set the IN point. The OUT point is set automatically.
- 2** Press the AUTO button.
The button lights up.
- 3** Press the PREVIEW/REVIEW button to preview.
- 4** Press the REC/EDIT button.
Automatic editing starts.
When the edit completes, the OUT point automatically becomes the next IN point, and the next OUT point is set automatically.
Repeat Steps **3** to **4** to perform animation editing.

6-2 Advanced Automatic Editing

6-2-3 Performing Preread Editing

Video and digital audio signals already recorded on the tape can be used as an edit source for insert editing. This type of editing is called preread editing, as the VTR uses preread heads to read signals in advance. Signals that are read in advance can be sent to mixers for mixing, then recorded to the original channels or other digital audio channels.

The preread editing settings are performed with the ALT/F1 (PRE READ) buttons in the HOME menu.

For details on the settings, refer to “4-2-4 Preread Settings (PRE READ)” on page 4-17.

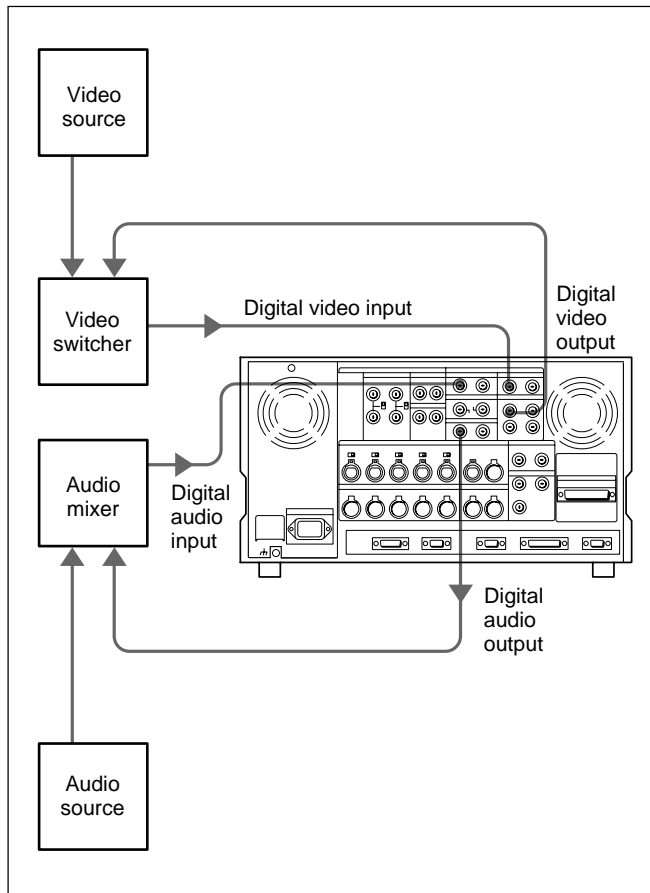

Preread editing

Notes

- In preread editing, if an input video signal is used as the reference signal for the output video signal, oscillation may occur because of loop connections. To avoid this, select the external reference signal for preread editing by setting the item 005. SERVO/AV REFERENCE select in the VTR SETUP menu to external.
- When preread mode is selected, shifting of the VTR to E-E mode is disabled in all operation modes to prevent oscillation caused by loop connections. If preread mode is deselected while a loop between the input and output of the same channel exists, E-E signals are output and oscillation occurs. To prevent oscillation, do the procedure below to select PB mode for both the video and digital audio channels before the start of preread editing.

- 1 Press the ALT/F1 (PRE READ) buttons in the HOME menu and select video, audio, or a/v.
- 2 Make the required connections for preread editing.
- 3 Perform preread editing after selecting the insert editing mode.
- 4 After preread editing, undo all the connections used for the preread editing.
- 5 Press the ALT button, and then press F1 (PRE READ) button to select off.
- 6 Check that no loop connections remain.

6-3 Manual Editing

Follow the procedure below to perform manual editing.

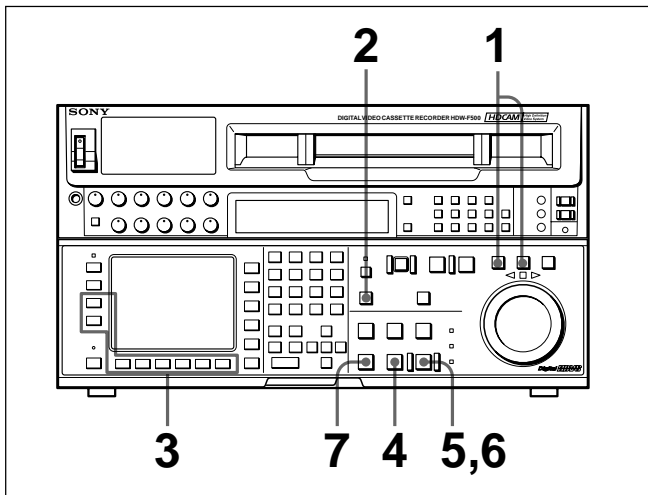

Manual editing

- 1** Enter jog or shuttle mode to position the tape at a place at least three seconds before the position at which you want to set an edit point.
- 2** Press the AUTO button to turn it off.
- 3** Press the **[F3]** (ASSEMBLE) button in the HOME menu or press the respective INSERT button (**[F4]** (INS TC), **[F5]** (INS VIDEO), **[F6]** (INS A-CH1), **[F7]** (INS A-CH2), **[F8]** (INS A-CH3), **[F9]** (INS A-CH4) or **[F10]** (INS CUE) button) to select the edit mode that you want.
- 4** Press the PLAY button.
Playback starts.
- 5** Press the REC/EDIT button at the point where you want to start editing (IN point).
The REC/EDIT button lights, and editing starts.
- 6** Press the REC/EDIT button where you want to end editing (OUT point).
Editing ends, but the tape continues to run in playback mode.

- 7** Press the STOP button to stop the tape.

Note

To ensure a stable picture, start playback at least three seconds before the IN point.

Maintenance

Head Cleaning

Use the BCT-HD12CL Cleaning Cassette to clean the video and audio heads. Read the instructions included with the cleaning cassette carefully, as improper usage can damage the heads.

Follow the procedure below to clean the heads.

Insert the cleaning cassette.

The tape runs at normal playback speed for about 3 seconds as it cleans the heads. The cleaning cassette is automatically ejected when the head cleaning finishes.

Note

Do not run the cleaning tape more than 6 times in succession to avoid damaging the heads.

Please refer to the supplied Maintenance Manual on cleaning the video and audio heads.

Moisture Condensation

If you suddenly move the VTR from a cold location to a warm one, or use the VTR in a very humid place, moisture in the air can form on the head-drum or tape guide. This is called moisture condensation. If you play a tape under these conditions, the tape may adhere to the drum where moisture has collected and become damaged.

If moisture condenses on the head-drum while you are operating the VTR, the error message "ERROR-10" appears in the time data display section.

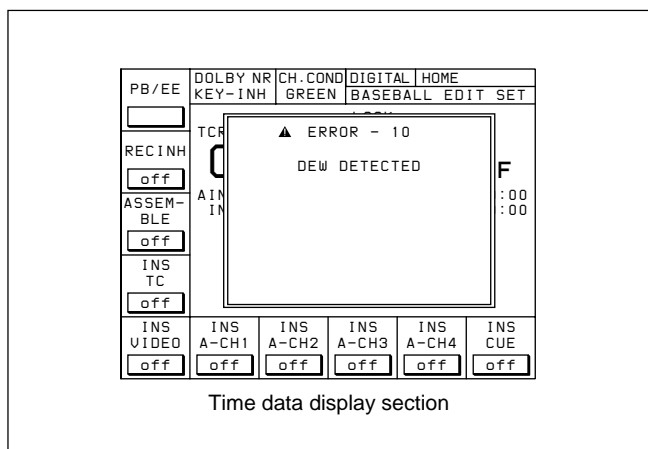

When moisture condensation has occurred

When this error message appears, the VTR enters the protection mode and certain operations become inoperable.

Once the moisture has evaporated, the error message disappears and the VTR becomes normal.

Please refer to the supplied Maintenance Manual on protection mode.

If "ERROR-10" appears immediately after turning the VTR on

Leave the VTR turned on and wait until the error message goes off. Inserting a cassette is not possible while the message is on.

When the error message disappears, you can use the VTR.

If you move the VTR from a cold to a warm location

Leave the VTR turned off for about ten minutes since some time is needed for the condensation-detection mechanism to work.

Specifications

General

Record format	HDCAM
Power requirements	100 to 240 V AC \pm 10%, 50/60 Hz
Power consumption	230 W
Peak inrush current	
(1) Power ON, current probe method: 50 A (240 V), 14 A (100V)	
(2) Hot switching inrush current, measured in accordance with European standard EN55103-1: 10 A (230V)	
Operating temperature	+5°C to +40°C (+41°F to + 104°F)
Storage temperature	-20°C to +60°C (-4°F to + 140°F)
Humidity	25% to 80% (relative humidity)
Mass	35 kg
Dimensions	427 \times 237 \times 520 mm (w/h/d) (16 ³ / ₄ \times 9 ³ / ₈ \times 20 ¹ / ₂ inches)

Tape system

Tape speed	77.4 mm/s (with the frame frequency of 24Hz) 80.7mm/s (with the frame frequency of 25Hz) 96.7mm/s (with the frame frequency of 30Hz)
Digital record/playback time (Using L-size cassette)	155 minutes (with the frame frequency of 24Hz) 149 minutes (with the frame frequency of 25Hz) 124 minutes (with the frame frequency of 30Hz)
Fast forward/rewind time	Approx. 3 minutes (Using L-size cassettes)

Search speed	Shuttle mode: Still to approx. \pm 60 times normal playback speed (with the frame frequency of 24Hz) Still to approx. \pm 58 times normal playback speed (with the frame frequency of 25Hz) Still to approx. \pm 50 times normal playback speed (with the frame frequency of 30Hz) Variable mode: -1 to +2 times normal playback speed Jog mode: Still to \pm 2 times normal playback speed
Dynamic Tracking range	-1 to +2 times normal playback speed
Load/unload time	6 seconds or less
Recommended tapes	HDCAM cassette (S- and L-sizes)

Digital video system

Digital video signal format

Sampling frequency	Y: 74.25 MHz P _B /P _R : 37.125 MHz
Quantization	10 bits/sample (Compression: 8 bits/sample)
Compression	Coefficient recording system
Channel coding	S-NRZI PR-IV
Error correction	Reed-Solomon code
Error concealment	Adaptive three dimensional

Analog composite output (with optional HKDV-501A)

Bandwidth	Y: 0 to 5.75 MHz +0.5 dB/-3.0 dB
S/N ratio	56 dB or more
Y/C delay	15 ns or less
K factor (2T Pulse)	1% or less
Output SCH phase	Based upon RS-170A/CCIR R.624-3

Digital audio system

Digital audio signal format (CH-1 to CH-4)

Sampling frequency	48 kHz (synchronized with video)
Quantization	20 bits/sample
Wow and flutter	Below measurable level
Headroom	Selectable settings: 20, 18, 16, 15, 14, 12, and 9 dB
Emphasis	T1=50 μ s, T2=15 μ s (on/off selectable in recording mode)

Analog output

A/D quantization	20 bits/sample
D/A quantization	20 bits/sample
Frequency response	20 Hz to 20 kHz +0.5 dB/−1.0 dB (0 dB at 1 kHz)
Dynamic range	More than 95 dB (at 1 kHz, emphasis on)
Distortion	Less than 0.05% (at 1 kHz, emphasis on, reference level ¹⁾)
Crosstalk	Less than −90 dB (at 1 kHz, between any two channels)

Analog audio (Cue track)

Frequency response	90 Hz to 12 kHz \pm 3 dB
S/N ratio	More than 45 dB (at 3% distortion level)
Distortion	Less than 2% (T.H.D at 1 kHz reference level ¹⁾)
Wow and flutter	Less than 0.2% rms

1) Reference level: +4 dBm

Note

The ANALOG AUDIO INPUT CH1/2/3/4/CUE connectors, ANALOG AUDIO OUTPUT CH1/2/3/4/CUE connectors, and TIME CODE IN/OUT connectors (XLR 3-pin) have

Input connectors

HD SDI INPUT

BNC (1 + 1 INPUT MONITOR)
HD SDI (1.485 Gbps) (conforms to SMPTE 292M/BTA S-004B)

SDTI (OPTION) IN

(when the optional HKDV-506A is installed)

BNC (1)
SDTI (270Mbps)

REF. IN

BNC (2 + 2 loop-through)

HD

Trilevel SYNC
0.6 V p-p, 75 Ω , sync negative

SD

Black burst
0.286 V p-p, 75 Ω , sync negative

AUDIO INPUT (AES/EBU)

BNC (2 + 2 loop-through)

CH1/2 and CH3/4

AES/EBU format, unbalanced

AUDIO INPUT

XLR 3-pin, female (5)

CH1, 2, 3, 4 and CUE

LOW OFF: −60 dBu, high impedance, balanced

HIGH OFF: +4 dBu, high impedance, balanced

HIGH ON: +4 dBm, 600 Ω termination, balanced

TIME CODE IN

XLR 3-pin, female (1)

0.5 to 18 Vp-p, 10 k Ω , balanced

gender conventions for input and output connectors in Japan which are opposite to those everywhere else in the world. If using this unit with non-Japanese specification equipment, use male/female adaptors.

Specifications

Output connectors

HD SDI OUTPUT

BNC (4, MONITOR with superimposed text)

1, 2, 3 and MONITOR

SDI (1.485 Gbps) (conforms to SMPTE 292M/BTA-S004B)

D CONV. SDI OUT (OPTION)

(when the optional HKDV-501A is installed, D1/D2 switchable)

BNC (3, 3(SUPER) with superimposed text)

1, 2 and 3(SUPER)

D1 SDI (270 Mbps) (conforms to SMPTE 259M/CCIR-656-III)

D2 SDI (143 Mbps) (conforms to SMPTE 259M/CCIR-656-III)

D CONV. OUT (OPTION)

(when the optional HKDV-501A is installed)

BNC (2, COMPOSITE (SUPER) with superimposed text)

COMPOSITE (SUPER)

1.0 Vp-p, 75 Ω , sync negative

SYNC

Black burst

0.286 Vp-p, 75 Ω , sync negative

SDTI (OPTION) OUT

(when the optional HKDV-506A is installed)

BNC (1)

SDTI (270 Mbps)

PULL DOWN OUT (OPTION)

(when the optional HKDV-507/507D is installed)

BNC (2, with superimposed text)

REF. OUT

BNC (2)

1125 SYNC Trilevel SYNC

0.6 Vp-p, 75 Ω , sync negative

AUDIO OUTPUT (AES/EBU)

BNC (2)

CH1/2 and CH3/4

AES/EBU format, unbalanced

AUDIO OUTPUT

XLR 3-pin, male (5)

CH1, CH2, CH3, CH4 and CUE

+4 dBm, (with 600 Ω load), low impedance, balanced

MONITOR OUTPUT

XLR, 3-pin, female (2)

L and R

+4 dBm (with a 600 Ω load), low impedance, balanced

TIME CODE OUT

XLR, 3-pin, male (1)

2.2 Vp-p, low impedance, balanced

PHONES

JM-60 stereo phone jack

$-\infty$ to -12 dBu (with an 8 Ω load), unbalanced

Remote connectors

CONTROL PANEL

D-sub 15-pin, female

REMOTE 1-IN D-sub 9-pin, female

REMOTE 1-OUT D-sub 9-pin, female

RS-232C D-sub 25-pin, female

VIDEO CONTROL

D-sub 9-pin, female (for optional HKDV-503)

PARALLEL I/O (50P)

D-sub 50-pin, female (with optional BKDW-509)

Note

The ANALOG AUDIO INPUT CH1/2/3/4/CUE connectors, ANALOG AUDIO OUTPUT CH1/2/3/4/CUE connectors, and TIME CODE IN/OUT connectors (XLR 3-pin) have gender conventions for input and output connectors in Japan

which are opposite to those everywhere else in the world. If using this unit with non-Japanese specification equipment, use male/female adaptors.

Accessories supplied

AC power cord (1)
RCC-5G 9-pin remote control cable (1)
PSW 4 × 16 screws for rack mounting (4)
SRAM 64 KB Memory card (1)
Operation Manual (1)
Maintenance Manual Part 1 (1)

Optional accessories

HKDV-501A HD-SD Converter Board
HKDV-502 HD Line Converter Board
HKDV-503 HD Digital Video Controller
HKDV-506A SDTI Board
HKDV-507/507D HD Pull Down Board
BKDW-509 Parallel (50-pin) Interface Kit
RMM-110 Rack Mount Adaptor
BCT-HD12CL Cleaning Cassette
MLB-1B-100 Memory Label

Recommended accessories

For details about recommended accessories, contact your Sony service representative.

Parallel/serial converter

HD-694 equivalent from ASTRO DESIGN Corporation

XLR/BNC adaptors

BCJ-XP-TRA equivalent from CANARE Corporation

Design and specifications are subject to change without notice.

Operation Information Display

Information on the operational status of the unit and discrepancies between the field frequency of the tape and that of the unit can be shown in the display.

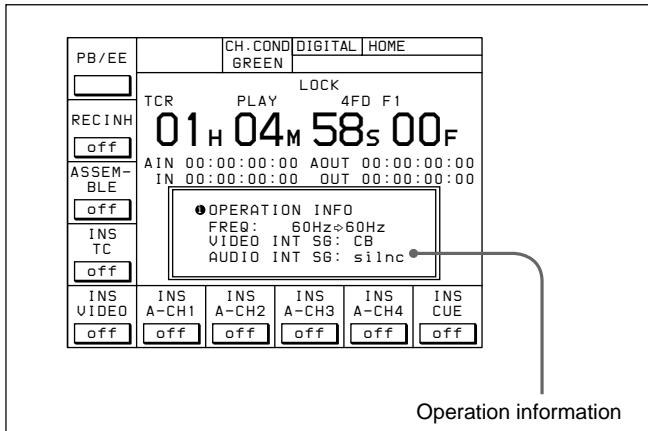

Note

The operation information can be viewed in any menu except the CUE or SET UP menu.

Selecting items to be displayed

Use 121.INFORMATION DISPLAY in the VTR SETUP menu to select the items to be displayed. The items and the functions that can be set by item 121. are as follows:

SYSTEM FREQUENCY

- off:** The field frequency of both the unit and the tape are not displayed.
- diff:** The field frequency of both the unit and the tape are displayed only when they do not match.
- ever:** The field frequency of both the unit and the tape are always displayed.

ACTIVE LINE (HD)

- off:** The effective scanning line number to be input or played back, and to be output are not displayed.
- diff:** The effective scanning line number to be input and output are displayed only when they do not match.
- ever:** The effective scanning line number to be input and output are always displayed.

EOS DISPLAY

- off:** EOS is not displayed.
- on:** EOS is displayed.

VIDEO INT SG

- off:** The type of the test signal generated by the internal video test signal generator is not displayed.
- on:** The type of the test signal generated by the internal video test signal generator is displayed.

AUDIO INT SG

- off:** The operating status of the internal audio test signal generator is not displayed.
- on:** The operating status of the internal audio test signal generator is displayed.

META DATA

- off:** Settings are not displayed during the recording of meta data.
- on:** Settings are displayed during the recording of meta data.

Information displayed for each item

The information displayed for ACTIVE LINE (HD), VIDEO INT SG and AUDIO INT SG are specified by T02.INTERNAL VIDEO SIGNAL GENERATOR (HD), T03.INTERNAL VIDEO SIGNAL GENERATOR LINE SELECT and T04.INTERNAL AUDIO SIGNAL GENERATOR.

The T02.INTERNAL VIDEO SIGNAL GENERATOR (HD) settings and display information

Setting of item T02	Displayed information
off	off
COLOR BARS	CB
MULTIBURST	MB
10 STEPS	10STP
PULSE & BAR	P&BAR
RAMP	RAMP
BLACK	BLACK

The T03.INTERNAL VIDEO SIGNAL GENERATOR LINE SELECT settings and display information

Setting of item T03	Displayed information
1035	1035
1080	1080

Note

This setting is only active when the frame frequency of the unit is 29.97 Hz or 30 Hz.

The T04.INTERNAL AUDIO SIGNAL GENERATOR settings and display information

Setting of item T04	Displayed information
off	off
silence	silnc
1 kHz sine	1kHz

Display priority of display messages

Messages are displayed in the following order of priority:

Error messages



Lost lock messages



Warning messages



Player edit points and time data



Operation information



Pull down time data (when optional HKDV-507/507D
HD Pull Down Board is installed)

Or

24-frame time data when playback in 25-frame mode
(off-speed playback) is selected

Error Messages and Warning Messages

Error Messages

When the unit ceases to operate correctly due to malfunction or an internal system error, the alarm will sound and an error message will be displayed on the display.

Only one message will be displayed even when multiple errors occur, but the error log menu keeps a history of the errors.

For more information about error messages, refer to the Maintenance Manual.

After the error occurs, eliminate the cause of the error and turn the unit back on. If the error message appears again when the unit is turned on, contact your Sony representative.

For more information about eliminating errors, refer to the supplied Maintenance Manual.

Protection Mode

To protect the tape and the mechanical parts of the VTR, the servo control system automatically stops tape transport and the drum motor and enters protection mode when an error occurs. Cassettes may not be inserted or ejected during protection mode.

Note

When a cassette is stuck in the unit because of protection mode, make sure to disconnect the power before removing the cassette manually.

For information about removing cassettes manually, refer to the supplied Maintenance Manual.

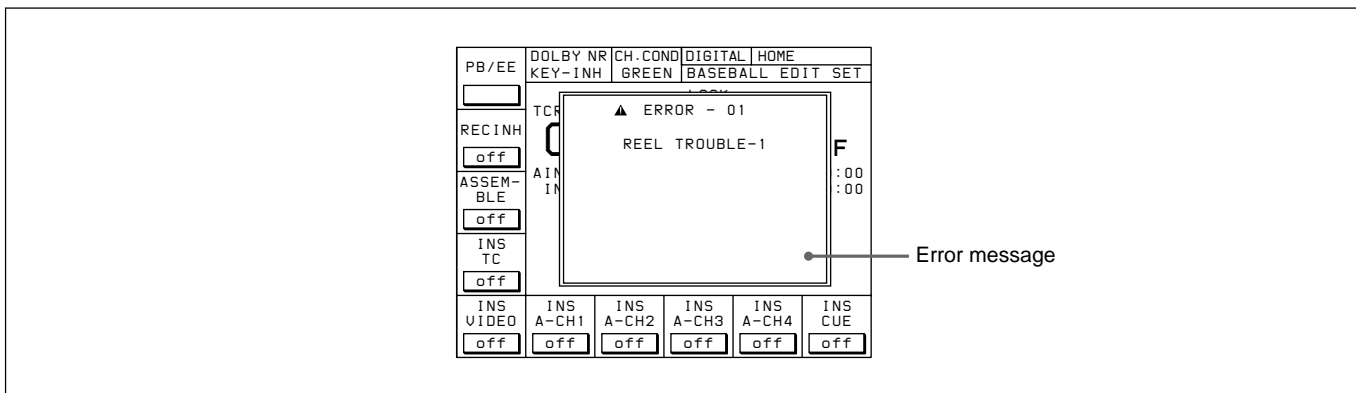

- 01 **REEL TROUBLE-1:** Slack in the tape was detected during threading or unthreading.
- 02 **REEL TROUBLE-2:** Slack in the tape was detected during searching, rewinding, or fast-forward.
- 03 **REEL TROUBLE-3:** Slack in the tape was detected during playback or recording.
- 04 **REEL TROUBLE-4:** Abnormality in tape speed was detected during fast-forward or rewinding.
- 05 **REEL TROUBLE-5:** Abnormality detected in the operation of S or T reels during cassette compartment operation. Or, current flow for S or T reels deviated from the fixed value.
- 06 **TAPE TENSION ERROR:** Excessive tension detected during recording or playback.
- 07 **CAPSTAN TROUBLE:** Abnormality detected in capstan motor operation.
- 08 **DRUM TROUBLE:** Abnormality detected in drum motor operation.
- 09 **TH/UNTH MOTOR TIME OUT:** Abnormality detected during threading or unthreading.
- 0A **THREADING TROUBLE:** Tape top process did not end normally during threading.
- 10 **DEW DETECTED:** Condensation detected.
- 11 **TAPE TOP/END SENSOR TROUBLE:** Top and end of tape were detected simultaneously.
- 12 **TAPE TOP SENSOR TROUBLE:** Trouble with the tape top sensor.
- 13 **TAPE END SENSOR TROUBLE:** Trouble with the tap end sensor.
- 14 **FAN MOTOR TROUBLE:** Abnormality detected in the operation of the fan motor.
- 20 **CASSETTE COMPARTMENT MOTOR LOCK:** Abnormality detected during cassette compartment operation.
- 21 **REEL SHIFT MOTOR LOCK:** Abnormality detected when moving the reel base corresponding to the cassette size.
- 22 **REEL POSITION SENSOR TROUBLE:** Positions for L cassette and S cassette reel positions were detected simultaneously.
- 92 **INTERNAL INTERFACE:** Abnormality detected in the communication with the CPU on the circuit board.
- 93 **CPU INITIALIZE ERROR:** When the unit was powered up, an abnormality was detected in the initial communication with the CPU.
- 97 **SV NV-RAM TROUBLE:** An abnormality was detected while reading servo adjustment data after the unit was turned on.
- A0 **READ WRITE ERROR:** Error occurred during reading and writing to the SS-88 on-board RAM.
- A1 **SY ROM ERROR:** Error detected while reading system computer ROM data when the unit was turned on.

-
- A2 DR NOV RAM CHECK SUM ERROR:** Error detected while reading machine type data when the unit was turned on.
 - A3 SYS NOV RAM CHECK SUM ERROR:** Error detected while reading menu settings data when the unit was turned on.
 - A4 PLAYER CONTROL COMMAND BUFFER FULL:** The 9 pin serial communication send buffer for player control is full.
 - A5 RS-422 REMOTE COMMAND BUFFER FULL:** The 9 pin serial communication receive buffer is full.
 - B0 DT HARD ERROR:** Error detecting during DT distortion removal.
 - B1 TCG HARD ERROR:** Possibly a hardware error in the time code generator circuit or peripheral hardware.
 - B2 DCP-26 BOARD INSTALLATION ERROR:** The two DCP-26 boards are installed.
 - B3 DCP-26 & PD-94 BOARD INSTALLATION ERROR:** The DCP-26 board and PD-94 board are installed to the wrong position.

Error Messages and Warning Messages

Warning Messages

When one of the problems described below is detected, a warning mark is displayed in the upper left corner of the display. Operation can continue even when the mark is flashing.

When the mark is flashing, the warning message can be displayed by using the tip of a small pointed object to press the MAINTENANCE switch.

Note

The warning messages can be viewed in any menu except the CUE or SET UP menu.

Only one message will be displayed even if there are multiple messages, but a history of errors is kept in the error log menu.

For more information about warning messages, refer to the Maintenance Manual.

Use the displayed warning information to eliminate the cause of the warning.

For more information about eliminating the cause of warning, refer to the Maintenance Manual.

To automatically display a warning message

Whenever a warning occurs, change item 120.WARNING DISPLAY in the VTR SETUP menu to on.

To clear a warning message

To cancel the display of a warning message, refer to "Clearing warning messages" on page A-12.

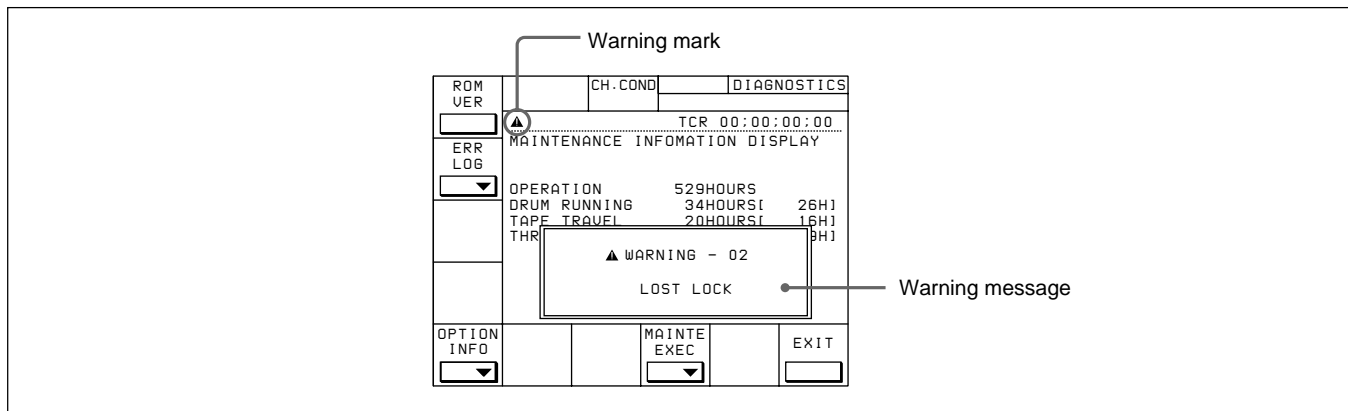

- 01 **NO EXTERNAL REFERENCE:** There is no reference signal on the selected REF INPUT connector. The VTR is using an internal reference signal.
- 02 **LOST LOCK:** Capstan servo lock was lost during playback, recording, or editing.
- 03 **NO EXTERNAL SD REFERENCE ON PD:** When item A05. PD EXT SD REF LOCK MODE in the VTR SETUP menu is set to "lock1" or "lock2," no external SD reference signal is input (only when the HKDV-507D is installed).
- 04 **HD & SD REF ASYNCHRONOUS:** When item A05. PD EXT SD REF LOCK MODE in the VTR SETUP menu is set to "lock1" or "lock2," HD reference signal and external SD reference signal are not synchronized (only when the HKDV-507D is installed).
- 08 **NO SDI INPUT:** A SDI input signal cannot be detected.
- 09 **NO SDI AUDIO INPUT:** No audio data detected in the SDI input signal.
- 10 **VITC NOT READ:** VITC cannot be correctly read from the tape.
- 11 **AUDIO PLL UNLOCKED:** Audio lock generator PLL not locked to the video reference signal.
- 14 **NO PB RF SIGNAL:** Playback heads cannot correctly read digital data from the tape.
- 15 **INCONSISTENT EMPHASIS:** Emphasis information on the tape is inconsistent with the system emphasis status.
- 16 **INCONSISTENT FORMAT OF META DATA:** The meta data being input and the meta data recorded on the tape have different formats.
- 17 **PB FREQUENCY IS UNSUITABLE:** The cassette is ejected automatically in line with the setting of item 018.AUTO EJECT LEVEL in the VTR SETUP menu because the system frequency of the VTR and the frequency of the signal recorded on the tape do not match.
- 1C **NO A1/A2 INPUT:** No carrier detected on digital audio input on channels 1 and 2
- 20 **NO A3/A4 INPUT:** No carrier detected on digital audio input on channels 3 and 4
- 2D **INVALID SDI DATA:** SDI input signal data is invalid.
- 34 **NO CASSETTE COMPARTMENT MODE:** The cassette compartment does not operate during no cassette compartment mode.
- 3B **NO LTC REPRODUCED:** LTC signal not detected on the tape.
- 45 **DT UNLOCKED:** DT cannot be correctly traced during playback, recording, or editing.
- 50 **PROCESSOR IS IN TEST MODE:** The processor is in test mode.
- 55 **VIDEO PLL UNLOCKED:** Video lock generator PLL not locked to the video reference signal.

Error Log Menu

The time and time codes of errors and warnings occurring during operation can be displayed in a list form in the display. (Maximum listing is 99 items.)

Openig the error log menu

Use the tip of a narrow object to press the MAINTENANCE switch and press the **[F2]** (ERR LOG) button.

PAGE TOP	CH. COND	DIAGNOSTICS
<input type="button" value="▼"/>	TCR 00:00:01:05	
PAGE END	ERROR LOG	'97/03/06 10:32:23
<input type="button" value="▼"/>	TOTAL 03	
FULL MSG	1. 00:00:00:00 (E) A3	
<input type="button" value="▼"/>	SYS NOU RAM CHECK SUM ERR ...	
ALL CLEAR	2. 23:59:59:09 (C) 0B	
<input type="button" value="▼"/>	VIDEO DATA ERROR	
WARNI-NG	ERROR	CONDI-TION
<input type="button" value="▼"/>	<input type="button" value="▼"/>	<input type="button" value="▼"/>
		TIME
		<input type="button" value="TC"/>
		EXIT
		<input type="button" value=""/>

Error Log Menu

Button	Display	Function	Setting
[F1]	PAGE TOP	Move to the top page	on, off
[F2]	PAGE END	Move to the last page	on, off
[F3]	FULL MSG	Display in full the message selected with the cursor	on, off
[F5]	WARNING	Display warning messages	on, off
[F6]	ERROR	Display error messages	on, off
[F7]	CONDITION	Display condition messages	on, off
[F9]	TIME	Toggle between time code are real time display	TC, REAL
[F10]	EXIT	Return to display of maintenance information	
SFT/ [F4]	ALL CLEAR	Clear messages (LOG DATA)	
ALT/ [F8]	CANCEL EDIT	Display the CANCEL EDIT screen	
ALT/ [F9]	REAL TIME	Display the REAL TIME screen	

For more information about error log menu settings, refer to the Maintenance Manual.

Error Messages and Warning Messages

Clearing warning messages

- 1 Press the ALT/**F8** (CANCEL EDIT) button.
- 2 Select the message to be cleared using the **▲** and **▼** buttons.
- 3 Press the **F2** (MARK) button.
An asterisk “*” will appear in front of the message.
The message will not be displayed or saved.

Cancelling removal

To cancel the removal of a warning message, press the **F2** (MARK) button.

Adjusting the clock

Press the ALT/**F9** (REAL TIME) button in the error log menu and use the setting below.

Get current time codes

Hold down the SFT button and press the **F5** (GET TC) button.

Setting the data and time

Hold down the SFT button and press the **F6** (SET) button.

Use the **◀** and **▶** buttons to move the bar to the location to be adjusted.

Use the numeric keys to change the value.

Adjusting minutes and second to zero

Hold down the SFT button and press **F8** (ZERO) button.

Selecting daylight saving time and normal time

Hold down the SFT button and press **F9** (SEASON) button.

STANDARD: normal time

SUMMER: daylight saving time (one hour ahead of normal time)

Note

Changing between normal and daylight saving times changes the current time by one hour.

Even if the change crosses midnight, the current date is not changed.

AES/EBU format

A standard format for the transfer of digital audio signals. In this format, two audio signals can be input/output through one XLR-type connector.

Assemble editing

An edit mode for adding new scenes to the end of previously recorded scenes. New video signals are recorded for each control signal, but continuity with the control signal preceding the edit point is maintained electrically. Because assemble editing in the middle of a scene will cause a break in the video image at the end of the insertion, this is not a practical method for inserting new video data. This should be done with insert editing. See also Insert editing.

Backspace editing

Also called phase matching. During backspace editing, the VTR automatically rewinds the tape a few seconds after recording of a scene has been completed. This allows the tape to attain a stable speed before the start of recording of the next scene, thus maintaining signal continuity during editing.

Bridging connection

A connection that allows a signal input to an input terminal to pass through the unit and exit from an output terminal for input to a third piece of equipment.

Capstan

A drive mechanism that moves the tape at a specified speed. Its rotation is normally synchronized with a reference sync signal.

Color frame

A color subcarrier phase having one cycle that consists of two frames (four fields) in the NTSC format.

Color frame locking

A procedure in which the time code frame value is set to an odd number for the first and second color fields, and to an even number for the third and fourth color fields.

Color framing

A method to maintain color subcarrier phase continuity by performing editing in two-frame units in order to achieve stable video without horizontal fluctuation at the edit points when editing downconverted composite video signal.

Component video signal

A video signal that consists of a luminance signal (Y) and two chrominance (color-difference) signals (R-Y, B-Y).

Composite video signal

A signal that consists of video (luminance and color sub carrier), sync (horizontal and vertical), and color burst signals.

Condensation

Moisture that collects on the head drum of the tape transport mechanism, causing damage to the tape and malfunction of the VTR.

CTL

Abbreviation for control signal. A pulse signal that can be counted, to determine the number of frames, and therefore the tape's running time. Used mainly for adjusting the tracking position of video heads, and to achieve time code continuity during continuous recording. This signal is recorded on a longitudinal tape track.

Cue point

A point used to mark the beginning of a section of tape so that it can be located for later playback or editing.

Drop frame mode

When the field frequency of this unit is 59.94 Hz, the actual number of frames per second is approximately 29.97, while the time code value advances one second every 30 frames. In drop frame mode, the time code is advanced such a way that this difference in the value between real time and the time codes is corrected. Specifically, two frames are skipped at the beginning of each minute, except for every tenth minute, so that the frame value for time codes matches that for real time. See also Non-drop frame mode.

E-E mode

Abbreviation for Electric-to-Electric mode. In this mode, the signals are passed through the VTR's electronics before output but do not pass through the magnetic converter circuits such as the tape and head circuits. This mode is used for confirming input signals or adjusting the input level.

Effect edit mode

When editing a tape using a switcher or when editing special effects, the pixels comprising the picture are often not dubbed to the same positions as those of the original. In the case of repeated dubbings, this shifting of pixels produces an accumulation of calculation errors during the compression/expansion process; this may result in an increase in low-level noise within the signal. The effect edit mode minimizes the production of this noise. Note, however, that a slight loss in picture resolution may be observed in this mode.

Emphasis

Emphasizing the high frequencies of a signal before processing (pre-emphasis) and de-emphasizing those high frequencies before output (de-emphasis). This reduces deterioration of the signal-to-noise ratio in the high frequency range.

External synchronization

A method to maintain color subcarrier phase continuity by performing editing in two-frame units in order to achieve stable video without horizontal fluctuation at the edit points. For editing, a recorder VTR (or master VTR) and a player VTR (or source VTR or slave VTR) are used, and external synchronization is commonly used to ensure that the operation timing control signals and time reference signals are synchronized.

Insert editing

An edit mode for inserting new scenes into the middle of previously recorded scenes. CTL signals previously recorded on the tape are used. Consequently, this mode cannot be used for blank tapes. This mode assumes that CTL signals have somehow be recorded to the tape already. See also Assemble editing

Longitudinal time code

See LTC.

LTC

Abbreviation for Longitudinal Time Code. This is the time code recorded onto a longitudinal track of the tape. During the playback of still pictures, LTC cannot be read since the tape is not moving. During slow playback, the LTC output is so small that it may not be read correctly, depending on the playback speed. See also VITC.

Glossary

Non-drop frame mode

In this mode, drop frame mode processing is not performed. Since there is no frame cutting, a discrepancy of about 86 seconds occurs each day (in the case of a field frequency of 59.94 Hz) which causes problems when editing programs in units of seconds using the number of frames as a reference.

See also Drop frame mode.

Preroll

The rewinding of a video tape in the player or recorder VTR by a certain length before an edit point, allowing the tape to attain a stable speed at the edit point and synchronization with the other video tape during editing.

Reference video signal

A video signal containing a sync signal or sync and burst signal, used as a reference for synchronizing video equipment.

Servolocking

The locking of the phase and speed of a VTR's head drum rotation and tape transport to a reference signal during recording and playback.

Standby-off mode

A mode in which head drum rotation is stopped and tape tension is released, and thus the VTR is not ready for immediate recording and playback. This mode alleviates the tape and video heads from wear or damage.

Standby-on mode

A mode in which the head drum rotates with the tape wrapped around it, and thus the VTR is ready for immediate recording or playback. The VTR enters standby-off mode after remaining in standby-on mode for a specified length of time to prevent wear or damage to the tape and video heads.

Time code

A digital signal recorded on the video tape that supplies information such as hour, minute, second and frame number for each frame to facilitate the setting of edit points or searching for specific scenes on the tape.

There are two types of time codes: SMPTE (for the NTSC color system) and EBU (for the PAL/SECAM color system); and two time code recording formats: LTC (longitudinal time codes) which are CTL signals and audio signals simultaneously recorded longitudinally on the tape and VITC (vertical interval time codes) which are recorded on the video signal track.

Tracking

The synchronizing of the head drum rotation phase and tape transport phase during playback and recording. Tracking is adjusted to eliminate picture instability when playing back material recorded on another VTR.

User bits

A recordable 32-bit section in each time code on a video tape for recording such information as the recording year, month, and day, and the tape or program ID number.

Vertical interval time code

See VITC.

VITC

Abbreviation for Vertical Interval Time Code. This is a time code recorded on a video signal track during the vertical blanking interval. This VTR writes this time code in the AUX data area in the video signals. It can be read correctly even during slow or still picture playback. See also LTC.

Menu List

Items in the VTR SETUP menu are divided into categories according to type of setting they perform.

Descriptions on each item are given below:

- Items related to the hours meter (H01~)
- Items related to VTR operations (001~)
- Items related to operation panels (101~)
- Items related to the remote interface (201~)
- Items related to editing (301~)
- Items related to prerolling (401~)

- Items related to recording protection (501~)
- Items related to the time code (601~)
- Items related to the video control (701~)
- Items related to the audio control (801~)
- Items related to digital process (901~)
- Items related to pull down control (A01~)
- Other items (T01~)

For details on the VTR SETUP menu, refer to “4-7-1 VTR SETUP Menu” on page 4-61.

Items Related to the Hours Meter (H01~)

Item number	Item	Function
H01	OPERATION HOURS	Displays the total number of hours that the VTR has been turned on and operated.
H02	DRUM RUNNING HOURS	Displays the total number of hours that the drum has rotated with tape threaded.
H03	TAPE RUNNING HOURS	Displays the total number of hours that the VTR has been in playback, fast-forwarding, rewinding, jog, shuttle, variable speed, and edit modes. (Does not include still mode.)
H04	THREADING COUNTER	Displays the total number of threadings and unthreadings.
H12	DRUM RUNNING HOURS (resettable)	Displays the total number of hours that the drum has run with tape threaded since last reset. Use this information as a guide for head-drum replacements. <i>For details, refer to the Maintenance Manual Part 1.</i>
H13	TAPE RUNNING HOURS (resettable)	Displays the total number of hours that the VTR has been in playback, jog, shuttle and variable speed modes since last reset. (Does not include stop and still modes.) Use this information as a guide for replacing the fixed head and pinch rollers. <i>For details, refer to the Maintenance Manual Part 1.</i>
H14	THREADING COUNTER (resettable)	Displays the total number of threadings and unthreadings since last reset. <i>For details, refer to the Maintenance Manual Part 1.</i>

Menu List

Items Related to VTR Operations (001~)

The values enclosed in a box are factory settings.

Item number	Item	Settable range	Function
001	PRE-READ	<input type="checkbox"/> off audio/video audio only video only	Selects the pre-read (read-before-write) mode for insert editing. off: No pre-read operation audio/video: Carry out pre-read editing for both audio and video audio only: Carry out pre-read editing for audio only video only: Carry out pre-read editing for video only
002	REC INHIBIT select	<input type="checkbox"/> off all/crash REC/video CTL/audio CTL	Selects the record inhibit mode. off: Recording is enabled. (The REC INHIBIT indicator does not light.) all/crash/video/audio: Recording is inhibited on the set channels. (The REC INHIBIT indicator either lights or goes off.) The scope of inhibiting recording is determined by menu item 003.
003	REC INHIBIT AREA select	<input type="checkbox"/> all crash REC video/CTL audio/CTL [casst]	Selects the scope to which inhibiting recording applies. all: All recording is inhibited. (The REC INHIBIT indicator lights.) crash REC: The normal recording mode is inhibited. Use this setting when you wish to record in assemble editing or insert editing only. video/CTL: Recording of video and CTL is inhibited. audio/CTL: Recording of audio and CTL is inhibited. [casst]: When the recording protection plug on the cassette is pushed in, this setting is displayed. This setting cannot be selected. The REC INHIBIT indicator lights or flashes to indicate the state of the recording inhibit mechanism on the cassette. <i>For details, see item 104.</i>
004	CAPSTAN LOCK select	<input type="checkbox"/> 2FD 4FD	When editing or playing back a tape with decoded component signals, select the appropriate setting depending on your purpose. 2FD: This setting locks the capstan servo in two-field units. This is the normal setting for editing or playing back HD or D1 signals. 4LOCK: The capstan servo is locked to the color frame every 4 fields. If color frames occur intermittently during playback, the capstan servo is locked when the next color frame appears. 4HOLD: The capstan servo is locked to the color frame every 4 fields. If color frames occurs intermittently during playback, the capstan servo stays locked to that color frame. Note <ul style="list-style-type: none"> This setting is only active when the frame frequency of the unit is 29.97 Hz or 30 Hz. To lock composite signal output to four fields on this VTR, set item 005. to external and 006. to extern SD.

Item number	Item	Settable range	Function
005	SERVO/AV REFERENCE select	<input type="checkbox"/> input auto external	<p>The servo reference is determined by the following menu.</p> <p>input: The reference signal is obtained from the HD SDI INPUT connectors or SDTI (OPTION) IN connector.</p> <p>auto: During recording and in the edit preset state, the reference signal is obtained from the HD SDI INPUT connectors or SDTI (OPTION) IN connector.</p> <p>Note</p> <p>When item 001 is not set to off, the reference signal is always external.</p> <p>In all other cases, the servo operates using the signal selected in item 006 as the reference signal. If the signal selected in item 006 is not present, the servo operates using an internal reference signal.</p> <p>external: The servo reference signal is always external.</p>
006	EXTERNAL REFERENCE select	<input type="checkbox"/> extrn HD extrn SD	<p>When item 005 is set to external, this selects the signal used as reference by this unit.</p> <p>extrn HD: The signal input to the REF. IN HD connector is used as the reference signal for playback and audio signal recording.</p> <p>extrn SD: The signal input to the REF. IN SD connector is used as the reference signal for playback and audio signal recording.</p>
007	SYNC PLAY	<input type="checkbox"/> off on	<p>This is the mode for automatic correction at the start of playback. In sync play mode, for example when playing back the VTR from a preroll point, the IN point is reached after exactly the preroll time has elapsed.</p> <p>off: Selects normal playback mode.</p> <p>on: Activates the sync play function for playback.</p> <p>Note</p> <p>In sync play mode, the time after the tape transport starts until the video and sound appear is longer than in the normal playback mode.</p>
008	LOCAL FUNCTION ENABLE	all disable <input type="checkbox"/> stop & eject all enable local key map	<p>When this unit is used in remote control mode, this selects which buttons on the control panel operate.</p> <p>all disable: All switches and buttons are disabled.</p> <p>stop & eject: Only the STOP and EJECT buttons operate.</p> <p>all enable: All switches and buttons except the RECORDER and PLAYER buttons are enabled.</p> <p>local key map: Only the buttons enabled in item 009 are operational.</p>

Menu List

Item number	Item	Settable range	Function
009	LOCAL KEY MAP		Enables/disables the buttons on this unit when it is in remote control mode.
	Sub items		
	STOP	disable enable	disable: The STOP button is disabled in remote control mode. enable: The STOP button operates in remote control mode.
	PLAY	disable enable	disable: The PLAY button is disabled in remote control mode. enable: The PLAY button operates in remote control mode.
	REC/EDIT	disable enable	disable: The REC/EDIT button is disabled in remote control mode. enable: The REC/EDIT button operates in remote control mode.
	STANDBY	disable enable	disable: The STANDBY button is disabled in remote control mode. enable: The STANDBY button operates in remote control mode.
	EJECT	disable enable	disable: The EJECT button is disabled in remote control mode. enable: The EJECT button operates in remote control mode.
	JOG	disable enable	disable: The JOG button is disabled in remote control mode. enable: The JOG button operates in remote control mode.
	SHUTTLE	disable enable	disable: The SHUTTLE button is disabled in remote control mode. enable: The SHUTTLE button operates in remote control mode.
	VAR	disable enable	disable: The VAR button is disabled in remote control mode. enable: The VAR button operates in remote control mode.
	PREROLL	disable enable	disable: The PREROLL button is disabled in remote control mode. enable: The PREROLL button operates in remote control mode.
	PREVIEW/ REVIEW	disable enable	disable: The PREVIEW/REVIEW button is disabled in remote control mode. enable: The PREVIEW/REVIEW button operates in remote control mode.
	AUTO	disable enable	disable: The AUTO button is disabled in remote control mode. enable: The AUTO button operates in remote control mode.
	INPUT CHECK	disable enable	disable: The INPUT CHECK button is disabled in remote control mode. enable: The INPUT CHECK button operates in remote control mode.
	MENU&CURSOR	disable enable	disable: The menu buttons and the cursor control buttons are disabled in remote control mode. enable: The menu buttons and the cursor control buttons operate in remote control mode.
AUDIO INPUT	disable enable	disable: The AUDIO INPUT button is disabled in remote control mode. enable: The AUDIO INPUT button operates in remote control mode.	
MONITOR	disable enable	disable: The MONITOR button is disabled in remote control mode. enable: The MONITOR button operates in remote control mode.	

Item number	Item	Settable range	Function
017	PB/EE SELECT MENU		Selects output video and audio signals.
	Sub items		
	STAND BY OFF	PB/MU EE/EE	Selects the video and audio output signals in the "standby off" mode. PB/MU: The playback video signal is output. The audio output is muted. EE/EE: The input video and audio signals are output.
	STAND BY ON	PB/MU EE/EE EE/MU	Selects the video and audio output signals in the "standby on" mode. PB/MU: The playback video signal is output. The audio output is muted. EE/EE: The input video and audio signals are output. EE/MU: The input video signal is output. The audio output is muted.
	REC	PB/PB EE/EE	Selects the video and audio output signals during recording. PB/PB: The playback video and audio signals are output. EE/EE: The input video and audio signals are output.
	EDIT	PB/PB EE/EE	Selects the video and audio output signals during editing. PB/PB: The playback video and audio signals are output. EE/EE: The input video and audio signals are output.
	SHUTTLE	PB/MU EE/EE PB/PB	Selects the video and audio output signals during shuttle playback. PB/MU: The playback video signal is output. The audio output is muted. EE/EE: The input video and audio signals are output. PB/PB: The playback video and audio signals are output.
	JOG	PB/PB PB/MU	Selects the video and audio output signals during jog playback. PB/PB: The playback video and audio signals are output. PB/MU: The playback video signal is output. The audio output is muted.
	VAR	PB/PB PB/MU	Selects the video and audio output signals during "variable" playback. PB/PB: The playback video and audio signals are output. PB/MU: The playback video signal is output. The audio output is muted.
018	AUTO EJECT LEVEL	off LEVEL1 LEVEL2 LEVEL3	Selects the condition under which the cassette is automatically ejected after being played back for a few seconds. When the cassette is ejected in accordance with this setting, the warning message "17 PB FREQUENCY IS UNSUITABLE" appears in the display. off: The cassette is not ejected. LEVEL1: The cassette is ejected when the audio signal on the tape is not compatible with this VTR. For details on audio signal compatibility, refer to the compatibility table in "1-8-1. Switching the System Frequency" in the supplied maintenance manual. LEVEL2: The cassette is ejected when the signal on the tape is not compatible with this VTR. However, if the difference between the audio signal and the VTR field frequency is $\pm 0.1\%$, the tape is assumed to be compatible. LEVEL3: The cassette is ejected when the field frequency, PsF mode, or interlace mode of the tape differs from that of the VTR.

Menu List

Items Related to Operation Panels (101~)

The values enclosed in a box are factory settings.

Item number	Item	Settable range	Function
101	SELECTION FOR SEARCH DIAL ENABLE	dial direct <input type="checkbox"/> via search key	Determines how the unit is set to search mode. dial direct: The unit enters search mode when you rotate the search dial in all modes except recording and edit modes. via search key: The unit enters search mode when you press the SHUTTLE, JOG or VAR button.
102	REFERENCE SYSTEM ALARM	off <input type="checkbox"/> on	Specifies where or not to display a warning when audio/video reference signal selected in item 005. is not present or out of phase with the input video signal. off: No warning is displayed. on: Warning is displayed by flashing STOP button.
104	REC INHIBIT LAMP FLASHING	<input type="checkbox"/> off on	Specifies whether the REC INHIBIT indicator lights or flashes, when REC inhibit plug on the back side of the inserted cassette tape is pressed down. off: The REC INHIBIT indicator lights up. on: The REC INHIBIT indicator flashes.
107	JOG DIAL RESPONSE	<input type="checkbox"/> type1: -1 to +1 type2: -2 to +2 type3: -2 to +2	<p>Selects the tape speed (VTR command) characteristics for search JOG dial rotation.</p> <p>TYPE1: Tape speed changes linearly in a range of -1 to +1 times normal tape speed.</p> <p>TYPE2: Tape speed changes in a range of -2 to +2 times normal tape speed as shown below in TYPE 2. (Tape speed does not change when the search dial is within a range of ±1 times normal tape speed.)</p> <p>TYPE3: Tape speed changes linearly in a range of -2 to +2 times normal tape speed as shown below in TYPE 3.</p> <div style="display: flex; justify-content: space-around;"> <div style="text-align: center;"> <p>TYPE2</p> </div> <div style="text-align: center;"> <p>TYPE3</p> </div> </div>
109	KEY INHIBIT	<input type="checkbox"/> off on	<p>When this is set to "on", the KEY INHIBIT indicator in the upper control panel lights, and some, all, or a group of the following buttons are disabled: REMOTE button on the upper control panel, AUDIO INPUT/MONITOR SELECT button, editing operation buttons on the lower control panel.</p> <p><i>For details of the keys and buttons disabled by this setting, see item 110.</i></p>

Appendix

Item number	Item	Settable range	Function
110	KEY INHIBIT SWITCH EFFECTIVE AREA		The enabling or disabling of switches and buttons can be independently specified through each of the following sub-items when item 109 is set to "on".
	Sub items		
	1	MON./INPUT SEL	<input type="checkbox"/> dis ena
2	CONTROL PANEL	<input type="checkbox"/> dis edit ena	Specifies which switches and buttons on the control panel of this unit and the external control panel connected to this unit are enabled. dis : All switches and buttons are disabled. edit : The switches and buttons related to editing function are disabled. ena: All switches and buttons are enabled.
111	VARIABLE SPEED LIMIT IN KEY PANEL CONTROL	<input type="checkbox"/> off (-1 to +2) on (0 to +1)	Sets the the tape speed range during variable-speed (VAR) playback on the control panel of this unit. off (-1 to +2) : The range of the tape speed is -1 to +2 times normal speed. on (0 to +1) : The range of the tape speed is 0 to +1 time normal speed.
112	CTL LOCK IN VAR/SHTL	<input type="checkbox"/> off -1/-0.5/0.5/1.0/2.0	CTL locks the tape transport during variable-speed playback or shuttle playback. off : CTL does not lock. -1/-0.5/0.5/1.0/2.0: CTL locks the tape transport at speeds of -1, -0.5, 0.5, 1.0, and 2.0 times normal speed.
113	DT MODE	<input type="checkbox"/> field (-1 to +1) frame	Sets the DT operation mode. field : (-1 to +1): Enters the field playback mode (Field DT mode) when the tape speed is -1 to +1 times normal speed. Enters the frame playback mode (Flame DT mode) when the tape speed is +1 to +2 times normal speed. frame: Enters the frame playback mode (Frame DT mode).
114	POWER-ON MENU select	<input type="checkbox"/> home menu TC menu CUE menu PF1 menu PF2 menu ALT+PF1 menu ALT+PF2 menu	Selects the menu displayed when the unit is powered on.
115	KEY BEEP	high low <input type="checkbox"/> off	Selects the volume of the key click sound.
116	ALARM BEEP	<input type="checkbox"/> high low off	Selects the volume of the key click sound.
117	SCREEN SAVER	3 min 10 min 60 min <input type="checkbox"/> off	Selects the time after which the screen saver function operates.
118	INPUT GUARD select	<input type="checkbox"/> off on	Selects the mode in which the INPUT SELECT buttons on the front panel switch video and audio inputs. off: The INPUT SELECT buttons on the front panel can switch the video and audio inputs. on: The INPUT SELECT buttons on the front panel are inhibited from switching the video and audio inputs. However, it is possible to check the INPUT SELECT display, and to carry out MONITOR SELECT switching.

Menu List

Item number	Item	Settable range	Function
120	WARNING DISPLAY	<input type="checkbox"/> off <input type="checkbox"/> on	<p>Selects whether warning messages should be displayed in the lower part of the timecode display for the HOME menu, the TC menu, the PF1 menu, and the PF2 menu.</p> <p>off: Do not display warning messages. on: Display warning messages.</p> <p>Notes</p> <ul style="list-style-type: none"> • No warning messages are displayed for the CUE menu, so check by viewing a menu other than the CUE menu. • If LOST LOCK occurs during playback or recording, a LOST LOCK warning message is always displayed.
121	INFORMATION DISPLAY		Selects items to be displayed in the operation information.
	Sub items		
	SYSTEM FREQUENCY	<input type="checkbox"/> off <input type="checkbox"/> diff <input type="checkbox"/> ever	<p>off: Does not display the field frequency of both the unit and the tape.</p> <p>diff: Displays the field frequency of the unit and the tape only when they do not match.</p> <p>ever: Always displays the field frequency of the unit and the tape.</p>
	ACTIVE LINE (HD)	<input type="checkbox"/> off <input type="checkbox"/> diff <input type="checkbox"/> ever	<p>off: Does not display the effective scanning line number to be input or played back, and to be output.</p> <p>diff: Displays the effective scanning line number to be input and to output only when they do not match.</p> <p>ever: Always displays the effective scanning line number to be input and output.</p>
	EOS DISPLAY	<input type="checkbox"/> off <input type="checkbox"/> on	<p>off: Does not display EOS.</p> <p>on: Displays EOS.</p>
	VIDEO INT SG	<input type="checkbox"/> off <input type="checkbox"/> on	<p>off: Does not display the type of the test signal generated by the internal video test signal generator.</p> <p>on: Display the type of the test signal generated by the internal video test signal generator.</p>
	AUDIO INT SG	<input type="checkbox"/> off <input type="checkbox"/> on	<p>off: Does not display the operating status of the internal audio test signal generator.</p> <p>on: Displays the operating status of the internal audio test signal generator.</p>
METADATA	<input type="checkbox"/> off <input type="checkbox"/> on	<p>Selects whether the reception setting (bank name) for the meta data multiplexed in the HD SDI packet is displayed or not.</p> <p>off: The bank name is not displayed. on: The bank name is displayed.</p>	
122	MULTI CUE CLEAR by inject	<input type="checkbox"/> on <input type="checkbox"/> off	<p>Selects whether to erase cue point data in multi-cue mode when a cassette is inserted.</p> <p>on : Erase cue point data. off : Do not erase cue point data.</p>
123	Tele-File CONTROL MODE	<input type="checkbox"/> control panel <input type="checkbox"/> RS-232C	<p>Selects the device to be used for TELE FILE menu operations.</p> <p>control panel: The control panel of the VTR is used. RS-232C: A personal computer connected to the RS-232C connector of the VTR is used.</p>
124	Tele-File MENU auto popup	<input type="checkbox"/> off <input type="checkbox"/> on	<p>Specifies whether or not the TELE FILE menu appears automatically when a cassette with a memory label is inserted.</p> <p>off: The TELE FILE menu does not appear. on: The TELE FILE menu appears.</p>
125	Tele-File THREAD COUNTER clear mode	<input type="checkbox"/> not clear <input type="checkbox"/> when format	<p>Specifies whether or not the thread counter is reset when a memory label is formatted.</p> <p>not clear: The thread counter is not reset. when format: The thread counter is reset.</p>

Items Related to Remote Interface (201~)

The values enclosed in a box are factory settings.

Item number	Item	Settable range	Function
201	REMOTE 9-PIN	<input type="checkbox"/> off on	<p>When this is set to "on," this unit is controlled from the device connected to the REMOTE 1-IN(9P)/OUT(9P) connectors.</p> <p>Note</p> <p>When this unit is controlled by a device connected to the REMOTE 1-IN(9P) or PARALLEL I/O 1-IN(50P) connectors, the editing control buttons and all of the tape transport buttons except STOP and EJECT are disabled. It is also possible to make a setting so that all of the buttons are disabled.</p> <p><i>For details, see item 008.</i></p>
202	REMOTE 50-PIN	<input type="checkbox"/> off on	<p>When this is set to "on," this unit is controlled from the device connected to the REMOTE PARALLEL I/O (50P) connector (optional BKDW-509).</p>
203	PARALLEL RUNNING	<input type="checkbox"/> disable enable	<p>Selects whether two or more VTRs can be operated synchronized.</p> <p>disable: Synchronized operation is not carried out. enable: Synchronized operation is enabled.</p> <p>Note</p> <p>For synchronized operation to be possible, item 203 must be set to "enable" on all of the connected VTRs.</p>

Menu List

Items Related to Editing (301~)

The values enclosed in a box are factory settings.

Item number	Item	Settable range	Function
301	EDIT OPERATION MODE	film CG normal	<p>Selects the animation edit mode. For normal editing, use the “normal” setting.</p> <p>film: Selects editing in field units for film recording. Since the standard film speed is 24 frames/sec and VTR frame rate is 30 frames/sec when the frame frequency is 29.97 Hz or 30 Hz, the duration must be alternated between 2 and 3 fields when recording films. This setting is automatically activated in film mode. When editing finishes, the next IN and OUT points are automatically set.</p> <p>Note</p> <p>This setting is only active when the frame frequency of the unit is 29.97 Hz or 30 Hz.</p> <p>CG: Primarily for recording computer graphics, this setting allows editing by individual frames. When the edit is completed, the OUT point automatically becomes the next IN point. The next OUT point is automatically set one frame ahead of the IN point.</p> <p>normal: Use this setting for normal insert editing.</p>
302	PREROLL TIME	0 sec : 5 sec : 30 sec	This sets the preroll time. The range is from 0 to 30 seconds, in steps of 1 second. The preroll time should generally be set to at least 3 seconds, and for phase adjustment with an editing controller it is recommended to set the preroll time to at least 5 seconds.
303	POSTROLL TIME	0 sec : 2 sec : 30 sec	This sets the postroll time for which the tape transport keeps moving after reaching an OUT point. The range is from 0 to 30 seconds, in steps of 1 second.
304	VAR SPEED RANGE FOR SYNCHRONIZATION	-1 to +2 -1.15 to +2.45	<p>Specifies the variable tape speed range when the variable speed playback is executed by a remote control unit connected to the REMOTE1 IN (9P) connector.</p> <p>-1 to +2: -1 to +2 times normal tape speed -1.15 to +2.45: -1.15 to +2.45 times normal tape speed</p> <p>Note</p> <p>When an editing control unit such as BVE-9100 is connected for DT editing, select “-1.15 to +2.45”.</p>
305	EDIT FIELD select	1F 2F 1F/2F	<p>Selects the start timing for editing when performing tape editing.</p> <p>1F: Start editing from field 1 and end on field 2. 2F: Start editing from field 2 and end on field 1. 1F/2F: Following received timing commands.</p> <p>Note</p> <p>When the system frequency of this unit is PsF mode, the unit always operates with the F1 setting.</p>
306	SYNCHRONIZE	accurate rough off	<p>When this unit is used as a controller for editing control of another VTR connected through a 9-pin remote cable, this selects whether or not to carry out phase synchronization of the two VTRs, and also the editing accuracy when carrying out synchronization.</p> <p>accurate: Editing is carried out with an accuracy of ± 0 frames. rough: Editing is carried out with an accuracy of ± 1 frame. off: Synchronization is not carried out.</p>

Item number	Item	Settable range	Function
Items 311 through 315 describe the analog audio edit preset during editing mentioned on right.			The following items specifies the allocation of each channel for the analog audio preset of the editor or remote controller when the digital audio signals from the VTR is edited on an editor (BVE-600, etc.) or remote controller with digital audio edit preset control functions.
311	ANALOG AUDIO EDIT PRESET REPLACE FOR CH 1	no definition analog ch 1 analog ch 2 analog ch 1 + ch 2	Sets the channel-1 edit preset of the VTR to ON or OFF according to the analog audio preset specified on an editor or remote controller. no definition: Not defined. analog ch 1: As determined by analog channel 1 edit preset. analog ch 2: As determined by analog channel 2 edit preset. analog ch 1 + ch 2: As determined by analog channel 1 or analog channel 2 preset.
312	ANALOG AUDIO EDIT PRESET REPLACE FOR CH 2	no definition analog ch 1 analog ch 2 analog ch 1 + ch 2	Sets the channel-2 edit preset of the VTR to ON or OFF according to the analog audio preset specified on an editor or remote controller. no definition: Not defined. analog ch 1: As determined by analog channel 1 edit preset. analog ch 2: As determined by analog channel 2 edit preset. analog ch 1 + ch 2: As determined by analog channel 1 or analog channel 2 preset.
313	ANALOG AUDIO EDIT PRESET REPLACE FOR CH 3	no definition analog ch 1 analog ch 2 analog ch 1 + ch 2	Sets the channel-3 edit preset of the VTR to ON or OFF according to the analog audio preset specified on an editor or remote controller. no definition: Not defined. analog ch 1: As determined by analog channel 1 edit preset. analog ch 2: As determined by analog channel 2 edit preset. analog ch 1 + ch 2: As determined by analog channel 1 or analog channel 2 preset.
314	ANALOG AUDIO EDIT PRESET REPLACE FOR CH 4	no definition analog ch 1 analog ch 2 analog ch 1 + ch 2	Sets the channel-4 edit preset of the VTR to ON or OFF according to the analog audio preset specified on an editor or remote controller. no definition: Not defined. analog ch 1: As determined by analog channel 1 edit preset. analog ch 2: As determined by analog channel 2 edit preset. analog ch 1 + ch 2: As determined by analog channel 1 or analog channel 2 preset.
315	ANALOG AUDIO EDIT PRESET REPLACE FOR CUE	no definition analog ch 1 analog ch 2 analog ch 1 + ch 2	Sets the analog audio channel (longitudinal) edit preset of the VTR to ON or OFF according to the analog audio preset specified on an editor or remote controller. no definition: Not defined. analog ch 1: As determined by analog channel 1 edit preset. analog ch 2: As determined by analog channel 2 edit preset. analog ch 1 + ch 2: As determined by analog channel 1 or analog ch 2 preset.

Menu List

Item number	Item	Settable range	Function
317	AUDIO EDIT MODE	cut edit <input type="checkbox"/> cross fade <input type="checkbox"/> fade in/out	<p>Specifies the type of editing for digital audio signals.</p> <p>cut edit: Cut editing (discontinuity in audio signal may result at the join, causing noise.)</p> <p>cross fade: Cross-fade (see figure below.)</p> <p>fade in/out: Fade-out and fade-in (see figure below.)</p> <p>Note</p> <ul style="list-style-type: none"> • The “t” in the figures above is the time set by item 811. • When editing non-audio data, be sure to select “cut edit.” • Noise may be produced during the editing of certain non-audio data.
318	EDIT RETRY	off <input type="checkbox"/> on	<p>Set this item when the VTR is used as a recorder during VTR-to-VTR editing. Specifies the action taken when the recorder fails to synchronize with the player VTR.</p> <p>off: Editing is not executed and the VTR enters STOP mode.</p> <p>on: The VTR automatically repeats the editing again (not more than twice).</p>
320	PLAY COMMAND DELAY START TIME	-30 frame : <input type="checkbox"/> 0 frame : +30 frame	<p>This adjusts the time in frames required between the issue of a playback command and this unit actually beginning the execution of the command. This adjustment is useful for synchronization between VTRs with widely differing start-up timing.</p>
321	VIDEO PREVIEW MODE	<input type="checkbox"/> VVV <input type="checkbox"/> VBV	<p>During a preview operation, this selects the video signals that can be monitored on the monitor output and line output connectors.</p> <p>VVV: VIDEO-VIDEO-VIDEO: In the editing interval the monitored signal is the player video signal or video input (EE) signal.</p> <p>VBV: VIDEO-BLACK-VIDEO: In the editing interval the monitored signal is a black signal.</p>
322	AUDIO PREVIEW MODE	<input type="checkbox"/> SSS <input type="checkbox"/> SMS	<p>During a preview operation, this selects the audio signals that can be monitored on the monitor output and line output connectors.</p> <p>SSS: SOUND-SOUND-SOUND: In the editing interval the monitored signal is the player audio signal or audio input (EE) signal.</p> <p>SMS: SOUND-MUTE-SOUND: In the editing interval the audio signal is muted.</p>

Items Related to Prerolling (401~)

The values enclosed in a box are factory settings.

Item number	Item	Settable range	Function
401	FUNCTION MODE AFTER CUE-UP	<input type="checkbox"/> stop still	<p>Selects the operation mode that the VTR changes to after completing a cue up operation.</p> <p>stop: Enters stop mode. still: Enters still-picture mode (search mode).</p> <p>Note When setting the standard constant on the editor and control the unit, set to "stop."</p>
403	CUEUP BY TC	capstan only <input type="checkbox"/> reel/capstan	<p>This setting is only active when item 602. is set to TC or UBIT.</p> <p>capstan only: The tape runs with the pinch ON during cue up. (The maximum tape speed is ten times normal tape speed.) reel/capstan: The tape runs with the pinch OFF state during cue up. When the tape nears the cue up point and tape speed drops to slow, the pinch turns ON.</p>
404	CUEUP BY CTL	<input type="checkbox"/> capstan only reel/capstan	<p>This setting is only active when item 602. is set to CTL.</p> <p>capstan only: The tape runs with the pinch ON state during cue up. (The maximum tape speed is ten times normal tape speed.) reel/capstan: The tape runs with the pinch OFF state during cue up. When the tape nears the cue up point and tape speed drops to slow, the pinch turns ON.</p> <p>When this unit is controlled by an editor (BVE-2000/BVE-9100, etc), and the setting is "reel/capstan", cue up operations are done at high speed.</p> <p>Select "capstan only" when editing precision has priority.</p>
405	CUE MENU DEFAULT MODE select	<input type="checkbox"/> page mode extend mode	<p>Selects the default mode when the CUE menu is opened.</p> <p>page mode: PAGE mode extend mode: EXTEND mode</p>
406	CUE MENU PREROLL OFFSET	<input type="checkbox"/> 0 sec : 30 sec	<p>Sets the preroll time for a cueing up operation from the CUE menu.</p>
407	AUTO REWIND	<input type="checkbox"/> off on	<p>Selects the rewind mode for the end of the tape.</p> <p>off: The tape transport stops at the end of the tape. on: The tape is automatically rewound from the end of the tape.</p>

Menu List

Items Related to Recording Protection (501~)

The values enclosed in a box are factory settings.

Item number	Item	Settable range	Function
501	STILL TIMER	0.5 sec 5 sec 10 sec 20 sec 30 sec 40 sec 50 sec 1 min 2 min 3 min 4 min 5 min 6 min 7 min 8 min 30 min	Select the amount of time after which the VTR to automatically enters tape-protect mode, for the purpose of protecting the video head and tape. This is the time between stopping of the tape (stop mode or still-picture mode in search mode) and the change to tape-protection mode. The selectable range of time is from 0.5 second to 30 minutes.
502	TAPE PROTECTION MODE SEARCH	step fwd standby off tension release	Specifies the tape-protect mode the VTR changes from still-picture mode while searching. The unit enters automatically the specified tape-protect mode after the time specified in item 501 has elapsed. step fwd: A two-second step advance is repeated in forward direction at 1/30 times normal tape speed. standby off: The VTR enters standby off mode (standby is canceled). tension release: The VTR enters tension release mode (tape tension is released).
503	TAPE PROTECTION MODE FROM STOP	standby off tension release	Specifies the tape-protect mode the VTR changes to from the stop mode. The unit automatically enters the specified tape-protect mode after the elapse of time specified by the item 501. standby off: The VTR enters standby off mode (standby is canceled). tension release: The VTR enters tension release mode (tape tension is released).
504	DRUM ROTATION IN STANDBY OFF	off on	Sets the drum rotation to on or off during standby-off mode. off: Drum rotation is stopped. on: Drum rotation continues.
505	STILL TENSION	normal loose	Sets the tape tension control in still-picture mode. normal: Maintains the tape tension that ensures unaffected playback even in still-picture mode. (This is the normal setting for VTR operations.) loose: Sets the tape tension lower than that of the "normal" setting after the VTR enters still-picture mode. In this case, picture playback is not ensured. (For long standbys (e.g., LMS) in still-picture mode, this setting is recommended.)

Items Related to the Time Code (601~)

The values enclosed in a box are factory settings.

Item number	Item	Settable range	Function
601	DF/NDF MODE select	drop frame non-drop frame auto	<p>Selects the timing mode for the time code generator and the CTL counter.</p> <p>drop frame: drop frame mode (“DF” indication) non-drop frame: non-drop frame mode (“NDF” indication) auto: Drop frame / non-drop frame mode is selected automatically on the basis of the frame frequency of the unit. For 29.97 Hz drop frame mode is selected, and for 30 Hz non-drop frame mode is selected. The setting of the frame frequency mode is carried out with the MAINTENANCE/F9/(OTHERS CHECK/SYSTEM) buttons.</p> <p>Note</p> <ul style="list-style-type: none"> • This setting is only active when the frame frequency of the unit is 29.97 Hz or 30 Hz. • When the F7(TCG MODE) key is set to regene, the time code generator is synchronized to the playback time code, and therefore this setting is disabled.
602	TIMER MODE select	CTL TC UBIT	<p>Selects the mode for displaying time data.</p> <p>CTL: During playback the CTL signal recorded on the tape, or during recording the CTL signal being recorded on the tape, is counted, and the tape running time is displayed in hours, minutes, seconds, and frames.</p> <p>TC: The time code value read by the time code reader, or the time code value generated by the time code generator is displayed. Use item 603. to toggle between VITC and LTC.</p> <p>UBIT: The user bits inserted in the playback time code, or the user bits inserted in the being recorded are displayed. Use item 603. to toggle between VITC and LTC.</p>
603	TCR MODE select	LTC auto VITC	<p>Selects the time code read by the time code reader during playback.</p> <p>LTC: LTC is read. auto: If the playback speed is from $-1/2$ to $+1/2$ normal speed, VITC is read, and if outside this range LTC is read. VITC: VITC is read.</p>
604	TAPE TIMER DISPLAY	+/- 12H 24H	<p>Selects whether the CTL counter operates in 12-hour display mode or 24-hour display mode.</p> <p>+/-12H: 12-hour display mode 24H: 24-hour display mode</p> <p>Note</p> <p>In the ± 12-hour display, the tens digit of the hours value is dropped.</p>
605	VITC SOURCE	TCG V IN	<p>Selects the source for VITC to be written to the AUX data area of video signals.</p> <p>TCG: Write the signals generated by this unit’s internal time code generator to the VITC. V IN: Write the VITC of video signals input to this unit to the VITC.</p>

Menu List

Item number	Item	Settable range	Function
606	TCG MODE select	<input type="checkbox"/> preset regene auto	<p>Selects the time code to which the internal time code generator synchronizes.</p> <p>preset: By an operation on the front panel or by remote control from a device connected to the REMOTE 1-IN (9P) connector, the initial value of the time code generated by the internal time code generator can be preset.</p> <p>regene: The internal time code generator is synchronized ("regene") to the time code values read by the internal time code generator.</p> <p>auto: Operates in regene mode when either assemble or insert mode is selected and operates in preset mode when any other mode is selected.</p>
607	TCG REGENE SOURCE select	<input type="checkbox"/> int-LTC int-VITC ext-LTC ext-VITC	<p>If item 606 is set to "regene," this selects the source of the synchronization of the time code generated internally.</p> <p>int-LTC: When the time code played back from the time code track on the tape is used.</p> <p>int-VITC: When the time code played back from the "AUX data" in the video signal on the tape is used.</p> <p>ext-LTC: When the external time code input to the TIME CODE IN connector is used.</p> <p>ext-VITC: When the external time code input to the HD SDI INPUT connector is used.</p>
608	TCG/UBG REGENE MODE	<input type="checkbox"/> TC & UB TC UB	<p>Selects the regenerate signal when the time code generator is in regenerate mode (when item 606. is set to regene) or during auto edit mode.</p> <p>TC & UB: The time code signal and user bits signal are both regenerated.</p> <p>TC: The time code signal is regenerated.</p> <p>UB: The user bits signal is regenerated.</p>
609	REC RUN/FREE RUN select	<input type="checkbox"/> free run rec run	<p>This selects the way in which the time code advances.</p> <p>free run: Regardless of the operating mode of this unit, the time code advances all the time that the power is on.</p> <p>rec run: The time code advances only during recording.</p> <p>Note When using this setting, set item 606. to "preset".</p>
610	VITC (SD)	<input type="checkbox"/> off on	<p>Selects whether or not to insert VITC data in the HD-SD converter output.</p> <p>off: VITC data is inserted.</p> <p>on: VITC data is not inserted.</p>
611	VITC POSITION-1 select (NTSC)	12 line ⋮ <input type="checkbox"/> 16 line ⋮ 20 line	<p>When an HKDV-501A (optional HD-SD Converter Board) is installed and 29.97PsF/59.94i mode is selected on the VTR, this setting specifies the lines in which the VITC signal is inserted.</p> <p>It can be inserted in any lines from 12 to 20.</p> <p>Note Items 611 and 612 allow VITC to be inserted in two lines.</p>
612	VITC POSITION-2 select (NTSC)	12 line ⋮ <input type="checkbox"/> 18 line ⋮ 20 line	<p>When an HKDV-501A (optional HD-SD Converter Board) is installed and 29.97PsF/59.94i mode is selected on the VTR, this setting specifies the lines in which the VITC signal is inserted.</p> <p>It can be inserted in any lines from 12 to 20.</p> <p>Note Items 611 and 612 allow VITC to be inserted in two lines.</p>

Item number	Item	Settable range	Function
613	TC OUTPUT SIGNAL IN REGENE MODE	<input type="checkbox"/> off tape regene through	Specifies the signal output to the TIME CODE OUT connector when the internal time code generator is in a mode for regenerating the playback time code (i.e. during auto edit mode or when item 607. is set to int-LTC or int-VITC and item 606. is set to "regene".) off tape: The playback time code signal is output to the TIME CODE OUT connector without regeneration. regene: The playback time code signal is output to the TIME CODE OUT connector after regeneration only when the VTR is in playback mode. through: The playback time code signal is output.
614	PHASE CORRECTION	<input type="checkbox"/> off on	Specifies whether the phase correction control of the LTC signal generated by the time code generator is applied or not. off: The phase correction control is not applied. on: The phase correction control is applied.
615	TCG CF FLAG	<input type="checkbox"/> off on auto	Specifies whether the color frame (CF) flag is set (ON) or not set (OFF) in the blank bit of the time code data. off: Color frame flag is set OFF. on: Color frame flag is set ON. auto: Color frame flag is set ON or OFF depending on the phase relationship of the color framing between the recorded video signal and the time code signal. Note When this item is set to "auto", the color frame flag is determined by the operating mode of the time code generator. • When PRESET mode (i.e., item 606 is set to preset and the VTR is in a mode other than automatic edit mode), the time code signal is generated with color flame-locked to the video signal, and the color frame flag is ON. • When REGENE mode (i.e., item 606 is set to regene or the VTR is in automatic edit mode), color frame flag is OFF.
616	VITC POSITION-1 select (PAL)	9,322 line : <input type="checkbox"/> 19,332 line : 22,335 line	When an HKDV-501A (optional HD-SD Converter Board) is installed and 25PsF/50i mode is selected on the VTR, this setting specifies the lines in which the VITC signal is inserted. It can be inserted in any lines from 9,322 to 22,335. Note Items 616 and 617 allow VITC to be inserted in two lines.
617	VITC POSITION-2 select (PAL)	9,322 line : <input type="checkbox"/> 21,334 line : 22,335 line	When an HKDV-501A (optional HD-SD Converter Board) is installed and 25PsF/50i mode is selected on the VTR, this setting specifies the lines in which the VITC signal is inserted. It can be inserted in any lines from 9,322 to 22,335. Note Items 616 and 617 allow VITC to be inserted in two lines.
620	SUPERIMPOSED CHARACTER	<input type="checkbox"/> off on	Specifies whether or not to superimpose time data and operating status information on the signal output from the MONITOR connector of HD SDI OUTPUT, the D CONV. OUT (OPTION) COMPOSITE (SUPER) connector and the 3 (SUPER) connector of D CONV. SDI OUT (OPTION). off: No information is superimposed. on: Information is superimposed.

Menu List

Item number	Item	Settable range	Function
622	CHARACTER H-POSITION	0 : 8 : 15	Sets the horizontal position of text information superimposed on the signal output from the MONITOR connector of HD SDI OUTPUT, the D CONV. OUT (OPTION) COMPOSITE (SUPER) connector, the 3 (SUPER) connector of D CONV. SDI OUT (OPTION) and the PULL DOWN OUT connectors. A setting of 0 displays the information at the left edge of the screen, and the position moves to the right as the setting is increased. There are 16 possible settings, from 0 to 15
623	CHARACTER V-POSITION	0 : 22 : 23	Sets the vertical position of text information superimposed on the signal output from the MONITOR connector of HD SDI OUTPUT, the D CONV. OUT (OPTION) COMPOSITE (SUPER) connector, the 3 (SUPER) connector of D CONV. SDI OUT (OPTION) and the PULL DOWN OUT connectors. A setting of 0 displays the information at the bottom of the screen, and the position moves up as the setting is increased. There are 24 possible settings, from 0 to 23. Note If two-line display is selected in item 626., sometimes the second line will disappear in the middle of the screen.
624	CHARACTER TYPE	without BG outlined translucent withBG	Sets the style of text information such as time codes output from the MONITOR connector of HD SDI OUTPUT, the D CONV. OUT (OPTION) COMPOSITE (SUPER) connector, the 3 (SUPER) connector of D CONV. SDI OUT (OPTION) and the PULL DOWN OUT connectors. without BG: White characters, with no background. outlined: White characters outlined in black. translucent: White characters on a gray screen background. with BG: White characters on a black background. Note For the D CONV. SDI OUT (OPTION) connector and D CONV. OUT (OPTION) COMPOSITE (SUPER) TYconnector, the “translucent” setting is automatically changed to “with BG”.
625	CHARACTER SIZE	× 1 x2 × 3	Sets the size of text information such as time codes output from the MONITOR of HD SDI OUTPUT connector, the D CONV. OUT (OPTION) COMPOSITE (SUPER) connector, 3 (SUPER) of D CONV. SDI OUT (OPTION) connector and the PULL DOWN OUT connectors. × 1: Normal size. × 2: Twice normal size. × 3: Three times normal size.
626	DISPLAY INFORMATION select	time data & status time data & UB time data & CTL time data & VITC time data only	When item 620 is set to “on”, this setting specifies the content of text information output from the MONITOR connector of HD SDI OUTPUT, the D CONV. OUT (OPTION) COMPOSITE (SUPER) connector, the 3 (SUPER) connector of D CONV. SDI OUT (OPTION) and the PULL DOWN OUT connectors. time data & status: Timer counter display and status information. time data & UB: Timer counter display and user bits. time data & CTL: Timer counter display and CTL. time data & VITC: Timer counter display and VITC. time data only: Timer counter display only.

Item number	Item	Settable range	Function
627	CHAR WARNING DISPLAY at dual line mode	<input type="checkbox"/> off on	<p>When item 626 is set to anything other than time data only, this item specifies whether warning messages flash on the second line or not.</p> <p>off: Warning messages do not flash. on: If a warning message exists, it flashes.</p> <p>Notes</p> <ul style="list-style-type: none"> • Messages that have been cleared are not displayed. For more information about clearing warning messages, see “Clearing warning messages” on page A-12. • When there are multiple warning messages, each message flashes twice before it is replaced by the next message.
628	REMAIN TIME DISPLAY	<input type="checkbox"/> off 10min on	<p>Sets whether to display remaining time on the tape in superimposed character position.</p> <p>off: Do not display remaining time. 10 min: Display remaining time when it is 10 minutes or less. on: Always display remaining time.</p> <p>Notes</p> <p>The remaining time on the tape is not displayed when no cassette is inserted. The remaining time is not also displayed until the VTR finishes detecting the diameter of the wound tape and estimating the remaining time immediately after the cassette is inserted.</p>
630	TC CONVERSION at 25F off-speed PB	<input type="checkbox"/> off on	<p>Specifies whether or not to convert the 24 frames time code to the 25 frames time code when off-speed playing back the cassette tape recorded in the 24F mode with the 25F mode.</p> <p>off: Does not convert the 24 frames time code to the 25 frames time code. on: Converts the 24 frames time code to the 25 frames time code.</p> <p>Note</p> <p>This setting is only active when the field frequency is 25 Hz.</p>
631	ORIGINAL TC display	<input type="checkbox"/> off on	<p>When item 630 is set to “on,” this setting specifies whether the 24-frame time code is displayed or not on the control panel of the VTR before conversion.</p> <p>off: The 24-frame time code is not displayed before conversion. on: The 24-frame time code is displayed before conversion. The type of time code type displayed is specified by item 603.</p>
632	JUMPING TC select	<input type="checkbox"/> -3H -2H -1H +1H +2H +3H 0H	<p>When the 24-frame time code is converted to 25-frame time code, this setting specifies the loopback point (JUMPING TC) with respect to the reference point for conversion (STARTING TC).</p> <p>-3H: The JUMPING TC is set 3 hours before STARTING TC. -2H: The JUMPING TC is set 2 hours before STARTING TC. -1H: The JUMPING TC is set 1 hour before STARTING TC. +1H: The JUMPING TC is set 1 hour after STARTING TC. +2H: The JUMPING TC is set 2 hours after STARTING TC. +3H: The JUMPING TC is set 3 hours after STARTING TC. 0H: The JUMPING TC is set 1 frame before STARTING TC.</p>

Menu List

Items Related to the Video Control (701~)

The values enclosed in a box are the factory settings.

Item number	Item	Settable range	Function
701	VIDEO INPUT select	SDI SDTI	Selects the input video signal. SDI: The SDI video signal input to the HD SDI INPUT connectors. SDTI (Only when the optional HKDV-506A SDTI Board is installed.): The SDTI video signal (270 Mbps) input to the SDTI (OPTION) IN connector.
706	FORCED VERTICAL INTERPOLATION OFF	auto forced YADD off	Specifies whether Y-add operation mode is automatically turned on during DT playback or not. auto: Y-add operation mode is automatically turned on. forced YADD off: Y-add operation mode is off all the time.
707	ROUNDING	simple adaptive	Specifies whether or not A-ROUNDING™ ¹⁾ performed. simple: A-ROUNDING™ is not used. 10 bit input signals changed to 8 bits by normal rounding (rounding down numbers of 4 or less and rounding up numbers of 5 or more). adaptive: A-ROUNDING™ is applied. 10 bit signals are rounded to 8 bits.
708	MASTER LEVEL (HD) preset: 100% (4000H)	0.0% (0H) ⋮ 100% (4000H) ⋮ 141.3% (5A70H)	Adjusts the level of the HD video signal output from the HD SDI OUTPUT connectors. Simultaneously adjusts the Y, P _B , and P _R levels.
709	Y LEVEL (HD) preset: 100% (4000H)	0.0% (0H) ⋮ 100% (4000H) ⋮ 141.3% (5A70H)	Adjusts the level of the HD video signal output from the HD SDI OUTPUT connectors. Adjusts the Y level of the video signal.

1) A-ROUNDING™

A method for rounding a 10 bit signal to 8 bits. This process suppresses step noise that occurs when lines which differ slightly from the horizontal are displayed. A-ROUNDING is a trademark of Sony Corp.

Item number	Item	Settable range	Function
710	P _B LEVEL (HD) preset: 100% (4000H)	0.0% (0H) ⋮ <input type="text" value="100% (4000H)"/> ⋮ 141.3% (5A70H)	Adjusts the level of the HD video signal output from the HD SDI OUTPUT connectors. Adjusts the P _B level of the video signal.
711	P _R LEVEL (HD) preset: 100% (4000H)	0.0% (0H) ⋮ <input type="text" value="100% (4000H)"/> ⋮ 141.3% (5A70H)	Adjusts the level of the HD video signal output from the HD SDI OUTPUT connectors. Adjusts the P _R level of the video signal.
712	SETUP LEVEL (HD) preset: 0	-10.0 ⋮ <input type="text" value="0.0"/> ⋮ 10.0	Adjusts the level of the HD video signal output from the HD SDI OUTPUT connectors. Adjusts the setup level of the video signal.
713	SYNC PHASE (HD) preset: 0	-128 ⋮ <input type="text" value="0"/> ⋮ 127	Controls the H sync phase of the HD video signal output from the HD SDI OUTPUT connectors, according to the menu.
714	FINE (HD) preset: 0	<input type="text" value="0"/> ⋮ 1024	Controls the H sync phase of the HD video signal output from the HD SDI OUTPUT connectors, according to the menu.
720	EFFECT EDIT MODE	<input type="text" value="off"/> on	Applies effect edit mode for editing special effects or for dubbing a tape with an attenuated signal-to-noise ratio. off: For normal editing or dubbing. on: For repeated editing of special effects or for dubbing a tape with a highly attenuated signal-to-noise ratio.
730	ACTIVE LINE 1035 CONVERT MODE	<input type="text" value="1080⇒1035(CONV)"/> 1080⇒1035(CROP)	When the HKDV-502 HD Line Converter Board is installed, selects the conversion mode of the effective scanning line number. 1080⇒1035(CONV): Convert the effective scanning line number from 1080 to 1035 preserving the aspect ratio of the image. 1080⇒1035(CROP): Convert the effective scanning line number from 1080 to 1035. The four sides of the image are cropped, then it is horizontally expanded.
731	ACTIVE LINE 1080 CONVERT MODE	<input type="text" value="1035⇒1080(CONV)"/> 1035⇒1080(PANEL)	When the HKDV-502 HD Line Converter Board is installed, selects the conversion mode of the effective scanning line number. 1035⇒1080(CONV): Convert the effective scanning line number from 1035 to 1080 preserving the aspect ratio of the image. 1035⇒1080(PANEL): Convert the effective scanning line number from 1035 to 1080. The 1035 lines of the image are inserted into the 1035 lines of 1080 lines, then it is horizontally compressed.
732	SLOW PROCESS MODE	<input type="text" value="on"/> off	When the HKDV-502 HD Line Converter Board is installed, selects whether or not to activate the function to improve the vertical resolution during slow-motion playback. on: Activate the function to improve the vertical resolution during slow-motion playback. off: Do not activate the function to improve the vertical resolution during slow-motion playback. Note This setting has no effect when the VTR is operated in PsF mode.

Menu List

Item number	Item	Settable range	Function
754	DOWNCONVERTER MODE	EDGE-CROP LETTER BOX SQUEEZE	When an HKDV-501A (optional HD-SD Converter Board) is installed, selects the mode EDGE-CROP: Selects edge crop mode. LETTER BOX: Selects letter box mode. SQUEEZE: Selects squeeze mode.
755	MASTER LEVEL (D1) preset: 100% (4000H)	0.0% (0H) : 100% (4000H) : 141.3% (5A70H)	Adjusts the level of the high D1 video signal output from D CONV. SDI OUT (OPTION) connector. Simultaneously adjusts the Y, B-Y, and R-Y level.
756	Y LEVEL (D1) preset: 100% (4000H)	0.0% (0H) : 100% (4000H) : 141.3% (5A70H)	Adjusts the level of the D1 video signal output from D CONV. SDI OUT (OPTION) connector. Simultaneously adjusts the Y levels.
757	B-Y LEVEL (D1) preset: 100% (4000H)	0.0% (0H) : 100% (4000H) : 141.3% (5A70H)	Adjusts the level of the D1 video signal output from D CONV. SDI OUT (OPTION) connector. Adjusts the B-Y level of the video signal.
758	R-Y LEVEL (D1) preset: 100% (4000H)	0.0% (0H) : 100% (4000H) : 141.3% (5A70H)	Adjusts the level of the D1 video signal output from D CONV. SDI OUT (OPTION) connector. Adjusts the R-Y level of the video signal.
759	VIDEO OUTPUT LEVEL (D2) preset: 100% (4000H)	0.0% (0H) : 100% (4000H) : 141.3% (5A70H)	Adjusts the video level of the D2 video signal output from D CONV. SDI OUT (OPTION) connector and analog composite video signal output from D CONV. OUT (OPTION) COMPOSITE (SUPER) connector.

Item number	Item	Settable range	Function
760	CHROMA LEVEL (D2) preset: 100% (4000H)	0.0% (0H) ⋮ <input type="text" value="100% (4000H)"/> ⋮ 141.3% (5A70H)	Adjusts the chroma level of the D2 video signal output from D CONV. SDI OUT (OPTION) connector and analog composite video signal output from D CONV. OUT (OPTION) COMPOSITE (SUPER) connector.
761	HUE (D2) preset: 0	-30 ⋮ <input type="text" value="0"/> ⋮ 30	Adjusts the hue of the D2 video signal output from D CONV. SDI OUT (OPTION) connector and analog composite video signal output from D CONV. OUT (OPTION) COMPOSITE (SUPER) connector.
762	SETUP LEVEL (D2) preset: 7.5 IRE	0.0 ⋮ <input type="text" value="7.5"/> ⋮ 10.0	Adjusts the setup level of the D2 video signal output from D CONV. SDI OUT (OPTION) connector and analog composite video signal output from D CONV. OUT (OPTION) COMPOSITE (SUPER) connector.
763	SYNC PHASE (SD) preset: 0	-128 ⋮ <input type="text" value="0"/> ⋮ 127	Adjusts the sync phase of the D1/D2 video signal output from D CONV. SDI OUT (OPTION) connectors and analog composite video signal output from D CONV. OUT (OPTION) COMPOSITE (SUPER) connector.
764	FINE (SD) preset: 0	<input type="text" value="0"/> ⋮ 1024	Makes fine adjustments to the sync phase of the D1/D2 video signal output from D CONV. SDI OUT (OPTION) connectors and analog composite video signal output from D CONV. OUT (OPTION) COMPOSITE (SUPER) connector.
765	CROSS COLOR preset: 8	0 ⋮ <input type="text" value="8"/> ⋮ 15	When an HKDV-501A (optional HD-SD Converter Board) is installed, adjusts the image enhancer.
766	H CROP POSITION preset: 0	-120 ⋮ <input type="text" value="0"/> ⋮ 120	When an HKDV-501A (optional HD-SD Converter Board) is installed, adjusts the image enhancer. Adjusts the "H crop" (cropping position in the horizontal direction when using edge crop mode).
767	DETAIL GAIN preset: 32	0 ⋮ <input type="text" value="32"/> ⋮ 127	When an HKDV-501A (optional HD-SD Converter Board) is installed, adjusts the image enhancer. Adjusts the degree of edge enhancement.
768	LIMITER preset: 32	0 ⋮ <input type="text" value="32"/> ⋮ 63	When an HKDV-501A (optional HD-SD Converter Board) is installed, adjusts the image enhancer. Adjusts the maximum level of the detail added to enhance the original signal.
769	CRISP THRESHOLD preset: 0	<input type="text" value="0"/> ⋮ 15	When an HKDV-501A (optional HD-SD Converter Board) is installed, adjusts the image enhancer. Sets the amplitude for not enhancing small-amplitude signals.

Menu List

Item number	Item	Settable range	Function
770	LEVEL DEPEND THRESHOLD preset: 8	0 : 8 : 15	When an HKDV-501A (optional HD-SD Converter Board) is installed, adjusts the image enhancer. Sets the luminance range for edge enhancement.
771	H DETAIL FREQUENCY select	2.6 MHz 3.4 MHz 3.9 MHz 4.6 MHz	When an HKDV-501A (optional HD-SD Converter Board) is installed, adjusts the image enhancer. Sets the center frequency for edge enhancement.
772	H/V RATIO preset: 3	0 : 3 : 7	When an HKDV-501A (optional HD-SD Downconverter Board) is installed, adjusts the image enhancer. Sets the horizontal to vertical ratio for edge enhancement.
773	GAMMA LEVEL preset: 0	-128 : 0 : 128	When an HKDV-501A (optional HD-SD Converter Board) is installed, adjusts the image enhancer. Adjusts the gradient of the correction curve.
775	VIDEO OUTPUT DATA	8bit 10bit	Sets the bit size of the output data from video processing (bit reduction processing). 8bit: When connected to an 8-bit system 10bit: When connected to a 10-bit system Notes • Make sure the bit length matches the destination device. • This setting is only active when the HD-SD converter output is set to D1.
776	DOWNCONVERTER INPUT CHECK ENABLE	disable enable	Selects the HD-SD converter mode when the INPUT CHECK button on the control panel is pressed. disable: The INPUT CHECK button is not linked to downconverter output. enable: The INPUT CHECK button is linked to downconverter output. When the INPUT CHECK button is pressed, the input signal selected by the setting in item 701 is output to the HD-SD converter output connector. Note The INPUT CHECK button works for all of the HD-SD converter output connectors.
777	V-FILTER SELECT	1 2 3	Selects coefficient of the vertical interpolation filter for the HD-SD converter output. The higher the figure is, the higher the vertical resolution is.
778	LETTER BOX MODE	16:9 14:9 13:9	When item 754 is set to "LETTER BOX," this setting specifies the aspect ratio of the HD-SD converter output. 16:9: The aspect ratio of the HD-SD converter output is 16:9. 14:9: The aspect ratio of the HD-SD converter output is 14:9. 13:9: The aspect ratio of the HD-SD converter output is 13:9.

Items Related to the Audio Control (801~)

The values enclosed in a box are the factory settings.

Item number	Item	Settable range	Function
801	AUDIO INPUT select ALL-CHANNELS	analg [SDI] AES/EBU [SDTI]	<p>Selects the type and channels of the audio input signals. analg: Audio signals input to the ANALOG AUDIO INPUT connectors. SDI: Audio signals input to the HD SDI INPUT connectors. AES/EBU: Audio signals input to the AUDIO INPUT (AES/EBU) connectors. [SDTI] (Only when the optional HKDV-506A SDTI Board is installed.): If "SDTI" is selected in item 701., the SDTI audio signal input to the SDTI (OPTION) IN connector is automatically selected and AUDIO INPUT/MONITOR SELECT buttons on the upper control panel become unlit and another input selection cannot be made.</p>
802	AUDIO INPUT select CH-1	analg [SDI] AES/EBU [SDTI]	
803	AUDIO INPUT select CH-2	analg [SDI] AES/EBU [SDTI]	
804	AUDIO INPUT select CH-3	analg [SDI] AES/EBU [SDTI]	
805	AUDIO INPUT select CH-4	analg [SDI] AES/EBU [SDTI]	
806	AUDIO EMPHASIS	[off] on	<p>Selects the emphasis mode when recording digital audio signals converted from analog input audio signals. off: Emphasis is not applied to any of the audio signals. on: Emphasis is applied to all of the audio signals.</p>
807	AUDIO MONITOR- Lselect	[ch1] ch2 : ch1, ch2, ch3, ch4, cue	Selects the audio channel output from the AUDIO MONITOR OUTPUT L connector.
808	AUDIO MONITOR- Rselect	ch1 [ch2] : ch1, ch2, ch3, ch4, cue	Selects the audio channel output from the AUDIO MONITOR OUTPUT R connector.
809	DIGITAL JOG SOUND	off [on]	<p>Switches digital jog sound on and off. off: Digital jog sound is switched off. In this case, the sound for channels for which speed correction processing is not being carried out is output, even in the case of "STILL." on: Digital jog sound is switched on.</p>
811	DIGITAL AUDIO FADE TIME	5 ms [10 ms] 15 ms 20 ms 25 ms ^{a)} 50 ms ^{b)} 85 ms 115 ms ^{c)}	<p>Specifies the fade processing time during cross-fading or fading-in/out of digital audio signals.</p> <p>Note Processing for cross fading, fading-in, and fading-out starts after an IN or OUT point. This item specifies rewriting during recording following the OUT point. Rewriting of one field occurs even when the minimum setting (5 ms) is selected. When "cut edit" is selected in item 317 to prevent this from happening, a discontinuity in the audio signal occurs. There is, however, no effect on the recording of the video signal. a) The cross fade time is 24 ms. b) The actual fade time is 49 ms. c) The actual fade time is 114 ms.</p>

Menu List

Item number	Item	Settable range	Function
812	AUDIO CH3/4 INPUT SOURCE ARRANGE	CH3/CH4 : sw/sw CH3/CH4 : ch1/sw CH3/CH4 : sw/ch2 CH3/CH4 : ch1/ch2	<p>Select the input signal for digital audio channels 3 and 4.</p> <p>CH3/CH4: sw/sw: The signal that is selected by the upper control panel is input to channels 3 and 4.</p> <p>CH3/CH4: ch1/sw: The signal to be recorded in channel 1 is also recorded in channel 3.</p> <p>CH3/CH4: sw/ch2: The signal to be recorded in channel 2 is also recorded in channel 4.</p> <p>CH3/CH4: ch1/ch2: The signal to be recorded in channel 1 is recorded in channel 3 while the signal to be recorded in channel 2 is recorded in channel 4.</p> <p>Note</p> <p>The edit preset for channels 3 and 4 is completely independent. Even if this item is set to "CH3/CH4 : sw/sw" and insert editing is performed with edit preset for channel 1 only, no signal is recorded in channel 3.</p> <p>The recording level is determined, not by the settings for channels 3 and 4, but by the level control of the input channels used as the source when this setting is CH3/CH4:ch1/sw, CH3/CH4:sw/ch2, or CH3/CH4:ch1/ch2.</p> <p>The level control for LINE/MONITOR output is independent of E-E, CONFI, and PB modes even when this setting is CH3/CH4:ch1/sw, CH3/CH4:sw/ch2, or CH3/CH4:ch1/ch2.</p>
813	AUDIO MONITOR OUTPUT MIXING	add rms average	<p>Specifies the type of audio mixing to be conducted on the digital audio signal output to the MONITOR OUTPUT connector.</p> <p>add: Simple addition rms: Multiplied average average: Simple average</p> <p>Note</p> <p>When the CUE channel signal is output to the monitor, signals are mixed by simple addition.</p>
814	LEVEL METER SCALE	peak 0 dB reference 0 dB	<p>Specifies the mode in which the digital audio level is displayed.</p> <p>peak 0 dB: Displays minus audio levels with the maximum level set at 0 dB.</p> <p>reference 0 dB: Displays plus and minus audio levels with the reference level set at 0 dB.</p> <p>Note</p> <p>The cue channel level is always displayed with the reference level set at 0 dB.</p>
815	AUDIO OUTPUT PHASE preset: 128	0 : 128 : 255	<p>Sets the output timing for the digital audio playback signal (SDI and AES/EBU only). The 128 setting specifies the reference position.</p> <p>A setting lower than 128 advances the output timing, and a setting higher than 128 delays the output timing. (128 samples, or approx. 2.7 ms, with 1 sample = approx. 20 μs)</p>
817	AUDIO LEVEL METER DIMMER CONTROL	0 : 7	<p>Specifies the brightness of the audio level meter.</p> <p>0 is the brightest level. 7 is the darkest level.</p>
819	NON AUDIO MODE select	BURST DATA MODE CONTINUOUS DATA MODE	<p>Specifies the format in which non-audio data is recorded.</p> <p>BURST DATA MODE: Select this setting for recording data compressed in units of video frames (e.g., Dolby E).</p> <p>CONTINUOUS DATA MODE: Select this setting for recording data compressed without any relationship to the video frames (e.g., Dolby Digital (AC-3)).</p>

Item number	Item	Settable range	Function
820	NON AUDIO Channelselect	<input type="checkbox"/> off SDI CH12 (MODE1) SDI CH34 (MODE2) SDI all (MODE3) AES CH12 (MODE4) AES CH34 (MODE5) AES all (MODE6) SDI CH12/AES CH34 (MODE7) SDI CH34/AES CH12 (MODE8)	<p>Selects the audio signal and the channels to be recorded as non-audio data.</p> <p>off: Non-audio signals are not recorded.</p> <p>SDI CH12 (MODE1): Channels 1 and 2 of the signal input from the HD/SDI INPUT connector are recorded.</p> <p>SDI CH34 (MODE2): Channels 3 and 4 of the signal input from the HD/SDI INPUT connector are recorded.</p> <p>SDI all (MODE3): Channels 1 to 4 of the signal input from the HD/SDI INPUT connector are recorded.</p> <p>AES CH12 (MODE4): Channels 1 and 2 of the signal input from the AUDIO INPUT (AES/EBU) connector are recorded.</p> <p>AES CH34 (MODE5): Channels 3 and 4 of the signal input from the AUDIO INPUT (AES/EBU) connector are recorded.</p> <p>AES all (MODE6): Channels 1 to 4 of the signal input from the AUDIO INPUT (AES/EBU) connectors are recorded.</p> <p>SDI CH12/AES CH34 (MODE7): Channels 1 and 2 of the signal input from the HD/SDI INPUT connector and the channels 3 and 4 of the signal input from the AUDIO INPUT (AES/EBU) connector are recorded.</p> <p>SDI CH34/AES CH12 (MODE8): Channels 3 and 4 of the signal input from the HD/SDI INPUT connector and the channels 1 and 2 of the signal input from the AUDIO INPUT (AES/EBU) connector are recorded.</p>
821	AUDIO ADVANCE MODE	<input type="checkbox"/> off <input type="checkbox"/> on	<p>Specifies whether or not the phase of the audio output signal is shifted 1 frame ahead of the video output signal.</p> <p>off: The phase of the audio output signal is not shifted.</p> <p>on: The phase of the audio output signal is shifted 1 frame ahead of the video output signal. Note that the phase is shifted for all audio channels.</p> <p>Note</p> <p>When edit preset is set to "ON", HDW-F500 operates internally with "off" setting.</p>

Menu List

Items Related to Digital Processing (901~)

The values enclosed in a box are the factory settings.

Item number	Item	Settable range	Function
902	FREEZE MODE	<div style="border: 1px solid black; display: inline-block; padding: 2px;">field</div> field1 field2 frame1+2 frame2+1	<p>Specifies the freeze (still-picture) mode and freeze timing during manual freezing (by REMOTE1 (9P) or REMOTE2 (50P) connector on the control panel) or automatic freezing.</p> <p>field: Freezes the odd or even field, depending on the timing in freeze mode.</p> <p>field1: Freezes the first (odd) field</p> <p>field2: Freezes the second (even) field</p> <p>frame1+2: Freezes the first and the subsequent second field</p> <p>frame2+1: Freezes the second field and the subsequent first field</p> <p>In the case of freezing in playback modes other than normal playback, the picture is frozen in frame mode only when dynamic tracking is performing a frame operation. The picture is frozed in field mode when dynamic tracking is not operating.</p> <p>The frozed picture does not change even if you change this setting during freeze mode. The change to this setting becomes effective the next time the VTR outputs a still picture.</p> <p>When the stop freeze function is enabled, regardless of the setting of this item, the picture is frozen in frame mode only when dynamic tracking is performing a frame operation, or is frozed in field mode when dynamic tracking is performing a field operation or when it is not operating.</p>
903	FREEZE CONTROL FROM KEY PANEL	<div style="border: 1px solid black; display: inline-block; padding: 2px;">momentary</div> latch	<p>Determines the freeze operation control by button operations.</p> <p>momentary : The picture is frozen only while the button is held down</p> <p>latch : The picture is frozen when the button is pressed, and remains frozen when the button is released.</p> <p>The fozen picture is cancelled when the button is pressed again.</p> <p>Button operations</p> <ul style="list-style-type: none"> Freezing in odd or even (first or second) field is specified by item 902. Distinction between the first or second field, follows the distinction in the reference signal.

Item number	Item	Settable range	Function
905	STOP FREEZE CONTROL	disable enable	Enable or disables the stop freeze function.

Stop freeze operation

MODE (Before) \ MODE (After)	STOP	TENSION OFF	STDBY OFF
STILL (dynamic tracking on)	DT picture	DT picture	DT picture
CAPSTAN drive (includes shuttling up to $\times 10$ normal tape speed)	non-DT picture	non-DT picture	non-DT picture
Reel drive (includes shuttling over $\times 10$ normal tape speed)	non-DT picture	non-DT picture	non-DT picture

- A “DT picture” is a frozen picture in noiseless DT playback mode. The picture freezes in frame mode when the dynamic tracking is performing a frame operation. It freezes in field mode when dynamic tracking is not performing a frame operation.
- A “non-DT picture” is a frozen picture in shuttle mode. A block pattern may appear in a non-DT picture, depending on the circumstances.

Menu List

Items Related to the Pull Down Control (A01~)

The values enclosed in a box are the factory settings.

Item number	Item	Settable range	Function
A01	PD TIME CODE DISPLAY	<input type="checkbox"/> off on	Sets whether or not to display the pull down time code on the time code display area. off: Does not display the pull down time code. on: Displays the pull down time code.
A02	PD PRESET FRAME MODE	<input type="checkbox"/> 24 FRAME MODE 30 FRAME MODE	Selects the time code to be preset. The A frame of the pulldown sequence can be preset. 24 FRAME MODE: The 24 frames time code is preset. 30 FRAME MODE: The 30 frames time code is preset.
A03	PD SUPERIMPOSED CHARACTER	<input type="checkbox"/> off on	Specifies whether or not to superimpose time data and operating status information on the signal output from the PULL DOWN OUT connector. off: No information is superimposed. on: Information is superimposed.
A04	PD DF/NDF SELECT	<input type="checkbox"/> drop frame non-drop frame auto	Selects the running mode for the pull down time code to be preset. drop frame: Drop frame mode non-drop frame: Non-drop frame mode auto: The unit switches the running mode (DF/NDF) automatically according to the frame frequency of the unit. When the frame frequency is 23.976 Hz, the unit switches to the drop frame mode and switches to the non-drop frame mode when it is 24 Hz.
A05	PD EXT SD REF LOCK MODE	<input type="checkbox"/> off lock1 lock2	When an HKDV-507D (optional HD Pull Down Board) is installed and the operating frequency is set to 23.976PsF, specifies whether or not the pull down output signal and down-converted output signal are synchronized with external SD (EXT-SD) reference signal. To output the pull down signal, an HKDV-507D (optional HD Pull Down Board) must be installed. To output the down-converted signal, an HKDV-501A (optional HD-SD Converter Board) must be installed. off: The pull down output signal and down-converted output signal are not synchronized with external SD (EXT-SD) reference signal. lock1: The pull down output signal and down-converted output signal are synchronized with external SD (EXT-SD) reference signal. lock2: The pull down output signal and down-converted output signal are synchronized with external SD (EXT-SD) reference signal. When the PB/EE mode is selected, the amount of delay on the A frame of the pull down output signal for the A frame of the main video signal is fixed to 2 frames (59.94i). Note • A warning message appears when the HD reference signal and external SD (EX-SD) reference signal are not input or the HD reference signal and external SD reference signal are not synchronized. • “lock1” and “lock2” are effective only when the operation mode of this unit is set to 23.98PsF.

Item number	Item	Settable range	Function
A06	PD SUPERIMPOSED TIME CODE ID	<input type="checkbox"/> off <input type="checkbox"/> on	<p>When item 620 and A03 is set to “on,” specifies whether or not the ID (24F/30F) is displayed to the right of superimposed time code.</p> <p>off: No ID is displayed. on: ID (“24F” or “30F”) is displayed.</p> <p>Note The setting of this item is effective only when the operation mode of this unit is set to 23.98PsF or 24PsF.</p>
A07	PD CHARACTER 24F TIME CODE MODE	<input type="checkbox"/> off <input type="checkbox"/> on	<p>When item 620 and A03 is set to “on,” specifies whether or not the 2-3 pull down 24-frame time data is inserted to the first line instead of 30-frame time data.</p> <p>off: 30-frame time data is displayed. on: 24-frame time data is displayed.</p> <p>Note The setting of this item is effective only when the operation mode of this unit is set to 23.98PsF or 24PsF.</p>
A10	TC sense data select	<input type="checkbox"/> 24F <input type="checkbox"/> 30F	<p>When an HKDV-507D (optional HD Pull Down Board) is installed and the operating frequency is set to 23.976PsF, specifies whether or not the 30-frame/sec time code information of pull down output signal and down-converted output signal is returned when time code sense command is input through the 9-pin connector.</p> <p>24F: 24-frame/sec time code information of main output signal is returned. 30F: 30-frame/sec time code information of pull down output signal and down-converted output signal is returned.</p> <p>Notes</p> <ul style="list-style-type: none"> • Pull down output signal and 30-frame/sec time code are synchronized only when this unit is set to PLAY LOCK mode. To synchronize the signals, set item A05. PDEXT SD REF LOCK MODE to “lock2.” • Machine-to-machine editing using the pull down output signal with a VTR operating in 30F mode may not function properly if the VTR in 30F mode is engaged in player sync.

Menu List

Other Items (T01~)

The values enclosed in a box are the factory settings.

Item number	Item	Settable range	Function
T01	AUTO REPEAT MODE	<input type="checkbox"/> off on	Selects the repeating operation in automatic editing. off: Automatic editing is not repeated. on: Automatic editing is repeated. To stop, press the STOP button.
T02	INTERNAL VIDEO SIGNAL GENERATOR (HD)	<input type="checkbox"/> off COLOR BARS MULTIBURST 10 STEPS PULSE & BAR <input type="checkbox"/> RAMP BLACK	Selects the test signal output by the signal generator built into the VTR. off: The test signal is not generated, and the VTR operates normally. all other settings: The test signal is output from the VTR. At this time it is also possible to record the signal.
T03	INTERNAL VIDEO SIGNAL LINE SELECT	1035 <input type="checkbox"/> 1080	Selects the effective scanning line number of the test signal output by the signal generator built into the VTR. 1035: Sets the effective scanning line number to 1035. 1080: Sets the effective scanning line number to 1080. Note This setting is only active when the frame frequency of the unit is 29.97 Hz or 30 Hz.
T04	INTERNAL AUDIO SIGNAL GENERATOR	<input type="checkbox"/> off silence 1 kHz sine	Selects the operation of audio test signal output. off: The audio test signal is not output. silence: Mute signal. 1 kHz sine: 1 kHz (In this case, a 1 kHz -20 dB FS sine wave is supplied to all audio inputs.) Note <ul style="list-style-type: none"> When "silence" or "1 kHz sine" is selected, the AUDIO INPUT/MONITOR SELECT buttons light up. When the unit is operated in the 23.98 PsF or 24 PsF mode with "1 kHz sine" selected, the output signal is 960 Hz.

Note

Items T01, T02, and T04 are reset whenever the power is turned off. Item T03 is maintained even when the power is turned off.

A

AC IN connector 2-15
 ACCESS button 2-6
 Adjusting
 audio playback level 5-6
 output video signal 4-58
 recording level 5-3
 ALARM indicator 2-6
 ALT button 2-6
 Assemble editing 4-17, 6-3
 AUDIO IN/OUT buttons 2-8
 AUDIO INPUT connectors 2-16
 AUDIO INPUT (AES/EBU) connectors 2-15
 AUDIO INPUT LEVEL/600Ω termination switches 2-16
 AUDIO INPUT/MONITOR SELECT buttons 2-4
 Audio level meters 2-3
 AUDIO OUTPUT connectors 2-16
 AUDIO OUTPUT (AES/EBU) connectors 2-15
 AUTO button 2-8
 Automatic edit modes 6-1
 Automatic editing
 Animation editing 6-17
 Backspace editing 4-40
 confirming edit points 6-8
 cuing up and prerolling 6-8
 DMC editing 6-15
 modifying edit points 6-10, 6-13
 non-audio data 6-7
 overview of automatic editing 6-1
 performing editing 6-12, 6-14
 preread editing 6-18
 previewing 6-9
 selecting the edit mode 6-3
 setting edit points 6-3
 setting switches and menus 6-2
 steps in automatic editing 6-1

B

Backspace editing 4-40
 BREAKER button 2-15

C

Capstan override playback 5-14
 Cassettes
 handling cassettes 3-8
 inserting and ejecting cassettes 3-8
 preventing accidental erasure 3-9
 recommended cassettes 3-8
 Changing
 menu settings 4-2
 preroll time 6-9
 Confirming edit points 6-8
 Connecting external equipment
 Cascade connection 3-4
 making HD analog connections 3-2
 making digital connections 3-1
 making NTSC/PAL Digital Connections 3-3
 Connector panel 2-14
 Control panel
 lower control panel
 (editing operations section) 2-7
 lower control panel
 (menu operations section) 2-5
 lower control panel
 (search operations section) 2-11
 lower control panel
 (tape transport section) 2-9
 upper control panel 2-2
 CONTROL PANEL connector 2-16
 CONTROL PANEL switch 2-13
 Conversion
 selecting conversion mode 5-7, 5-8
 time code in 24F mode 4-34
 time code in 25F mode 4-29
 (HD-SD) conversion mode
 Edge crop 5-7
 Letter box mode 5-7
 Squeeze mode 5-7
 Cross-fade editing A-25
 CTL timer 4-24
 CUE menu 4-35
 Cue point
 changing into an edit point 4-40
 erasing 4-38
 prerolling 4-39
 registrating 4-36
 Cut editing A-26

D

D CONV. OUT (OPTION) SYNC connector 2-15
 D CONV. OUT (OPTION) COMPOSITE (SUPER) connector 2-15
 D CONV. SDI OUT (OPTION) connectors 2-16
 Deleting edit points 6-10
 DISPLAY FULL/FINE button 2-2
 Displaying the duration 6-8
 DMC editing
 overview 6-15
 performing 6-15
 setting edit points and playback speed 6-15
 DMC playback
 overview 5-14
 performing 5-15
 DF (Drop frame) mode 4-25, 4-26

E

Editing *See Automatic editing*
 Edit point
 confirming 6-8
 deleting 6-10
 modifying 6-10
 moving a position by one frame at a time 6-11
 setting 6-3
 recalling 4-19
 Editing precautions 6-1
 Effective scanning line number 5-8
 EJECT button 2-9
 Ejecting the cassette 3-8
 EMPHASIS 4-60
 ENTRY button 2-8
 Error Messages A-8
 Error Log Menu A-11
 Clearing warning messages A-12
 Adjusting the clock A-12
 EXTEND mode 4-36

F, G

Fade IN/OUT A-26
 Function buttons 2-6

H

HD SDI INPUT connectors 2-15
 HD SDI OUTPUT connectors 2-15
 Head cleaning A-1
 HOME menu 4-14

-
- ## I
- IN/OUT buttons 2-8
 - Indicator window 2-3
 - INPUT CHECK button 2-8
 - INPUT SELECT button 2-4
 - Improving vertical resolution 5-9
 - Insert editing 4-17, 6-3
 - Inserting VITC 4-26
-
- ## J, K, L
- JOG button 2-11
 - Jog mode playback 5-12
-
- ## M
- MAINTENANCE A-1
 - MAINTENANCE switch 2-6
 - Manual editing 6-19
 - Memory card
 - adding titles 4-11
 - data compatibility 4-13
 - formatting 4-6
 - insertion slot 2-6
 - recalling 4-9
 - recalling cue point list 4-10
 - storing 4-7
 - storing cue point lists 4-8
 - MEMORY CARD indicator 2-6
 - Memory label 1-2, 4-41, A-5
 - Menu
 - configuration 4-1
 - changing settings 4-2
 - CUE menu 4-35
 - HOME menu 4-14
 - list A-15
 - PANEL SETUP menu 4-65
 - PF1 menu 4-55
 - PF2 menu 4-59
 - registering items to the PF1/2 menus 4-3
 - MLB-1B-100 1-2, 4-41, A-5
 - Moisture condensation A-1
 - MONITOR OUTPUT connectors 2-16
 - MONITOR SELECT button 2-3
 - Monitoring video and audio signals being recorded 5-4
-
- ## N
- NDF (Non-drop frame) mode 4-25, 4-26
 - Non-audio data
 - editing 6-7
 - playing back 5-16
 - selecting as the audio input signal 5-3
 - Normal-speed playback 5-11
-
- ## O
- Operation information A-6
 - Outputting still-pictures 4-17
 - Overview
 - automatic editing 6-1
 - DMC editing 6-15
 - DMC playback 5-13
-
- ## P, Q
- PARALLEL I/O(50P) connector 2-16
 - Pausing the current time 4-24
 - PB audio output level controls 2-3
 - PF1 menu 4-55
 - PF2 menu 4-59
 - PHONES jack 2-2
 - PHONES level control 2-3
 - PLAY button 2-10
 - Playback 5-11
 - capstan override playback 5-14
 - DMC playback 5-14
 - jog mode playback 5-12
 - non-audio data 5-16
 - normal-speed playback 5-11
 - shuttle mode playback 5-12
 - variable mode playback 5-13
 - PLAYER/RECORDER buttons 2-8
 - POWER switch 2-2
 - Preparing for playback 5-6
 - adjusting the audio playback level 5-6
 - improving the vertical resolution 5-9
 - selecting the HD-SD conversion mode 5-7
 - Selecting the conversion mode of the effective scanning line number 5-8
 - setting switches and menus 5-6
 - Preparing for recording 5-1
 - adjusting the audio recording level 5-3
 - monitoring simultaneous playback of recording analog audio 5-4
 - selecting audio signals 5-2
 - setting switches and menus 5-1
 - PREREAD indicator 2-8
 - Preread editing 4-17
 - PREROLL button 2-10
 - Preroll time setting 4-18
 - PREVIEW/REVIEW button 2-10
 - Pull down output 5-16
 - Pull down time code
 - Displaying 4-29
 - Presetting 4-26
-
- ## R
- REC/EDIT button 2-10
 - REC INHIBIT indicator 2-10
 - REC level controls 2-3
 - Recording 5-5
 - inhibit mode 4-16
 - REF SYNC indicators 2-4
 - Reference signals connections 3-6
 - Reference signals for video output and servo system 3-5
 - REF. IN SD connectors (BNC) and 75 Ω termination switch 2-15
 - REF. IN HD connectors (BNC) and 75 Ω termination switch 2-15
 - REF. OUT 1125 SYNC connectors 2-15
 - REMOTE buttons 2-4
 - REMOTE1-IN/OUT connectors 2-16
 - RS-232C connector 2-16
 - RS-232C indicator 2-4
-
- ## S
- SDTI (OPTION) IN connector 2-15
 - SDTI (OPTION) OUT connector 2-15
 - Search dial 2-12
 - Selecting
 - audio input signals 5-2
 - audio signals to be monitored 5-2
 - capstan servo lock mode 4-18
 - CTL display 4-21
 - CTL display mode 4-26
 - conversion mode of the effective scanning line number 5-8
 - drop frame mode 4-25
 - edit mode 4-17
 - HD-SD conversion mode 5-7
 - input video signal 4-56
 - monitor output signal 4-60
 - multi-cue mode 4-36
 - non-audio data as the audio input signal 5-3
 - output signals 4-16
 - output signals for the TIME CODE OUT terminal 4-17
 - reference signal 4-56
 - remote operation mode 4-62
 - time code and user bits to be recorded 4-22
 - SERVO indicator 2-10
 - SET button 2-8
 - SET UP menu 4-59
 - SFT button 2-8
 - SHUTTLE button 2-11
 - Shuttle mode playback 5-12
 - Slow-motion playback
 - improving vertical resolution 5-9
 - Split editing 6-5
 - STANDBY button 2-9
 - STOP button 2-10
 - Super imposition of character information 4-28
 - System set-up panel 2-13

T

- TC menu 4-20
- Tele-File 1-2, 4-41
- TELE FILE menu 4-41
- Time code
 - conversion in the 24F mode 4-34
 - conversion in the 25F mode 4-29
 - presetting for conversion from 24-frame to 25-frame time code 4-27
 - presetting for conversion from 25-frame to 24-frame time code 4-33
 - running mode 4-25
- Time code generator (TCG) 4-25
 - setting 4-25
- TIME CODE IN connector 2-17
- TIME CODE OUT connector 2-17
- Time code reader (TCR) 4-24
- Time data
 - resetting 4-24
 - selecting the time data display 4-21
 - setting 4-21

U

- Upper control panel 2-2
- User bits setting 4-24

V

- VAR button 2-11
- Variable mode playback 5-13
- Vertical resolution 5-9
- VIDEO CONTROL connector 2-16
- VITC insertion line setting 4-32
- VTR memory banks 4-4
 - adding titles 4-11
 - recalling 4-5
 - storing 4-4
- VTR SETUP menu
 - items related to digital processing A-42
 - items related to editing A-24
 - items related to operation panels A-20
 - items related to prerolling A-27
 - items related to recording protection A-28
 - items related to remote interface A-23
 - items related to the audio control A-39
 - items related to the hours meter A-15
 - items related to the pull down control A-44
 - items related to the time code A-29
 - items related to the video control A-34
 - items related to VTR operations A-16
 - other items A-46

W, X, Y, Z

- Warning messages A-10

Table of Functions (Factory Default Settings)

ALT										
Menu	F1	F2	F3	F4	F5	F6	F7	F8	F9	F10
HOME	PB/EE	RECINH	ASSEMBL	INS TC	INS VIDEO	INS A-CH1	INS A-CH2	INS A-CH3	INS A-CH4	INS A-CUE
	PB EE	off <all crash REC video/CTL audio/CTL> [casst]	on off	on off	on off	on off	on off	on off	on off	on off
TC	TIMER SEL	TIMER RESET	TIMER SET	TIMER HOLD	TC SEL	TCG SOURCE	TCG MODE	RUN MODE	DF/NDF	VITC
	CTL TC UBIT				VITC auto LTC	int-LTC int-VITC ext-LTC ext-VITC	regene prst auto	free rec	DF NDF auto	TCG V IN
12 to 20	CUE	PREV PAGE		NEXT PAGE EXTEND	TELE FILE MODE	CUE P-ROLL		PAGE SET	PAGE SET	CUENUM SET
				setting)						M-CUE CLEAR
V	0 to 30 s	PF1 (Factory)			VIDEO IN	SERVO REF	MASTER LEVEL (HD)	Y LEVEL (HD)	PB LEVEL (HD)	PR LEVEL (HD)
	SETUP LEVEL (HD)	SYNC PHASE (HD)		FINE (HD)	SDI SDTI	input auto ext	prst xx%	prst xx%	prst xx%	prst xx%
prst xx	prst xx	prst xx	PF2 (Factory)	A-IN CH1	A-IN CH2	A-IN CH2	A-IN CH3	A-IN CH3	A-IN CH4	A-IN CH4
	EMPHASIS	MON-L SEL	MON-R SEL	analog SDI AES/EBU [SDTI]	analog SDI AES/EBU	analog SDI AES/EBU	analog SDI AES/EBU	analog SDI AES/EBU	[SDTI]	[SDTI]
analog SDI	AES/EBU [SDTI]	off on	1,2,3,4,5	1,2,3,4,5	1,2,3,4,5	SET UP	VTR BANK	MEMORY CARD		
		PF1&2 ASSIGN	PANEL SETUP	VTR SETUP	REMOTE 9-PIN	REMOTE 50-PIN	V	V	V	off
VTR BANK		EDIT TITLE	DIRECTION	COPY	EXIT	EXIT	MEMORY CARD SHOW SETUP	FORMAT CARD		
SHOW CUESSET	EDIT TITLE	SELECT ALL	DIRECTION	COPY	EXIT	EXIT		CANCEL	PF1&2 ASSIGN	
PF1	ALT				+PF1					
	PASTE						PF2 SAVE/EXIT	ALT +PF2 PANEL SETUP	SET BLANK	
KEYINH	KEY BEEP	ALARM BEEP					SCREEN SAVER	CANCEL	EXIT	

V indicates the existence of other menu levels.

このマニュアルに記載されている事柄の著作権は当社にあり、説明内容は機器購入者の使用を目的としています。

従って、当社の許可なしに無断で複写したり、説明内容（操作、保守等）と異なる目的で本マニュアルを使用することを禁止します。

The material contained in this manual consists of information that is the property of Sony Corporation and is intended solely for use by the purchasers of the equipment described in this manual.

Sony Corporation expressly prohibits the duplication of any portion of this manual or the use thereof for any purpose other than the operation or maintenance of the equipment described in this manual without the express written permission of Sony Corporation.

Le matériel contenu dans ce manuel consiste en informations qui sont la propriété de Sony Corporation et sont destinées exclusivement à l'usage des acquéreurs de l'équipement décrit dans ce manuel.

Sony Corporation interdit formellement la copie de quelque partie que ce soit de ce manuel ou son emploi pour tout autre but que des opérations ou entretiens de l'équipement à moins d'une permission écrite de Sony Corporation.

Das in dieser Anleitung enthaltene Material besteht aus Informationen, die Eigentum der Sony Corporation sind, und ausschließlich zum Gebrauch durch den Käufer der in dieser Anleitung beschriebenen Ausrüstung bestimmt sind. Die Sony Corporation untersagt ausdrücklich die Vervielfältigung jeglicher Teile dieser Anleitung oder den Gebrauch derselben für irgendeinen anderen Zweck als die Bedienung oder Wartung der in dieser Anleitung beschriebenen Ausrüstung ohne ausdrückliche schriftliche Erlaubnis der Sony Corporation.

Sony Corporation
Broadband Solutions Network Company

HDW-F500 (SYL, 英)
3-203-128-04(1)

<http://www.world.sony.com/>

Printed in Japan
2001.09.13
© 1999