

DVD Player/ Video Cassette Recorder

Operating Instructions



Hi-Fi

VIDEO*plus+*[®]



SLV-D980P GI

WARNING

To prevent fire or shock hazard, do not expose the unit to rain or moisture.

To avoid electrical shock, do not open the cabinet. Refer servicing to qualified personnel only.

Mains lead must only be changed at a qualified service shop.



This appliance is classified as a CLASS 1 LASER product. The CLASS 1 LASER PRODUCT MARKING is located on the rear exterior.

CAUTION

The use of optical instruments with this product will increase eye hazard. As the laser beam used in this DVD player/Video Cassette Recorder is harmful to eyes, do not attempt to disassemble the cabinet. Refer servicing to qualified personnel only.

Notice for customers in the United Kingdom and Republic of Ireland

A moulded plug complying with BS1363 is fitted to this equipment for your safety and convenience.

Should the fuse in the plug supplied need to be replaced, a 3 AMP fuse approved by ASTA or BSI to BS1362, (i.e., marked with ⚡ or ⚡ mark) must be used.

If the plug supplied with this equipment has a detachable fuse cover, be sure to attach the fuse cover after you change the fuse. Never use the plug without the fuse cover. If you should lose the fuse cover, please contact your nearest Sony service station.

Precautions

Safety

- This unit operates on 220 – 240 V AC, 50 Hz. Check that the unit's operating voltage is identical with your local power supply.
- To prevent fire or shock hazard, do not place objects filled with liquids, such as vases, on the apparatus.
- The unit is not disconnected from the AC power source (mains) as long as it is connected to the wall outlet, even if the unit itself has been turned off.

Installing

- Do not install the unit in a confined space such as a bookshelf or similar unit.
- Do not install the unit in an inclined position. It is designed to be operated in a horizontal position only.
- Keep the unit and discs away from equipment with strong magnets, such as microwave ovens, or large loudspeakers.
- Do not place heavy objects on the unit.
- Do not place the unit on surfaces (rugs, blankets, etc.) or near materials (curtains, draperies) that may block the ventilation slots.
- If the unit is brought directly from a cold to a warm location, moisture may condense inside the unit and cause damage to the video head and tape. When you first install the unit, or when you move it from a cold to a warm location, wait for about three hours before operating the unit.

VIDEO Plus+ and PlusCode are registered trademarks of Gemstar Development Corporation. The VIDEO Plus+ system is manufactured under license from Gemstar Development Corporation.



Disposal of Old Electrical & Electronic Equipment (Applicable in the European Union and other European countries with separate collection systems)

This symbol on the product or on its packaging indicates that this product shall not be treated as household waste. Instead it shall be handed over to the applicable collection point for the recycling of electrical and electronic equipment. By ensuring this product is disposed of correctly, you will help prevent potential negative consequences for the environment and human health, which could otherwise be caused by inappropriate waste handling of this product. The recycling of materials will help to conserve natural resources. For more detailed information about recycling of this product, please contact your local city office, your household waste disposal service or the shop where you purchased the product.

Welcome!

Thank you for purchasing this Sony DVD Player/Video Cassette Recorder. Before operating this player, please read this manual thoroughly and retain it for future reference.

Caution

For use of the VCR

Television programmes, films, video tapes and other materials may be copyrighted. Unauthorized recording of such material may be contrary to the provisions of the copyright laws. Also, use of this recorder with cable television transmission may require authorization from the cable television transmitter and/or programme owner.

For use of the DVD player

This product incorporates copyright protection technology that is protected by U.S. patents and other intellectual property rights. Use of this copyright protection technology must be authorized by Macrovision, and is intended for home and other limited viewing uses only unless otherwise authorized by Macrovision. Reverse engineering or disassembly is prohibited.

Table of contents

- 2 WARNING
 - 3 Welcome!
 - 3 Caution
 - 6 About this manual
 - 6 This player can play the following discs
 - 8 Notes about discs
-

Getting Started

- 9 Step 1 : Unpacking
 - 10 Step 2 : Setting up the remote commander
 - 12 Step 3 : Connecting the DVD-VCR
 - 15 Step 4 : Setting up the DVD-VCR with the Auto Set Up function
 - 17 Step 5 : Selecting a language
 - 18 Step 6 : Setting the clock
 - 20 Step 7 : Presetting channels
-

Basic Operations

- 28 Playing discs
- 33 Guide to the on-screen display
- 36 Locking the disc tray (Child Lock)
- 37 Playing a tape
- 40 Recording TV programmes
- 44 Recording TV programmes using the VIDEO Plus+® system
- 48 Recording TV programmes using the timer
- 51 Checking/changing/cancelling timer settings

Advanced Hookups

- 53 A/V Receiver hookup
- 55 S-Video/Component Video hookup

DVD Settings and Adjustments

- 57 Audio Setup
- 60 Screen Setup
- 64 Setting the display or sound track language
- 66 Parental Control (limiting playback by children)

DVD Additional Operations

- 69** Using the DVD's menu
- 71** Zooming into a scene
- 72** Changing the angles
- 74** Displaying the subtitle
- 75** Various play mode functions
(Programme play, Shuffle play,
Repeat play)
- 80** Changing the sound
- 81** Virtual surround setting
- 83** Playing an MP3 audio track
- 88** Playing JPEG image files
- 92** Playing VIDEO CDs with "PBC On/
Off" functions

VCR Additional Operations







- 94** Quick Timer Recording
- 96** Recording stereo and bilingual
programmes
- 98** Searching using index function
- 100** Adjusting the picture (tracking)
- 102** Changing menu options
- 104** Editing

Additional Information

- 107** General setup information
- 109** Troubleshooting
- 115** Glossary
- 117** Specifications
- 118** Index to parts and controls
- 123** DVD Audio/Subtitle Language
- 124** Index











About this manual

- This manual mainly explains operations using the remote, but the same operations can also be performed using the buttons on the DVD-VCR having the same or similar names.
- “DVD” may be used as a general term for DVD VIDEOS, DVD+RWs/DVD+Rs, and DVD-RWs/DVD-Rs.
- The meaning of the icons used in this manual is described below:

Icon	Meaning
	Functions available for DVD VIDEOS and DVD-RWs/DVD-Rs in video mode or DVD+RWs/DVD+Rs
	Functions available for DVD-RWs in VR (Video Recording) mode
	Functions available for VIDEO CDs, Super VCDs or CD-Rs/CD-RWs in video CD format or Super VCD format
	Functions available for music CDs or CD-Rs/CD-RWs in music CD format
	Functions available for DATA CDs (CD-ROMs/CD-Rs/CD-RWs containing MP3* audio tracks or JPEG files)
	Functions available for DATA DVDs (DVD-ROMs/DVD+RWs/DVD+Rs/DVD-RWs/DVD-Rs containing MP3* audio tracks or JPEG files)
	Functions available for VHS VIDEOS

* MP3 (MPEG 1 Audio Layer 3) is a standard format defined by ISO/MPEG which compresses audio data.

This player can play the following discs

Format of discs	
DVD VIDEO	
DVD-RW/-R	 
DVD+RW/+R	  
VIDEO CD/ Music CD	 
CD-RW/-R	 

“DVD+RW,” “DVD-RW,” “DVD+R,” “DVD+R DL,” “DVD-R,” “DVD VIDEO,” and “CD” logos are trademarks.

Note about CDs/DVDs

The player can play CD-ROMs/CD-Rs/CD-RWs recorded in the following formats:

- music CD format
- video CD format
- MP3 audio tracks and JPEG image files of format conforming to ISO 9660* Level 1/Level 2, or its extended format, Joliet
- KODAK Picture CD format

* A logical format of files and folders on CD-ROMs, defined by ISO (International Organization for Standardization).

The player can play DVD-ROMs/DVD+RWs/DVD+Rs/DVD-RWs/DVD-Rs recorded in the following formats:

- MP3 audio tracks and JPEG image files of format conforming to UDF (Universal Disk Format).

Region code

Your player has a region code printed on the back of the unit and only will play DVD VIDEO discs (playback only) labelled with identical region codes. This system is used to protect copyrights.

DVDs labelled  will also play on this player.

If you try to play any other DVD VIDEO, a message will appear on the TV screen to indicate that the disc is not playable. Depending on the DVD VIDEO, no region code indication may be labelled even though playing the DVD VIDEO is prohibited by area restrictions.

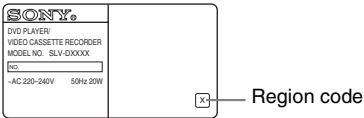

Example of discs that the player cannot play

The player cannot play the following discs:

- CD-ROMs/CD-Rs/CD-RWs other than those recorded in the formats listed on the previous page.
- CD-ROMs recorded in PHOTO CD format.
- Data part of CD-Extras
- DVD Audios
- HD layer on Super Audio CDs

Also, the player cannot play the following discs:

- A DVD VIDEO with a different region code.
- A disc that has a non-standard shape (e.g., card, heart).
- A disc with paper or stickers on it.
- A disc that has the adhesive of cellophane tape or a sticker still left on it.

Notes about DVD+RWs/DVD+Rs, DVD-RWs/DVD-Rs or CD-Rs/CD-RWs

Some DVD+RWs/DVD+Rs, DVD-RWs/DVD-Rs, or CD-Rs/CD-RWs cannot be played on this player due to the recording quality or physical condition of the disc, or the characteristics of the recording device and authoring software.

The disc will not play if it has not been correctly finalized. For more information, refer to the operating instructions for the recording device. Note that some playback functions may not work with some DVD+RWs/DVD+Rs, even if they have been correctly finalized. In this case, view the disc by normal playback. Also some DATA CDs/DATA DVDs created in Packet Write format cannot be played.

continued

Note on playback operations of DVDs and VIDEO CDs

Some playback operations of DVDs and VIDEO CDs may be intentionally set by software producers. Since this player plays DVDs and VIDEO CDs according to the disc contents the software producers designed, some playback features may not be available. Also, refer to the instructions supplied with the DVDs or VIDEO CDs.

Music discs encoded with copyright protection technologies

This product is designed to playback discs that conform to the Compact Disc (CD) standard. Recently, various music discs encoded with copyright protection technologies are marketed by some record companies. Please be aware that among those discs, there are some that do not conform to the CD standard and may not be playable by this product.

Note on DualDiscs

This product is designed to playback discs that conform to the Compact Disc (CD) standard. A DualDisc is a two sided disc product which mates DVD recorded material on one side with digital audio material on the other side. Please be aware that the audio side of a DualDisc may not play on this product because these discs do not conform to the CD standard.

“DualDisc” is a trademark of the Recording Industry Association of America (RIAA).

Notes about discs

- To keep the disc clean, handle the disc by its edge. Do not touch the surface.



- Do not expose the disc to direct sunlight or heat sources such as hot air ducts, or leave it in a car parked in direct sunlight as the temperature may rise considerably inside the car.
- After playing, store the disc in its case.
- Clean the disc with a cleaning cloth. Wipe the disc from the centre out.



Do not use solvents such as benzene, thinner, commercially available cleaners, or anti-static spray intended for vinyl LPs.

Step 1 : Unpacking

Check that you have received the following items with the DVD-VCR:

- Remote commander
- Aerial cable

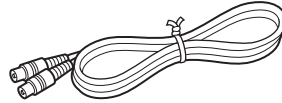
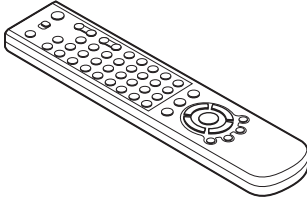

- R6 (size AA) batteries

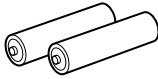

Note

- The supplied remote commander is for the exclusive use of this DVD-VCR.

Step 2 : Setting up the remote commander

Inserting the batteries

Insert two size AA (R6) batteries by matching the + and – on the batteries to the diagram inside the battery compartment.

Insert the negative (–) end first, then push in and down until the positive (+) end clicks into position.

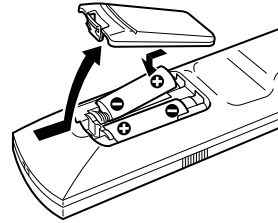

Using the remote commander

You can use this remote commander to operate this DVD-VCR and a Sony TV. Buttons on the remote commander marked with a dot (•) can be used to operate your Sony TV.

If the TV does not have the  symbol near the remote sensor, this remote commander will not operate the TV.

Remote sensor

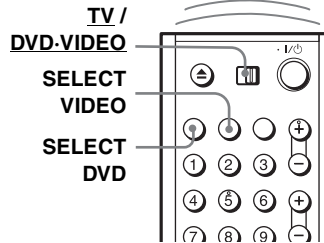
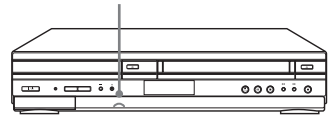

To operate	Set <u>TV / DVD-VIDEO</u> to
the DVD player	<u>DVD-VIDEO</u> , then press SELECT DVD and point at the remote sensor at the DVD-VCR
the VCR	<u>DVD-VIDEO</u> , then press SELECT VIDEO and point at the remote sensor at the DVD-VCR
your TV	<u>TV</u> and point at the remote sensor at your TV

Notes

- With normal use, the batteries should last about three to six months.
- If you do not use the remote commander for an extended period of time, remove the batteries to avoid possible damage from battery leakage.
- Do not use a new battery with an old one.
- Do not use different types of batteries.
- Do not leave the remote commander in an extremely hot or humid place.
- Do not drop any foreign object into the remote casing, particularly when replacing the batteries.
- Do not expose the remote sensor to direct light from the sun or lighting apparatus. Doing so may cause a malfunction.

Controlling other TVs with the remote commander

The remote commander is preprogrammed to control non-Sony TVs. If your TV is listed in the following table, set the appropriate manufacturer's code number.

- 1** Set TV / DVD-VIDEO at the top of the remote commander to TV.
- 2** Hold down I/⏻, and enter your TV's code number using the number buttons. Then release I/⏻.

Now you can use the I/⏻, VOL +/-, PROG +/-, MUTING*, TV/VIDEO, 0-9 and -/-* buttons to control your TV. You can also use the buttons marked with a dot (•) to control a Sony TV. To control the DVD-VCR, reset TV / DVD-VIDEO to DVD-VIDEO.

* for Sony TV only

Code numbers of controllable TVs

If more than one code number is listed, try entering them one at a time until you find the one that works with your TV.

Manufacturer	Code number
Sony	01, 02
Akai	68
Ferguson	52
Grundig	10, 11
Hitachi	24
JVC	33
Loewe	45
Mivar	09, 70
NEC	66
Nokia	15, 16, 69

Manufacturer	Code number
Panasonic	17, 49
Philips	06, 07, 08
Saba	12, 13
Samsung	22, 23
Sanyo	25
Sharp	29
Telefunken	36
Thomson	43
Toshiba	38

Notes

- If you enter a new code number, the code number previously entered will be erased.
- If the TV uses a different remote control system from the one programmed to work with the DVD-VCR, you cannot control your TV with the remote commander.
- When you replace the batteries of the remote commander, the code number may change. Set the appropriate code number every time you replace the batteries.

Step 3 : Connecting the DVD-VCR

Note that “Advanced Hookups” (page 53) explains additional hookup methods that will optimize the picture and sound for a true “hometheatre” experience.

If your TV has a Scart (EURO-AV) connector, see page 13.

If your TV does not have a Scart (EURO-AV) connector

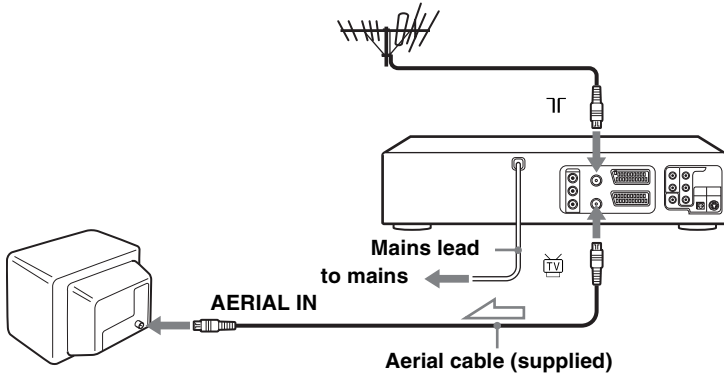

 : Signal flow

1

Disconnect the aerial cable from your TV and connect it to  on the rear panel of the DVD-VCR.

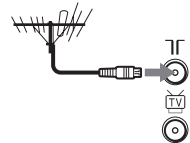

2

Connect  of the DVD-VCR and the aerial input of your TV using the supplied aerial cable.

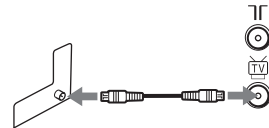

3

Connect the mains lead to the mains.

Note

- When you connect the DVD-VCR and your TV only with an aerial cable, you have to tune your TV to the DVD-VCR (see page 15).

If your TV has a Scart (EURO-AV) connector

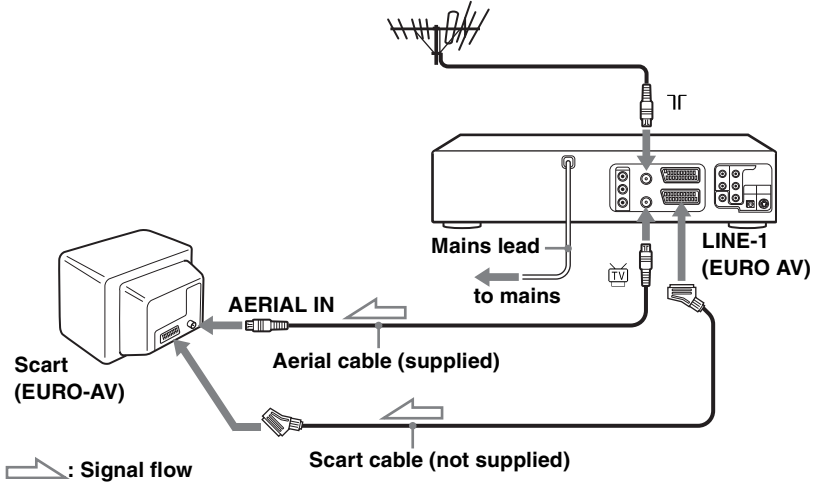

1

Disconnect the aerial cable from your TV and connect it to Υ on the rear panel of the DVD-VCR.

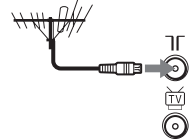

2

Connect TV of the DVD-VCR and the aerial input of your TV using the supplied aerial cable.

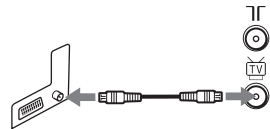

3

Connect LINE-1 (EURO AV) on the DVD-VCR and the Scart (EURO-AV) connector on the TV with the optional Scart cable.

This connection improves picture and sound quality.

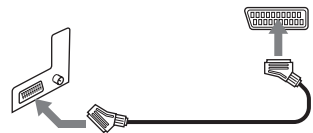

4

Connect the mains lead to the mains.

continued

Additional connections

To a satellite or digital tuner with Line Through

Using the Line Through function, you can watch programmes from a satellite or digital tuner connected to this DVD-VCR on the TV even when the DVD-VCR is turned off. When you turn on the satellite or digital tuner, this DVD-VCR automatically sends the signal from the satellite or digital tuner to the TV without turning itself on.

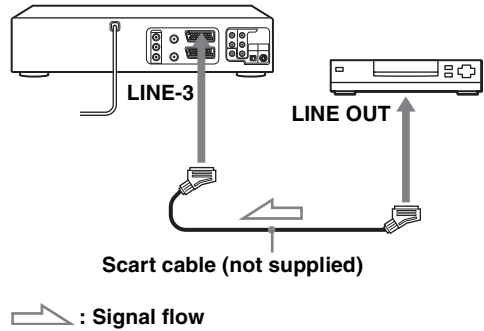

- 1 Connect the satellite or digital tuner to the LINE-3 connector as shown above.
- 2 Turn off the DVD-VCR.
To watch a programme, turn on the satellite or digital tuner and the TV.

Notes

- This function may not work with some types of satellite or digital tuners.
- When the DVD-VCR is turned off, set the TV to the video channel.
- The Line Through function will not operate properly if "Power Save" in "OPTION" menu is set to "On." Set "Power Save" to "Off" to ensure proper operation.

Step 4 : Setting up the DVD-VCR with the Auto Set Up function

Before using the DVD-VCR for the first time, set up the DVD-VCR using the Auto Set Up function. With this function, you can set TV channels, guide channels for the VIDEO Plus+ system, and DVD-VCR clock automatically.

Before you start...

- To control the DVD-VCR, set TV / DVD-VIDEO to DVD-VIDEO on the remote (page 10).

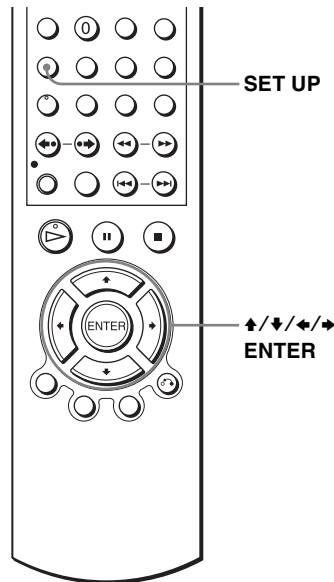

1

Turn on your TV and set it to the video channel.

If your TV does not have a Scart (EURO-AV) connector, tune the TV to channel 21 (the initial RF channel for this DVD-VCR). Refer to your TV manual for TV tuning instructions. If the picture does not appear clearly, see “To change the RF channel” on page 16.

2

Connect the mains lead to the mains.

The DVD-VCR automatically turns on and the DVD-VCR starts searching for all of the receivable channels and presets them (in the appropriate order for your local area).

If you want to change the order of the channels or disable unwanted programme positions, see “Changing/disabling programme positions” on page 22.

After the search is complete, the current time appears for any stations that transmit a time signal. If the time does not appear, set the clock manually. See “Setting the clock” on page 18.

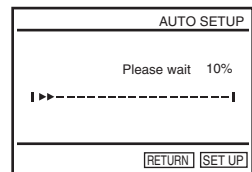

To cancel the Auto Set Up function

Press SET UP.

To change the RF channel

If the picture does not appear clearly on the TV, change the RF channel on the DVD-VCR and TV. Select “Install” in the “OPTION” menu, then press ▲/▼ to select “Video Output CH.” Select the RF channel by pressing the ◀/▶ buttons and press ENTER. Then, tune the TV to the new RF channel so that a clear picture appears.

Tip

- If you want to change the language for the on-screen display from the one preset in the Auto Set Up function, see page 17.

Notes

- Whenever you operate the Auto Set Up function, some of the settings (VIDEO Plus+, timer, etc.) will be reset. If this happens, you have to set them again.
- Auto preset starts automatically only when you plug in the mains lead for the first time after you purchase the DVD-VCR.
- If you want to use the Auto Set Up function again, select “Install” in the “OPTION” menu, then press ▲/▼ to select “Auto Setup.”
- Auto preset can be performed by pressing ■ on the unit continuously for 5 seconds or more during power off with no tape inserted.

Step 5 : Selecting a language

You can change the on-screen display language.

Before you start...

- Turn on the DVD-VCR and your TV.
- To control the DVD-VCR, set **TV / DVD-VIDEO** to **DVD-VIDEO** on the remote (page 10).
- Set your TV to the video channel so that the signal from the player appears on the TV screen.
- If the DVD player is in play mode, you cannot display the setup menu. Stop the DVD playback.

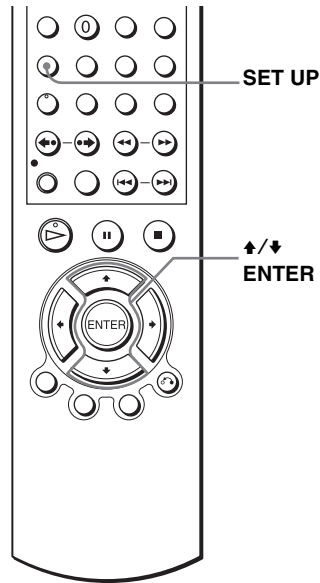

- 1** **SET UP** Press SET UP, then press \uparrow/\downarrow to select (OPTION) and press ENTER.

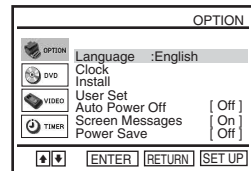
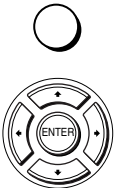

- 2** Press \uparrow/\downarrow to select "Language," then press ENTER.



The "LANGUAGE SET" menu appears.

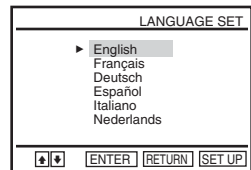

- 3** Press \uparrow/\downarrow to select the desired language, then press ENTER.



- 4** **SET UP** Press SET UP to exit the menu.



Step 6 : Setting the clock

You must set the time and date on the DVD-VCR to use the timer features properly.

The Auto Clock Set function works only if a station in your area is broadcasting a time signal.

Before you start...

- Turn on the DVD-VCR and your TV.
- To control the DVD-VCR, set TV / DVD-VIDEO to DVD-VIDEO on the remote (page 10).
- Set your TV to the video channel so that the signal from the player appears on the TV screen.
- If the DVD player is in play mode, you cannot display the setup menu. Stop the DVD playback.

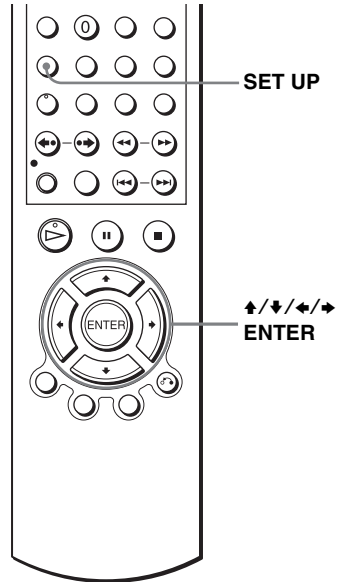

1 Press **SET UP**, then press **▲/▼** to select **(OPTION)** and press **ENTER**.

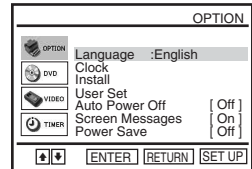
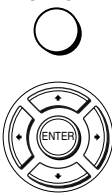

2 Press **▲/▼** to select “Clock,” then press **ENTER**.



The “**CLOCK SET**” menu appears.

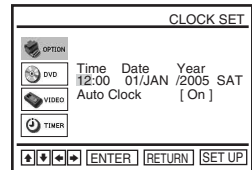

3 Press **▲/▼** to set the hour.

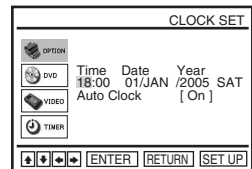

4



Press \blacktriangleright to select the minutes and set the minutes by pressing $\blacktriangle/\blacktriangledown$.

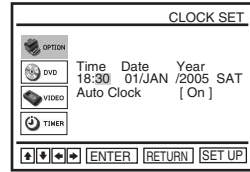

5



Set the day, month, and year in sequence by pressing \blacktriangleright to select the item to be set, and press $\blacktriangle/\blacktriangledown$ to select the digits, then press \blacktriangleright .

The day of the week is set automatically.

Press \blacktriangleright to select "Auto Clock."

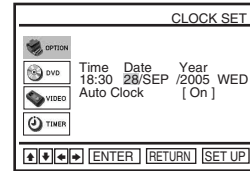

6



Press $\blacktriangle/\blacktriangledown$ to select "On" for the setting of the Auto Clock Set function.

The DVD-VCR automatically sets the clock according to the time signal broadcast between the channels PR 1 to PR 5.

If you do not need the Auto Clock Set function, select "Off."

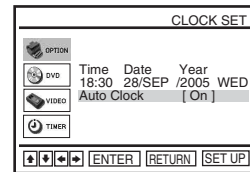

7



Press ENTER to confirm the setting.

8

SET UP



Press SET UP to exit the menu.

Tips

- If you set "Auto Clock" to "On," the Auto Clock Set function is activated whenever the DVD-VCR is turned off. The time is adjusted automatically by making reference to the time signal from the station.
- To change the digits while setting, press \blacktriangleleft to return to the item to be changed, and select the digits by pressing $\blacktriangle/\blacktriangledown$.

Note

- The clock display appears when VIDEO mode is selected with no tape inserted or when the DVD-VCR is turned off.

Step 7 : Presetting channels

If some channels could not be preset using the Auto Set Up function, you can preset them manually.

Before you start...

- Turn on the DVD-VCR and your TV.
- To control the DVD-VCR, set **TV / DVD-VIDEO** to **DVD-VIDEO** on the remote (page 10).
- Set your TV to the video channel so that the signal from the player appears on the TV screen.
- If the DVD player is in play mode, you cannot display the setup menu. Stop the DVD playback.

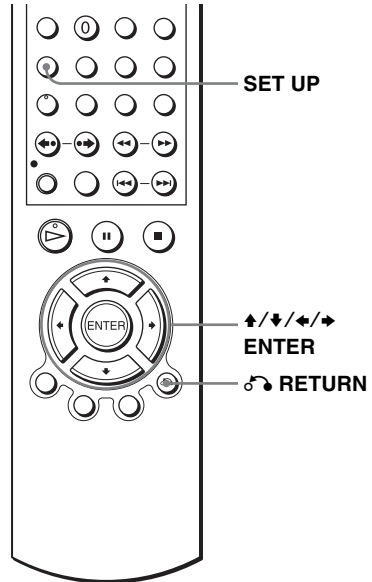

1 **SET UP** Press SET UP, then press \uparrow/\downarrow to select (OPTION) and press ENTER.

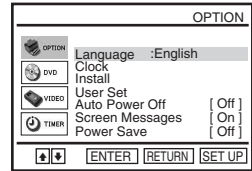

2 Press \uparrow/\downarrow to select "Install," then press ENTER.
The "INSTALL" menu appears.

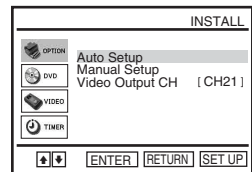

3 Press \uparrow/\downarrow to select "Manual Setup," then press ENTER.

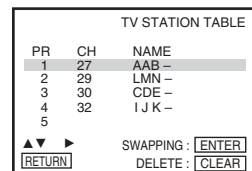

4



Press \uparrow/\downarrow to select the row which you want to preset, then press \rightarrow .

To display other pages for programme positions 6 to 80, press \uparrow/\downarrow repeatedly.

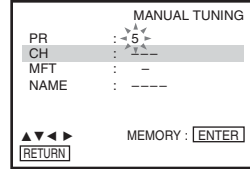

5



Press \leftarrow/\rightarrow repeatedly until the channel you want is displayed.

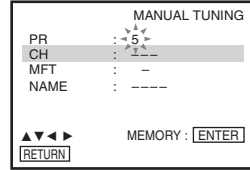

6



Press \uparrow/\downarrow to select "NAME," then press \rightarrow .

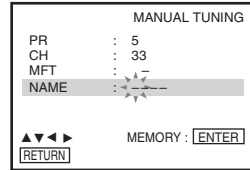

7



Enter the station name.

1 Press \uparrow/\downarrow to select a character.

Each time you press \uparrow , the character changes as shown below.

A \rightarrow **B** \rightarrow ... \rightarrow **Z** \rightarrow **0** \rightarrow **1** \rightarrow ... \rightarrow **9**
 \rightarrow - (space) \rightarrow **A**

2 Press \rightarrow to set the next character.

The next space flashes.

To correct a character, press \leftarrow/\rightarrow until the character you want to correct flashes, then reset it.

You can set up to 4 characters for the station name.

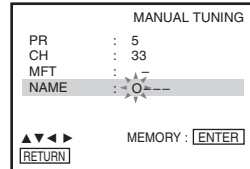

8



Press ENTER to confirm the station name.

9



RETURN

SET UP



Press \rightarrow RETURN, then press SET UP to exit the menu.

continued

If the picture is not clear

If the picture is not clear, you may use the Manual Fine Tuning (MFT) function. After step 5, press **▲/▼** to select "MFT." Press **◀/▶** to get a clear picture. Then press **ENTER**.

Tip

- The DVD-VCR must receive channel information for station names to appear automatically.

Note

- When adjusting MFT, the menu may become difficult to read due to interference from the picture being received.

Changing/disabling programme positions

After setting the channels, you can change the programme positions as you like. If any programme positions are unused or contain unwanted channels, you can disable them.

You can also change the station names. If the station names are not displayed, you can enter them manually.

Changing programme positions

Before you start...

- Turn on the DVD-VCR and your TV.
- To control the DVD-VCR, set **TV / DVD-VIDEO** to **DVD-VIDEO** on the remote (page 10).
- Set your TV to the video channel so that the signal from the player appears on the TV screen.
- If the DVD player is in play mode, you cannot display the setup menu. Stop the DVD playback.

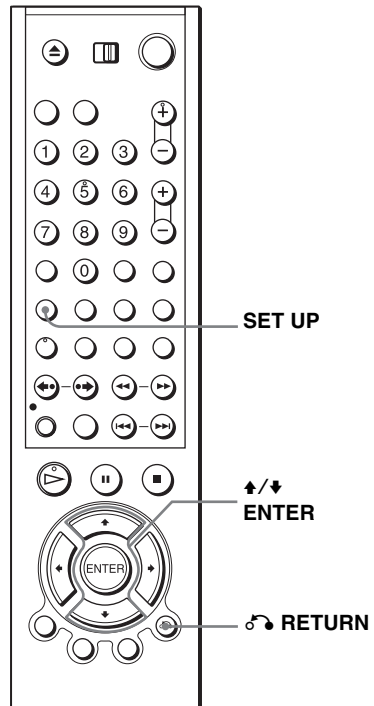

1

SET UP



Press **SET UP**, then press **▲/▼** to select (OPTION) and press **ENTER**.

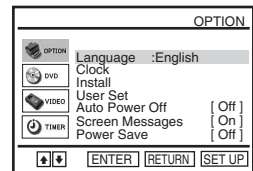

2



Press \uparrow/\downarrow to select “Install,” then press ENTER.

The “INSTALL” menu appears.

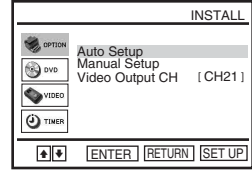

3



Press \uparrow/\downarrow to select “Manual Setup,” then press ENTER.

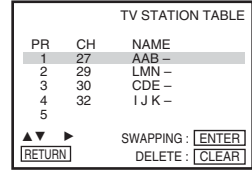

4



Press \uparrow/\downarrow to select the row containing the programme position you want to change.

To display other pages for programme positions 6 to 80, press \uparrow/\downarrow repeatedly.

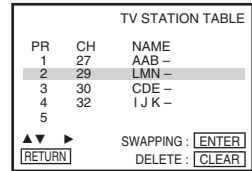

5



Press ENTER, then press \uparrow/\downarrow to move to the desired programme position.

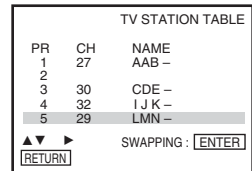

6



Press ENTER to confirm the setting.

To change the programme position of another station, repeat steps 4 through 6.

7



RETURN

SET UP



continued

Disabling unwanted programme positions

After presetting channels, you can disable unused programme positions. The disabled positions will be skipped later when you press the PROG +/- buttons.

Before you start...

- Turn on the DVD-VCR and your TV.
- To control the DVD-VCR, set TV / DVD-VIDEO to DVD-VIDEO on the remote (page 10).
- Set your TV to the video channel so that the signal from the player appears on the TV screen.
- If the DVD player is in play mode, you cannot display the setup menu. Stop the DVD playback.

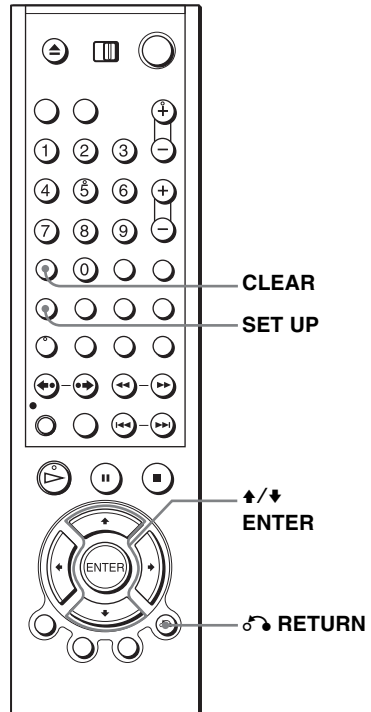

- 1** Press SET UP, then press to select (OPTION) and press ENTER.

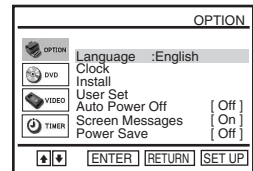
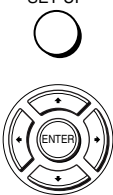

- 2** Press to select "Install," then press ENTER.



The "INSTALL" menu appears.

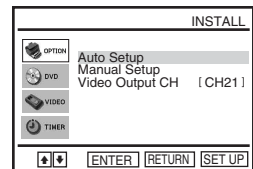

3



Press \uparrow/\downarrow to select “Manual Setup,” then press ENTER.

TV STATION TABLE		
PR	CH	NAME
1	27	AAB -
2	29	LMN -
3	30	CDE -
4	32	I J K -
5		

\uparrow \downarrow SWAPPING :
 DELETE :

4



Press \uparrow/\downarrow to select the row which you want to disable.

To display other pages for programme positions 6 to 80, press \uparrow/\downarrow repeatedly.

TV STATION TABLE		
PR	CH	NAME
1	27	AAB -
2	29	LMN -
3	30	CDE -
4	32	I J K -
5		

\uparrow \downarrow SWAPPING :
 DELETE :

5

CLEAR



Press CLEAR.

The selected row will be cleared as shown on the right.

TV STATION TABLE		
PR	CH	NAME
1	27	AAB -
2		
3	30	CDE -
4	32	I J K -
5		

\uparrow \downarrow SWAPPING :
 DELETE :

6

Repeat steps 4 and 5 for any other programme positions you want to disable.

7



RETURN

Press \circlearrowleft RETURN, then press SET UP to exit the menu.

SET UP

**Note**

- Be sure to select the programme position you want to disable correctly. If you disable a programme position by mistake, you need to reset that channel manually.

continued



Changing the station names

You can change or enter the station names (up to 4 characters). The DVD-VCR must receive channel information for station names to appear automatically.

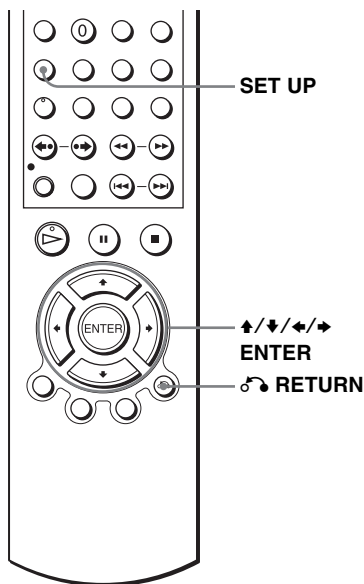

Before you start...

- Turn on the DVD-VCR and your TV.
- To control the DVD-VCR, set TV / DVD-VIDEO to DVD-VIDEO on the remote (page 10).
- Set your TV to the video channel so that the signal from the player appears on the TV screen.
- If the DVD player is in play mode, you cannot display the setup menu. Stop the DVD playback.



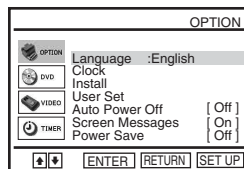

- 1**  Press SET UP, then press  to select (OPTION) and press ENTER.

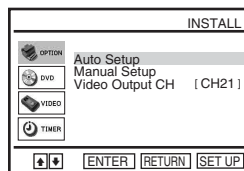

- 2**  Press  to select “Install,” then press ENTER.
The “INSTALL” menu appears.



- 3**  Press  to select “Manual Setup,” then press ENTER.

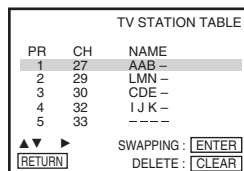

4



Press \uparrow/\downarrow to select the row which you want to change or enter the station name, then press \rightarrow .
To display other pages for programme positions 6 to 80, press \downarrow/\uparrow repeatedly.

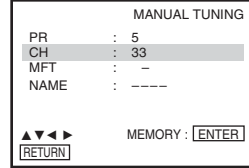

5



Press \uparrow/\downarrow to select "NAME," then press \rightarrow .

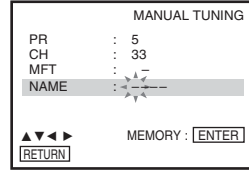

6



Enter the station name.

1 Press \uparrow/\downarrow to select a character.

Each time you press \uparrow , the character changes as shown below.

A \rightarrow **B** \rightarrow ... \rightarrow **Z** \rightarrow **0** \rightarrow **1** \rightarrow ... \rightarrow **9**
 \rightarrow (space) \rightarrow **A**

2 Press \rightarrow to set the next character.

The next space flashes.

To correct a character, press \leftarrow/\rightarrow until the character you want to correct flashes, then reset it.

You can set up to 4 characters for the station name.

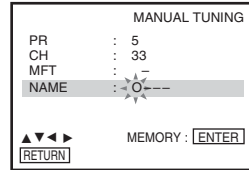

7



Press ENTER to confirm the new name.

8



RETURN

SET UP



Press \rightarrow RETURN, then press SET UP to exit the menu.

Playing discs **DVD-V** **DVD-RW** **VCD** **CD** **DATA-CD** **DATA-DVD**

Depending on the disc, some operations may be different or restricted. Refer to the operating instructions supplied with your disc.

Before you start...

- Turn on the DVD-VCR and your TV.
- Set your TV to the video channel so that the signal from the player appears on the TV screen.
- Set **TV / DVD-VIDEO** to **DVD-VIDEO**, then press **SELECT DVD** to control the DVD player (page 10).

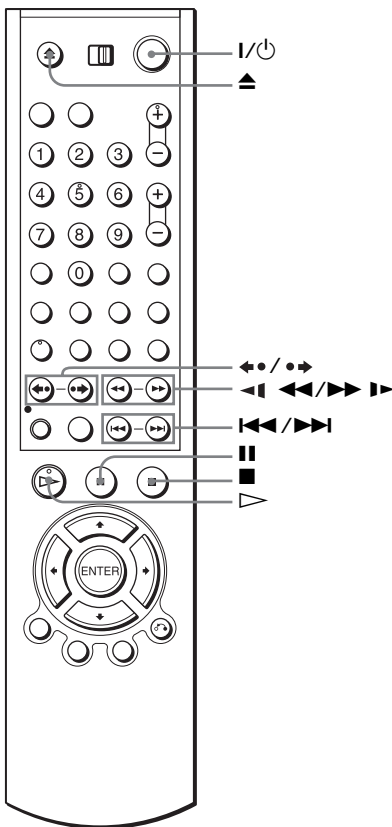

1



Press  to open the disc tray and place a disc on the disc tray.

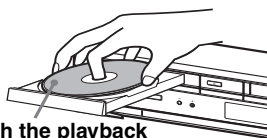

with the playback side facing down

2



Press .

The disc tray closes and the DVD player starts playback.

The display window shows the playback time.*

Depending on the disc, a menu may appear on the TV screen.

For DVDs, see page 69. For VIDEO CDs, see page 92.

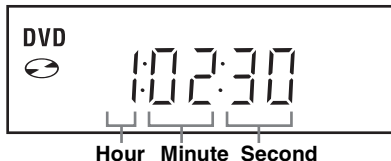

* "-----" appears when no disc is loaded.









Tips

- To make a video timer reservation during DVD playback, we recommend performing the operations under "Quick Timer Recording" (page 94).
- During DVD playback, DVD-VCR does not standby even if the VCR stops recording.

Notes

- You can change the screen type using the "SCREEN SETUP" menu (see "Screen Setup" on page 60).
- Stop VIDEO playback while playing back a disc.
- If you play a DVD or VIDEO CD that has scratches, the player may stop playback at the point of the scratch.
- Playback of play lists longer than 10 hours recorded in VR mode is not guaranteed.

Additional tasks

To	Press
Stop play	
Pause play*1	
Resume play after pause	
Go to the next frame in pause mode	 SKIP
Go to the previous frame in pause mode	 REPLAY
Go to the next chapter, track, or scene in continuous play mode	 NEXT on the remote or  on the unit
Go back to the previous chapter, track, or scene in continuous play mode	 PREV on the remote or  on the unit

To	Press
Locate a point quickly	<p>◀◀ or ▶▶ on the remote (or hold down ◀◀ or ▶▶ on the unit)</p> <p>The playback speed changes as follows each time you press the button on the remote (or depending on how long you press the button on the unit):</p> <ul style="list-style-type: none"> DVD <ul style="list-style-type: none"> fast forward: PLAY → ×1.4 ●▶▶▶*2 → 1▶▶▶ → 2▶▶▶ → 3▶▶▶ → 4▶▶▶ → 5▶▶▶ → 6▶▶▶ fast reverse: PLAY → 1◀◀◀ → 2◀◀◀ → 3◀◀◀ → 4◀◀◀ → 5◀◀◀ → 6◀◀◀ CD, MP3 and VIDEO CD <ul style="list-style-type: none"> fast forward: PLAY → 1▶▶▶ → 2▶▶▶ → 3▶▶▶ fast reverse: PLAY → 1◀◀◀ → 2◀◀◀ → 3◀◀◀ <p>When you find the point you want, press ▷.</p>
Watch slow motion in continuous play mode (DVD and VIDEO CD only)	<p>⏸ during playback, then press ◀◀ or ▶▶</p> <p>The playback speed changes as follows each time you press ◀◀ or ▶▶:</p> <ul style="list-style-type: none"> DVD <ul style="list-style-type: none"> forward slow motion: ×0.6 ●▶▶▶*2 → 2▶▶▶ → 3▶▶▶ reverse slow motion (except for DVD-RW in VR mode): 1◀◀◀ → 2◀◀◀ → 3◀◀◀ VIDEO CD <ul style="list-style-type: none"> forward slow motion only: 1▶▶▶ → 2▶▶▶ → 3▶▶▶ <p>To resume normal playback, press ▷.</p>
Replay the previous scene for 10 seconds in continuous play mode*3 (Instant Replay)	◀● REPLAY
Briefly fast forward the current scene for 30 seconds in continuous play mode*3*4 (Instant Advance)	●▶ SKIP
Stop play and remove the disc	⏏

*1 If you pause the DVD player for more than 5 minutes, the DVD player will automatically stop.

*2 Playback quickly or slowly with sound (see “To playback quickly or slowly with sound (DVD only)” on page 31).

*3 For DVD VIDEOS and DVD-RWs/DVD-Rs or DVD+RWs/DVD+Rs only

*4 You can press ●▶ SKIP up to 4 times. This allows you to fast forward up to 2 minutes in total.

Tips

- The Instant Replay function is useful when you want to review a scene or dialogue that you missed.
- The Instant Advance function is useful when you want to pass over a scene that you do not want to watch.

Notes

- No sound is output except for:
 - during normal play
 - during playback quickly or slowly with sound
- You cannot perform playback quickly or slowly with sound when a virtual surround effect is set.
- The fast reverse operation may not be possible for CD, MP3 and VIDEO CD depending on the recording method.
- You may not be able to use the Instant Replay or Instant Advance function with some scenes.
- Switching between original (ORG) and play list (PL) within a disc recorded in VR mode is possible only while the disc is stopped. Press TOP MENU to switch between ORG and PL.

To playback quickly or slowly with sound (DVD only)

You can listen to dialog or sound while playing the current scene quickly or slowly.

To playback quickly, press ►► during playback.

To playback slowly, press ■■, then press ► during playback.

Press ▷ to return to normal playback.

Notes

- You cannot set virtual surround effects while performing playback quickly or slowly with sound. In addition, you cannot perform playback quickly or slowly with sound when a virtual surround effect is set.
- You cannot perform DTS audio output during playback quickly or slowly with sound.

To Resume playback for the current disc (Resume Play)

The DVD player remembers the point where you stopped the disc even if the DVD player enters standby mode by pressing I/⏻.

1 While playing a disc, press ■ to stop playback.

2 Press ▷.

The DVD player starts playback from the point where you stopped the disc in Step 1.

Tip

- To begin playback from the top of the disc, press ■ twice then press ▷.

Notes on playing DTS* sound tracks on a CD

- When playing DTS-encoded CDs, no audio out will be output from the analogue stereo jacks. To avoid possible damage to the audio system, the consumer should take proper precautions when the analogue stereo jacks of the DVD player are connected to an amplification system.
- Do not play DTS sound tracks without first connecting the DVD player to an audio component having a built-in DTS decoder. The DVD player outputs the DTS signal via the DIGITAL AUDIO OUT (COAXIAL or OPTICAL) jack even if “DTS” is set to “Off” in “AUDIO SETUP” menu (page 58), and may affect your ears or cause your speakers to be damaged.

Notes on playing DVDs with a DTS sound track

- DTS audio signals are output only through the DIGITAL AUDIO OUT (COAXIAL or OPTICAL) jack.
- When you play a DVD with DTS sound tracks, set “DTS” to “On” in “AUDIO SETUP” menu (page 58). You cannot select DTS audio stream when “DTS” is set to “Off”.
- If you connect the player to audio equipment without a DTS decoder, do not set “DTS” to “On” in “AUDIO SETUP” menu (page 58). A loud noise may come out from the speakers, affecting your ears or causing the speakers to be damaged.

* “DTS” and “DTS Digital Out” are trademarks of Digital Theater Systems, Inc.

Guide to the on-screen display

DVD-V DVD-RW VCD CD

You can check disc information during playback.

The displayed contents differ according to the type of disc being played.

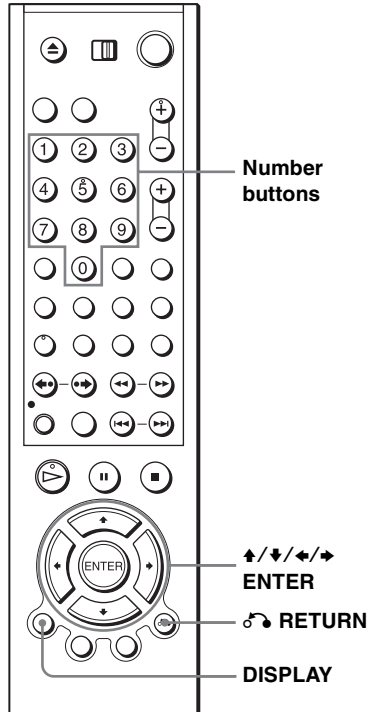

Basic Operations

Press DISPLAY during playback. The following information appears; type of disc, current title/track, chapter, counter position, voice language, subtitle language and Custom AV Mode setting. Refer to “DVD Audio/Subtitle Language” on page 123 for the abbreviation of the language.

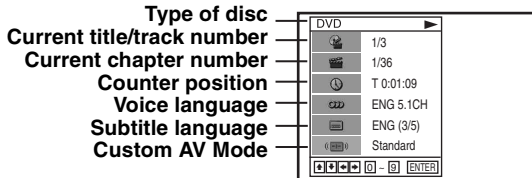

Note

- You cannot select disc information items when the disc is stopped.

continued

To playback the desired title/track or chapter

You can playback the desired title/track or chapter using this menu.

- 1 Press \uparrow/\downarrow during playback to select the desired item.
- 2 Press \leftarrow/\rightarrow to change the item.
- 3 Press ENTER to start playback.
- 4 Press DISPLAY or RETURN to turn off the menu.

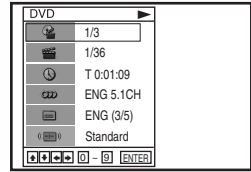

The title/track or chapter icon will appear on the DVD playback screen followed by the current title/track or chapter number and the counter position.

To playback from the desired title/track counter position

You can playback the desired title/track counter position using this menu.

- 1 Press \uparrow/\downarrow during playback to select the counter position icon.
- 2 Enter the desired elapsed playing time of the current title/track using the number buttons.
- 3 Press ENTER to start playback.
- 4 Press DISPLAY or RETURN to turn off the menu.

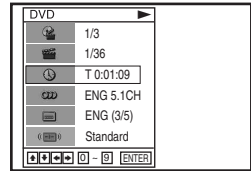

Tip

- You can change the counter position information (playing time or remaining time) using \leftarrow/\rightarrow (DVD and CD only).

DVD

Indication	Counter information
T * : ** : **	Elapsed playing time of the current title
T- * : ** : **	Remaining time of the current title
C * : ** : **	Elapsed playing time of the current chapter
C- * : ** : **	Remaining time of the current chapter

CD

Indication	Counter information
T * : ** : **	Elapsed playing time of the current track
T- * : ** : **	Remaining time of the current track
D * : ** : **	Elapsed playing time of the disc
D- * : ** : **	Remaining time of the disc

Notes

- The display may not change as operated depending on the disc.
- The display window continue indicating the playing time even when the counter position information on the on-screen display is being changed.
- The remaining time of the current track and the disc may not be indicated correctly for Copy Control CDs, CD EXTRA or CDs with jacket pictures on the disc, etc.

To adjust the playback picture (Custom AV Mode)

You can adjust the video signal of the DVD or VIDEO CD (with PBC function off) from the player to obtain the picture quality you want. Choose the setting that best suits the programme you are watching.

- 1 Press $\blacktriangle/\blacktriangledown$ during playback to select the Custom AV Mode icon.

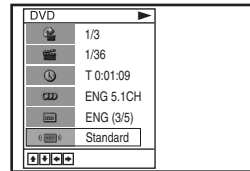

- 2 Press \leftarrow/\rightarrow to change the setting.

Setting	Video Setting	Audio Setting
Dynamic 2	Produces a more dynamic picture than Dynamic 1 by further increasing the picture contrast and the colour intensity.	Full (modulated) sound with even clearer treble and bass than Dynamic 1.
Dynamic 1	Produces a bold dynamic picture by increasing the picture contrast and the colour intensity.	Full (modulated) sound with clear treble and bass.
Standard	Off (Default setting) Displays a standard picture.	Standard sound.
Cinema 1	White colours become brighter and black colours become richer, and the colour contrast is increased.	Powerful sound with strong bass.
Cinema 2	Enhances details in dark areas by increasing the black level.	Powerful sound with even stronger bass than Cinema 1.

Tip

- When you watch a movie, “Cinema 1” or “Cinema 2” is recommended.

Locking the disc tray (Child Lock)

DVD-V **DVD-RW** **VCD** **CD** **DATA-CD** **DATA-DVD**

You can lock the disc tray so that the disc tray is not opened by mistake.

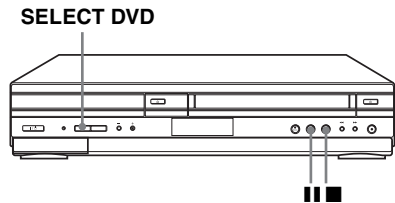

To lock the disc tray

When the DVD-VCR is turned on, press **■**, **■** and **SELECT DVD** on the unit at the same time. “LOCK” appears in the display window. The disc tray is locked.

To unlock the disc tray

Press **■**, **■** and **SELECT DVD** on the unit at the same time. The disc tray is unlocked.

Notes

- If you lock the disc tray while open, the disc tray will be locked after closing.
- You cannot lock the disc tray when the DVD-VCR is turned off. If the DVD-VCR is turned on, you can lock the disc tray either in play mode or stop mode.

Playing a tape **VHS**

Before you start...

- Turn on the DVD-VCR and your TV.
- Set your TV to the video channel so that the signal from the player appears on the TV screen.
- Set **TV / DVD-VIDEO** to **DVD-VIDEO**, then press **SELECT VIDEO** to control the VCR (page 10).

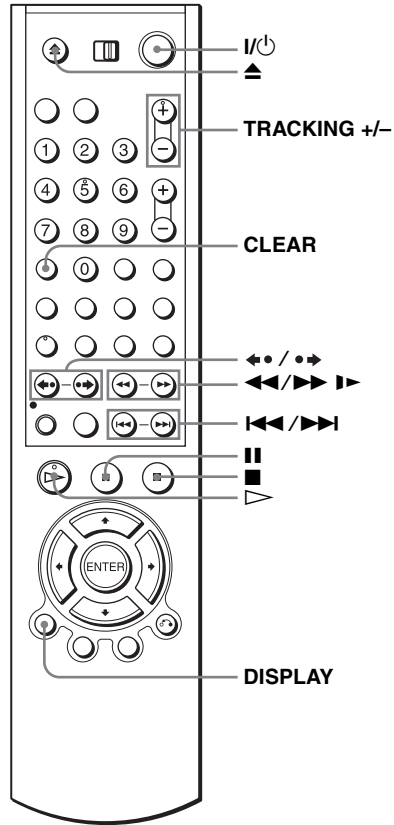

1

Insert a tape.

The VCR starts playing automatically if you insert a tape with its safety tab removed.

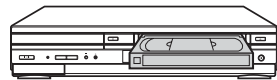

2



Press .

The display window shows the playback time.

When the tape reaches the end, it will rewind automatically.



continued

Additional tasks

To	Press
Stop play	■
Pause play*	
Resume play after pause	or ▷
Fast-forward the tape	▶▶ during stop
Rewind the tape	◀◀ during stop
Eject the tape	▲

* If you pause the VCR for more than 5 minutes, the VCR will automatically resume play.

To turn off the power while rewinding (Rewind Shut Off)

Press I/⏻ while the tape is rewinding. The power will turn off, but the tape will keep rewinding until it reaches the end.

To play/search at various speeds

Playback options	Operation
View the picture during fast-forward or rewind	During fast-forward, hold down ▶▶. During rewind, hold down ◀◀.
Play at high speed	<ul style="list-style-type: none"> • During playback, briefly press ▶▶ or ◀◀. The tape continues to play at 5 times normal speed. • During playback, hold down ▶▶ or ◀◀. The tape continues to play at 5 times normal speed. When you release the button, normal playback resumes.
Play in slow motion* ¹	During pause, press ▶▶.
Replay the previous scene in continuous play mode* ² (Instant Replay)	During playback, press ◀◀ REPLAY.
Fast forward the current scene for 30 seconds in continuous play mode* ³ (Instant Skip)	During playback, press ●▶ SKIP.
Play at various speeds (Shuttle play)	During playback, press ◀◀ or ▶▶. You can change the playback speed as follows. REW* ⁴ ↔ -PLAY2 ↔ -PLAY ↔ -SLOW ↔ STILL ↔ SLOW ↔ PLAY ↔ PLAY2 ↔ FF* ⁵

*¹ You can change the slow motion playback speed by pressing ▶▶ or ◀◀.

*² For 10 seconds in SP or LP mode/for 15 seconds in EP mode

*³ You can press ●▶ SKIP up to 4 times. This allows you to fast forward up to 2 minutes in total.

*⁴ "REW" flashes in the display window.

*⁵ "FF" flashes in the display window.

To resume normal playback

Press \triangleright .

To set the colour system

If the playback picture has no colour, or streaks appear during playback, set “Colour System” in the “USER SET” menu to conform to the system that the tape was recorded in (see page 107). (Normally set the option to “Auto.”)

To use the time counter

Press CLEAR at the point on the tape that you want to find later. The counter in the display window resets to “0:00:00.”



To display the counter on the TV screen, press DISPLAY during normal playback.

Tip

- Adjust the picture using the TRACKING +/- buttons if:
 - Streaks appear while playing in slow motion.
 - Bands appear at the top or bottom while pausing.
 - The picture shakes during pause.

Notes

- Tapes recorded in LP mode on other VCRs can be played back on this VCR but the picture quality cannot be guaranteed.
- The counter resets to “0:00:00” whenever a tape is reinserted.
- The counter stops counting when it comes to a portion with no recording.
- Depending on your TV, the following may occur while playing an NTSC-recorded tape:
 - The picture becomes black and white.
 - The picture shakes.
 - No picture appears on the TV screen.
 - Black streaks appear horizontally on the TV screen.
 - The colour density increases or decreases.
- When 10 hours have passed, the counter in the display window returns to “0:00:00” and the count starts over again.
- No sound is output during playback at various speeds.
- The picture may show noise when playing at high speed in reverse.
- While playing a tape, you can display the setup menu, but the remote commander’s function switches to DVD automatically. Press SET UP to exit the menu.
- Stop disc playback while playing back a video.
- The picture returns to normal playback from slow motion in reverse in 30 seconds.

Recording TV programmes **VHS**

Before you start...

- Turn on the DVD-VCR and your TV.
- Switch the input selector on your TV so that the signal from the player appears on the TV screen.
- Set **TV / DVD-VIDEO** to **DVD-VIDEO**, then press **SELECT VIDEO** to control the VCR (page 10).
- To record from a satellite or digital tuner, turn it on.
- Make sure the tape is longer than the total recording time.

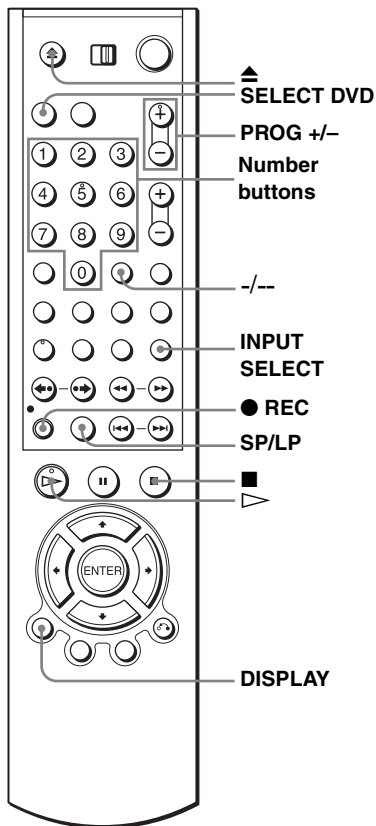

1

Insert a tape with its safety tab in place.

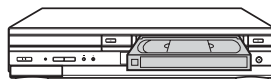

2

• PROG/
TRACKING

- To record a normal channel, press PROG +/- until the programme position number you want appears in the display window.

INPUT
SELECT

- To record from other equipment connected to one or more of the LINE inputs, press INPUT SELECT until the connected line appears in the display window.



3

SP / LP



Press SP/LP to select the tape speed, SP or LP.

LP (Long Play) provides recording time twice as long as SP. However, SP (Standard Play) produces better picture and audio quality.



4

● REC



Press ● REC to start recording.

The recording indicator lights up red in the display window.



Recording indicator

To stop recording

Press ■.

continued

To check the remaining time

Press DISPLAY three times. With the display on, press DISPLAY again to check the remaining time.

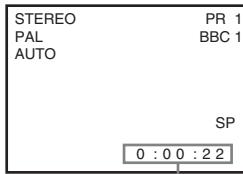

Time counter

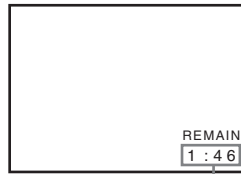

Remaining tape length

In order to get an accurate remaining time indication, be sure "Tape Select" in the "VIDEO SETUP" menu is set according to the tape type you use (see page 102).



Maximum Recording Time

Tape Length	SP	LP
E-180	3 hrs	6 hrs
E-240	4 hrs	8 hrs
E-260	4 hrs 20 mins	8 hrs 40 mins
E-300	5 hrs	10 hrs

To watch another TV programme while recording

- 1 If your TV is connected to the VCR using A/V connections, set the TV to the TV's antenna input; if not, skip this step.
- 2 Select another channel on the TV.

To watch a DVD while recording

- 1 Press SELECT DVD to control the DVD player.
- 2 Press  and place the disc on the disc tray.
- 3 Press .

The disc tray closes and the DVD player starts playback. The TV screen will automatically change to the DVD playback screen.

To save a recording

To prevent accidental erasure, break off the safety tab as illustrated. To record on the tape again, cover the tab hole with adhesive tape.

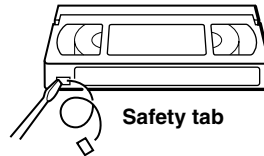

Tips

- To select a programme position, you can use the number buttons on the remote commander. For two-digit numbers, press **-/-** (ten's digit) followed by the number buttons.
- If you connect additional equipment to a **LINE** connector or jack, you can select the input signal using the **INPUT SELECT** or **PROG +/-** buttons.
- The display appears on the TV screen indicating information about the tape, but the information will not be recorded on the tape.
- If you do not want to watch TV while recording, you can turn off the TV. When using a satellite or digital tuner, make sure to leave it on.

Notes

- If a tape has portions recorded in both PAL and NTSC systems, the time counter reading will not be correct. This discrepancy is due to the difference between the counting cycles of the two video systems.
- The remaining tape length may not be indicated accurately for short tapes such as T-20 or T-30, or tapes recorded in LP mode.
- The remaining time is intended for rough measurement only.
- About 30 seconds after the tape begins playback, the tape remaining time will be displayed.
- You cannot record a DVD to a VCR tape.
- To watch a TV programme during video recording, stop disc playback.

Recording TV programmes using the VIDEO Plus+® system **VHS**

The VIDEO Plus+ system is the feature that simplifies programming the VCR to make timer recordings. Just enter the PlusCode number listed in the TV programme guide. The date, times, and programme position of that programme are set automatically. You can preset a total of six programmes, including settings made with other timer methods.

Before you start...

- Check that the DVD-VCR clock is set to the correct time.
- Turn on the DVD-VCR and your TV.
- Set your TV to the video channel so that the signal from the player appears on the TV screen.
- Set **TV / DVD-VIDEO** to **DVD-VIDEO**, then press **SELECT VIDEO** to control the VCR (page 10).
- When using a satellite or digital tuner, turn it on.
- Insert a tape with its safety tab in place. Make sure the tape is longer than the total recording time.
- If the DVD player is in play mode, you cannot display the setup menu. Stop the DVD playback.

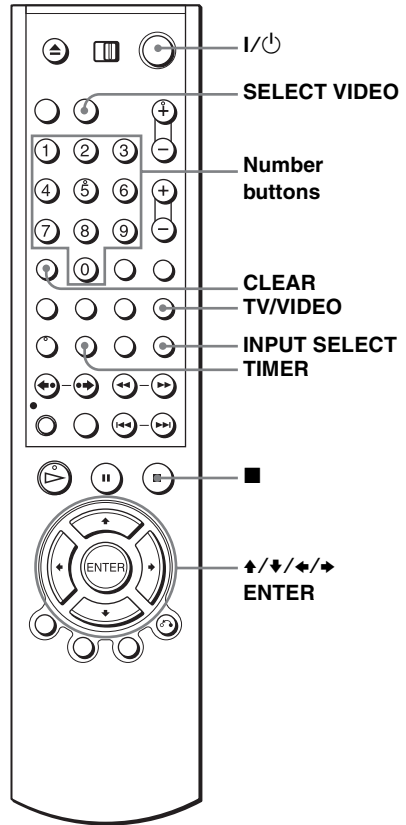

1



Press **SET UP**, then press **▲/▼** to select **(TIMER)** and press **ENTER**. You can also display the timer programming menu by pressing **TIMER**.

The "TIMER METHOD" menu appears.

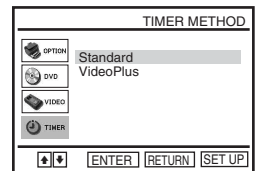

5

If you want to change the date, tape speed and the PDC setting:

- 1 Press ←/→ to select the item you want to change.
- 2 Press ↑/↓ to reset it.
 - To record the same programme every day or the same day every week, see “Daily/weekly recording” on page 46.
 - To use the PDC function, set “PDC” to “On.” For details about the PDC function, see “Timer recording with PDC signals” on page 46.

PR	DATE	START	STOP	SPEED	PDC
35	SA 19	19:00	20:00	SP	Off
---	---	---	---	---	---
---	---	---	---	---	---
---	---	---	---	---	---
---	---	---	---	---	---
<input type="button" value="ENTER"/> <input type="button" value="CLEAR"/> <input type="button" value="SETUP"/>					

6

Press ENTER to confirm the setting.

7

Press ENTER to confirm all settings.

8

Press I/O to turn off the DVD-VCR.

The indicator appears in the display window and the VCR stands by for recording.

To record from other equipment, leave the connected equipment switched on.

To stop recording

To stop the DVD-VCR while recording, press SELECT VIDEO and then press ■.

Daily/weekly recording

In step 5 above, press ↓ to select the recording pattern. Each time you press ↓, the indication changes as shown below. Press ↑ to change the indication in reverse order.

today → **DLY** → **MO~SA** → **MO~FR** → **W~SA (every Saturday)** → **W~SU (every Sunday)** → **1 month later** → **(dates count down)** → **today**

Timer recording with PDC signals

Some broadcast systems transmit PDC signals with their TV programmes. These signals ensure that your timer recordings are made regardless of broadcast delays, early starts, or broadcast interruptions.

To use the PDC function, set “PDC” to “On” in step 5 above. You can also use the PDC function for a source connected to one or more of the LINE inputs.

To record satellite broadcasts

If you connect the satellite tuner and the VCR, you can record satellite programmes.

- 1** Turn on the satellite tuner.
- 2** On the satellite tuner, select the satellite programme for which you want to make a timer setting.
- 3** Keep the satellite tuner turned on until the VCR finishes recording the satellite programme for which you have made a timer setting.

To watch another TV programme after setting the timer

- 1** If your TV is connected to the VCR using A/V connections, set the TV to the TV's aerial input; if not, skip this step.
- 2** Select another channel on the TV.

Tips

- If the  indicator appears, this means that the VCR is currently recording this programme.
- You can also do the following tasks while the VCR is recording:
 - Reset the counter (page 39).
 - Display tape information on the TV screen (page 42).



To use the Auto Tape Speed function

In step 5 above, press  to select “Auto.” When you are recording a programme in the SP mode and the remaining tape length becomes shorter than the recording time, the recording tape speed is automatically changed to LP mode. Note that some noise will appear on the picture when the tape speed is changed. To operate this function correctly, the “Tape Select” setting in the “VIDEO SETUP” menu must be accurate (see page 102).

Tips

- To set the line input video source, you can also use the INPUT SELECT button.
- You can set the extended time for the VIDEO Plus+ setting by 10, 20, 30, 40, 50, or 60 minutes. Set “VideoPlus Extend” in the “USER SET” menu to the desired extended time on page 107.
- To check, change, or cancel the programme setting, see “Checking/changing/cancelling timer settings” on page 51.

Notes

- If the PDC signal is too weak or the broadcasting station failed to transmit PDC signals, the VCR will start recording at the set time without using the PDC function.
- The  indicator flashes in the display window when you press  with no tape inserted.

Recording TV programmes using the timer

VHS

You can preset up to six programmes at a time.

Before you start...

- Check that the DVD-VCR clock is set to the correct time.
- Turn on the DVD-VCR and your TV.
- Switch the input selector on your TV so that the signal from the player appears on the TV screen.
- Set **TV / DVD-VIDEO** to **DVD-VIDEO**, then press **SELECT VIDEO** to control the VCR (page 10).
- When using a satellite or digital tuner, turn it on.
- Insert a tape with its safety tab in place. Make sure the tape is longer than the total recording time.
- If the DVD player is in play mode, you cannot display the setup menu. Stop the DVD playback.

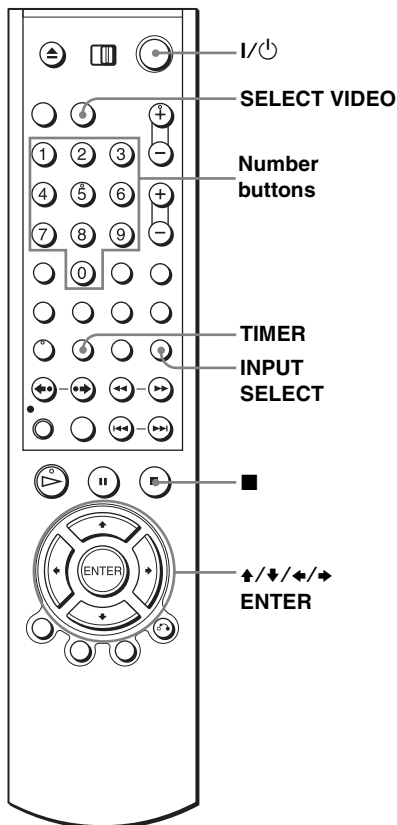

1



Press **SET UP**, then press **▲/▼** to select **(TIMER)** and press **ENTER**. You can also display the timer programming menu by pressing **TIMER**.

The "TIMER METHOD" menu appears.

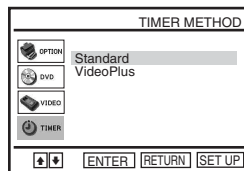

2



Press \uparrow/\downarrow to select “Standard,” then press ENTER.
The timer programming menu appears.

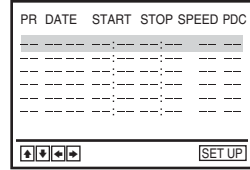

3



Set the programme position, date, start and stop times, tape speed and PDC function:

- 1 Press \rightarrow to select each item in turn.
- 2 Press \uparrow/\downarrow to set each item.
To correct a setting, press \leftarrow to return to that setting and reset.

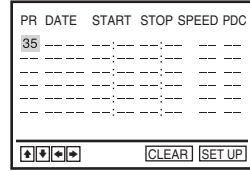

- To record the same programme every day or the same day every week, see “Daily/weekly recording” on page 50.
- To use the PDC function, set “PDC” to “On.” For details about the PDC function, see “Timer recording with PDC signals” on page 46.
- To record from other equipment connected to one or more of the LINE inputs, press INPUT SELECT to display the connected line in the “PR” position.



4



Press ENTER to confirm the setting.
To enter another setting, press \uparrow/\downarrow to select the next row and repeat step 3.

5



Press ENTER to confirm all settings.

6



Press I/O to turn off the DVD-VCR.
The \ominus indicator appears in the display window and the VCR stands by for recording.
To record from other equipment, leave the connected equipment switched on.

continued

To stop recording

To stop the DVD-VCR while recording, press SELECT VIDEO and then press ■.

Daily/weekly recording

In step 3 above, press ▼ to select the recording pattern. Each time you press ▼, the indication changes as shown below. Press ▲ to change the indication in reverse order.

today → **DLY** → **MO~SA** → **MO~FR** → **W-SA (every Saturday)** → **W-SU (every Sunday)** → **1 month later** → **(dates count down)** → **today**

To use the Auto Tape Speed function

In step 3 above, press ▼ to select “Auto.” When you are recording a programme in the SP mode and the remaining tape length becomes shorter than the recording time, the recording tape speed is automatically changed to the LP mode. Note that some noise will appear on the picture when the tape speed is changed. To operate this function correctly, the “Tape Select” setting in the “VIDEO SETUP” menu must be accurate (see page 102).

Tips

- To set the line input video source, you can also use the INPUT SELECT button.
- To check, change, or cancel the programme setting, see “Checking/changing/cancelling timer settings” on page 51.

Notes

- When setting the timer with PDC signals, enter the start times exactly as indicated in the TV programme guide. Otherwise, the PDC function will not work.
- If the PDC signal is too weak or the broadcasting station failed to transmit PDC signals, the VCR will start recording at the set time without using the PDC function.
- The ⊖ indicator flashes in the display window when you press I/⏪ with no tape inserted.

To watch another TV programme after setting the timer

- 1** If your TV is connected to the VCR using A/V connections, set the TV to the TV’s aerial input; if not, skip this step.
- 2** Select another channel on the TV.

Tips

- If the ○ indicator appears, this means that the VCR is currently recording this programme.
- You can also do the following tasks while the VCR is recording:
 - Reset the counter (page 39).
 - Display tape information on the TV screen (page 42).

Checking/changing/cancelling timer settings **VHS**

Before you start...

- Check that the DVD-VCR clock is set to the correct time.
- Turn on the DVD-VCR and your TV.
- Switch the input selector on your TV so that the signal from the player appears on the TV screen.
- Set **TV / DVD-VIDEO** to **DVD-VIDEO**, then press **SELECT VIDEO** to control the VCR (page 10).
- When using a satellite or digital tuner, turn it on.
- Insert a tape with its safety tab in place. Make sure the tape is longer than the total recording time.
- If the DVD player is in play mode, you cannot display the setup menu. Stop the DVD playback.

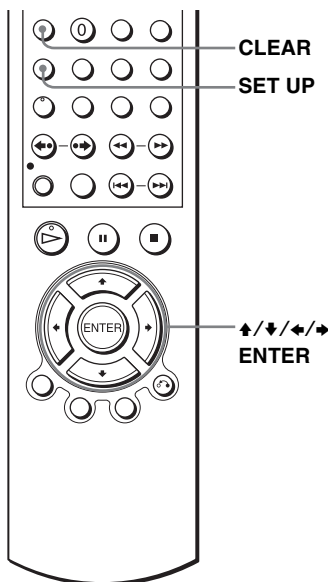

1

SET UP

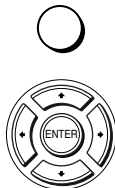

Press SET UP, then press  to select (TIMER) and press ENTER. You can also display the timer programming menu by pressing TIMER.

The "TIMER METHOD" menu appears.

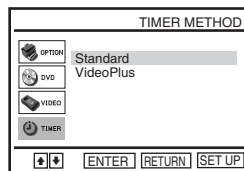

2



SET UP



Press  to select "Standard," then press ENTER.

- If you want to change a setting, go on to the next step.
- If you do not need to change the settings, press SET UP to exit the menu.

continued

3



CLEAR



Press \uparrow/\downarrow to select setting you want to change or cancel.

- To change the setting, press \leftarrow/\rightarrow to select the item you want to change, and press \uparrow/\downarrow to change it.
- To cancel the setting, press CLEAR.

PR	DATE	START	STOP	SPEED	PDC
35	MO 30	20:00	21:00	SP	Off
20	WE 02	22:00	23:30	LP	Off
60	TU 30	20:30	22:00	Auto	Off
---	---	---	---	---	---
---	---	---	---	---	---
---	---	---	---	---	---
---	---	---	---	---	---
		[ENTER]		[CLEAR] [SET UP]	

4



Press ENTER to confirm the setting.

5



Press ENTER to confirm all settings.

If any settings remain, turn off the VCR to return to recording standby.

To record from other equipment, leave the connected equipment switched on.

When the timer settings overlap

The programme that starts first has priority and the second programme starts recording only after the first programme has finished. If the programmes start at the same time, the programme listed first in the menu has priority.

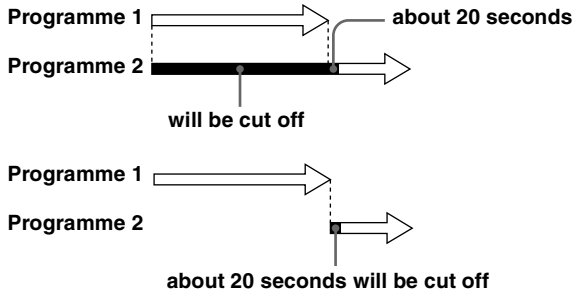

A/V Receiver hookup

DVD-V DVD-RW VCD CD DATA-CD DATA-DVD VHS

A Use this hookup if your A/V receiver has a Dolby* Surround (Pro Logic) decoder and 3 to 6 speakers

You can enjoy the Dolby Surround effects only when playing Dolby Surround audio or multi-channel audio (Dolby Digital) discs.

* Manufactured under license from Dolby Laboratories. "Dolby", "Pro Logic", and the double-D symbol are trademarks of Dolby Laboratories.

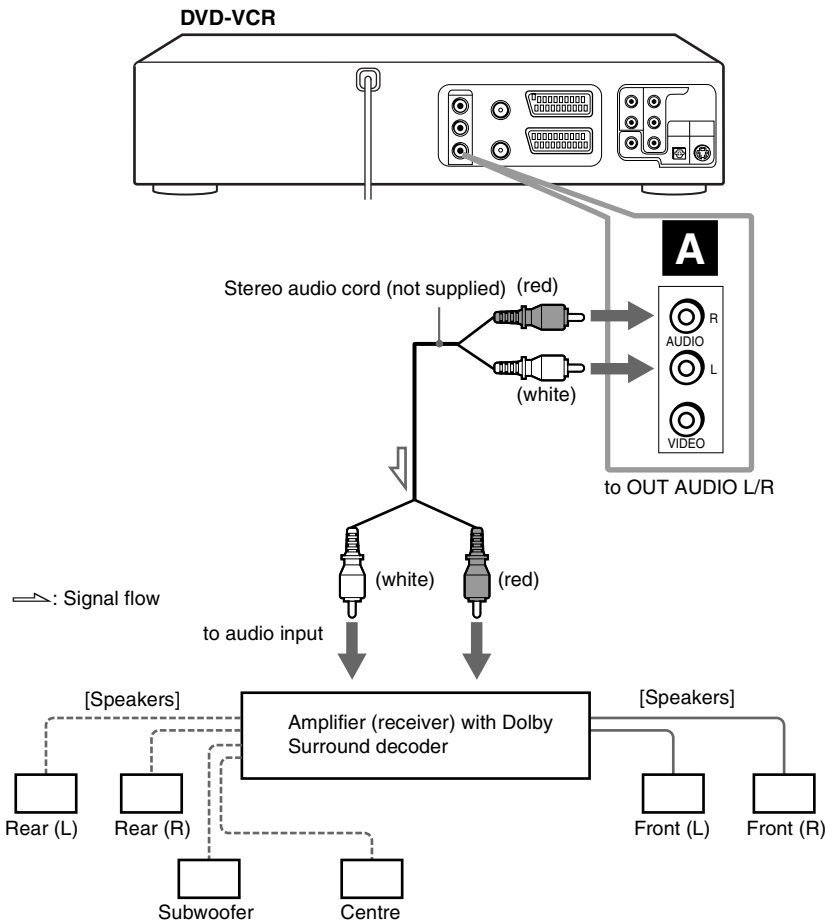

continued

B Use this hookup if your A/V receiver has a Dolby Digital, MPEG audio or DTS* decoder, a digital input jack and 6 speakers

This connection will allow you to use the Dolby Digital, MPEG audio or DTS decoder function of your AV amplifier (receiver). You are not able to enjoy the surround sound effects of this player. You must make connections using **B-1** and **B-2**.

* “DTS” and “DTS Digital Out” are trademarks of Digital Theater Systems, Inc.

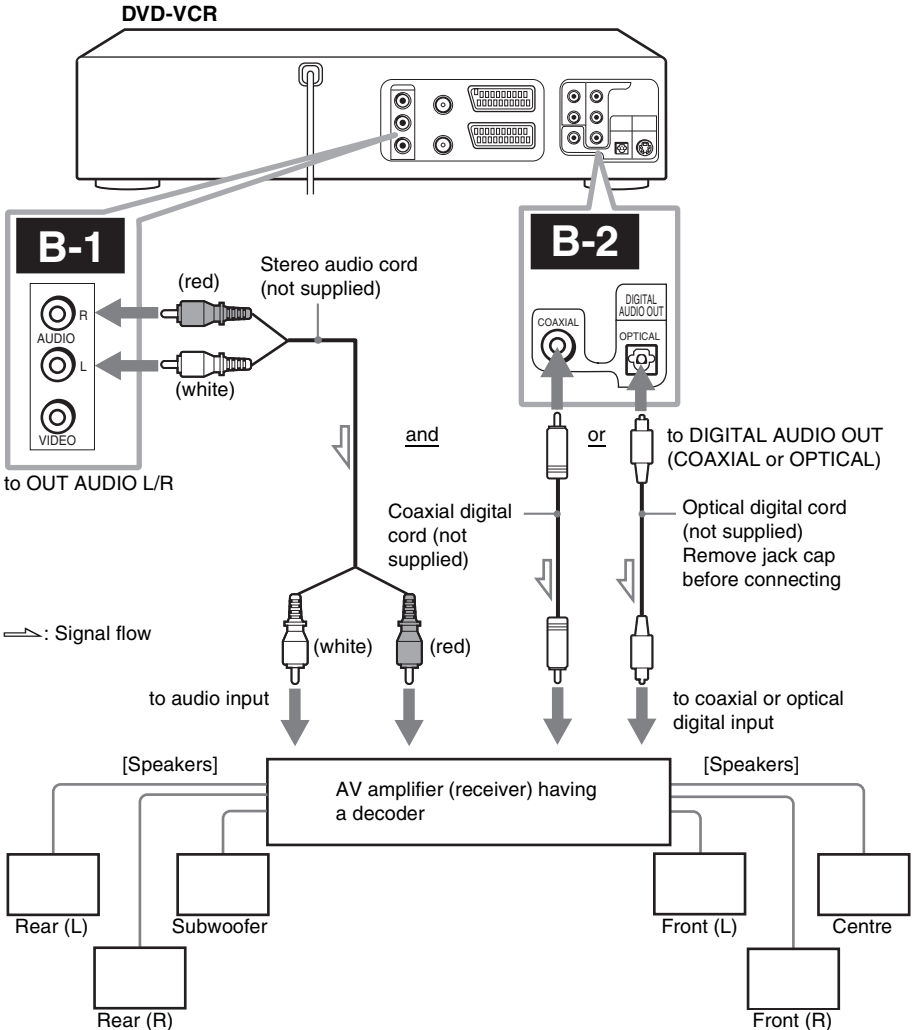

Note

- After you have completed the connection, be sure to set “Dolby Digital” to “Dolby Digital” and “DTS” to “On” in “AUDIO SETUP” menu (page 57). If your AV amplifier (receiver) has an MPEG audio decoder function, set “MPEG” to “MPEG” in “AUDIO SETUP” menu (page 57). Otherwise, no sound or a loud noise will come from the speakers.

S-Video/Component Video hookup

DVD-V **DVD-RW** **VCD** **DATA-CD** **DATA-DVD**

Make audio connections using the OUT AUDIO L/R jacks or DIGITAL AUDIO OUT (OPTICAL or COAXIAL) jacks when you use S-VIDEO/Component Video hookup.

A Use this hookup if your TV has an S-VIDEO input jack

Connect an S-VIDEO cord (not supplied). You will enjoy high quality images.

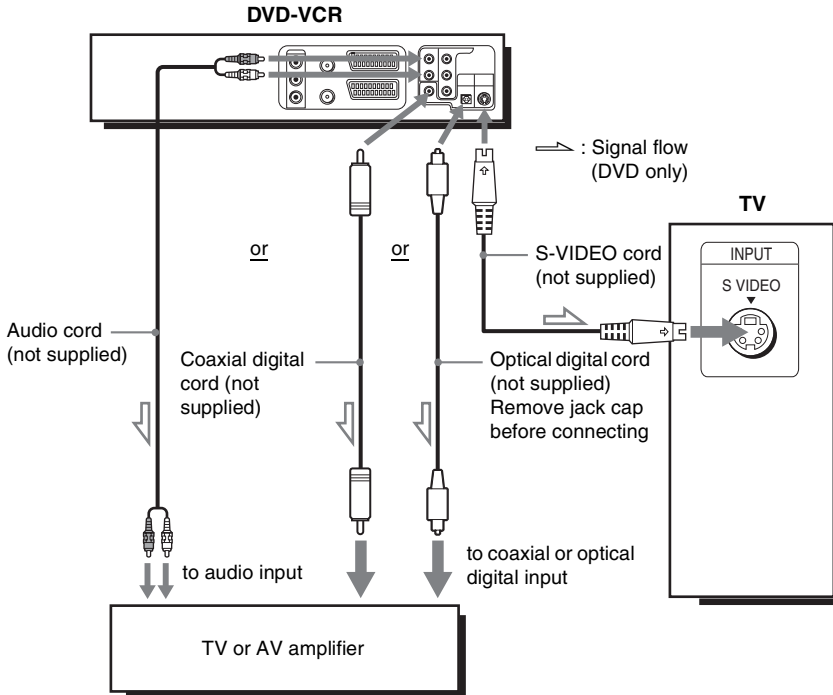

Notes

- Set "DVD S-Video Out" to "On" in the "SCREEN SETUP" menu (page 60) to view pictures from the S-VIDEO jack.
- The connection using S-VIDEO OUT jack is only for the DVD player.

B Use this hookup if your TV has component video input jacks

Connect your TV via the COMPONENT VIDEO OUT jacks using a component video cord (not supplied) or three video cords (not supplied) of the same kind and length. You will enjoy accurate color reproduction and high quality images. See page 60 for audio connections.

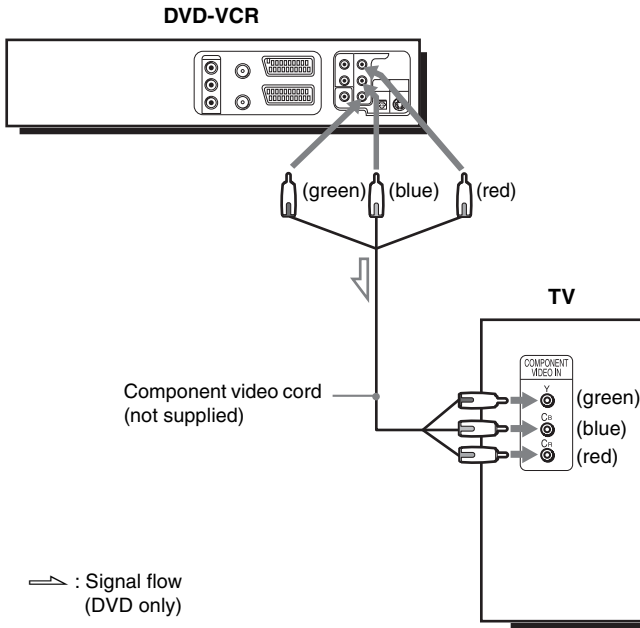

If your TV accepts progressive (525P/625P) format signals, you must use this connection and then set “Progressive” to “On” in the “SCREEN SETUP” menu (page 62). The PROGRESSIVE indicator lights up in orange when the DVD player outputs progressive signals.

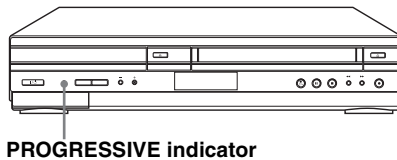



Notes

- The connection using COMPONENT VIDEO OUT jack is only for the DVD player.
- Consumers should note that not all high definition television sets are fully compatible with this product and may cause artifacts to be displayed in the picture. In case of progressive scan picture problems, it is recommended that you switch the connection to the standard definition output. If there are questions regarding your Sony TV set's compatibility with this DVD player, please contact our customer service center.

Audio Setup **DVD-V** **DVD-RW**

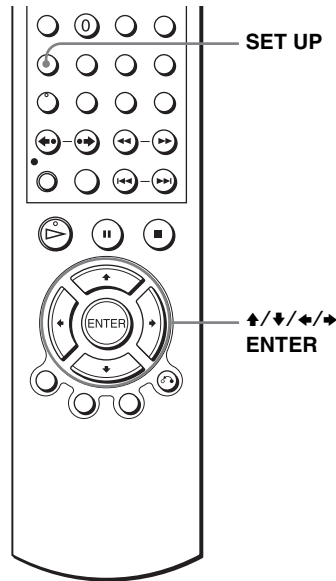
“Audio Setup” allows you to set the sound according to the playback and connection conditions.



- 1** Press SET UP when the DVD player is in stop mode, then press \uparrow/\downarrow to select  (DVD) and press ENTER.

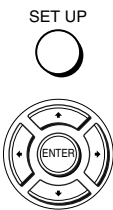

- 2** Press \uparrow/\downarrow to select “Audio Setup,” then press ENTER.

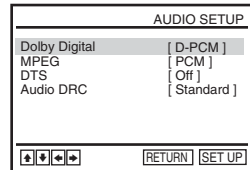

- 3** Press \uparrow/\downarrow to select the setup item from the displayed list: “Dolby Digital,” “MPEG,” “DTS” or “Audio DRC.”



continued

4

Press **←/→** to select an item.

5

SET UP



Press SET UP to exit the menu.

Menu choices

- **Dolby Digital**

Selects the type of Dolby Digital signal.

The default setting is indicated in bold print.

D-PCM	Select this when the player is connected to an audio component lacking a built-in Dolby Digital decoder.
Dolby Digital	Select this when the player is connected to an audio component with a built-in Dolby Digital decoder.

- **MPEG**

Selects the type of MPEG audio signal.

The default setting is indicated in bold print.

PCM	Select this when the player is connected to an audio component lacking a built-in MPEG decoder. If you play MPEG audio sound tracks, the player outputs stereo signals via the DIGITAL AUDIO OUT (OPTICAL or COAXIAL) jack.
MPEG	Select this when the player is connected to an audio component with a built-in MPEG decoder.

- **DTS**

Selects whether or not to output DTS signals.

The default setting is indicated in bold print.

Off	Select this when the player is connected to an audio component lacking a built-in DTS decoder.
On	Select this when the player is connected to an audio component with a built-in DTS decoder.

- Audio DRC (Dynamic Range Control)

Makes the sound clear when the volume is turned down when playing a DVD that conforms to “Audio DRC.” This affects the output from the following jacks:

- OUT AUDIO L/R jacks
- DIGITAL AUDIO OUT (OPTICAL or COAXIAL) jack only when “Dolby Digital” is set to “D-PCM.”

The default setting is indicated in bold print.

Standard	Normally select this position.
Wide Range	Gives you the feeling of being at alive performance.

Notes

- If you connect a component that does not conform to the selected audio signal, a loud noise (or no sound) will come out from the speakers, affecting your ears or causing the speakers to be damaged.
- Noise may occur in the LinearPCM double-speed audio. This is not a malfunction.
- If you set “DTS” to “On,” you cannot select surround setting (page 81).
- You cannot perform DTS audio output during playback quickly or slowly with sound (page 31).

Screen Setup **DVD-V**

“Screen Setup” allows you to set the screen according to the playback and connection conditions.

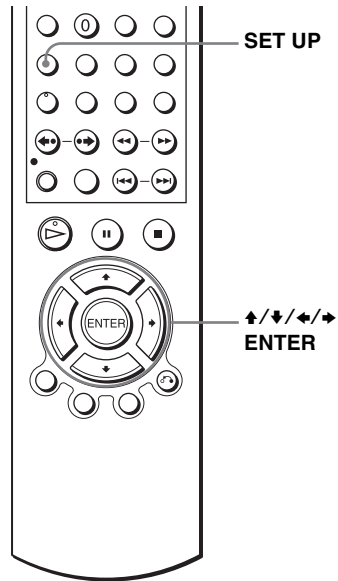

1

SET UP



Press SET UP when the DVD player is in stop mode, then press \uparrow/\downarrow to select  (DVD) and press ENTER.



2



Press \uparrow/\downarrow to select “Screen Setup,” then press ENTER.

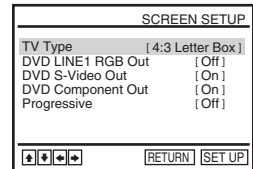

3



Press \uparrow/\downarrow to select the setup item from the displayed list: “TV Type,” “DVD LINE1 RGB Out” or “DVD S-Video Out” or “DVD Component Out”.

To set the “Progressive” setting, see page 62.

4Press **←/→** to select an item.**5**

SET UP



Press SET UP to exit the menu.

Menu choices

• TV Type

Selects the aspect ratio of the connected TV (4:3 standard or wide).

The default setting is indicated in bold print.

4:3 Letter Box	Select this when you connect a 4:3 screen TV. Displays a wide picture with bands on the upper and lower portions of the screen.
4:3 Pan Scan	Select this when you connect a 4:3 screen TV. Automatically displays the wide picture on the entire screen and cuts off the portions that do not fit.
16:9	Select this when you connect a wide-screen TV or a TV with a wide mode function.

4:3 Letter Box



4:3 Pan Scan

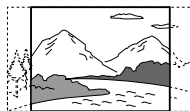

16:9

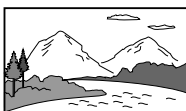

• DVD LINE1 RGB Out

Selects the method of outputting video signals from the LINE-1 (EURO AV) jack on the rear panel of the player.

The default setting is indicated in bold print.

Off	Select this not to output RGB signals.
On	Select this to output RGB signals.

• DVD S-Video Out

Selects whether or not to output S-video signals from the S-VIDEO OUT jack on the rear panel of the player.

The default setting is indicated in bold print.

On	Select this when the player is connected to a TV with S-VIDEO input jack.
Off	Select this when the player is connected to a TV lacking S-VIDEO input jack.

continued

- DVD Component Out

Selects whether or not to output DVD Component Out signals from the DVD Component Out jack on the rear panel of the player.
The default setting is indicated in bold print.

On	Select this to output DVD Component Out signals.
Off	Select this not to output DVD Component Out signals.

Notes

- Playback settings stored in the disc take priority over the “DVD SETUP” menu settings and not all the functions described may work.
- Depending on the DVD VIDEO, “4:3 Letter Box” may be selected automatically instead of “4:3 Pan Scan” or vice versa.
- The connection using S-VIDEO OUT jack is only for the DVD player.
- When you select “On” in the “DVD LINE1 RGB Out” setting, “DVD S-Video Out” and “DVD Component Out” are set to “Off” automatically.
- When you select “On” in the “DVD LINE1 RGB Out” setting, “DVD S-Video Out” and “DVD Component Out” signals will not be output properly.
- When you select “On” in the “DVD S-Video Out” and “DVD Component Out” settings, “DVD LINE1 RGB Out” is set to “Off” automatically.
- When you select “On” in the “Progressive” setting, “DVD LINE1 RGB Out” and “DVD S-Video Out” are set to “Off” automatically.

To set the “Progressive” setting

If your TV accepts progressive (525P/625P) format signals, you will enjoy accurate color reproduction and high quality image.

- 1 Follow step 1 and 2 on page 60, then press **▲/▼** to select “Progressive.”

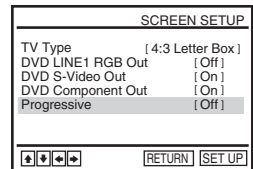

- 2 Press **←/→** to select “On,” then press ENTER.

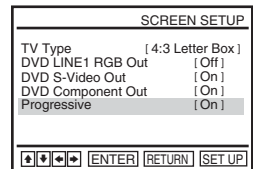

3 Follow the instructions appearing on the screen.

- 1 Ensure your TV is (525P/625P) Progressive Scan capable.
- 2 Connect with Component Video Output jacks (red/green/blue connections). see “Use this hookup if your TV has component video input jacks” on page 56.
- 3 Press **↔** to select [OK] to test your video signal.

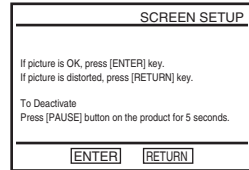
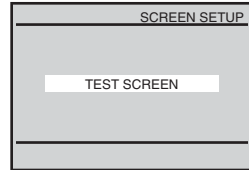
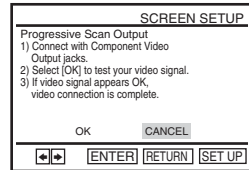

4 If video signal appears OK, video connection is complete. Press ENTER.

The PROGRESSIVE indicator on the unit lights up in orange.

If picture is distorted, press **↶** RETURN.
Check the connection (page 56).

5 Press SET UP to exit the menu.

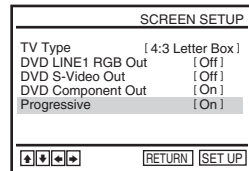

Tip

- The “Progressive” setting can be canceled in stop mode by pressing **||** on the unit continuously for 5 seconds or more, or selecting “Off” in step 2.

Note

- If you select progressive signal when you connect the DVD player to a TV that cannot accept the signal in progressive format, the image quality will deteriorate. In this case, set “Progressive” to “Off.”

Setting the display or sound track language

language **DVD-V**

You can set various languages for the disc's menu, sound track or subtitle.

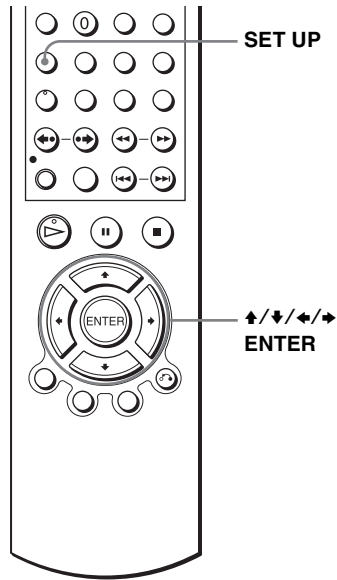

1

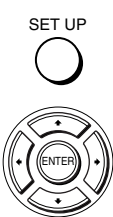

Press SET UP when the DVD player is in stop mode, then press \uparrow/\downarrow to select  (DVD) and press ENTER.



2



Press \uparrow/\downarrow to select "Language Setup," then press ENTER.

The "LANGUAGE SETUP" menu appears.

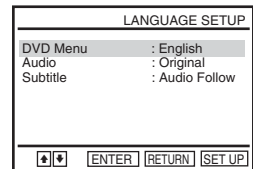

3



Press $\blacktriangle/\blacktriangledown$ to select the language setup item from the displayed list: “DVD Menu,” “Audio,” or “Subtitle.” Then press ENTER.

4



Press $\blacktriangle/\blacktriangledown$ to select the desired language, then press ENTER.

- DVD MENU LANGUAGE
You can select the desired language for the disc’s menu.



- AUDIO LANGUAGE
Switches the language of the sound track. When you select “Original,” the language given priority in the disc is selected.

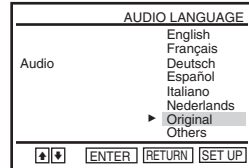

- SUBTITLE LANGUAGE
Switches the language of the subtitle recorded on the DVD VIDEO. When you select “Audio Follow,” the language for the subtitle changes according to the language you selected for the sound track.

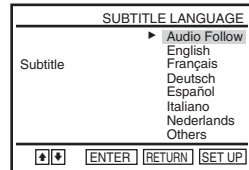

5

SET UP



Press SET UP to exit the menu.

Tip

- If you select “Others” in step 4, an additional language menu appears. Press $\blacktriangle/\blacktriangledown/\blacktriangleleft/\blacktriangleright$ to select the desired language, then press ENTER.



Notes

- When you select a language that is not recorded on the DVD VIDEO in step 4, one of the recorded languages will be automatically selected.
- Playback settings stored in the disc take priority over the DVD SETUP settings and not all the functions described may work.
- If you change the DVD MENU LANGUAGE setting after playing the disc, press \blacktriangle to open and close the disc tray to activate the menu setting, then play the disc again.

Parental Control (limiting playback by children)

DVD-V

Playback of some DVD VIDEOS can be limited according to a predetermined level such as the age of the users. The parental control function allows you to set a playback limitation level.

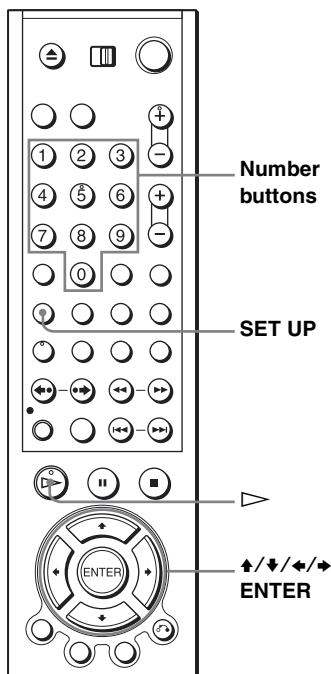

- 1** **SET UP** Press SET UP when the DVD player is in stop mode, then press (DVD) and press ENTER.



- 2** Press to select "Parental Setup," then press ENTER.

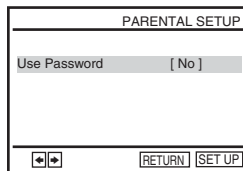

3

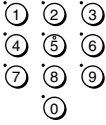

Press **▶** to select “Yes.”

- If you have not entered a password
The display for registering a new password appears.
Enter a 4-digit password using the number buttons.

The display for confirming the password appears.
Re-enter the password.

- When you have already registered a password
The display for entering the password appears.
Enter a 4-digit password using the number buttons.
After registering a password, if you set “Use password” to “No,” “PASSWORD CHECK” screen will not appear.

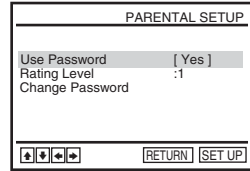
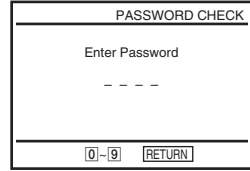
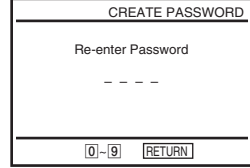
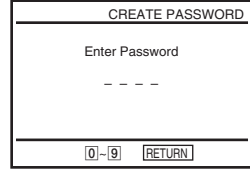

4



Press **▲/▼** to select “Rating Level,” then press **ENTER**.

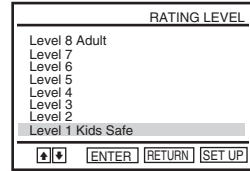

5



Press **▲/▼** to select the level you want, then press **ENTER**.

The options are as follows.

Level 8 (Adult) ↔ Level 7 ↔ Level 6 ↔
Level 5 ↔ Level 4 ↔ Level 3 ↔ Level 2
↔ Level 1 (Kids Safe)

The lower the value, the stricter the limitation.

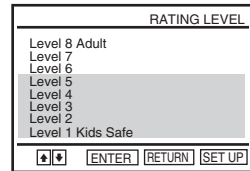

6



Press **SET UP** to exit the menu.

continued

To change the password

- 1** Select “Change Password” in step 4 on page 67.
The display for entering a new password appears.
- 2** Enter a new 4-digit password using the number buttons.
The display for confirming the password appears.
- 3** Re-enter the new password.

To turn off the Parental Control function

Set “Use Password” to “No” in step 3 on page 67.

To play a disc for which Parental Control is set

- 1** Insert the disc, then press \triangleright .
The display for entering your password appears.
- 2** Enter your 4-digit password using the number buttons.
The player starts playback.

If you forget your password

- 1** Turn on the DVD-VCR.
- 2** Remove the disc and close the disc tray.
- 3** Hold down \blacktriangleleft and \blacktriangleright on the front panel simultaneously for 5 seconds.
“Reset OK” appears on the screen.
- 4** Turn off the DVD-VCR.
The password is cleared.
- 5** To create a new password, follow step 3 on page 67.

Notes

- When you play DVD VIDEOS which do not have the Parental Control function, playback cannot be limited on this player.
- All the ratings higher than the level you select will be blocked.
- Write your password down and keep it in a safe place in case you forget it.
- All DVD settings below which you set in the “DVD SETUP” menu will also be cleared when you reset the DVD-VCR to clear the password setting.
 - Language Setup
 - Audio Setup
 - Screen Setup
 - Parental Setup

Using the DVD's menu **DVD-V**

A DVD is divided into long sections of a picture or a music feature called "titles." When you play a DVD VIDEO which contains several titles, you can select the title you want using the TOP MENU button.

When you play DVD VIDEOS that allow you to select items such as the language for the subtitles and the language for the sound, select these items using the MENU button.

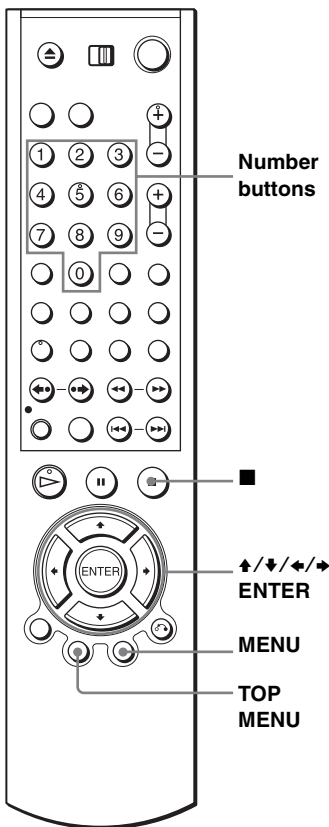

1







- Press TOP MENU or MENU.
The disc's menu appears on the TV screen.
- The contents of the menu vary from disc to disc.

continued

2



Press /// to select the item you want to play or change, then press ENTER.

You can also use the number buttons to select the item.

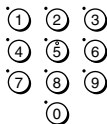

Note

- Depending on the DVD VIDEO, you may not be able to use the TOP MENU button or search a point by setting the time.

Zooming into a scene

DVD-V DVD-RW VCD DATA-CD DATA-DVD





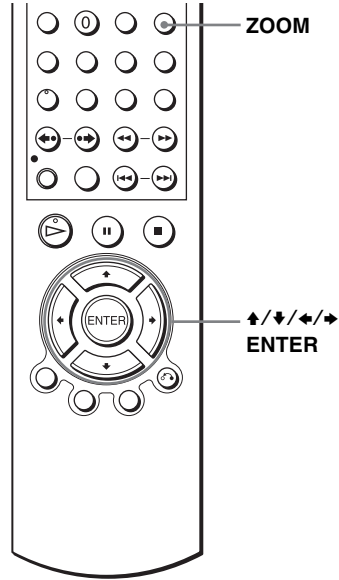

You can zoom into a scene during playback or still mode.

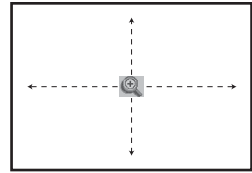
To zoom into a JPEG image, see “Playing JPEG image files” on page 88.



- 1**  Press ZOOM.
“” appears.



- 2**  Press /// to move “” to the position where you want to zoom in.

- 3**  Press ENTER repeatedly to change the magnification.
Each time you press the button, the magnification changes as shown below.
2× → 4× → 2× → normal magnification

Notes

- You cannot use 4× magnification when you play VIDEO CDs.
- The zoom function may not work depending on the DVD.

Changing the angles **DVD-V**

If various angles (multi-angles) for a scene are recorded on the DVD VIDEO, “” appears in the display window. This means that you can change the viewing angle.

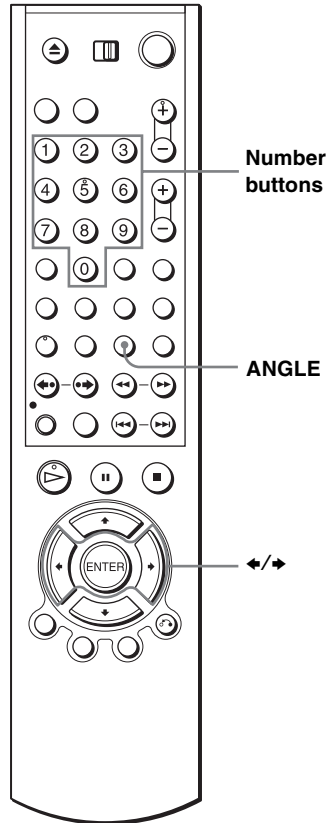

1



Press ANGLE during playback.

The angle number appears on the display.

The number after the slash indicates the total number of angles.

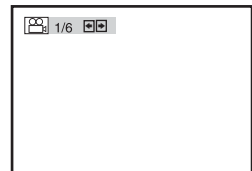

2



Press \leftarrow/\rightarrow repeatedly or use the number buttons to select the angle number.
The scene changes to the selected angle.

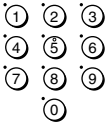

Note

- Depending on the DVD VIDEO, you may not be able to change the angles even if multi-angles are recorded on the DVD VIDEO.

Displaying the subtitle **DVD-V** **DVD-RW**

If subtitles are recorded on the disc, you can change the subtitles or turn them on and off whenever you want while playing a DVD.

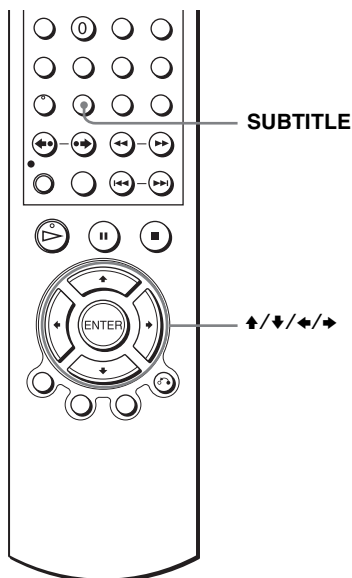

- 1** Press SUBTITLE during playback.

SUBTITLE/
TIMER

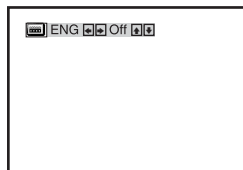

- 2** Press \leftarrow/\rightarrow repeatedly to select the language.



Depending on the DVD, the choice of language varies. Refer to “DVD Audio/Subtitle Language” on page 123 for the abbreviation of the language.

- 3** Press \uparrow/\downarrow repeatedly to select “On.”



To turn off the subtitles

Select “Off” in step 3.

Note

- Depending on the DVD, you may not be able to change the subtitles even if multilingual subtitles are recorded on the DVD. You also may not be able to turn them off.

Various play mode functions (Programme play, Shuffle play, Repeat play)

DVD-V DVD-RW VCD CD DATA-CD DATA-DVD

You can set the following play modes:

- Programme play (page 75), Programme play MP3 audio tracks (page 85)
- Shuffle play (page 77), Shuffle play MP3 audio tracks (page 86)
- Repeat play (page 78)

Note

- The play mode is cancelled when:
 - you open the disc tray
 - the player enters standby mode by pressing I/⏻.

Creating your own programme (Programme play) **CD**

You can play the contents of a disc in the order you want by arranging the order of the tracks on the disc to create your own programme. You can programme up to 20 tracks.

To programme MP3 audio tracks, see page 85.

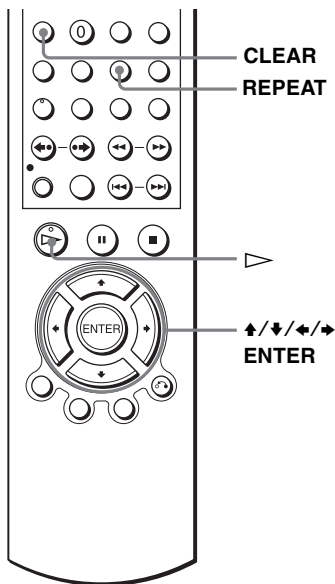

DVD Additional Operations

1



Press REPEAT when the DVD player is in stop mode.

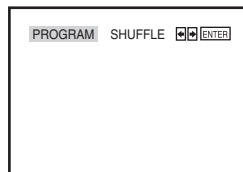

continued

2



Press \leftarrow/\rightarrow to select “PROGRAM,” then press ENTER.

PROGRAM							
Track				Program Order			
01	02	03	04	---	---	---	---
05	06	07	08	---	---	---	---
09	10	11	12	---	---	---	---
13	14	15	16	---	---	---	---
17	18	19	20	---	---	---	---
Clear last track				Clear all tracks			
<div style="display: flex; justify-content: space-between; align-items: center;"> ⏪ ⏩ ⏴ ⏵ ENTER RETURN CLEAR </div>							

3



Press $\uparrow/\downarrow/\leftarrow/\rightarrow$ to select the track number you want to programme, then press ENTER.

PROGRAM							
Track				Program Order			
01	02	03	04	06	---	---	---
05	08	07	08	---	---	---	---
09	10	11	12	---	---	---	---
13	14	15	16	---	---	---	---
17	18	19	20	---	---	---	---
Clear last track				Clear all tracks			
<div style="display: flex; justify-content: space-between; align-items: center;"> ⏪ ⏩ ⏴ ⏵ ENTER RETURN CLEAR </div>							

4

To programme other tracks, repeat step 3.

The programmed track numbers are displayed in the selected order.

5



Press \blacktriangleright to start programme play.

Programme play starts.

When the programme ends, you can restart the same programme again by pressing \blacktriangleright .

To stop programme play

Press CLEAR until “Off” appears at the upper left top of the TV screen during programme play.

To change or cancel a programme

- 1 Follow steps 1 and 2 of “Creating your own programme (Programme play).”
- 2 Press \downarrow repeatedly to select “Clear last track,” then press ENTER. Each time you press the button, the last programmed number is canceled. You can also cancel the last programmed number by pressing CLEAR.
- 3 Follow step 3 for new programming.

To cancel all the programmed numbers

- 1 Follow steps 1 and 2 of “Creating your own programme (Programme play).”
- 2 Press \downarrow repeatedly to select “Clear last track,” then press \rightarrow to select “Clear all tracks” and press ENTER.

All the programmed numbers are canceled.

Notes

- Up to 99 tracks can be displayed.
- Up to 20 tracks can be programmed at one time.

Playing in random order (Shuffle play)

You can shuffle the playback order of tracks. Subsequent “shuffling” may produce a different playing order.

To shuffle MP3 audio tracks, see page 86.

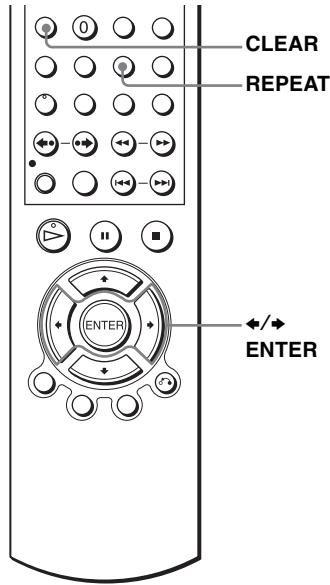

1



Press REPEAT when the DVD player is in stop mode.

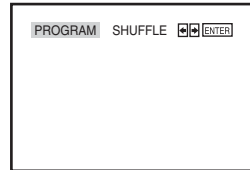

2



Press  to select “SHUFFLE,” then press ENTER.

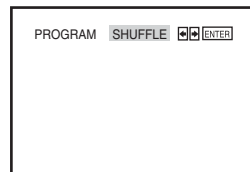

To return to normal play

Press CLEAR until “Off” appears at the upper left top of the TV screen during shuffle play.

Tips

- Shuffle play will stop when all the tracks are played back.
- You cannot repeat play while in shuffle play.

Playing repeatedly (Repeat play) DVD-V DVD-RW VCD CD DATA-CD DATA-DVD

You can play all of the titles or tracks on a disc or a single title, chapter, or track repeatedly.

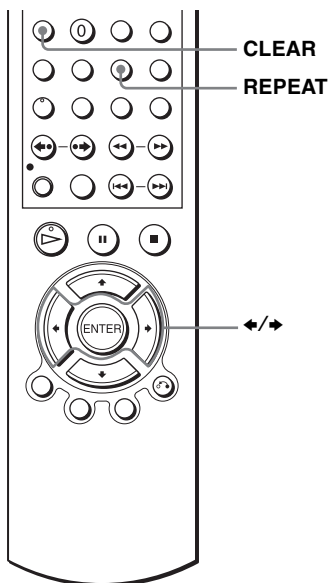

1



Press REPEAT during playback.

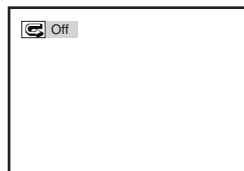

2



Press REPEAT or \leftarrow/\rightarrow to select the item to be repeated.

When playing a DVD

- Chapter: repeats the current chapter.
- Title: repeats the current title on a disc.

When playing a VIDEO CD (with PBC function off) or CD

- Track: repeats the current track.
- Disc: repeats all of the tracks.

When playing a DATA CD/DATA DVD (MP3 audio)

- FILE: repeats the current file (track).
- DIR: repeats the current directory (album).
- DISC: repeats the current disc.

To return to normal play

Select “Off” in step 2 or press CLEAR during repeat play.

Tip

- When you press ■ during repeat play, repeat play is cancelled.

Notes

- You cannot repeat play with DVD-RW in VR mode.
- You cannot repeat play VIDEO CDs with PBC function on. See “Playing VIDEO CDs with “PBC On/Off” functions” on page 92.
- You cannot repeat play while in programme play.

Changing the sound DVD-V DVD-RW VCD CD

When playing a DVD recorded in multiple audio formats (PCM, Dolby Digital, MPEG or DTS), you can change the audio format. If the DVD is recorded with multilingual tracks, you can also change the language.

With CDs or VIDEO CDs, you can select the sound from the right or left channel and listen to the sound of the selected channel through both the right and left speakers. For example, when playing a Karaoke VIDEO CD containing a song with the vocals on the right channel and the instruments on the left channel, you can hear the instruments from both speakers by selecting the left channel.

To enjoy Dolby Digital or DTS effect from a LinearPCM format disc, you have to make the **B-2** connection as shown on page 54.

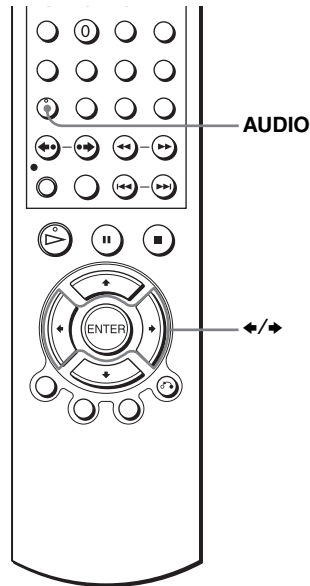

1



Press AUDIO during playback.

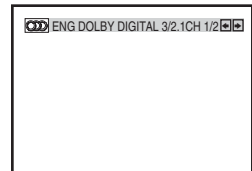

2



Press \leftarrow/\rightarrow repeatedly to select the desired language/audio setting.

- When playing a DVD
Depending on the DVD, the choice of language varies. Refer to “DVD Audio/Subtitle Language” on page 123 for the abbreviation of the language.
- When playing a VIDEO CD or CD
The default setting is indicated in bold print.

STEREO	The standard stereo sound
Left	The sound of the left channel (monaural)
Right	The sound of the right channel (monaural)

Virtual surround setting DVD-V DVD-RW VCD CD

When you connect a stereo TV or 2 front speakers, SURROUND lets you enjoy surround sound effects by using sound imaging to create virtual rear speakers from the sound of the front speakers without using actual rear speakers.

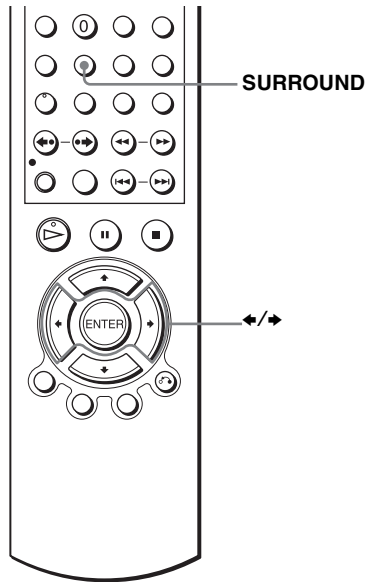

- 1** **SURROUND** Press SURROUND during playback.

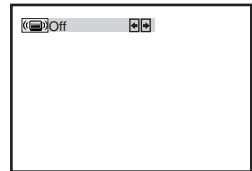

- 2** Press \leftarrow/\rightarrow repeatedly to select "Surround1," "Surround2," "Surround3."
Surround effect increases as shown below.



Surround1

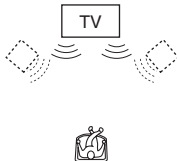

Surround2

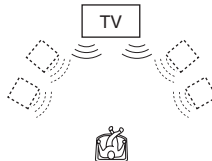

Surround3

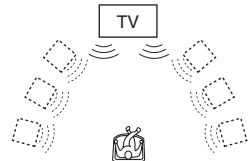

 : Virtual speaker

continued

To cancel the setting

Select “Off” in step 2.

Notes

- When the playing signal does not contain a signal for the rear speakers, the surround effects will be difficult to hear.
- When you activate the surround effect, turn off the surround setting of the connected TV or amplifier (receiver).
- Make sure that your listening position is between and at an equal distance from your speakers, and that the speakers are located in similar surroundings.
- If you use the DIGITAL AUDIO OUT (OPTICAL or COAXIAL) jack and set “Dolby Digital” to “Dolby Digital” or “DTS” to “On” in “AUDIO SETUP” menu, sound will come from your speakers but it will not have the surround effect.
- You cannot perform playback quickly or slowly with sound when a virtual surround effect is set (page 31).

Playing an MP3 audio track **DATA-CD** **DATA-DVD**

You can play back DATA CDs (CD-ROMs/CD-Rs/CD-RWs) or DATA DVDs (DVD-ROMs/DVD+RWs/DVD+Rs/DVD-RWs/DVD-Rs) recorded in MP3 (MPEG1 Audio Layer 3) format.

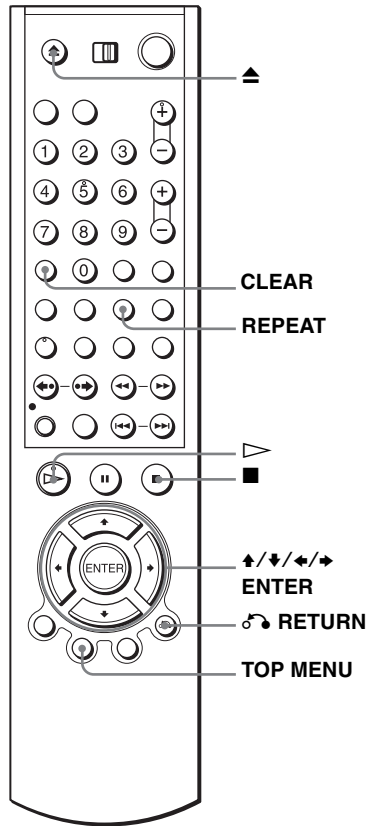

1



Press and place a DATA CD or DATA DVD on the disc tray, then press to close the tray.

When you load a DATA CD or DATA DVD which contains MP3 audio tracks and JPEG image files, “Select a Media Type” menu appears.

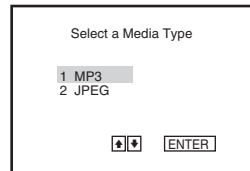

If you load a DATA CD or DATA DVD which contains only MP3 audio files, the MP3 display appears. Then you can skip step 2.

continued

2



Press \uparrow/\downarrow to select “MP3,” then press ENTER.

The first track starts playing. Press \blacksquare if necessary.

Repeat mode
Elapsed playing time

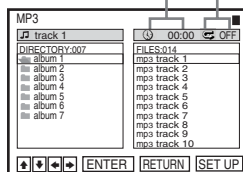

3



RETURN



Press \curvearrowright RETURN, then press \uparrow/\downarrow to select the desired directory in the left column, then press ENTER.

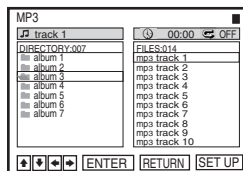

4



Press \uparrow/\downarrow to select the desired track in the right column, then press ENTER.

The selected track starts playing.

When a track or album is being played, the title is shown in a box. The playing track number appears on the display window.

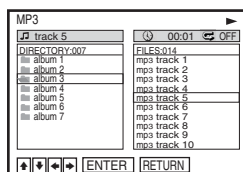

To stop play

Press \blacksquare .

To repeat play

Press REPEAT repeatedly during playback to change the repeat mode.

- FILE: repeats the current file (track).
- DIR: repeats the current directory (album).
- DISC: repeats the current disc.

To go to the next or previous page

Press \rightarrow or \leftarrow .

To return to the previous display

Press \curvearrowleft RETURN.

To return to the “Select a Media Type” menu

Press \blacksquare twice, then press TOP MENU.

To turn off the display

Press \blacksquare twice, then press \curvearrowleft RETURN repeatedly.

Notes

- Only the letters in the alphabet and numbers can be used for album or track names. Anything else is displayed as an asterisk.
- Up to 12 alphanumeric characters can be displayed for album or track names.
- ID3 tags cannot be displayed.

To programme MP3 audio tracks

1 Press **■** twice, then press REPEAT.

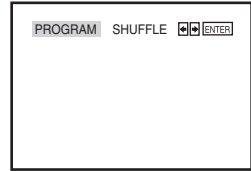

2 Press **←/→** to select “PROGRAM,” then press ENTER.

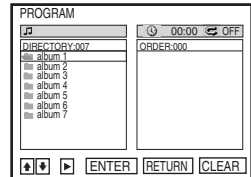

3 Press **↑/↓** to select the desired directory in the left column, then press ENTER.

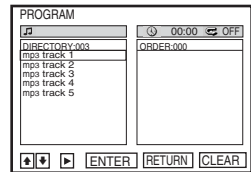

4 Press **↑/↓** to select the track you want to programme, then press ENTER.

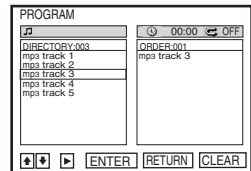

5 To programme other tracks, repeat step 4.

The programmed tracks are displayed in the selected order. Press CLEAR to cancel the last programmed track.

6 Press **▷** to start programme play.

Programme play starts. When the programme ends, you can restart the same programme again by pressing **▷**.

To stop programme play

Press **■** during programme play.

Note

- Up to 20 tracks can be programmed at one time.

continued

To return to normal play

Press CLEAR during programme play.

Tip

- You cannot repeat play while in programme play.

To shuffle MP3 audio tracks

1 Press ■ twice, then press REPEAT.

2 Press ◀/▶ to select “SHUFFLE,” then press ENTER.

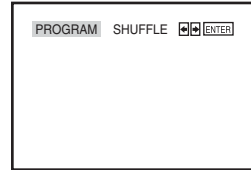

To return to normal play

Press CLEAR during shuffle play.

Tips

- Shuffle play will stop when all the tracks are played back.
- You cannot repeat play while in shuffle play.

About MP3 audio tracks

You can play back DATA CDs (CD-ROMs/CD-Rs/CD-RWs) or DATA DVDs (DVD-ROMs/DVD+RWs/DVD+Rs/DVD-RWs/DVD-Rs) recorded in MP3 (MPEG-1 Audio Layer III) format. However, the discs must be recorded according to ISO9660 Level 1/Level 2 or Joliet format and DATA DVDs of Universal Disk Format (UDF) for the player to recognize the tracks (or files). You can also play DATA CDs or DATA DVDs recorded in Multi Session or Multi Border (see “Note on Multi Session/Border discs” on page 86).

Refer to the instructions supplied with the CD-R/CD-RW/DVD-R/DVD-RW drives and the recording software (not supplied) for details on the recording format.

Note on Multi Session/Border discs

If MP3 audio tracks are recorded in the first session/border, the player will also play MP3 audio tracks in other session/border. If audio tracks and images in Music CD format or Video CD format are recorded in the first session/border, only the first session/border will be played back.

Notes

- If you put the extension “.MP3” to data not in MP3 format, the player cannot recognize the data properly and will generate a loud noise which could damage your speaker system.
- The player cannot play audio tracks in MP3PRO format.
- The player may not be able to play some DATA CDs/DATA DVDs created in the Packet Write format.
- If both video data and MP3 audio tracks exist on a DATA DVD, the player recognizes only the video data.
- This player supports MP3 audio tracks recorded with a bit rate of 128 kbps and a sampling frequency of 44.1 kHz. Attempting to play MP3 audio tracks recorded with different specifications may result in loud noise, sound skipping or speaker damage.
- Depending on the disc, playback may take some time to start.

The Playback order of MP3 audio tracks

The playback order of albums and tracks recorded on a DATA CD or DATA DVD is as follows.

- Structure of disc contents

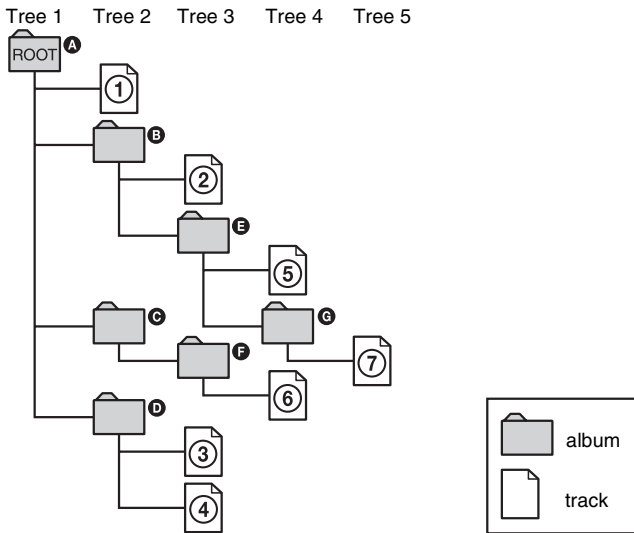

When you insert a DATA CD or DATA DVD and press \triangleright , the numbered tracks are played sequentially, from ① through ⑦. Any sub-albums/tracks contained within a currently selected album does not take priority over the next album in the same tree. (Example: **E** contains **G** but **6** is played before **7**.)

When you press σ RETURN and the list of MP3 albums appears (page 84), the albums are arranged in the following order: **A** → **B** → **D** → **E** → **F** → **G**. Albums that do not contain tracks (such as album **C**) do not appear in the list.

Tips

- If you add numbers (01, 02, 03, etc.) to the front of the track file names, the tracks will be played in that order.
- A disc with many trees takes longer to start playback. Some discs with many trees cannot be played back.

Notes

- Depending on the software you use to create the DATA CD or DATADVD, the playback order may differ from the illustration above.
- The playback order above may not be applicable if there are more than a total of 1000 albums and tracks in the DATA CD or DATA DVD.
- A total of up to 999 files can be recognized for discs that contain both MP3 and JPEG files. Files are recognized in the order that they were recorded. For example, if 990 JPEG files are recorded then 100 MP3 files are recorded, the 990 JPEG files recorded first and only the first 9 MP3 files can be recognized.
- Depending on the disc contents, playback may take some time to start.

Playing JPEG image files DATA-CD DATA-DVD

You can play JPEG image files on DATA CDs (CD-ROMs/CD-Rs/CD-RWs) or DATA DVDs (DVD-ROMs/DVD+RWs/DVD+Rs/DVD-RWs/DVD-Rs).

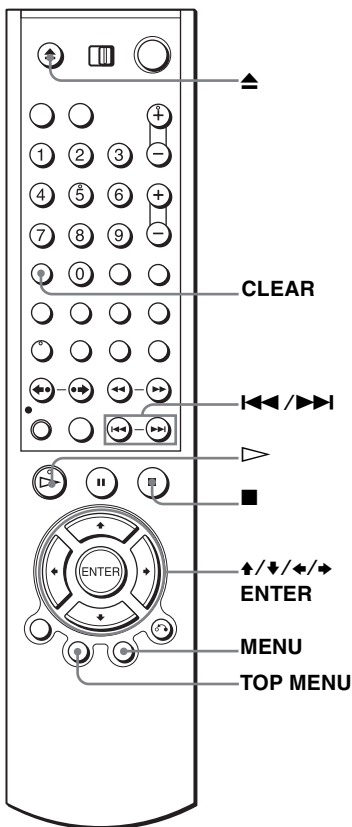

1



Press ▲ and place a DATA CD or DATA DVD on the disc tray, then press ▲ to close the tray.

When you load a DATA CD or DATA DVD which contains MP3 audio tracks and JPEG image files, “Select a Media Type” menu appears.

If you load a DATA CD or DATA DVD which contains only JPEG image files, the “Album” display appears. Then you can skip step 2.

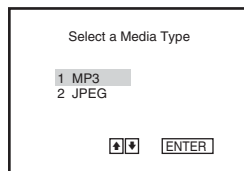

2



Press \uparrow/\downarrow to select “JPEG,” then press ENTER.

The “Album” display will appear.

If you do not press ENTER after selecting a media type, the selected media will be automatically played.

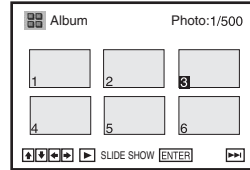

3



Press \leftarrow/\rightarrow to select the next/previous album page, then press $\uparrow/\downarrow/\leftarrow/\rightarrow$ to select an image in the “Album” display.



To display the selected image

1 Press ENTER.

The selected image number appears in the display window.

2 To display the next/previous image, press \leftarrow/\rightarrow .

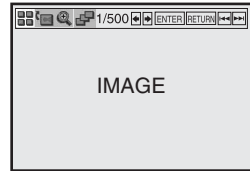

To play the Slide show

1 Press \triangleright .

You can also play the Slide show using the menu on the selected image. For details, see “To enjoy the Slide show” on page 90.

2 Press \leftarrow/\rightarrow to select the desired playing speed on the “Interval” menu, then press ENTER. Slide show starts from the selected image.

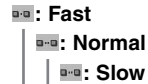

To rotate the selected image

1 Press $\uparrow/\downarrow/\leftarrow/\rightarrow$ to select an image in the “Album” display, then press ENTER.

2 Press \leftarrow/\rightarrow to select “,” then press ENTER. Each time you press ENTER, the image turns clockwise by 90°.

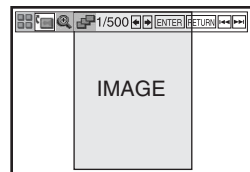

continued

To zoom in an image

- 1 Press **↑/↓/←/→** to select an image in the “Album” display, then press ENTER.
- 2 Press **←/→** to select “**ⓐ**,” then press ENTER. “**ⓐ**” appears.
- 3 Press **↑/↓/←/→** to move “**ⓐ**” to the position where you want to zoom in.
- 4 Press ENTER repeatedly to change the magnification. Each time you press ENTER, the magnification changes as shown below.
2× → normal magnification

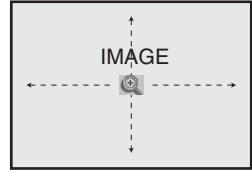

Note

- You cannot use ZOOM on the remote in JPEG image files on DATA CD/DATA DVD.

To enjoy the Slide show

- 1 Press **↑/↓/←/→** to select an image in the “Album” display, then press ENTER.
- 2 Press **←/→** to select “**ⓐ**,” then press ENTER. The “Interval” menu appears.
- 3 Press **←/→** to select the desired playing speed, then press ENTER. Slide show starts.



To turn on/off the menu in the single image display

Press CLEAR to turn off the menu. Press **←** or **→** to turn on the menu.

To return to the “Album” display

Press MENU to return to the “Album” display. Press **⏪** repeatedly to return to the first “Album” page.

To return to the “Select a Media Type” menu

Press **■** twice, then press TOP MENU.

Notes

- Slide show can play in only one direction.
- You cannot rotate or zoom in the image during Slide show.
- If you select “**ⓐ**” in the rotated image display, the images in the “Album” display will not be rotated. But if you start the slide show, the images will be rotated. Correct the rotation in the “**ⓐ**” menu.

About JPEG image files

You can play back DATA CDs (CD-ROMs/CD-Rs/CD-RWs) or DATA DVDs (DVD-ROMs/DVD+RWs/DVD+Rs/DVD-RWs/DVD-Rs) recorded in JPEG format.

However, the discs must be recorded according to ISO9660 Level 1/Level 2 or Joliet format and DATA DVDs of Universal Disk Format (UDF) for the player to recognize the tracks (or files). You can also play DATA CDs or DATA DVDs recorded in Multi Session or Multi Border (see “Note on Multi Session/Border discs” on page 91).

Refer to the instructions supplied with the CD-R/CD-RW/DVD-R/DVD-RW drives and the recording software (not supplied) for details on the recording format.

Notes

- If both video data and JPEG image files exist on a DATA DVD, the player recognizes only the video data.
- A total of up to 999 files can be recognized for discs that contain both MP3 and JPEG files. Files are recognized in the order that they were recorded. For example, if 990 JPEG files are recorded then 100 MP3 files are recorded, the 990 JPEG files recorded first and only the first 9 MP3 files can be recognized.

Note on Multi Session/Border discs

If JPEG image files are recorded in the first session/border, the player will also play JPEG image files in other session/border. If audio tracks and images in Music CD format or Video CD format are recorded in the first session/border, only the first session/border will be played back.

Tip

- If you add numbers (01, 02, 03, etc.) to the front of the file names, the files will be played in that order.

Notes

- This player can play JPEG image files with the extension “.JPEG” or “.JPG.”
- Some DATA CDs or DATA DVDs cannot be played on this system depending on file format.
- The player may not be able to play some DATA CDs/DATA DVDs created in the Packet Write format.
- If you add the extension “.JPG” or “.JPEG” to data not in JPEG format, “Can not Display” will appear.
- Depending on the disc or the size of image files, playback may take some time to start.
- Progressive and lossless compression JPEG image files are not supported.
- The image size that can be displayed is limited. You can display the following images; width 32 - 7680 pixels by height 32 - 8192 pixels.

2

Press \blacktriangle / \blacktriangledown to select the item number you want.

You can also use the number buttons to select the item number and track.

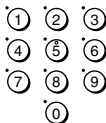

3

Press ENTER.

4

Follow the instructions in the menu for interactive operations.

Refer to the instructions supplied with the disc, as the operating procedure may differ depending on the VIDEO CD.

To return to the menu

Press \curvearrowright RETURN.

To play using “PBC Off”

Press MENU to select “PBC Off.”

When “PBC Off” is selected, the DVD player starts continuous play. You cannot play still pictures such as a menu.

To return to “PBC On,” press MENU to select “PBC On.”

Tip

- Depending on the VIDEO CD, “Press ENTER” in step 3 may appear as “Press SELECT” in the instructions supplied with the disc. In this case, press \blacktriangleright .

Quick Timer Recording **VHS**

After you have started recording, you can have the VCR stop recording automatically after a specified duration.

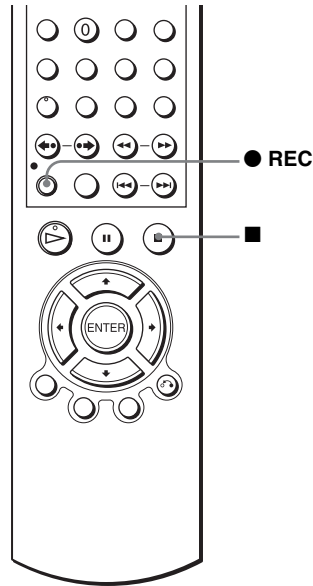

- 1** ●REC While recording, press ●REC.



- 2** ●REC Press ●REC repeatedly to set the duration time.
In SP mode

Each press advances the time in increments of 30 minutes.

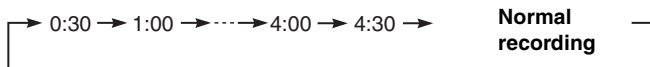

In LP mode

Each press advances the time as shown below.

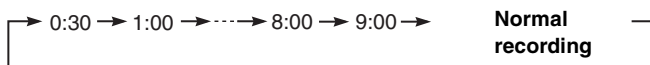

The tape counter decreases minute by minute to 0:00, then the VCR stops recording.

To extend the duration

Press ● REC repeatedly to set a new duration time.

To cancel the duration

Press ● REC repeatedly until the ⊖ indicator disappears and the VCR returns to normal recording mode.

To stop while recording

Press ■.

Notes

- You cannot display the current tape time in the display window when setting the recording duration time.
- During DVD playback, DVD-VCR does not standby even if the VCR stops recording.

Recording stereo and bilingual programmes **VHS**

In the NICAM system

This VCR receives and records stereo and bilingual programmes based on the NICAM system (NICAM appears on the TV screen). When a stereo or bilingual programme is received, the STEREO indicator appears in the display window.

To record a NICAM programme, “NICAM” in the “USER SET” menu should be set to “On” (initial setting). To check the menu setting, see page 107 for details.

To select the sound while recording

Press AUDIO to select the sound you want.

Stereo programmes

To listen to	On-screen display	Display window
Stereo	NICAM, STEREO	STEREO
Left channel	NICAM, LCH	STEREO
Right channel	NICAM, RCH	STEREO
Left and right channels*	NICAM, LCH + RCH	STEREO

* Usually the mixed sound of left and right channels

Bilingual programmes

To listen to	On-screen display	Display window
Main	NICAM, MAIN	STEREO
Sub	NICAM, SUB	STEREO
Main and sub	NICAM, MAIN/SUB	STEREO
Standard sound*	NICAM, MONO	STEREO

* Usually the main sound (monaural)

Selecting the sound during Hi-Fi playback

Press AUDIO to select the sound you want.

To listen to	On-screen display	Display window
Stereo	STEREO	STEREO
Left channel	LCH	STEREO
Right channel	RCH	STEREO
Mix sound*	MIX	STEREO
Mono sound	MONO	No indicator

* The mixed sound of left and right channels, and the normal mono audio track

How sound is recorded on a video tape

The VCR records sound onto two separate tracks. Hi-fi audio is recorded onto the main track along with the picture. Monaural sound is recorded onto the normal audio track along the edge of the tape.

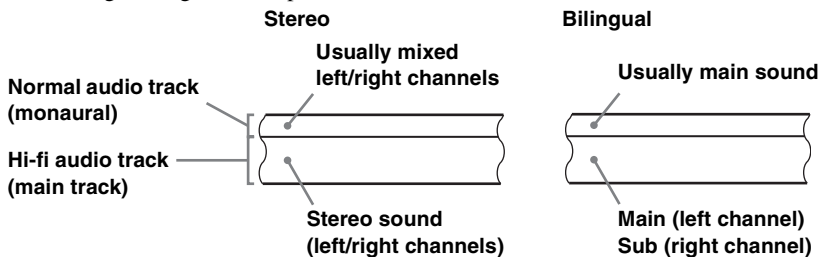

Notes

- To listen to playback sounds in stereo, you must use the Scart or AUDIO OUT connections.
- When you play a tape recorded in monaural, the sound is heard in monaural regardless of the AUDIO setting.

Searching using index function **VHS**

The VCR automatically marks the tape with an index signal at the point where each recording begins. Use these signals as references to find a specific recording.

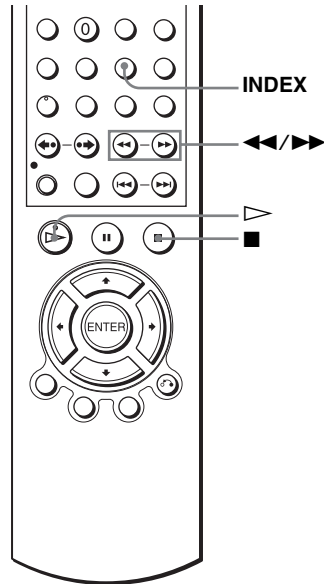

To find a specific recording by scanning (Index scan)

1 Insert an indexed tape into the tape compartment.

2 Press REPEAT/INDEX, then press ◀◀/▶▶. The VCR starts scanning each recording for five seconds in the corresponding direction.



3 Press ▷ to start playback when you find the desired point.



To search a specific recording (Index search)

1 Insert an indexed tape into the VCR.

2 Press INDEX, then press ◀◀/▶▶ twice.

REPEAT/
INDEX



- To search ahead, press ▶▶ twice.
- To search backwards, press ◀◀ twice.



3 Press ◀◀/▶▶ depending on the direction where your desired programme is located.



Each time you press the button, the number increases or decreases up to ±20, respectively.



4 The VCR starts searching, and playback starts automatically from that point.

To stop searching

Press ■.

Note

- No index signal will be added when recording starts from recording pause. However, an index signal will be marked if you change the programme position during recording pause.

Adjusting the picture (tracking) **VHS**

Adjusting the tracking

Although the VCR automatically adjusts the tracking when playing a tape, distortion may occur if the recording is in poor condition. In this case, manually adjust the tracking.

During playback, press TRACKING +/- to display the tracking meter. The distortion should disappear as you press one of the two buttons. To resume automatic tracking adjustments, eject the tape and re-insert it.

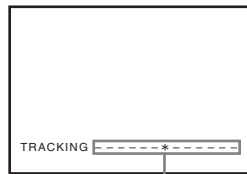

Tracking meter

Adjusting the picture sharpness (Smart trilogic)

You can automatically adjust the sharpness of the picture.

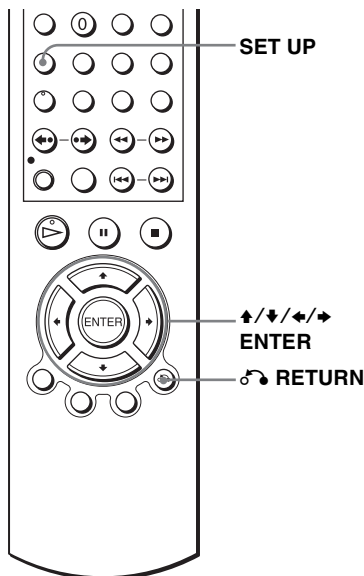

- 1 **SET UP** During playback, press SET UP, then press **↑/↓** to select **OPTION** and press ENTER.

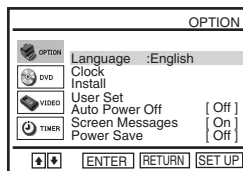

2



Press \uparrow/\downarrow to select “User Set,” then press ENTER.

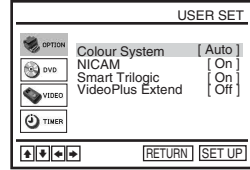

3



Press \uparrow/\downarrow to select “Smart Trilogic,” then press \rightarrow .

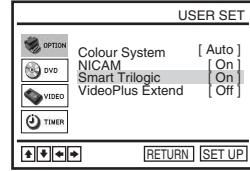

4



Press \uparrow/\downarrow to set “SMART TRILOGIC” to “ON” or “OFF.”

- ON: Picture sharpness is automatically adjusted.
- OFF: Adjust the picture sharpness manually.

To soften the picture, press \leftarrow .

To sharpen the picture, press \rightarrow .

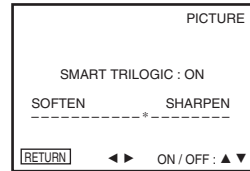

5



RETURN

Press \circlearrowleft RETURN to return to the original screen.

Changing menu options **VHS**

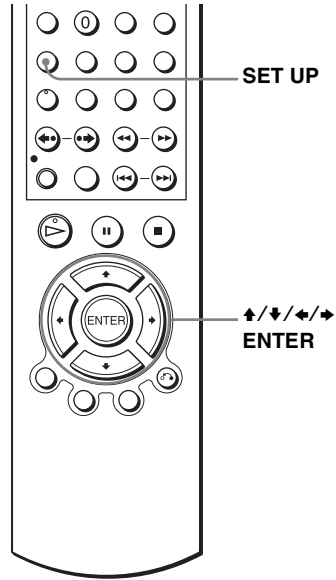

- 1** Press SET UP when the DVD player is in stop mode, then press (OPTION) or (VIDEO) and press ENTER.

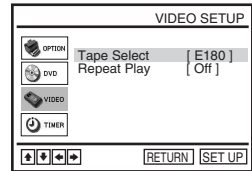
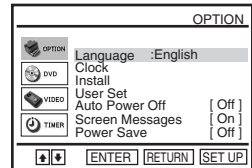
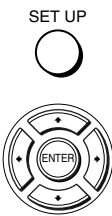

- 2** Press / to select the option to change.



3

Press ◀/▶ to change the setting.

4

SET UP



Press SET UP to exit the menu.

Menu choices

The default settings are indicated in bold print.

OPTION

Menu option	Set this option to
Auto Power Off	<ul style="list-style-type: none"> • “Off” to deactivate the Auto Power Off function. • “1Hour”/“2Hours”/“3Hours” to turn the DVD-VCR off automatically if no signal is received and you do not press any of the buttons during this time.
Screen Messages	<ul style="list-style-type: none"> • “On” to display the menu on the TV screen. • “Off” to disappear the menu from the TV screen.
Power Save	<ul style="list-style-type: none"> • “On” to turn off the indicators in the display window during standby mode to reduce the DVD-VCR’s power consumption to a minimum. • “Off” to turn on the indicators in the display window while the DVD-VCR is standing by.

VIDEO SETUP

Menu option	Set this option to
Tape Select	<ul style="list-style-type: none"> • “E180” to use an E-180 or shorter type tape. • “E240” to use an E-240 type tape. • “E260” to use an E-260 type tape. • “E300” to use an E-300 type tape.
Repeat Play	<ul style="list-style-type: none"> • “On” to play back a tape repeatedly. The VCR rewinds a tape to the beginning and restarts playback automatically. • “Off” to turn off Auto repeat.

Notes

- When the VCR stands by for recording, the ⊖ indicator in the display window remains lit even when “Power Save” is set to “On.”
- The Line Through function will not operate properly if “Power Save” in “OPTION” menu is set to “On.” Set “Power Save” to “Off” to ensure proper operation.

Editing **VHS**

How to connect to record on this VCR

Connect the line outputs of the other VCR to the input connector of this VCR. Refer to the examples A through C and choose the connection that best suits your VCR.

Example A

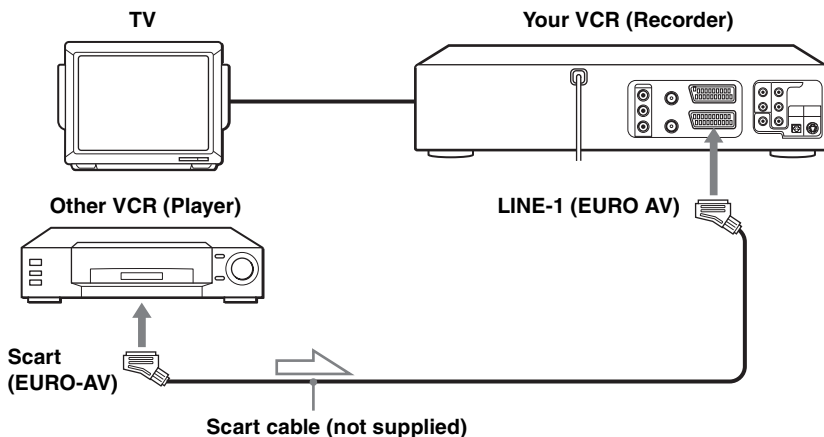

 : Signal flow

Example B

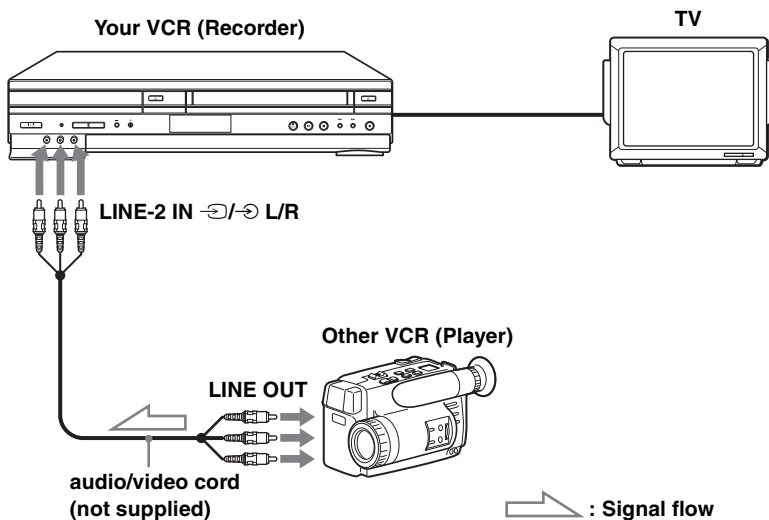

 : Signal flow

Example C

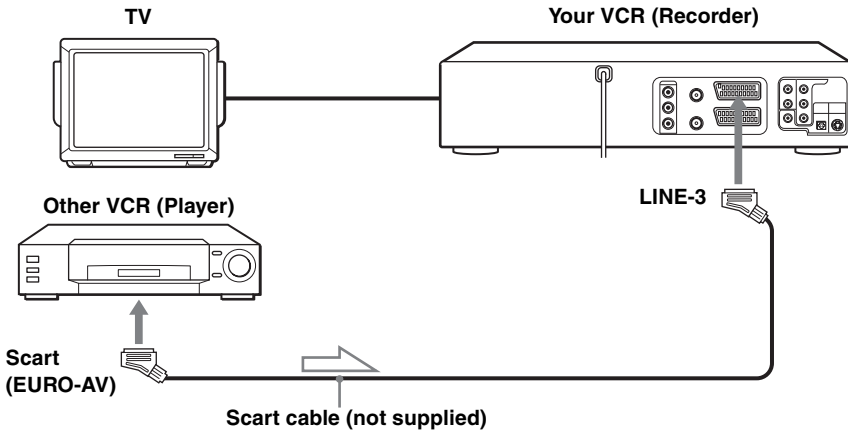

How to connect to a stereo system

Connect the LINE-2 IN \curvearrowright / \curvearrowleft L/R jacks on this DVD-VCR to the audio output jacks on the stereo system, using an audio cord (not supplied).

Notes

- Make sure you connect the plugs to jacks of the same colour.
- If the other VCR is a monaural type, leave the red plugs unconnected.
- If you connect this VCR to both the LINE IN and LINE OUT jacks of the other VCR, select the input correctly to prevent a humming noise.
- When you connect another VCR to the LINE-3 or LINE-2 connector, press INPUT SELECT to display "L3" or "L2" in the display window.

Operation (when recording on this VCR)

Before you start editing

- Turn on your TV and set it to the video channel.
- Press INPUT SELECT to display the connected line in the display window.
- Press SELECT VIDEO to control the VCR.
- Press SP/LP to select the tape speed, SP or LP.

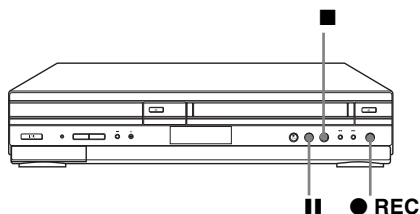

-
- 1** Insert a source tape with its safety tab removed into the other (playback) VCR. Search for the point to start playback and set it to playback pause.

 - 2**  Insert a tape with its safety tab in place into this (recording) VCR. Search for the point to start recording and press **||** to set it to playback pause.

 - 3**  Press **● REC** on this VCR to set it to recording pause.

 - 4**  To start editing, press the **||** (pause) buttons on both VCRs at the same time.
-

To stop editing

Press the **■** (stop) buttons on both VCRs.

Tip

- To cut out unwanted scenes while editing, press **||** on this VCR when an unwanted scene begins. When it ends, press **||** again to resume recording.

General setup information

Changing setup options

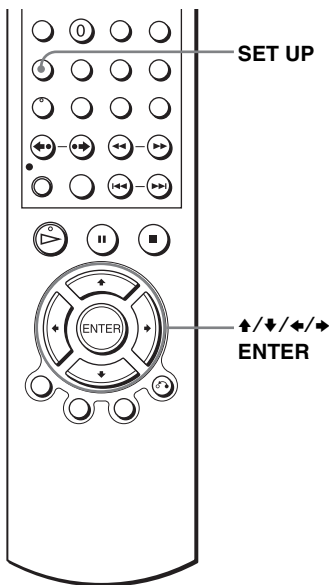

- 1** Press SET UP when the DVD player is in stop mode, then press \uparrow/\downarrow to select (OPTION) and press ENTER.

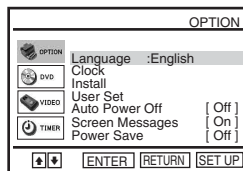
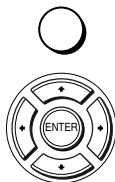

- 2** Press \uparrow/\downarrow to select “User Set,” then press ENTER.
The “USER SET” menu appears.

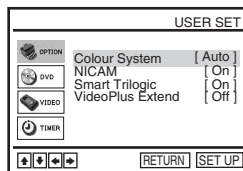

- 3** Press \uparrow/\downarrow to select the option to change.



continued

4

Press \leftarrow/\rightarrow to change the setting.

When changing the “RF Output Channel,” confirmation messages will appear. Press ENTER to confirm the messages.

5

SET UP



Press SET UP to exit the menu.

Menu choices

Initial settings are indicated in bold print.

Menu option	Set this option to
Colour System	<ul style="list-style-type: none">• “Auto” to select the colour system automatically.• “PAL” to use the tape recorded in the PAL colour system.• “B/W” to use the tape recorded in black and white. <p>When using the tape recorded NTSC colour signals:</p> <ul style="list-style-type: none">• “NTPB” to play back an NTSC-recorded tape on PAL TV.• “NTSC4.43” to play back an NTSC-recorded tape on Multi TV.
NICAM	<ul style="list-style-type: none">• “On” to record NICAM broadcasts on the hi-fi audio track.• “Off” to record standard sound on the hi-fi audio track. <p>For details, see page 96.</p>
Smart Trilogic	<ul style="list-style-type: none">• “On” to automatically adjust the sharpness of the picture.• “Off” to manually adjust the sharpness of the picture.
VideoPlus Extend	<ul style="list-style-type: none">• “Off” to deactivate the VideoPlus Extend function.• 10/20/30/.../60 (minutes) to extend the time of the VideoPlus setting by the selected amount of time.

Troubleshooting

If you have any questions or problems not covered below, please consult your nearest Sony service facility.

General Troubleshooting

	Symptom	Remedy
Power	The I/⏻ (on/standby) switch does not function.	<ul style="list-style-type: none">• Connect the mains lead to the mains securely.
	The power is turned on but the DVD-VCR does not operate.	<ul style="list-style-type: none">• Moisture condensation has occurred. Turn the power off, unplug the mains lead and leave the DVD-VCR to dry for over three hours.
Clock	The clock has stopped and "--:--" appears in the display window.	<ul style="list-style-type: none">• The clock stops if the DVD-VCR is disconnected from the mains. Reset the clock (and timer).
Others	The remote commander does not function.	<ul style="list-style-type: none">• Make sure you are pointing the remote commander at the remote sensor on the DVD-VCR.• Replace all the batteries in the remote commander with new ones if they are weak.• Make sure the TV / DVD·VIDEO switch is set correctly.• Select correctly VIDEO or DVD with the SELECT DVD/VIDEO button.
	The tracking meter does not appear on the screen.	<ul style="list-style-type: none">• The recording condition of the tape is very poor and tracking cannot be adjusted.
	You cannot control other TVs.	<ul style="list-style-type: none">• Set your TV's code number. The code number may change when you replace the batteries of the remote commander.

DVD Troubleshooting

	Symptom	Remedy
Picture	There is no picture/picture noise appears.	<ul style="list-style-type: none"> • Re-connect the connecting cord securely. • The connecting cords are damaged. • Check the connection to your TV (page 12) and switch the input selector on your TV so that the signal from the player appears on the TV screen. • The disc is dirty or flawed. • If the picture output from your player goes through your VCR to get to your TV or if you are connected to a combination TV/VIDEO player, the copy-protection signal applied to some DVD programmes could affect picture quality. If you still experience problems even when you connect your player directly to your TV, please try connecting your player to your TV's S-VIDEO input (page 55). • You have set the player to progressive format (the PROGRESSIVE indicator lights up in orange) even though your TV cannot accept the progressive signal. In this case, set "Progressive" to "Off" (page 62). • Even if your TV is compatible with progressive format (480p) signals, the image may be affected when you set the player to progressive format. In this case, set "Progressive" to "Off" and the player is set to normal (interlace) format (page 62). • COMPONENT VIDEO OUT jack is not used or "Progressive" of the "SCREEN SETUP" menu is not set correctly while the PROGRESSIVE indicator lights up in orange. Check the setting (page 60) and connection (page 56).
	Even though you set the aspect ratio in "TV Type" of the "SCREEN SETUP" menu the picture does not fill the screen.	<ul style="list-style-type: none"> • The aspect ratio of the disc is fixed on your DVD.
	There is no picture from your VCR connected to the LINE IN jacks.	<ul style="list-style-type: none"> • The DVD player must be in standby mode to view pictures from your VCR.
Sound	There is no sound.	<ul style="list-style-type: none"> • Re-connect the connecting cord securely. • The connecting cord is damaged. • The player is connected to the wrong input jack on the amplifier (receiver) (page 53). • The amplifier (receiver) input is not correctly set. • The player is in pause mode or in Slow-motion Play mode. • The player is in fast forward or fast reverse mode. • If the audio signal does not come through the DIGITAL AUDIO OUT (OPTICAL or COAXIAL) jack, check the audio settings (page 57).
	Sound is noisy.	<ul style="list-style-type: none"> • When playing a CD with DTS sound tracks, noise will come from the OUT AUDIO L/R jacks (page 32) or DIGITAL OUT (OPTICAL or COAXIAL) jack.

	Symptom	Remedy
Sound	The sound volume is low.	<ul style="list-style-type: none"> The sound volume is low on some DVDs. The sound volume may improve if you set "Audio DRC" to "Wide Range" (page 59).
	The disc does not play.	<ul style="list-style-type: none"> The disc is turned over. Insert the disc with the playback side facing down on the disc tray. The disc is skewed. The player cannot play certain discs (page 7). The region code on the DVD does not match the player. Moisture has condensed inside the player. The player cannot play a recorded disc that is not correctly finalized (page 7). Make sure the TV / DVD-VIDEO switch is set correctly. Select correctly VIDEO or DVD with SELECT DVD/ VIDEO button.
Operation	The MP3 audio track cannot be played (page 83).	<ul style="list-style-type: none"> The DATA CD or DATA DVD is not recorded in the MP3 format that conforms to ISO9660 Level 1/Level 2 or UDF. The MP3 audio track does not have the extension ".MP3." The data is not formatted in MP3 even though it has the extension ".MP3." The data is not MPEG1 Audio Layer 3 data. The player cannot play audio tracks in MP3PRO format.
	The JPEG image file cannot be played.	<ul style="list-style-type: none"> The DATA CD or DATA DVD is not recorded in JPEG format that conforms to ISO9660 Level 1/Level 2 or UDF. The JPEG image file does not have the extension ".JPG" or ".JPEG." The data is not formatted in JPEG even though it has the extension ".JPG" or ".JPEG." Length or width of the image is more than 4720 dots.
	The title of the MP3 audio album/ track or JPEG image album/file is not correctly displayed.	<ul style="list-style-type: none"> The player can only display numbers and alphabet. Other characters are displayed as asterisks.
	The disc does not start playing from the beginning.	<ul style="list-style-type: none"> Programme play, shuffle play, or repeat play, has been selected (pages 75, 77, 78). Resume play has taken effect (page 31).
	The player starts playing the disc automatically.	<ul style="list-style-type: none"> The disc features an auto playback function.
	Playback stops automatically.	<ul style="list-style-type: none"> While playing discs with an auto pause signal, the player stops playback at the auto pause signal.
	You cannot perform some functions such as stop, search, slow-motion play, repeat play, shuffle play, or programme play.	<ul style="list-style-type: none"> Depending on the disc, you may not be able to do some operations. See the operating manual that comes with the disc.

	Symptom	Remedy
Operation	The language for the sound track cannot be changed.	<ul style="list-style-type: none"> • Try using the DVD's menu instead of the direct selection button on the remote (page 69). • Multilingual tracks are not recorded on the DVD being played. • The DVD prohibits the changing of the language for the sound track.
	The subtitle language cannot be changed or turned off.	<ul style="list-style-type: none"> • Try using the DVD's menu instead of the direct selection button on the remote (page 69). • Multilingual subtitles are not recorded on the DVD being played. • The DVD prohibits the changing of the subtitles.
	The angles cannot be changed.	<ul style="list-style-type: none"> • Try using the DVD's menu instead of the direct selection button on the remote (page 69). • Multi-angles are not recorded on the DVD being played. • The DVD prohibits changing of the angles.
	The player does not operate properly.	<ul style="list-style-type: none"> • When static electricity, etc., causes the player to operate abnormally, unplug the player.

VCR Troubleshooting

	Symptom	Remedy
Playback	The playback picture does not appear on the TV screen.	<ul style="list-style-type: none"> Make sure the TV is set to the channel for the VCR. If you are using a monitor, set it to video input. If the VCR is connected to the TV with the Scart cable, make sure the VIDEO indicator is lit in the display window. Use the TV/VIDEO button on the remote commander to light up the VIDEO indicator.
	The picture is not clear.	<ul style="list-style-type: none"> Existing broadcasts may interfere with the VCR. Reset the RF channel output of your VCR (page 16). Adjust the tracking with the TRACKING +/- buttons. The video heads are dirty (see the last page of Troubleshooting). Clean the video heads using a Sony video head cleaning cassette. If a Sony cleaning cassette is not available in your area, have the heads cleaned at your nearest Sony service facility (a standard service charge will be required). Do not use a commercially available liquid type cleaning cassette other than Sony's, as it may damage the video heads. The video heads may have to be replaced. Consult your local Sony service facility for more information.
	The picture has no colour.	<ul style="list-style-type: none"> The "Colour System" option in the "USER SET" menu is set to the wrong position. Set the option to conform to the system that the tape was recorded in.
	The picture rolls vertically during picture search.	<ul style="list-style-type: none"> Adjust the vertical hold control on the TV or monitor.
	The picture has no sound.	<ul style="list-style-type: none"> The tape is defective. If you made A/V connections, check the audio cord connection.
	The sound from a tape recorded with the VCR is not in stereo or the STEREO indicator in the display window is flashing.	<ul style="list-style-type: none"> Adjust the tracking. The video heads are dirty. Clean the video heads using a Sony video head cleaning cassette as explained above.
Recording	No TV programme appears on the TV screen.	<ul style="list-style-type: none"> Make sure the TV is set to the video channel. If you are using a monitor, set it to video input. Existing broadcasts may interfere with the VCR. Reset the RF channel output of your VCR (page 16). Select the correct source with the INPUT SELECT button. Select a programme position when recording TV programmes; select a line input when recording from other equipment.
	TV reception is poor.	<ul style="list-style-type: none"> Make sure the aerial cable is connected securely. Adjust the TV aerial.
	The tape starts playing as soon as it is inserted.	<ul style="list-style-type: none"> The safety tab has been removed. To record on this tape, cover the tab hole.
	The tape is ejected when you press ● REC.	<ul style="list-style-type: none"> The safety tab has been removed. To record on this tape, cover the tab hole.
	Nothing happens when you press ● REC.	<ul style="list-style-type: none"> Make sure the tape is not at its end.

continued

	Symptom	Remedy
Timer recording	The timer does not operate.	<ul style="list-style-type: none"> • Check that the clock is set. • Make sure a tape has been inserted. • Check that the safety tab has not been removed. • Make sure the tape is not at its end. • Make sure a programme has been set for timer recording. • Make sure your timer settings are past the current time. • Check that the decoder is turned on. • Check that the satellite tuner is turned on. • The clock stops if the DVD-VCR is disconnected from the mains for more than one minute. Reset the clock and timer. • Turn the power off and unplug the mains lead.
	The PDC function does not operate properly.	<ul style="list-style-type: none"> • Check that the clock and the date are set correctly. • Check that the PDC time you set is the correct one (there might be a mistake in the TV programme guide). If the broadcast you wanted to record did not send the good PDC information, the VCR will not start recording. • If the reception is poor, the PDC signal might be altered and the VCR might not start recording.
Others	A tape cannot be inserted.	<ul style="list-style-type: none"> • Check that a tape is not already in the tape compartment.
	The selected input line connector number does not appear in the display window.	<ul style="list-style-type: none"> • Press INPUT SELECT to display the connected line.
	The VCR mechanism needs to be cleaned.	<ul style="list-style-type: none"> • Clean the cabinet, panel and controls with a dry, soft cloth, or a soft cloth slightly moistened with a mild detergent solution. Do not use any type of solvent, such as alcohol or benzine.

Symptoms caused by contaminated video heads

• Normal picture



• Rough picture

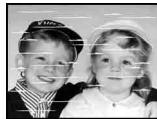

• Unclear picture



• No picture (or black & white screen appears)



initial
contamination



terminal

Glossary

Chapter (page 33)

Sections of a picture or a music feature that are smaller than titles. A title is composed of several chapters. Depending on the disc, no chapters may be recorded.

Dolby Digital (pages 54 and 58)

Digital audio compression technology developed by Dolby Laboratories. This technology conforms to 5.1-channel surround sound. The rear channel is stereo and there is a discrete subwoofer channel in this format. Dolby Digital provides the same 5.1 discrete channels of high quality digital audio found in Dolby Digital cinema audio systems. Good channel separation is realized because all of the channel data are recorded discretely and little deterioration is realized because all channel data processing is digital.

Dolby Surround (Pro Logic) (page 53)

Audio signal processing technology that Dolby Laboratories developed for surround sound. When the input signal contains a surround component, the Pro Logic process outputs the front, centre and rear signals. The rear channel is monaural.

DTS (page 58)

Digital audio compression technology that Digital Theater Systems, Inc. developed. This technology conforms to 5.1-channel surround sound. The rear channel is stereo and there is a discrete subwoofer channel in this format. DTS provides the same 5.1 discrete channels of high quality digital audio.

Good channel separation is realized because all of the channel data is recorded discretely and little deterioration is realized because all channel data processing is digital.

DVD (page 6)

A disc that contains up to 8 hours of moving pictures even though its diameter is the same as a CD.

The data capacity of a single-layer and single-sided DVD is 4.7 GB (Giga Byte), which is 7 times that of a CD. The data capacity of a double-layer and single-sided DVD is 8.5 GB, a single-layer and double-sided DVD is 9.4 GB, and double-layer and double-sided DVD is 17 GB.

The picture data uses the MPEG 2 format, one of the worldwide standards of digital compression technology. The picture data is compressed to about 1/40 (average) of its original size. The DVD also uses a variable rate coding technology that changes the data to be allocated according to the status of the picture. Audio information is recorded in a multi-channel format, such as Dolby Digital, allowing you to enjoy a more real audio presence.

Furthermore, various advanced functions such as the multi-angle, multilingual, and Parental Control functions are provided with the DVD.

DVD-RW (page 6)

A DVD-RW is a recordable and rewritable disc that is the same size as a DVD VIDEO. The DVD-RW has two different modes: VR mode and Video mode. DVD-RWs created in Video mode have the same format as a DVD VIDEO, while discs created in VR (Video Recording) mode allow the contents to be programmed or edited.

DVD+RW (page 6)

A DVD+RW (plus RW) is a recordable and rewritable disc. DVD+RWs use a recording format that is comparable to the DVD VIDEO format.

Interlace format

Interlace format shows every other line of an image as a single “field” and is the standard method for displaying images on television. The even number field shows the even numbered lines of an image, and the odd numbered field shows the odd numbered lines of an image.

Progressive format (pages 56 and 62)

Compared to the Interlace format that alternately shows every other line of an image (field) to create one frame, the Progressive format shows the entire image at once as a single frame. This means that while the Interlace format can show 25 or 30 frames (50-60 fields) in one second, the Progressive format can show 50-60 frames in one second. The overall picture quality increases and still images, text, and horizontal lines appear sharper. This player is compatible with the 525 or 625 progressive format.

Title (page 33)

The longest section of a picture or music feature on a DVD, movie, etc., in video software, or the entire album in audio software.

Track (page 33)

Sections of a picture or a music feature on a CD or VIDEO CD (the length of a song).

Specifications

System

Laser

Semiconductor laser

Signal format system

PAL/(NTSC)

Channel coverage

PAL (I)

VHF IA to IJ, SA10 to SA13

UHF E21 to E69

CATV S01 to S05, S1 to S20

HYPER S21 to S41

RF output signal

UHF channels 21 to 69

Aerial out

75-ohm asymmetrical aerial socket

Tape speed

SP: PAL 23.39 mm/s (recording/playback)

NTSC 33.35 mm/s (playback only)

LP: PAL 11.70 mm/s (recording/playback)

NTSC 16.67 mm/s (playback only)

EP: NTSC 11.12 mm/s (playback only)

Maximum recording/playback time

10 hrs. in LP mode (with E300 tape)

Rewind time

Approx. 1 min. (with E180 tape)

Inputs and outputs

LINE-1 (EURO AV)

21-pin

Video input: pin 20

Audio input: pins 2 and 6

Video output: pin 19

Audio output: pins 1 and 3

LINE-2 IN \rightarrow / \rightarrow L/R

VIDEO IN, phono jack (1)

Input signal: 1 Vp-p, 75 ohms, unbalanced, sync negative

AUDIO IN, phono jacks (2)

Input level: 327 mVrms

Input impedance: more than 47 kilohms

LINE-3

21-pin

Video input: pin 20

Audio input: pins 2 and 6

OUT

VIDEO OUT, phono jack (1)

Output signal: 1 Vp-p, 75 ohms, unbalanced, sync negative

AUDIO OUT, phono jacks (2)

Standard output: 327 mVrms

Load impedance: 47 kilohms

Output impedance: less than 10 kilohms

Additional AUDIO OUT, phono jacks (2)

Standard output: 327 mVrms

Load impedance: 47 kilohms

Output impedance: less than 10 kilohms

DIGITAL OUT (OPTICAL)

Optical output jack/-18 dBm (wave length 660 nm)

DIGITAL OUT (COAXIAL)

Phono jack/0.5 Vp-p/75 ohms

COMPONENT VIDEO OUT (Y, C_B, C_R)

Phono jack

Y: 1.0 Vp-p/C_B, C_R: 0.7 Vp-p, 75 ohms

S-VIDEO OUT

4-pin mini DIN/Y: 1.0 Vp-p, C: 0.3 Vp-p (PAL), 0.286 Vp-p (NTSC)/75 ohms

Timer section

Clock

Quartz locked

Timer indication

24-hour cycle

Timer setting

6 programs (max.)

General

Power requirements

220 – 240 V AC, 50 Hz

Power consumption

20 W

Standby power consumption

2.6 W (Power Save On mode, minimum)

Operating temperature

5°C to 40°C

Storage temperature

-20°C to 60°C

Dimensions including projecting parts and controls (w/h/d)

Approx. 430 × 85 × 287 mm

Mass

Approx. 3.9 kg

Supplied accessories

Remote commander (1)

R6 (size AA) batteries (2)

Aerial cable (1)

Design and specifications are subject to change without notice.

Index to parts and controls

Refer to the pages indicated in parentheses () for details.

Front panel

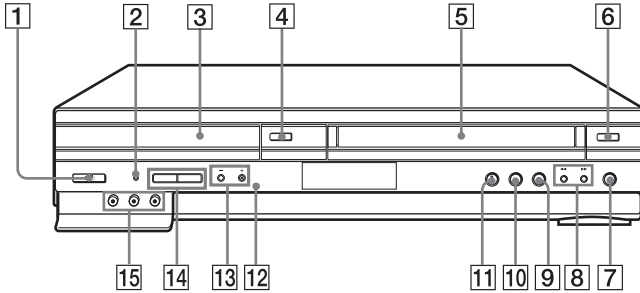

1 I/⏻ (on/standby) switch (11) (31) (38)

2 PROGRESSIVE indicator (56) (62)

3 Disc tray (28)

4 ⏪ (open/close) button (28) (30)

5 Tape compartment (37)

6 ⏮ (eject) button (38)

7 ● REC (record) button (41)

8 ⏮ (rewind)/⏭ (fast-forward) buttons (30) (38)

9 ■ (stop) button (29) (38)

10 ■■ (pause) button (29) (38)

11 ▷ (play) button*¹ (29) (37)

12 📡 Remote sensor (10)

13 PROGRAM/TRACKING +/- buttons*¹ (41)

14 SELECT DVD/VIDEO buttons (10)

15 LINE-2 IN ⏪/⏭ L/R jacks*² (104)

*¹ ▷ and PROGRAM/TRACKING + button has a tactile dot.

Use the tactile dot as a reference when operating the DVD-VCR.

*² Covered

Display window

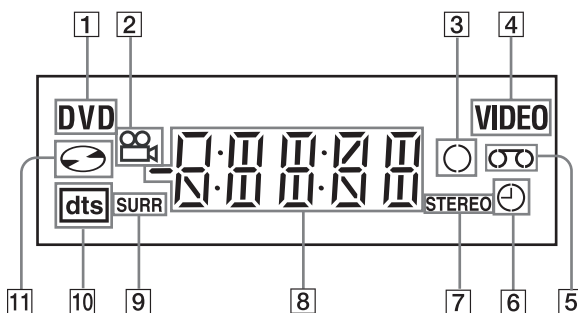

- | | |
|--------------------------------|--|
| 1 DVD indicator (29) | 7 STEREO indicator (96) |
| 2 Angle indicator (72) | 8 Playing time/clock/current status indicator (29) (37) |
| 3 Record indicator (41) | 9 SURR (surround) indicator (81) |
| 4 VIDEO indicator (37) | 10 DTS indicator (58) |
| 5 Tape indicator (37) | 11 Disc indicator (29) |
| 6 Timer indicator (46) | |

Rear panel

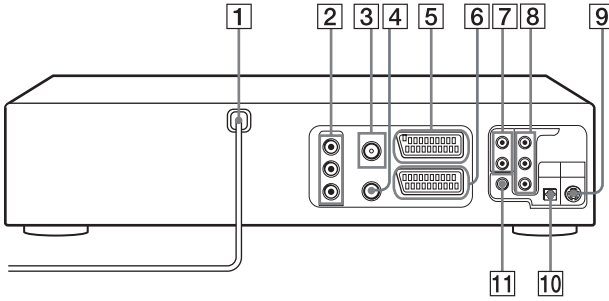

DVD player and VCR

- 1** Mains lead (12)
- 2** OUT AUDIO L/R/VIDEO jacks (53)
- 3** Π (in from aerial) connector (12)
- 4**  (out to tv) connector (12)
- 5** LINE-3 connector (14)
- 6** LINE-1 (EURO AV) connector (13)

DVD player only

- 7** LINE OUT AUDIO L/R jacks (55)
- 8** COMPONENT VIDEO OUT $C_R/C_B/Y$ jacks (56)
- 9** S-VIDEO OUT jack (55)
- 10** DIGITAL AUDIO OUT jack (OPTICAL) (54)
- 11** DIGITAL AUDIO OUT jack (COAXIAL) (54)

Remote commander for DVD

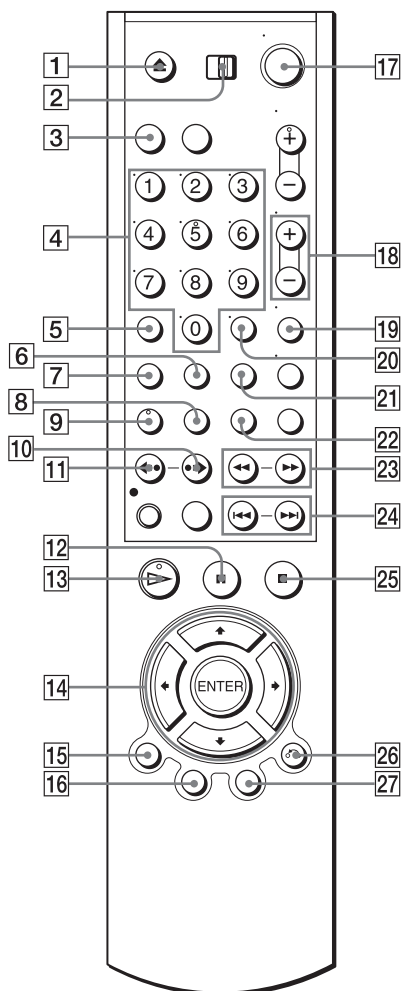

- 1 ▲ (open/close) button (28) (30)
- 2 TV / DVD-VIDEO switch (10)
- 3 SELECT DVD button (10)
- 4 Number buttons* (11) (67)
- 5 CLEAR button (25) (76)
- 6 SURROUND button (81)
- 7 SET UP button (16)
- 8 SUBTITLE button (74)
- 9 AUDIO button* (80)
- 10 ●▶ SKIP button (29)
- 11 ◀◀ REPLAY button (29)
- 12 ■■ (pause) button (29)
- 13 ▷ (play) button* (29)
- 14 ▲/▼/◀/▶ buttons
ENTER button (16) (57)
- 15 DISPLAY button (33)
- 16 TOP MENU button (69)
- 17 I/⏻ (on/standby) switch (11) (31)
- 18 VOL (volume) +/- buttons (11)
- 19 ZOOM button (71)
- 20 -/-- (ten's digit) button (11)
- 21 REPEAT button (75) (78)
- 22 ANGLE button (72)
- 23 ◼◼◼◼ buttons (29) (30)
- 24 ◀◀◀ PREV (previous)/▶▶▶ NEXT buttons (29)
- 25 ◼ (stop) button (29)
- 26 ⏪ RETURN button (21) (34)
- 27 MENU button (69)

* Number 5, AUDIO and ▷ buttons have a tactile dot. Use the tactile dot as a reference when operating the DVD-VCR.

continued

Remote commander for VCR

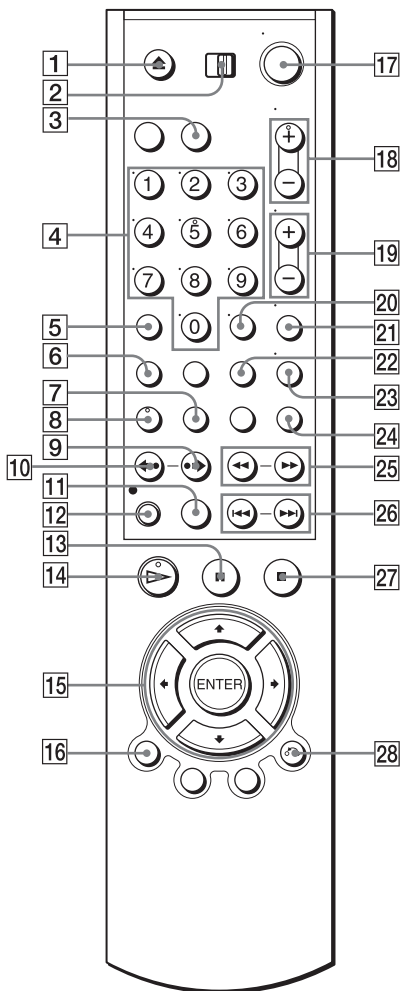

- 1 ▲ (eject) button (38)
- 2 TV / DVD-VIDEO switch (10)
- 3 SELECT VIDEO button (10)
- 4 Number buttons* (11)
- 5 CLEAR button (25) (39)
- 6 SET UP button (16)
- 7 TIMER button (48)
- 8 AUDIO button* (96)
- 9 ●→ SKIP button (38)
- 10 ←● REPLAY button (38)
- 11 SP (Standard Play)/LP (Long Play) button (41)
- 12 ● REC (record) button (41)
- 13 || (pause) button (38)
- 14 ▷ (play) button* (37)
- 15 ↑/↓/←/→ buttons
ENTER button (15) (45)
- 16 DISPLAY button (42)
- 17 I/⏻ (on/standby) switch (11) (38)
- 18 PROG (programme)/TRACKING +/- buttons* (41) (100)
- 19 VOL (volume) +/- buttons (11)
- 20 -/-- (ten's digit) button (11)
- 21 MUTE button (11)
- 22 INDEX button (98)
- 23 TV/VIDEO button (11)
- 24 INPUT SELECT button (41)
- 25 ◀◀ (rewind)/▶▶ (fast-forward)/
SLOW ▶▶ buttons (38)
- 26 ◀◀/▶▶ SHUTTLE buttons (38)
- 27 ■ (stop) button (38)
- 28 ↺ RETURN button (21) (101)

* Number 5, AUDIO, ▷ and PROG/TRACKING + buttons have a tactile dot. Use the tactile dot as a reference when operating the DVD-VCR.

DVD Audio/Subtitle Language

Abbreviation	Language
ARA	Arabic
BUL	Bulgarian
CHI	Chinese
CRO	Croatian
CZE	Czech
DAN	Danish
DEU	German
ENG	English
ESP	Spanish
FIN	Finish
FRA	French
GRE	Greek
HUN	Hungarian
IDN	Indonesian
IND	Hindi
ISL	Icelandic
ITA	Italian
IWR	Hebrew
JPN	Japanese
KOR	Korean
MAL	Malay
NLD	Dutch
NOR	Norwegian
POL	Polish
POR	Portuguese
RUS	Russian
SVE	Swedish
THA	Thai
TUR	Turkish
VIE	Vietnamese
ZAF	Afrikaans

Index

Numerics

- 16:9 61
- 4:3 Letter Box 61
- 4:3 Pan Scan 61

A

- Adjusting
 - picture 100
 - tracking 100
- Aerial hookup 12
- Angle 72
- Audio track 97
- Auto Clock Set 15
- Auto Set Up 15

C

- Changing the programme position 22
- Changing the station name 26
- Cleaning the video heads 113
- Clock setting 18
- Connecting
 - the DVD-VCR and your TV 12
 - to a TV with a Scart (EURO-AV) connector 13
 - to video equipment 104
- Counter 39
- Custom AV Mode 35

D

- Daily/weekly recording 46
- DATA CD 6, 83, 88
- DATA DVD 6, 83, 88
- Disabling the programme positions 24
- DOLBY DIGITAL 53, 58, 80
- DTS 54, 58, 80
- DVD 6

E

- Editing 104
- EP mode 38

H

- Handling discs 8
- Hi-fi audio track 97

I

- Index scan 98
- Instant Advance 30
- Instant Replay 30, 38
- Instant Skip 38

J

- JPEG 6, 88

L

- Language selecting 17
- LP mode 41

M

- Manual fine tuning 22
- Monaural 96
- Monitoring
 - during playback 97
 - during recording 96
- MP3 6, 83

N

- NICAM broadcasts 96
- Normal audio track 97

P

- Parental Control 66
- PBC (Playback control) 92
- PDC (Programme Delivery Control) 46
- Picture adjustment 100
- Playback 28, 37
 - at various speeds 30, 38
 - JPEG image files 88
 - MP3 audio track 83
 - programme play 75
 - repeat play 78
 - selecting the sound 96, 97
 - shuffle play 77
 - shuttle play 38
 - slow motion 30, 38
 - VIDEO CDs 92
- Playback quickly or slowly with sound 31
- Presetting channels 20
- Programme play 75
- Progressive 56, 116

R

- Recording 40
 - daily/weekly 50
 - quick timer recording 94
 - saving 43
 - using the VIDEO Plus+ system 44
 - while watching another programme 42, 47, 50
- Repeat play 78
- Resume play 31
- RF channel 15, 16
- Rotation 89

S

- Safety tab 43
- Scart connection 13
- Searching
 - at various speeds 30, 38
- Shuffle play 77
- Shuttle play 38
- Slide show 90
- Smart trilogic 100
- SP mode 41
- STEREO 80, 96
- Subtitle 74

T

- Timer setting
 - quick timer recording 94
 - using the VIDEO Plus+ system 44
- Tracking adjustment. *see* Adjusting

U

- Usable discs 6

V

- VIDEO CD 6
- VIDEO Plus+ recording 44

Z

- Zoom 71, 90