

Hi-Q™

Real Time Digital Video Recorders

EN

Installation Instructions



IMPORTANT SAFEGUARDS

1. Read Instructions - All safety and operating instructions should be read before the unit is operated.
2. Retain Instructions - The safety and operating instructions should be retained for future reference.
3. Heed Warnings - All warnings on the unit and in the operating instructions should be adhered to.
4. Follow Instructions - All operating and use instructions should be followed.
5. Cleaning - Unplug the unit from the outlet before cleaning. Do not use liquid cleaners or aerosol cleaners. Use a damp cloth for cleaning.
6. Attachments - Do not use attachments not recommended by the product manufacturer as they may cause hazards.
7. Water and Moisture - Do not use this unit near water - for example, in a wet basement, near a swimming pool, in an unprotected outdoor installation, or in any area which is classified as a wet location.
8. Accessories - Do not place this unit on an unstable stand, tripod, bracket, or mount. The unit may fall, causing serious injury to a person and serious damage to the unit. Use only with a stand, tripod, bracket, or mount recommended by the manufacturer or sold with the product. Any mounting of the unit should follow the manufacturer's instructions and should use a mounting accessory recommended by the manufacturer.
An appliance and cart combination should be moved with care. Quick stops, excessive force, and uneven surfaces may cause the appliance and cart combination to overturn.
9. Ventilation - This unit should not be placed in a built-in installation or rack, unless proper ventilation is provided, or the manufacturer's instructions have been adhered to. The equipment must not exceed its maximum operating temperature requirements.
10. Mechanical Loading - Mounting of the equipment in a rack shall be such that a hazardous condition is not achieved due to uneven mechanical loading.
11. Power Sources - This unit should be operated only from the type of power source indicated on the marking label. If you are not sure of the type of power supply you plan to use, consult your dealer or local power company. For units intended to operate from battery power or other sources, refer to the operating instructions.
12. Grounding or Polarization - This unit may be equipped with a polarized alternating-current line plug (a plug having one blade wider than the other). This plug will fit into the power outlet only one way. This is a safety feature. If you are unable to insert the plug fully into the outlet, try reversing the plug. If the plug should still fail to fit, contact your electrician to replace your obsolete outlet. Do not defeat the safety purpose of the polarized plug.
Alternately, this unit may be equipped with a 3-wire grounding-type plug, a plug having a third (grounding) pin. This plug will only fit into a grounding-type power outlet. This is a safety feature. If you are unable to insert the plug into the outlet, contact your electrician to replace your obsolete outlet. Do not defeat the safety purpose of the grounding-type plug.
13. Power Cord Protection - Power supply cords should be routed so that they are not likely to be walked on or pinched by items placed upon or against them, paying particular attention to cords and plugs, convenience receptacles, and the point where they exit from the appliance.
14. Power Lines - An outdoor system should not be located in the vicinity of overhead power lines or other electric light or power circuits or where it can fall into such power lines or circuits. When installing an outdoor system, extreme care should be taken to keep from touching such power lines or circuits as contact with them might be fatal. U.S.A. models only - refer to the National Electrical Code Article 820 regarding installation of CATV systems.
15. Overloading - Do not overload outlets and extension cords as this can result in a risk of fire or electric shock.
16. Object and Liquid Entry - Never push objects of any kind into this unit through openings, as they may touch dangerous voltage points or short out parts that could result in a fire or electric shock. Never spill liquid of any kind on the unit.
17. Servicing - Do not attempt to service this unit yourself as opening or removing covers may expose you to dangerous voltage or other hazards. Refer all servicing to qualified service personnel.
18. Damage Requiring Service - Unplug the unit from the outlet and refer servicing to qualified service personnel under the following conditions:
 - a. When the power supply cord or plug is damaged.
 - b. If liquid has been spilled or objects have fallen into the unit.



- c. If the unit has been exposed to water and/or inclement weather (rain, snow, etc.).
 - d. If the unit does not operate normally by following the operating instructions. Adjust only those controls that are covered by the operating instructions, as an improper adjustment of other controls may result in damage and will often require extensive work by a qualified technician to restore the unit to its normal operation.
 - e. If the unit has been dropped or the cabinet has been damaged.
 - f. When the unit exhibits a distinct change in performance--this indicates a need for service.
19. Replacement Parts - When replacement parts are required, be sure the service technician has used replacement parts specified by the manufacturer or have the same characteristics as the original part. Unauthorized substitutions may result in fire, electric shock, or other hazards.
 20. Safety Check - Upon completion of any service or repairs to this unit, ask the service technician to perform safety checks to determine that the unit is in proper operating condition.
 21. Coax Grounding - If an outside cable system is connected to the unit, be sure the cable system is grounded. U.S.A. models only--Section 810 of the National Electrical Code, ANSI/NFPA No.70, provides information with respect to proper grounding of the mount and supporting structure, grounding of the coax to a discharge unit, size of grounding conductors, location of discharge unit, connection to grounding electrodes, and requirements for the grounding electrode.
 22. Lightning - For added protection of this unit during a lightning storm, or when it is left unattended and unused for long periods of time, unplug it from the wall outlet and disconnect the cable system. This will prevent damage to the unit due to lightning and power line surges.
 23. The safety related fire, shock, and injury aspects of the models have been investigated by Underwriters Laboratories Inc. to UL 1950 and CSA 22.2 No. 950-95. Burglary and theft protection features have not been evaluated by Underwriters Laboratories.

FCC & ICES INFORMATION (U.S.A. AND CANADIAN MODELS ONLY)

This device complies with part 15 of the FCC Rules. Operation is subject to the following two conditions:

- (1) This device may not cause harmful interference, and
- (2) This device must accept any interference received, including interference that may cause undesired operation.



NOTE: This equipment has been tested and found to comply with the limits for a Class A digital device, pursuant to Part 15 of the FCC Rules and ICES-003 of Industry Canada. These limits are designed to provide reasonable protection against harmful interference when the equipment is operated in a commercial environment. This equipment generates, uses and radiates radio frequency energy, and if not installed and used in accordance with the instruction manual, may cause harmful interference to radio communications. Operation of this equipment in a residential area is likely to cause harmful interference, in which case the user will be required to correct the interference at his expense.

Intentional or unintentional changes or modifications, not expressly approved by the party responsible for compliance, shall not be made. Any such changes or modifications could void the user's authority to operate the equipment. If necessary, the user should consult the dealer or an experienced radio/television technician for corrective action.

This is a Class A product. In a domestic environment, this product may cause radio interference, in which case, the user may be required to take adequate measures.

The user may find the following booklet, prepared by the Federal Communications Commission, helpful: [How to Identify and Resolve Radio-TV Interference Problems](#). This booklet is available from the U.S. Government Printing Office, Washington, DC 20402, Stock No. 004-000-00345-4.

SAFETY PRECAUTIONS

	CAUTION RISK OF ELECTRIC SHOCK. DO NOT OPEN!	
CAUTION: TO REDUCE THE RISK OF ELECTRICAL SHOCK, DO NOT OPEN COVERS. NO USER SERVICEABLE PARTS INSIDE. REFER SERVICING TO QUALIFIED SERVICE PERSONNEL.		

 The lightning flash with an arrowhead symbol within an equilateral triangle is intended to alert the user to the presence of uninsulated "dangerous voltage" within the product's enclosure that may be of sufficient magnitude to constitute a risk of electric shock to persons.

 The exclamation point within an equilateral triangle is intended to alert the user to presence of important operating and maintenance (servicing) instructions in the literature accompanying the appliance.

WARNING TO PREVENT FIRE OR SHOCK HAZARD, DO NOT EXPOSE UNITS NOT SPECIFICALLY DESIGNED FOR OUTDOOR USE TO RAIN OR MOISTURE.
--

 Attention: Installation should be performed by qualified service personnel only in accordance with the National Electrical Code or applicable local codes.

 Power Disconnect. Units with or without ON-OFF switches have power supplied to the unit whenever the power cord is inserted into the power source; however, the unit is operational only when the ON-OFF switch is in the ON position. The power cord is the main power disconnect for all units.

SECURITE

	ATTENTION RISQUE D'ÉLECTROCUTION. NE PAS OUVRIR!	
DANGER : POUR ÉVITER TOUT RISQUE D'ÉLECTROCUTION, VEUILLEZ NE PAS OUVRIR LE BOÎTIER. IL N'Y A PAS DE PIÈCES REMPLAÇABLES PAR L'UTILISATEUR À L'INTÉRIEUR DU BOÎTIER. POUR TOUTE MAINTENANCE, VEUILLEZ VOUS ADRESSER À UN TECHNICIEN SPÉCIALISÉ.		

 L'éclair fléché dans un triangle équilatéral avertit l'utilisateur de la présence d'une "tension dangereuse" non isolée à l'intérieur de l'appareil et d'une valeur suffisante pour présenter un risque d'électrocution aux personnes.

 Le point d'exclamation contenu dans un triangle équilatéral avertit l'utilisateur de la présence de consignes d'utilisation et de maintenance importantes dans la documentation qui accompagne l'appareil.

ATTENTION POUR ÉVITER TOUT RISQUE D'ÉLECTROCUTION OU D'INCENDIE, VEUILLEZ NE PAS EXPOSER À LA PLUIE OU À L'HUMIDITÉ UN APPAREIL NON CONÇU POUR UNE UTILISATION EXTÉRIEURE.

 Attention. L'installation ne doit être effectuée que par un personnel technique qualifié conformément à la réglementation du Code Électrique National ou à la réglementation locale pertinente.

 Disjonction de l'alimentation. Les appareils avec ou sans commutateurs ON-OFF sont alimentés à chaque fois que le cordon d'alimentation est branché à la source d'alimentation; toutefois, les appareils disposant de commutateurs ON-OFF ne fonctionnent que lorsque le commutateur ON-OFF est dans la position ON. Le cordon d'alimentation constitue le moyen de disjonction de l'alimentation principale de tous les appareils.

WARNING: Electrostatic-sensitive device. Use proper CMOS/MOSFET handling precautions to avoid electrostatic discharge.

NOTE: Grounded wrist straps must be worn and proper ESD safety precautions observed when handling the electrostatic-sensitive printed circuit boards.



ATTENTION OBSERVE PRECAUTIONS FOR HANDLING ELECTROSTATIC SENSITIVE DEVICES

CAUTION: Lithium Battery

Danger of explosion if battery is incorrectly replaced. Replace only with the same or equivalent type recommended by the manufacturer. Dispose of used batteries according to the battery manufacturer's instructions.



SICHERHEITSHINWEISE

	VORSICHT ELEKTRISCHE SPANNUNG. NICHT ÖFFNEN!	
VORSICHT: DAS GEHÄUSE ZUR VERMEIDUNG VON ELEKTRISCHEN SCHLÄGEN NICHT ÖFFNEN. DAS GERÄT ENTHÄLT KEINE VOM BENUTZER ZU WARTENDEN TEILE. REPARATUREN NUR VON FACHPERSONAL AUSFÜHREN LASSEN.		



Das Blitzsymbol im gleichseitigen Dreieck soll den Benutzer auf nicht isolierte „gefährliche Spannung“ im Produkt hinweisen, die ausreichend stark sein kann, um die Gefahr von elektrischen Schlägen für Menschen darzustellen.



Das Ausrufungszeichen im gleichseitigen Dreieck soll den Benutzer auf wichtige Bedienungs- und Wartungsanweisungen in der Dokumentation hinweisen, die dem Gerät beiliegt.

**WARNUNG
ZUR VERMEIDUNG VON FEUER UND
ELEKTRISCHEN SCHLÄGEN DAS GERÄT
NICHT REGEN ODER FEUCHTIGKEIT
AUSSETZEN.**



Achtung: Die Installation darf nur von qualifiziertem Wartungspersonal gemäß dem National Electrical Code oder den gültigen örtlichen Vorschriften durchgeführt werden.



Abtrennen der Spannungsversorgung: Die Spannungsversorgung zu Geräten mit und ohne Ein/Aus-Schalter ist hergestellt, wenn das Netzkabel an eine Netzsteckdose angeschlossen ist. Das Gerät ist jedoch nur betriebsbereit, wenn der Ein/Aus-Schalter eingeschaltet ist. Bei allen Geräten erfolgt das Abtrennen der Spannungsversorgung über das Netzkabel.

SEGURIDAD

	PRECAUCIÓN RIESGO DE DESCARGA ELÉCTRICA ¡NO ABRIR!	
PRECAUCIÓN: PARA REDUCIR EL RIESGO DE DESCARGA ELÉCTRICA, NO ABRA LAS TAPAS. EN EL INTERIOR NO HAY NINGÚN COMPONENTE REPARABLE POR EL USUARIO. LAS REPARACIONES DEBE REALIZARLAS PERSONAL CUALIFICADO.		



El símbolo de flecha en forma de rayo situado dentro de un triángulo equilátero pretende alertar al usuario de la presencia de "voltaje peligroso" sin aislamiento dentro de la caja del producto, el cual podría resultar de una magnitud suficiente como para presentar un riesgo de descarga eléctrica para las personas.



El punto de exclamación dentro de un triángulo equilátero pretende alertar al usuario de la existencia de instrucciones de funcionamiento y mantenimiento (reparación) en la documentación suministrada con el aparato.

**AVISO
PARA IMPEDIR EL RIESGO DE INCENDIO O
DESCARGA, NO EXPONGA EL APARATO A
LLUVIA O HUMEDAD**



Atención: La instalación debe realizarla personal cualificado en cumplimiento estricto del código eléctrico nacional (en el caso de los EE.UU.) o de los códigos locales aplicables.



Para Desconectar la Alimentación: Unidades no equipadas con interruptores ON/OFF, son alimentadas cuando el cable de alimentación es conectado a la corriente eléctrica. Las unidades equipadas con interruptores son alimentadas de igual forma, pero adicionalmente requieren que el interruptor esté posicionado en ON. El cable de alimentación es el medio principal de desconexión del equipo.

VEILIGHEIDSMATREGELEN

	VOORZICHTIG GEVAAR VOOR ELEKTRISCHE SCHOK. NIET OPENEN!	
VOORZICHTIG: MAAK HET APPARAAT NIET OPEN OM DE KANS OP ELEKTRISCHE SCHOKKEN TE VERMIJDEN. BEVAT GEEN ONDERDELEN DIE DOOR DE GEBRUIKER MOETEN WORDEN ONDERHOUDEN. LAAT ONDERHOUD EN REPARATIES UITVOEREN DOOR BEVOEGDE TECHNICI.		



Het symbool 'Bliksemflits met pijlkop' in een gelijkzijdige driehoek wijst de gebruiker op de aanwezigheid in de kast van het apparaat van niet-geïsoleerde spanningen die voldoende sterk zijn om het gevaar van elektrische schokken op te leveren.



Het uitroepteken in een gelijkzijdige driehoek maakt de gebruiker attent op de aanwezigheid in de bij het apparaat behorende documentatie van belangrijke aanwijzingen voor bediening en onderhoud.

**WAARSCHUWING
TER VOORKOMING VAN BRANDGEVAAR
EN ELEKTRISCHE SCHOKKEN MAG DIT
ARMATUUR NIET AAN REGEN EN VOCHT
WORDEN BLOOTGESTELD.**





Let op: Het apparaat mag uitsluitend door bevoegde technici geïnstalleerd worden en wel in overeenstemming met de National Electrical Code of de daarvoor plaatselijk geldende richtlijnen.



Afsluiten voeding. Apparaten met of zonder ON-OFF-schakelaar krijgen voeding zodra het netsnoer in de wandcontactdoos wordt gestoken; het apparaat is echter alleen operationeel als de ON-OFF-schakelaar op ON staat. Het netsnoer kan bij alle apparaten worden gebruikt om deze uit te schakelen.

SICUREZZA

	ATTENZIONE PERICOLO DI SCOSSA ELETTRICA. NON APRIRE.	
ATTENZIONE: PER RIDURRE IL PERICOLO DI SCOSSA ELETTRICA, NON APRIRE LE COPERTURE. L'INTERNO NON CONTIENE COMPONENTI CHE L'UTENTE PUÒ RIPARARE PERSONALMENTE. RIVOLGERSI AL PERSONALE DI ASSISTENZA QUALIFICATO PER QUALSIASI INTERVENTO DI RIPARAZIONE.		



Il simbolo triangolare di un fulmine con la punta a freccia intende mettere in allerta l'utente riguardo alla presenza di tensioni pericolose non isolate all'interno del guscio dell'unità, che potrebbero essere di intensità sufficiente per costituire pericolo di elettrocuzione.



Il punto esclamativo racchiuso in un triangolo equilatero intende avvisare l'utente in merito alla presenza di importanti istruzioni operative e di manutenzione nella documentazione di accompagnamento all'unità.

**AVVERTENZA
PER IMPEDIRE INCENDI O SCOSSA
ELETTRICA, NON ESPORRE L'UNITÀ ALLA
PIOGGIA O ALL'UMIDITÀ.**



Precauzione: affidare l'installazione al solo personale qualificato e nel rispetto del Codice elettrico nazionale (USA) o dei codici locali pertinenti.



Scollegamento dell'alimentazione. Gli apparecchi con o senza commutatori ON-OFF ricevono corrente tutte le volte che il cavo di alimentazione è inserito nella presa di forza; tuttavia, gli apparecchi muniti di commutatore ON-OFF funzionano solo se quest'ultimo è in posizione ON. Il cavo di alimentazione serve a scollegare dalla corrente tutti gli apparecchi.

MEDIDAS DE SEGURANÇA



CUIDADO

RISCO DE CHOQUE ELÉCTRICO.
NÃO ABRIR!



CUIDADO: PARA REDUZIR O RISCO DE CHOQUE ELÉCTRICO, NÃO ABRA AS TAMPAS. O INTERIOR NÃO CONTÉM PEÇAS QUE NECESSITEM DE MANUTENÇÃO. A MANUTENÇÃO DEVE SER EFECTUADA POR PESSOAL DE ASSISTÊNCIA TÉCNICA QUALIFICADO.



O símbolo do raio com a cabeça de uma seta dentro de um triângulo equilátero serve para alertar o utilizador para a presença de "corrente eléctrica perigosa" não isolada no interior da caixa do produto que pode ser suficiente para dar origem a choques eléctricos.



O ponto de exclamação dentro de um triângulo equilátero serve para alertar o utilizador para a presença de instruções de funcionamento e manutenção importantes na documentação fornecida com o aparelho.

AVISO

PARA EVITAR INCÊNDIOS OU CHOQUES ELÉCTRICOS, NÃO EXPONHA À CHUVA OU HUMIDADE UNIDADES NÃO ESPECIFICAMENTE CRIADAS PARA UTILIZAÇÃO NO EXTERIOR.



Atenção: A instalação deve ser efectuada por pessoal de assistência técnica qualificado, de acordo com o National Electrical Code (Normas de Electricidade Nacionais) ou a legislação local aplicável.



Desconexão da electricidade. Unidades com ou sem interruptores ON-OFF são activadas sempre que o cabo eléctrico for ligado a uma fonte de alimentação. No entanto, a unidade fica operacional apenas quando o interruptor ON-OFF se encontrar na posição ON. Para desligar a electricidade em qualquer uma das unidades deve ser utilizado o cabo eléctrico.

ZASADY BEZPIECZEŃSTWA



UWAGA

NIEBEZPIECZEŃSTWO PORAZENIA PRĄDEM
ELEKTRYCZNYM. NIE OTWIERAĆ!



UWAGA: ZE WZGLĘDU NA NIEBEZPIECZEŃSTWO PORAZENIA PRĄDEM NIE WOLNO OTWIERAĆ POKRYWY. W ŚRODKU NIE MA ŻADNYCH ELEMENTÓW, KTÓRE MOGĄ BYĆ NAPRAWIANE PRZEZ UŻYTKOWNIKA. NAPRAWĘ NALEŻY POWIERZYĆ AUTORYZOWANEMU PUNKTOWI SERWISOWEMU.



Błyskawica ze strzałką wewnątrz trójkąta równobocznego ma za zadanie zwrócić uwagę użytkownika na obecność niez izolowanego "niebezpiecznego napięcia" wewnątrz obudowy urządzenia, o wielkości stwarzającej niebezpieczeństwo porażenia prądem.



Wykrzyknik wewnątrz trójkąta równobocznego ma za zadanie zwrócić uwagę użytkownika na ważne czynności, związane z obsługą i konserwacją urządzenia, zamieszczone w Instrukcji obsługi.

OSTRZEŻENIE

ABY UNIKNĄĆ POŻARU LUB PORAZENIA PRĄDEM NIE WOLNO WYSTAWIAĆ NA DZIAŁANIE DESZCZU LUB WILGOCI URZĄDZEŃ, KTÓRE NIE ZOSTAŁY SPECJALNIE ZAPROJEKTOWANE DO UŻYWKANIA NA OTWARTYM POWIETRZU.



Uwaga: Instalację urządzenia powinien wykonać tylko wykwalifikowany personel, zgodnie z przepisami NEC lub odpowiednimi przepisami miejscowymi.



Odłączanie zasilania. Urządzenia zarówno nie posiadające, jak i posiadające wyłączniki ON-OFF znajdują się pod napięciem, jeżeli tylko przewód zasilający jest połączony ze źródłem zasilania. Jednakże urządzenie działa tylko wtedy, gdy wyłącznik znajduje się w położeniu ON. Przewód zasilający jest głównym odłącznikiem zasilania dla wszystkich rodzajów urządzeń.

1	PRODUCT DESCRIPTION	9
1.1	Models	9
1.2	Features.....	9
2	UNPACKING	9
2.1	Package Contents	9
3	FUNCTIONAL OVERVIEW	10
3.1	Front Panel of the Hi-Q	10
3.2	Rear Panel of the Hi-Q.....	11
4	TYPICAL SYSTEM CONFIGURATION	12
4.1	Hi-Q Audio Connection.....	12
5	QUICK START GUIDE (INITIAL POWER-UP)	13
6	PASSWORDS AND MENU NAVIGATION.....	14
6.1	Passwords	14
6.2	Navigating the Menu	14
7	PROGRAMMING THE HI-Q VIA THE MENU	15
7.1	Menu Structure.....	15
7.2	Profiles	15
7.2.1	<i>Creating a Profile</i>	<i>15</i>
7.2.2	<i>Configuring Recording Quality and Alarms</i>	<i>15</i>
7.3	Configuring the Calendar	16
7.3.1	<i>Enabling and Viewing the Calendar; Submenu <Calendar><<Settings>>.....</i>	<i>17</i>
7.3.2	<i>Inserting Profiles into the Calendar; Submenu <Calendar><<Edit Calendar>>.....</i>	<i>17</i>
7.4	Configuring Alarms	18
7.4.1	<i>Submenu <Alarms><<Inputs>></i>	<i>19</i>
7.4.2	<i>Submenu <Alarms><<Outputs>></i>	<i>19</i>
7.5	Motion Detection	19
7.5.1	<i>Submenu <Motion Detection><<Settings>></i>	<i>20</i>
7.5.2	<i>Submenu <Motion Detection><<Active Zones>></i>	<i>20</i>
7.6	Data Storage	21
7.6.1	<i>Submenu <Data Storage><<Hard Drive>>.....</i>	<i>21</i>
7.6.2	<i>Submenu <Data Storage><<Archive>></i>	<i>21</i>
7.7	System	21
7.7.1	<i>Submenu <System><<Password>></i>	<i>21</i>
7.7.2	<i>Submenu <System><<Network>></i>	<i>21</i>
7.8	Display	22
7.8.1	<i>Submenu <Display><<Monitors>></i>	<i>22</i>
7.8.2	<i>Submenu <Display><<Regional>></i>	<i>22</i>
7.9	Utilities	23
7.9.1	<i>Submenu <Utilities><<Shut Down>>.....</i>	<i>23</i>
7.9.2	<i>Submenu <Utilities><<Misc.>> (Reconfiguring the Unit; PAL/NTSC reset)</i>	<i>23</i>
7.10	Information	23
7.10.1	<i>Submenu <Information><<Activity Log>></i>	<i>23</i>
7.10.1.1	<i>Contents of Activity Log.....</i>	<i>23</i>
7.10.2	<i>Submenu <Information><<Help>>.....</i>	<i>23</i>
8	OPERATOR FUNCTIONS (FRONT PANEL).....	24
8.1	Alarm List.....	24
8.1.1	<i>Alarm List (Pop-up) Menu Options</i>	<i>24</i>
8.2	On-screen Display (OSD).....	24
8.2.1	<i>Alarm Icons.....</i>	<i>24</i>

9	PLAYBACK AND LIVE VIEW	25
9.1	Full-screen	25
9.2	Quad Screen	25
9.3	Playback Search	25
10	ARCHIVING	27
10.1	Connecting the Archive Drive	27
10.2	Connecting to Disk Array Device	27
10.3	Archive Modes	27
10.3.1	Submenu <Data Storage><Archive>	28
10.3.2	Disk Full Behavior (via <Data Storage><Hard Drive> menu)	28
10.3.3	Archive Mode Settings	28
10.4	Manual Archive (Tape Archive ONLY)	28
10.5	Tape Catch-up Feature	29
10.6	Tape Archiving FAQ & Hints	29
11	MAINTENANCE	30
11.1	Temperature Monitoring	30
12	REPLACEMENT PARTS	30
13	Hi-Q MANAGEMENT UTILITY	31
13.1	Overview	31
13.2	Operating System Requirements	31
13.3	Installation	31
13.4	Hi-Q Management Utility Operations	31
13.4.1	Hi-Q Version Information	32
13.4.2	Bosch Security Systems, Inc. Software Update Site	32
13.4.3	Transferring Files	32
13.4.3.1	File Selection Controls	32
13.4.3.2	File Transfers	32
14	TROUBLESHOOTING	33
	APPENDIX A – TECHNICAL SPECIFICATIONS	34
	APPENDIX B – Hi-Q DEFAULTS	35
	APPENDIX C – APPROVED ARCHIVE DEVICES	36
	APPENDIX D – Hi-Q ON-SCREEN CHARACTER SET	36
	APPENDIX E – RACK EAR INSTALLATION	36

For additional information, please visit our web site at www.boschsecuritysystems.com.

I PRODUCT DESCRIPTION

The Philips Hi-Q provides the highest quality digital video recording by utilizing MPEG-2 compression. Each input has its own dedicated MPEG-2 compression engine, which allows each channel to simultaneously record high quality full-motion video, without ever compromising recording quality or update rate. The recorder's contact alarms, motion detection, and 1-Touch Alarm feature, combined with its Calendar and Profile programming, provide ultimate flexibility to get the most recording out of the unit, without ever sacrificing quality.

1.1 Models

Following are the two Philips Hi-Q models currently available:

- DVRRT4 (120 GB minimum hard drive)
- DVRRT4EP (240 GB minimum hard drive)

1.2 Features

- Simultaneous four-channel recording of high quality, real time digital video
- Audio recording (channel one)
- Time-lapse and real time recording modes
- Jog shuttle control
- Two monitor outputs (menu capability on MON A)
- Quad (MON A), full-screen, and sequential switching
- On-screen alarm indicators
- Simultaneous recording, playback, and archival
- Alarm and time/date search filters
- Motion detection with direction parameters
- 1-Touch, contact, motion, sync loss, and dark alarms
- Archive Player Software for Clip Retrieval, Archiving, & Authentication
- Management Utility software
- Compatible with Philips DVAD and DVAS Series Disk Arrays
- 19-inch rack mountable

2 UNPACKING

Unpack carefully to prevent damage to the equipment.

2.1 Package Contents

Check for the following items:

- ✓ Philips DVRRT4 or DVRRT4EP unit
- ✓ Mounting Ears (for a 19-inch rack) - Part #303 3638 001 (Use Rack Mount Kit: 303 3740 501; see **Appendix E** for instructions).
- ✓ Screw Terminal Connectors:
 - Two (2) 3-pin connectors - Part #303 1759 003
 - Two (2) 8-pin connectors - Part #303 1759 008
 - One (1) 12-pin connector - Part #303 1759 012
- ✓ Power Cords: 240 V - Part #303 0167 002;
120 V - Part #303 2143 001
- ✓ Keyboard Termination Plug (not pictured) - Part #303 2728 001
- ✓ In-line Surge Protector (not pictured) - Part #303 3900 001
- ✓ Hi-Q Installation Instruction Manual (this manual) - Part #3935 890 403##,(where ## refers to a language code, followed by the document's revision number).
- ✓ CD-ROM containing Hi-Q Archive Player software, Hi-Q Management Utility software, and Installation Instruction Manuals in English, French, German, Spanish, Dutch, and Italian - Part #303 3887 0103



If any items appear to have been damaged in shipment, replace the item(s) properly in the shipping carton and notify the shipping company. If any items are missing, notify your Bosch Security Systems, Inc. Sales or Customer Service Representative.

NOTE: The shipping carton is the safest container in which to transport the unit. Save it and all packing materials for future use.

3 FUNCTIONAL OVERVIEW

3.1 Front Panel of the Hi-Q

See **Operator Functions** (Section 8) for details regarding front panel controls.

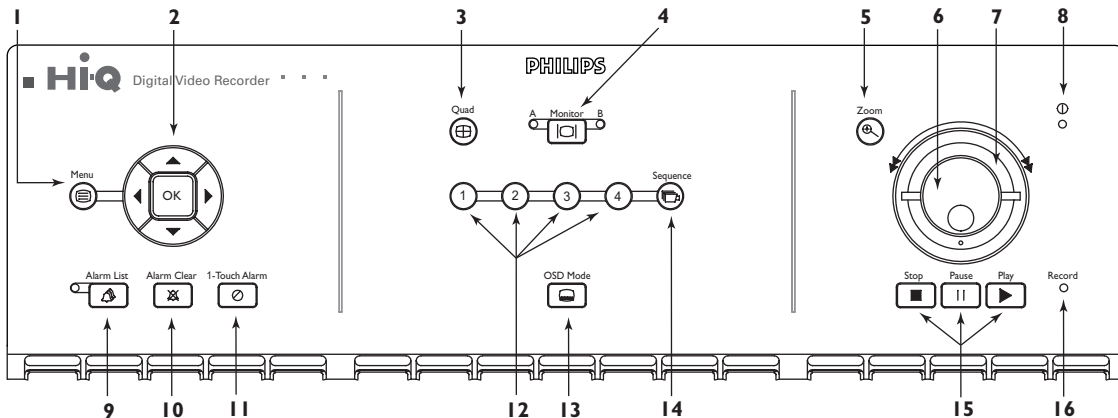
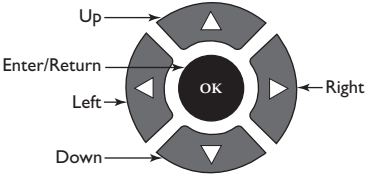

Figure 3.1 Front Panel of the Hi-Q

Ref	Name	Description and Use
1	Menu	<ul style="list-style-type: none"> Displays main menu on MON A Exits the menu from any level
2	Navigation	<p>OK button:</p> <ul style="list-style-type: none"> Confirms selection Activates submenus Edits field values <p>Up, Down, Left, Right buttons:</p> <ul style="list-style-type: none"> Navigates within menus Enters text and field values Digital PTZ control 
3	Quad	Switches MON A to quad view
4	Monitor	Toggles control between MON A and MON B
5	Zoom	Digitally zooms paused or recorded video 2X or 4X
6	Jog	<ul style="list-style-type: none"> Scrolls through menu text/values Frame advance
7	Shuttle	Forward and reverse playback speed adjustment (outside shuttle ring)
8	Power LED	Indicates that the system has power
9	Alarm List	Displays alarm list, newest first (LED is lit when there are noncleared alarms)
10	Alarm Clear	<ul style="list-style-type: none"> Acknowledges all active alarms, silences beeper, stops flashing alarm icons on MON A, and ends sequencing of alarm video on MON B Resets active relays to nonalarm state
11	1-Touch Alarm	Triggers alarm recording of all channels enabled for 1-Touch Alarm
12	Camera Display	<ul style="list-style-type: none"> 1, 2, 3, and 4 buttons display video from the selected camera Used for password entry 1, 2 used for Alarm List navigation (1 jumps to first page; 2 jumps to last page)
13	OSD Mode	(On-screen Display) Toggles screen data on or off
14	Sequence	Displays all cameras sequentially on selected monitor
15	Video Playback	<p>Stop: Stops playback video; press twice to return to live mode</p> <p>Pause: Pauses live and recorded video</p> <p>Play: Presents playback search screen (If playback video was paused, normal speed is resumed)</p>
16	Record LED	Indicates the unit is recording

3.2 Rear Panel of the Hi-Q

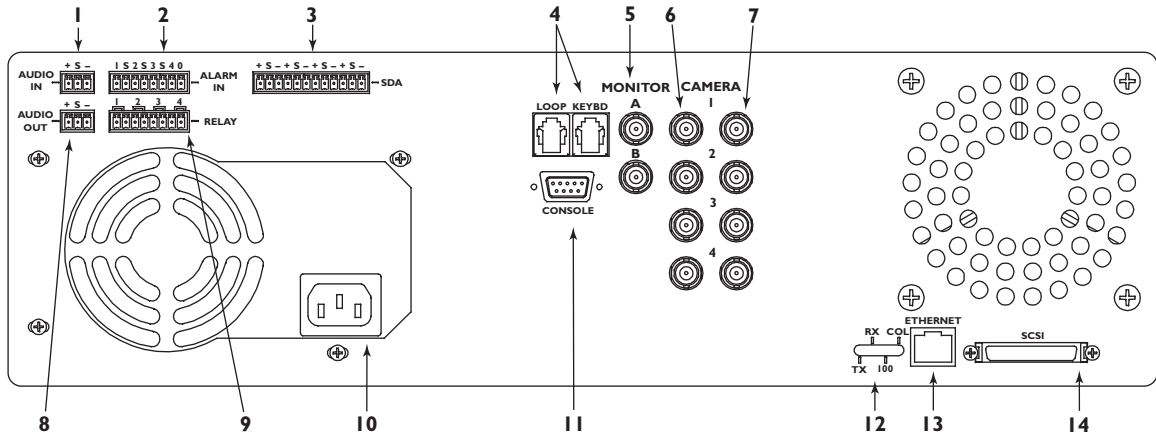

Figure 3.2 Rear Panel of the Hi-Q

Ref	Description	Connector Type
1	AUDIO IN	Screw terminal
2	4 ALARM INs**	Screw terminal
3	SDA biphas output for PTZ cameras* **	Screw terminal
4	Keyboard loop-through and keyboard input*	RJ-11
5	MON A and B outputs	BNC
6	4 video inputs	75 Ω autoterminating BNC
7	4 video looping ports	75 Ω autoterminating BNC
8	AUDIO OUT	Screw terminal
9	4 RELAY outputs (N/O or N/C)**	Screw terminal
10	Auto-sensing power input (110/220 VAC, 50/60 Hz)	IEC male
11	CONSOLE RS-232*/CCL port	DB-9 male
12	Ethernet status lights	
13	Ethernet 10/100BaseT	RJ-45
14	SCSI connector for archiving device	50-pin high density D

* Functionality provided with software upgrade in later release.

⚠ ** Belden 8760 twisted shielded cable (or equivalent) should be used for wiring to the alarm connector. Total length of unshielded cable not to exceed 10 cm (3.9 in) on each connector port to maintain compliance with Directive 89/336/EEC.

NOTES:

- Unused camera inputs should be disabled via the menu to avoid Vid Loss alarm.
- Each alarm input and output corresponds to the physical camera input/output channel (i.e., input #1 corresponds to camera #1).

4 TYPICAL SYSTEM CONFIGURATION

A typical system could contain the following components:

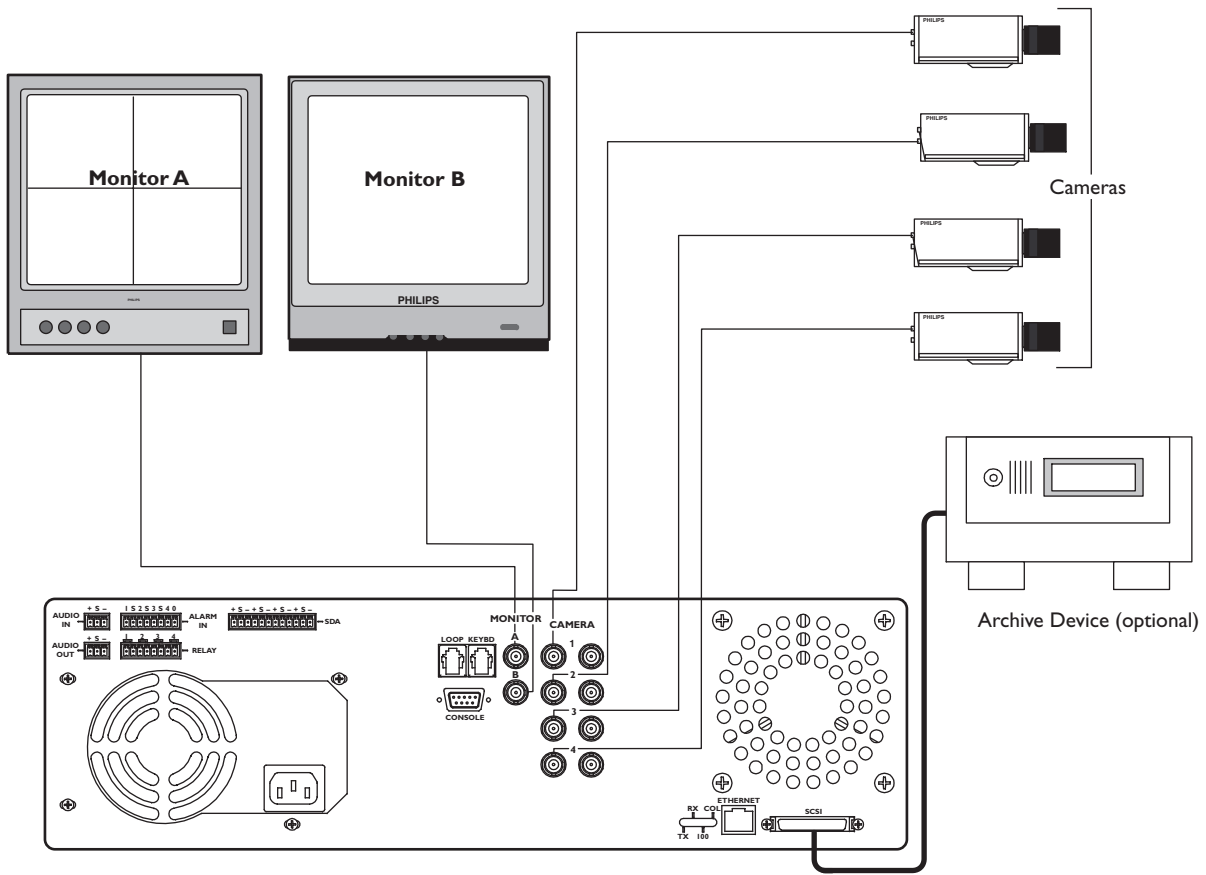
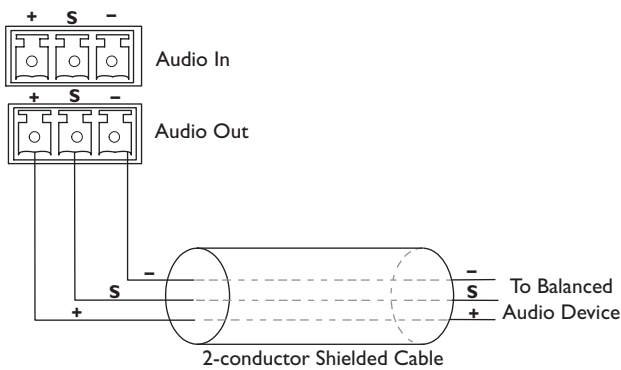

Figure 4.1 Typical Configuration

4.1 Hi-Q Audio Connection

The Hi-Q accepts both balanced and unbalanced audio inputs and outputs.

Examples for possible Audio Output connections:



NOTE: Balanced connections are more immune to noise (used for longer distances).

Figure 4.2 Balanced Audio

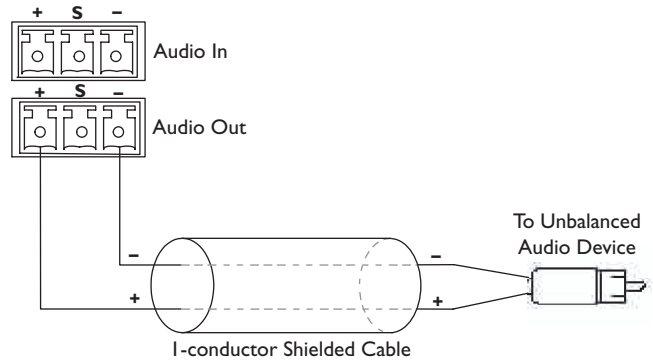

NOTE: Unbalanced connections are used to connect audio to monitors using standard RCA-type connectors (typically used for short distances).

Figure 4.3 Unbalanced Audio

5 QUICK START GUIDE (INITIAL POWER-UP)

The default setting (Profile 1 **only** is in use) has all four channels recording high quality real time video. To change these settings, proceed to **Programming the Hi-Q via the Menu** (Section 7). Refer to **Appendix B** for all default settings.

1. Install the Hi-Q in a well ventilated location, ensuring that cooling vents are not blocked. Do not place the unit on top of other equipment unless rack mounted.
2. Connect camera(s).
3. Connect audio (optional; See **Figure 3.2** for configuration).

NOTES:

- By default, audio recording is disabled to prevent unintentional audio recording that could violate legal restrictions. The administrator must enable the audio feature if desired.
 - Audio recording occurs only if Channel 1 is recording video.
4. Attach a monitor to MON A for viewing Hi-Q configuration menus.
 5. Locate the in-line surge protector packaged with the Hi-Q, and install it between the Hi-Q unit and the power cord (see installation example below).



6. Apply power and select language, date, and time (see below). Time must be entered in 24-hour format.

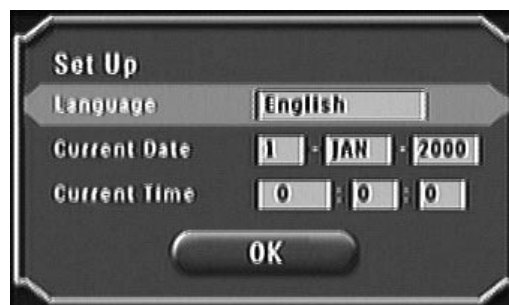

7. The Hi-Q will now autodetect PAL or NTSC cameras.

NOTE: You **must** use the **Shut Down** procedure to power down the Hi-Q (Section 7.9.1) or data may be lost.

6 PASSWORDS AND MENU NAVIGATION

6.1 Passwords

If the Hi-Q is password enabled, the following screen appears when **MENU** (front panel) is pressed. See **Section 7.7.1** for more information on passwords.



6.2 Navigating the Menu

IMPORTANT NOTES ON NAVIGATING MENUS:

These principles apply to all menus, thus are not repeated throughout this manual.

- The **Navigation** buttons are used to move through the menus.
- The **OK** button selects the highlighted item.
- Placing an **X** in a checkbox indicates that the option is enabled.

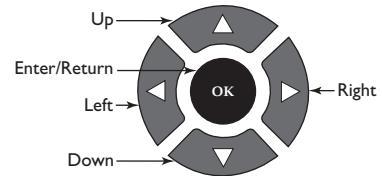

Figure 6.1 Navigation Buttons (Front Panel)

Example: Renaming **Profile 1** to **Weekend**.

Step	Procedure	Screen/Icon
1	Press MENU to display the Main Menu Screen on MON A. Use the Arrow Navigation buttons to highlight the desired menu item (in this case, <Profiles>).	
2	Press OK to open the text box of the Profile being defined.	
3	Use the Arrow Navigation buttons (or Jog) to select the text characters, then press OK .	

7 PROGRAMMING THE Hi-Q VIA THE MENU

7.1 Menu Structure

<Menu Title>	<<Submenu 1>>	<<<Submenu 2>>>
Calendar	Settings	Edit Calendar
Profiles	Manager	Edit Profile
Alarms	Inputs	Outputs
Motion Detection	Settings	Active Zones
Data Storage	Hard Drive	Archive
System	Password	Network
Display	Monitors	Regional
Utilities	Shut Down	Misc.
Information	Activity Log	Help

7.2 Profiles

To program the Calendar, first set up the Profiles, then place them into the Calendar.

Profiles define the recording quality, update rate (time-lapse or real time settings), and alarm response for each camera. Profiles are scheduled into the weekly Calendar and can automatically enable or disable video and audio recording.

7.2.1 Creating a Profile

The profile manager allows the user to name a profile (optional; 12 characters maximum), copy its contents, or reset it to default. To edit a profile name, select menu option <Profiles> <<Manager>>.



7.2.2 Configuring Recording Quality and Alarms

1. Select the profile to be edited via <Profiles> <<Edit Profile>>:



2. Configure details of the profile by checking the appropriate check boxes as shown below:

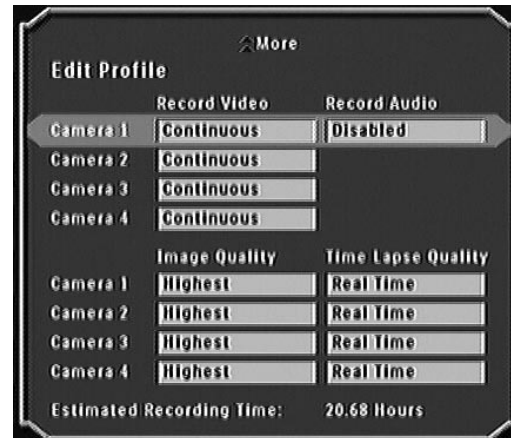
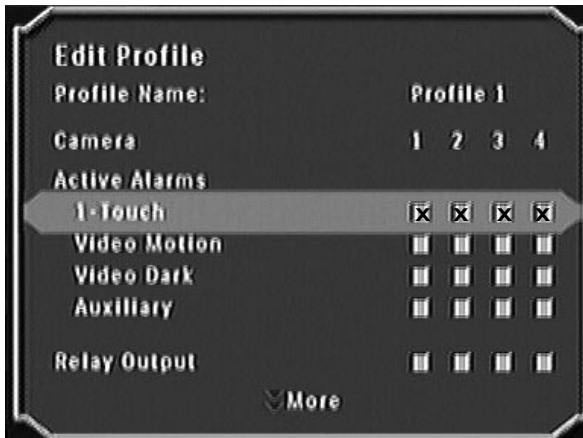

FIELD	VALUES	DEFAULT VALUE	EXPLAINED
Profile Name	Profile name as selected in the <Edit Profile> screen	[profile number]	Name of the selected profile.
Active Alarms			
I-Touch Alarm (front panel)	Each channel: Enabled or Disabled	Enabled	If enabled (box is checked), the corresponding alarm triggers high quality real time recording. Duration of alarm recording is determined by alarm settings (see Section 7.4).
Video Motion (via motion detectors)	Each channel: Enabled or Disabled	Disabled	
Video Dark (capped lens alarm)	Each channel: Enabled or Disabled		
Auxiliary (contact closure via alarm inputs)	Each channel: Enabled or Disabled		
Relay Output	Each channel: Enabled or Disabled	Disabled	If enabled, an alarm on the channel triggers a relay output response.
Record Video	Each channel: • Continuous • Event Only • Do Not Record	Continuous	Defines type of recording for each channel. Event Only records pre-alarm video for the pre-alarm time (see Section 7.4.1).
Record Audio	Camera 1 only: Enabled or Disabled	Disabled	Audio available on Channel 1 if Video is enabled.
Image Quality	Each camera: • High • Medium • Standard Plus • Standard	High	Setting image quality lower extends the record time.
Time Lapse Quality	Each camera: • Real Time (full motion) • (NTSC) 2, 5, 10, 15, 30, 60 images/sec • (PAL) 2, 5, 9, 12, 25, 50 images/sec	Real Time	Lower time-lapse setting extends the record time.
Estimated Recording Time	Calculated	Calculated	Time is estimated and is based on the current profile running continuously without alarms.

7.3 Configuring the Calendar

Calendar configuration is used to schedule recording profiles into the weekly calendar. If the calendar is not being used, only Profile 1 is needed. To change recording characteristics based on a day or time, first configure the profile, then insert it into the 7-day calendar profiles.

7.3.1 Enabling and Viewing the Calendar; Submenu <Calendar><<Settings>>

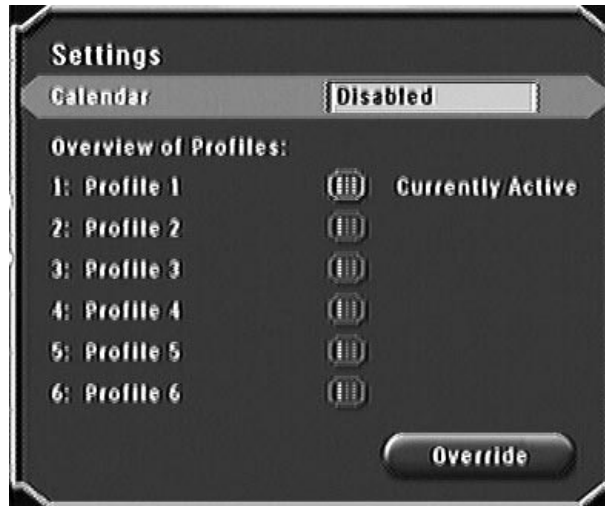

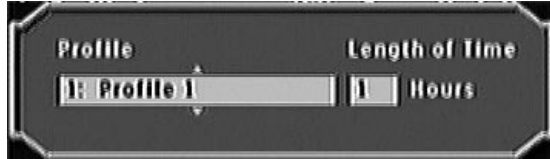
Field	Values	Default Value	Explanation									
Calendar	<ul style="list-style-type: none"> Enabled Disabled 	Disabled	If disabled, all active channels use Profile 1 all of the time.									
Override	<p>The text screen below appears for selection of values.</p>  <table border="1"> <thead> <tr> <th>Text Box</th> <th>Values</th> <th>Default Value</th> </tr> </thead> <tbody> <tr> <td>Profile</td> <td>[Profiles 1 to 6]</td> <td>[Profile 1]</td> </tr> <tr> <td>Length of time</td> <td>[1-hour increments, from 1-72]</td> <td>1</td> </tr> </tbody> </table>			Text Box	Values	Default Value	Profile	[Profiles 1 to 6]	[Profile 1]	Length of time	[1-hour increments, from 1-72]	1
Text Box	Values	Default Value										
Profile	[Profiles 1 to 6]	[Profile 1]										
Length of time	[1-hour increments, from 1-72]	1										

7.3.2 Inserting Profiles into the Calendar; Submenu <Calendar><<Edit Calendar>>



NOTE: If Stop Time is earlier than Start Time, the profile wraps to the next day. For 24-hour recording, Start and Stop Time should be programmed to 00:00.

- Start Time: 24-hour time format, in 15-minute intervals
- Stop Time: 24-hour time format, in 15-minute intervals
- Days: Days to be scheduled for this profile
- Profile: Profile to be scheduled
- Select **Enter**
- Scroll down to view the 7-day calendar containing all programmed profiles:

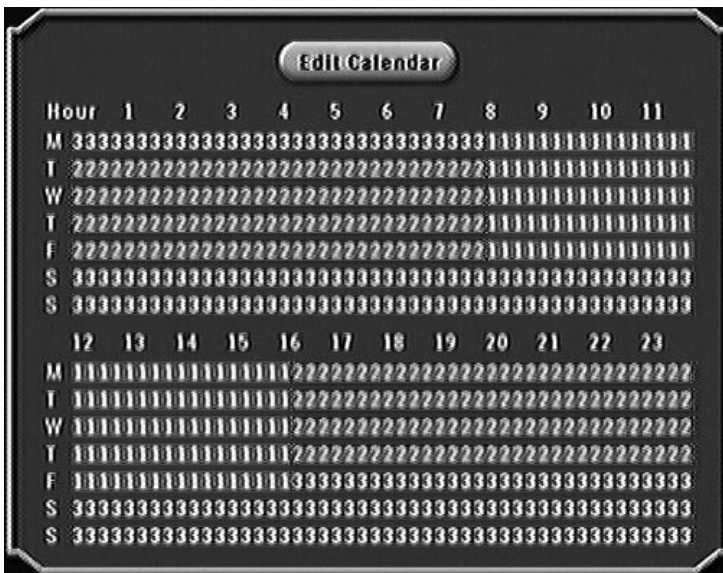

7.4 Configuring Alarms

Alarm configuration establishes alarm polarity, beeper, dwell time, and global pre-alarm and post-alarm settings.

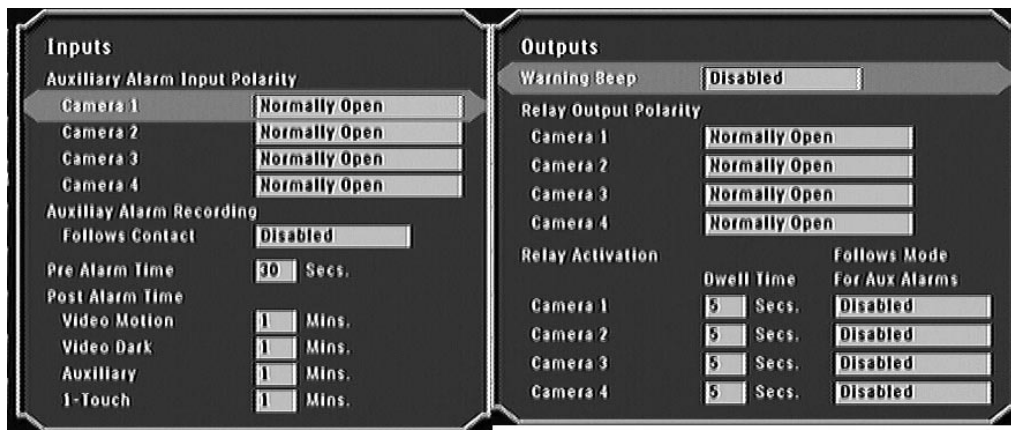

7.4.1 Submenu <Alarms><<Inputs>>

FIELD	VALUES	DEFAULT VALUE
Auxiliary Alarm Input Polarity - Cameras 1-4 individually	<ul style="list-style-type: none"> • Normally Open • Normally Closed 	Normally Open
Auxiliary Alarm Recording Follows Contact	<ul style="list-style-type: none"> • Enabled • Disabled 	Disabled
Pre-alarm Time	[1 to 60 seconds]	30 seconds
Post-alarm Time: <i>Video Motion</i>	[1 to 60 minutes]	1 minute
<i>Video Dark</i>		
<i>Auxiliary</i>		
<i>1-Touch</i>		

NOTE: Use **1-Touch Alarm** (front panel) to trigger alarm recording for the duration of the programmed POST ALARM time. Continue alarm recording by pressing **1-Touch Alarm** again.

7.4.2 Submenu <Alarms><<Outputs>>

FIELD	VALUES	DEFAULT VALUE
Warning Beep	<ul style="list-style-type: none"> • Enabled • Disabled 	Enabled
Relay Output Polarity - Cameras 1-4 individually	<ul style="list-style-type: none"> • Normally Open • Normally Closed 	Normally Open
Relay Activation: <i>Dwell Time - Cameras 1-4 individually</i>	[3 to 60 seconds, 1 second increments]	5 seconds
Follows Mode for Aux Alarm -	<ul style="list-style-type: none"> • Enabled • Disabled 	Disabled

7.5 Motion Detection

Motion detection causes the system to alarm based on motion through a zone. Sensitivity, speed, and direction settings can be set via these menus.

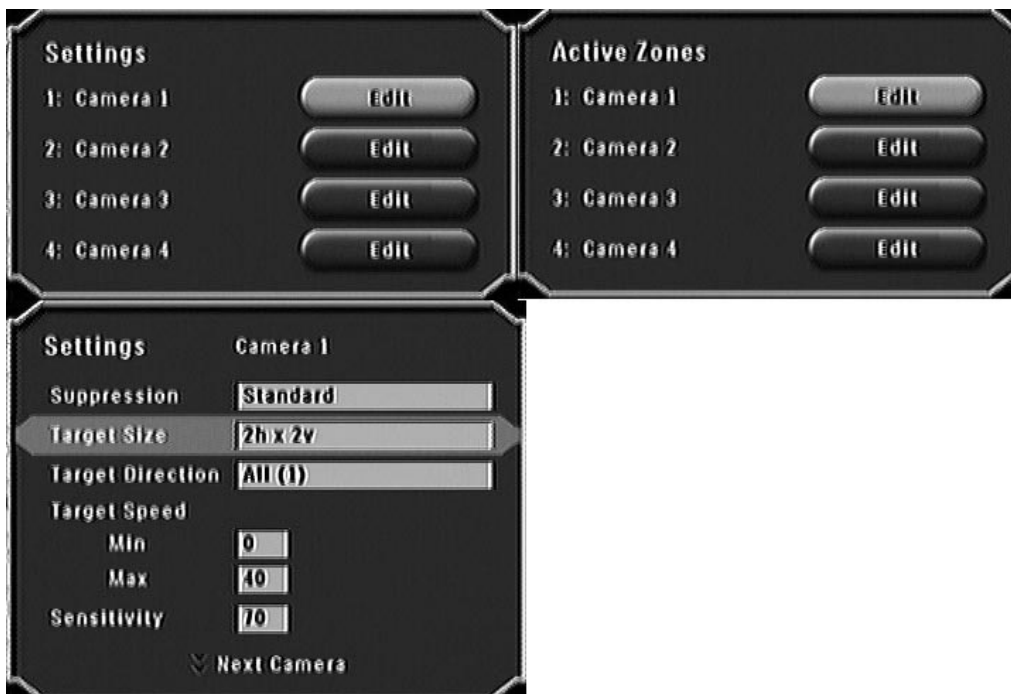

7.5.1 Submenu <Motion Detection><<Settings>>

FIELD	VALUES	DEFAULT VALUE	EXPLAINED
Suppression	<ul style="list-style-type: none"> • Standard • Stable • None 	Standard	<ul style="list-style-type: none"> • Standard: ignores small lighting changes (less than 25%) • Stable: ignores large lighting changes (less than 50%) • None: responds to all changes; recommended for indoor applications
Target Size (horizontally by vertically)	<ul style="list-style-type: none"> • 1 h x 1 v • 1 h x 2 v • 2 h x 1 v • 2 h x 2 v 	2 h x 2 v	Defines size of motion grid
Target Direction	<ul style="list-style-type: none"> • All (1) • All (2) • Up • Down • Left • Right 	All (1)	<ul style="list-style-type: none"> • All (1): detects motion in any direction • All (2): detects motion in any direction, but helps suppress false motion alarms • Up, Down, Left, or Right - alarm only on specific motion
Target Speed Min, Max	0 to 85 seconds	0–40 seconds	Alarms if object passes through camera's field-of-view within range
Sensitivity	[Between 100 (high) and 1 (low)]	70	Higher value is more sensitive to motion

7.5.2 Submenu <Motion Detection><<Active Zones>>

When **Edit** is selected, a frozen video image from the selected camera appears (by default, the entire area is an active zone).



Use the **DOWN** arrow to move the cursor down into the image, then to the desired area. The light blue overlay indicates the selected active region(s); multiple active zones are permitted. Press **OK** to toggle the cursor between modes (see below). When complete, select **Save**. To deselect, press **Clear All**.

CURSOR MODES:

- **Move** - No change
- **Activated** - Selected
- **Clear** - Deselected

ACTIONS:

- **Set All** - Marks all zones active
- **Clear All** - Marks all zones inactive
- **Save** - Exits screen and saves settings
- **Cancel** - Exits screen without saving settings

7.6 Data Storage



7.6.1 Submenu <Data Storage><<Hard Drive>>

FIELD	VALUES	DEFAULT VALUE
Disk Full Behavior	<ul style="list-style-type: none"> Overwrite Stop Recording 	Overwrite <ul style="list-style-type: none"> Stop Recording is the default (non-adjustable) if a disk array is recognized
Disk 1 Status	<ul style="list-style-type: none"> Good Bad 	Calculated
Disk 2 Status	<ul style="list-style-type: none"> Good Bad Not Installed 	Calculated
Total Capacity	Hard disk capacity, in GB	Calculated

7.6.2 Submenu <Data Storage><<Archive>>

See Archiving, Section 10.

7.7 System



7.7.1 Submenu <System><<Password>>

FIELD	VALUES & DEFINITION	DEFAULT VALUE
Password Protection	<ul style="list-style-type: none"> Enabled (requires password for menu access) Disabled (no password required for menu access) 	Disabled

Available Actions:

- **Set Password.** Press front panel buttons 1 through 4 to set the password (four to ten characters).

NOTE: This password is the same password used by the Hi-Q Management Utility.

7.7.2 Submenu <System><<Network>>

The Network menu allows access to settings that control the behavior of the recorder with respect to a network.

- Enter the IP, Subnet Mask, and Default Router addresses.
- Enter a Hi-Q recorder name to be used on the network.

FIELD	VALUES	DEFAULT VALUE
IP Address	[0–255 in each block]	10.10.0.0
Subnet Mask	[0–255 in each block]	255.255.255.0
Default Router	[0–255 in each block]	10.10.0.1
Name	[12 Characters]*	Hi-Qxxxx**

* See Appendix D for Hi-Q on-screen character set.

** XXXX is the last 4 digits of the Hi-Q recorder serial number.

7.8 Display

7.8.1 Submenu <Display><<Monitors>>

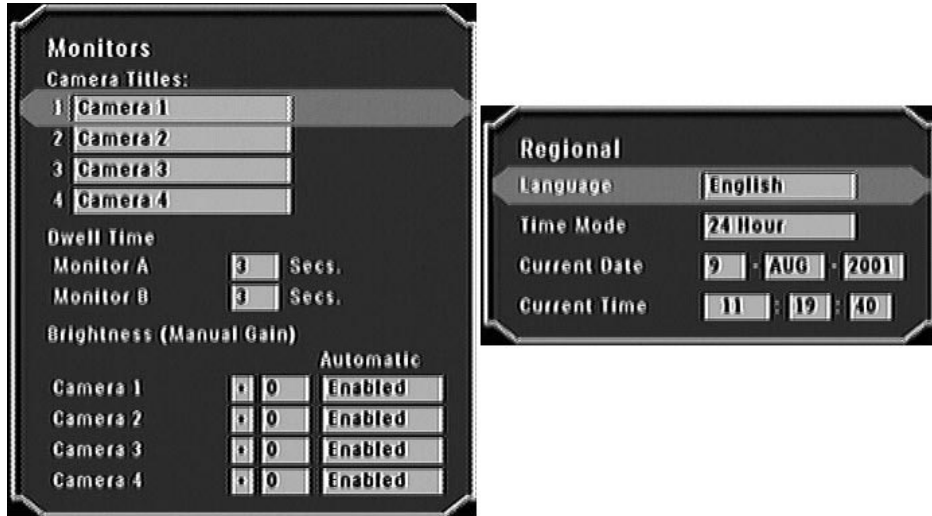

FIELD	VALUES	DEFAULT VALUE
Camera Titles - Cameras 1–4 individually	[text entry, max 12 characters]	Camera < 1, 2, 3, 4 >
Dwell Time: Monitor A Monitor B	[1 to 60 seconds, 1 second increments]	3
Brightness (manual gain) for MON A only - Cameras 1–4 individually	Automatic: enabled or disabled Values: –50 to 50	AUTO

NOTES:

- The **Brightness** setting affects the gain level on both recorded and live video.
- On *quad-screen* live video, the gain level for all camera inputs is forced to *Automatic* if any of the four channels is set for *Automatic*. If all four channels are set to a *Manual* level, quad mode reflects the specified manual gain level for each camera.

7.8.2 Submenu <Display><<Regional>>

REGIONAL FIELD	VALUES	DEFAULT VALUE
Language	<ul style="list-style-type: none"> • English • German • French • Italian • Spanish • Dutch 	English
Time Mode	<ul style="list-style-type: none"> • 24-hour • 12-hour 	24-hour
Current Date	[date in the format DD-MMM-YYYY]	[Current Date]
Current Time	<ul style="list-style-type: none"> • 24-hour mode: HH:MM:SS • 12-hour mode: HH:MM:SS AM 	[Current Eastern Standard Time: HH:MM:SS (24-hour)]

7.9 Utilities

7.9.1 Submenu <Utilities><<Shut Down>>

NOTE: You must use the **Shut Down** procedure to power down the Hi-Q or data may be lost.



7.9.2 Submenu <Utilities><<Misc.>> (Reconfiguring the Unit; PAL/NTSC reset)



Select **Defaults** to reset the unit to its factory default settings (see **Appendix B** for Hi-Q defaults). The unit cycles power, automatically detects camera type - PAL or NTSC, and configures itself accordingly.

7.10 Information

7.10.1 Submenu <Information><<Activity Log>>

To view a list of entries present in the Activity Log, specify the time frame in the screen as below.



ACTIVITY LOG FIELD	VALUES	DEFAULT VALUE
Options	<ul style="list-style-type: none"> • Entries from Date/Time • Entries from Beginning 	Entries from Date/Time
Date	[All dates]	[Current Date]
Time	All times, 1 minute increments	[Current Time] – 5 minutes

Available Actions:

- **View Log** displays the Search Results submenu. **Cancel** stops the search.

7.10.1.1 Contents of Activity Log

- Error and warning messages
- Alarms
- Alarm clear and alarm review actions
- Setup changes
- Video Clip Archive Requests
- Power cycle messages
- Administrator log-in/log-out
- Archive tape change

7.10.2 Submenu <Information><<Help>>

Displays helpful descriptions. The current version of Hi-Q software is shown at the top of the Help screen. Press **OK** to scroll to the next page.

8 OPERATOR FUNCTIONS (FRONT PANEL)

All operator functions are available from the front panel of the Hi-Q, without accessing the menu.

8.1 Alarm List

In live mode, press **Alarm List** to display all alarm events that have not been cleared (newest first), then select the desired alarm and press **OK**. The pop-up box (below, right) appears for further selection.

Press **2** to jump to the last page of the alarms; press **1** to jump to the first page.



8.1.1 Alarm List (Pop-up) Menu Options

- **Clear:** Removes an item from the list on exit but does not delete it from hard drive.
- **Play:** Plays selected alarm video (internal hard drive only). To stop playback, press **STOP**. Press **STOP** again to exit to live video.
- **Archive:** Displays the archive screen (see **Section 10** for archiving details).
 - If the Hi-Q is programmed for *Continuous* archive, this option is disabled.
- **Clear All:** Permanently deletes all items in the alarm list at exit.
- **Cancel:** Removes the Pop-up menu from the screen, leaving the item highlighted.
- **Exit to Live Mode:** Exits the Alarm List and reverts to Live mode.

8.2 On-screen Display (OSD)

8.2.1 Alarm Icons

If **OSD** is on, icons appear at the top left-hand corner of the video.

ALARM TYPE	ICON	
Video Motion		
Video (sync) Loss		
Video Dark		
Auxiliary (contact closure)		
I-Touch Alarm		

9 PLAYBACK AND LIVE VIEW

9.1 Full-screen

Typical full-screen playback screen:



The text banner includes the playback speed, camera title, date, and time. If using digital PTZ (pan/tilt/zoom), a **2X ZOOM** or **4X ZOOM** indicator also appears.

During live mode, the playback speed indicator is **LIVE**. To freeze the video, press **Pause** on the front panel. The text banner now reflects **LIVE ||**. When an alarm occurs, the appropriate alarm icon flashes between the two bitmaps defined for each alarm type.

9.2 Quad Screen

Press **Quad** (front panel) for quad screen playback. In Quad view, audio playback and frame advance are disabled.

Live video in quad mode appears to be time-lapsing even though video may be recorded in real time.

9.3 Playback Search

To search for recorded video based on time/date, camera, or alarm type, press **PLAY** during live mode.

Search Procedure:

1. Press **PLAY** to present the *Playback Search* screen.
2. Enter search criteria.
3. Select **Search Archive** or **Disk**.

NOTE:

- When equipped with a disk array, the Hi-Q automatically searches the disk array if the **From Date** is set to an older date than that of the video stored on the internal hard drive.
- When retrieving video from a tape archive device, 6 minutes of video is restored to the hard drive (1 minute prior to the specified start time and 5 minutes after).

4. Select **Find Now**.

Selecting the time/date plays back the video. If search criteria was entered, the *Playback Search Results* screen appears as shown at right.

ITEM	VALUES	DEFAULT VALUE
Devices to Search	Disk, Archive	Disk
Date from	Date Value	Current Date*
Date to	Date Value	Current Date
Time from	Time Value	Current Time – 1 minute*
Time to	Time Value	Current Time
Cameras	Cameras 1, 2, 3, and 4	All Cameras
Alarms	Motion, Dark, Vid Loss, Aux, I-Touch	None Checked
Find Now	Search Results screen is displayed	
Exit	Reverts to live video mode	



* TIP: **Date From** can be set to display the earliest video from the archive device. To do this, specify a date that is out of range (like the year 1999), then press **Find Now**.

5. Select the desired video for playback. At the completion of playback, the *Playback Search Results* screen is presented.
6. Select another video or exit search.

IMPORTANT NOTES:

- If searching a tape while in *Continuous* or *Event Only* archive mode, you must first acknowledge the message to take the tape device off-line. Video being recorded will be identified for future archiving.
- If in *Event Only* archive mode, searching tapes may take additional time due to the increased number of tape indices.
- When searching an archive tape, the tape indices are stored on the unit's hard drive for faster retrieval.
- If the search screen is exited or the tape is ejected, its indices are purged from the system, so be sure that the current search is complete before exiting.
- While in playback mode, press **STOP** to revert to the previous *Playback Search* screen. Press **STOP** again to exit and return to live mode.



Playback Search Results Options:

- **Play:** The selected alarm video is played.
- **Archive:** The archive box is displayed (see **Section 10**).
 - If *Continuous Archive* is set, *Archive* is disabled on this menu.
- **New Search:** Returns to the search screen. Current search parameters are stored as the default search criteria.
- **Cancel:** Removes the pop-up menu from the screen and leaves the item highlighted.
- **Exit:** Exits the playback function.

10 ARCHIVING

10.1 Connecting the Archive Drive

IMPORTANT NOTES:

- Do not set the tape device to **High Compression** mode.
 - Approved Hi-Q archive devices are listed in **Appendix C** and at www.boschsecuritysystems.com.
 - When retrieving video from an archive tape, 6 minutes of video is restored to the hard drive (1 minute prior to the specified start time and 5 minutes after).
1. Prior to powering the tape device and the Hi-Q, connect the tape drive to the SCSI port of the Hi-Q using a standard 50-pin high density, SCSI-2 connector.
 2. Set the tape drive SCSI address to zero (0) (consult the device's manual for setting the address).
 3. If the tape drive's SCSI port is not autoterminating, a suitable SCSI terminator must be used (consult the device's manual for the recommended terminator).
 4. Apply power to the tape device and wait for initialization.
 5. Apply power to the Hi-Q.
 6. Ensure proper communication between the two devices via the Hi-Q menu **<Data Storage><<Archive>>**; the screen should show the archive device type.

10.2 Connecting to Disk Array Device

1. With all power disconnected, connect the appropriate SCSI cable from the disk array to the Hi-Q.
2. Power the disk array and wait for it to initialize, approximately 1 minute (see Disk Array Instruction Manual).
3. Apply Power to the Hi-Q.
4. Ensure proper communication between the two devices via the Hi-Q menu **<Data Storage><<Archive>>**; the screen should show the disk array archive device type.

NOTES:

- The above procedure must be followed before the Hi-Q's auto SCSI device (Disk Array) detection can be enabled.
- The disk array must be powered up and initialized to be recognized by the Hi-Q. If the Hi-Q is configured for a disk array, it will wait up to 1 minute during its boot up process to give the disk array time to complete its initialization. If the disk array is not detected within this time, the Hi-Q will complete its boot process and display *Archive Not Found*.

10.3 Archive Modes

If using a tape archive device, *Archive Now* can be selected from the **<Data Storage><<Archive>>** menu. If the selected archive mode is **Event Only** or **Manual Only**, archiving is available from the **<Alarm List>** or **<Search Results>** screen.

10.3.1 Submenu <Data Storage><<Archive>>



FIELD	VALUES	DEFAULT VALUE
Archive Mode	<ul style="list-style-type: none"> Continuous Event Only* Manual Only* 	Manual Only <ul style="list-style-type: none"> Continuous if a disk array is present
Drive Manufacturer	Information displayed when archive device is installed. NOTE: <i>Cartridge Label</i> and <i>Data Written</i> appear only if in Continuous or Event Only Archive Mode.	
Type & Model		
Cartridge Label		
Data Written		

* not applicable with disk arrays

Available Actions:

- **Eject** temporarily suspends archiving, enabling the tape device's Eject button. If the tape device is not busy writing data, this menu selection is not required.
- **Archive Now** displays the *Manual Archive* screen (tape archiving only).

10.3.2 Disk Full Behavior (via <Data Storage><<Hard Drive>> menu)

- If **Disk Full Behavior** is set to *Overwrite* and the HDD is full, video continues to record, overwriting the oldest video first. Note that *Overwrite* refers to the internal Hi-Q disk drives, and is not available if archiving via disk array.
- If **Disk Full Behavior** is set to *Stop Recording* and **Archive Mode** is set to *Manual Only*, recording stops when the HDD is full.

10.3.3 Archive Mode Settings

NOTE: **Event Only** and **Manual Archive** modes are only applicable for tape devices.

- If **Archive Mode** is set to *Continuous* or *Event Only*, recording stops when it's about to overwrite video identified for archival.
- A message is displayed when the unit stops recording. Resume recording by selecting the menu option <Data Storage><<Hard Drive>>RECORD.
- *Event Only* archiving is a global setting; an alarm on any camera causes archival of video from all cameras recording at that time.

10.4 Manual Archive (Tape Archive ONLY)

Manual Archive archives video from the selected camera(s) for a specified date/time, to the archive device.



Manual Archive Options:

FIELD	VALUES	DEFAULT VALUE
Channels - 1-4 individually	<ul style="list-style-type: none">• [each channel: Enabled]• [each channel: Disabled]	[All enabled]
Data from	[all dates]	Start date of clip
Time from	[all dates]	Start date of clip
Date to	[all dates]	End date of clip
Time to	[all dates]	End date of clip
Mode	<ul style="list-style-type: none">• Append• Overwrite	Append

10.5 Tape Catch-up Feature

The maximum time that an archive device can be off-line is based on all cameras continuously recording real time video, at the highest quality. As long as the archive device is back on-line, receiving accumulated archive data before the hard drive reaches capacity, no archive data is lost. This can be accomplished because the Hi-Q identifies or *tags* video to be archived. When successfully archived, the tag is removed.

10.6 Tape Archiving FAQ & Hints

- Can I search and read tapes produced from another Hi-Q?
Yes.
- Can I perform a *Manual* archive when in *Continuous* or *Event Only* Archive Mode?
No. You must first change Archive Mode to Manual Only via the <Data Storage><<Hard Disk>> <<<Archive>>> menu, then follow the instructions for manual archive.
- Why can't I write to a tape?
Ensure the tape is not write-protected.
- Can a tape be relabeled?
Before a tape is overwritten, there's a prompt to accept the existing tape label or create a new one.
- How much video can be retrieved from tape at a time?
When retrieving video from an archive tape, 6 minutes of video is restored to the hard drive (1 minute prior to the specified start time and 5 minutes after).
- Why are there variances in the length of time it takes to search a tape?
Search time is dependent upon the type of archiving. Event Only archive tapes typically take longer.
- How can a tape be protected so that it is not mistakenly overwritten?
Depress the tape's write protect tab.
- Why won't the tape eject?
If the tape drive is busy or reading/writing data, the eject button is disabled. Either wait for the tape drive to complete its task or use the Hi-Q's menu option, Eject (see Section 10.2.1).
- What happens if a *Manual Archive* request consists of more data than the tape has remaining?
The tape fills with data, then prompts for a new tape. The remainder of the data is transferred to the second tape.
- Does the Hi-Q continue to record and tag video for archival during a tape search?
Yes.
- Will data get lost if the tape drive has been off-line for a period of time?
The Tape Catch-up feature usually prevents archive data from being lost. If the tape device is off-line for an extended period of time, data loss could occur.
- When can I append to a tape?
The type of archive data appending to the tape must be the same as when the tape was initialized (formatted). For example, a formatted tape containing manual archive data can only be appended with manual archive data.

II MAINTENANCE

In the event of a lost system password or for instructions for changing the Hi-Q's battery, contact Bosch Security Systems, Inc. Technical Support or your local Bosch Representative.

Field maintenance of this unit is limited to external cleaning and inspection. Refer all servicing to qualified personnel. Contact your local Bosch Representative for Service.

Toll-free Voice Activated Phone Number: 800-326-3270 or 717-735-6300.

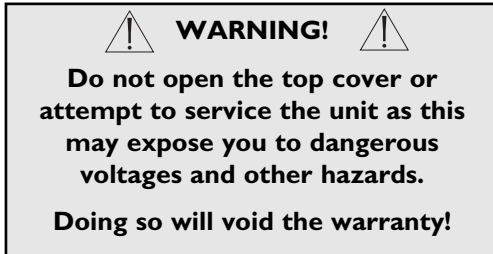

II.1 Temperature Monitoring

A temperature sensor monitors the Hi-Q's internal temperature. In the event that the temperature exceeds the highest recommended operating temperature, an on-screen error message appears on Monitors A and B.

II.2 REPLACEMENT PARTS

Part No.	Description
303 3638 001	Mounting Ears (for a 19-inch rack. Use Rack Mount Kit #303 3740 501)
303 2143 001	Power Cord: 120 V
303 0167 002	Power Cord: 240 V
303 0588 001	Hi-Q Battery: (Rayovac® battery, lithium, 3 V/180 mAH, button cel type; part # BR2325-B)
303 1759 003	3-pin Screw Terminal Connector
303 1759 008	8-pin Screw Terminal Connector
303 1759 012	12-pin Screw Terminal Connector
303 2728 001	Keyboard Termination Plug
3935 890 403##	Hi-Q Installation Instructions; this manual (where ## refers to language & revision)
303 3887 0103	CD-ROM containing Hi-Q Archive Player software, Hi-Q Management Utility software, and Installation Instruction Manuals in English, French, German, Spanish, Dutch, and Italian

13 Hi-Q MANAGEMENT UTILITY

13.1 Overview

The Hi-Q Management Utility is a simple Windows® application that allows users to perform the following:

- View the contents of /Transfer a Software Update File (SUF) to the Hi-Q
- Transfer a Configuration File to the Hi-Q
- Retrieve a Configuration File from the Hi-Q
- Retrieve/View the contents of a System Activity Log from the Hi-Q
- View the Hi-Q version information
- Open a Web browser to the Bosch Security Systems, Inc. software update site

13.2 Operating System Requirements

The Hi-Q Management Utility runs under Windows 98/ME, Windows NT 4.0 (with Service Pack 6), and Windows 2000, and it must be configured with TCP/IP network protocol.

The Hi-Q Management Utility's user interface is supported under the Danish, Dutch, English, Finnish, French, German, Italian, Norwegian, Portuguese, Spanish, and Swedish localized versions of the operating systems listed above but is displayed in English only.

13.3 Installation

Exit all Windows programs prior to installing the Hi-Q Management Utility executable .exe file. Run the application and follow the instructions.

NOTE: The PC may need to be restarted after installation is complete.

13.4 Hi-Q Management Utility Operations

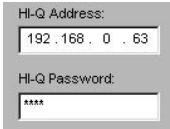

IMPORTANT: The Hi-Q IP address must be entered before proceeding. If the Hi-Q password was never enabled or changed, enter 1,2,3,4 for the password.

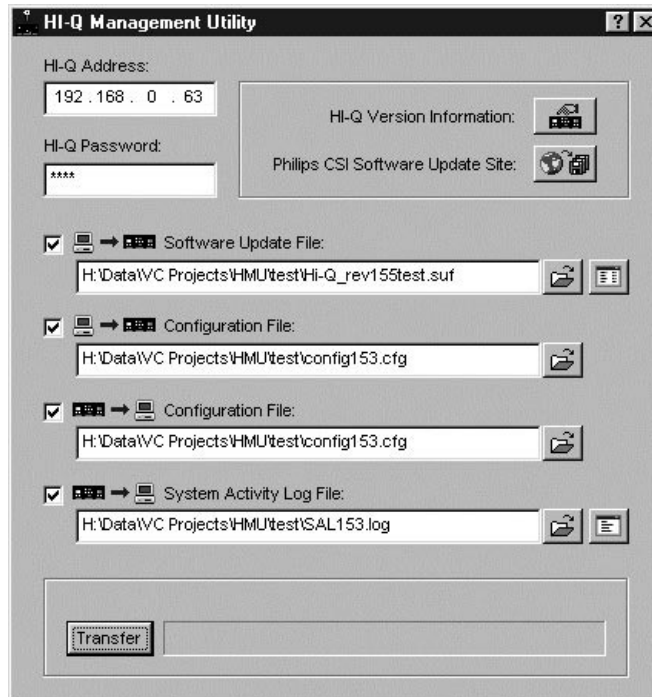

13.4.1 Hi-Q Version Information

Click  to view the Hi-Q's Version Information

13.4.2 Bosch Security Systems, Inc. Software Update Site

Click  to launch the PC's Web browser, then navigate to the Bosch Security Systems, Inc. software update site.

13.4.3 Transferring Files

- Software Update Files (*.suf) - upgrades to the Hi-Q software (improvements/extensions as released by Bosch Security Systems, Inc.).

CAUTION:

Updating older Hi-Q recorders configured with external disk arrays to software version 1.30 will result in **LOSS OF ARCHIVED VIDEO**. It is suggested to copy important archived video to VHS tape prior to updating older Hi-Q's to software version 1.30.



- Configuration Files (*.cfg) - used to save/restore the Hi-Q configuration (e.g. camera titles, alarm settings, etc.).
- System Activity Logs (*.log) - a list of Hi-Q activities and operations.

13.4.3.1 File Selection Controls

Select each file to be transferred between the Hi-Q and Hi-Q Management Utility by choosing the appropriate option.



A file is only transferred between the Hi-Q and Hi-Q Management Utility if its corresponding checkbox has been set. Setting a checkbox enables (*un-grays*) the file's controls.

 /  Files can only be transferred in one direction (i.e., PC to Hi-Q **or** Hi-Q to PC). Files to be transferred from the PC to the Hi-Q **must already exist on the PC**. Files to be transferred from the Hi-Q to the PC are created (or overwritten with permission of the user) at time of transfer.

Click  to locate files.

Click the corresponding  /  viewer buttons to display the contents of SUF and SAL files.

13.4.3.2 File Transfers

After selecting file(s), click **Transfer**. Progress is displayed on a progress bar.



If you want to interrupt the transfer, click **Abort**.

14 TROUBLESHOOTING

TROUBLE	CHECKS	ADJUSTMENTS
No video on one or more cameras on MON A	Verify proper 1 Volt p-p video level input on affected channel(s) and make sure no ground loops exist.	Correct any coax, power or camera problems.
Black screen on MON B output	Same as above.	Clear the alarm and check the other channels.
No audio on playback	Verify channel 1 video and audio are enabled in the menus. Audio can only be heard if full screen playback is viewed on the monitor for camera #1.	Make programming changes for video and audio.
Temperature Alarm flashes on-screen every 30 minutes	Ensure the environmental temperature is within the maximum and minimum limits.	Move the unit to a temperature-controlled area within the maximum and minimum limits.
Can't access the menu	Incorrect or lost password.	Contact Bosch Security Systems Technical Support for password reset instructions.
Hi-Q Management Utility can't access Hi-Q	Wrong network connection.	Program proper IP address into the Hi-Q.
Cannot view Quad screen on MON A	Ensure MON A LED is lit.	Press Monitor , ensure the A LED is lit, then press Quad .
Hi-Q Recorder Splash screen periodically flashes on MON A	Verify input AC voltage is within the maximum and minimum limits and is constant.	If necessary to maintain a constant AC input voltage, install UPS system.
Scheduled recording did not happen	Calendar is disabled.	Enable calendar via menu. If already enabled, verify the current profile settings.
Hi-Q does not detect disk array as archive device	Ensure the initial power up procedure was followed (See Section 10.2) Ensure proper communication between the two devices via the Hi-Q <Data Storage> <<Archive>>; the screen should show the disk array archive device type.	Follow initial power up procedure. If followed, verify SCSI cable is connected securely to the proper host port of the disk array.

APPENDIX A – TECHNICAL SPECIFICATIONS

SPECIFICATIONS

Electrical

Model Numbers Voltage Range Power (Operating)
 DVRRT4, DVRRT4EP 110/220 VAC, 50/60 Hz 75 W

Digital Resolution:

	60 IPS (50 IPS PAL)	30 IPS (25 IPS PAL)	<30 IPS (<25 IPS PAL)
NTSC:			
High Quality	720 H x 480 V	—	720 H x 240 V
Medium Quality	720 H x 480 V	—	352 H x 240 V
Standard Plus Quality	—	720 H x 240 V	352 H x 240 V
Standard Quality	—	352 H x 240 V	352 H x 240 V
PAL:			
High Quality	720 H x 576 V	—	720 H x 288 V
Medium Quality	720 H x 576 V	—	352 H x 288 V
Standard Plus Quality	—	720 H x 288 V	352 H x 288 V
Standard Quality	—	352 H x 288 V	352 H x 288 V

On-line Storage Time: See table below.

Recording Speeds per Channel (IPS):

NTSC: 60, 30, 15, 10, 5, and 2 IPS.

PAL: 50, 25, 12, 9, 5, and 2 IPS.

Internal Hard Drive Capacity:

DVRRT4: 120 GB.

DVRRT4EP: 240 GB.

Video:

Inputs: Four (4), looping BNC connectors (auto-terminating), 0.5 to 2.0 Vp-p, PAL/NTSC compatible.

Outputs (Mon A/B): BNC connectors, PAL/NTSC compatible, composite.

Compression: Four (4) independent MPEG-2 channels.

Audio:

Input (Mono): Screw terminal, balanced LL.

Balanced Audio Input:

4.0 Vp-p (max)/2.8 Vp-p (typ) differential level AUDIO IN (+) to AUDIO IN (-).

Unbalanced Audio Input:

4.0 Vp-p (max)/2.8 Vp-p (typ) unbalanced level AUDIO IN (+) to GROUND/SHIELD with AUDIO IN (-) tied to GROUND/SHIELD.

Output: Screw terminal, balanced LL.

Audio Output to Audio Input Gain: Unity Gain, typically.

Connectors:

Power: IEC male.

Console (Serial) Port: RS-232, DB-9 male.

Video Inputs/Outputs: BNC.

Audio Inputs/Outputs: Screw terminal.

Ultra SCSI: DB-50, narrow, single-ended.

Network: RJ45, ethernet 10/100BaseT.

Alarm Handling:

Contact Alarms:

Alarm Inputs: Four (4) NO or NC inputs, contact closure to ground or 5V logic level.

Alarm Outputs: Four (4) NO or NC outputs; Rated at 40 VAC/DC, 1 A Max (resistive).

Other Alarms: Sync, Dark, Manual, Motion.

Motion Detector (Each Input):

Parameters: Size, speed, direction; false alarm suppression.

Supported Archiving Device†:***

DVAD Series disk array

DVAS Series disk array

***Hi-Q Requires Firmware 1.10 or greater.

Network Software:

Hi-Q Archive Player:

Minimum PC Requirements

Operating System: Windows 98SE, ME, 2000, or XP with Direct Show (Version 6.1 or newer)

Processor: 600Mhz Pentium III

RAM: 128MB

Free Disk Space: 2GB for storage of a 60-minute video clip

Video System: 800 x 600 with 16-bit color and 8MB of video memory

Connection: 10/100 Base-T Network Interface

Hi-Q Management Utility:

Software upgrades, saving recording profiles and log files to PC.

The Hi-Q Management Utility runs under Windows 98/ME, Windows NT (with Service Pack 6), and Windows 2000, must be configured with TCP/IP network protocol.

Mechanical

Dimensions: 441.96 W x 464.8 D x 137.16 H mm (17.4 W x 18.3 D x 5.4 H in).

Weight: 10.94 kg (24.1 lb).

Temperature: 10° to 45°C (50° to 113°F).

Relative Humidity: 0 to 90%, noncondensing.

Product Regulatory Compliance

Electromagnetic Compatibility (EMC):

Complies with FCC Part 15, ICES-003 and CE regulations.

Product Safety:

Complies with CE regulations, UL, CSA, EN and IEC Standards.

Hi-Q Recorder

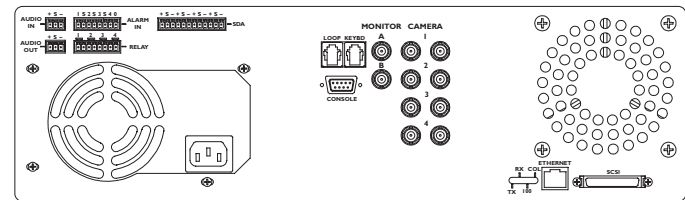

**Biphase, keyboard, and console port reserved for future upgrades.

Recording Times (Hours)

	RECORD SPEED PER CHANNEL (IPS)						
	Real Time Modes			Time-lapse Modes			
	NTSC PAL	60 50	30 25	15 12	10 9	5 5	2 2
DVRRT4:							
High Quality		15	—	22	31	39	89
Medium Quality		19	—	30	45	57	125
Standard Plus Quality		*	27	41	84	91	164
Standard Quality		*	38	63	89	98	244
DVRRT4EP:							
High Quality		32	—	46	64	80	183
Medium Quality		39	—	61	92	116	255
Standard Plus Quality		*	55	85	170	184	329
Standard Quality		*	78	128	183	199	497
NOTE: This table reflects estimated recording times, assuming all video channels are continuously recording at the given quality and record rate, without audio recording.							
*Interlaced video (50/60) is only available when recording at the High or Medium Quality settings.							

†Consult the Bosch Security Systems web site at www.boschsecuritysystems.com for an updated listing of supported devices.

APPENDIX B – Hi-Q DEFAULTS

ITEM	FACTORY DEFAULT VALUE
Alarm Setup	
Auxiliary Alarms	All Disabled
Auxiliary Alarm Input Polarity	All Normally Open
Relay Output Polarity	All Normally Open
Relay Output Enable	Disabled
Relay Activation Dwell Time	5 seconds
Relay Activation FOLLOWS Mode for Contact Closure Alarms	Disabled
1-Touch Alarm	Enabled
Dark Alarms	All Disabled
Motion Detector Alarms	All Disabled
Pre-alarm Recording Duration	30 Seconds
Post-alarm Recording Duration	1 Minute for All Alarm Types
Recording Setup	
Video Recording	All Continuous
Audio Recording	Disabled
Estimated Recording Time	Calculated
Image Quality	Highest Quality
Time-lapse mode	Real Time
Disk Full Behavior	Overwrite; (Stop Recording with disk array)
Hard Drive: Data Redundancy	For DVRRT4EP Model Only: Striping
Disk (1, 2) Status	Determined by System
Total Disk Capacity	Calculated
Archive Mode	Manual; (set to Stop Recording with disk array)
Motion Detector Setup	
Target Size	2 h x 2 v
Motion Zones	All Grid Elements Active
Sensitivity	70
Suppression	Standard
Motion Detector Direction	All (1)
Target Speed	0–40 seconds
Miscellaneous Setups	
Profile Name	Profile [Profile Number]
Warning Beeper	Enabled
Front Panel Password Protection	Disabled
Language Selection	English
Date/Time On-screen Display Format	24-hour Mode; Not Affected by Restoring Factory Defaults
Activity Log Date/Time	Current Date/Current Time – 5 Minutes
IP Address	10.10.0.0
Subnet Mask	255.255.255.0
Default Router	10.10.0.1
Name of Hi-Q	Hi-Qxxxx
Camera Titles	Camera n, where n is the camera number <1,2,3,4>
Brightness (Manual Gain) Adjustment on Video Inputs (MON A Only)	AUTO
Sequence Dwell Time - MON A & B	3 Seconds

APPENDIX C – APPROVED ARCHIVE DEVICES*

Supported Archiving Devices:* DVAS Series disk array
DVAD Series disk array
Sony® AIT-2 Single Tape Drive.

* Consult the Bosch Security Systems, Inc. web site, www.boschsecuritysystems.com, for updated listing of supported devices.

APPENDIX D – HI-Q ON-SCREEN CHARACTER SET

Character Set:

<space> ! " # \$ % & ' () * + , - . / 0 1 2 3 4 5 6 7 8 9 : ; < = > ? @ A B C D E F G H I J K L M N O P
Q R S T U V W X Y Z [\] ^ _ ` a b c d e f g h i j k l m n o p q r s t u v w x y z { | } ~ □ , f ^ < ' ' " "
• – — ~ > ¢ £ ¥ ¦ § ¨ ª « ¬ ® ¯ ± ² µ ¶ · ¸ ¹ º » ¼ ½ ¿ Ä Å Æ Ç È É Ê Ë Ì Í Î Ï Ñ Ò Ó Ô Õ ÷ ø ù ú ÿ

APPENDIX E – RACK EAR INSTALLATION

Installation:

Tools required: Medium sized Phillips head screwdriver.

Items included in supplied Rack Mount Kit (quantity):

- (2) Rack mount ears
- (6) Phillips pan head screws with integral lock washers

Mounting:

1. Remove the 6 flat head screws located near the front panel on the right and left side of the housing and discard.
2. Attach the mounting ears to each side using the 6 supplied Phillips pan head screws with lock washers and tighten securely.
3. Install the unit into the rack using the Rack manufacturer's supplied hardware.

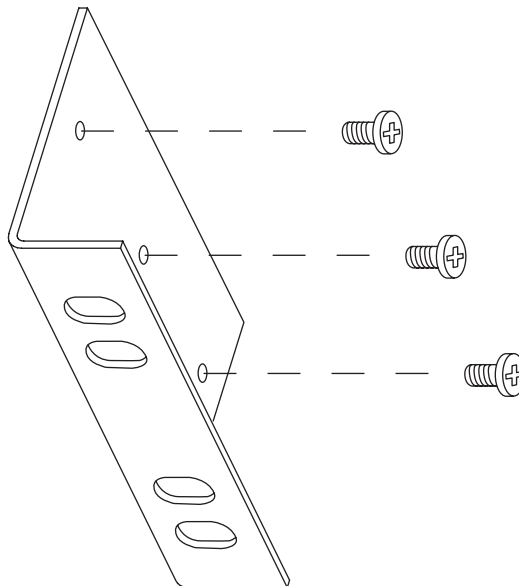

Windows® is a registered trademark of Microsoft Corporation.
Rayovac® is a registered trademark of Rayovac Corporation.

3935 890 40315 03-27
Printed In U.S.A.

© 2003 Bosch Security Systems, Inc.
All Rights Reserved. Philips® is a registered trademark of Philips Electronics N.V.
Updated July 10, 2003. Data subject to change without notice. Refer to www.boschsecuritysystems.com for latest information.