



IMPORTANT SAFETY INSTRUCTIONS



Getting started

IMPORTANT SAFETY INSTRUCTIONS	2
Accessories	3
Disc information	4
The remote control information	6
Disc handling	6
Unit care	6
Control reference guide	7
STEP 1 Connection	8
STEP 2 Plug-in Auto Tuning	12
Channel captions/Television type	14
Remote control settings	15
Clock settings	15

Recording

Important notes for recording	16
Recording modes and approximate recording times	17
Disc Insertion/Ejection	17
Recording television programs	18
To specify a time to stop recording –One Touch Recording ..	19
Flexible Recording	19
Playing while you are recording	19
Selecting audio to record	19
Scheduled recording	20
Cancel scheduled recording that has already begun	21
Release program from recording standby	21
Notes on scheduled recording	21
Check, change or delete a program	21

Playing back

Playing discs	22
Operations during play	23
Using menus to play MP3 and still pictures	
(JPEG/TIFF)	24
Playing MP3	24
Playing still pictures (JPEG/TIFF)	25
Useful functions during still picture play	25
Using on-screen menus/	
FUNCTIONS window and Status messages	26
Using on-screen menus	26
FUNCTIONS window	27
Status messages	27

Editing

Editing titles/chapters	28
Editing titles/chapters and playing chapters	28
Title operations	29
Chapter operations	29
Creating, editing and playing playlists	30
Creating playlists	30
Editing and playing playlists/chapters	31
Playlist operations	31
Chapter operations	31

Copying

Copying from a video cassette recorder	32
DV camcorder recording	32
Manual recording	32

Convenient functions





Entering text	33
Deleting titles	33
Selecting recorded titles to delete –Delete Navigator	33
Deleting title during play	33
DVD Management	34
Providing a disc with a name –Disc Name	34
Setting the protection –Disc Protection	34
Deleting all titles and playlists –Delete All Titles	34
Deleting all contents of a disc –Format Disc (DVD)	34
Selecting whether to show the Top Menu first	
–Playback will start with:	35
Enabling discs to be played on other equipment –Finalize ..	35
Creating Top Menu –Create DVD Top Menu	35
Enabling the second layer on DL (dual- or double- layer on single	
side) discs to be recordable –Close First Layer	35
Changing the unit's settings	36
Common procedures	36
Summary of settings	36

Reference

Messages	39
Frequently asked questions	40
Troubleshooting guide	41
Product Service	43
Glossary	44
Specifications	45
Limited Warranty (ONLY FOR U.S.A.)	46
Limited Warranty (ONLY FOR CANADA)	47
Referencia rápida en español	48
(Spanish Quick Reference)	
Index	Back cover

Accessories

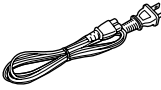
 Please check and identify the supplied accessories. Use numbers indicated in parentheses when asking for replacement parts. (Product numbers correct as of December 2005. These may be subject to change.)
Only for U.S.A.: To order accessories, refer to "Accessory Purchases" on page 46.
Only for Canada: To order accessories, call the dealer from whom you have made your purchase.

- | | | | | | | | |
|--|---|--|---|---|---|---|--|
| <input type="checkbox"/> |  | <input type="checkbox"/> |  | <input type="checkbox"/> |  | <input type="checkbox"/> |  |
| 1 Remote control
(EUR7659Y10) | | 1 Audio/video cable
(K2KA6BA00003) | | 1 75 Ω coaxial cable
(K2KZ2BA00001) | | 1 AC power supply cord
(K2CB2CB00018) | |
| <input type="checkbox"/> |  | <input type="checkbox"/> |  | | | | |
| 2 Batteries
for remote control | | 1 DVD-RAM disc | | | | | |

• For use with this unit only.
Do not use it with other equipment.
Also do not use the cords for other equipment with this unit.



(U.S.A. only)

Product Registration Card

Please complete and return the included product registration card, or register via the Internet at: <http://www.prodreg.com/panasonic/>

Disc information

Discs you can use for recording and play

Disc type	DVD-RAM	DVD-R	DVD-R DL* ¹ (dual layer on single side)	DVD-RW	+R* ²	+R DL* ¹ (double layer on single side)	+RW
Indication in these instructions	■	■ Before finalization	■ Before finalization	■ Before finalization	■ Before finalization	■ Before finalization	■
		■ After finalization	■ After finalization	■ After finalization	■ After finalization	■ After finalization	
Logo					—	—	—
Recording format (→ below)	VR	DVD-Video	DVD-Video	DVD-Video	+VR	+VR	+VR
Re-writable* ³	Yes	No	No	Yes	No	No	Yes
What you can do on this unit							
Recording broadcasts that allow one copy	Yes* ⁴	No	No	No	No	No	No
Recording both Main and SAP of MTS broadcast	Yes	No	No	No	No	No	No
Recording 16:9 aspect picture	Yes	No	No	No	No	No	No
Creating playlists	Yes	No	No	No	No	No	No
Compatibility							
Usable high speed recording disc type* ⁵	Up to 5x	Up to 16x	Up to 4x	Up to 6x	Up to 16x	Up to 2.4x	Up to 4x* ⁶
Play on other players	Only on DVD-RAM compatible players. (It is not possible to finalize the disc.)	Yes	Yes* ⁷	Yes	Yes	Yes* ⁸	Yes (It is not possible to finalize the disc.)
		Only on compatible players after finalizing the disc (→ page 35)					

- We recommend using Panasonic discs. We also recommend using DVD-RAM discs with cartridges to protect them from scratches and dirt.
- You may not be able to record depending on the condition of the discs and you may not be able to play due to the condition of the recording.
- For the recording time, refer to “Recording modes and approximate recording times” on page 17.

*¹ You can record onto the second layer of dual- or double-layer discs after closing the first layer (→ page 35). You will no longer be able to record to the first layer after you do this (→ page 16).

When playing a title recorded on both layers, video and audio may momentarily cut out when the unit is switching layers.

*² You may not be able to use +R recorded on this unit in another Panasonic DVD recorder and vice versa. Once the disc is finalized, however, it can be played in the other unit.

*³ The amount of the recordable disc space doesn't increase even if the program is deleted when you use a one time recording disc.

*⁴ CPRM (→ page 44) compatible discs only.

*⁵ This unit can use the high-speed recording discs shown in the chart, but using them will not shorten the recording time.

*⁶ You can play 8x recording speed discs recorded on another equipment.

*⁷ Play on DVD-R DL compatible equipment.

*⁸ Play on +R DL compatible equipment.

Regarding recording format

VR (DVD Video Recording) format

This is a recording method which allows you to freely record and edit television broadcasts and so on.

- Digital broadcasts that allow “One time only recording” can be recorded to a CPRM compatible disc. You can record to CPRM compatible DVD-RAM on this unit.
- Plays only possible on a compatible DVD player.











DVD-Video format

This recording method is the same as commercially available DVD-Video.

Digital broadcasts that allow “One time only recording” cannot be recorded.

You can play on compatible equipment such as DVD players after finalizing the disc on this unit.

Play-only discs

Disc type	DVD-Video	DVD-Audio	DVD-RW (VR format)	CD		Video CD
Indication in these instructions						
Logo					—	
Instructions	High quality movie and music discs	High fidelity music discs • Played on this unit in 2 channels.	DVD-RW recorded on another DVD Recorder* • You can play programs that allow "One time only recording" if they have been recorded to a CPRM compatible disc. • By formatting (→ page 34) the disc, you can record to it in DVD-Video format. • It may be necessary to finalize the disc on the equipment used for recording.	Music and audio recorded (including CD-R/RW*)	CD-R and CD-RW* with music recorded in MP3 Still pictures (JPEG and TIFF) recorded on CD-R and CD-RW*	Music and video recorded (including CD-R/RW*)

• The producer of the disc can control how discs are played. So you may not always be able to control play as described in these operating instructions. Read the disc's instructions carefully.

* Close the session after recording. Play may be impossible on some discs due to the condition of the recording.

Regarding DVD-Audio

Some multi-channel DVD-Audio will prevent down-mixing (→ page 44) of all or part of their contents if this is the manufacturer's intention. Tracks that are prevented from being down-mixed will not play properly on this unit (e.g. audio is played from the front two channels only). Refer to the disc's jacket for more information.

Note about using a DualDisc

The digital audio content side of a DualDisc does not meet the technical specifications of the Compact Disc Digital Audio (CD-DA) format so play may not be possible.

Discs that cannot be played

- 2.6 and 5.2 GB DVD-RAM, 12 cm (5")
- 3.95 and 4.7 GB DVD-R for Authoring
- DVD-R recorded in VR format
- DVD-R (DVD-Video format), DVD-R DL, DVD-RW (DVD-Video format), +R, +R DL recorded on another unit and not finalized (→ page 44)
- PAL discs (you can still play the audio on DVD-Audio)
- DVD-Video with a region number other than "1" or "ALL"
- Blu-ray
- DVD-ROM, +R 8 cm (3"), CD-ROM, CDV, CD-G, Photo CD, CVD, SVCD, SACD, MV-Disc, PD, Divx Video Disc, etc.

AC

id -)
ote

ble type

new

nt types at

xpose
art or
to
at

it
il
ri
si
a
C
r



e.

This may cau
ing it unusat
th a soft, oil-t
ard writing im
ne, thinner, s
solvent.

y affected t
midity, and
tion or bre

oth.

to
F

co

s lens ov

-CL720PP) ab

ending on frequency use and the operat
Carefully read the lens c instructions b

Remote control

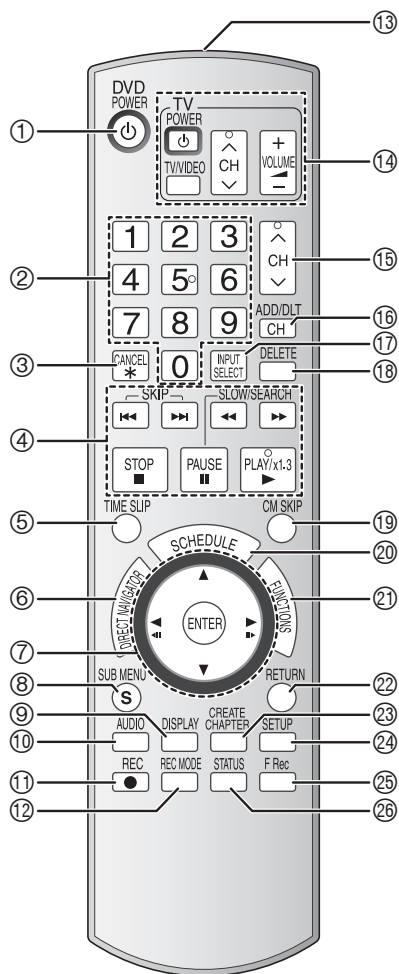

- ① Turn the unit on (→ page 12)
- ② Select channels and title numbers, etc./Enter numbers
- ③ Cancel
- ④ Basic operations for recording and play
- ⑤ Skip the specified time (→ page 23)
- ⑥ Show Direct Navigator/Top menu (→ page 22, 24, 28)
- ⑦ Selection/Enter, Frame-by-frame (→ page 12, 23)
- ⑧ Show sub menu (→ page 25, 28, 31)
- ⑨ Show on-screen menu (→ page 26)
- ⑩ Select audio (→ page 19, 23)
- ⑪ Start recording (→ page 18)
- ⑫ Change recording mode (→ page 18)
- ⑬ Remote control signal output
- ⑭ Television operations (→ page 15)
- ⑮ Channel select (→ page 18)
- ⑯ Add/delete channel (→ page 13)
- ⑰ Input select (IN1 or IN2 or DV)
- ⑱ Delete items (→ page 33)
- ⑲ Skip a minute forward (→ page 23)
- ⑳ Show scheduled recording list (→ page 20)
- ㉑ Show FUNCTIONS window (→ page 27)
- ㉒ Return to previous screen
- ㉓ Create chapters (→ page 23)
- ㉔ Show Setup menu (→ page 14, 36)
- ㉕ Start Flexible Recording (→ page 19)
- ㉖ Show status messages (→ page 27)

Main unit

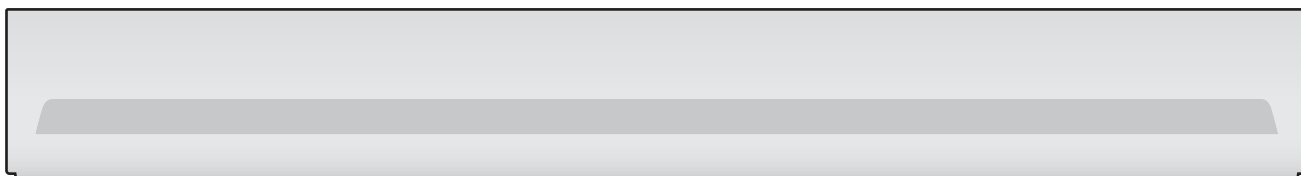

The unit's display

t erminals (

This

.

f C A e l 75 Ω coaxial cable C

Connect only aft er all ot her connections are complete.To

Ω coaxialcable
75

If y

ulator is necessary

a

This

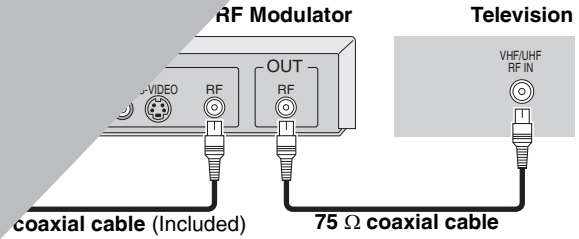

b

cassette recorder (→ page 8 B)

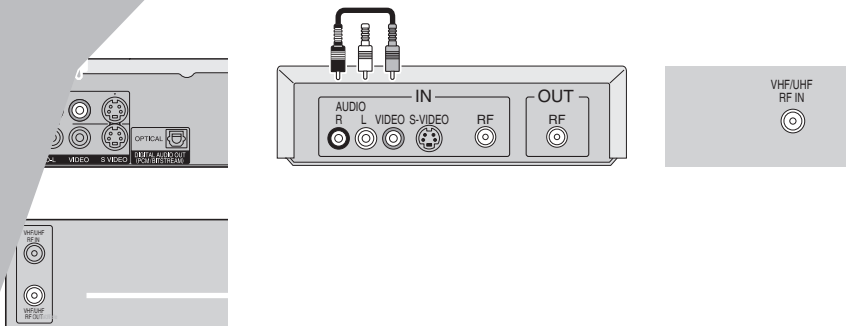

c

television and cable box or satellite receiver (→ page 9 C)

d

television, video cassette recorder and cable box or satellite receiver (→ page 9 D)

Picture quality

more vivid picture than the
on the television.)

These terminals can be used for either interlace
output (→ page 44) and provide a pure
OUT terminal.

- Connect

If the antenna connector doesn't match

Use one of the following connections to suit the antenna lead to the unit's RF IN terminal, and the 75 Ω coaxial cable to the antenna terminals on the equipment (television etc.). Refer to other equipment's operating instructions.

Type	This unit	Other equipment (television etc.)
A twin lead	<p>from the antenna</p> <p>(Flat) Twin lead 300 Ω cable</p> <p>300–75 Ω transformer</p> <p>To this unit's RF IN terminal</p>	<p>75–300 Ω transformer</p> <p>75 Ω coaxial cable</p> <p>VHF or UHF Television</p>
A twin lead and a coaxial plug	<p>from the antenna</p> <p>(Flat) Twin lead 300 Ω cable</p> <p>(Round) 75 Ω coaxial cable</p> <p>VHF/UHF band mixer</p> <p>To this unit's RF IN terminal</p>	<p>VHF/UHF band separator</p> <p>75 Ω coaxial cable</p> <p>VHF UHF Television</p>
Two twin leads	<p>from the antenna</p> <p>(Flat) Twin lead 300 Ω cable</p> <p>300–75 Ω transformer</p> <p>VHF/UHF band mixer</p> <p>To this unit's RF IN terminal</p>	<p>VHF/UHF band separator</p> <p>75 Ω coaxial cable</p> <p>VHF UHF Television</p>

Connecting an amplifier or system component

■ Connecting an amplifier with a digital input terminal

- To enjoy multi-channel surround on DVD-Video, connect an amplifier with a built-in decoder displaying these logo marks using an optical digital audio cable and change the settings in Digital Audio Output (→ page 38).
- Before purchasing an optical digital audio cable, check the terminal shape of the connected equipment.
- You cannot use DTS Digital Surround decoders not suited to DVD.
- Even if using this connection, output will be only 2 channels when playing DVD-Audio.

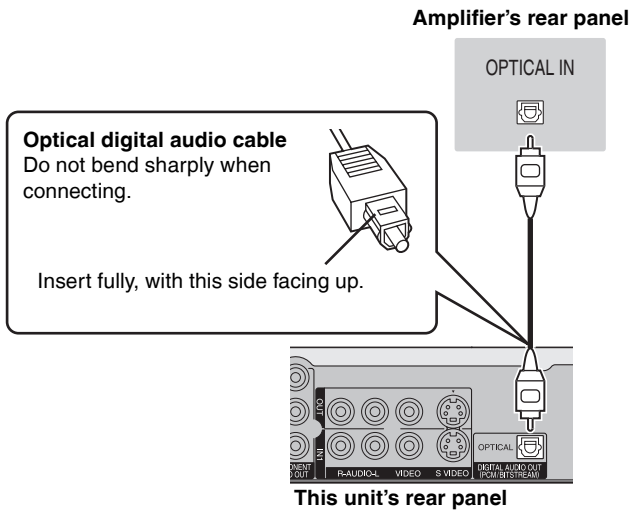

■ Connection to a stereo amplifier

Amplifier's rear panel

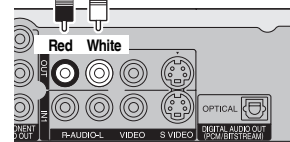
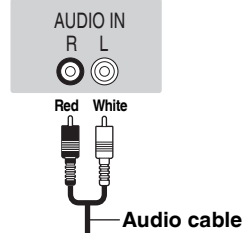

This unit's rear panel

STEP 2 Plug-in Auto Tuning

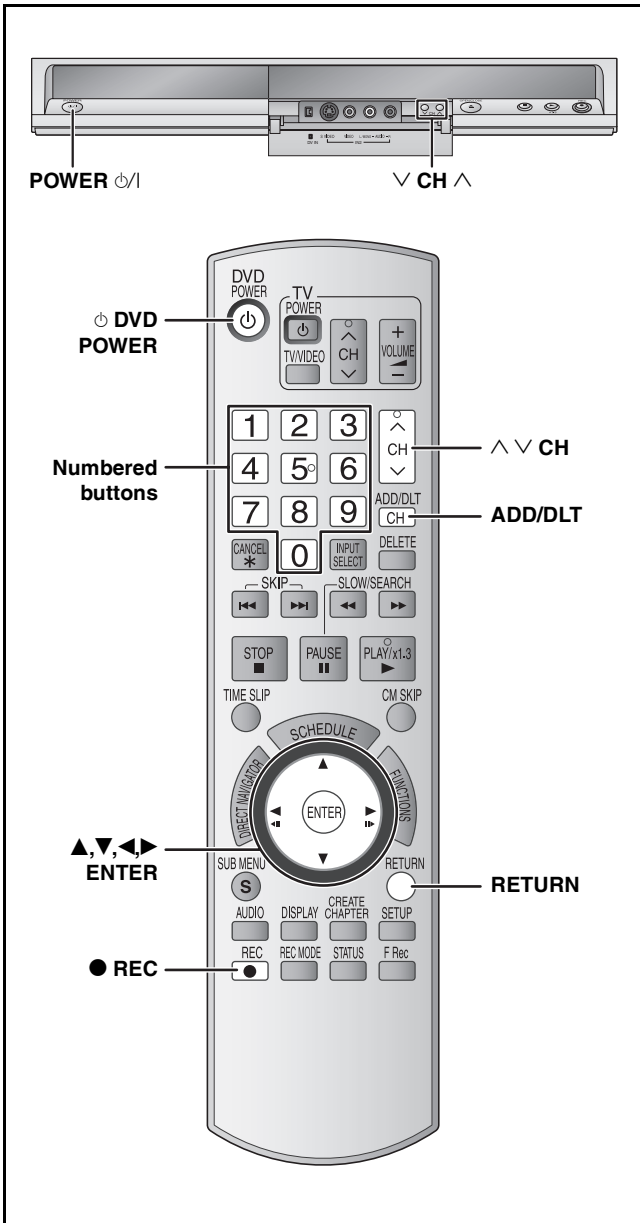

After pressing [⏻ DVD POWER] to turn the unit on for the first time, the unit starts necessary setup.

Regarding DST (Daylight Saving Time) (→ page 15)

Legal revision is expected to change the DST period in 2007. When you use the unit with DST on, the change may cause the unit's clock to go behind the actual time. Check the DST setting in "Set Clock Manually" in the Setup menu, set DST off and reset the clock precisely if you are using this function.

Preparation

Turn on the television and select the appropriate video input to suit the connections to this unit.

1 Press [⏻ DVD POWER].

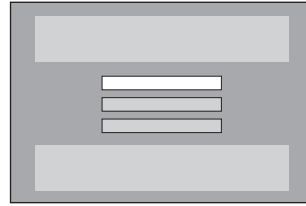

2 Press [▲, ▼] to select the language and press [ENTER].

If you make a mistake, press [RETURN] to return to an earlier screen.

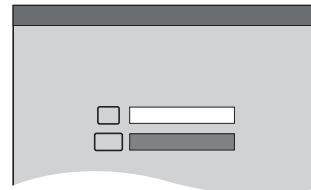

3 Press [▲, ▼] to select "4:3 TV" or "16:9 Widescreen TV" and press [ENTER].

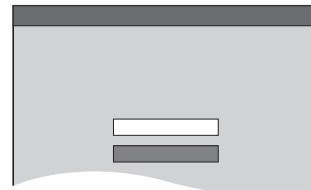

4 Press [▲, ▼] to select "On" or "Off" and press [ENTER].

If you activate "Quick Start" function, select "On".

About "Quick Start" function

If you set Quick Start to on, you can start recording to DVD-RAM about 1 second after you press [⏻ DVD POWER] to turn the unit on and then sequentially press [● REC].

The following happens when you have selected "On".

- Power consumption in standby mode increases because power is supplied to the unit.

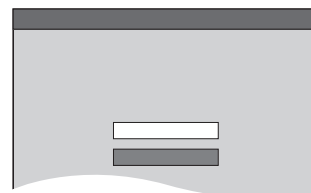

5 Press [▲, ▼] to select "Internal TV Tuner" or "Input" and press [ENTER].

When you do not set channels on this unit, select "Input". The unit then displays "Set Clock Manually" screen. Set the clock manually (→ page 13).

(Continued on next page)

6 Press [ENTER] to start Plug-in Auto Tuning.



The unit then proceeds with Auto Clock Setting. The time is displayed when finished.



■ When one of the following screen appears “No channels were found.” screen



After turning off the unit, confirm following and perform setup again.

- Confirm the antenna cable is firmly connected to RF IN terminal.
- If you do not set channels on this unit, select “Input” in step 5.

“Auto Clock Setting is incomplete.” screen



Press [ENTER] and set clock manually (→ right).

7 Press [ENTER].

A picture or a blue background screen is displayed.

■ If the clock is an hour slower or faster than the actual time

Select “-1” or “+1” in “Adjust Time Zone” in the Setup menu (→ page 15).

The unit configures channels according to the Signal Source (RF IN) settings (→ page 36) as follows.

Signal Source (RF IN)	Band	Channel
Antenna	VHF	2-13
	UHF	14-69
Cable TV	VHF	2-13
	CATV LOW BAND	95-99
	CATV MID/SUPER BAND	14-36
	CATV HYPER BAND	37-65
	ULTRA BAND	66-94 100-125
	SPECIAL CATV CHANNEL	1

Adding and deleting channels

After channel setting on this unit completed, you can add or delete channels if necessary channels are not set or unnecessary channels are set.

1 Press the numbered buttons to select a channel.

Antenna

e.g., 5: [0] → [5]
15: [1] → [5]

Cable TV

e.g., 5: [0] → [0] → [5]
15: [0] → [1] → [5]
115: [1] → [1] → [5]

Unit's display



- You can also use [^ ∨ CH] when you are going to delete a channel.

2 Press [ADD/DLT].

e.g., The channel is deleted.

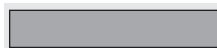

Restart Plug-in Auto Tuning (after relocation, for example)

The setting of the clock and channel is cleared when you perform the procedure below. Scheduled recording settings are also cleared.

1 When the unit is on and stopped Press and hold [∨ CH] and [^ CH] on the main unit for about five seconds.

The unit turns off.

2 Press [DVD POWER].

The language selection screen is displayed.

When “Set Clock Manually” screen is displayed

The “Set Clock Manually” screen is automatically displayed when:
– there is an error while setting the clock automatically.
– you have selected “Input” in step 5 while setting (→ page 12).

1 Press [◀▶] to select the item you want to change and press [▲, ▼] to change the setting.

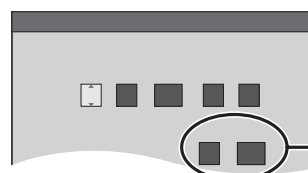

DST, Time Zone (→ below)

- DST (Daylight Saving Time):
If you select “On”, the clock is advanced one hour starting at 2 a.m. on the first Sunday in April and ending at 2 a.m. on the last Sunday in October.
- Time Zone shows the time difference from Greenwich Mean Time (GMT).
EST (Eastern Standard Time) = GMT -5
CST (Central Standard Time) = GMT -6
MST (Mountain Standard Time) = GMT -7
PST (Pacific Standard Time) = GMT -8
AST (Alaska Standard Time) = GMT -9
HST (Hawaii Standard Time) = GMT -10

2 Press [ENTER].

A picture or a blue background screen is displayed. The clock starts.



Channel captions

You can give the preset captions, or manually enter new ones yourself. The captions you enter are displayed when the channel is displayed and in the Direct Navigator screen.

- You can set channel captions after channel setting on this unit is completed (→ page 12–13).

1 While stopped
Press [SETUP].

2 Press [▲,▼] to select “Channel” and press [▶].

Preset Channel Captions

3 Press [▲,▼] to select “Preset Channel Captions” and press [ENTER].

4 Press [▲,▼] to select the caption and press [▶].

You can choose from the following captions.
ABC, PBS, CBS, CNN, FOX, ESPN, NBC, HBO, A&E, AMC, FAM, MAX, MTV, SHOW, TBS, USA, TNT, CBC, UPN, CTV, WB, TSN, DSC, GLOB

- When selecting the caption, press and hold [▲,▼] to scroll up and down the screen.

5 Press [▲,▼] to select the channel corresponding to the caption and press [◀].

- Channels are only displayed if they contain a station and if captions have not been added manually.
- To delete the channel number, press [CANCEL].

Repeat steps 4 and 5 to enter other channels.

6 Press [ENTER].

3 Press [▲,▼] to select “Manual Channel Captions” and press [ENTER].

4 Press [▲,▼] to select the channel and press [▶].

- Channels are only displayed if they contain a station and if preset captions have not been added.

5 Press [▲,▼] to select the first character and press [▶].

- You can choose from the following characters:
A–Z, 0–9, -, &, !, /, (space)
- To delete the caption, press [CANCEL].
- Repeat this step to enter the other characters.

6 Press [◀,▶] to return to the “Channel Number” column.

Repeat steps 4–6 to enter other channels.

7 Press [ENTER].

To exit the screen

Press [SETUP].

To return to the previous screen

Press [RETURN].

Do the following if you connect a progressive television or if you connect a different type of television after choosing a type during initial setup just after turning the unit on for the first time. Select the item that matches your television.

1 While stopped
Press [SETUP].

2 Press [▲,▼] to select “TV Screen” and press [▶].

3 Press [▲,▼] to select “TV Type” and press [ENTER].

- 480p/480i:
Select “480p” if the television is compatible with progressive output.

4 Press [▲,▼] to select the item and press [ENTER].

To exit the screen

Press [SETUP].

To return to the previous screen

Press [RETURN].

Remote control settings

Refer to the control reference on page 14.

Television operation

You can operate the TV through the unit's remote control.

Point the remote control at the television

While pressing [⏻ POWER TV], enter the code with the numbered buttons.

e.g., 0250: [0] → [2] → [5] → [0]

Manufacturer and Code No.

Panasonic	0051/0250	PHILIPS (RC-5)	0054
National		RCA	0047
QUASAR		SAMSUNG	0060/0587/ 0702
FISHER	0154	SANYO	0154
GE	0047	SHARP	0093/0165
GOLDSTAR	0178/0317/ 0457	SONY	0000
HITACHI	0145	SYLVANIA	0054
JVC	0053	THOMSON	0047
LG	0178/0317/ 0457	TOSHIBA	0156
MAGNAVOX	0054	ZENITH	0017
mitsubishi	0150		

Test by turning on the television and changing channels. Repeat the procedure until you find the code that allows correct operation.

- If your television brand is not listed or if the code listed for your television does not allow control of your television, this remote control is not compatible with your television.

When other Panasonic products respond to this remote control

When other Panasonic products placed nearby affect this unit's remote control, change the remote control code on the main unit and the remote control (the two must match).

Use "1", the factory set code, under normal circumstances.

To change the code on the main unit

- 1 While stopped**
Press [SETUP].
- 2 Press [▲,▼] to select "Setup" and press [▶].**
- 3 Press [▲,▼] to select "Remote Control Code" and press [ENTER].**
- 4 Press [▲,▼] to select the code ("1", "2" or "3") and press [ENTER].**



To change the code on the remote control

- 5 While pressing [ENTER], press and hold the numbered button ([1], [2] or [3]) for more than 2 seconds.**
- 6 Press [ENTER].**

- **When the following indicator appears on the unit's display**



Press and hold [ENTER] and the indicated number button at the same time for more than 2 seconds.

To exit the screen

Press [SETUP].

To return to the previous screen

Press [RETURN].

Clock settings

Refer to the control reference on page 14.

Set Clock Manually

In the case of a power failure, the clock setting remains in memory for approximately 1 minute.

- 1 While stopped**
Press [SETUP].
- 2 Press [▲,▼] to select "Setup" and press [▶].**
- 3 Press [▲,▼] to select "Clock Settings" and press [ENTER].**
- 4 Press [▲,▼] to select "Set Clock Manually" and press [ENTER].**

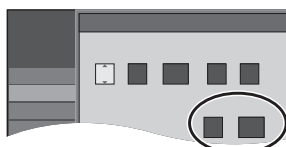

DST, Time Zone (→ below)

- 5 Press [◀,▶] to select the item you want to change and press [▲,▼] to change the setting.**
 - DST (Daylight Saving Time): On or Off
If you select "On", the clock is advanced one hour starting at 2 a.m. on the first Sunday in April and ending at 2 a.m. on the last Sunday in October.
 - Time Zone shows the time difference from Greenwich Mean Time (GMT).
 - EST (Eastern Standard Time) = GMT -5
 - CST (Central Standard Time) = GMT -6
 - MST (Mountain Standard Time) = GMT -7
 - PST (Pacific Standard Time) = GMT -8
 - AST (Alaska Standard Time) = GMT -9
 - HST (Hawaii Standard Time) = GMT -10

- 6 Press [ENTER].**

The clock starts.

Adjust Time Zone

Adjust the time zone (-1 or +1) if it was not set correctly with auto clock setting.

You can set this menu only after "Set Clock Automatically" is completed.

- 1 While stopped**
Press [SETUP].
- 2 Press [▲,▼] to select "Setup" and press [▶].**
- 3 Press [▲,▼] to select "Clock Settings" and press [ENTER].**
- 4 Press [▲,▼] to select "Adjust Time Zone" and press [ENTER].**
- 5 Press [▲,▼] to select "-1" or "+1" and press [ENTER].**

To exit the screen

Press [SETUP].

To return to the previous screen

Press [RETURN].

DVD-R DL,
re-writable DVD-RAM.

35).
After recording or copying titles to them. You can then play
them. After recording or copying titles to them, the discs become play-only and you can no longer record or
erase on that DVD-RW.



For other DVD equipment, please use "Create DVD Top Menu" in DVD Management menu

DVD-R DL and +R DL discs have two layers of recording surface on one side.
It is not possible to record continuously from the first layer to the second layer. Recording stops when
space on the first layer becomes full. You must close the first layer to start recording on the second layer.
Closing makes the first layer unavailable for recording (editing is still available). You cannot cancel closing.
Make certain before proceeding.

Recording modes and approximate recording times

Depending on the content being recorded, the recording times may become shorter than indicated.

Recording Mode	DVD-RAM		DVD-R, DVD-RW, +R, +RW 4.7 GB
	4.7 GB	9.4 GB (Double-sided*1)	
XP (High picture quality)	1 h.	2 h.	1 h.
SP (Standard)	2 h.	4 h.	2 h.
LP (Long recording)	4 h.	8 h.	4 h.
EP (Extra long recording)	8 h. (6 h.*2)	16 h. (12 h.*2)	8 h. (6 h.*2)
FR (Flexible Recording)	8 h. maximum	8 h. maximum for one side	8 h. maximum

Recording Mode	DVD-R DL, +R DL*3 8.5 GB	
	First layer (L0)	Second layer (L1)
XP (High picture quality)	55 min.	50 min.
SP (Standard)	1 h. 50 min.	1 h. 40 min.
LP (Long recording)	3 h. 40 min.	3 h. 20 min.
EP (Extra long recording)	7 h. 25 min. (5 h. 30 min.*2)	6 h. 50 min. (5 h. 15 min.*2)
FR (Flexible Recording)	7 h. 25 min. maximum	6 h. 50 min. maximum

*1 It is not possible to record or play continuously from one side of a double sided disc to the other.
 *2 When "Recording Time in EP Mode" is set to "EP - Extended Play (6H)" in the Setup menu (→ page 37). The sound quality is better when using "EP - Extended Play (6H)" than when using "EP - Extended Play (8H)".
 *3 It is not possible to record continuously from the first layer to the second layer.

- This unit uses variable bit rate (VBR) recording which varies the amount of data recorded to suit the images, so actual recording times and remaining recording times shown by the unit will be different. (The difference will be especially noticeable with DVD-R DL and +R DL.) Use a disc with plenty of remaining time.
- When recording to DVD-RAM using EP (8H) mode, play may not be possible on DVD players that are compatible with DVD-RAM. Use EP (6H) mode if playback may be on other equipment.

FR (Flexible Recording)

The unit automatically selects a recording rate between XP and EP (8H) that will enable the recordings to fit in the remaining disc space with the best possible recording quality.

- You can use FR mode in Scheduled recording (→ page 20, step 3) and Flexible recording (→ page 19).

Using "FR mode" is convenient in these kind of situations

- When the amount of free space on the disc makes selecting an appropriate recording mode difficult
 - When you want to record a long program with the best picture quality possible
- e.g., Recording a 90 minutes program to disc

If you select XP mode
<p>The program will not fit one disc.</p> <div style="text-align: center;"> </div>
If you select SP mode
<p>The program will fit one disc.</p> <div style="text-align: center;"> </div>
If you select FR mode
<p>The program will fit one disc perfectly.</p> <div style="text-align: center;"> </div>

Disc Insertion/Ejection

When the format confirmation screen is displayed

When you insert a new disc and a disc recorded on a computer or other equipment, a format confirmation screen might be displayed. Format the disc to use it. However all the recorded contents are deleted.

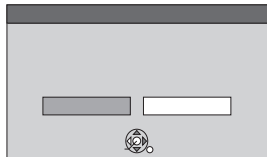

Press [◀▶] to select "Yes" and press [ENTER].

- Several steps are necessary to format a disc. Refer to "Deleting all contents of a disc -Format Disc (DVD)" (→ page 34).

When remove a recorded disc

When you press [▲ OPEN/CLOSE] on the main unit while stopped: The following screen appears when you have not processed the disc for play on other equipment.

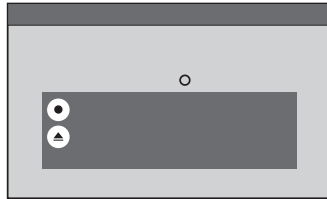

■ When finalizing the disc

- Press [● REC].
- You cannot stop this process once you have started it.
 - If you want to provide the disc with a name or set play menu select, select "Disc Name" (→ page 34) or "Playback will start with." (→ page 35) in "DVD Management" before finalizing.

■ When opening the tray without disc finalization

Press [▲ OPEN/CLOSE] on the main unit.

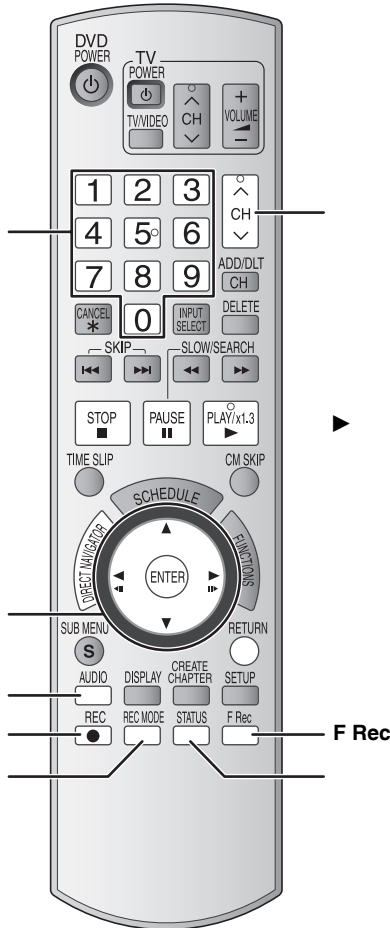
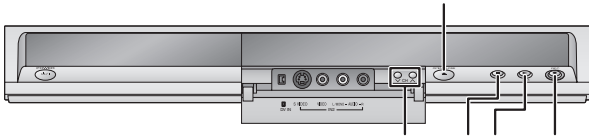

- You can record up to 99 titles on one disc.
- You can record up to 49 titles on one disc.

See also the notes “Important notes for recording” (→ page 16).

- You can create a Top Menu using “Create DVD Top Menu” (→ page 35). Recording or editing on the disc may delete the menu. In that case, create the menu again.
- It is not possible to record continuously from one side of a double sided disc to the other. You will need to eject the disc and turn it over.

Preparation

- Turn on the television and select the appropriate video input to suit the connections to this unit.
- Turn the unit on.

Off Timer

The unit switches to standby after about 6 hours in the stop mode. You can turn this feature off or change the time to 2 hours (→ page 36, “Off Timer”).

1 Press [**▲ OPEN/CLOSE**] on the main unit to open the tray and insert a disc.

- Press the button again to close the tray.
- When using 8 cm (3”) DVD-RAM, or 8 cm (3”) DVD-R, remove the disc from the cartridge.

2 Press [**^ ∨ CH**] to select the channel.

To select with the numbered buttons:

3 Press [**REC MODE**] to select the recording mode (XP, SP, LP, or EP).

- Select the audio to record (→ page 19).

4 Press [**● REC**] to start recording.

The elapsed time is shown on the display.

Recording will take place on free space on disc. Data will not be overwritten.

- You cannot change the channel or recording mode during recording. You can change the channel or recording mode while paused; however, the recording will then be as a separate title.
- You can record while the unit is in standby for scheduled recording, but once the time for the scheduled recording to begin is reached, any recording taking place will stop and the scheduled recording will begin.

■ To pause recording

Press [**||**].

Press again to restart recording.

You can also press [**● REC**] to restart.

(Title is not split into separate titles.)

■ To stop recording

Press [**■**].

- From the start to the end of the recording is called one title.

- It takes about 30 seconds for the unit to complete recording management information after recording finishes.

■ When recording the channel (not set on this unit) from cable box or satellite receiver

- ① Select the channel on the equipment before turning the unit on.
- ② Press [**^ ∨ CH**] to select IN1 or IN2 in step 2 (→ above).

To specify a time to stop recording –One Touch Recording

During recording

Press [● REC] to select the recording time.

- The unit's display changes as shown below.

OFF 0:30 → OFF 1:00 → OFF 1:30 → OFF 2:00
 ↑ Counter (cancel) ← OFF 4:00 ← OFF 3:00 ←

- This does not work during scheduled recordings (→ page 20) or while using Flexible Recording (→ below).
- If you change the channel or recording mode while recording is paused, the time specified to stop recording is cancelled.
- The unit turns off automatically after the time to stop recording is reached.

To cancel

Press [● REC] several times until the counter appears.

- The time to stop recording is cancelled; however, recording continues.

To stop recording partway

Press [■].

Flexible Recording

(Recording that fits the remaining disc space)

The unit sets the best possible picture quality that fits the recording within the remaining disc space. The recording mode becomes FR mode. Refer to "FR (Flexible Recording)" (→ page 17).

Preparation

Select the channel or the external input (IN1, IN2 or DV) to record.

1 While stopped

Press [F Rec].

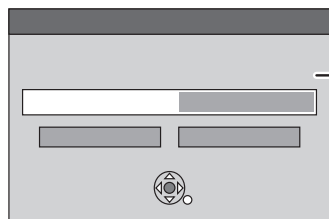

Maximum recording time
 This is the maximum recording time in FR mode.

2 Press [◀▶] to select "Hour" and "Min." and press [▲▼] to set the recording time.

- You can also set the recording time with the numbered buttons.
- You cannot record for more than 8 hours.

3 When you want to start recording

Press [▲▼, ▶▶] to select "Start" and press [ENTER].

Recording starts.

To exit the screen without recording

Press [RETURN].

e.g., DVD-RAM

To stop recording partway

Press [■].

To show the remaining time

Press [STATUS].

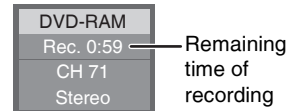

Playing while you are recording

Playing from the beginning of the title you are recording–Chasing playback

Press [▶] (PLAY) during recording.

- There is no sound output while searching forward or backward.

To stop play

Press [■].

To stop recording

2 seconds after play stops

Press [■].

To stop scheduled recording

- Press [■] to stop playing.
- After 2 seconds, press [■].
- Press [◀▶] to select "Stop recording" and press [ENTER].

Playing a title previously recorded while recording–Simultaneous rec and play

1 Press [DIRECT NAVIGATOR] during recording.

2 Press [▲, ▼, ▶, ◀] to select a title and press [ENTER].

- There is no sound output while searching forward or backward.

To stop play

Press [■].

To stop recording

- Press [■] to stop playing.
- Press [DIRECT NAVIGATOR] to exit screen.
- Press [■].

To stop scheduled recording

- Press [■] to stop playing.
- Press [DIRECT NAVIGATOR] to exit screen.
- Press [■].
- Press [◀▶] to select "Stop recording" and press [ENTER].

Selecting audio to record

Press [AUDIO].

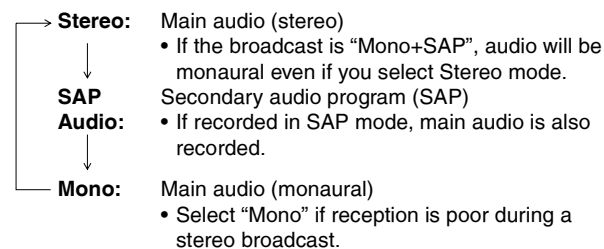

e.g., "Stereo" is selected



"(" appears when the unit is receiving the audio type you selected.

- If you change the sound setting while recording, the recorded sound will also change.

Select the audio (Main or SAP) in "Multi-channel TV Sound (MTS)" in the Setup menu (→ page 38).

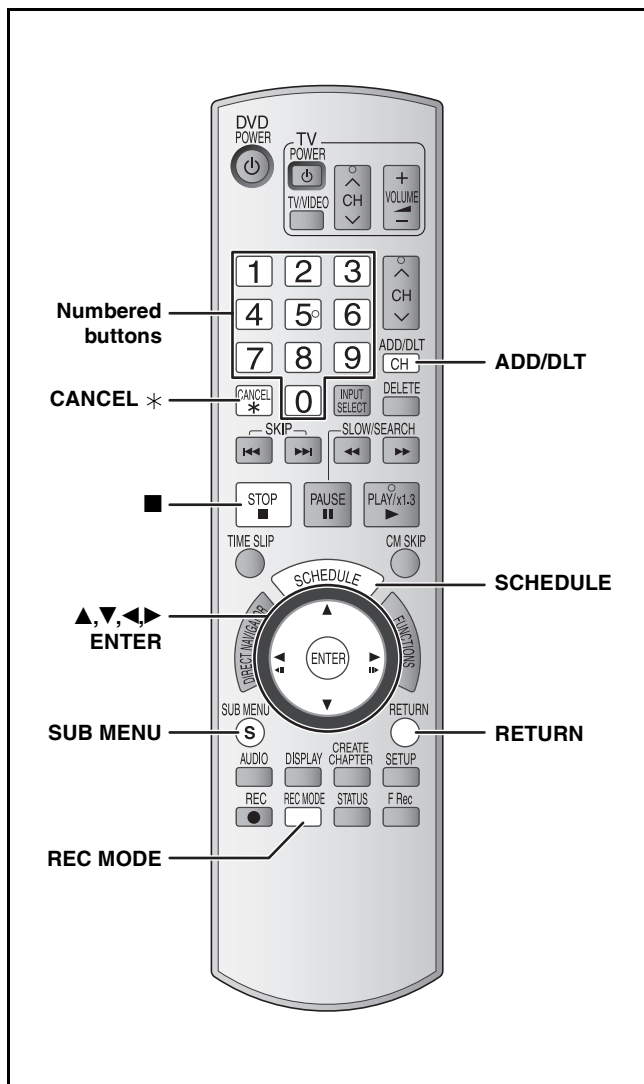

See also the notes “Important notes for recording” (→ page 16).

You can enter up to 16 programs up to a month in advance. (Each daily or weekly program is counted as one program.)

Preparation

- Turn on the television and select the appropriate video input to suit the connections to this unit.
- Check that the time on the unit is correct.
- Insert a disc (→ page 18).

1 Press [SCHEDULE].

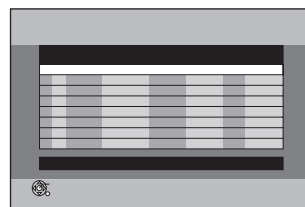

2 Press [▲,▼] to select “New Scheduled Recording” and press [ENTER].



3 Press [▶] to move through the items and change the items with [▲,▼].



- Press and hold [▲,▼] to alter On (Start time) and Off (Finish time) in 30-minute increments.
- You can also set Channel, Date, On (Start time), and Off (Finish time) with the numbered buttons.
- You can also press [REC MODE] to change the recording mode.

■ To set daily or weekly timer

Press [◀▶] to select “Date” and [▲,▼] to select daily timer or weekly timer.

→ Date: Current date up to one month later minus one day
 ↓↑
 Daily timer: Sun-Sat → Mon-Sat → Mon-Fri
 ↓↑
 Weekly timer: Weekly, Sun → --- → Weekly, Sat

■ To enter title name

Press [◀▶] to select “Title Name” and press [ENTER] (→ page 33, Entering text).

4 Press [ENTER].



When “1” appears, make sure the disc has a sufficient space.

“1” lights on the unit’s display to indicate scheduled recording standby has been activated.

- Repeat steps 2–4 to schedule other recordings.

When the disc is removed, scheduled recording standby is cancelled (the “1” indicator goes out). You can put the unit back on standby by inserting a recordable disc (the “1” lights on again).

■ To return to the previous screen

Press [RETURN].

■ To exit the screen

Press [SCHEDULE].

■ When recording the channel (not set on this unit) from cable box or satellite receiver

- ① Press [▲,▼] to select IN1 or IN2 in the channel column (→ above, step 3).
- ② Select the channel on the equipment before the scheduled time.

Cancel scheduled recording that has already begun

- 1 When the unit is on
Press [■].
The confirmation screen appears.
- 2 Press [◀,▶] to select “Stop recording” and press [ENTER].
Recording stops and the scheduled recording is cancelled.
(Daily and weekly schedules remain and scheduled recording will start as programmed.)

Release program from recording standby

- 1 Press [SCHEDULE].
- 2 Press [▲,▼] to select the program and press [SUB MENU].
- 3 Press [▲,▼] to select “Schedule set to Off” and press [ENTER].
Cancelled icon is displayed in left column.

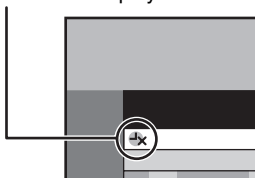

- Be sure to select “Schedule set to On.” in step 3 before the scheduled time to put the program on recording standby.

Notes on scheduled recording

- “Ⓞ” flashes on the unit’s display for about 5 seconds when the unit cannot go to scheduled recording standby (e.g., a recordable disc is not in the disc tray).
- Scheduled recordings begin when the set time is reached even when recording or when playing.
- If the unit is turned on when scheduled recording begins, it remains turned on after recording finishes. It does not turn off automatically. You can turn the unit off during scheduled recording.
- If you are making consecutive recordings that will start one after the other, the beginning of the later program cannot be recorded.

e.g., Program① 10:00–11:00
Program② 11:00–12:00

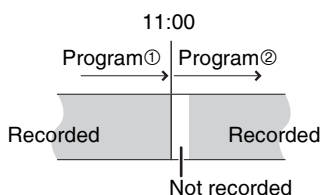

- If the actual broadcasting times of scheduled recordings overlap, the recording that starts first always has priority, and the recording of the later program will start only after the first scheduled recording has finished.
- If you set DST (Daylight Saving Time) to On when manually setting the clock (→ page 15), scheduled recording may not work when summer switches to winter and vice versa.

Check, change or delete a program

Even when the unit is turned off, you can display the schedule list by pressing [SCHEDULE].

Press [SCHEDULE].

Icons

- This program is currently recording.
- Ⓞ The times overlap those in another program.
- ✕ Scheduled recording standby is cancelled. Recording will not start at the scheduled time.
- ⊖ You stopped a weekly or daily scheduled recording. The icon disappears the next time the scheduled program starts recording.
- Ⓛ The disc was full so the program failed to record.
- Ⓜ The material was copy-protected so it was not recorded.
- Ⓧ The program did not complete recording because the disc is dirty or for some other reason.

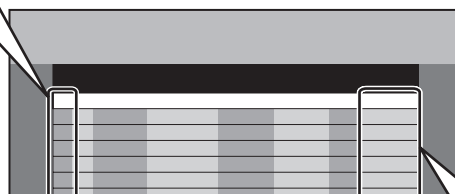

Message displayed in the Check line

- OK:** Displayed if the recording can fit in the remaining space.
- **(Date):** For recordings made daily or weekly, the display will show until when recordings can be made (up to a maximum of one month from the present time) based on the time remaining on the disc.
- !:** It may not be possible to record because:
 - no disc is inserted
 - the disc is write-protected
 - there is no more space left
 - the number of possible titles has reached its maximum
 - scheduled recording standby is cancelled
- Overlap:** The times overlap those in another program. Recording of the program with the later start time starts when the earlier program finishes recording.

■ To change a program

Press [▲,▼] to select the program and press [ENTER] (→ page 20, step 3).

- During scheduled recording, you can change the end time as long as the recording mode is not “FR”.

■ To delete a program

Press [▲,▼] to select the program and press [CANCEL *] or [ADD/DLT].

■ To cancel recording that has already begun





Press [▲,▼] to select program and press [SUB MENU], then press [ENTER].

■ To exit the schedule list

Press [SCHEDULE].

- Programs that failed to record are displayed gray, and cannot be changed. They are automatically deleted from the schedule list at 4 a.m. two days later.

Operations during play

<p>Stop</p>	<p>Press [■]. The stopped position is memorized. Resume play function Press [▶] (PLAY) to restart from this position.</p> <ul style="list-style-type: none"> • [■] Depending on the disc, resume play function may not be effective. • The stopped position is cleared when: <ul style="list-style-type: none"> – You press [■] several times. – You open the tray. – [■] [■] [■] You turn the unit off.
<p>Pause</p>	<p>Press []. Press again or press [▶] (PLAY) to restart play.</p>
<p>Search</p>	<p>Press [◀◀] or [▶▶].</p> <ul style="list-style-type: none"> • The speed increases up to 5 steps ([■] [■] [■] up to 3 steps). • Press [▶] (PLAY) to restart play. • Audio is heard during first level search forward. <ul style="list-style-type: none"> [■] (excluding motion picture parts) [■] Audio is heard during all levels of search. • Depending on the disc, searching may not be possible.
<p>Skip</p>	<p>During play or while paused, press [◀◀] or [▶▶]. The unit will skip titles, chapters, or tracks according to the number of times the button is pressed and play will begin.</p>
<p>Starting from a selected item</p>	<p>Press the numbered buttons. Play starts from the selected title, chapter or track.</p> <p>e.g., 5: [0] → [5] [■] (MP3, JPEG/TIFF) 5: [0] → [0] → [5] 15: [1] → [5] 15: [0] → [1] → [5]</p> <p>[■] Selecting groups While stopped (screen saver is displayed on the television → right)</p> <p>5: [5]</p>  <ul style="list-style-type: none"> • This works only when stopped (screen saver is displayed on the television → above) with some discs. • [■] (with playback control) • If you press the numbered buttons while stopped (the above screen saver is displayed on the television) you can cancel PBC. (Elapsed play time appears on the unit's display.)
<p>Quick View [■]</p>	<p>Press and hold [▶] (PLAY/x1.3). Play speed is quicker than normal.</p> <ul style="list-style-type: none"> • Press again to return to normal speed.
<p>Slow-motion [■] [■] [■] [■] [■] [■] [■] [■] [■] (Motion picture parts only) [■] [■]</p>	<p>While paused, press [◀◀] or [▶▶].</p> <ul style="list-style-type: none"> • The speed increases up to 5 steps. • Press [▶] (PLAY) to restart play. • [■] Forward direction [▶▶] only. • The unit will pause if slow-motion play is continued for approximately 5 minutes (excluding [■] [■] [■]).
<p>Frame-by-frame [■] [■] [■] [■] [■] [■] [■] [■] [■] (Motion picture parts only) [■] [■]</p>	<p>While paused, press [◀] or [▶].</p> <ul style="list-style-type: none"> • Each press shows the next frame. • Press and hold to change forward or backward in succession. • Press [▶] (PLAY) to restart play. • [■] Forward direction [▶] only.
<p>Skipping the specified time (Time Slip) [■] [■] [■] [■] [■] [■] [■] [■]</p>	<p>1 Press [TIME SLIP]. 2 Press [▲, ▼] to select the time and press [ENTER]. Play skips to the specified time.</p> <ul style="list-style-type: none"> • Each time you press [▲, ▼], the time increases [▲] or decreases [▼] by 1 minute intervals. (Press and hold for 10-minute intervals.)
<p>CM Skip [■] [■] [■] [■] [■] [■] [■] [■]</p>	<p>Press [CM SKIP]. Play restarts from approximately a minute later.</p>
<p>Changing audio</p>	<p>Press [AUDIO]. [■] [■] [■]</p> <p>Stereo → Mono L → Mono R  e.g., "Stereo" is selected </p> <ul style="list-style-type: none"> • [■] [■] When playing an SAP broadcast: Main Audio ↔ SAP Audio <p>[■] [■] You can change the audio channel number each time you press the button. This allows you to change things like the soundtrack language.</p>  <p>e.g., [■] English is the selected language (→ page 26, Soundtrack).</p>
<p>Create Chapter [■] (→ page 28, Title/Chapter)</p>	<p>Press [CREATE CHAPTER]. Chapters are divided at the point pressed.</p> <ul style="list-style-type: none"> • Press [◀◀, ▶▶] to skip to the start of a chapter.

Using menus to play MP3 and still pictures (JPEG/TIFF)

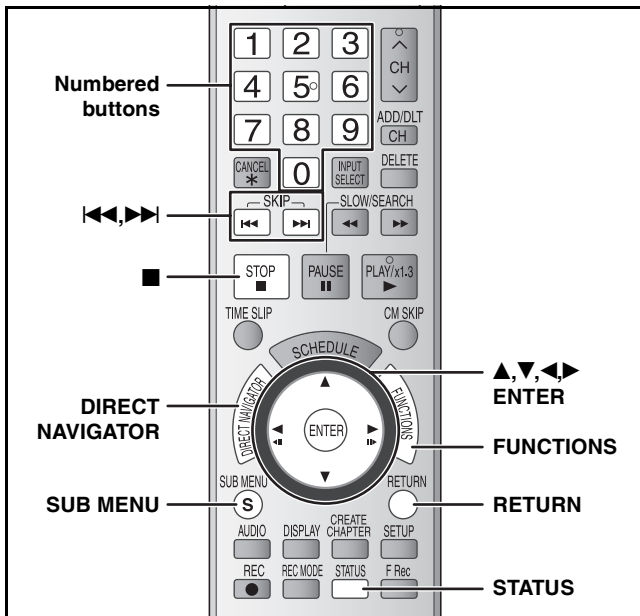

Playing MP3

You can play CD-R, CD-RW discs which contain MP3 files that have been recorded on a computer.

The screen shown at right is displayed when you insert a disc containing MP3 files and still pictures (JPEG/TIFF). Press [ENTER], and follow the steps below.

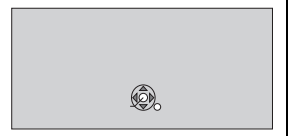

1 Press [DIRECT NAVIGATOR].

G: Group no.
T: Track no. in the group
Total: Track no./Total track no. in all groups

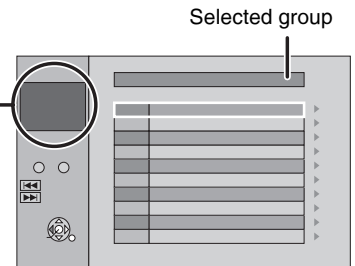

Files are treated as tracks and folders are treated as groups.

2 Press [▲, ▼] to select the track and press [ENTER].

Play starts on the selected track.

- “” indicates the track currently playing.
- You can also select the track with the numbered buttons.
 e.g., 5: [0] → [0] → [5]
 15: [0] → [1] → [5]

To show other pages

Press [◀] (Previous) or [▶] (Next).

To select other group

1 Press [▶].

G: Selected group no. /Total group no.
 If the group has no track, “--” is displayed as group number.

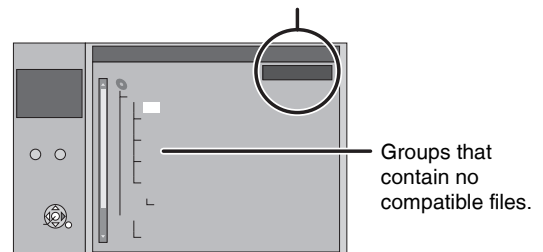

2 Press [▲, ▼] to select a group and press [ENTER].

The file list for the group appears.

Regarding MP3 and still pictures (JPEG/TIFF)

- Compatible formats: ISO9660 level 1 or 2 (except for extended formats) and Joliet
- Maximum number of files (tracks) and folders (groups) recognizable: 999 files* (tracks) and 99 (including the root folder) folders (groups)
- * Total number for all the MP3, JPEG and other type of files
- This unit is compatible with multi-session but reading or play of the disc may take time if there are a lot of sessions.
- Operation may take time to complete when there are many files (tracks) and/or folders (groups) and some may not display or be playable.
- The display order on this unit may differ from how the order is displayed on a computer.
- Depending on how you create the disc (writing software), files (tracks) and folders (groups) may not play in the order you numbered them.
- This unit is not compatible with packet-writing format.
- Depending on the recording, some items may not be playable.

Regarding MP3

- File format: MP3
Files must have the extension “.mp3” or “.MP3”.
- Bit rates: 32 kbps to 320 kbps
- Sampling frequency: 16 kHz/22.05 kHz/24 kHz/32 kHz/44.1 kHz/48 kHz
- This unit is not compatible with ID3 tags.
- If there is a large amount of still picture data etc. within an MP3 file, play may not be possible.

Regarding still pictures (JPEG/TIFF)

- File format: JPEG, TIFF (non-compressed RGB chunky format)
Files must have the extension “.jpg”, “.JPG”, “.tif” and “.TIF”.
- Number of pixels: between 34 x 34 and 6144 x 4096 (Sub sampling is 4:2:2 or 4:2:0)
- This unit cannot play images that have resolutions beyond the range shown.
- Operation may take time to complete when playing TIFF format still pictures.
- The unit is not compatible with MOTION JPEG.

You can play MP3 and still pictures (JPEG/TIFF) on this unit by making folders as shown below. However, depending on how you create the disc (writing software), play may not be in the order you numbered the folders.

When the highest level folders are “DCIM” folders, they are displayed first on the tree.

Structure of MP3 folders

Prefix with 3-digit numbers in the order you want to play them.

Structure of still pictures (JPEG/TIFF)

Files inside a folder are displayed in the order they were updated or taken.

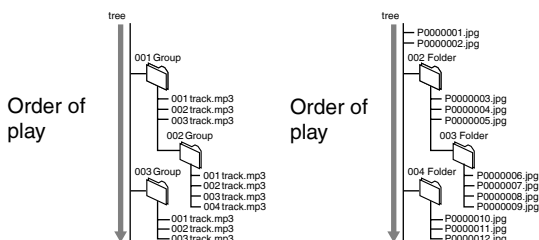

Playing still pictures (JPEG/TIFF)

You can play CD-R, CD-RW discs which contain still pictures (JPEG/TIFF) that have been recorded on a computer.

The screen shown at right is displayed when you insert a disc containing MP3 files and still pictures (JPEG/TIFF).



■ To select Pictures Menu

- 1 Press [RETURN].
- 2 Press [FUNCTIONS].
- 3 Press [▲,▼] to select "Menu" and press [ENTER].
- 4 Press [▲,▼] to select "Pictures" and press [ENTER].
→below, step2

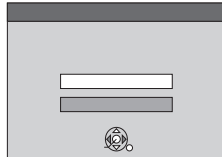

1 Press [DIRECT NAVIGATOR].

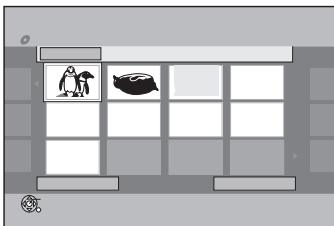

- Thumbnails for large JPEG files and images with aspect ratios other than 4:3 may not display.

2 Press [▲,▼,◀,▶] to select the still picture and press [ENTER].

- The selected still picture is displayed on the screen.
- You can also select still pictures with the numbered buttons.

e.g., 5: [0] → [0] → [5]
15: [0] → [1] → [5]

To show other pages

Press [◀◀] (Previous) or [▶▶] (Next).

■ To select another folder

While the Pictures Menu is displayed

- 1 Press [▲,▼,◀,▶] to select "Folder" and press [ENTER].

2 Press [▲,▼] to select the folder and press [ENTER].

To display the previous or next still picture during play

Press [◀,▶].

To stop playing

Press [■].

- The unit remembers the still picture where you stopped play. This is cleared when you turn the unit off or remove the disc.

To return to the previous screen

Press [RETURN].

To switch to MP3 menu

Select "MP3 Music" in step 4 of "To select Pictures Menu" (→ above).

To exit the menu screen

Press [DIRECT NAVIGATOR].

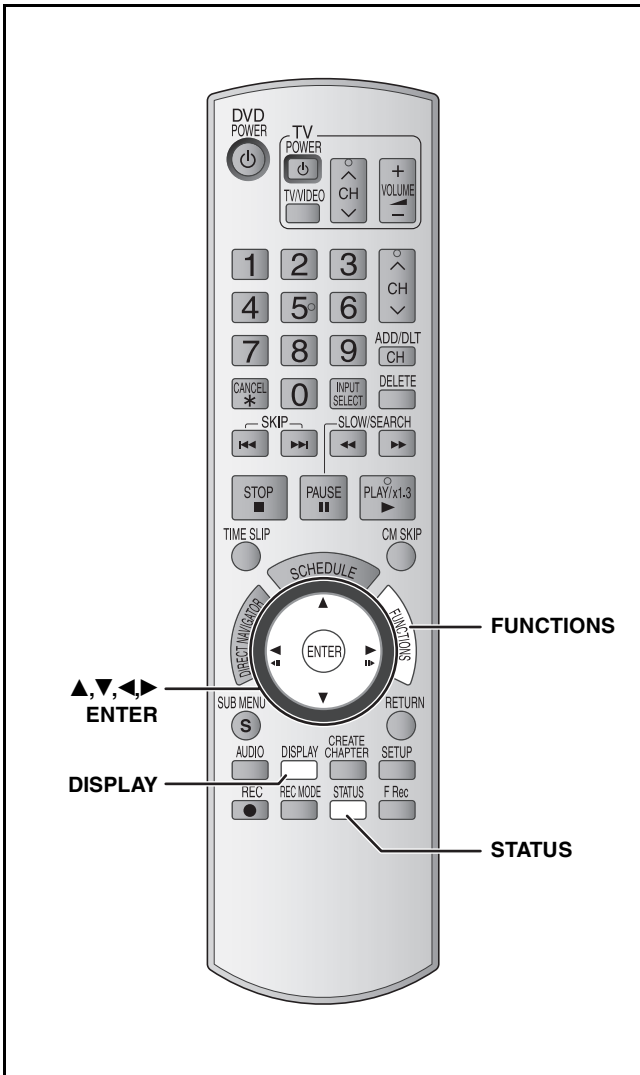

Using on-screen menus

Common procedures

1 Press [DISPLAY].



• Depending on the condition of the unit (playing, stopped, etc.) and disc contents, there are some items that you cannot select or change.

2 Press [▲, ▼] to select the menu and press [▶].

3 Press [▲, ▼] to select the item and press [▶].

4 Press [▲, ▼] to select the setting.

• Some items can be changed by pressing [ENTER].

To clear the on-screen menus

Press [DISPLAY].

Disc menu—Setting disc content

Soundtrack* [] []

Select the audio and language (→ below, Audio attribute, Language).

[] [] [] [] [] [] [] [] [] []

The disc's audio attributes appear.

Subtitle* [] []

Turn the subtitle on/off and select the language (→ below, Language).

[] [] [] [] [] [] [] [] [] []

(Only discs that contain subtitle on/off information)

- Subtitle on/off information cannot be recorded using this unit.
- If the subtitles overlap closed captions recorded on discs, turn the subtitles off.

Audio channel [] [] []

→ page 23, Changing audio

Angle* [] []

Change the number to select an angle.

Still-P (Still picture) []

Selects the play method for still pictures.

Slide Show: Plays according to the default order on the disc.

Page: Select the still picture number and play.

- RANDOM: Plays in random order.
- Return: Returns to the default still picture on the disc.

PBC (Playback control → page 44) []

Indicates whether menu play (playback control) is on or off (unchangeable).

* With some discs, you may only be able to make changes using the menus (→ page 22) on the disc.

- The display changes according to the disc content. You cannot change anything when there is no recording.

Audio attribute

LPCM/PPCM/□□ Digital/DTS/MPEG:	Signal type
k (kHz):	Sampling frequency
b (bit):	Number of bits
ch (channel):	Number of channels

Language

ENG: English	DAN: Danish	THA: Thai
FRA: French	POR: Portuguese	POL: Polish
DEU: German	RUS: Russian	CES: Czech
ITA: Italian	JPN: Japanese	SLK: Slovak
ESP: Spanish	CHI: Chinese	HUN: Hungarian
NLD: Dutch	KOR: Korean	FIN: Finnish
SVE: Swedish	MAL: Malay	*: Others
NOR: Norwegian	VIE: Vietnamese	

Play menu—Change play sequence

This function works only when the elapsed play time is displayed. Select the item for repeat play. Depending on the disc, the items that can be selected will differ.

Repeat play

- All [] (excluding MP3 discs) []
 - Chapter [] [] [] [] [] [] [] [] [] []
 - Group [] [] (MP3 discs only)
 - Playlists [] []
 - Title [] [] [] [] [] [] [] [] [] []
 - Track [] [] [] []
- Select "Off" to cancel.

Video menu—Change picture quality

Picture



Select the picture mode.

- **Normal:** Default setting
- **Soft:** Soft picture with fewer video artifacts
- **Fine:** Details are sharper
- **Cinema:** Mellows movies, enhances detail in dark scenes.

DNR



Reduces noise and picture degradation.
On↔Off

Progressive

[Only when you have selected “480p” in “TV Type” (→ page 14).]

- Select “On” to enable progressive output.
- Select “Off” if the picture is stretched horizontally.
 - When progressive output is on, closed captions cannot be displayed.

Transfer [Only when “Progressive” (→ above) is set to “On”.]

Select the method of conversion for progressive output to suit the type of material being played (→ page 44, Film and video).

- **Auto1 (normal):** Automatically detects the film and video content, and appropriately converts it.
- **Auto2:** In addition to “Auto1”, automatically detects film contents with different frame rates and appropriately converts it.
- **Video:** Select when using “Auto1” and “Auto2”, and the video content is distorted.

Line-in NR (Only when IN1, IN2 or DV is selected.)

Reduces video tape noise while copying.
Depending on the video signal, jittering may occur.

- **Automatic:** Noise reduction only works on picture input from a video tape.
- **On:** Noise reduction works for any video input.
- **Off:** Noise reduction is off. Select when you want to record input as it is.

Audio menu—Change sound effect

V. Surround Sound



(Dolby Digital, 2-channel or over only)

Enjoy a surround-like effect if you are using two front speakers only.

- Turn V. Surround Sound off if it causes distortion.
- Turn off the surround function on the connected equipment.
- V. Surround Sound does not work for SAP recordings.

Dialog Enhancer



(Dolby Digital, 3-channel or over only, including a center channel)

The volume of the center channel is raised to make dialog easier to hear.

Other menu—Change the display position

Position

1 (Standard) - 5: The higher the setting the lower the screen moves.

FUNCTIONS window

By using the FUNCTIONS window you may access the main functions quickly and easily.

- 1 While stopped
Press [FUNCTIONS].

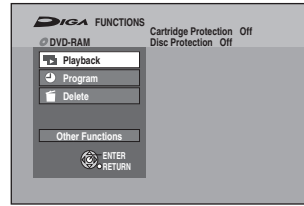

Functions displayed depend on the type of disc.

- 2 Press [▲,▼] to select an item and press [ENTER].

- If you select “Other Functions”, press [▲,▼] to select an item and press [ENTER].

To exit the FUNCTIONS window

Press [FUNCTIONS].

Status messages

Status messages appear on the television during operation to show the condition of the unit.

Press [STATUS].

The display changes each time you press the button.

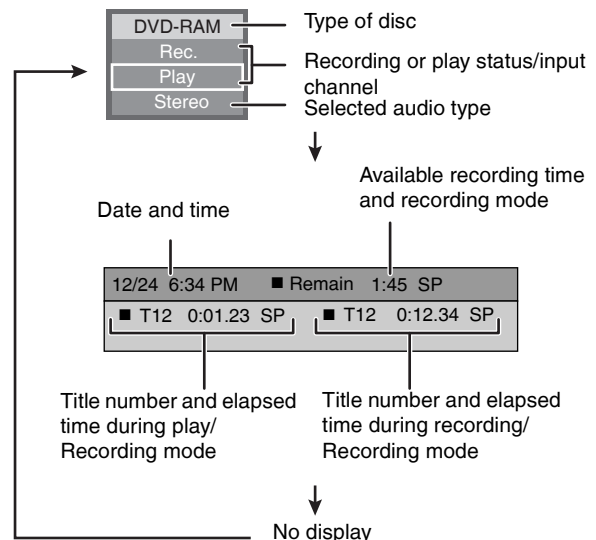

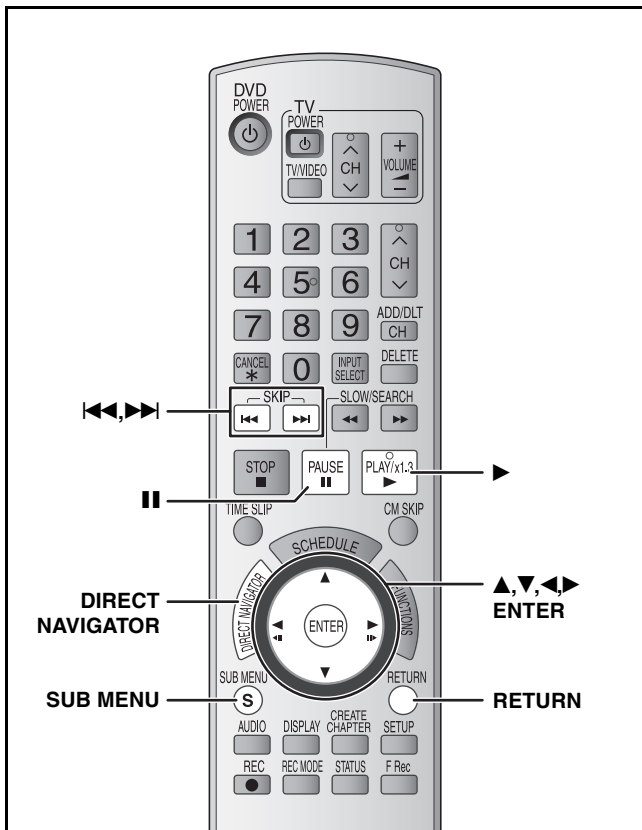

Title/Chapter

Programs are recorded as a single title consisting of one chapter.

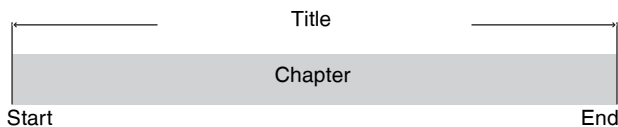

You can divide a title into multiple chapters. (→ page 23, 29, Create Chapter)

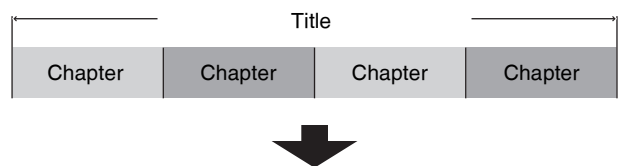

You can change the order of chapters and create a playlist (→ page 30).

- Titles are divided into about 5-minute (8-minute) chapters after finalizing (→ page 35).
- The maximum number of items on a disc:
 - Titles: 99 (49 titles)
 - Chapters: Approximately 1000 (Approximately 254) Depends on the state of recording.

- Once deleted, divided or shortened, a title cannot be restored to its original state. Make certain before proceeding.
- You cannot edit during recording.
- You can create a Top Menu using “Create DVD Top Menu” (→ page 35). Recording or editing on the disc may delete the menu. In that case, create the menu again.
- Management information is recorded in unused sections when you edit discs. The available space on these discs decreases each time you edit their contents.

Preparation

- Turn on the television and select the appropriate video input to suit the connections to this unit.
- Turn the unit on.
- Insert a disc (→ page 18).
- Release protection (→ page 34).

Editing titles/chapters and playing chapters

- 1 During play or while stopped
Press [DIRECT NAVIGATOR].
- 2 Press [▲,▼,◀,▶] to select the title.

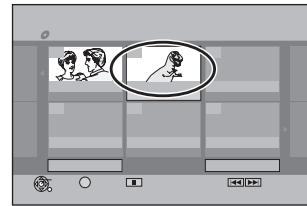

To show other pages

Press [◀] (Previous) or [▶] (Next).

Multiple editing

Select with [▲,▼,◀,▶] and press [■]. (Repeat.)

- A check mark appears. Press [■] again to cancel.

- 3 Press [SUB MENU], then press [▲,▼] to select the operation and press [ENTER].

- If you select “Edit Title”, press [▲,▼] to select the operation and press [ENTER] (→ page 29).

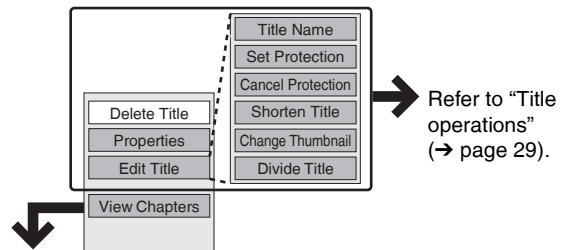

If you select “View Chapters” (→ Step 4)

- 4 Press [▲,▼,◀,▶] to select the chapter.

To start play → Press [ENTER].

To edit → Step 5

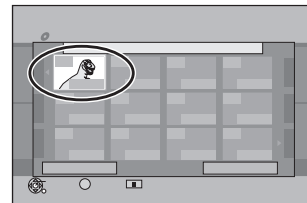

- To show other pages/Multiple editing (→ above)

- 5 Press [SUB MENU], then press [▲,▼] to select the operation and press [ENTER].

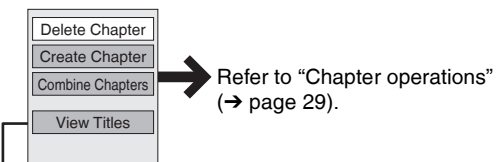

- You can go back to the Title View.

To exit the screen













Press [DIRECT NAVIGATOR].

To return to the previous screen

Press [RETURN].

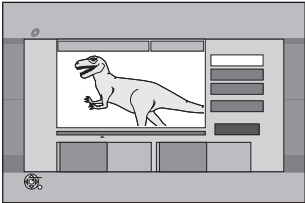
Title operations

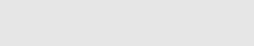
After performing steps 1–3 (→ page 28)

Delete Title* 	<p>Press [◀▶] to select “Delete” and press [ENTER].</p> <ul style="list-style-type: none"> • Once deleted, the recorded contents are lost and cannot be restored. Make certain before proceeding. •  The available recording space does not increase when you delete titles. •  Available recording space increases only when the last recorded title is deleted. It does not increase if other titles are deleted. 	
Properties 	<p>Information (e.g., time and date) is shown.</p> <ul style="list-style-type: none"> • Press [ENTER] to exit the screen. 	
Title Name 	<p>You can give names to recorded titles. → page 33, Entering text</p>	
Set Protection* Cancel Protection* 	<p>If set, this will protect the title from accidental deletion.</p> <p>Press [◀▶] to select “Yes” and press [ENTER].</p> <p>The lock symbol appears when the title is protected.</p>	
Shorten Title  (→ below, “For quicker editing”)	<p>You can remove unnecessary parts of the recording such as commercials.</p> <ol style="list-style-type: none"> ① Press [ENTER] at the start point and end point of the section you want to delete. ② Press [▲,▼] to select “Exit” and press [ENTER]. Select “Next” and press [ENTER] to delete other sections. ③ Press [◀▶] to select “Delete” and press [ENTER]. 	
Change Thumbnail  (→ below, “For quicker editing”)	<p>You can change the image to be shown as a thumbnail picture in the Title View.</p> <ol style="list-style-type: none"> ① Press [▶] (PLAY) to start play. ② Press [ENTER] when the image you want to use as a thumbnail is shown. To change the thumbnail Restart play and press [▲,▼] to select “Change”, then press [ENTER] at the point you want to use as the thumbnail. ③ Press [▲,▼] to select “Exit” and press [ENTER]. 	
Divide Title  (→ below, “For quicker editing”)	<p>You can divide a title into two.</p> <ol style="list-style-type: none"> ① Press [ENTER] at the point you want to divide the title. ② Press [▲,▼] to select “Exit” and press [ENTER]. ③ Press [◀▶] to select “Divide” and press [ENTER]. <p>To confirm the division point Press [▲,▼] to select “Preview” and press [ENTER]. (The unit plays 10 seconds before and after the division point.)</p> <p>To change the division point Restart play and press [▲,▼] to select “Divide”, then press [ENTER] at the point you want to divide.</p> <ul style="list-style-type: none"> • The divided titles retain the name and CPRM property (→ page 44) of the original title. • Video and audio just before and after the dividing point may momentarily be cut out. Make certain using “Preview” function (→ above) before proceeding. 	

* Multiple editing is possible.

Chapter operations

After performing steps 1–5 (→ page 28)

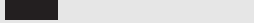
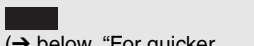
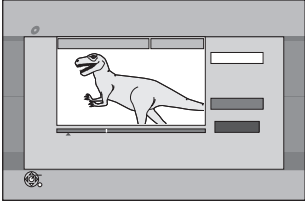
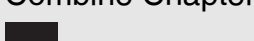
Delete Chapter* 	<p>Press [◀▶] to select “Delete” and press [ENTER].</p> <ul style="list-style-type: none"> • Once deleted, the recorded contents are lost and cannot be restored. Make certain before proceeding. 	
Create Chapter  (→ below, “For quicker editing”)	<p>Select the point where you want to start a new chapter while viewing the title.</p> <ol style="list-style-type: none"> ① Press [ENTER] at the point you want to divide. • Repeat this step to divide at other points. ② Press [▲,▼] to select “Exit” and press [ENTER]. 	
Combine Chapters 	<p>Press [◀▶] to select “Combine” and press [ENTER].</p> <ul style="list-style-type: none"> • The selected chapter and following chapter are combined. 	

* Multiple editing is possible.

For quicker editing

- Use search, Time Slip or slow-motion (→ page 23) to find the desired point.
- To skip to the start or end of a title, press [◀◀] (start) or [▶▶] (end).

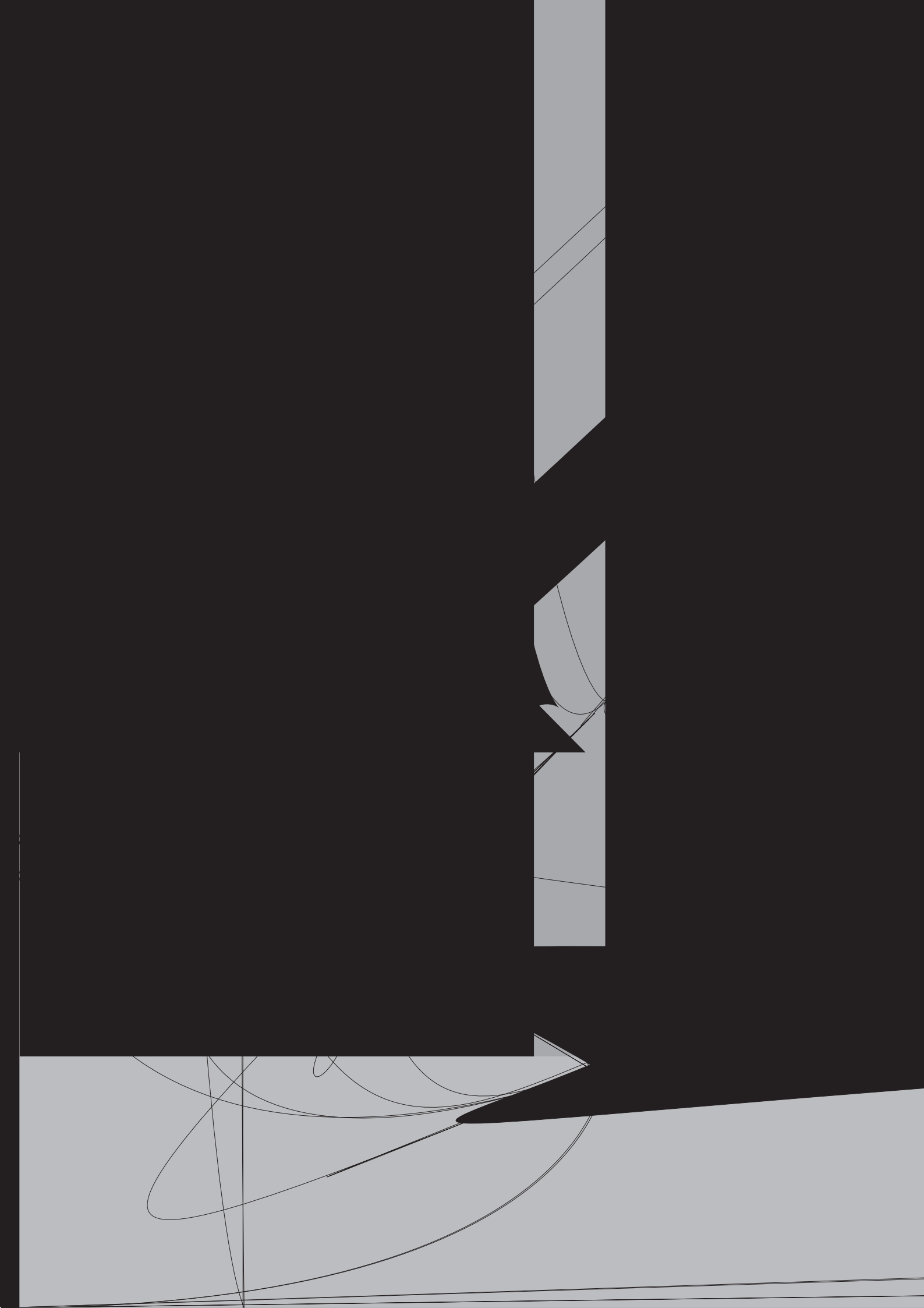

P

D
P

P

C

C

P
N

→ p

→ page



→ p

P

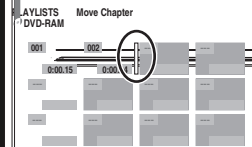

→ page

→ page

Delete
C

→ page

hB

c

To exit the screen
Press [RETURN]

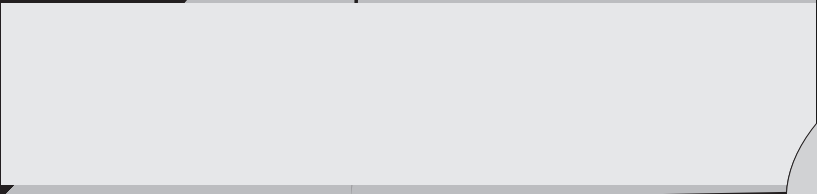

e.g.: Connecting other video equipment to the IN2 or DV IN terminals

You can also connect to the IN1 input terminal on the rear.

- Turn off the unit and other video equipment before connecting.

If the audio output of the other equipment is monaural

Connect to L/MONO.

* The S VIDEO terminal achieves a more vivid picture than the VIDEO terminal.

See also the notes “Important notes for recording” (→ page 16).

Preparation

- Turn on the unit and connected equipment.
- Insert a disc (→ page 18).
- Press [REC MODE] to select the recording mode.
- To reduce noise in input from external equipment, set “Line-in NR” to “On” (→ page 27).
- **When recording from the unit’s DV IN terminal**
Select the type of audio recording from “Select Audio Channel for DV Input” in the Setup menu (→ page 38).
When recording from DV equipment (e.g., digital video camcorder), you can record audio/video recordings from DV tape only.

Entering text

Refer to the control reference on page 32.

You can give names to recorded titles, etc.

The maximum number of characters:

	Characters		Characters
Title	64 (44*)	Title	44
Playlist	64	Disc	40
Disc	64		

* Scheduled recording

If a name is long, parts of it may not be shown in some screens.

1 Show Enter Name screen.

Title (scheduled recording)	(→ page 20, Step 3)
Title	(→ page 28, Step 3)
Playlist	(→ page 31, Step 5)
Disc (→ page 34, "Providing a disc with a name –Disc Name")	



If you enter a long name, only part of it is shown in the Top Menu after finalization (→ page 35). When entering a title name, the name that will appear in the Top Menu can be previewed in "Top Menu Preview (Finalized Disc)" window.

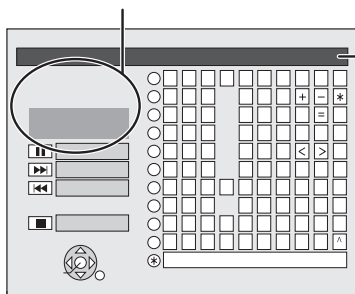

Name field:
shows the text you have entered

2 Press [▲, ▼, ◀, ▶] to select a character and press [ENTER].

Repeat this step to enter other characters.

• To erase a character

Press [▲, ▼, ◀, ▶] to select the character in the name field and press [II].

• Using the numbered buttons to enter characters

e.g., entering the letter "R"

① Press [7] to move to the 7th row.

② Press [7] twice to highlight "R".

③ Press [ENTER].

• To enter a space

Press [CANCEL ✖] and press [ENTER].

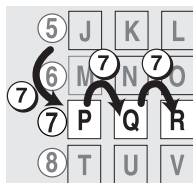

3 Press [■] (Set).

Returns to the previously displayed screen.

To end partway

Press [RETURN].

Text is not saved.

■ To save frequently used phrases

You can add frequently used phrases and recall them later.

Maximum number of saved phrases: 20

Maximum number of characters per phrase: 20

After entering the phrase (→above, steps 1–2)

1 Press [▶▶] while the phrase to be saved is shown in the name field.

2 Press [◀] to select "Save" and press [ENTER].

• To cancel saving phrase

Press [RETURN].

■ To recall a saved phrase

1 Press [◀◀].

2 Press [▲, ▼, ◀, ▶] to select the phrase to be recalled and press [ENTER].

■ To erase a saved phrase

1 Press [◀◀].

2 Press [▲, ▼, ◀, ▶] to select the phrase to be erased and press [SUB MENU].

3 Press [ENTER].

4 Press [◀] to select "Erase" and press [ENTER].

5 Press [RETURN].

Deleting titles

Refer to the control reference on page 32.

• A title cannot be restored once it is deleted.

Make certain before proceeding.

• You cannot delete while recording.

When a recorded title is deleted the available disc space will increase by the amount deleted.

The available disc space increases if any of these is deleted.

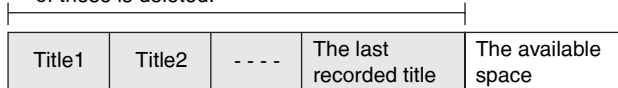

Disc space increases only when the last recorded title is deleted.

The available space does not increase if these are deleted. When deleted, the available disc space increases.

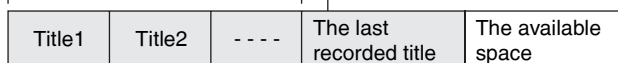

Available space does not increase after deletion.

Selecting recorded titles to delete –Delete Navigator

Preparation

- Turn on the television and select the appropriate video input to suit the connections to this unit.
- Turn the unit on.
- Insert a disc (→ page 18).

1 While stopped

Press [FUNCTIONS].

2 Press [▲, ▼] to select "Delete" and press [ENTER].



3 Press [▲, ▼, ◀, ▶] to select the title and press [ENTER].

To show other pages

Press [◀◀] (Previous) or [▶▶] (Next).

Multiple deleting

Select with [▲, ▼, ◀, ▶] and press [II]. (Repeat.)

• A check mark appears. Press [II] again to cancel.

4 Press [◀, ▶] to select "Delete" and press [ENTER].

To return to the previous screen

Press [RETURN].

To exit the screen

Press [RETURN] several times.

Deleting title during play

1 While playing

Press [DELETE].

2 Press [◀, ▶] to select "Delete" and press [ENTER].



ER].
and

press [ENTER].

A message appears when formatting is finished.

- **Do not disconnect the AC power supply cord while formatting.** This can render the disc unusable.
- Formatting normally takes a few minutes. However, it may take up to a maximum of 70 minutes ().

7 Press [ENTER].



-
-
-
-

Formatting cannot be performed.

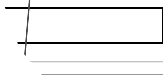

Selecting whether to show the Top Menu first

–Playback will start with:



You can select whether to show the top menu after finalizing. Make selections before finalizing the disc.

After performing steps 1–3 (→ page 34)

- 4 Press [▲,▼] to select “Playback will start with:” and press [ENTER].
- 5 Press [▲,▼] to select items and press [ENTER].

DVD's Top Menu: The top menu appears first.
 First Title on DVD: The disc content is played without displaying the top menu.

Enabling discs to be played on other equipment

–Finalize



Finalize the disc so you can play it on other DVD equipment. The equipment must be able to play finalized discs. To check compatibility with other equipment, refer to page 4.

After performing steps 1–3 (→ page 34)

- 4 Press [▲,▼] to select “Finalize” and press [ENTER].
- 5 Press [◀,▶] to select “Yes” and press [ENTER].
- 6 Press [◀,▶] to select “Start” and press [ENTER].

- Finalizing starts. You cannot cancel finalizing.
- Finalizing can take a few minutes, up to a maximum of 15 minutes, depending on the remaining space on the disc.
 (■■■■ up to 60 minutes.)

■■■■
 Do not disconnect the AC power supply cord while finalizing. This will render the disc unusable.

- 7 Press [ENTER].

After finalizing

- ■■■■ The disc becomes play-only and you can no longer record or edit.
- ■■■■ You can record and edit the disc after formatting (→ page 34) although it becomes play-only after finalizing.
- Titles are divided into about 5-minute (■■■■ 8-minute) chapters. This time varies greatly depending on the condition and mode of recording.
- There is a pause of several seconds between titles and chapters during play.

- You cannot finalize discs recorded on other manufacturers' equipment.
- Discs finalized on this unit may not be playable on other players due to the condition of the recording.
- When finalizing a high-speed recording compatible disc, it may take longer than displayed on the confirmation screen (approximately four times).

Creating Top Menu

–Create DVD Top Menu



+RW discs contain no Top Menu data. Top Menu is a convenient function. We recommend you to create the menu before playing a +RW disc on other equipment.

After performing steps 1–3 (→ page 34)

- 4 Press [▲,▼] to select “Create DVD Top Menu” and press [ENTER].
- 5 Press [◀,▶] to select “Yes” and press [ENTER].
- 6 Press [◀,▶] to select “Start” and press [ENTER].

Creating Top Menu starts. You cannot cancel creating. Creating Top Menu can take a few minutes.

- 7 Press [ENTER].

- Recording or editing on the disc may delete the menu. In that case, create the menu again.
- You cannot use the title menu for playing on this unit.

Enabling the second layer on DL (dual- or double- layer on single side) discs to be recordable

–Close First Layer



DVD-R DL and +R DL discs have two layers of recording surface on one side. This unit does not offer seamless recording on two layers. Recording stops when space on the first layer becomes full. You must close the first layer to start recording on the second layer. Closing makes the first layer unavailable for recording (editing is still available). You cannot cancel closing. Make certain before proceeding.

After performing steps 1–3 (→ page 34)

- 4 Press [▲,▼] to select “Close First Layer” and press [ENTER].
- 5 Press [◀,▶] to select “Yes” and press [ENTER].
- 6 Press [◀,▶] to select “Start” and press [ENTER].

Closing the layer starts. You cannot cancel closing. Closing the layer can take several minutes, up to a maximum of 30 minutes, depending on the remaining space on the first layer.

■■■■
 Do not disconnect the AC power supply cord while closing the layer. This will render the disc unusable.

- 7 Press [ENTER].



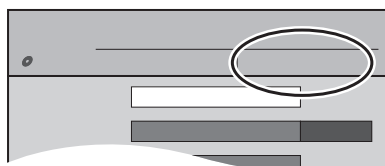

- You cannot close the first layer when it has no recording.
- By closing the layer, you can record or edit discs that have been recorded on the second layer by other equipment.

■ To confirm the layer you can record

You can confirm the remaining recording time on the layer you can record.



Tabs	Menus	Options (Underlined items are the factory presets.)	
Disc	Settings for Playback Press [ENTER] to show the following settings.		
	Ratings Set a ratings level to limit DVD-Video play. Follow the on-screen instructions. Enter a 4-digit password with the numbered buttons when the password screen is shown. • Do not forget your password.	<ul style="list-style-type: none"> • <u>8 No Limit</u>: All DVD-Video can be played. • 1 to 7: Prohibits play of DVD-Video with corresponding ratings recorded on them. • 0 Lock All: Prohibits play of all DVD-Video. 	
	Play DVD-Audio in Video Mode Select "Video Mode (Video On)" to play DVD-Video content on some DVD-Audio.	<ul style="list-style-type: none"> • <u>Unlock Recorder</u> • <u>Change Level</u> • <u>Change Password</u> • <u>Temporary Unlock</u> 	
	Audio Language <div style="background-color: black; width: 20px; height: 10px; display: inline-block;"></div>	<ul style="list-style-type: none"> • Some discs start in a certain language despite any changes you make here. • Enter a code (→ page 44) with the numbered buttons when you select "Other * * * *". • When the selected language is not available on the disc, the default language is played. There are discs where you can only switch the language from the menu screen (→ page 22). 	
	Subtitle Language <div style="background-color: black; width: 20px; height: 10px; display: inline-block;"></div>	<ul style="list-style-type: none"> • <u>English</u> • <u>French</u> • <u>Spanish</u> • <u>Original</u>: The original language of each disc will be selected. • <u>Other * * * *</u> 	
	Menu Language <div style="background-color: black; width: 20px; height: 10px; display: inline-block;"></div>	<ul style="list-style-type: none"> • <u>Automatic</u>: If the language selected for "Audio Language" is not available, subtitles of that language will automatically appear if available on that disc. • <u>English</u> • <u>French</u> • <u>Spanish</u> • <u>Other * * * *</u> 	
	Settings for Recording Press [ENTER] to show the following setting.		
	Recording Time in EP Mode Select the maximum number of hours for recording in EP mode (→ page 17, Recording modes and approximate recording times).	<ul style="list-style-type: none"> • <u>EP – Extended Play (6H)</u>: You can record for 6 hours on an unused 4.7 GB disc. • <u>EP – Extended Play (8H)</u>: You can record for 8 hours on an unused 4.7 GB disc. The sound quality is better when using "EP – Extended Play (6H)" than when using "EP – Extended Play (8H)". 	
	Video	Still Mode (paused video) Select the type of picture shown when you pause play (→ page 44, Frames and fields).	
		Black Level Control Select for adjusting the black level control to the desired setting for picture enhancement.	<ul style="list-style-type: none"> • <u>Automatic</u> • <u>Field</u>: Select if jittering occurs when "Automatic" is selected. (The picture is coarser.) • <u>Frame</u>: Select if small text or fine patterns cannot be seen clearly when "Automatic" is selected. (The picture is clearer and finer.)
Input Level Adjusts the black level of the input signal.		<ul style="list-style-type: none"> • <u>Lighter</u> • <u>Darker</u> 	
Output Level (Composite/SVideo) Adjusts the black level of the output signal from the VIDEO OUT and S VIDEO OUT terminal.		<ul style="list-style-type: none"> • <u>Lighter</u> • <u>Darker</u> 	
Output Level (Component) Adjusts the black level of the output signal from the COMPONENT VIDEO OUT (Y/P _B /P _R) terminals.		<ul style="list-style-type: none"> • <u>Lighter</u> • <u>Normal</u> • <u>Darker</u> 	

Tabs	Menus	Options (Underlined items are the factory presets.)
Audio	Dynamic Range Compression  (Dolby Digital only) Change the dynamic range for late night viewing.	<ul style="list-style-type: none"> • On • <u>Off</u>
	Multi-channel TV Sound (MTS)  Select whether to record the main or secondary audio program (SAP) when recording to a disc.	<ul style="list-style-type: none"> • <u>Main</u> • Secondary Audio Program (SAP) You cannot select the audio on this unit when recording from an external source, such as when transferring (copying) from a video cassette recorder. Select on the other equipment. When recording from the unit's DV IN terminal, select the type of audio recording from "Select Audio Channel for DV Input" (→ below).
	Digital Audio Output Change the settings when you have connected equipment through this unit's DIGITAL AUDIO OUT terminal (→ page 11). <ul style="list-style-type: none"> • Press [ENTER] to display the menu. 	
	PCM Down Conversion Select how to output audio with a sampling frequency of 96 kHz or 88.2 kHz. <ul style="list-style-type: none"> • Signals are converted to 48 kHz or 44.1 kHz despite the above settings if the signals have a sampling frequency of over 96 kHz or 88.2 kHz, or the disc has copy protection. 	<ul style="list-style-type: none"> • On: Signals are converted to 48 kHz or 44.1 kHz. (Choose when the connected equipment cannot process signals with a sampling frequency of 96 kHz or 88.2 kHz.) • <u>Off</u>: Signals are output as 96 kHz or 88.2 kHz. (Choose when the connected equipment can process signals with a sampling frequency of 96 kHz or 88.2 kHz.)
	Dolby Digital   Select how to output the signal. If "Bitstream" is selected, the connected equipment decodes the signal. If "PCM" is selected, this unit decodes the signal and outputs it as 2 channel.	<ul style="list-style-type: none"> • <u>Bitstream</u>: When connecting to equipment displaying the Dolby Digital logo. • PCM: When connecting to equipment not displaying the Dolby Digital logo.
	Not making the proper settings may result in noise or some trouble for digital recording.	<ul style="list-style-type: none"> • <u>Bitstream</u>: When connecting to equipment displaying the DTS logo. • PCM: When connecting to equipment not displaying the DTS logo.
Select Audio Channel for DV Input You can select the kind of audio when recording from the unit's DV IN terminal (→ page 32).	<ul style="list-style-type: none"> • <u>Stereo 1</u>: Records audio (L1, R1) • Stereo 2: Records added audio such as narration (L2, R2) subsequent to original recording. • Mix: Records both Stereo 1 and Stereo 2.  When recording MTS broadcast, select the type of audio in advance from "Multi-channel TV Sound (MTS)" (→ above).	
Display	Status Messages Choose whether to show status messages automatically.	<ul style="list-style-type: none"> • <u>Automatic</u> • Off
	On-screen Language Choose the language for these menus and on-screen messages.	<ul style="list-style-type: none"> • <u>English</u> • Español • Français
	Blue Background Select "Off" if you do not want to have the unit show the blue background when reception is weak.	<ul style="list-style-type: none"> • <u>On</u> • Off
	FL Display Changes the brightness of the unit's display.	<ul style="list-style-type: none"> • <u>Bright</u> • Dim • Automatic: The display turns dark during play, and reappears momentarily when you press a button. When the unit is turned off all displays disappear. While using this mode the standby power consumption can be reduced.
TV Screen	TV Type (→ page 14)	<ul style="list-style-type: none"> • <u>Aspect 4:3 & 480i</u> • Aspect 4:3 & 480p • Aspect 16:9 & 480i • Aspect 16:9 & 480p
	4:3 TV Settings for DVD-Video Select how DVD-Video widescreen picture is shown on a 4:3 standard aspect television.	<ul style="list-style-type: none"> • <u>Pan and Scan (Stretch to fit)</u>: Video recorded for a widescreen is played as Pan & Scan (unless prohibited by the producer of the disc). • Letterbox (Shrink to fit): Video recorded for a widescreen is played in the letterbox style.
	4:3 TV Settings for DVD-RAM Select how DVD-RAM widescreen picture is shown on a 4:3 standard aspect television.	<ul style="list-style-type: none"> • 4:3 Aspect: Titles played as recorded. • <u>Pan and Scan (Stretch to fit)</u>: Video recorded for a widescreen is played as Pan & Scan. • <u>Letterbox (Shrink to fit)</u>: Video recorded for a widescreen is played in the letterbox style.

On the television

Page

Cannot finish recording completely.	<ul style="list-style-type: none"> The program was copy-protected. The disc may be full. The maximum number of times you can record the program is exceeded. 	—
Cannot play.	<ul style="list-style-type: none"> You inserted an incompatible disc (Discs recorded in PAL video, etc.). 	—
Cannot record on the disc.	<ul style="list-style-type: none"> The disc may be dirty or scratched. 	6
Unable to format.		
Please check the disc.		
Cannot record. Disc is full.	<ul style="list-style-type: none"> Create space by deleting any unnecessary titles. ■■■ ■■■■ ■■■■ (Even if you delete recorded content from DVD-R, DVD-R DL, +R or +R DL, there is no increase in disc space.) Use a new disc. 	29, 33, 34
Cannot record. Maximum numbers of titles exceeded.		
No disc	<ul style="list-style-type: none"> The disc may be upside down. 	—
Please change the disc.	<ul style="list-style-type: none"> There may be a problem with the disc. Press [▲ OPEN/CLOSE] on the main unit to remove it and check it for scratches or dirt. (The unit turns off automatically after you open the tray.) 	6
This is a non-recordable disc.	<ul style="list-style-type: none"> The unit cannot record on the disc you inserted. Insert a DVD-RAM or unfinalized DVD-R, DVD-R DL, DVD-RW (DVD-Video format), +R, +R DL or +RW. You inserted an unformatted DVD-RAM, DVD-RW, +R, +R DL or +RW. Format the disc with this unit. 	4
This disc is not formatted properly.		34
⊘	<ul style="list-style-type: none"> The operation is prohibited by the unit or disc. 	—

On the unit's display

The following messages or service numbers appear on the unit's display when something unusual is detected during startup and use.

SET □ ("□" stands for a number.)	<ul style="list-style-type: none"> The remote control and main unit are using different codes. Change the code on the remote control. Press and hold [ENTER] and the indicated number button at the same time for more than 2 seconds. 	15
HARD ERR ("HARD" and "ERR" are alternately displayed.)	<ul style="list-style-type: none"> If there is no change after turning the unit on and off, consult the dealer where the unit was purchased. 	—
NoREAD	<ul style="list-style-type: none"> The disc is dirty or badly scratched. The unit cannot record, play, or edit. The message may appear when the DVD lens cleaner has finished cleaning. Press [▲ OPEN/CLOSE] on the main unit to eject the disc. 	6 —
NoWRIT	<ul style="list-style-type: none"> Recording may be unavailable due to a disc problem. Use a new disc. 	—
NoERAS	<ul style="list-style-type: none"> Deleting an item may be unavailable due to a disc problem. Use a new disc. 	—
PLEASE WAIT ("PLEASE" and "WAIT" are alternately displayed.)	<ul style="list-style-type: none"> Displayed when the unit is started. This is not a malfunction. The unit is carrying out its recovery process. You cannot operate the unit while "PLEASE WAIT" is displayed. 	— —
UNSUPPORT ("UNSUP" and "PORT" are alternately displayed.)	<ul style="list-style-type: none"> You have inserted a disc the unit cannot play or record on. 	4, 5
UNFORMAT ("UNFOR" and "MAT" are alternately displayed.)	<ul style="list-style-type: none"> You have inserted a new DVD-RW/+R/+R DL/+RW or a DVD-RAM/DVD-RW (DVD-Video format) recorded on other equipment. 	34
U59	<ul style="list-style-type: none"> The unit is hot. The unit switches to standby for safety reasons. Wait about 30 minutes until the message disappears. Select a position with good ventilation when installing the unit. Do not block the vent on the rear of the unit. 	—
U61	<ul style="list-style-type: none"> There was a power failure or the AC plug was disconnected while the unit was on. The unit is carrying out its recovery process. This process restores the unit to normal operation. The unit is not broken. Wait until the message disappears. 	—
U88	<ul style="list-style-type: none"> There was something unusual detected with the disc while recording or playing. The unit is carrying out its recovery process. This process restores the unit to normal operation. The unit is not broken. Wait until the message disappears. 	41
U99	<ul style="list-style-type: none"> The unit fails to operate properly. Press [POWER ⏻] on the main unit to switch the unit to standby. Now press [POWER ⏻] on the main unit again to turn the unit on. 	—

Troubleshooting guide

Before requesting service, make the following checks. If you are in doubt about some of the check points, or if the remedies indicated in the chart do not solve the problem, refer to "Customer Services Directory" on page 46 if you reside in the U.S.A., or refer to "Product information" on page 43 if you reside in Canada.

The following do not indicate a problem with this unit:

- | | |
|---|--|
| <ul style="list-style-type: none"> • Regular disc rotating sounds. • Poor reception due to atmospheric conditions. • Image disturbance during search. • Interruptions in reception due to periodic satellite broadcasting breaks. | <ul style="list-style-type: none"> • Operations do not work due to a poor-quality disc. (Try again using a Panasonic disc.) • The unit freezes due to one of its safety devices being activated. (Press and hold [POWER ϕ/I] on the main unit for 10 seconds.) |
|---|--|

Power

		Page
No power.	• Insert the AC power supply cord securely into a known active AC outlet.	8, 9
The unit switches to the standby mode.	• This is a power saving feature. Change "Off Timer" in the Setup menu, if you would prefer. • One of the unit's safety devices is activated. Press [POWER ϕ /I] on the main unit to turn the unit on.	36 —





TV screen and video

The images from this unit do not appear on the television.	• Make sure that the television is connected to the VIDEO OUT terminal, S VIDEO OUT terminal or COMPONENT VIDEO OUT terminals on this unit.	8, 9, 10
Picture is distorted.	• Make sure that the television's input setting (e.g., VIDEO 1) is correct. • The television isn't compatible with progressive signals. Press and hold [■] and [▶ x1.3] on the main unit at the same time for about 5 seconds. The setting will change to interlace.	— —
Television reception worsens after connecting the unit.	• Re-connect all connecting cords securely.	—
Status messages do not appear.	• Select "Automatic" in "Status Messages" in the Setup menu.	38
The blue background does not appear.	• Select "On" in "Blue Background" in the Setup menu.	38
The 4:3 aspect ratio picture expands left and right.	• Use the television to change the aspect. If your television does not have that function, set "Progressive" in the Video menu to "Off".	27
Screen size is wrong.	• Check the settings for "TV Type", "4:3 TV Settings for DVD-Video" or "4:3 TV Settings for DVD-RAM" in the Setup menu.	38
There is a lot of after-image when playing video.	• Set "DNR" in the Video menu to "Off".	27
When playing DVD-Video using progressive output, one part of the picture momentarily appears to be doubled up.	• Set "Progressive" in the Video menu to "Off". This problem is caused by the editing method or material used on DVD-Video, but should be corrected if you use interlace output.	27
There is no apparent change in picture quality when adjusted with the Video menu in the on-screen menus.	• The effect is less perceivable with some types of video.	—









Displays

The display is dim.	• Change "FL Display" in the Setup menu.	38
"12:00A" is flashing on the unit's display.	• Set the clock.	15
Compared to the actual recorded time, less remaining time is displayed.	• The displayed recording/play time is converted from the number of frames at 29.97 frames (equal to 0.999 seconds) to one second. There will be a slight difference between the time displayed and the actual elapsed time (e.g., actual one-hour elapsed time may display as approximately 59 minutes 56 seconds). This does not affect the recording.	—
The time recorded on the disc and the available time shown do not add up.	• Times shown may disagree with actual times.	—
The play time shown for MP3 does not agree with the actual time.	• Even if you delete recorded content from DVD-R, DVD-R DL, +R, or +R DL, there is no increase in disc space. • Available recording space on DVD-RW (DVD-Video format) or +RW increases only when the last recorded title is deleted. It does not increase if other titles are deleted. • Available recording space on DVD-R, DVD-R DL, +R and +R DL reduces if you have repeatedly recorded and edited more than 200 times or so. (For the second layer on DVD-R DL and +R DL, this happens after about 60 times.) • While searching, the elapsed time may not display correctly.	— — —
"U88" is displayed and the disc cannot be ejected.	• The unit is carrying out the recovery process. Do the following to eject the disc. 1 Press [POWER ϕ /I] on the main unit to switch the unit to standby. If the unit doesn't switch to standby, press and hold [POWER ϕ /I] on the main unit for about 10 seconds. The unit is forcibly switched to standby. 2 While the unit is off, press and hold [■] and [CH ^] on the main unit at the same time for about 5 seconds. Remove the disc.	—

Sound		Page
No sound Low volume. Distorted sound. Cannot hear the desired audio type.	• Check the connections and settings. Check the input mode on the amplifier if you have connected one.	8–11, 38
	• Press [AUDIO] to select the audio.	23
	• Turn off V. Surround Sound in the following cases. – When using discs that do not have surround sound effects such as Karaoke discs. – When playing MTS broadcast programs.	27
Cannot switch audio.	• The disc may have a restriction on the method of audio output. If “D. MIX” does not appear in the display when playing multi-channel DVD-Audio, only audio for the two front channels will be output. Refer to the disc’s jacket.	—
	• You cannot change the audio type when DVD-R, DVD-R DL, DVD-RW (DVD-Video format), +R, +R DL or +RW is in the disc tray.	—
	• You cannot change the audio type when playing DVD-R, DVD-R DL, DVD-RW (DVD-Video format), +R, +R DL or +RW. (You can select “Main” or “SAP” in “Multi-channel TV Sound (MTS)” in the Setup menu before recording.)	38
	• When the sound is output from DIGITAL AUDIO OUT terminal, the sound effect doesn’t work if the setting of “Dolby Digital” is “Bitstream”. • There are discs where audio cannot be changed because of how the disc was created.	11, 38 —

Operation		Page	
Cannot operate the television. The remote control doesn’t work.	• Change manufacturer code. Some televisions cannot be operated even if you change the code.	15	
	• The remote control and main unit are using different codes. Change the code on the remote control. Press and hold [ENTER] and the indicated number button at the same time for more than 2 seconds.	15	
	• The batteries are depleted. Replace them with new ones.	6	
	• You are not pointing the remote control at the main unit’s remote control signal sensor during operation.	6	
	• Colored glass may obstruct the signal reception/transmission.	—	
	• Don’t place the signal sensor in direct sunlight or in areas that may be subject to sunlight exposure.	—	
	• It may be necessary to set the code on the remote control again after changing the batteries.	15	
	• It may be necessary to set the manufacturer code again after changing the batteries.	15	
	The unit is on but cannot be operated.	• Some operations may be prohibited by the disc.	—
		• The unit is hot (“U59” appears on the display). Wait for “U59” to disappear.	—
• One of the unit’s safety devices may have been activated. Reset the unit as follows: 1 Press [POWER ] on the main unit to switch the unit to standby. If the unit doesn’t switch to standby, press and hold [POWER ] on the main unit for about 10 seconds. The unit is forcibly switched to standby. Alternatively, disconnect the AC power supply cord, wait one minute, then reconnect it. 2 Press [POWER ] on the main unit to switch it on. If the unit still cannot be operated, consult the dealer.		— — —	
Cannot eject disc.	• The unit is recording. • The unit may have a problem. While the unit is off, press and hold [] and [CH ] on the main unit at the same time for about 5 seconds. Remove the disc and consult the dealer.	— —	
Startup is slow.	• Startup takes time in the following situations. – A disc other than a DVD-RAM is inserted. – The clock is not set. – Immediately after a power failure or the AC power supply cord is connected.	—	
Takes time to read DVD-RAM.	• It may take time to read a disc if it is being used for the first time in this unit or it has not been used for a long time.	—	

Recording, scheduled recording and copying

Cannot record.	• You haven’t inserted a disc or the disc you inserted cannot be recorded on. Insert a disc the unit can record onto.	4	
	•      The disc is not formatted. Format the disc using DVD Management.	34	
	• The write-protect tab on the cartridge is set to Protect, or the disc is protected with DVD Management.	34	
	• Some programs have limitations on the number of times they can be recorded. (CPRM)	44	
	• The disc is full or nearly full. Delete unneeded titles or use another disc.	29, 33, 34	
	• You cannot record on finalized DVD-R, DVD-R DL, DVD-RW (DVD-Video format), +R, +R DL or DVD-RW (VR format) discs.	—	
	• Due to peculiarities of DVD-R, DVD-R DL, DVD-RW (DVD-Video format), +R, +R DL or +RW you may be unable to record onto them if you either insert and remove the disc or switch the unit on and off while a disc is loaded, a total of fifty times.	—	
	• DVD-R, DVD-R DL, DVD-RW, +R, +R DL and +RW recorded on this unit may not be recordable on other Panasonic DVD recorders.	—	
	Cannot record from external equipment. Scheduled recording does not work properly. Scheduled recording does not stop even when  is pressed. The scheduled program remains even after recording finishes. A part or whole of a recorded title has been lost.	• Check that the connection is correct. • Select the input channel (“IN1”, “IN2” or “DV”) for the equipment you have connected.	8, 9, 32
		• The scheduled program is incorrect or different scheduled program times overlap. Correct the program.	21
• Set the clock.		15	
• If you start recording immediately after turning on the unit while “Quick Start” is set to “On”, you cannot then stop recording for a few seconds.		36	
• The scheduled program remains if set to Monday - Friday, Monday - Saturday, Sunday - Saturday or weekly.		20	
• If there is a power failure or the plug is disconnected from the household AC outlet while recording or editing, the title may be lost or the disc may become unusable. You will have to format the disc ( ) or use a new disc. We cannot offer any guarantee regarding lost titles or discs.	—		

Recording, scheduled recording and copying (Continued)

	Page
The DV automatic recording function does not work.	32
• If images cannot be recorded or if the recording is aborted, check the connections and DV equipment settings.	—
• You cannot start recording until the images from the DV equipment appear on the television.	—
• Recording may not be performed as desired if the time codes on the tape in the DV equipment are not successive.	—
• Depending on the equipment, the DV automatic recording may not operate properly.	—
• You can only record audio/video images on a DV tape.	—

Play

Play fails to start even when [▶] (PLAY) is pressed. Play starts but then stops immediately.	<ul style="list-style-type: none"> • Insert the disc correctly with the label facing up. • The disc is dirty. • You tried to play a blank disc or unplayable disc on this unit. • You tried to play a +RW that needs to be finalized on the equipment used for recording. • When recording to DVD-RAM using EP (8H) mode, play may not be possible on DVD players that are compatible with DVD-RAM. In this case use EP (6H) mode. • You cannot play discs during DV automatic recording. 	<p>18</p> <p>6</p> <p>4, 5</p> <p>—</p> <p>37</p> <p>32</p>
DVD-Video is not played.	<ul style="list-style-type: none"> • Some DVD-Video cannot be played when you change the ratings level. 	37
Alternative soundtrack and subtitles cannot be selected.	<ul style="list-style-type: none"> • The languages are not recorded on the disc. • You may have to use the disc's menus to select languages. 	<p>—</p> <p>22</p>
No subtitles.	<ul style="list-style-type: none"> • When progressive output is on, closed captions cannot be displayed. • Subtitles are not recorded on the disc. • Set "Subtitle" on the on-screen menu to "On". 	<p>—</p> <p>—</p> <p>26</p>
Angle cannot be changed.	<ul style="list-style-type: none"> • Angles can only be changed during scenes where different angles are recorded. 	—
You have forgotten your ratings password.	<ul style="list-style-type: none"> • While the disc tray is open, press and hold [● REC] and [▶ x1.3] on the main unit at the same time for 5 or more seconds ("INIT" will appear on the unit's display). The ratings level returns to "8". 	—
Quick View does not work.	<ul style="list-style-type: none"> • This does not work when audio is other than Dolby Digital. • This does not work while recording in XP or FR mode. 	<p>—</p> <p>—</p>
The resume play function does not work.	<ul style="list-style-type: none"> • Memorized positions are cancelled when the tray is opened. The memorized position on the playlist is also cancelled when the playlist and title are edited. 	—

Edit

Cannot format.	<ul style="list-style-type: none"> • The disc is dirty. Wipe with a damp cloth and then wipe dry. • You tried formatting a disc that is not compatible with this unit. 	<p>6</p> <p>4, 5</p>
Cannot create chapters.	<ul style="list-style-type: none"> • The unit writes the chapter division information to the disc when you turn it off or remove the disc. The information is not written if there is an interruption to the power before this. 	—
Cannot mark the start point or the end point during "Shorten Title" operation.	<ul style="list-style-type: none"> • These operations are not possible with still pictures. • You cannot set points if they are too close to each other. You cannot set an end point before a start point. 	<p>—</p> <p>—</p>
Cannot delete chapters.	<ul style="list-style-type: none"> • When the chapter is too short to delete, use "Combine Chapters" to make the chapter longer. 	29
The available recording space doesn't increase even after deleting recordings on the disc.	<ul style="list-style-type: none"> • Available recording space on DVD-R, DVD-R DL, +R or +R DL does not increase even after deleting previously recorded titles. • Available recording space on DVD-RW (DVD-Video format) or +RW increases only when the last recorded title is deleted. It does not increase if other titles are deleted. 	<p>—</p> <p>—</p>
Cannot create a playlist.	<ul style="list-style-type: none"> • You cannot select all the chapters at once in a title if the title also includes still pictures. Select them individually. 	—

Product Service

- 1. Damage requiring service**—The unit should be serviced by qualified service personnel if:
 - (a) The AC power supply cord or AC adaptor has been damaged; or
 - (b) Objects or liquids have gotten into the unit; or
 - (c) The unit has been exposed to rain; or
 - (d) The unit does not operate normally or exhibits a marked change in performance; or
 - (e) The unit has been dropped or the cabinet damaged.
- 2. Servicing**—Do not attempt to service the unit beyond that described in these operating instructions. Refer all other servicing to authorized servicing personnel.
- 3. Replacement parts**—When parts need replacing ensure the servicer uses parts specified by the manufacturer or parts that have the same characteristics as the original parts. Unauthorized substitutes may result in fire, electric shock, or other hazards.
- 4. Safety check**—After repairs or service, ask the servicer to perform safety checks to confirm that the unit is in proper working condition.

Product information

For product information or assistance with product operation:

In the U.S.A., refer to "Customer Services Directory" on page 46.

In Canada, contact the Panasonic Canada Inc. Customer Care Centre at 1-800-561-5505, or visit the website (www.panasonic.ca), or an authorized Servicentre closest to you.

stream

is the digital form of multi-channel audio data (e.g., 5.1 channel) before it is decoded into its various channels.

DRM (Content Protection for Recordable Media)

DRM is technology used to protect broadcasts that are allowed to be recorded only once. Such broadcasts can be recorded only with DRM compatible recorders and discs.

Dolby Digital

This is a method of coding digital signals developed by Dolby Laboratories. Apart from stereo (2-channel) audio, these signals can also be multi-channel audio. A large amount of audio information can be recorded on one disc using this method.

Down-mixing

This is the process of remixing the multi-channel audio found on some discs into two channels for stereo output. It is useful when you want to listen to the 5.1-channel audio recorded on DVDs through your television's speakers. Some discs prohibit down-mixing and this unit can then only output the front two channels.

DTS (Digital Theater Systems)

This surround system is used in many movie theaters. There is good separation between the channels, so realistic sound effects are possible.

Dynamic range

Dynamic range is the difference between the lowest level of sound that can be heard above the noise of the equipment and the highest level of sound before distortion occurs. Dynamic range compression means reducing the gap between the loudest and softest sounds. This means you can listen at low volumes but still hear dialog clearly.

Film and video

DVD-Videos are recorded using either film or video. This unit can determine which type has been used, then uses the most suitable method of progressive output.

Film:

Recorded at 24 or 30 frames per second. Generally appropriate for motion picture films.

Video:

Recorded at 30 frames/60 fields per second. Generally appropriate for TV drama programs or animation.

Finalize

A process that makes play of a recorded CD-R, CD-RW, DVD-R, etc. possible on equipment that can play such media. You can finalize DVD-R, DVD-R DL, DVD-RW (DVD-Video format), +R or +R DL on this unit. After finalizing, the disc becomes play-only and you can no longer record or edit. However, finalized DVD-RW can be formatted to become recordable.

Formatting

Formatting is the process of making media such as DVD-RAM recordable on recording equipment. You can format DVD-RAM, DVD-RW (only as DVD-Video format), +R, +R DL or +RW on this unit. When you use a new DVD-RW, +R, +R DL or +RW, it must be formatted.

Formatting irrevocably deletes all contents.

Frames and fields

Frames refer to the single images that constitute the video you see on your television. Each frame consists of two fields.



- A frame still shows two fields, so there may be some blurring, but picture quality is generally better.
- A field still shows less picture information so it may be rougher, but there is no blurring.

JPEG (Joint Photographic Experts Group)

This is a system used for compressing/decoding color still pictures. If you select JPEG as the storage system on digital cameras, etc., the data will be compressed to 1/10–1/100 of its original size. The feature of JPEG is less deterioration in picture quality considering the degree of compression.

MP3 (MPEG Audio Layer 3)

An audio compression method that compresses audio to approximately one tenth of its size without any considerable loss of audio quality. You can play MP3 you have recorded onto CD-R and CD-RW.

Pan & Scan/Letterbox

In general, DVD-Video are produced with the intention that they be viewed on a widescreen television (16:9 aspect ratio), so images often don't fit regular (4:3 aspect ratio) televisions. Two styles of picture, "Pan & Scan" and "Letterbox", deal with this problem.

Playback control (PBC)

If a Video CD has playback control, you can select scenes and information with menus.

(This unit is compatible with version 2.0 and 1.1.)

Progressive/Interlace

NTSC, the video signal standard, has 480 interlaced (i) scan lines, whereas progressive scanning uses twice the number of scan lines. This is called 480p.

Using progressive output, you can enjoy the high-resolution video recorded on media such as DVD-Video. Your television must be compatible to enjoy progressive video.

Protection

You can prevent accidental deletion by setting writing protection or deletion protection.

Sampling frequency

Sampling is the process of converting the heights of sound wave (analog signal) samples taken at set periods into digits (digital encoding). Sampling frequency is the number of samples taken per second, so larger numbers mean more faithful reproduction of the original sound.

Thumbnail

This refers to a miniature representation of a picture used to display multiple pictures in the form of a list.

TIFF (Tag Image File Format)

This is a system used for compressing/decoding color still pictures. A common format for storing high quality images on digital cameras and other devices.

Limited Warranty (ONLY FOR U.S.A.)

Panasonic Consumer Electronics Company,
Division of Panasonic Corporation of North America
One Panasonic Way Secaucus, New Jersey 07094

Panasonic Puerto Rico, Inc.
Ave. 65 de Infantería, Km. 9.5
San Gabriel Industrial Park, Carolina, Puerto Rico 00985

Panasonic DVD Recorder Limited Warranty

Limited Warranty Coverage

If your product does not work properly because of a defect in materials or workmanship, Panasonic Consumer Electronics Company or Panasonic Puerto Rico, Inc. (collectively referred to as "the warrantor") will, for the length of the period indicated on the chart below, which starts with the date of original purchase ("warranty period"), at its option either (a) repair your product with new or refurbished parts, or (b) replace it with a new or a refurbished product. The decision to repair or replace will be made by the warrantor.

Product of Part name	Parts	Labor
DVD Recorder	One (1) Year	One (1) Year
Rechargeable Batteries, DVD-RAM Disc (in exchange for defective item)	Ten (10) Days	Not Applicable

During the "Labor" warranty period there will be no charge for labor. During the "Parts" warranty period, there will be no charge for parts. You must carry-in or mail-in your product during the warranty period. If non-rechargeable batteries are included, they are not warranted. This warranty only applies to products purchased and serviced in the United States or Puerto Rico. This warranty is extended only to the original purchaser of a new product which was not sold "as is". A purchase receipt or other proof of the original purchase date is required for warranty service.

Carry-In or Mail-In Service

For Carry-In or Mail-In Service (as applicable) in the United States call 1-800-211-PANA (7262) or visit Panasonic Web Site: <http://www.panasonic.com>
For assistance in Puerto Rico call Panasonic Sales Company (787)-750-4300 or fax (787)-768-2910.

Limited Warranty Limits And Exclusions

This warranty ONLY COVERS failures due to defects in materials or workmanship, and DOES NOT COVER normal wear and tear or cosmetic damage. The warranty ALSO DOES NOT COVER damages which occurred in shipment, or failures which are caused by products not supplied by the warrantor, or failures which result from accidents, misuse, abuse, neglect, mishandling, misapplication, alteration, faulty installation, set-up adjustments, misadjustment of consumer controls, improper maintenance, power line surge, lightning damage, modification, or commercial use (such as in a hotel, office, restaurant, or other business), rental use of the product, service by anyone other than a Factory Servicenter or other Authorized Servicer, or damage that is attributable to acts of God.

THERE ARE NO EXPRESS WARRANTIES EXCEPT AS LISTED UNDER "LIMITED WARRANTY COVERAGE". THE WARRANTOR IS NOT LIABLE FOR INCIDENTAL OR CONSEQUENTIAL DAMAGES RESULTING FROM THE USE OF THIS PRODUCT, OR ARISING OUT OF ANY BREACH OF THIS WARRANTY. (As examples, this excludes damages for lost time, travel to and from the servicer, loss of media or images, data or other recorded content. The items listed are not exclusive, but are for illustration only.) **ALL EXPRESS AND IMPLIED WARRANTIES, INCLUDING THE WARRANTY OF MERCHANTABILITY, ARE LIMITED TO THE PERIOD OF THE LIMITED WARRANTY.**

Some states do not allow the exclusion or limitation of incidental or consequential damages, or limitations on how long an implied warranty lasts, so the exclusions may not apply to you.

This warranty gives you specific legal rights and you may also have other rights which vary from state to state. If a problem with this product develops during or after the warranty period, you may contact your dealer or Servicenter. If the problem is not handled to your satisfaction, then write to the warrantor's Consumer Affairs Department at the addresses listed for the warrantor.

PARTS AND SERVICE WHICH ARE NOT COVERED BY THIS LIMITED WARRANTY ARE YOUR RESPONSIBILITY.

Customer Services Directory

Obtain Product Information and Operating Assistance; locate your nearest Dealer or Servicenter; purchase Parts and Accessories; or make Customer Service and Literature requests by visiting our Web Site at:

<http://www.panasonic.com/consumersupport>

or, contact us via the web at:

<http://www.panasonic.com/contactinfo>

You may also contact us directly at:

1-800-211-PANA (7262),

Monday-Friday 9 am-9 pm; Saturday-Sunday 10 am-7 pm, EST.

For hearing or speech impaired TTY users, TTY: 1-877-833-8855

Accessory Purchases

Purchase Parts, Accessories and Instruction Books online for all Panasonic Products by visiting our Web Site at:

<http://www.pasc.panasonic.com>

or, send your request by E-mail to:

npcparts@us.panasonic.com

You may also contact us directly at:

1-800-332-5368 (Phone) 1-800-237-9080 (Fax Only) (Monday - Friday 9 am to 8 pm, EST.)

Panasonic Services Company

20421 84th Avenue South, Kent, WA 98032

(We Accept Visa, MasterCard, Discover Card, American Express, and Personal Checks)

For hearing or speech impaired TTY users, TTY: 1-866-605-1277

Service in Puerto Rico

Panasonic Puerto Rico, Inc.

Ave. 65 de Infantería, Km. 9.5, San Gabriel Industrial Park, Carolina, Puerto Rico 00985

Phone (787)750-4300, Fax (787)768-2910

Limited Warranty (ONLY FOR CANADA)

Panasonic Canada Inc.

PANASONIC/TECHNICS PRODUCT – LIMITED WARRANTY

Panasonic Canada Inc. warrants this product to be free from defects in material and workmanship and agrees to remedy any such defect for a period as stated below from the date of original purchase.

Technics Audio Product	One (1) year, parts and labour
Panasonic Audio & DVD Product	One (1) year, parts and labour
Accessories including rechargeable batteries	Ninety (90) days

In-home Service will be carried out only to locations accessible by roads and within 50 km of an authorized Panasonic service facility.

LIMITATIONS AND EXCLUSIONS

This warranty does not apply to products purchased outside Canada or to any product which has been improperly installed, subjected to usage for which the product was not designed, misused or abused, damaged during shipping, or which has been altered or repaired in any way that affects the reliability or detracts from the performance, nor does it cover any product which is used commercially. Dry cell batteries are also excluded from coverage under this warranty.

This warranty is extended to the original end user purchaser only. A purchase receipt or other proof of date of original purchase is required before warranty service is performed.

THIS EXPRESS, LIMITED WARRANTY IS IN LIEU OF ALL OTHER WARRANTIES, EXPRESS OR IMPLIED, INCLUDING ANY IMPLIED WARRANTIES OF MERCHANTABILITY AND FITNESS FOR A PARTICULAR PURPOSE.

IN NO EVENT WILL PANASONIC CANADA INC. BE LIABLE FOR ANY SPECIAL, INDIRECT OR CONSEQUENTIAL DAMAGES.

In certain instances, some jurisdictions do not allow the exclusion or limitation of incidental or consequential damages, or the exclusion of implied warranties, so the above limitations and exclusions may not be applicable.

WARRANTY SERVICE

FOR PRODUCT OPERATION ASSISTANCE, please contact:

Our Customer Care Centre:	Telephone #:	(905) 624-5505
	1-800 #:	1-800-561-5505
	Fax #:	(905) 238-2360
	Email link:	"Contact Us" on www.panasonic.ca

FOR PRODUCT REPAIRS, please locate your nearest Authorized Servicentre at www.panasonic.ca :

Link : "Servicentres™ locator" under "Customer support"

Panasonic Factory Service:

Richmond British Columbia

Panasonic Canada Inc.
12111 Riverside Way
Richmond BC V6W 1K8
Tel: (604) 278-4211
Fax: (604) 278-5627

Mississauga Ontario

Panasonic Canada Inc.
5770 Ambler Drive
Mississauga ON L4W 2T3
Tel: (905) 624-8447
Fax: (905) 238-2418

IF YOU SHIP THE PRODUCT TO A SERVICENTRE

Carefully pack and send prepaid, adequately insured and preferably in the original carton.
Include details of the defect claimed, and proof of date of original purchase.

Limited Warranty (ONLY FOR U.S.A.)/Limited Warranty (ONLY FOR CANADA)

- Visite la <http://www>
- Antes de
- El equip

■ **Term**
La señal
terminal
Asegúrese
de la unid
VIDEO O

■ **Cuan**
much
Para ahorra
CA. Esta un
aunque se

ación acerca de los métodos de conexión. (Sólo está en inglés.)
[corder/dvd_connection.asp](http://www.corder/dvd_connection.asp)
os manuales de instrucciones apropiados.
parado a menos que se indique lo contrario.

■ **Conecte la unidad directamente al televisor**
Las señales de vídeo enviadas a través de videograbadoras se verán afectadas por los sistemas de protección del copyright, y las imágenes no se mostrarán correctamente en el televisor.

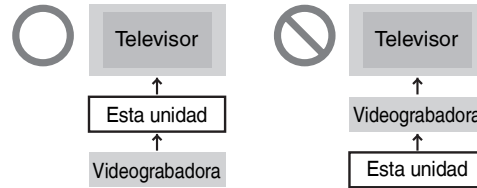

Conecte

Esta conexión

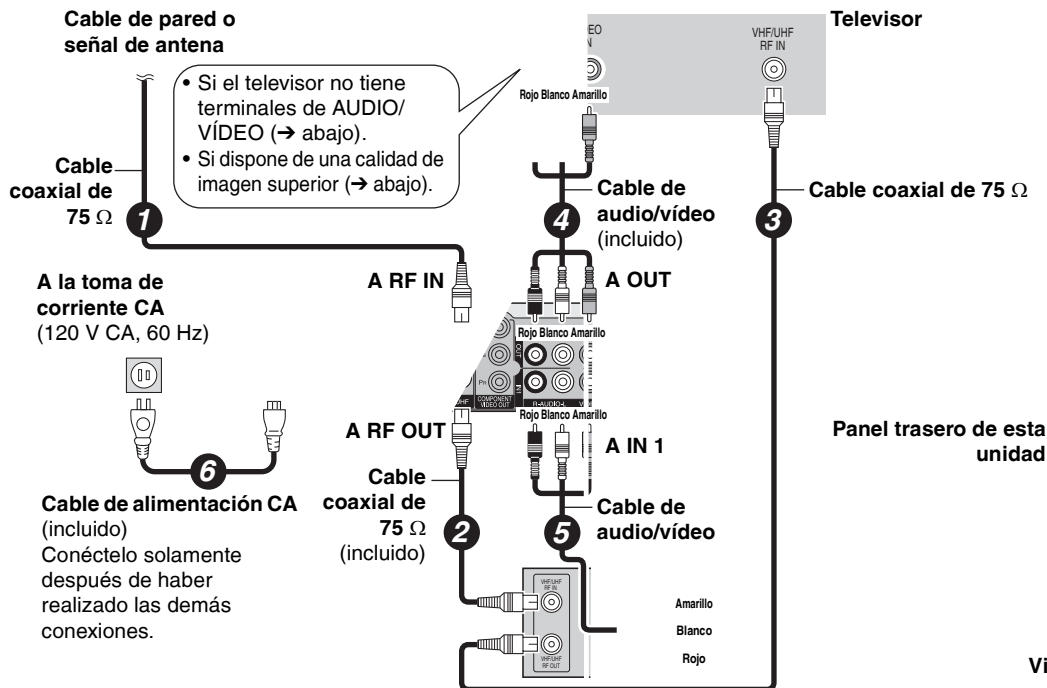

Videograbadora

Conecte la unidad al televisor y grabar cuando la unidad esté apagada.

Si el televisor no tiene terminales de audio/vídeo se necesita un modulador RF

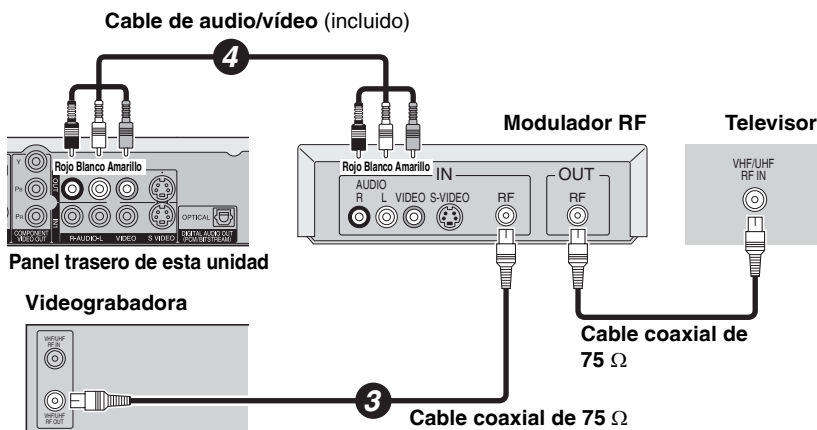

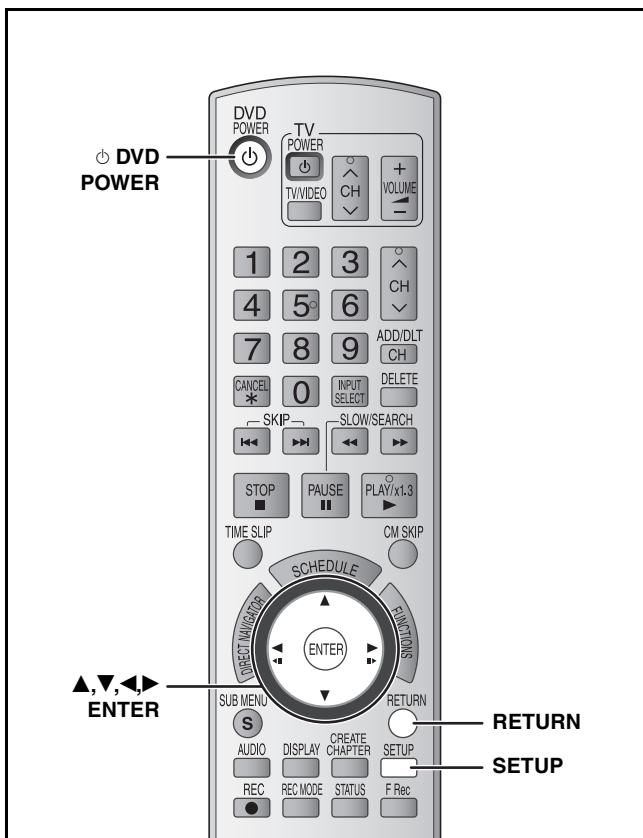

Sintonización automática

Preparación

- Encienda el televisor y seleccione la entrada de vídeo apropiada para las conexiones de esta unidad.

1 Pulse [DVD POWER].



2 Pulse [▲,▼] para seleccionar el idioma y pulse [ENTER].

Si se equivoca, pulse [RETURN] para volver a la pantalla anterior.

3 Pulse [▲,▼] para seleccionar “TV de 4:3” o “TV ancho de 16:9” y pulse [ENTER].

4 Pulse [▲,▼] para seleccionar “Encendido” o “Apagado” y pulse [ENTER].

5 Pulse [▲,▼] para seleccionar “Sintonizador” o “Entrada” y pulse [ENTER].

6 Pulse [ENTER] para empezar la sintonización automática.



A continuación, la unidad procederá con el ajuste automático del reloj. Cuando acabe, aparecerá la hora.

7 Pulse [ENTER].

■ Si el reloj va una hora adelantado o retrasado

- 1 Pulse [SETUP].
- 2 Pulse [▲,▼] para seleccionar “Configuración” y pulse [▶].
- 3 Pulse [▲,▼] para seleccionar “Fecha y Hora” y pulse [ENTER].
- 4 Pulse [▲,▼] para seleccionar “Ajustar del huso horario” y pulse [ENTER].
- 5 Pulse [▲,▼] para seleccionar “-1” o “+1” y pulse [ENTER].

■ Si aparece la pantalla “Ajuste manual del reloj”

- Se ha producido un error al ajustar el reloj automáticamente.
- Se ha seleccionado “Entrada” en el paso 5 durante el ajuste.

- 1 Pulse [◀] para seleccionar la opción que desee modificar y pulse [▲,▼] para cambiar el ajuste.
- 2 Pulse [ENTER].

Selección del tipo de televisor

Si tras haber elegido un tipo de televisor concreto durante el ajuste inicial, conecta un televisor progresivo u otro tipo de televisor distinto justo después de encender la unidad por primera vez, siga los pasos que se indican a continuación. Seleccione la opción que corresponda a su televisor.

1 Durante la parada

Pulse [SETUP].

2 Pulse [▲,▼] para seleccionar “Pantalla TV” y pulse [▶].

3 Pulse [▲,▼] para seleccionar “Tipo TV” y pulse [ENTER].

- 480p/480i:
Seleccione “480p” si el televisor es compatible con la salida progresiva.

4 Pulse [▲,▼] para seleccionar la opción y pulse [ENTER].

Para salir de la pantalla

Pulse [SETUP].

Para volver a la pantalla anterior

Pulse [RETURN].

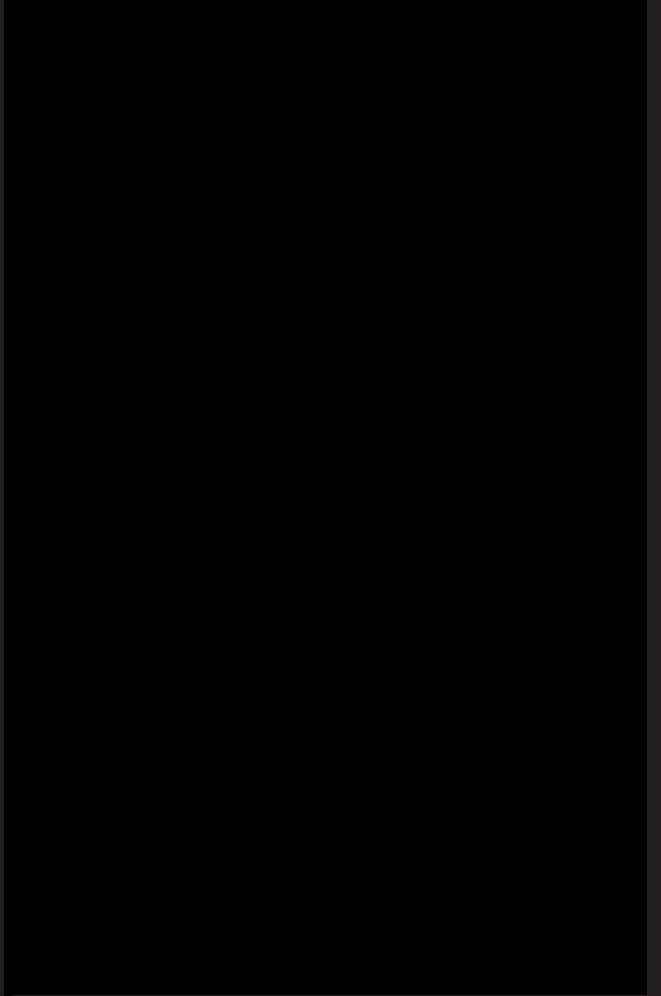
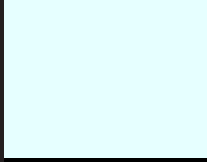

G



Index

Angle	26	Divide Title	29	PCM Down Conversion	38
Audio		DNR	27	Picture	27
attribute	26	DV automatic recording	32	Playlist	30
language	26	DVD-RAM, DVD-R, DVD-R DL, DVD-RW, +R, +R DL, +RW	4	Progressive	27, 44
receiving, recording	19, 38			Properties	
Change Thumbnail	29	Enter name		playlist	31
Channel		disc	34	title	29
adding, deleting	13	playlist	31	Protection	
audio	26	title	20, 29	cartridge	34
captions	14			disc	34
Set Channels Automatically	13	Finalize	35, 44	title	29
Chasing playback	19	Flexible Recording	19	Quick Start	12, 36
Cleaning		Format disc	34	Quick View	23
disc	6	FR (Flexible Recording) Mode	17		
lens	6	FUNCTIONS window	27	Ratings	37
main unit	6			Recording	
Clock settings	15	JPEG	25, 44	Flexible Recording	19
Close First Layer	35	Language		from a video cassette recorder	32
CM Skip	23	audio	26	mode	17
Connection		on-screen	38	scheduled	20
amplifier, system component	11	soundtrack	26	Repeat play	26
antenna	8, 9, 11	subtitle	26	Restore default settings	36
cable box, satellite receiver	9, 10	Menu		Resume play function	23
DV IN terminal	32	MP3	24		
television	8, 9, 10	on-screen	26	Scheduled recording	20
video cassette recorder	8, 9, 10, 32	Pictures	25	Setup menu	36
Copy (playlist)	31	Setup	36	Shorten Title	29
Copying		Mode		Signal Source (RF IN)	13
DV automatic recording	32	recording	17	Simultaneous rec and play	19
from a video cassette recorder	32	still mode	37	Soundtrack	26
Manual recording	32	MP3	24, 44	Status messages	27
CPRM	44	Noise reduction (NR)		Subtitle	26
Create Chapter	23, 29, 31	DNR	27	Thumbnail	29
Create DVD Top Menu	35	Line-in NR	27	TIFF	25, 44
Create playlists	30	On-screen		Time Slip	23
		language	38	Transfer	27
Delete		menus	26	TV Type	14
all titles	34	status messages	27	V. Surround Sound	27
chapter	29, 31				
chapter in playlist	31				
playlist	31				
title	33				
Delete Navigator	33				
Dialog Enhancer	27				
Direct Navigator	22, 28				

Manufactured under license from Dolby Laboratories. "Dolby" and the double-D symbol are trademarks of Dolby Laboratories.

"DTS" and "DTS 2.0 + Digital Out" are trademarks of Digital Theater Systems, Inc.

Apparatus Claims of U.S. Patent Nos. 4,631,603, 4,577,216, and 4,819,098, licensed for limited viewing uses only.

This product incorporates copyright protection technology that is protected by method claims of certain U.S. patents and other intellectual property rights owned by Macrovision Corporation and other rights owners. Use of this copyright protection technology must be authorized by Macrovision Corporation, and is intended for home and other limited viewing uses only unless otherwise authorized by Macrovision Corporation. Reverse engineering or disassembly is prohibited.

MPEG Layer-3 audio decoding technology licensed from Fraunhofer IIS and Thomson multimedia.

-If you see this symbol-

Information on Disposal in other Countries outside the European Union



This symbol is only valid in the European Union. If you wish to discard this product, please contact your local authorities or dealer and ask for the correct method of disposal.

Panasonic Consumer Electronics Company, Division of Panasonic Corporation of North America
One Panasonic Way Secaucus,
New Jersey 07094
<http://www.panasonic.com>

Panasonic Puerto Rico, Inc.
Ave. 65 de Infantería, Km. 9.5
San Gabriel Industrial Park, Carolina,
Puerto Rico 00985

Panasonic Canada Inc.
5770 Ambler Drive
Mississauga, Ontario
L4W 2T3
www.panasonic.ca

