

Video Recordable DVD Drive

Operating Instructions



VRD-VC10

Safety Regulations

WARNING

You are cautioned that any changes or modifications not expressly approved in this manual could void your authority to operate this equipment.
To prevent fire or shock hazard, do not expose the unit to rain or moisture.
To avoid electrical shock, do not open the cabinet. Refer servicing to qualified personnel only.

CAUTION:

As the laser beam in the VRD-VC10 is harmful to the eyes, do not attempt to disassemble the cabinet. Refer servicing to qualified personnel only.
The use of optical instruments with this product will increase eye hazard.
The use of controls or adjustments or performance of procedures other than those specified herein may result in hazardous radiation exposure.

The VRD-VC10 is classified as a CLASS 1 LASER PRODUCT.
The CLASS 1 LASER PRODUCT label is located on the enclosure.

Bei diesem VRD-VC10 handelt es sich um ein Laser-Produkt der Klasse 1.
Das Etikett mit der Aufschrift LASER KLASSE 1 PRODUKT befindet sich auf dem Gehäuse.

CLASS 1
LASER PRODUCT
LASER KLASSE 1
PRODUKT

LUOKAN 1 LASERLAITE
KLASS 1 LASER APPARAT

FCC Compliance:

This equipment has been tested and found to comply with the limits for a Class B digital device, pursuant to Part 15 of the FCC Rules. These limits are designed to provide reasonable protection against harmful interference in a residential installation. This equipment generates, uses, and can radiate radio frequency energy and, if not installed and used in accordance with the instructions, may cause harmful interference to radio communications. However, there is no guarantee that interference will not occur in a particular installation. If this equipment does cause harmful interference to radio or television reception, which can be determined by turning the equipment off and on, the user is encouraged to try to correct the interference by one or more of the following measures:

- Reorient or relocate the receiving antenna.
- Increase the separation between the equipment and receiver.
- Connect the equipment into an outlet on a circuit different from that to which the receiver is connected.
- Consult the dealer or an experienced radio/TV technician for help.

The shielded interface cable recommended in this manual must be used with this equipment in order to comply with the limits for a digital device pursuant to Subpart B of Part 15 of FCC Rules.

Notes:

If you have any questions about this product, you may call the telephone number listed on the "Support overview" on page 45. The telephone number below is not for customer service but only for official purpose.

Declaration of Conformity

Trade Name: SONY
Model No.: VRD-VC10
Responsible Party: Sony Electronics Inc.
Address: 16450 W. Bernardo Dr.,
San Diego, CA 92127
U.S.A.
Telephone No.: 858-942-2230

This device complies with Part 15 of the FCC Rules. Operation is subject to the following two conditions:

- (1) This device may not cause harmful interference, and
- (2) This device must accept any interference received, including interference that may cause undesired operation.

CAUTION

The mains plug on this equipment must be used to disconnect mains power. Please ensure that the socket outlet is installed near the equipment and shall be easily Accessible.

Achtung

Zur Trennung vom Netz ist der Netzstecker aus der Steckdose zu ziehen, welche sich in der Nähe des Gerätes befinden muß und leicht zugänglich sein soll.

Table of Contents

Safety Regulations 2

Introduction

Features 6
 Stand-alone operation 6
 Computer-controlled operation 6
 Others 6
Unpacking 7
Parts and controls 8
System requirements 10

Stand-alone Operation - Using the Drive as a DVD Recorder

Creating DVDs 11
 Recording procedure 11
 Recording methods 11
 Discs that can be used 12
 Recording mode 12
 About titles and chapters on
 a disc 13
Synchronized recording 14
Manual recording 18
Additional operations 21
 Selecting a recording mode 21
 Selecting a chapter interval 21
 Creating titles manually 21
 Selecting automatic playback
 mode 22
 Finalizing a Disc 22
 Erasing a Disc 24
 Selecting a player-type 25

Using the Drive as an External DVD Drive

Connecting the drive to
a computer 26
 Connecting the drive to a
 computer 26
 Installing the driver 27
 Disconnection 32
About software 33
 Notes on using other software
 with the drive 34
Maximizing performance 35
 Reaching the highest possible
 data transfer rate 35
 Updating the firmware 35
 Using 48x read/write speed for
 CDs 35

Discs

Compatible discs 36
 Recommended discs 38
Features of writable discs 39
Precautions on writing/playing
discs 42

Additional Information

Precautions 44
Support overview 45
 User support web site 45
 Update the drive firmware 45
 Technical support 45
Specifications 46
Troubleshooting 48

- **Power-Burn** is a trademark of Sony Corporation.
c o n f o r m e d
- Pentium is a registered trademark of Intel Corporation.
- Microsoft and Windows are registered trademarks of Microsoft Corporation.
- Other system and product names used herein are registered trademarks or trademarks of their respective manufacturers, although the ™ and ® marks are not used in the text.
- Manufactured under license from Dolby Laboratories.
Dolby and the double-D symbol are trademarks of Dolby Laboratories.

- Our product warranty is valid only when the supplied accessories (including software) are used in the specified or recommended system environment, in accordance with the documentation, and applies only to this DVD/CD rewritable drive. Our customer service and user support apply only under these product warranty conditions.
- Please note that we cannot accept responsibility for failure of the computer or other devices, incompatibility with special hardware, operating problems caused by improper installation of software, loss of data, discs or other accidental or incidental damage that might occur when using this product.
- The guarantee and user support for this product are valid only within the countries or sales regions specified on the warranty card.
- Copyright laws prohibit the copying in part or in full of the supplied software and documentation, or loaning the software, without obtaining permission of the copyright holder.
- We cannot accept responsibility for any direct or indirect financial damage or loss of profit that might occur when using the supplied software.
- The supplied software can only be used with this product.
- Specifications of the supplied software may be changed without notice in the interest of product improvement.

Please Record Responsibly

Before copying anything onto a disc, please be sure that you are not violating copyright laws. Most software companies allow you to make a backup or archive copy of software. Check your software's license agreement for details.

Copyrights

- Television programs, films, video tapes, discs, and other materials may be copyrighted. Unauthorized recording of such material may be contrary to the provisions of the copyright laws. Also, use of this product with cable television transmission may require authorization from the cable television transmitter and/or program owner.
- This product incorporates copyright protection technology that is protected by U.S. patents and other intellectual property rights. Use of this copyright protection technology must be authorized by Macrovision, and is intended for home and other limited viewing uses only unless otherwise authorized by Macrovision. Reverse engineering or disassembly is prohibited.

Features

This drive offers the following features.

Stand-alone operation

You can use this drive as a stand-alone DVD recorder to record videos on DVD+R or DVD+RW discs directly from connected video cameras and AV devices.

- ❑ Synchronized recording allows the drive to record videos automatically, synchronized with the operations carried out on the connected video device.
- ❑ You can create titles or chapters either automatically or manually.

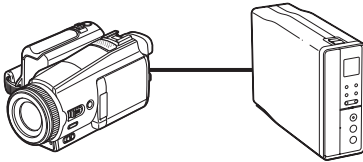

Computer-controlled operation

- ❑ A video recordable DVD drive with Hi-Speed USB (USB 2.0-compliant) interfaces for computers, and analog audio/video input terminals for video devices.
- ❑ The drive can write to seven types of disc, including a DVD+R Double Layer disc.
- ❑ The drive can write at a maximum speed of 16x when using high speed DVD+R discs.
- ❑ Adopts the **Power-Burn**_{conformed} technology to prevent buffer underrun errors.

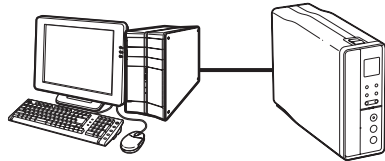

Others

- ❑ Hardware MPEG encoder captures video signals.
- ❑ The drive can be placed vertically or horizontally.

Unpacking

Please confirm that the package contains the following items. If any of these items appear to be missing and/or damaged, please contact your dealer.

- Drive

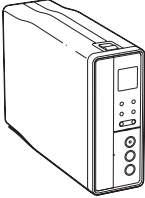

- Hi-Speed USB cable ×1

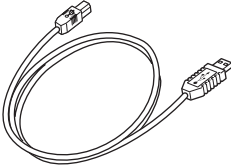

- Power cord

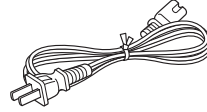

- AC adaptor (MPA-AC1)

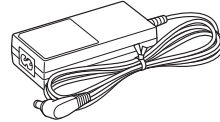

- Quick Start Guide
- Operating instructions (this document)
- Nero Quick Start Guide
- Software disc
- Warranty card

Note

Make sure that you back up the supplied software disc on another disc because the software disc is not distributed separately.

Parts and controls

Front Panel

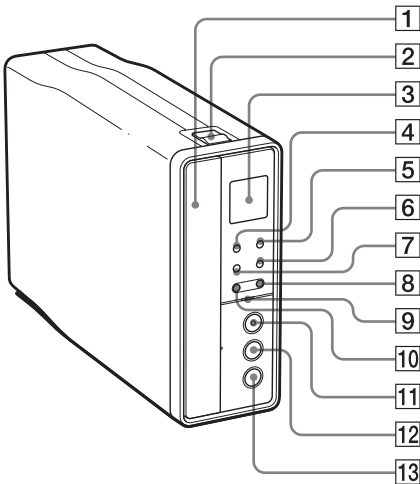

1 Disc tray

Insert discs here, label side to the left.

Hint

When you insert a disc into the drive, make sure that you set the disc inside the two lower pins. When using the drive horizontally, make sure that it is under the four pins.

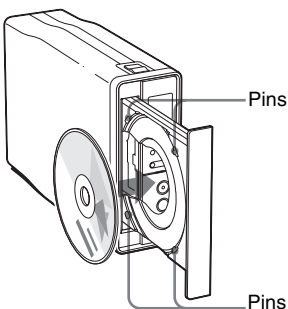

2 Eject button

Opens and closes the disc tray.

3 Display window

4 TIME button

Displays time passed or time remaining.

5 SYNC (synchronize) button

Activates the synchronized recording.

6 INPUT SELECT button

Selects an input signal to be recorded.

7 REC MODE button

Selects a recording mode.

8 SELECT button

Selects the mode of the function.

9 Busy indicator

Indicates the drive status.

Lit (green)

- The power is on.

Blinking (greenish orange)

- The drive is accessing the disc, such as reading, playing or writing.

Off

- The power is off.

10 FUNCTION/ENTER button

Selects a function to be operated.

11 REC (record) button

Starts recording videos.

12 PAUSE button

Pauses recording.





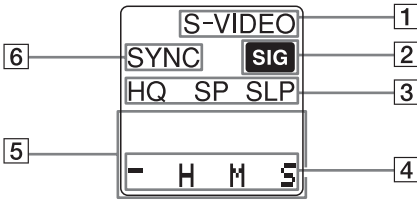

13 STOP button

Stops recording.

Display Window

The display window works only when the drive is used as the stand-alone DVD recorder (p. 11), and indicates the following:



- 1** Input signal ( p. 14, 18)
- 2** Video signal indicator ( p. 14, 18)
- 3** Recording mode ( p. 21)
- 4** Status and warning messages ( p. 48)
- 5** Time display (time passed or time remaining) ( p. 17, 20)
- 6** Synchronized recording ( p. 14)

Rear Panel

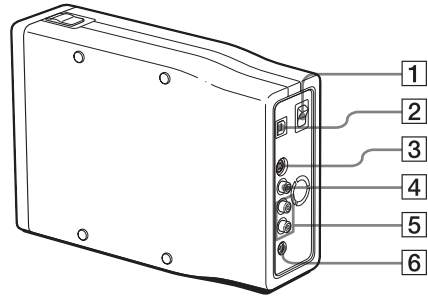

- 1** **Power switch**
Turns the drive on or off.
- 2** **USB connector**
Connect a USB cable when connecting the drive to a computer.
- 3** **S VIDEO IN connector**
Connect an S VIDEO cable (not supplied) when connecting the drive to a video device such as a video camera or VCR.
- 4** **VIDEO IN connector**
Connect a video plug of AV cable (not supplied) when connecting the drive to a video device such as a video camera or VCR.
- 5** **AUDIO IN L/R connectors**
Connect audio plugs of AV cable (not supplied) when connecting the drive to a video device such as a video camera or VCR.
- 6** **DC IN jack**
Connect the supplied AC power adaptor.

System requirements

When connected to a computer, the drive should be used with a system that meets the following requirements¹⁾.

- ❑ CPU: Pentium III, 800 MHz or higher (with NeroVision Express: Pentium 4, 1.6 GHz recommended)
- ❑ RAM: 256 MB or higher
- ❑ 1 GB (with NeroVision Express: 10 GB) free hard disk space
- ❑ Operating system:
Windows 2000 Professional (referred to as Windows 2000),
Windows XP Home Edition or
Windows XP Professional (referred to as Windows XP)
- ❑ Hi-Speed USB (USB2.0) port

¹⁾ The above requirements are the minimum necessary requirements to write to disc normally. Under actual operating conditions, the requirements imposed by your software must also be met. For details, refer to your software documentation.

Notes

- You must use discs that are compatible with the write speed you have selected.
- Writing speed may automatically be adjusted depending on the disc, specified disc speed, or disc conditions such as weight imbalance and eccentricity.
- System should meet following requirements in order to use USB 2.0 operation with this device.
 - Hi-Speed USB (USB 2.0-compliant) interface cable (included).
 - System equipped with a Hi-Speed USB (USB 2.0-compliant) connector or PCI adaptor card, and running the USB 2.0 EHCI device driver¹⁾.
- When connected to a product that does not support Hi-Speed USB, the maximum transfer rate is limited to 12 Mbps (equivalent to a USB 1.1 transfer rate).

¹⁾ The USB 2.0 EHCI driver software is supplied with currently available PCI adaptor cards that conform to USB 2.0. You can also use the USB 2.0 EHCI driver software supplied with Windows 2000 SP4 and Windows XP SP1. For details, contact your USB 2.0 adaptor dealer or consult the Microsoft Corporation Web site.

Creating DVDs

You can use this drive as a stand-alone DVD recorder to record videos on DVD+R or DVD+RW discs directly from a connected video cameras or video devices such as VCRs.

Note

Stand-alone operation of the drive is not available when the drive is connected to a computer with the USB cable and the computer is turned on.

Recording procedure

You can record videos from video cameras or VCRs to a DVD using the following procedure.



- Connect a playback device to the drive.
- ↓
- Turn on and set up the connected device.
- ↓
- Turn on the drive, and insert a disc.
- ↓
- Set up the drive according to the input signal, recording mode used, etc.
- ↓
- Start recording.

Hint

The recording settings you make on the drive remain as they are until you change them.

Recording methods

The drive features synchronized recording mode and manual recording mode.

Recording method	Operation
Synchronized recording  page 14	The drive will start/stop recording automatically when it detects signals from the connected playback device.
Manual recording  page 18	You can start/pause/stop recording manually by operating the drive and the connected device respectively.

Discs that can be used

In stand-alone operation, you can use only DVD+RW or DVD+R discs.

Note

You cannot make additional recording on discs that have been created using computers or other DVD recorders by the stand-alone operation.

Recording mode

Three recording modes are available. Select a recording mode according to your priority - picture quality or recording duration.

Mode	Picture quality	Recording time	
		Single layer disc	Double layer disc
HQ (default)	High	Approx. 1 hour	Approx. 2 hours
SP	Standard	Approx. 2 hours	Approx. 4 hours
SLP	Low	Approx. 6 hours	Approx. 12 hours

About titles and chapters on a disc

What are titles and chapters?

DVD contents consist of sections, called titles, and smaller sub-sections, called chapters.

On this drive, a title is created between the points where you start and stop a recording.

Chapters are created automatically at specified intervals (5, 10, or 15 minutes), or they can be created manually.

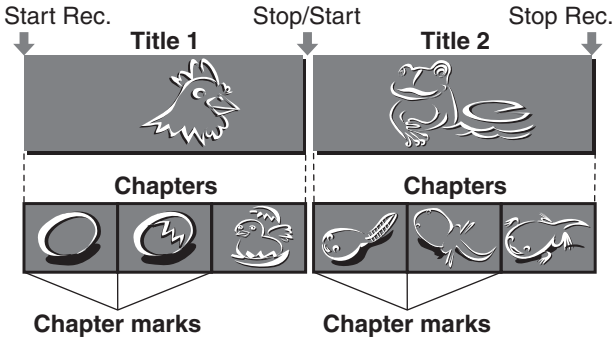

Maximum number of titles on a disc

No additional titles can be created after title 49.

Recording will not be initiated on a disc on which 49 titles have already been recorded.

Maximum number of chapters in a title

No additional chapters can be created after a total of 99 automatic and manual chapters have been marked out.

Synchronized recording

You can record videos on DVD+RW or DVD+R discs while playing them back on your video device.

Connect the video device to the drive using an AV cable, and the drive will start/stop recording automatically when you start/stop playback on the video device. In synchronized recording, the drive starts/stops recording when it detects signals from the video device.

Note

Synchronized recording may not operate properly or entirely in the following cases:

- The video device continues to output signals even after playback has stopped. For example, standard VCRs output signals from the built-in tuner after they stop playback of tapes, therefore, the drive keeps detecting signals and does not stop recording. To avoid this, set the VCR so that it does not output signals when it is not playing back tape, by switching the input selection to line-in, etc. This symptom will occur with some video cameras that output a video signal to make blue or plain back-screen. In this case, disable the signal for back-screen on your video cameras.
- The drive has detected a copy protection signal. Recording stops.
- Videos may not be recorded for a moment when recording has just started.

1 Connect a video device.

Refer also to the manual supplied with the device to be connected.

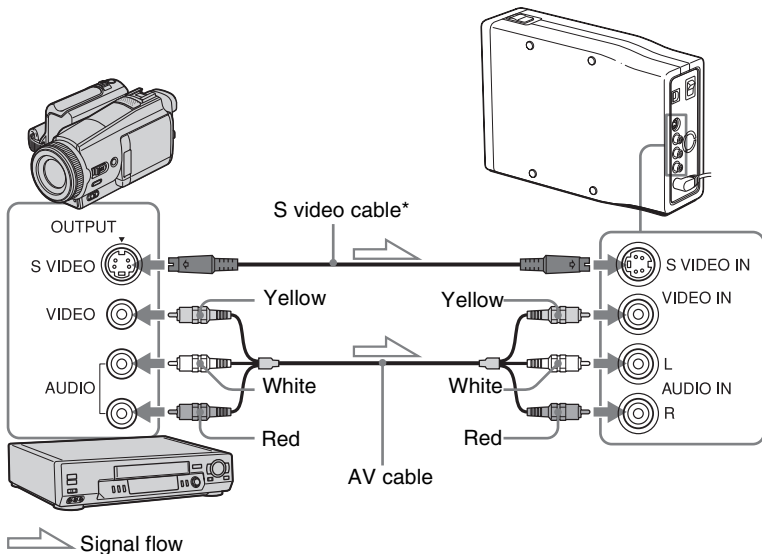

* When the video camera or VCR has the S VIDEO jack.

2 Turn on the drive.

The busy indicator lights up in green.

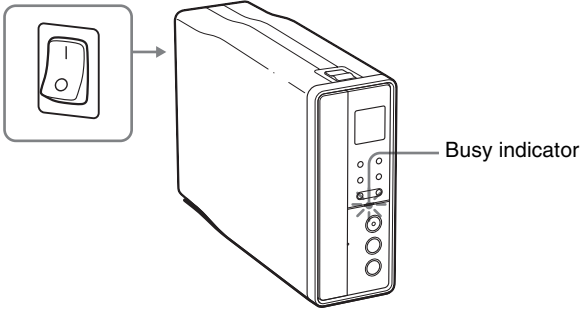

3 Press EJECT, and insert a disc.

A new blank disc is formatted automatically. Wait until [Format] on the display window changes to [Ready].

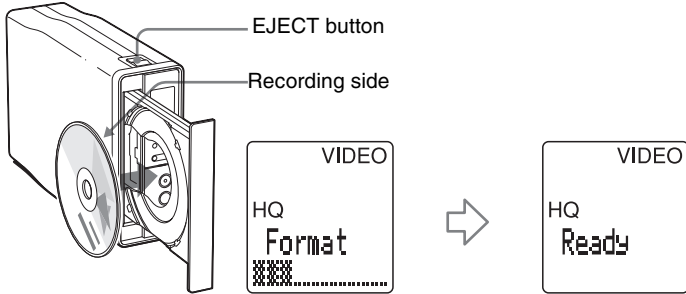

➔ *Continued*

4 Select the recording conditions.

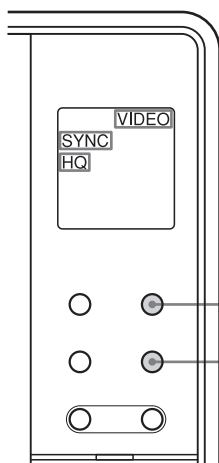

Display [VIDEO] by pressing INPUT SELECT.
If you have connected an S video cable, display [S-VIDEO].
Each time you press the button, [VIDEO] or [S-VIDEO] appears in turn.

Display [SYNC] by pressing SYNC.

To select a recording mode, see “Selecting a recording mode” on page 21.
To select a chapter interval, see “Selecting a chapter interval” on page 21.
To select how to start playback, see “Selecting automatic playback mode” on page 22.

5 Press REC on the drive.

The drive comes in standby for recording.

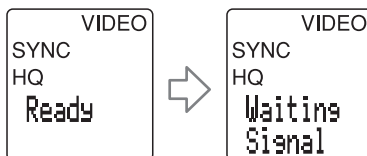
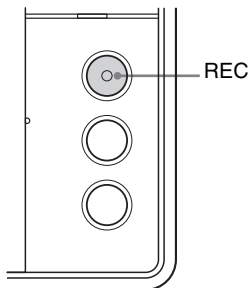

6 Start playback on the video device.

[Recording] appears on the display window and the REC button lights up during recording.

[SIG] on the display window indicates that the drive is receiving signals from the video device.

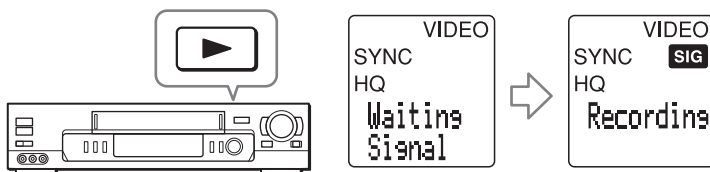

- Recording stops automatically when playback ends.
- When the video signal is interrupted, the drive pauses. If the drive detects no video signals after 2 minutes, it stops.

7 Press STOP to stop recording.

[STOP] appears on the display window, and the drive stops recording automatically. Wait for a moment until [Ready] appears.

Note on using a DVD+R disc

To play a recorded DVD+R on DVD devices, you need to finalize the disc after recording (p. 22).

To pause recording

Press PAUSE. [Pause] appears on the display window.

To resume recording, press REC or PAUSE again.

Recording pauses also when you stop playback on the video device. To resume recording, restart playback.

To check the time passed or remaining

Press TIME.

Each time you press TIME, the time passed within the current title or the time remaining within the disc appears in turn.

Manual recording

You can start/pause/stop recording manually by operating the drive and the connected device respectively.

1 Connect a video device.

See “Synchronized recording” on page 14.

2 Turn on the drive.

The busy indicator lights up in green.

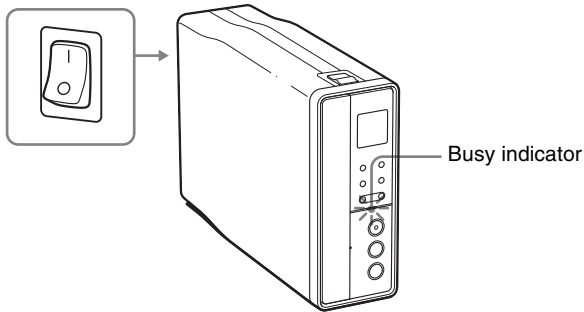

3 Press EJECT, and insert a disc.

A new blank disc is formatted automatically. Wait until [Format] on the display window changes to [Ready].

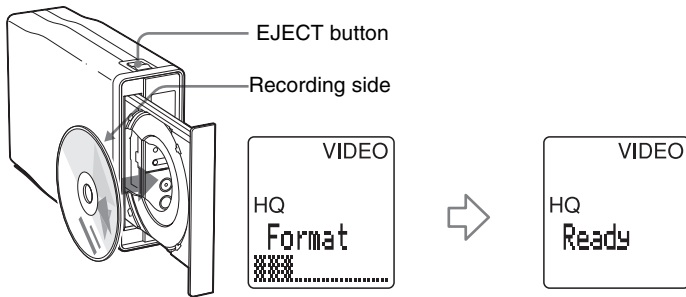

4 Select the recording conditions.

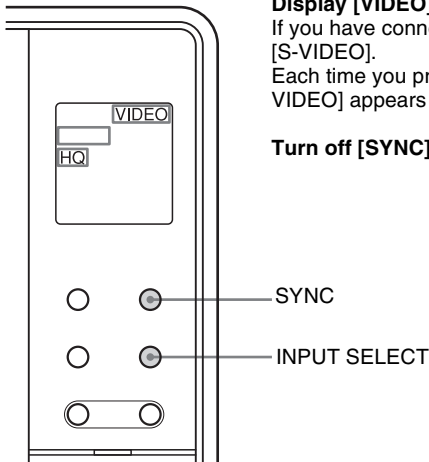

Display [VIDEO] by pressing INPUT SELECT.
If you have connected an S video cable, display [S-VIDEO].
Each time you press the button, [VIDEO] or [S-VIDEO] appears in turn.

Turn off [SYNC] by pressing SYNC.

To select a recording mode, see “Selecting a recording mode” on page 21.
To select a chapter interval, see “Selecting a chapter interval” on page 21.
To select how to start playback, see “Selecting automatic playback mode” on page 22.

5 On the video device, search the start point you want to record and set it in the playback pause mode.

6 Press REC on the drive, and start playback on the connected device.

[Recording] appears on the display window and the REC button lights up during recording.

[SIG] on the display window indicates that the drive is receiving signals from the connected device.

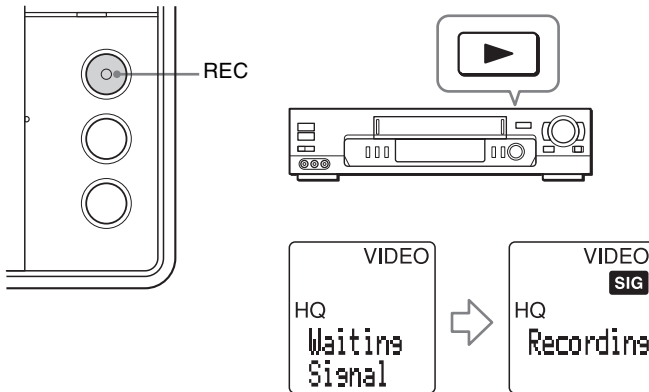

➔ *Continued*

7 Press STOP to stop recording.

[STOP] appears on the display window, and stop playback on the video device.
Wait for a moment until [Ready] appears.

Note on using a DVD+R disc

To play a recorded DVD+R on DVD devices, you need to finalize the disc after recording (p. 22).

To pause recording

Press PAUSE. [Pause] appears on the display window.
To resume recording, press REC or PAUSE again.

To check the time passed or remaining

Press TIME.

Each time you press TIME, the time passed within the current title or the time remaining within the disc appears in turn.

Additional operations

Selecting a recording mode

Press REC MODE.

Each time you press the button, [HQ], [SP], or [SLP] appears in sequence. See page 12 for details on the recording mode.

Note

You cannot do this operation during recording.

Selecting a chapter interval

See page 13 for details on chapters.

1 Display [Auto Chp] by pressing FUNCTION/ENTER.

Each time you press the button, [Finalize?], [Erase All?], [Auto Play?], [Auto Chp], or [PlayerType] appears in sequence.

2 Press SELECT to select the interval.

Each time you press the button, [5 minutes], [10 minutes], [15 minutes], or [None] appears in sequence.

Note

You cannot do this operation during recording

To create chapters manually

Select [None] for [Auto Chp].

The videos are recorded as one chapter until you pause recording.

Pressing REC during recording also writes a chapter mark.

Creating titles manually

Stop recording. The videos are recorded as one title until you stop recording.

Selecting automatic playback mode

You can set automatic playback mode on the disc before recording. In the default setting ([No]), the disc is to start playback with displaying the menu screen of the title recorded.

1 Display [AutoPlay?] by pressing FUNCTION/ENTER.

Each time you press the button, [Finalize?], [Erase All?], [Auto Play?], [Auto Chp], or [PlayerType] appears in sequence.

2 Press SELECT to select [Yes] or [No].

When you select [Yes] (automatic playback mode is on), the disc starts playback on a DVD player with the first title recorded.

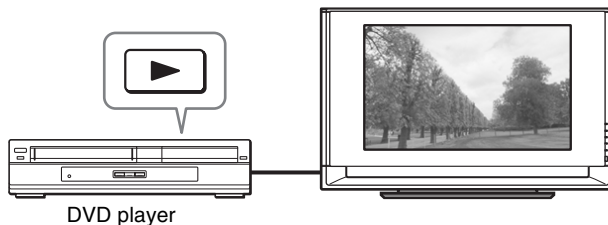

When you select [No] (automatic playback mode is off), the disc starts playback on a DVD player with displaying the menu screen of the titles recorded.

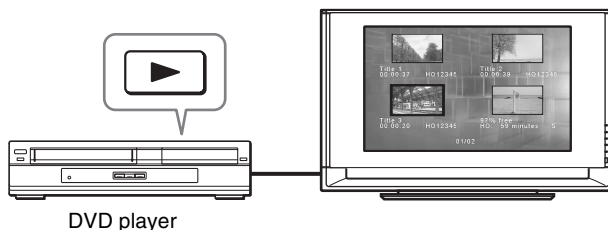

Finalizing a Disc

You need to finalize DVD+R discs after recording to play them back on other DVD devices. You **cannot** edit or record on them after finalizing.

You do not need to finalize DVD+RW discs. (DVD+RW discs are finalized automatically after recording. You can edit or record on them even after finalizing.)

1 Turn on the drive.

The busy indicator lights up in green.

2 Press EJECT, and insert a disc.

Wait until [Ready] appears on the display window.

3 Press FUNCTION/ENTER repeatedly to display [Finalize?] on the display window.

Each time you press the button, [Finalize?], [Erase All?], [Auto Play?], [Auto Chp], or [PlayerType] appears in sequence.

```

VIDEO
SYNC
HQ
Finalize?
[No]/ Yes

```

4 Press SELECT to select [Yes].

If you do not finalize the disc, select [No].

5 Press FUNCTION/ENTER.

[Reconfirm?] appears on the display window.

```

VIDEO
SYNC
HQ
Reconfirm?
[No]/ Yes

```

6 Press SELECT to select [Yes].

If you do not finalize the disc, select [No].

7 Press FUNCTION/ENTER.

Finalizing of the disc starts.

When finalizing is complete, [Finalize Complete] appears.

```

VIDEO
SYNC
HQ
Finalizing
████████████████████

```

➔

```

VIDEO
SYNC
HQ
Finalize
Complete

```

8 Eject the disc.

Notes

- Depending on the disc condition, recording condition, or DVD device, discs may not play even if the discs are finalized.
- The drive can finalize only the discs recorded on this drive.
- It may take about five minutes or more to finalize a disc. Please wait until [Finalize Complete] is displayed.

Erasing a Disc

You can erase the contents of DVD+RWs recorded on this drive. This operation erases all of the contents in the disc at once.

1 Turn on the drive.

The busy indicator lights up in green.

2 Press EJECT, and insert a disc.

Wait until [Ready] appears on the display window.

3 Press FUNCTION/ENTER repeatedly to display [Erase All?] on the display window.

Each time you press the button, [Finalize?], [Erase All?], [Auto Play?], [Auto Chp], or [PlayerType] appears in sequence.

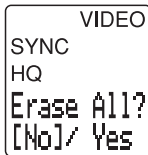

```
VIDEO
SYNC
HQ
Erase All?
[No]/ Yes
```

4 Press SELECT to select [Yes].

If you do not erase the disc, select [No].

5 Press FUNCTION/ENTER.

[Reconfirm?] appears on the display window.

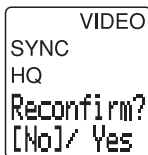

```
VIDEO
SYNC
HQ
Reconfirm?
[No]/ Yes
```

6 Press SELECT to select [Yes].

If you do not erase the disc, select [No].

7 Press FUNCTION/ENTER.

Erasing of the disc starts.

When erasing is complete, [Ready] appears.

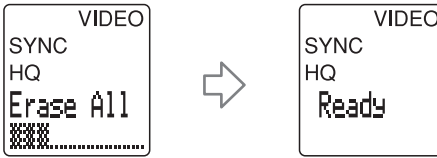

8 Eject the disc.

Note

You cannot erase title by title, or chapter by chapter.

Selecting a player-type

Double layer discs may encounter a compatibility problem with some DVD players. Changing the player-type setting may solve this problem.

1 Display [PlayerType] by pressing FUNCTION/ENTER.

Each time you press the button, [Finalize?], [Erase All?], [Auto Play?], [Auto Chp], or [PlayerType] appears in sequence.

2 Press SELECT to select the type [A] or [B].

Normally select [A]. If you cannot play back the disc due to the compatibility problem, select [B] and record again using the disc.

Notes

- This setting is only applicable to the DVD+R DL (double layer) discs.
- The player-type must be set prior to recording the disc. You cannot change the player-type of the disc after recording.

Connecting the drive to a computer

Connect the drive to a computer using the supplied USB cable to use the drive as an external DVD drive. When connecting the drive to your computer for the first time, you need to install the driver software.

Note

When the drive is connected to a computer, you cannot use the drive as a DVD recorder in stand-alone operation. The buttons and display window of the drive do not function.

Connecting the drive to a computer

- 1 Connect the supplied USB cable, the power cord, and the AC adaptor to the drive.

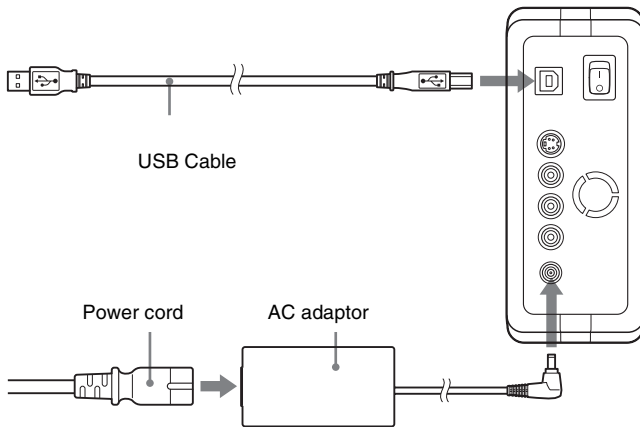

- 2 Turn on the drive.

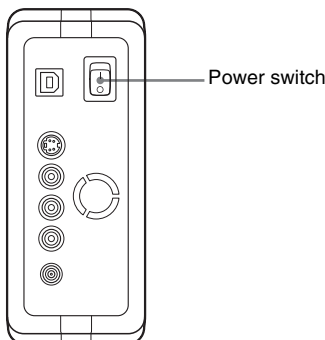

- 3 Turn on your computer.
- 4 Connect the other end of the USB cable to your computer.

Note

Please connect the drive directly to a USB connector on the computer.

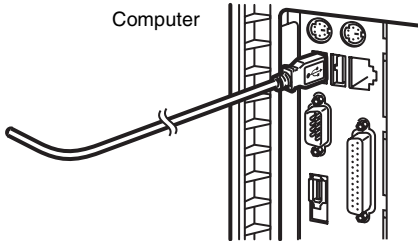

- 5 Install the drive on the computer.
On Windows XP, see below.
On Windows 2000, see page 30.

Installing the driver

On Windows XP

- 1 Insert the supplied software disc into a drive on the computer.
The following screen will appear.



➔ *Continued*

- 2 Check [Install from a list or specific location (Advanced)] (①), then click [Next] (②).

The following screen will appear.

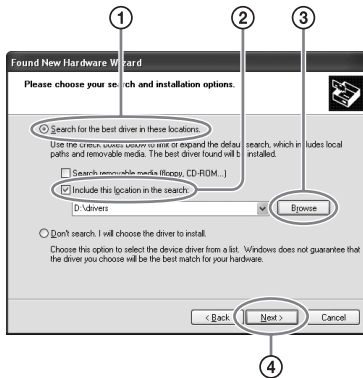

- 3 Check [Search for the best driver in these locations.] (①), [Include this location in the search:] (②), click [Browse] (③), browse for the drive you insert the software disc, then click [OK] (④).

The following screen will appear.

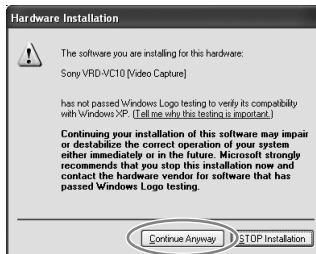

- 4 Make sure that “Sony VRD-VC10 [Video Capture]” is displayed, then click [Continue Anyway].

The following screen will appear.



- 5 Click [Finish], and continue to install the writing software in the supplied software disc following the instructions on the screen.

- 1 Insert the supplied software disc into a drive on the computer.
The following screen will appear.



- 2 Click [Next].
The following screen will appear.

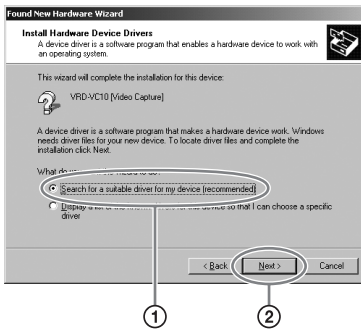

- 3 Check [Search for a suitable driver for my device (recommended)] (1), then click [Next] (2).
The following screen will appear.

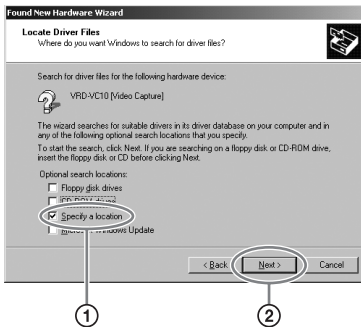

4 Check [Specify a location] (①), then click [Next] (②).

The following screen will appear.

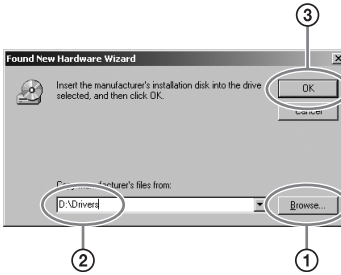

5 Click [Browse] (①), browse for the drive you insert the software disc (②), then click [OK] (③).

The following screen will appear.



6 Make sure that “VRD-VC10 [Video Capture]” is displayed, then click [Next].

The following screen will appear.

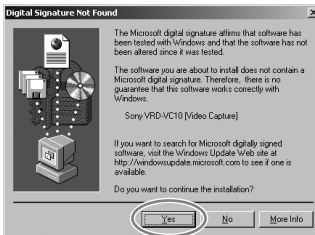

7 Click [Yes].

The following screen will appear.



8 Click [Finish], and continue to install the writing software in the supplied software disc following the instructions on the screen.

Disconnection

The disconnection procedure varies depending on your OS.

When your computer detects the drive successfully,  appears on the Windows task bar. When you want to disconnect the drive, you must first stop it using this icon.

- 1 Click  on the task bar, and click the drive to be disconnected on the shortcut menu.
- 2 Operate following the message displayed, if any.
- 3 Disconnect the USB cable.

Note

If you disconnect the USB cable without performing the procedure above, your computer may operate erratically or data may be damaged. Be sure to perform the procedure above before disconnecting the USB cable.

About software

Use the supplied software to create discs and play back DVDs. The supplied software disc contains the following software. (Refer to the PDF or online documentation of each software for details about their operation.)

Nero StartSmart

Serves as the command center to quickly start all the software of the Nero suite.

Nero Burning ROM SE

Writes data on CDs and DVDs.

Nero Express

A light version of the Nero Burning ROM software. Makes it easier to create CDs and DVDs.

NeroVision Express

Authoring software to create DVD-Videos and video CDs.

Nero Recode

Compresses your videos to burn and fit them all onto one disc.

Nero ShowTime

Plays back DVD-Videos and video CDs.

Nero BackItUp

Allows to back up the data from a hard disk to DVDs and CDs.

InCD

Packet writing software that supports DVD±RW and CD-RW.

Nero Wave Editor

Audio processing software that allows editing audio files.

Nero Media Player

Audio processing software specialized in playing back music.

Nero Cover Designer

Creates CD and DVD covers and labels.

Nero Toolkit

Utility software consists of Nero CD-DVD Speed, Nero DriveSpeed, and Nero InfoTool.

Notes on using other software with the drive

- Using software other than the supplied software (such as commercially available software, shareware, or freeware) to write data to disc with this drive is not under warranty and Sony provides no customer service.
- Make sure that the supplied writing software and other writing software do not coexist on your computer. Especially if other packet writing software ¹⁾ exists in your computer, the software and/or computer may operate erratically.
- If the commercially available software you are using does not detect the drive correctly, visit the web site of the software manufacturer and update the software, as this may solve the problem.

¹⁾ Such as Drag-to-Disc (ROXIO), Direct CD (ROXIO), B's CLIP (BHA), and DLA (Sonic).

Maximizing performance

Reaching the highest possible data transfer rate

Make sure that you use high-speed certified discs for which this operation has been guaranteed by Sony. For the latest information about these discs, visit the user support web site. When using discs other than those mentioned above, the drive may limit writing speed to preserve a good reading quality.

Updating the firmware

We recommend using the drive with the latest firmware as some problems encountered when using the drive can be solved simply by updating the drive firmware. Firmware updates are available on the user support web site. See page 45 for details.

Hint

The firmware is the built-in software that makes the drive work.

Using 48x read/write speed for CDs

The default read/write speed for CDs of this drive is 40x speed. With a single touch, you can make the read/write speed 48x speed.

Notes

- On rare occasions, some discs may not be able to tolerate 48x speed, causing them to break. We recommend that you do not use deeply scratched, brittle, or other discs that may break at 48x speed.
- This function does not guarantee a 48x write speed. Depending on the condition of the disc you are using, the speed may be lower.
- This function does not increase read/write speed with CD-RW discs.

1 Insert a disc into the drive.

The read/write speed when you insert a disc is normally 40x speed.

2 Press the Eject button for five seconds.

The busy indicator blinks twice and the read/write speed switches to 48x speed.







Hint

When you open the disc tray, the read/write speed reverts to its default of 40x speed.

Compatible discs









The following discs are compatible with the drive.

DVD

Disc types	Logo	Read	Write	Write (Stand-alone)	Write speed ¹⁾
DVD+R		✓	✓	✓	1× to 16×
DVD+R DL (Double layer)		✓	✓	✓	1× to 2.4×
DVD+RW		✓	✓	✓	1× to 4×
DVD-R		✓	✓	—	1× to 8×
DVD-RW		✓	✓	—	1× to 4×
DVD-ROM		✓	—	—	—
DVD-Video		✓	—	—	—

¹⁾ Supported by the drive. Depending on your software and disc, this speed may vary.

CD

Disc types	Logo	Read	Write	Write speed
CD-R		✓	✓	Max. 48×
CD-RW		✓	✓	Max. 4×
CD-RW (High Speed)		✓	✓	Max. 10×
CD-RW (Ultra Speed)		✓	✓	Max. 24×
CD-ROM		✓	—	—
CD-DA (audio only)		✓	—	—
CD Extra		✓	—	—
Video CD		✓	—	—
CD TEXT		✓	—	—

Disc diameters		Read	Write
DVD	12 cm	✓	✓
	8 cm	✓	—
CD	12 cm	✓	✓
	8 cm	✓	✓

Notes

- Only round discs should be used with this drive. Never use odd-shaped discs (stars, hearts, card shape, etc.), otherwise the drive may be damaged.
- It is not guaranteed to write to or play back 99-minute discs.
- With 8 cm discs, you must place the drive horizontally.

Recommended discs

We recommend that you only use discs for which operation has been guaranteed. You can obtain the latest list of writable discs for which operation with this drive has been guaranteed at the user support web site (see page 45 for details).

Note

You can safely use most disc formats that comply with the appropriate standards with this drive. However, bear in mind that some commercially available discs do not comply with the quality or performance standards that are necessary to use with this drive. If you use such discs, the drive may automatically adjust the writing speed, may not be able to write at all, etc. Even if the discs are successfully written, they may cause errors at the time of reading.

Features of writable discs

You can use various discs with the drive to write data. Refer to the table below to find the type of disc that matches what you want to do.

To	DVD+R DVD+R DL	DVD+RW	DVD-R	DVD-RW	CD-R	CD-RW
create DVD-Video that can be played back by most drives and/or players	✓		✓			
create DVDs that you can edit		✓		✓		
create DVDs to which you can add to later.		✓				
create video CDs that can be played back with most computers					✓	
use DVDs like video tapes (allowing multiple rewrites)		✓		✓		
distribute 700 MB of data or more (create DVD-ROM discs)	✓		✓			
distribute data that can be used on most computers (create CD-ROM discs)					✓	
create audio CDs that can be played back on most CD players					✓	
back up your hard disk	✓		✓		✓	
store data without deleting it	✓		✓		✓	
use discs in the same way as floppy discs		✓		✓		✓

Note

You can access/play back the data written to the discs above with most drives/players that support their formats. However, some combinations of drives/players and discs (depending on their quality and/or characteristics) may make access/playback impossible. For details, refer to your drive/player documentation.

Writable CDs and compatibility

The drive can write to CD-R and CD-RW discs, when used with writing software.

To play back (read) these CD-R and CD-RW discs on other CD-ROM drives, make settings on the writing software according to the purpose of the data.

CD-R discs

Data can be written to this type of disc only once, and once it has been written, it cannot be erased. Music CDs created on CD-R disc media can be played on standard CD players.

CD-RW discs

Data can be written to and erased from this type of disc repeatedly. Typically, a new CD-RW disc can be rewritten about 1,000 times.

Music CDs created on CD-RW disc media cannot be played on a CD player unless it is designed to be CD-RW compatible.

High speed CD-RW discs

The drive can write to High Speed CD-RW disc media. Data written on High Speed CD-RW discs can be read by standard CD-ROM drives.

Note

Drives that do not have the High Speed CD-RW logo cannot be used to write to High Speed CD-RW discs. When writing or adding to such discs with a drive other than this one, make sure that the drive has the High Speed CD-RW logo. Also, always set the writing speed to that specified for the particular High Speed CD-RW disc media being used.

Ultra speed CD-RW discs

The drive can write to High Speed CD-RW and Ultra Speed CD-RW disc media. Data written to these discs can be read by standard CD-ROM drives.

Note

Drives that do not have the Ultra Speed CD-RW logo cannot be used to write to Ultra Speed CD-RW discs. When writing or adding to such discs with a drive other than this one, make sure that the drive has the Ultra Speed CD-RW logo. Also, always set the writing speed to that specified for the particular Ultra Speed CD-RW disc media being used.

Writing speed

When writing to CD-R and CD-RW discs, set the writing speed to that specified on the disc. Change the writing speed on the writing software.

About playback/reading compatibility in CDs

CD-R and CD-RW discs created with the drive can be read on most CD-ROM drives. However, some older CD-ROM drives cannot read CD-RW discs.

In addition, CD-R music discs created and finalized with the drive can be played on most CD players, however, there are some CD players and automobile CD players that do not guarantee playback of CD-R discs.

Also, CD-R music discs created with the drive can be played back on many standard CD players. However, depending on the type of your player, playback of CD-R and CD-RW discs may not be supported.

Further, because of the differences in quality and characteristics between various CD-ROM drive, CD player, CD-R disc, and CD-RW disc manufacturers, playback may not be possible depending on the combination.

Writable DVDs and compatibility

The drive can write to DVD+R DL, DVD+R and DVD-R discs, as well as to DVD+RW and DVD-RW discs, when used with writing software. The playback (read) compatibility of data written by this drive depends on the capabilities of the DVD-ROM drives or the DVD players and on the logical format selected when the disc is recorded (written).

DVD+R DL/DVD+R/DVD-R discs

Data can be written to this type of disc only once. Once it has been written, it cannot be erased. Playback (read) compatibility of DVD+R and DVD-R discs depends on the capability of the DVD-ROM drive and the DVD player and on the logical format selected when it is recorded (written).

DVD+RW and DVD-RW discs

Data can be repeatedly written to or erased from this type of disc. Typically, a new DVD+RW or DVD-RW disc can be rewritten about 1,000 times.

Playback (read) compatibility of DVD+RW and DVD-RW discs depends on the capability of the DVD-ROM drive and the DVD player and on the logical format selected when it is recorded (written).

About playback/reading compatibility in DVDs

DVD+R DL/DVD+R/DVD-R discs, as well as DVD+RW and DVD-RW discs created and finalized with the drive can be played back on almost all DVD-ROM drives. However depending on the type of your drive, playback of DVD+R DL, DVD+RW, and DVD-RW discs may not be supported.

In addition, some drives do not support multi-session (DVD+R DL/DVD+R/DVD+RW) or multi-border (DVD-R/DVD-RW). In these cases, you can only play back the disc in single-session (DVD+R DL/DVD+R/DVD+RW) or single-border (DVD-R/DVD-RW).

Also, DVD-Video discs created with the drive can be played back on many standard DVD players. However depending on the type of your player, playback of DVD+RW and DVD-RW discs may not be supported.

Further, because of the differences in quality and characteristics between various DVD-ROM drive, DVD player, DVD+R DL disc, DVD+R disc, DVD+RW disc, DVD-R disc, and DVD-RW disc manufacturers, playback may not be possible depending on the combination. (Playback compatibility is not under warranty.)

Precautions on writing/playing discs

Write speed and compatible discs

- When writing data to disc at high speeds, you must use the appropriate type of disc.
- Set the writing speed on your writing software. For details about the setting procedures, refer to your writing software documentation.
- Writing speed may be adjusted automatically according to the quality of the disc used. Also, writing speed may be limited by the transfer rate of the computer.

DVD region codes

The playback of DVD-Video (DVD discs) is protected and controlled by a region code setting. For the drive to play back DVD-Video, the region code on the DVD disc, the drive, and the DVD-Video playback software must be identical.

With this drive, the region code can be set up to five times, including the initial assignment (RPC phase 2¹) standard). After setting the region code five times, the setting becomes permanent and can no longer be changed. From this point on, you are only able to play back DVD-Video whose region code matches the one set at the fifth time.

Do not attempt to make unauthorized changes to the region code. Any problems resulting from doing so are not covered by the warranty.

Hint

- You can change the region code of the drive on its properties dialog box that is accessible from the Device Manager.
- The DVDs created in stand-alone operation have the region code "All".

1) Region Playback Control (RPC) standard.

Playing back DVD-Video

DVD-Video disc playback conditions are sometimes determined by software manufacturers. Because the drive plays back discs as determined by software manufacturers, some drive functions may not always perform as expected. When playing back DVD-Video, refer to the documentation accompanying each disc.

About copy protected DVDs

Most DVD-Video discs on the market are protected against unauthorized copy. Attempting to copy protected discs violates copyright laws.

About copy controlled CDs

This product is designed to play back discs conforming to the compact disc (CD) standard. Audio CDs encoded with copyright protection technology are now marketed by various record companies. Be aware that some of these discs do not conform to the CD standard and you may not be able to play them back with the drive. When using the drive as an audio CD player, only use audio CDs with the following mark. Some of these discs are encoded in such a way as to prevent sampling and/or copy, while others can only be played back under certain conditions. For details, refer to the documentation of your audio CD.



► Additional Information

Precautions

Operation and storage conditions

Avoid using or storing the drive in a hot or humid location, or where it might be subject to severe vibration or direct sunlight.

Transportation

- Please repack the drive in its original carton when shipping by itself.
- If the drive is to be shipped while installed in a computer, remove any disc beforehand.

Moisture condensation

Do not expose the drive to sudden temperature changes. Do not use the drive immediately after moving it from a cold to a warm location, or raising the room temperature suddenly, as condensation may form within the drive. If the temperature changes suddenly while using the drive, stop using it, but keep the power on for at least an hour.

Handling discs

- Handle discs only by the edges. Never touch the recording surface.

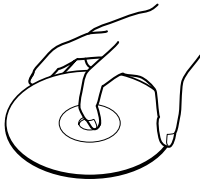

- Do not affix labels on discs.

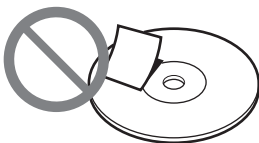

- Do not store discs in dusty, dirty or humid locations, in direct sunlight, or near heat-generating devices.
- To protect important data, always keep discs in their cases.
- Do not wipe writable discs using a disc cleaner before recording data. Instead, use a blower to remove any dust.
- Data may not be recorded properly if there are scratches or dust on the unrecorded area of writable discs. Handle discs very carefully.

Support overview

User support web site

You can find the following information on this web site. The information is periodically updated, so we recommend that you visit regularly.

- Information about the drive
- Information about the software supplied with the drive
- Latest firmware
- Frequently asked questions
- Troubleshooting guide
- Guaranteed compatible computers
- Guaranteed compatible discs
- Operating instructions
- Others

Accessing the user support web site

Sony Storage Support web sites

(As of September, 2004)

<http://sony.storagesupport.com/>

About the Bundled Software

Detailed information about the supplied software is available on the web sites of the software manufacturer.

<http://www.nero.com>

Update the drive firmware

Some problems encountered when using the drive can be solved simply by updating the drive firmware. Firmware updates are available on the user support Web site. Access the site, make sure that there is an update for your firmware, and follow the instructions on the screen to proceed with download and installation.

Technical support

Please visit the above web sites that provide technical support and other information on the drive and the supplied software. When asking questions using telephone or e-mail, please have the following information available:

- Model number: VRD-VC10
- Serial number
- Date and place of purchase
- Computer maker and model number
- Computer specifications (CPU speed, memory size, OS version, etc.)
- Writing software used (version, etc.)

Local technical support is only available in the specified sales regions. The customers in these regions should be provided with a warranty card for this product. For contact information, refer to the warranty card.

Note that technical support conditions may vary according to the locality, and that charges and/or limited service may apply in some regions.

Specifications

Recording (stand-alone)

Video signal format

NTSC color

Video encoding format

MEPG-2

Audio encoding format

Dolby Digital 2 ch

Recordable disc

DVD+R, DVD-R (DL), DVD+RW

Disc recording format

DVD+VR format

DVD/CD drive

Writing systems

DVD:

Random write

Sequential write

CD:

Track-at-once

Disc-at-once

Session-at-once

Packet writing

Access time (average/random stroke)

DVD: Approx. 135 ms

CD: Approx. 140 ms

Buffer capacity

2 MB

Inquiry strings

SONY DVD RW DRU-710A

Laser

CD

Type: DL-7140-211RA

Wavelength: 783 nm

Output power:

260 mW (pulse)

90 mW (CW)

DVD

Type: M L 101 J 25-23

Wavelength: 658 nm

Output power:

250 mW (pulse)

100 mW (CW)

Compatible discs

	Read (max.)	Write (max.)
DVD+R	8×-CAV	2.4×
DVD+R (4×)	8×-CAV	4×
DVD+R (8×)	8×-CAV	8× -PCAV
DVD+R (16×)	8×-CAV	16× -CAV
DVD+R Double Layer	6×-CAV	2.4×
DVD+RW	8×-CAV	2.4×
DVD+RW (4×)	8×-CAV	4×
DVD-R	8×-CAV	1×
DVD-R (4×)	8×-CAV	4×
DVD-R (8×)	8×-CAV	8× -ZCLV
DVD-RW	8×-CAV	1×
DVD-RW (2×)	8×-CAV	2×
DVD-RW (4×)	8×-CAV	4×
DVD-ROM	16×-CAV	—
DVD-Video	6×-CAV	—
CD-R	48×-CAV ¹⁾	48×-CAV
CD-RW	32×-CAV	4×
CD-RW (High Speed)	32×-CAV	10×
CD-RW (Ultra Speed)	32×-CAV	24×-ZCLV
CD-ROM	48×-CAV	—
CD-DA	10×-CAV	—
CD-DA (DAE)	48×-CAV	—

Disc diameters

DVD	12 cm	✓	✓
	8 cm ¹⁾	✓	—
CD	12 cm	✓	✓
	8 cm ¹⁾	✓	✓

¹⁾ Required to place the drive horizontally.

Interface

USB port

Hi-Speed USB (USB 2.0)-compliant

VIDEO input

1 V_{p-p}/75 ohms

S VIDEO input

Y: 1 V_{p-p}/75 ohms

C: 0.286 V_{p-p}/75 ohms

AUDIO input

2 V_{rms}, Impedance more than

47 kilohms

General

Power

DC 12 V (supplied from the DC IN jack)

Consumption

Max. 3.0 A

AC adaptor

AC 100 - 240 V

Use a power cord appropriate to the region or country of use.

Size

Approx. 66 × 164 × 234 mm (W×H×D)
(excluding the projecting parts)

Weight

Approx. 1.8 kg (drive only)









Operating temperature



5 to 35 °C



Design and specifications are subject to change without notice.

Troubleshooting

If you experience any of the following difficulties while using the drive, use this troubleshooting guide to help remedy the problem before requesting repairs. Should any problem persist, consult your dealer.

Symptom	Cause/remedy	See
A recorded disc cannot be played back.	<ul style="list-style-type: none"> → If the disc is a DVD+R disc, it may not have been finalized. Finalize the disc. → The disc you are using may not be of a certified brand by Sony. Try to use a disc of a brand of which operation has been certified by Sony. → The playback device you are using may have an issue on playback compatibility. 	<ul style="list-style-type: none">  p. 22  p. 38  p. 38, 41
No recording can be done.	<ul style="list-style-type: none"> → You can use only DVD+RW or DVD+R discs. You cannot use other discs for this operation. → Select a signal correctly. 	<ul style="list-style-type: none">  p. 12  p. 14  p. 18
A recorded disc cannot be played back.	<ul style="list-style-type: none"> → Finalize the disc. 	<ul style="list-style-type: none">  p. 22
No additional recording can be made.	<ul style="list-style-type: none"> → There are 49 titles in the disc. → You cannot add anything to a finalized DVD+R disc. 	<ul style="list-style-type: none">  p. 13  p. 22

Display	Cause/remedy	See
Disc Error	<ul style="list-style-type: none"> → The drive cannot read or write the disc due to an issue related to the disc, such as scratches, being dirty, low-quality, etc. Try with other disc. → If errors occur frequently with any type of new discs, the drive may have a hardware problem. Contact an authorized service center. 	—
Insert +R/RW DISC	<ul style="list-style-type: none"> → The inserted disc may be unsupported type of discs for stand-alone operation. Use a DVD+R or DVD+RW disc. 	<ul style="list-style-type: none">  p. 12
Format Error	<ul style="list-style-type: none"> → The drive cannot format the disc because of the disc error. 	—
Invalid Operation	<ul style="list-style-type: none"> → You tried to finalize or erase a disc when there is no disc in the drive. → You tried to erase a DVD+R disc. → You tried to finalize a DVD+RW disc. 	<ul style="list-style-type: none">  p. 22

Display	Cause/remedy	See
Recording Prohibited	→ Copyright protection signal (CGMS or Macrovision) was detected. You cannot record the source.	 p. 5
Insert Blank Disc	→ The disc may have been already recorded on other recordable device that is not compatible with this drive. Use a blank disc. → This will appear also when you insert a finalized DVD+R disc.	—
Erase All [No]/Yes	→ The DVD+RW disc may have been recorded on other recordable device. If you want to erase the disc, select [Yes].	 p. 24
Finalize/ Error	→ The disc may have been recorded on other recordable device. Try with other disc. → The disc may not be a DVD+R disc. → The disc may be already finalized.	—
No signal	→ Video input signal is not detected. Check if the AV cable is properly connected with the output terminal on the playback device, or check if the connectors are firmly mated. → Check if input is correctly selected.	—
Disc Full	→ The disc came to full and recording stopped.	—

