

Pioneer

DVD PLAYER

DV-S88A

DV-S838A

Operating Instructions



(This mark applies only to DV-S88A)



IMPORTANT



The lightning flash with arrowhead symbol, within an equilateral triangle, is intended to alert the user to the presence of uninsulated "dangerous voltage" within the product's enclosure that may be of sufficient magnitude to constitute a risk of electric shock to persons.



CAUTION:
TO PREVENT THE RISK OF ELECTRIC SHOCK, DO NOT REMOVE COVER (OR BACK). NO USER-SERVICEABLE PARTS INSIDE. REFER SERVICING TO QUALIFIED SERVICE PERSONNEL.



The exclamation point within an equilateral triangle is intended to alert the user to the presence of important operating and maintenance (servicing) instructions in the literature accompanying the appliance. **H002_En**

CAUTION : USE OF CONTROLS OR ADJUSTMENTS OR PERFORMANCE OF PROCEDURES OTHER THAN THOSE SPECIFIED HEREIN MAY RESULT IN HAZARDOUS RADIATION EXPOSURE.

CAUTION : THE USE OF OPTICAL INSTRUMENTS WITH THIS PRODUCT WILL INCREASE EYE HAZARD. **H013_En**

WARNING: THE APPARATUS IS NOT WATERPROOFS, TO PREVENT FIRE OR SHOCK HAZARD, DO NOT EXPOSE THIS APPLIANCE TO RAIN OR MOISTURE AND DO NOT PUT ANY WATER SOURCE NEAR THIS APPARATUS, SUCH AS VASE, FLOWER POT, COSMETICS CONTAINER AND MEDICINE BOTTLE ETC. **H001AEn**

WARNING: BEFORE PLUGGING IN THE UNIT FOR THE FIRST TIME, READ THE FOLLOWING SECTION CAREFULLY. THE VOLTAGE OF THE AVAILABLE POWER SUPPLY DIFFERS ACCORDING TO COUNTRY OR REGION, BE SURE THAT THE POWER SUPPLY VOLTAGE OF THE AREA WHERE THIS UNIT WILL BE USED MEETS THE REQUIRED VOLTAGE (E.G., 230V OR 120V) WRITTEN ON THE REAR PANEL. **H041_En**

CAUTION:

THE STANDBY/ON BUTTON IS SECONDARY CONNECTED AND THEREFORE DOES NOT SEPARATE THE UNIT FROM MAINS POWER IN STANDBY POSITION. THEREFORE INSTALL THE UNIT SUITABLE PLACES EASY TO DISCONNECT THE MAINS PLUG IN CASE OF THE ACCIDENT. THE MAINS PLUG OF UNIT SHOULD BE UNPLUGGED FROM THE WALL SOCKET WHEN LEFT UNUSED FOR A LONG PERIOD OF TIME. **H017BEn**

CAUTION

This product contains a laser diode of higher class than 1. To ensure continued safety, do not remove any covers or attempt to gain access to the inside of the product.

Refer all servicing to qualified personnel.

The following caution label appears on your unit.

Location: rear of the unit

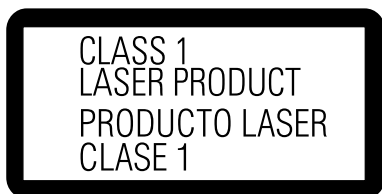

H018

CONGRATULATIONS ON YOUR PURCHASE OF THIS FINE PIONEER PRODUCT.

Pioneer is on the leading edge of DVD research for consumer products and this unit incorporates the latest technological developments.

We are sure you will be fully satisfied with the DVD player.

Thank you for your support.

Please read through these operating instructions so you will know how to operate your model properly. After you have finished reading the instructions, put them away in a safe place for future reference.









- This player is not suitable for commercial use.

This product incorporates copyright protection technology that is protected by method claims of certain U. S. patents and other intellectual property rights owned by Macrovision Corporation and other rights owners. Use of this copyright protection technology must be Authorized by Macrovision Corporation, and is intended for home and other limited viewing uses only unless otherwise authorized by Macrovision Corporation. Reverse engineering or disassembly is prohibited.

Features of This Player

Compatible with DVD, Video CD and CD formats

DVD, Video CD and CD discs that display the logos shown below can be played back on PIONEER DVD players. For more information on discs compatible with this player, refer to the table below.

Types of playable discs and their marks	Diameter/ Playable sides	Playback time											
 	12 cm (5in.)/ single-sided <table border="1" style="display: inline-table; vertical-align: middle;"> <tr> <td>1 layer</td> <td>133 min.</td> </tr> <tr> <td>2 layer</td> <td>242 min.</td> </tr> </table>	1 layer	133 min.	2 layer	242 min.	Digital audio Digital video (MPEG 2)							
	1 layer	133 min.											
	2 layer	242 min.											
	12 cm (5in.)/ double-sided <table border="1" style="display: inline-table; vertical-align: middle;"> <tr> <td>1 layer</td> <td>266 min.</td> </tr> <tr> <td>2 layer</td> <td>484 min.</td> </tr> </table>	1 layer	266 min.	2 layer	484 min.								
1 layer	266 min.												
2 layer	484 min.												
DVD-Audio DVD-Video <table border="1" style="display: inline-table; vertical-align: middle;"> <tr> <td>8 cm (3 in.)/ single-sided</td> <td>1 layer</td> <td>41 min.</td> </tr> <tr> <td></td> <td>2 layer</td> <td>75 min.</td> </tr> <tr> <td>8 cm (3 in.)/ double-sided</td> <td>1 layer</td> <td>82 min.</td> </tr> <tr> <td></td> <td>2 layer</td> <td>150 min.</td> </tr> </table>	8 cm (3 in.)/ single-sided	1 layer	41 min.		2 layer	75 min.	8 cm (3 in.)/ double-sided	1 layer	82 min.		2 layer	150 min.	Digital audio Digital video (MPEG 2)
8 cm (3 in.)/ single-sided	1 layer	41 min.											
	2 layer	75 min.											
8 cm (3 in.)/ double-sided	1 layer	82 min.											
	2 layer	150 min.											
(DV-S88A only) 	DVD-RW 12 cm (5in.)/ single-sided 8 cm (3 in.)/ single-sided	Digital audio Digital video (MPEG 2) Max. 360 min. Max. 100 min.											
VIDEO CD 	VIDEO CD 12 cm (5 in.)/ single-sided	Digital audio Digital video (MPEG 1) Max. 74 minutes											
	VIDEO CD single 8 cm (3 in.)/ single-sided	Digital audio Digital video (MPEG 1) Max. 20 minutes											
CD   	CD 12 cm (5 in.)/ single-sided 	Digital audio Max. 74 minutes											
	CD single 8 cm (3 in.)/ single-sided 	Digital audio Max. 20 minutes											

The disc format logos shown above are found on disc labels or on disc jackets.

- To prevent malfunction, do not use an 8 cm (3 in.) adaptor (for CDs).
- Discs other than the ones indicated above cannot be played on this unit.
- DVDs that have incompatible region numbers, DVD-ROM, DVD-RAM, and CD-ROM cannot be played on this unit. The region number of the player can be found on the rear panel.

* Playing DVD-RW discs (DV-S88A only)

- You may not be able to play non-finalized DVD-RW discs.
- Copyrighted content originally provided with the permission of one generation and recorded on DVD discs cannot be played on this player.
- When playing a DVD-RW disc that was edited on a DVD recorder, you may see scenes from just before the edited point. This is not a malfunction.
- Up to 20 characters of a title name can be displayed.

** Playing recordable CDs

- Note that this unit cannot record onto recordable discs.
- This unit can play music-use CD-R and CD-RW discs. However, depending on the condition of the CD-Recorder and the disc, you may find that not all discs will play successfully. (For example, if the disc is scratched or dirty, or if the player's pickup lens is dirty.)

Superlative audio performance from built in DVD-Audio, Dolby Digital*, DTS** and MPEG decoders

The 192kHz/24bit-compatible DAC inside the DV-S88A/DV-S838A delivers breath-taking sound quality with DVD-Audio, Dolby Digital and DTS discs.

The DV-S88A/DV-S838A is compatible with both 2-channel (192kHz/24bit) and multi-channel (96kHz/24bit) DVD-Audio discs thanks to its 5.1-channel audio outputs.

In addition, Dolby Digital, DTS and MPEG decoders are built-in so you can connect the DV-S88A/DV-S838A directly to an AV amplifier with 5.1 channel inputs to enjoy cinema-like surround sound.

525 line digital progressive-scan component video output (NTSC)

Compared to standard interlaced video, progressive scan effectively doubles the amount of video information fed to your TV or monitor. The result is a stable, flicker-free image. (Check your TV/monitor for compatibility with this feature.)

For the very highest picture quality, try watching a movie on DVD-Video on a progressive-scan compatible TV.

The DV-S88A/DV-S838A offers complete flexibility and compatibility with all types of AV equipment with composite video and S-Video outputs, as well as component video outs.

Digital Noise Reduction PRO (Video Quality Enhancer)

This new type of **DNR** (Digital Noise Reduction) for encoding video (called VQE or Video Quality Enhancer) enables you to adjust the video settings on a more detailed and exact level. There are three possible settings to choose from. These include: **TV (CRT)**, **Projector**, and **Professional**. This technology can remember which setting you've chosen and employ it at the proper time.

Frame Search

The NTSC system displays pictures at 30 frames/second; PAL* at 25 frames/second. With this DVD player you can locate and display a specific frame from anywhere on the disc.

* Playback of PAL discs is not possible on the DV-S88A.

Easy setup and adjustment using on-screen menus

Press **SETUP** on the remote control to open the Setup screen and you'll find setting up and adjusting the system easy to do with on-screen menus conveniently organized and arranged. Additionally, on-screen information (ⓘ) appears to clarify the functions and explain the options available.

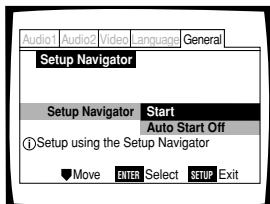

Answer a few questions and have all the necessary audio, video, and on-screen language adjustments set automatically by the player using the Setup Navigator (page 20).

Smooth variable speed scanning in forward and reverse directions

This player incorporates technology that enables smooth playback of DVDs and Video CDs not only at different speeds but also in both forward and reverse directions. Control the direction and scanning speeds from 1/16 normal play speed to extremely quick scanning using the **MULTI DIAL** on the remote control (page 52).

Wide range of DVD viewing options

Multi-Angle (page 39)★

You can view scenes from different camera angles when watching movies or other media with multiple angle playback available.

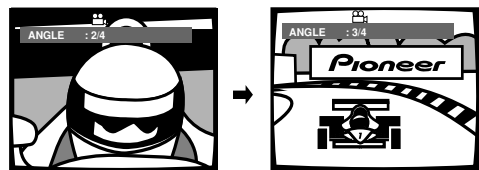

Multiple Languages (page 41)★

You can select the language on when watching movies or other media that have multiple language and/or audio soundtracks recorded on them.

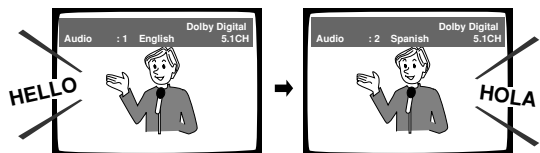

Multi-Language Subtitles (page 42)★

You can select a subtitle language or turn subtitles off when watching movies or other media with subtitles available.

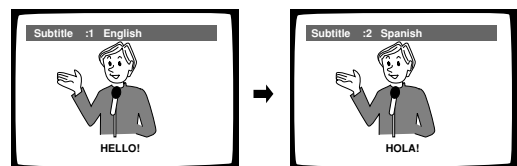

★This mark indicates this may not be possible with certain discs.

Energy-saving design

This unit is designed to use less than 1 W of energy when this player is in standby mode.

- * Manufactured under license from Dolby Laboratories. "Dolby" and the double-D symbol are trademarks of Dolby Laboratories. Confidential unpublished works. © 1992-1997 Dolby Laboratories. All rights reserved.
- ** "DTS" and "DTS Digital Surround" are trademarks of Digital Theater Systems, Inc. Manufactured under license from Digital Theater Systems, Inc.

Differences in Disc Composition

DVD

DVD-Videos are divided into units referred to as titles, and titles are divided into chapters. A DVD which contains a movie may have only one title with many or no chapter divisions. Karaoke DVDs may have many titles, assigning a title to each song on the disc. Menu screens do not belong to any title.

DVD player functions generally apply to titles on a disc or chapters within a selected title. The player functions available may also vary from title to title, depending on the disc. When discs have a unique title division, it should be noted that search and program functions may be affected.

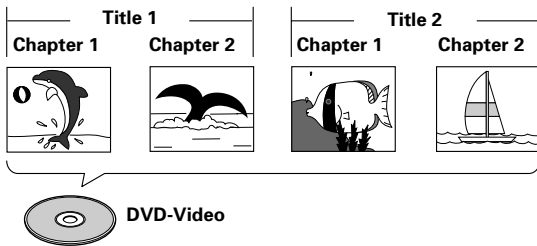

DVD-Audio discs are divided up into units known as groups, and each group is further divided into tracks. Generally speaking, a single song corresponds to a single track, however, tracks may also be divided into indexes. Menu screens and video material common to DVD-Video discs may also be included on some discs.

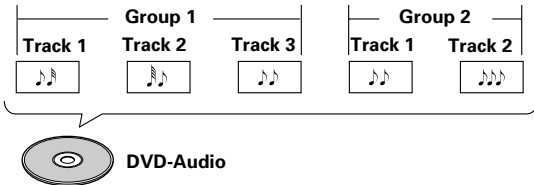

Video CD/CD

Video CDs and CDs are divided into units referred to as tracks (Video CD tracks may also be referred to as scenes). One song generally corresponds to one track. Some tracks are further divided into units referred to as indexes. Video CDs with PBC (Playback Control) also contain menus recorded on the disc which enable easy access to the contents of the disc.

When played back on a DVD player, both Video CDs and CDs are considered to be a single title, regardless of the number of tracks.

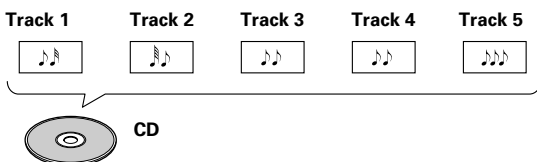
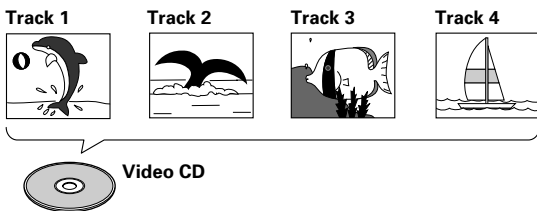

How to Proceed in This Manual

DVD is an incredible format that presents the highest quality digital audio and video available today. The amount of information that can be recorded onto a DVD disc is remarkable, allowing it to offer numerous functions and features available with no other format. Because using the DVD player and DVDs may be confusing at first, following the order below should help you get through the important stages of getting set up so you can start using your player as soon as possible.

Get familiar with the player.

Refer to the section *"Before Using"* on page 8 to confirm that all the accessories were included with the player. If you are new to DVD, it might be beneficial for you to go through the *"Names and Functions"* section starting on page 9 to get familiar with the parts and buttons on the main unit and remote control as they will be referred to throughout this manual.

There is also a list of terms that can be found on page 68 if you are having trouble understanding some of the terminology associated with DVD.

Make the necessary connections.

No entertainment system seems to be set up exactly the same way. The *"Making Connections"* section starting on page 14 shows how video and audio connections may be made to suit your home entertainment system.

Set up the necessary player menus.

Before you can begin to enjoy the benefits of the DVD format, it is first necessary to set up the player to output the video and audio information that corresponds to your system. The section *"Setting Up the Player"* starting on page 20 explains how to use the Setup Navigator, a function that automatically sets up the player corresponding to the answers given in a multiple-choice on-screen procedure. The Setup screen menus, described in the section starting on page 28, are also used in a number of other functions. Learning the procedure for operating these menus will make using this player much easier and more enjoyable.

Play a disc.

When all the connections and setups have been made, you are ready to play a DVD, Video CD, or CD with the player. The section *"Getting Started Using Your DVD Player"* starting on page 24 outlines the basic player operations.

Enjoy the many features available.

Once you are comfortable using the basic player functions, you are ready to take advantage of the various options DVD and this player have to offer. The section *"Advanced Functions"* starting on page 45 describes how to use the features available on many DVDs.

Table of contents

Features of This Player 4

- Differences in Disc Composition 6
- How to Proceed in This Manual 6

Before Using 8

- Checking Accessories 8
- Preparing the Remote Control 8

Names and Functions 9

- Front Panel 9
- Display Window 10
- Rear Panel 11
- Remote Control 12

Making Connections 14

- Connecting Your DVD Player 14
- Audio Connections 16
- Video Connections 18
- System Control Connections 19
- TV SYSTEM switch (except for DV-S88A)
..... 19

Setting Up the Player 20

- Using the Setup Navigator 20

Getting Started Using Your DVD Player 24

- Playing DVDs, Video CDs and CDs 24
- Playing DVD-RWs (DV-S88A only) 25
- Chapter (Track) Skip Forward/Skip5 Back 26
- Forward and Reverse Scanning 26
- Resuming playback from where you stopped
..... 27
- Stopping Playback and Switching Power Off
..... 27

Adjusting Audio and Video Settings 28

- Using the Setup Screen Menus 28
- Changing to the Setup Menu Mode 29
- Setting the Digital Audio Output to be
Compatible with your AV Component 30
- Adjusting the Dynamic Range of the Audio
Soundtrack 32
- Setting Analog Audio Connections to an AV
Amplifier or Receiver 31
- Setting Your Speaker System for Multichannel
Audio Playback 33
- Adjust the output level from the speakers
(Gain setting) 34
- Listening to higher quality CD sound
(CD Digital Direct) 35
- Setting the TV Screen Size 36
- 525 line Digital Progressive Scan Compatible
Video Output 37

- Switching the S-Video Output 38
- Selecting the type of paused image to display
..... 38
- Setting the position of the on-screen display
..... 38
- Viewing from a Desired Camera Angle (Multi-
Angle) 39
- Selecting the type of search mode 39

Setting the Language Options 40

- Setting the on-screen display (OSD) language
..... 40
- Setting Language and Subtitle Preferences in
the Setup Screen Menus 40
- Changing the Audio Language
(Multi-Language Function) 41
- Selecting a Subtitle Language
(Multi-Language Subtitles) 42

Advanced Functions 45

- Setting the Parental Lock Level 45
- Turning the Screen Saver On and Off 47
- Changing the Background Color of the Screen
..... 48
- Bonus Group 48
- Auto Disc Menu 48
- Adjusting the Video Quality
(Digital Noise Reduction) 49
- Still Frame/Slow Play/Frame Advance Playback
..... 51
- Scanning in Forward and Reverse Directions at
Different Speeds 52
- Manual scanning using the Jog Mode 52
- Searching for a Title/Group, Chapter/Track, or
Location on a Disc 53
- Repeat Play 54
- Random Play 55
- Playback in a Desired Order (Program Play)
..... 56
- Continuing Playback from a Specified Location
(Last Memory) 59
- Memorizing Regularly Used Menu Settings
(Function Memory) 60
- Memorizing Settings for Often Viewed DVDs
(Condition Memory) 61
- Viewing Disc Information 62
- Resetting the Player to System Settings 63
- Language Code List 64

Additional Information 65

- Disc Care 65
- For Proper and Long Use of This Unit 65
- Troubleshooting 66
- Terms 68
- Specifications 70

Before Using

Checking Accessories

Please confirm that the following were received with the player.

Audio cord

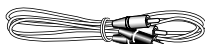

Video cord

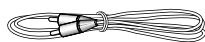

Power cord

DV-S88A



DV-S838A



Remote control unit

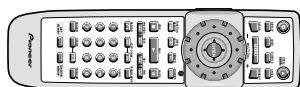

AA/R6P dry cell batteries

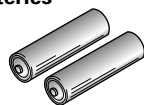

- When disposing of used batteries, please comply with governmental regulations or environmental public instruction's rules that apply in your country or area.

H048 En

Operating instructions (this manual)

Preparing the Remote Control

Inserting batteries into the remote control

- 1 While pushing the tab on the battery compartment cover toward the center of the remote, pull out in the direction indicated by the arrow.

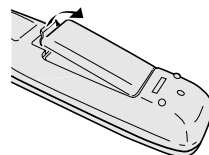

- 2 Insert batteries.

Make sure to match the plus (+) and minus (-) polarity guides on the batteries with the marks inside the battery compartment.

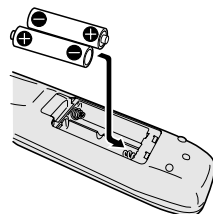

- 3 Close the cover.

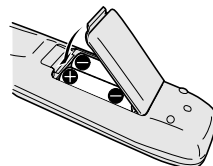

Notes

- Do not mix old and new batteries.
- When replacing batteries, use all new batteries.
- When not using the remote control for a long period of time (over 1 month), remove the batteries to avoid possible damage from battery corrosion. If battery leakage occurs, wipe the battery liquid from the battery component, then insert new batteries.

Remote control operation

When operating the remote control, point it at the remote sensor (SR) located on the player's front panel. The remote control can be used up to 7 m from the player and within a 30° angle on each side of the sensor.

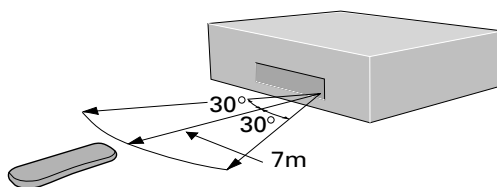

Notes

- Exposing the remote sensor to direct sunlight or strong light may cause faulty operation.
- If the **CONTROL IN** jack on the player's rear panel is connected to the **CONTROL OUT** jack of another component, point the remote control at the other component to operate the player. Operation will not be possible when pointed at this player (page 19).

Names and Functions

Front Panel

Illustration is DV-S838A

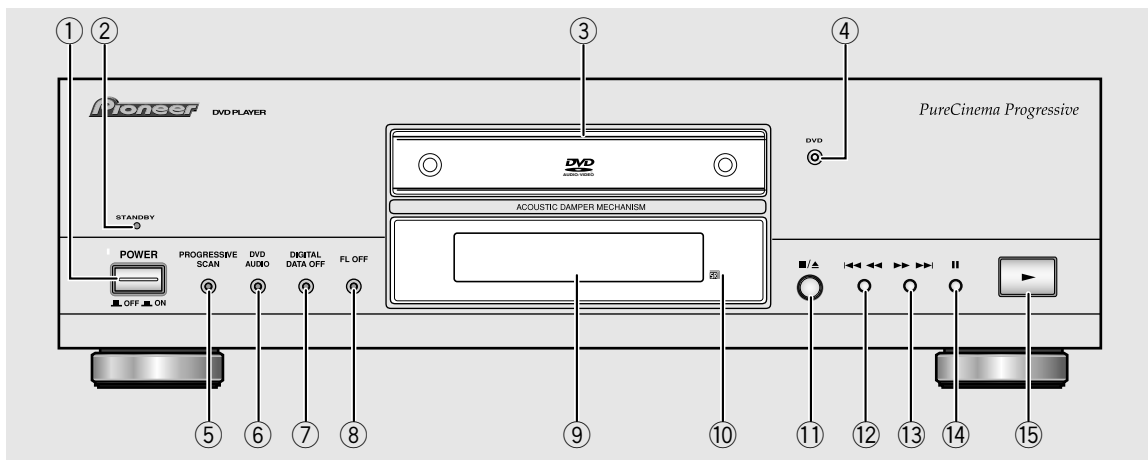

① **⏻ STANDBY/ON button (DV-S88A)**

Press to switch the player on or to put in standby (pages 24, 27).

POWER switch (DV-S838A)

Press to switch the player on or off (pages 24, 27).

② **STANDBY indicator**

Lights when the player is in standby, using a minimum amount of power to maintain system settings (pages 24, 27).

③ **Disc tray**

When loading a disc, place discs in the disc tray with the label side facing up (pages 24, 27).

④ **DVD indicator**

Lights when a DVD disc is loaded.

⑤ **PROGRESSIVE SCAN indicator**

Lights when unit is outputting 525 line progressive scan (non-interlaced) video.

⑥ **DVD-AUDIO indicator**

Lights when a DVD-Audio playback.

⑦ **DIGITAL DATA OFF indicator**

Lights when unit is set to Digital Out Off (page 31).

⑧ **FL OFF indicator**

Lights when the fluorescent (FL) display is switched off.

⑨ **Display window**

Displays system information (page 10).

⑩ **Remote sensor**

Point the remote control toward the remote sensor to operate the player (page 8).

⑪ **■/▲ (stop/open/close) button**

Press to open and close the disc tray (pages 24, 27). Press to stop playback. Pressing once enables playback to resume from a point shortly before the location where it stopped. During playback, press twice to open the disc tray (page 27).

⑫ **◀◀◀ (reverse) button**

Press to go back to previous title/chapters/tracks. Press and hold to perform reverse playback scanning (pages 26).

⑬ **▶▶▶ (forward) button**

Press to advance to title/chapters/tracks. Press and hold to perform fast-forward scanning (page 26).

⑭ **⏸ (pause) button**

Press during playback to pause. Press again to resume playback (page 51).

⑮ **▶ (play) button**

Press to start or resume playback (pages 24, 27).

Display Window

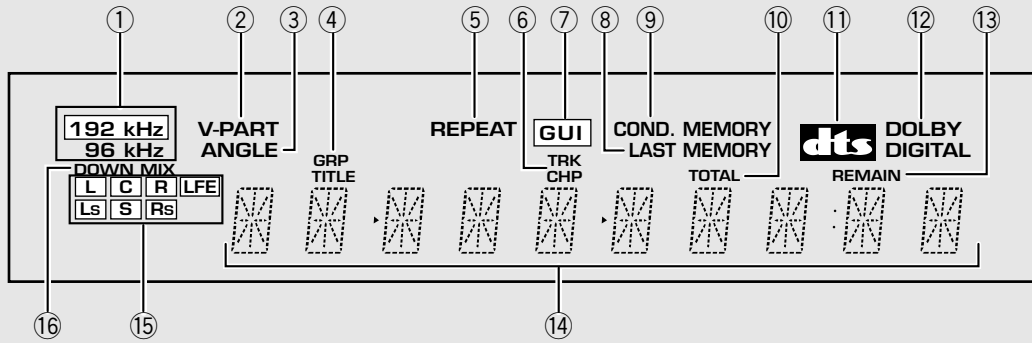

- ① 192 kHz/96 kHz indicator**
Indicates a DVD disc containing high-sampling rate (192 kHz/96 kHz) audio is playing.
- ② V-PART indicator**
Indicates that video part of DVD discs playback.
- ③ ANGLE indicator**
Indicates Multi-Angle playback is in progress (page 39).
- ④ GRP/TITLE indicator**
Indicates a group/title number is being displayed.
- ⑤ REPEAT indicator**
Indicates that the Repeat function is on and that the current title, chapter, or track is being repeated (page 54).
- ⑥ TRK/CHP indicator**
Indicates a track/chapter number is being displayed.
- ⑦ GUI indicator**
Indicates a player menu operation is being performed (page 20).
- ⑧ LAST MEMORY indicator**
Indicates the Last Memory location is recorded in memory for the currently loaded DVD or Video CD (page 59).
- ⑨ COND. MEMORY indicator**
Indicates that Condition Memory settings are memorized for the currently loaded DVD (page 61).
- ⑩ TOTAL indicator**
Indicates that the disc in the player is stopped and **DISPLAY** has been pressed (page 62).
- ⑪ DTS indicator**
Indicates DTS audio playback.
- ⑫ DOLBY DIGITAL indicator**
Indicates Dolby Digital audio playback.
- ⑬ REMAIN indicator**
Indicates that the remaining playback time of a title or chapter/track is being displayed.
- ⑭ Counter display**
Displays the playback mode, type of disc, title and chapter/track numbers, playback time, etc.
- ⑮ Program Format indicators**
During multichannel audio playback, indicate which channels are present in the soundtrack.
L : Left front *1*2, **C** : Center *1, **R** : Right front *1*2,
Ls : Left surround*1, **S** : Surround (mono) *1*2,
Rs : Right surround*1,
LFE : The LFE (low frequency effects) channel indicator indicates 5.1 channel audio that contains a channel for low frequency sounds that are used by the sub woofer*1
*1 : Indicates DVD-Audio, Dolby Digital, DTS or MPEG playback.
*2 : Indicates Dolby Pro Logic playback.
- ⑯ DOWNMIX indicator**
During multichannel audio playback, indicates that the output signal has been “downmixed” from the original audio source. This is an automatic function performed by the player in order to present the most appropriate audio mix to the speakers present in your system.

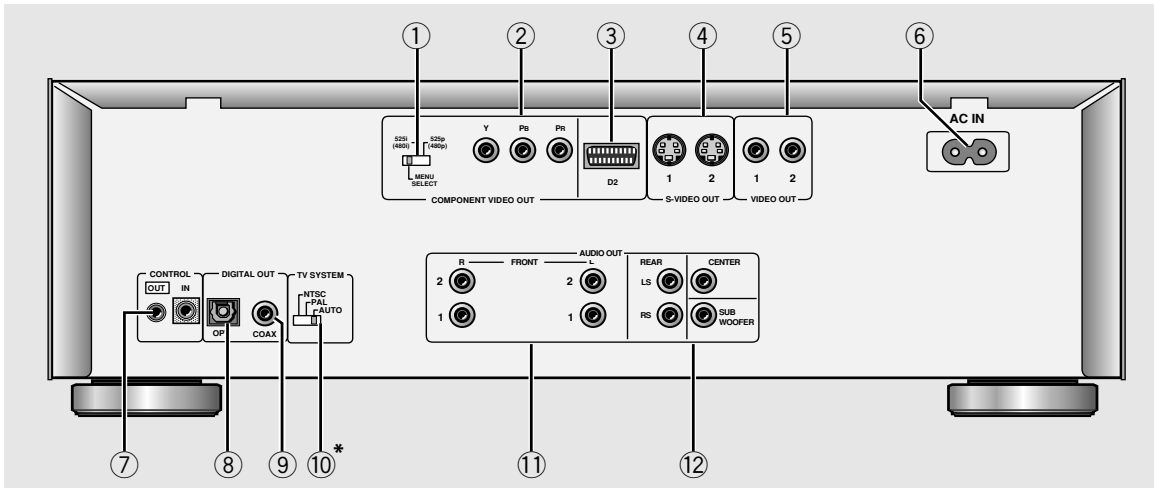

① COMPONENT VIDEO OUT switch

You only need to set this switch if you're using an NTSC TV/monitor connected via the component video outputs of this player. This player can output NTSC video as a standard interlaced signal (the **525i(480i)** setting), or as a non-interlaced, or progressive scan signal (the **525p(480p)** setting). If your TV/monitor is compatible with progressive scan video, set this switch to either **525p(480p)** or **MENU SELECT**. When set to **MENU SELECT**, you can use the on-screen Setup menu to switch between progressive and interlaced video output. If your TV/monitor is not progressive scan compatible, you will not be able to see any picture if this player is set to output progressive scan video. In this case, set the switch to **525i(480i)** to restore the picture (page 37).

② COMPONENT VIDEO OUT jacks (Interlace/Progressive-scan)

If your TV or monitor has component video inputs, you can produce a higher quality picture on your TV or monitor by connecting to the component video outputs on this unit (page 18).

③ D2 jack (Interlace/Progressive-scan)

If your TV or monitor has D video input, you can produce a higher quality picture on your TV or monitor by connecting to the D2 video output on this unit (page 18).

④ S-VIDEO OUT jacks

If your TV or monitor has an S-video input, clear picture reproduction is possible by connecting the player to your TV or monitor via the S-Video jack (page 18).

You can switch between **[S1]** and **[S2]** S-video output from the Setup menu (page 38).

⑤ VIDEO OUT jacks

Connect to the video input on a TV or monitor or AV amplifier or receiver with video input capability. (pages 14, 18).

⑥ AC IN power cord connection terminal

Use to connect the power cord to the wall outlet (pages 14, 15).

⑦ CONTROL IN/OUT jacks

Use to connect this player to another component bearing the Pioneer mark. This lets you control this unit as though it were a component in a system. Player operations are then performed by pointing the remote control at the component that the player is connected to (page 19).

⑧ DIGITAL OUT jack (optical (OPT))

Use to output the digital audio signal recorded on discs. You can output the digital signal via either optical output jack to an AV amplifier or receiver (page 16).

⑨ DIGITAL OUT jack (coaxial (COAX))

Use to output the digital audio signal recorded on discs. You can output the digital signal via either coaxial output jack to an AV amplifier or receiver (page 16).

⑩ TV SYSTEM switch* (DV-S838A only)

Use to change the TV signal mode to either **PAL** or **NTSC** according to the type of TV and disc to be used. When the switch is in the **AUTO** position, the player outputs the format on the disc as is (page 19).

⑪ AUDIO OUT FRONT jacks

Use to output two-channel audio (analog) to the audio stereo inputs on a TV or stereo amplifier. If you are connecting to a receiver that has both digital and analog input jacks for DVD player connection, it may be beneficial to make both connections (pages 14, 17).

⑫ AUDIO OUT (5.1 channel) jacks

Use to output 6 discrete audio channels of decoded digital audio to a receiver or amplifier with discrete audio inputs (pages 15, 17).

Remote Control

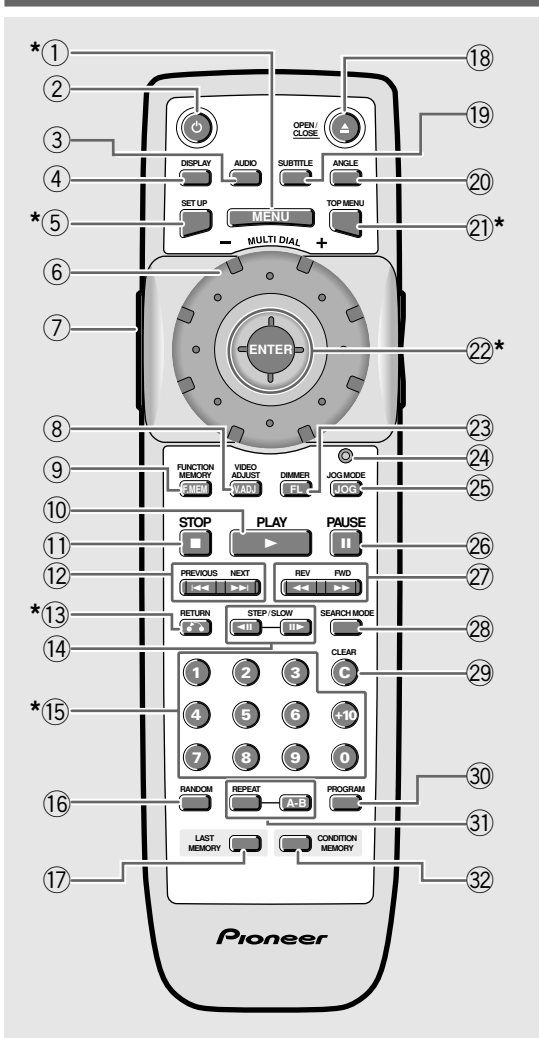

(Buttons indicated with * are used for menu operation.)

- ① **MENU button***
Use to display or close the DVD-Video menu screen (page 25).
- ② **⏻ (Standby/On) button**
Press to switch the player on or to put in standby (pages 24, 27).
- ③ **AUDIO button**
Press repeatedly to select one of the audio languages and/or audio formats programmed on a DVD (page 41).
For Video CD and CD, each press changes the audio output as follows.

Stereo → 1/L (Left) → 2/R (Right)
- ④ **DISPLAY button**
Press during playback to display statistical disc information. Press repeatedly to display different information (page 62).
- ⑤ **SETUP button***
Press when the player is in either play or stop mode to open and close the Setup screen (pages 20, 28).
- ⑥ **MULTI DIAL**
Use to control the rate of playback according to the speed at which **MULTI DIAL** is turned. When the Jog Mode is on, frame by frame scanning in both forward and reverse directions is possible (page 52).
- ⑦ **LIGHTING button (side panel)**
Use to illuminate the main operation buttons on the remote control. When pressed, the buttons light for approximately 6 seconds. This function is convenient for locating the command buttons when the room is dark.
- ⑧ **VIDEO ADJUST (V.ADJ) button**
Various attributes of the video presentation can be adjusted to suit the program type or personal preferences. Press **VIDEO ADJUST (V.ADJ)** to display the on-screen options (page 49).
- ⑨ **FUNCTION MEMORY (F.MEM) button**
Press to incorporate a menu item into a shortcut list that is stored in memory and can be called up at any time (page 60).
- ⑩ **PLAY ► button**
Press to start disc playback (page 24).
- ⑪ **STOP ■ button**
Press to stop playback. Pressing once enables playback to resume from a point shortly before the location where it was stopped. Pressing twice causes the disc to return to the beginning of the disc when playback starts again (page 27).

12 PREVIOUS ◀◀/NEXT ▶▶ buttons

During playback, press **PREVIOUS** ◀◀ to go back to a previous chapter/track and **NEXT** ▶▶ to advance to the next chapter/track (page 26).

13 RETURN ↶ button*

Use to go one menu back (current settings are maintained). Use **RETURN** ↶ when you do not want to change the option setting in a menu (pages 20, 25, 29).

14 STEP/SLOW ◀II/II▶ buttons

Press **STEP/SLOW** II▶ during playback to view slow playback. In pause mode, press **STEP/SLOW** II▶ to advance DVDs and Video CDs frame by frame and **STEP/SLOW** ◀II to back up a DVD a few frames at a time (page 51).

15 Number buttons (1-9, 0, +10)*

Use to perform direct title/group and chapter/track searches, and to input numerical values.

16 RANDOM button

Press to play titles/groups/chapters/tracks in random order (page 55).

17 LAST MEMORY button

You can resume DVD-Video or Video CD playback from the point you last watched even if the disc is removed from the player. Press **LAST MEMORY** during playback to set a Last Memory point. When you want to resume playback of that disc, press **LAST MEMORY** in the stop mode and playback starts from the memorized point. Last Memory locations can be stored for up to 5 DVDs and 1 Video CD (page 59).

18 OPEN/CLOSE ▲ button

Press to open or close the disc tray (pages 24, 27).

19 SUBTITLE button

Press repeatedly to select one of the subtitle languages programmed on a DVD or to turn the subtitles off (page 42).

20 ANGLE button

Some DVDs are recorded with various camera angle playback options. Press **ANGLE** repeatedly to display different camera angles (page 39).

21 TOP MENU button*

Press to call up the top menu programmed on the DVD. Depending on the DVD, the top menu may be identical to the DVD menu (page 25).

22 Cursor control joystick*

Use to move the cursor through the options on menu screens and to change settings.

ENTER button*

Press to implement settings selected with the cursor control joystick or to set items highlighted in a menu.

23 DIMMER (FL) button

Press to change the brightness of the FL display and DVD indicator in four steps: maximum brightness, medium brightness, minimum brightness, and off. When the FL display is turned off, the **FL OFF** indicator on the front panel lights.

24 JOG MODE indicator

Lights red when the player is in the Jog Mode (page 52).

25 JOG MODE (JOG) button

Press to put the player in the Jog Mode. When this mode is on, rotate **MULTI DIAL** clockwise to scan frame by frame in the forward direction and counterclockwise to scan frame by frame in the reverse direction (page 52).

26 PAUSE II button

Press to pause playback of a disc. Press again to resume playback (page 51).

27 REV ◀◀/FWD ▶▶ (fast reverse/ fast forward) buttons

During playback of DVD and Video CD, press **FWD** ▶▶ to perform fast forward scanning. Press **REV** ◀◀ to perform fast reverse scanning of DVD and Video CD. When a CD is loaded, audio scanning is performed (page 26).

28 SEARCH MODE button

Press to perform a title/group, chapter/track, elapsed time search or time & frame search (page 53).

29 CLEAR button

Works in conjunction with a number of player functions. Use to cancel repeat and random playback, and to edit programs.

30 PROGRAM button

You can program titles, groups, chapters, or tracks to play back in a desired order. Programs can be a maximum of 24 steps. Additionally, DVD-Video programs for up to 24 discs can be stored in the player's memory for future use (page 56).

31 REPEAT button

Press once to repeat playback of current chapter/track. Press twice to repeat playback of current title/group (page 54).

A-B button

Press at the beginning and end of the section you want to repeat or to mark a location you want to return to (page 54).

32 CONDITION MEMORY button

You can store in memory the settings for up to 15 DVD-Videos. Press **CONDITION MEMORY** during DVD-Video playback to memorize the settings (page 61).

Making Connections

Connecting Your DVD Player

Unlike any other audiovisual media format, DVD offers a wide array of audio and video output options which allows playback to be enjoyed in any number of system configurations from a standard TV with stereo audio input to a home theater system with a TV or monitor and full surround sound capabilities.

Connection Guide

The illustration on this page shows the basic setup using the audio and video cords included with this player. Use this illustration as a guide to setting up your home system.

An explanation of each type of audio and video connection available can be found on **pages 16 to 18**. To determine the best audio and video connection setup for your system, refer to the manuals supplied with the components you are making connections to.

In addition to making physical connections to your TV or monitor, it is also necessary to assign the TV screen size. You can use the **[Setup Navigator]** in the Setup screen **General** menu to set whether you are using a wide screen or standard size TV or monitor (**page 20**).

Additionally, you can use the **[TV Screen]** setting in the Setup screen **Video** menu (**page 36**).

Notes

- When making connections to this unit or when changing connections, check that the unit is off by pressing **⏻ STANDBY/ON** (or **POWER**) and unplug the power cord from the power outlet.
- The video output on this player uses copy protect circuitry to prevent the video playback on DVDs from being copied. If you connect the player to a TV via a VCR, or record and play back the contents of a disc with a VCR, the playback picture may not be normal.

Illustration is DV-S838A

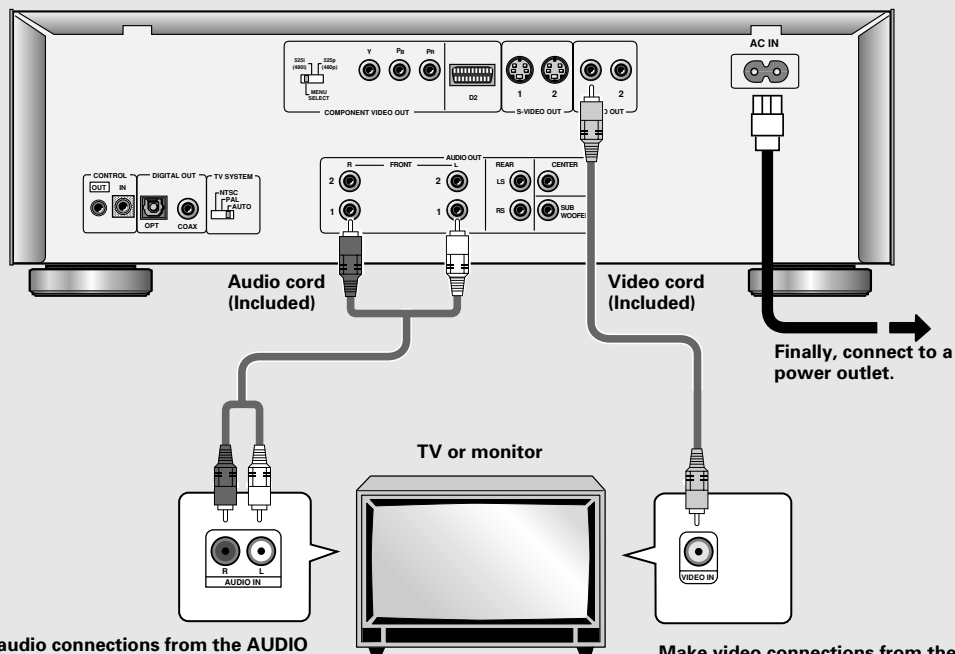

Make audio connections from the **AUDIO OUT** jacks on the player to the **AUDIO IN** jacks on the TV or monitor using the stereo audio cord included with the player. Be sure to match the color of the plugs with the color of the jacks (red and white).

Make video connections from the **VIDEO OUT** jacks on the player to the **VIDEO IN** jack on the TV or monitor using the video cord included with the player.

Home Theater Component Connections

The connections on this page demonstrate the versatility of this player to conform to any number of home entertainment systems.

Please note that the illustration shown on this page is meant as an example. Please refer to the manuals supplied with the components to which you are making connections to determine the best possible setup for your home system.

An explanation of each type of audio and video connection available can be found on **pages 16-18**.

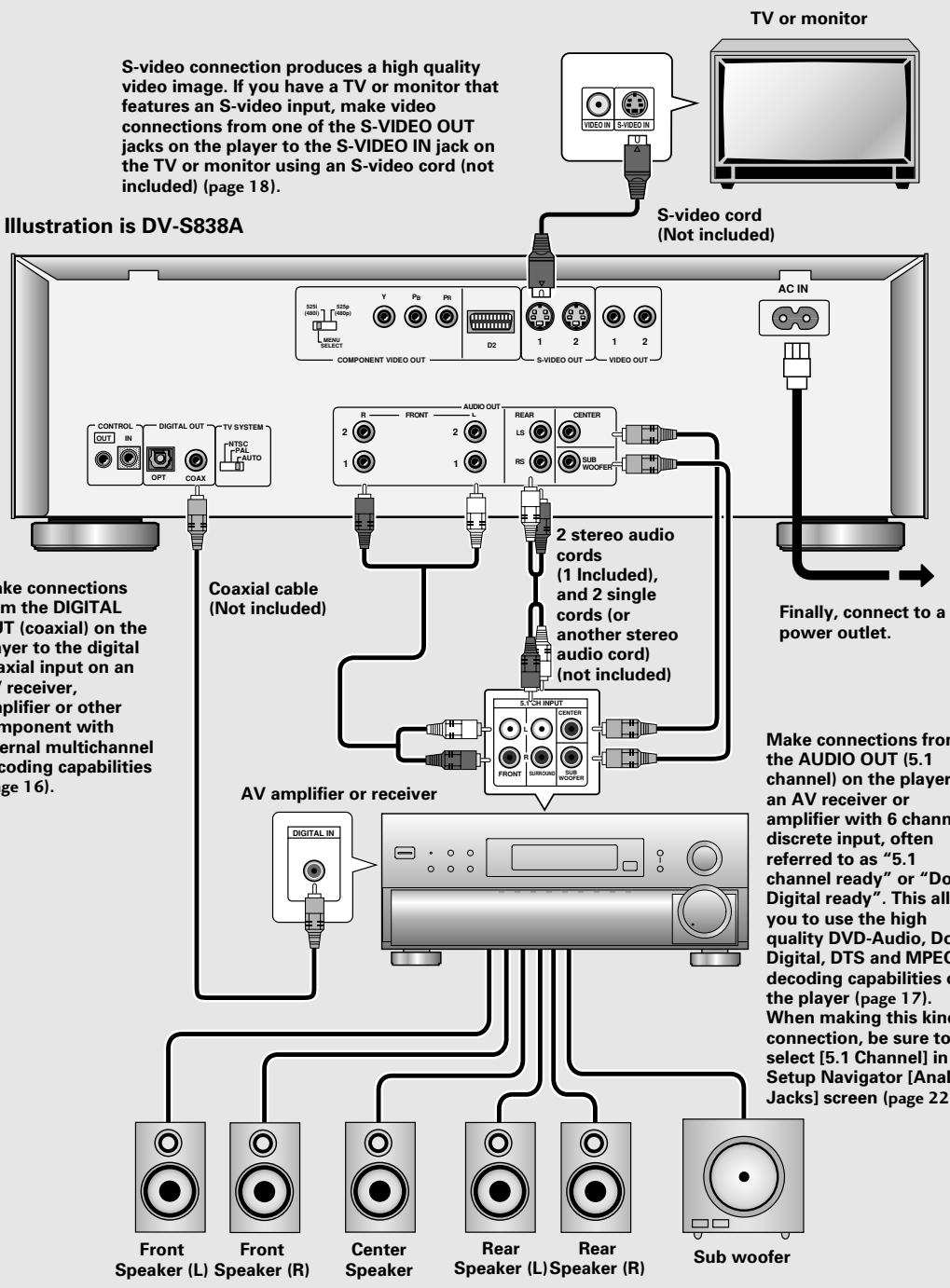

Audio Connections

This player features two digital (optical and coaxial) and also analog audio output formats.

Digital Audio Connections

You can enjoy the digital audio recorded on discs from both optical digital and coaxial digital output jacks.

When making digital audio connections, do not make connections from both the coaxial and optical digital outputs to the same component.

When a DVD recorded in Dolby Digital, DTS, or MPEG is loaded, noise will be output if you have made connections via the digital audio jacks to a receiver or amplifier that cannot decode a Dolby Digital, DTS, or MPEG digital bitstream. In this case, be sure to set up the Setup Navigator audio settings to best reflect the type of system you are using (page 23). Additionally, the digital audio settings can be adjusted manually in the Setup screen **Audio 1** menu (pages 30–31).

DIGITAL OUT (Optical)

The digital signal is transmitted as light pulses through a fiber-optic cable.

- Use to connect to an AV amplifier or receiver with built-in Dolby Digital, DTS, or MPEG decoder.
- Use a fiber-optic cable (not supplied) to connect the **DIGITAL OUT OPT** (digital optical output) on the player to the digital optical input on an AV amplifier or receiver.

Illustration is DV-S838A

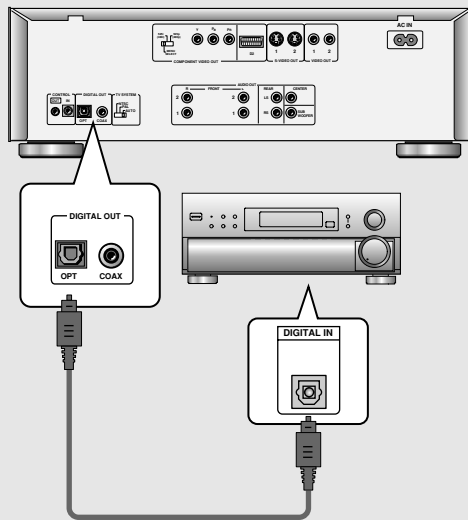

AV amplifier or receiver with built-in Dolby Digital, DTS, or MPEG decoder

DIGITAL OUT (Coaxial)

The digital signal is transmitted electronically through a coaxial cable.

- Use to connect to an AV amplifier or receiver with built-in Dolby Digital, DTS, or MPEG decoder.
- Use a coaxial cable (not supplied) to connect the **DIGITAL OUT COAX** (coaxial digital output) on the player to the coaxial digital input on an AV amplifier or receiver.

Illustration is DV-S838A

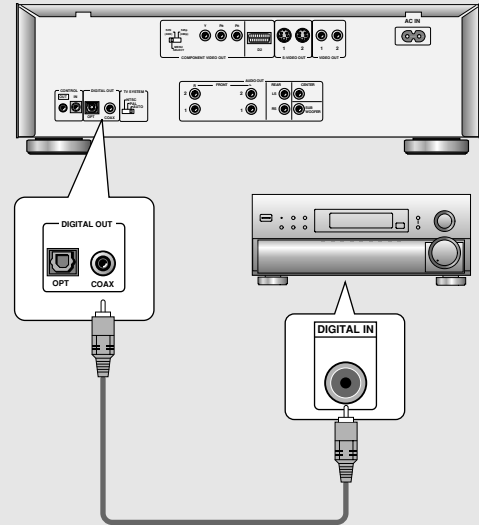

AV amplifier or receiver with built-in Dolby Digital, DTS, or MPEG decoder

Analog Audio Connection

After making physical connections to either the **AUDIO OUT FRONT** or **AUDIO OUT (5.1 channel)** analog jacks, be sure to identify which output you are going to be using in the **[Analog Jacks]** screen of the Setup Navigator (page 22). You can also manually set the output in the **[Audio Out]** setting of the Setup screen **Audio 2** menu (page 32).

Notes

- When **[5.1 Channel]** is selected, the front right (R) and left (L) audio channels are output from the **AUDIO OUT FRONT** jacks.
- The **[Audio Out]** setting creates an audio output default for the player. If connections are made to both **AUDIO OUT FRONT** and **AUDIO OUT (5.1 channel)** analog jacks to make different audio connections for multichannel and stereo audio sources.

2 CHANNEL AUDIO OUT

- Make analog audio connections to a stereo amplifier or receiver.
- Analog audio connections can also be made to a TV or monitor with stereo input jacks.
- Use the supplied audio cable to connect one of the **AUDIO OUT FRONT** jacks on the player to the audio input on the stereo amplifier or receiver.
- When making analog audio connections, be sure to match the color of the plugs with the color of the jacks (red and white).
- When making this kind of connection, be sure to select **[2 Channel]** in the Setup Navigator **[Analog Jacks]** screen (page 22).

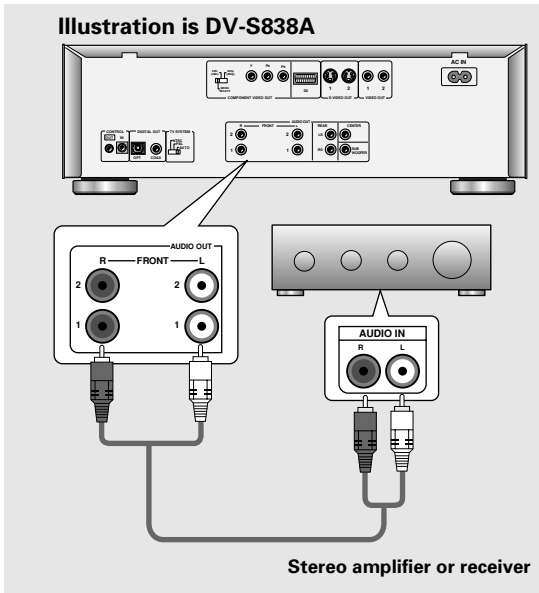

5.1 CHANNEL AUDIO OUT

5.1 channel audio refers to the current industry surround sound standard requiring two front speakers, a center speaker, two surround (rear) speakers and a sub woofer. Although in actuality there are 6 channels, because the sub woofer channel, or LFE channel, makes up a mere fraction of the total audio soundtrack, it has been designated as the 0.1 of the 5.1 system.

By utilizing the player's internal multichannel audio decoder, the audio of DVD-Audio, Dolby Digital, DTS and MPEG DVDs can be output from the 5.1 channel discrete outputs to an AV amplifier or receiver with 5.1 channel input capability.

- Use audio cables to make connections from the player's **AUDIO OUT (5.1 channel)** jacks to the equivalent input jacks on the AV amplifier or receiver.
- When making 5.1 channel analog audio connections, be sure to match the left and right channels on both components, and also make sure that the jacks of all the channels are connected correctly on both components.
- Either 2 single audio cords or a stereo cord may be used to connect the CENTER and SUB WOOFER channels to the AV amplifier or receiver.
- When making this kind of connection, be sure to select **[5.1 Channel]** in the Setup Navigator **[Analog Jacks]** screen (page 22).

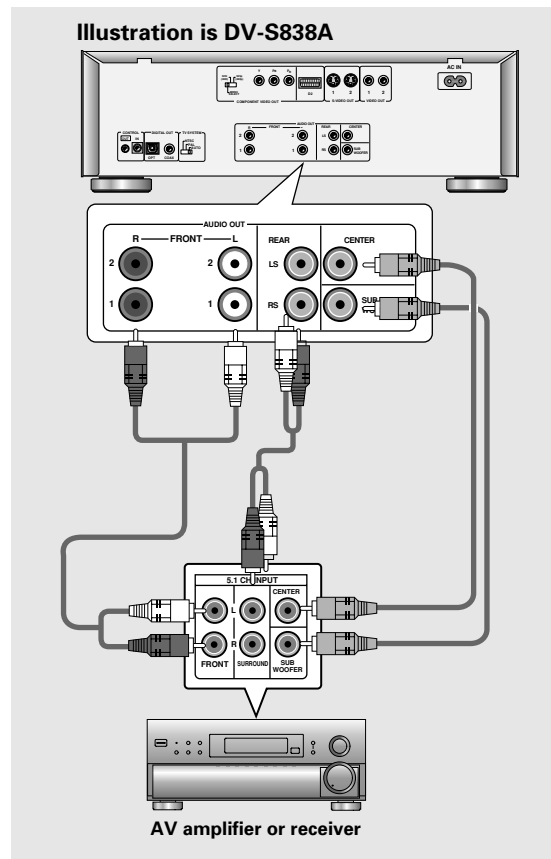

Video Connections

This player features S-video, composite, and component video output possibilities. Check the manual supplied with your TV or monitor to determine the best possible connection for your system.

In addition to making physical connections to your TV or monitor, it is also necessary to assign the TV screen size. You can use the **[Setup Navigator]** in the Setup screen **General** to set whether you are using a wide screen or standard size TV or monitor (page 21). Additionally, you can use the **[TV Screen]** setting in the Setup screen **Video** menu (page 36).

VIDEO OUT

- Make composite video connections to a standard TV or monitor with a video input jack.
- Use the supplied video cable to connect one of the **VIDEO OUT** jacks on the player to the video input on the TV or monitor.
- Be sure to match the color of the plug with the color of the jack (yellow).

Illustration is DV-S838A

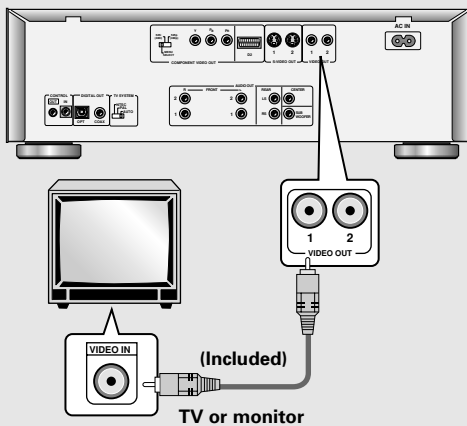

S-VIDEO OUT

- Make S-video connections to a TV or monitor with S-video input to produce a high quality video image.
- Use an S-video cable (not supplied) to connect the **S-VIDEO OUT** jack on the player to S-video input on the TV or monitor.

Illustration is DV-S838A

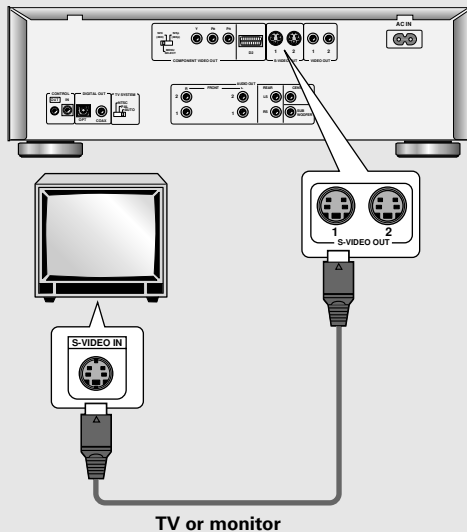

COMPONENT VIDEO OUT

- Make component video connections to a TV or monitor with component inputs to produce a higher quality video image.
- Use a component video cable or 3 video cords (not supplied) to connect the **COMPONENT VIDEO OUT** jacks on the player to the component jacks on the monitor.

Illustration is DV-S838A

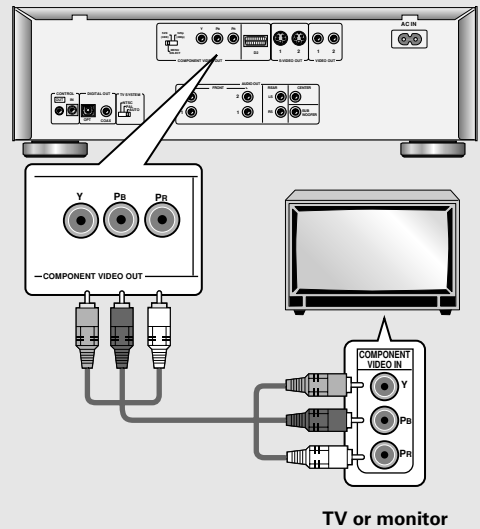

Component Video Out (D2)(NTSC)

If your TV has a **D VIDEO INPUT** jack, you can use a D Video cable (not supplied) to connect it to the D2 output on this unit.

Illustration is DV-S838A

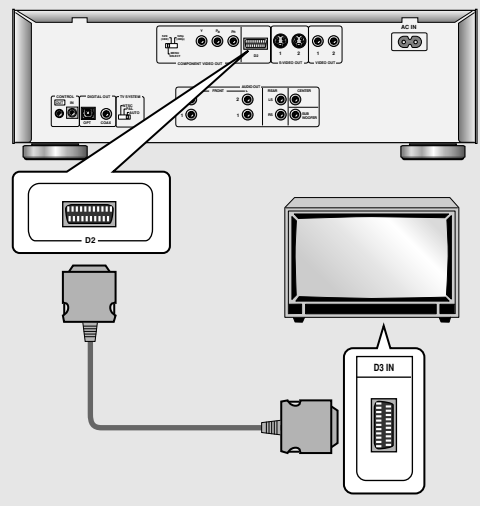

About D Video

The designation of a D Video jack indicates the kinds of signal it is compatible with.

D Video	Compatibility designation
D2	525i(480i), 525p(480p)
D1	525i(480i),

i = interlaced

p = progressive scan (non-interlaced)

System Control Connections

Using a commercially available cord with a mini plug (3.5 mm dia. with no resistance) to connect this player's **CONTROL IN** jack to the **CONTROL OUT** jack of another PIONEER component bearing the **SR** mark, you can control the player as though it were a component in a system (system control).

- If you connect for system control, you cannot operate the player directly. Point the remote control unit at the component (AV amplifier, etc.) connected to the **CONTROL OUT** jack to operate.
- When controlling as a system, be sure to make a connection to the amplifier **using an audio or video cord**, even when using only digital components.
- For details, refer to the operation manuals of the connected components.

Illustration is DV-S838A

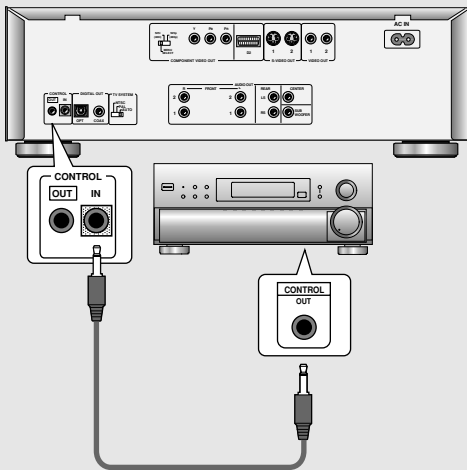

Pioneer component with **SR** mark.

TV SYSTEM switch (except for DV-S88A)

Video output changes as follows according to the playback disc's recorded format.

NTSC → PAL, PAL → NTSC conversion is possible on Video CDs. PAL → NTSC conversion is not possible on DVDs. When the **TV SYSTEM** switch is set to the **AUTO** position, the disc's format will be output as is. When a CD or disc is not loaded, the previous video output format will be selected.

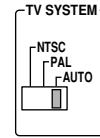

Disc		Output format		
Type	Format	Position of TV SYSTEM switch		
		NTSC	PAL	AUTO
DVD	NTSC	NTSC	MOD. PAL	NTSC
	PAL	—	PAL	PAL
Video CD	NTSC	NTSC	MOD. PAL	NTSC
	PAL	NTSC	PAL	PAL
CD, No disc		NTSC	PAL	NTSC or PAL

About MOD. (Modulation) PAL

- **SHRINK**
Most models of the newly developed countdown PAL TV system detect 50 Hz (PAL)/60 Hz (NTSC) and automatically switch vertical amplitude, resulting in a display without vertical shrinkage.
- If your PAL TV does not have a V-Hold control, you may not be able to view NTSC disc because the picture may roll. If the TV has a V-Hold control, adjust it until the picture stops rolling. On some TVs, the picture may shrink vertically, leaving black bands at the top and bottom of the screen. This is not a malfunction; it is caused by the NTSC → PAL conversion.

Note

When playing Video CDs, the **TV SYSTEM** switch has no effect with playback stops.

Setting Up the Player

Using the Setup Navigator

The Setup Navigator has been designed to simplify the process of getting the DVD player ready to perform. Designed as a series of on-screen multiple-choice questions, the Setup Navigator automatically sets the audio, video, and language settings according to how the questions are answered. Once this procedure is complete, it will be possible to begin using the DVD player to enjoy DVDs.

The procedure on this page describes the operations necessary to function within the Setup Navigator screens. A detailed description of the contents of each question that appears on the screen can be found on the following pages.

When setting up for the first time

Some DVDs start playing automatically when loaded in the player. Because the Setup Navigator cannot be used if a disc is playing, it is recommended to set up the player using the Setup Navigator before loading a DVD for the first time. If a DVD has been loaded, be sure to press **STOP** ■ before proceeding.

Procedures in this section use the DV-S88A.

Differences in procedures of other models are clearly marked by white numbered steps.

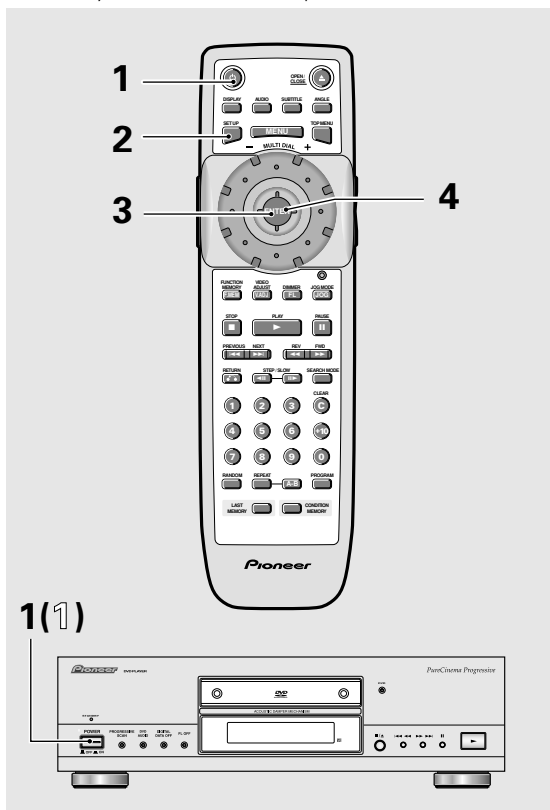

1 Press **STANDBY/ON** on the front panel (**⏻** on the remote control). (DV-S88A)

1 Press **POWER** on the front panel. (DV-S838A)

2 Press **SETUP**.

When **SETUP** is pressed for the first time, the following screen appears. Though the Setup Navigator may be used more than once, this screen only appears the first time **SETUP** is pressed.

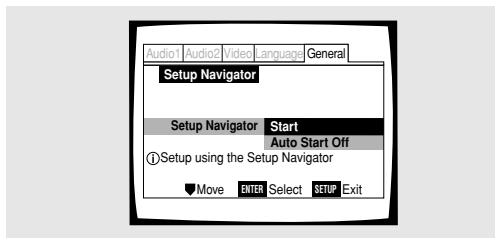

3 Move the cursor control joystick up or down to make a selection.

- If you are going to use the Setup Navigator, it is not necessary to change the setting on the first screen. Please proceed to the next step.
- **If you do not want to set up the player using the Setup Navigator, use the cursor control joystick down to select [Auto Start Off] at this time.**

The Setup Navigator function may still be used at a later time in manual Setup screen menu operation (**page 30**).

4 Press **ENTER**.

The selection is entered and the next Setup Navigator screen appears.

Use steps **3** and **4** as a basis for entering selections on all of the Setup Navigator screens described on the following pages.

To change the answer to a prior question

Move the **cursor control joystick** left to return to previous screens. Please note, however, that you cannot go forward by moving the **cursor control joystick** right, so it will be necessary to answer all the questions that occur after the screen that was returned to.

To exit the Setup Navigator

Press **SETUP** while on any of the screens to exit the Setup Navigator. Please note that if the Setup Navigator is exited before all the questions are answered, no settings are changed.

To return to the Setup screen

Press **RETURN** ⏪. The Setup Navigator is exited and the Setup screen **General** menu screen appears. Please note that no settings are changed if **RETURN** ⏪ is pressed before the Setup Navigator is finished.

Setting the OSD Language (On-Screen Display Language)

The **[OSD Language]** screen establishes the OSD language, or on-screen display language, which refers to the language that is used by the player in menus and on-screen messages. Additionally, the language that is established at this setting will also be used for the default audio and subtitle language.

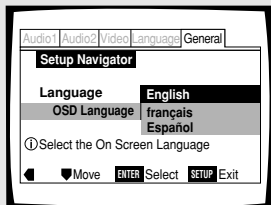

Settings: **English***
français
Español

* Factory setting

Notes

- The languages that can be selected may be different from those shown above.
- In addition to setting the **[OSD Language]**, the audio and subtitle language are also set at this time. If you wish to change the audio or subtitle language to a different language, make changes in the Setup screen **Language** menu **[Audio Language]** and **[Subtitle Language]** as needed (page 40, 42).

Setting the TV screen size

The **[TV Type]** screen establishes the size, or more appropriately the width to height ratio of your television or monitor. The width-to-height ratio of conventional TVs is 4:3, while the width-to-height ratio of wide screen and high-definition TVs is 16:9. This width-to-height ratio is called the aspect ratio.

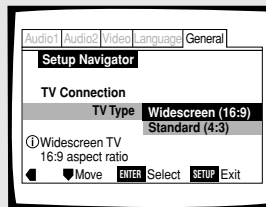

Settings: **Widescreen (16:9)***
Standard (4:3)

* Factory setting

Note

There are two screen formats that can be used to display wide-screen format DVDs: letter box and pan & scan. When **[Standard (4:3)]** is selected in the Setup Navigator, the letter box screen format is automatically selected. To switch the preference to the pan & scan format, make changes in the Setup screen **Video** menu **[TV Screen]** setting (page 36).

Setting analog audio connections to an AV amplifier or receiver

The **[Analog Jacks]** screen establishes whether analog connections have been made to an AV amplifier or receiver, and if connections are made, whether the connections made are for 2 channel stereo or for 5.1 channel surround sound.

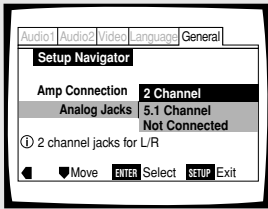

Settings: **2 Channel***

Select if you have made 2 channel connections to an amplifier or receiver.

5.1 Channel

Select if you have made 5.1 channel connections to an AV amplifier or receiver with the appropriate inputs. When this setting is selected, several screens will follow to determine the configuration of your speaker system. These screens are described in the section *'To coordinate your speaker system for 5.1 channel output'* on this page.

Not Connected

Select if you have not made connections to an amplifier or receiver or if you have made stereo connections to a TV or monitor.

* Factory setting

To coordinate your speaker system for 5.1 channel output

When **[5.1 Channel]** is selected in the **[Analog Jacks]** screen, the following screens appear to determine the configuration of your speaker system. In all of the following screens, select **[Present]** if the speaker in question is present in your system, and **[Not Present]** if it is not.

[Center Speaker]

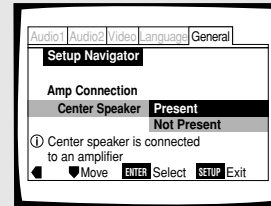

[Surround Speakers]

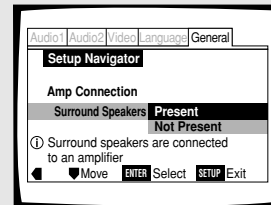

[Sub-woofer]

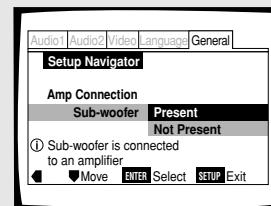

Settings: **Present***

Not Present

* Factory setting

Setting digital audio connections to an AV amplifier or decoder

The **[Digital Jack]** screen establishes whether digital connections have been made to an AV amplifier, receiver, or external decoder. As there are numerous options available, please refer to the instructions supplied with the component the player is connected to determine what digital audio formats can be decoded. If you have made no digital connections, select **[Not Connected]**.

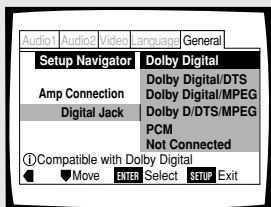

Settings: **Dolby Digital***

Dolby Digital/DTS

Dolby Digital/MPEG

Dolby D/DTS/MPEG

PCM

Not Connected

* Factory setting

Setting compatibility with 96 kHz output

The **[96 kHz PCM Audio]** screen establishes whether or not the AV component the player is connected to is capable of processing an audio signal with a sampling rate of 96 kHz. This screen only appears if connections have been made to an external AV component as determined in previous screens.

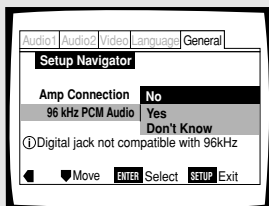

Settings: **No***

Select if the connected AV component cannot process an audio signal with a sampling rate of 96 kHz.

Yes

Select if the connected AV component can process an audio signal with a sampling rate of 96 kHz.

Don't Know

Select if you are uncertain whether the connected AV component can process an audio signal with a sampling rate of 96 kHz.

* Factory setting

Confirming the settings

The **[Exit Setup Navigator]** is the final screen in the Setup Navigator.

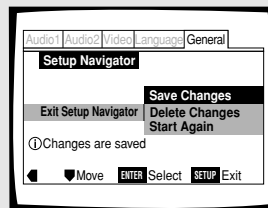

Settings: **Save Changes***

Select to have the player make all of the necessary audio, video and language settings according to your responses in the Setup Navigator.

Delete Changes

Select to exit the Setup Navigator without changing any of the system settings.

Start Again

Select to return to the **[OSD Language]** screen of the Setup Navigator and do the settings again.

* Factory setting

To exit the Setup screen

When you have completed setting up the player using the Setup Navigator or if you exit the Setup Navigator, the Setup screen **General** menu appears. Press **SETUP** to close the Setup screen.

To change other player settings in the Setup screen menus

The procedure for changing the settings in the Setup screen menus is described on **page 28**.

Getting Started Using Your DVD Player

Playing DVDs, Video CDs and CDs – DVD/Video CD/CD

Before you can start to enjoy the digital audio and video on DVDs, be sure that you have either performed the Setup Navigator procedure described in the previous section or made the necessary settings in the Setup screen menus as outlined in the next section to set up the player to correspond to your home system. Having made these settings, you are now ready to start using the player to enjoy DVDs, Video CDs, and CDs.

Procedures in this section use the DV-S88A.

Differences in procedures of other models are clearly marked by white numbered steps.

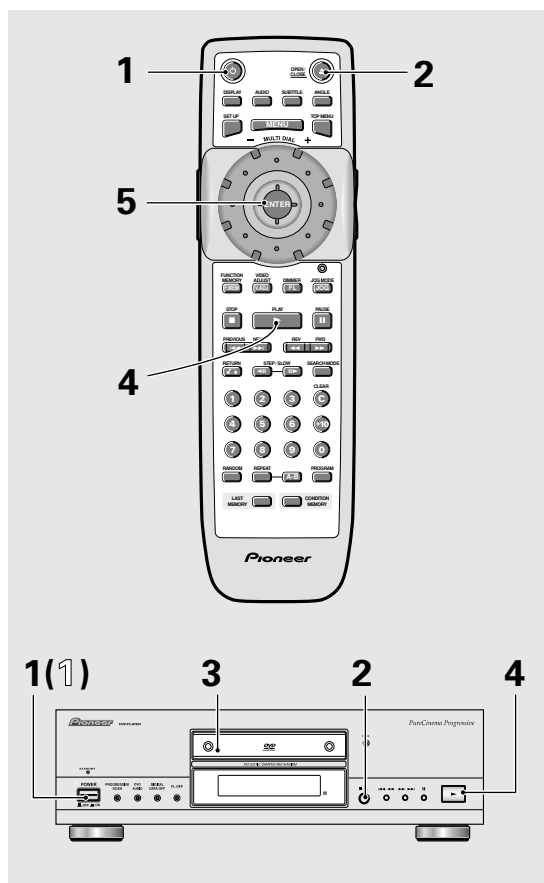

1 Press **⏻ STANDBY/ON** on the front panel (**⏻** on the remote control). (DV-S88A)

1 Press **POWER** on the front panel. (DV-S838A)

2 Press **OPEN/CLOSE** (**⏏/⏏** on the front panel).

The disc tray comes out.

3 Load a disc.

- Load a disc with the label side facing up, using the disc tray guide to align the disc.

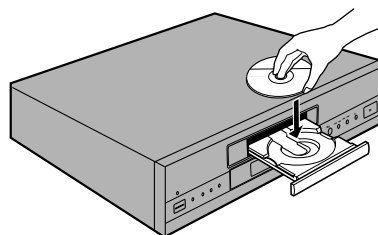

4 Press **PLAY** (**▶** on the front panel).

- The disc tray closes, and playback begins.
- Depending on the disc, a menu may be displayed. If a menu is displayed, proceed to step 5.

5 Select the item you want to view.

- When a DVD is loaded:
Select the item with the **cursor control joystick** or the **number buttons** then press **ENTER**.
- When a Video CD is loaded:
Use the number buttons to select the item.

Notes

- Noise is output if you make digital audio connections to a receiver or amplifier that does not have a built-in decoder. Check that the digital audio output format selected in the **Audio 1** menu corresponds to the audio components you have made connections to (**pages 30-31**).
- The TV screen size is factory set to present the wide screen format (16:9 aspect ratio). If you have a standard TV screen (4:3 aspect ratio), this setting can be changed to match your TV screen size in the **Video** menu (**page 36**).

When an operation is prohibited

There are times when you are using the player and attempt to perform an operation, but for some reason it cannot be performed. When this occurs, one of the two following icons appears on the screen.



The operation is prohibited by the player.



The operation is prohibited by the programming on the disc.

When a menu screen is displayed

Menu screens are displayed for DVDs that have menu screens or Video CDs that include Playback Control (PBC). DVDs often contain extra information that can be accessed in the DVD menu and sometimes makes navigating DVD menu screens as enjoyable as watching the feature presentation.

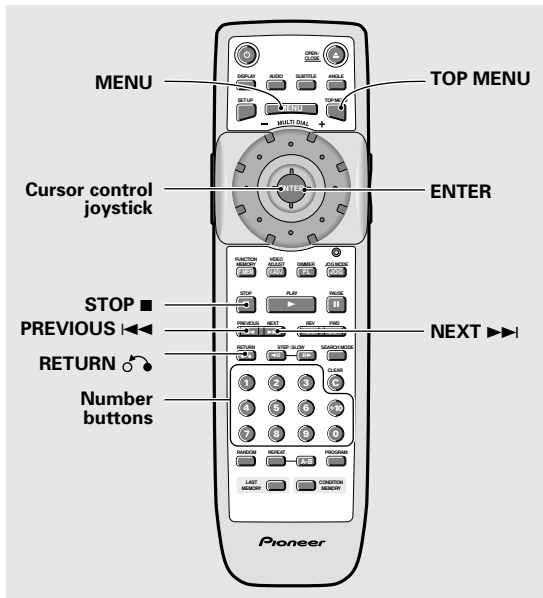

Example: When a DVD that has menu screens is loaded



Example: When a Video CD that has Playback Control is loaded



To open or return to the DVD or Video CD menu screen

Although this differs depending on the disc, pressing **MENU**, **TOP MENU**, or **RETURN** during DVD playback or **RETURN** during Video CD playback displays the menu screen. Refer to the DVD or Video CD disc jacket and accompanying documentation for more information.

- For DVD-Audio discs, use **TOP MENU**.
- Some DVD-Audio disc contain a 'bonus group'. To access this group you'll need to input a 4-digit code, which can be found printed on the disc packaging. See **page 68** for more information on playing discs with bonus groups.

To navigate a menu screen

- Although individual DVD titles may differ, when a menu screen is displayed, use the **cursor control joystick** and **ENTER** on the remote control. The **cursor control joystick** is used to move around the options on the screen and **ENTER** is used for selection.
- Occasionally, the **number buttons** may also be used to make selections. If this is possible, using **number buttons** serves to directly select an option on a menu screen. Only **number buttons** are used to make selections on Video CD menu screens.
- When the Video CD has more than one menu, pages can be returned to or advanced to with **PREVIOUS** **◀◀** or **NEXT** **▶▶**.

To play Video CDs without displaying menu screens

Video CDs with Playback Control (PBC) display a menu screen when play is started. It is possible, however, to play back Video CDs without displaying menu screens.

When a Video CD with PBC is loaded, press **STOP** **■**, and then the **number button** of the track you want to play.

Playing DVD-RWs (DV-S88A only) – DVD-RW

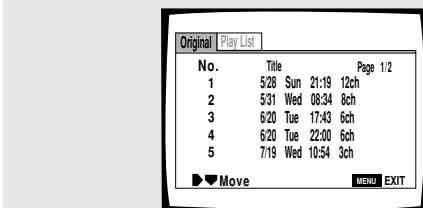

1 Use the cursor control joystick right or left to toggle between Original and Play List.

The **Original** screen shows the contents of the disc as recorded. The **Play List** screen shows the contents in the order programmed by the person who recorded the disc (not all DVD-RW discs contain a Play List).

- You can't switch between Original and Play List while a disc is playing.

2 Use the cursor control joystick up or down to highlight a menu item in the list, then press ENTER to select it.

- Use the **◀◀** **◀** **▶** **▶▶** buttons to see the previous/next page (**◀◀** and **▶▶** on the remote control unit).
- To preview the first frame of the highlighted menu item, use the cursor control joystick right.
- To display this disc menu during playback, press **MENU**.

Chapter (Track) Skip Forward/ Skip Back – DVD/Video CD/CD

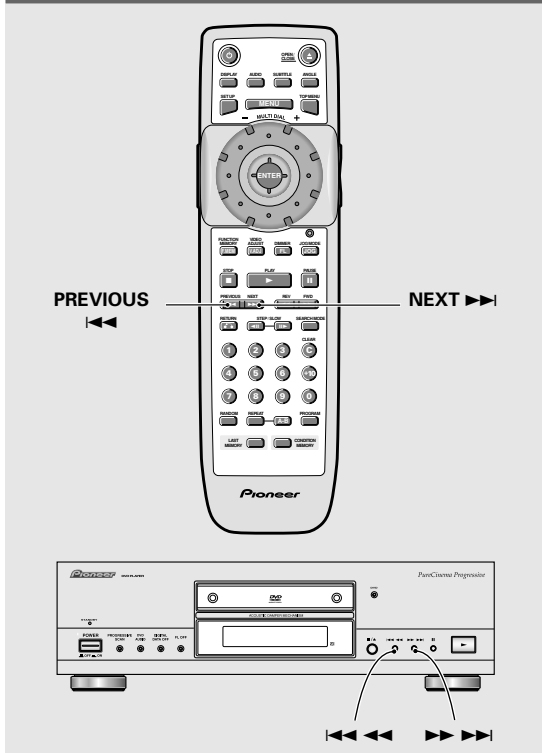

Advancing to the next chapter (track)

Press **NEXT** ►► (►► ►► on the front panel).

- Press to skip forward to the next chapter (track).
- You can advance more than one chapter (track) forward by pressing and holding **NEXT** ►► and releasing when the desired chapter (track) number appears in the display.

Note: Press and hold ►► ►► to start scanning.

Skipping back to the previous chapter (track)

Press **PREVIOUS** ◄◄ (◄◄ ◄◄ on the front panel).

- Press once to skip back to the start of the chapter (track) currently playing.
- Press twice to skip back to the start of the previous chapter (track).
- You can skip back to previous chapters (tracks) by pressing and holding **PREVIOUS** ◄◄ and releasing when the desired chapter (track) number appears in the display.

Note: Press and hold ◄◄ ◄◄ to start scanning.

Forward and Reverse Scanning – DVD/Video CD/CD

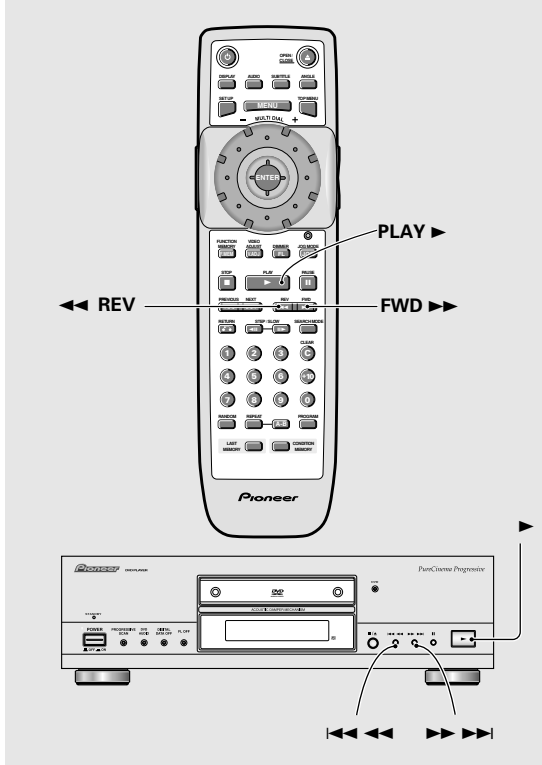

Fast forward scanning

Press and hold **FWD** ►► (►► ►► on the front panel) during playback.

- Release **FWD** ►► when you reach the desired location. Normal playback resumes.
- On DVDs, when the flashing **"SCAN 2"** on the screen changes to a flashing **"SCAN 3"**, fast forward scanning will continue even if the button is released. On Video CDs and CDs, the scanning speeds are **"SCAN 1"** and **"SCAN 2"**. When the desired location has been reached, press **PLAY** ►.
- Variable speed scanning is also possible using the **MULTI DIAL** on the remote control (page 52).

Fast reverse scanning

Press and hold **REV** ◄◄ (◄◄ ◄◄ on the front panel) during playback.

- Release **REV** ◄◄ when you reach the desired location. Normal playback resumes.
- On DVDs, when the flashing **"SCAN 2"** on the screen changes to a flashing **"SCAN 3"**, fast reverse scanning will continue even if the button is released. On Video CDs and CDs, the scanning speeds are **"SCAN 1"** and **"SCAN 2"**. When the desired location has been reached, press **PLAY** ►.
- Variable speed scanning is also possible using the **MULTI DIAL** on the remote control (page 52).

Resuming playback from where you stopped

- DVD-Video/Video CD

Use the resume feature to restart playback from the point that the disc was stopped last time.

Press **STOP** ■ once.

The display shows **"RESUME"** and the stop position is memorized.

- The resume position remains memorized as long as the disc is in the player — even if you switch the power off.
- Pressing **STOP** ■ twice causes the disc to return to the beginning when **PLAY** ► is pressed again. The display shows the disc type (DVDs or Video CDs).

Press **PLAY** ►.

Playback starts from the resume position.

Notes

- The actual restart position may be slightly before or after the resume position.
- If you want to remove the disc, but still want to resume playback from the last stopped position, use the **LAST MEMORY** feature instead (page 59).
- Resume is not possible with DVD-Audio discs.

Stopping Playback and Switching Power Off

- DVD/Video CD/CD

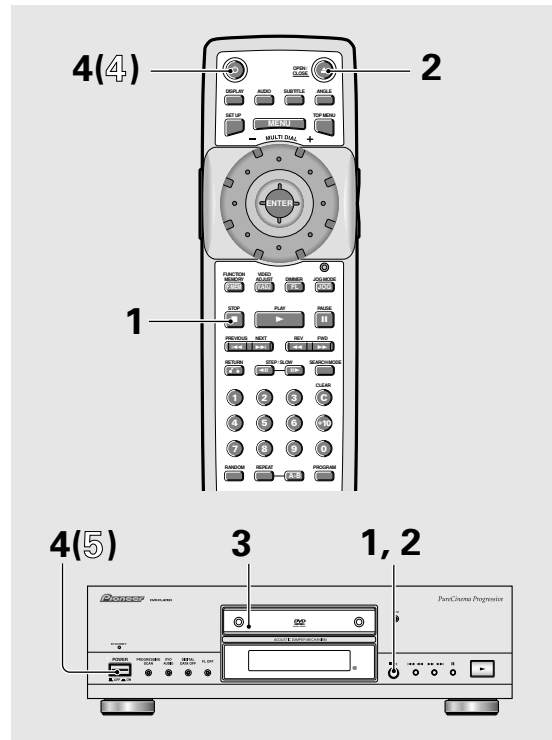

1 Press **STOP** ■ (■/▲ on the front panel).
Playback stops.

2 Press **OPEN/CLOSE** (■/▲ on the front panel).
The disc tray comes out.

3 Remove the disc.

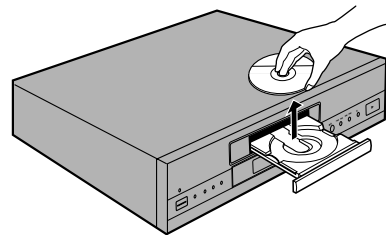

4 Press **STANDBY/ON** on the front panel (⏻ on the remote control). (DV-S88A)
The disc tray goes back in.

4 Press **STANDBY/ON** on the remote control. (DV-S838A)
The disc tray goes back in.

5 Press **POWER** on the front panel to turn the player's power off. (DV-S838A)

Adjusting Audio and Video Settings

Using the Setup Screen Menus

The procedure on this page describes how to operate the menus on the Setup screen. These menus are used to set and adjust a number of system settings. The various functions that can be adjusted are covered throughout this manual. The procedure on this page provides a basic outline for using the Setup screen menus.

When setting up for the first time

It is recommended to set up player using the Setup Navigator (page 20). If you selected **[Auto Start Off]** when the Setup Navigator appeared, you may still set up the player using the Setup Navigator in the **General** menu screen.

If you choose not to use the Setup Navigator, be sure to make the necessary settings in the Setup screen

Audio 1, **Audio 2**, **Video**, and **Language** menus as described on the following pages.

Some DVDs start playing automatically when loaded in the player. If a DVD has been loaded, be sure to press **STOP ■** before proceeding.

Procedures in this section use the DV-S88A.

Differences in procedures of other models are clearly marked by white numbered steps.

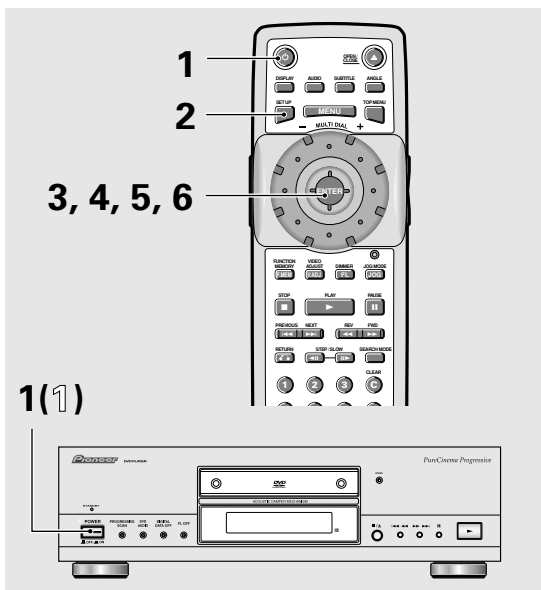

1 Press **⏻ STANDBY/ON** on the front panel (**⏻** on the remote control). (DV-S88A)

1 Press **POWER** on the front panel. (DV-S838A)

2 Press **SETUP**.

The Setup screen appears.

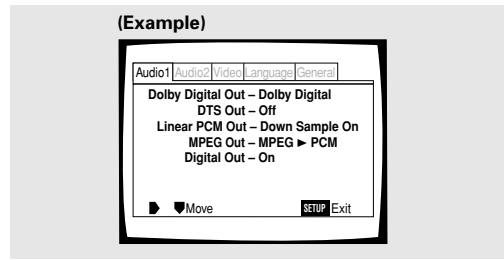

3 Move the cursor control joystick right or left to select the menu you want.

As each menu is selected with the cursor, the settings appear below the menu heading.

4 Move the cursor control joystick down to enter the menu.

The top item within the menu becomes highlighted.

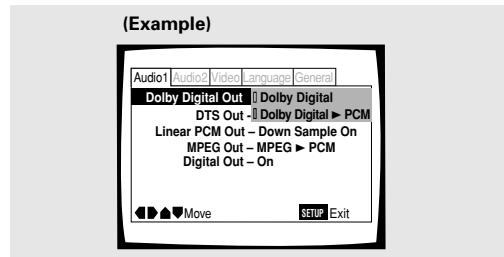

5 Move the cursor control joystick up or down to select the setting you want to change.

The options available for each setting appear to the right when the setting is selected. The current setting appears with the setting indicator lit.

6 Move the cursor control joystick right to enter the setting options.

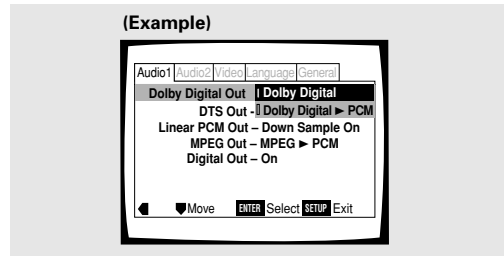

- Not all menu options can be changed while a disc is playing. In these cases, the options appear grayed out on the screen and cannot be adjusted. To change these settings, press **STOP ■** first before pressing **SETUP**.
- Operating the menu after pressing **STOP ■** may cancel the resume function.
- Some menu options are not immediately effective if set while a disc is playing. To make these settings effective, stop playback and then start again, or change the settings while the disc is stopped.

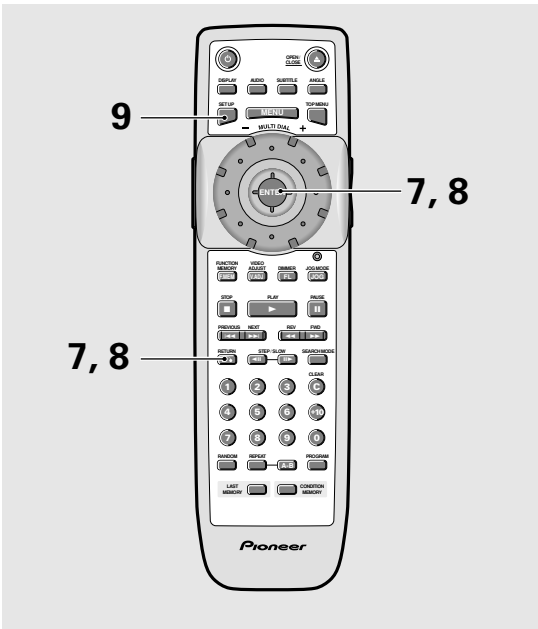

7 Move the cursor control joystick up or down to select a new setting and press ENTER to set the new setting in memory. Press RETURN or move the cursor control joystick left to exit the options without making any changes.

8 Press RETURN or move the cursor control joystick left to go back to the main menu bar to select another menu.

9 Press SETUP to close the Setup screen. The Setup screen closes.

Note
The next time you press **SETUP**, you'll see the menu screen that you exited from last time.

How to interpret the setting indicator colors in the Setup screen menus

When setting up the system, or when making adjustments, it is convenient to know what settings are applicable to the different disc formats. When the settings appear for each menu option, the currently selected setting appears with the setting indicator highlighted in one of two colors: blue, orange or green. These colors correspond to what formats the menu option effects as shown in the table below.

Color of indicator	Disc format(s)
Blue	DVD only
Orange	CD only
Green	All compatible formats

Note
If a setting applicable only to DVDs is changed while a Video CD or CD is loaded, a blue DVD icon appears in the upper right hand corner of the screen to indicate that the setting is not applicable to the currently loaded disc. The setting will be effective the next time a DVD is loaded.

IMPORTANT

Changing to the Setup Menu Mode

The Setup screen menus are divided into two levels, **[Basic]** and **[Expert]**, to make this unit more convenient to operate for different levels of users. The **[Basic]** menu mode contains functions that may be considered necessary for the basic operations of this player and helpful on-screen information identified by the **i** mark. The **[Expert]** menu mode adds to the **[Basic]** menu mode additional functions of the player that can be adjusted to further personalize performance of the player.

In this manual, functions that are contained in the **[Expert]** menu mode are identified by the **[Expert]** icon. Make changes to the **[Setup Menu Mode]** setting in the Setup screen **General** menu.

Settings: **Expert***
Basic

* Factory setting

Note
On-screen information only appears **[Basic]** menu mode.

Setting the Digital Audio Output to be Compatible with your AV Component – DVD

This player is capable of digital audio output for Dolby Digital, DTS, MPEG, and signals with a sampling rate of 96 kHz. Make settings in the Setup screen **Audio 1** menu to reflect the capabilities of the components that you have made digital connections to.

Notes

- If you have already completed the Setup Navigator screen operations, the settings on this page have already been set by the player.
- If you have made only stereo line connections (analog) using the supplied audio cord, it is not necessary to make any changes in this menu.

Dolby Digital Out

This player is capable of outputting the Dolby Digital surround sound audio signal. When the player is connected to an AV component that has a built-in Dolby Digital decoder, select **[Dolby Digital]**. This player can also convert the Dolby Digital signal to a digital Linear PCM signal, the same digital signal output from a CD. Select **[Dolby Digital ▶ PCM]** when you have made connections to an amplifier or receiver with a Dolby Pro Logic decoder or a Digital Analog Converter (DAC).

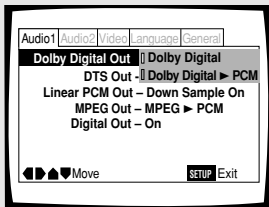

Settings: **Dolby Digital***
Dolby Digital ▶ PCM

* Factory setting

DTS Out

This player is capable of outputting DTS digital audio for DVDs recorded in DTS. When this player is connected to an AV component that has a built-in DTS decoder, select **[DTS]**. If your system is not equipped to decode DTS, select **[Off]**. Refer to the operating instructions supplied with your audio components if you are unsure about compatibility with DTS.

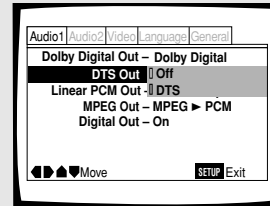

Settings: **Off***
DTS

* Factory setting

Note

If you have made digital audio connections to component(s) not equipped to decode the DTS digital bitstream, be sure to select **[Off]**. If a DTS signal is output without decoding, the output is digital noise that could potentially cause damage to your speakers.

Linear PCM Out

This player is capable of outputting digital signals with a sampling frequency of 96 kHz. If you have made connections to a component capable of processing this signal rate, select **[Down Sample Off]** for the signal to be output as is. As some components are incapable of processing digital signal input with sampling rates of 96 kHz, selecting **[Down Sample On]** compresses the signal to a standard signal with a sampling rate of 48 kHz. If **[Digital Out]** is set to **[On]** and **[Linear PMC Out]** is set to **[Down Sample On]**, you'll see the message **"Digital Out Converted"** appear on-screen when either the **AUDIO** button is pressed or when playing 192 kHz source material.

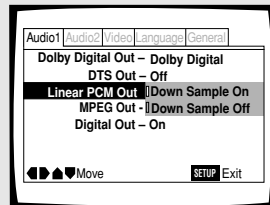

Settings: **Down Sample On***
Down Sample Off

* Factory setting

Notes

- On DVDs that contain copy protection, the 96 kHz signal may only be output from the analog audio jacks. When this type of disc is encountered, even if **[Down Sample Off]** is selected, the player automatically outputs the digital audio signal at a compressed rate of 48 kHz or 44.1 kHz.
- Changes to the **[Linear PCM Out]** setting cannot be made when a disc is playing.

MPEG Out

This player is capable of outputting the MPEG digital bitstream. When the player is connected to an AV component that has a built-in MPEG decoder, select the **[MPEG]** setting. Otherwise, select **[MPEG ▶ PCM]** to convert the digital signal to the PCM signal, the digital signal output from a CD.

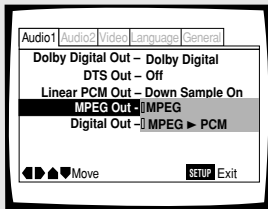

Settings: **MPEG**
MPEG ▶ PCM*

* Factory setting

Digital Out **[Expert]**

Depending on your preferences and the type of connections made, you may opt not to have the digital audio signal output at all. When this setting is set to **[Off]** there is no signal output from the digital audio output jacks.

Make changes to the **[Digital Out]** setting in the Setup screen **Audio 1** menu in the **[Expert]** menu mode (page 29).

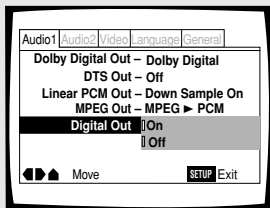

Settings: **On (Digital signal is output)***
Off (Digital signal is not output)

* Factory setting

Adjusting the Dynamic Range of the Audio Soundtrack - DVD

Audio DRC stands for Audio Dynamic Range Compression. When Audio DRC is on, soft sounds such as dialog can be heard more clearly without making loud sounds even louder. Select from three levels of compression depending on how much effect you want. When Audio DRC is set to **[Off]**, there is no effect on the audio source.

Make changes to the **[Audio DRC]** setting in the Setup screen **Audio 2** menu.

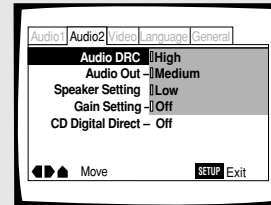

Settings: **High**
(maximum compression of audio source)
Medium
(moderate compression of audio source)
Low
(very little compression of audio source)
Off*

* Factory setting

Note

Audio DRC is only effective with Dolby Digital audio sources.

Setting Analog Audio Connections to an AV Amplifier or Receiver

This player is capable of both 2 channel stereo and 5.1 multichannel surround sound audio output. Use this setting to select which analog outputs are connected to an AV component.

Make adjustments in the **[Audio Out]** setting in the Setup screen **Audio 2** menu.

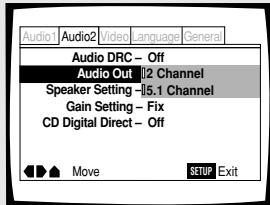

Settings: **2 Channel***
5.1 Channel

*Factory setting

Notes

- When **[5.1 Channel]** is selected, the front right (R) and left (L) audio channels are output from the **AUDIO OUT FRONT** jacks.
- If the center or surround components are not recorded on the disc, there will be no output from the **CENTER** or **SURROUND** output jacks. This is not a malfunction. The audio channels present on the disc can be verified in the program format indicators in the display.

About source audio output

When the source output mode has been switched between the **[5.1 Channel]** and **[2 Channel]** mode settings using the **[Audio Out]** setting in the Setup screen **Audio 2** menu, audio output for each source will be as shown on the following table.

AUDIO CONTENTS	OUTPUT MODE	AUDIO OUT (2 CH)		AUDIO OUT (5.1 CH)			DIGITAL OUTPUT (S/PDIF)	
		L, R (Front L,R)	Center	Surround L,R	Sub Woofer	Dolby Digital or MPEG ► PCM	Dolby Digital or MPEG	
DVD	Dolby Digital	5.1 CH	Front Lch, Rch	Center	Rear LS, RS	LFE	2 ch DOWNMIX Lch, Rch	Dolby Digital
		2 CH	2 ch DOWNMIX Lch, Rch	MUTE				
	Dolby Digital Karaoke	5.1 CH	Lch, Rch	MUTE			Lch, Rch	Dolby Digital
		2 CH		MUTE				
	LPCM	5.1 CH/ 2 CH	Lch, Rch	MUTE			Lch, Rch	
	DTS	5.1 CH	Front Lch, Rch	Center	Rear LS, RS	LFE	DTS [*]	
		2 CH	2 ch DOWNMIX Lch, Rch	MUTE				
	MPEG	5.1 CH	Front Lch, Rch	Center	Rear LS, RS	LFE	Lch, Rch	MPEG
		2 CH	Lch, Rch	MUTE				
	DVD -Audio	5.1 CH	Front Lch, Rch	Center	Rear LS, RS	LFE	2 ch DOWNMIX Lch, Rch ^{**}	
		2 CH	2 ch DOWNMIX Lch, Rch ^{**}	MUTE				
	CD	5.1 CH/ 2 CH	Lch, Rch	MUTE			Lch, Rch	
	VIDEO CD	5.1 CH/ 2 CH	Lch, Rch	MUTE			Lch, Rch	
	DVD-RW (DV-S88A only)	5.1 CH/ 2 CH	Lch, Rch ^{****}	MUTE			Dolby Digital, MPEG or PCM (Lch, Rch)	

*: When the Setup screen **Audio 1** menu **[DTS Out]** setting is set to **[Off]**, DTS digital output is muted.

** : Discs that prohibit downmixing will be output as 5.1 channel even if **[2 Channel]** is selected.

*** : Discs that prohibit downmixing also mute the digital output.

**** : If the sound is mono, Lch and Rch audio will be the same.

Setting Your Speaker System for Multichannel Audio Playback

This player contains a built-in decoder for Dolby Digital, DTS and MPEG audio sources as well as 5.1 channel discrete audio output. Ideally, a 5.1 channel system contains 6 speakers: 2 front speakers, 2 surround speakers, a center speaker, and a sub woofer. However, as this is not always the case, accurately setting the **[Speaker Setting]** setting to reflect your speaker setup allows the player's built-in decoder to reroute signals to compensate for absent speakers. Make adjustments in the **[Speaker Setting]** setting in the Setup screen **Audio 2** menu.

1 Press Enter.

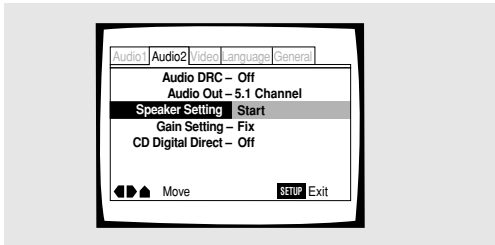

2 Press Enter.

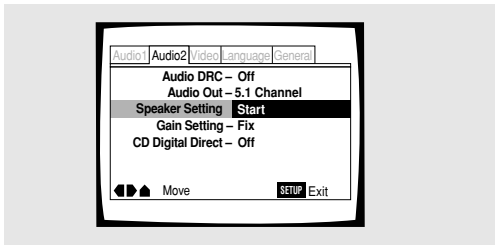

Set to Speaker's size

3 Move the cursor control joystick up or down to select the speaker.

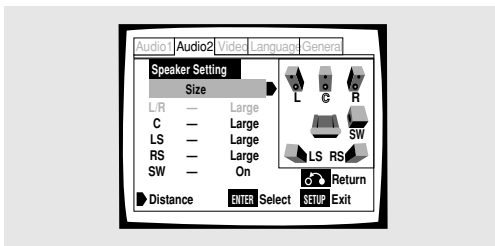

4 Move the cursor control joystick left or right to select Large/Small/Off or On/Off corresponding to whether the selected speaker is present in your system or not, respectively.

Set the size of your speakers in the Size screen. The front left/right **[L/R]** speakers have a fixed setting of Large. The center **[C]**, left surround **[LS]** and right surround **[RS]** speakers can each be set to **[Large]**, **[Small]** or **[Off]**. Set a speaker to **Large** if the main speaker cone is 12cm or more; set to **Small** if the it's less than 12cm. Note that the **[LS]** and **[RS]** speakers cannot be set independently.

The subwoofer (**SW**) can only be set to **On** or **Off**. The graphic on the right of the screen represents your speaker setup, with the currently selected speaker's name highlighted in blue, and the speakers set to On highlighted in yellow.

5 Repeat steps 3 and 4 for each speaker in your system.

Set to distance from listening position

6 Move the cursor control joystick up to select [Size] and press cursor control joystick right.

7 Move the cursor control joystick up or down to select the speaker.

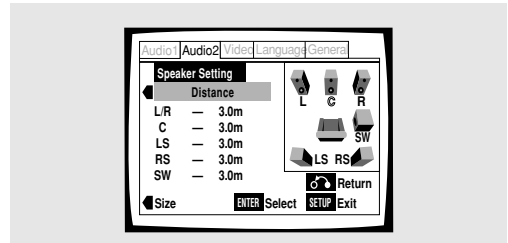

8 Move the cursor control joystick left or right to select distance from speaker.

Set the distance from your main listening position to each speaker in the Distance screen. The distance setting for any speaker that was set to Off in the Size screen will be grayed out. For the other speakers, enter the distance to the nearest 0.1m (10cm). You can set the distance for the **[L/R]** speakers between 0.3m and 9m. Note that you must set the **[C]** and **[SW]** speakers within 2m of the **[L/R]** setting. The **[LS]** and **[RS]** speakers must be set within -6m and +2m of the **[L/R]** setting. The graphic on the right of the screen represents your speaker setup, with the currently selected speaker's name highlighted in blue, and the speakers set to **[On]** highlighted in yellow.

Note: If your subwoofer is placed beyond the adjustment range (**L/R±2**), set to the nearest setting possible. Surround sound cohesion should not be affected very much.

Notes

- If you have already completed the Setup Navigator screen operations, the settings on this page have already been set by the player.
- If you have not made connections to the **AUDIO OUT (5.1channel)** jacks on the rear panel of the player, it is not necessary to make any changes to this setting.
- To help identify the speakers being selected, the initials of the speakers in the speaker system representation on the right side of the screen will appear in blue.

Adjust the output level from the speakers (Gain setting)

This setting should be made when the **AUDIO OUT (5.1 channel)** jacks on the rear panel are connected to an AV amplifier or receiver. The output level of each speaker in your system can be set and confirmed. The factory setting is set to **[Fix]**. However, when you want to adjust the output level, select **[Variable]**.

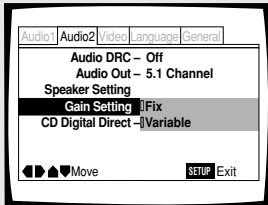

Settings: **Fix***
Variable

* Factory setting

When "Variable" is selected

1 Move the cursor control joystick up or down to select the speaker.

Speakers set to **[Off]** in the **[Speaker Setting]** setting cannot be selected.

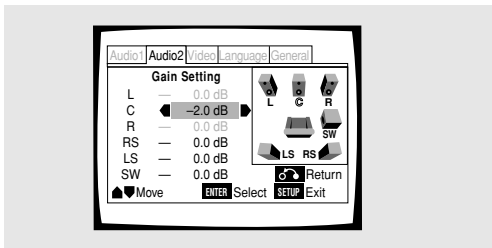

2 Move the cursor control joystick right or left to set the output level.

The value can be adjusted in the range of -6.0 dB to 6.0 dB in 0.5 dB increments. The output level of front L/R speakers are fixed and therefore cannot be adjusted.

3 Repeat steps 1 and 2 for each speaker in your system.

Set to Test tone

You can't use the Test Tone function when the **[Audio Out]** setting is **[2 Channel]** (page 32).

The Test Tone will not work with the disc tray open, or while a disc is playing.

4 Move the cursor control joystick up to select **[Gain Setting]** and press cursor control joystick right.

5 Move the cursor control joystick up or down to select the speaker.

Off: Test tone is not output. (Factory Setting)

On: Test tone output is manually controlled.

Auto: Test tone is automatically output.

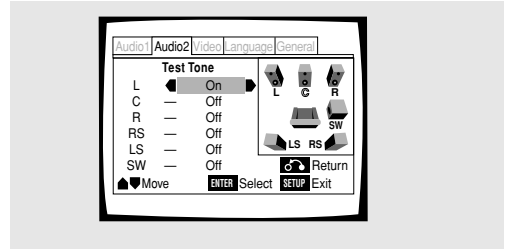

When "On" is selected

Move the cursor control joystick up to the speaker selection line, then Move the cursor control joystick right or left to select the speaker to output the test tone from. The test tone is output from the selected speaker. To output the test tone from another speaker, change the speaker selection.

When "Auto" is selected

Test tone is output in the following order.

Front Left, Center, Front Right, Surround Right, Surround Left, Front Left, ...

6 Move the cursor control joystick up to select **[Test Tone]** and press cursor control joystick left.

This takes you back to the Gain Setting screen.

7 Move the cursor control joystick up or down to select the speaker, then move the cursor control joystick right or left to adjust the output level while listening to the test tone.

To stop the test tone

Move the cursor control joystick down to the "Test Tone" setting, then move the cursor control joystick right or left to select **[Off]** in the **[Test Tone]** setting.

Notes

- When **[Variable]** is selected, the output level of all speakers is uniformly set to -6.0 dB. The output level of each speaker (center, surround, or sub woofer) can then be adjusted in the range of -6.0 dB to 6.0 dB. "6.0 dB" is the maximum level of **[Variable]** and also the level set for **[Fix]**. Therefore, when **[Variable]** is selected, the output level will usually be lower than when the setting is set to **[Fix]**.
- The **[Variable]** setting has no effect on CD and Video CD playback.
- The test tone is not output when the setting is set to **[2 Channel]** in the **[Audio Output]** setting (page 32), while the disc tray opens, or while a disc is playing.

Listening to higher quality CD sound (CD Digital Direct)

By setting the **[CD Digital Direct]** setting to **[On]**, internal circuitry unrelated to CD playback can be bypassed to produce a higher quality CD sound.

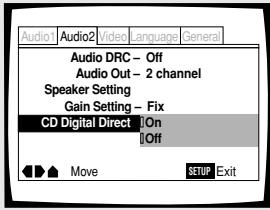

Settings: **On** (Bypass unnecessary circuitry for CD playback.)

Off* (Passes through the necessary circuitry for DTS CD playback.)

* Factory setting

Note

If this setting is set to **[On]** when a DTS CD is played back, noise is produced.

Setting the TV Screen Size

The width-to-height ratio of conventional TVs is 4:3, while the width-to-height ratio of wide screen and high-definition TVs is 16:9. This width-to-height ratio is called the aspect ratio.

When viewing software recorded in different aspect ratios, the image's height to width ratio can be switched to match the TV or monitor being used.

Make changes to the TV screen size in the **[TV Screen]** setting in the Setup screen **Video** menu. Please note that changes to the **[TV Screen]** setting cannot be made when a disc is playing. Stop playback of the disc before attempting to make any changes.

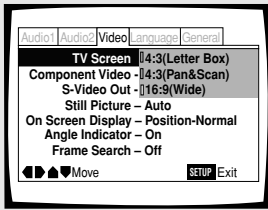

Settings: **4:3 (Letter Box)**

4:3 (Pan & Scan)

16:9 (Wide)*

* Factory setting



Notes





- If **[Standard (4:3)]** is selected in the Setup Navigator screen, **[4:3 (Letter Box)]** is selected on this screen. If you prefer the pan&scan format, change the settings on this screen.
- Whether the aspect can be switched or not depends on the disc. Please refer to the information written on the disc jacket, etc.
- Some discs may not include the screen format selected in the **[TV Screen]** setting. When this occurs, the standard TV screen format available on the disc is automatically selected.
- Some widescreen DVD-RW (DV-S88A only) recordings cannot display the **[4:3 (Pan & Scan)]** setting. In this case, the display will automatically switch to **[4:3 (Letterbox)]**.

Differences in screen sizes and DVD formats

The number of screen size formats currently available can be somewhat confusing. If set incorrectly, the video presentation may not appear as it should. The following diagrams and descriptions are intended to help you set your TV screen size in a way that will allow you to fully enjoy the digital video of DVD.

The settings in the **[TV Screen]** setting are perhaps most applicable when the DVD you are watching is programmed in the wide screen format. If you have a standard TV, select either **[4:3 (Letter Box)]** or **[4:3 (Pan & Scan)]** based on your personal preference. If you have a wide screen TV, select **[16:9 (Wide)]**.

When viewing a wide screen TV or monitor	
DVD screen size format	Setting and Appearance
Wide screen format DVD Please note that there are some wide screen letter box formats that place black bars at the top and bottom of the screen. This is not a malfunction.	 <p>"Wide" setting</p>
Standard screen format DVD When viewing a standard screen format DVD on a wide screen TV, black bars may be automatically placed at the side of the screen to adjust to the DVD format.	 <p>"Wide" setting</p>
Standard screen format DVD (unnatural stretched effect) If you are viewing a standard screen format DVD on a wide screen TV, the picture may appear 'stretched' on the screen. To remedy this condition, change your wide screen TV to display a standard (4:3) screen. Refer to the instructions supplied with your wide screen TV or monitor for more information.	 <p>"Wide" setting</p>

When viewing a standard size TV or monitor	
DVD screen size format	Setting and Appearance
Wide screen format DVD The Letter box presentation places black bars at the top and bottom portions of the screen to provide the full wide screen presentation of a movie on a standard TV (4:3 aspect ratio).	 <p>"Letter Box" setting</p>
Wide screen format DVD The Pan & Scan presentation crops both sides of the wide screen presentation to use the full standard TV screen.	 <p>"Pan & Scan" setting</p>
Standard screen format DVD If you have a standard TV, the standard screen format will be presented regardless of the setting.	 <p>Any setting</p>
Wide screen format DVD (unnatural squeezed effect) If you are viewing a wide screen format DVD on a standard TV and the [TV Screen] setting is set to [16:9 (Wide)] , the picture may appear 'squeezed' on the screen. To remedy this condition, select either [4:3 (Letter Box)] or [4:3 (Pan & Scan)] .	 <p>"Wide" setting</p>

525 line Digital Progressive Scan Compatible Video Output

– DVD

Connecting to a progressive scan-compatible TV

Compared to a standard interlaced TV picture, a progressive scan TV is capable of stable, flicker-free images.

Set only if you connected the **COMPONENT VIDEO OUT** jacks to a progressive scan-compatible TV or monitor. For this setting to be effective, the rear panel **COMPONENT VIDEO OUT** switch set to **525p (480p)** or **MENU SELECT**.

When a progressive-scan video signal is output, the **"PROGRESSIVE SCAN"** indicator lights on the front panel.

When the switch is set to **MENU SELECT**, make changes to the **[Component Video]** setting in the Setup screen **Video** menu.

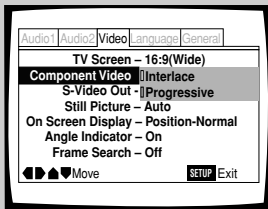

Settings: **Interlace***

Use this setting with regular TVs that are not compatible with progressive scan. Check the TV's instruction manual if you are not sure about this.

Progressive

Use this setting with TVs and monitors that have progressive scan component video inputs. Check the TV's instruction manual if you are not sure about this.

* Factory setting

Tip:

If this player is set to output progressive-scan video, it's possible that the picture will appear stretched when playing discs recorded in 4:3 format. This happens when the TV's aspect ratio is set at 16:9. To see the picture in its correct aspect ratio, change the TV setting to 4:3.

If your TV can not be switched between 4:3 and 16:9, set this player to **[Interlace]**.

Note

If you connect a TV that is not compatible with a progressive scan signal and choose one of the progressive scan settings, you will not be able to see any picture at all.

Set the rear panel **COMPONENT VIDEO OUT** switch to the **525i(480i)** position.

Compatibility of this unit with progressive-scan TVs.

'CONSUMERS SHOULD NOTE THAT NOT ALL HIGH DEFINITION TELEVISION SETS ARE FULLY COMPATIBLE WITH THIS PRODUCT AND MAY CAUSE ARTIFACTS TO BE DISPLAYED IN THE PICTURE. IN CASE OF 525 PROGRESSIVE SCAN PICTURE PROBLEMS, IT IS RECOMMENDED THAT THE USER SWITCH THE CONNECTION TO THE "STANDARD DEFINITION" OUTPUT. IF THERE ARE QUESTIONS REGARDING OUR TV SET COMPATIBILITY WITH THIS MODEL 525p DVD PLAYER, PLEASE CONTACT OUR CUSTOMER SERVICE CENTER.'

Switching the S-Video Output

Expert – DVD

You can Switch the kind of S-Video signal output from the S-Video outputs. If you connected your TV with an S-Video cord, in rare cases the TV picture may appear stretched. In this case switch the output from **[S2]** to **[S1]**.

Make changes in the **[S-Video Out]** in the Setup screen **Video** menu in the **[Expert]** menu mode (page 29).

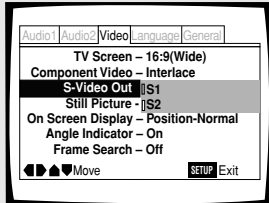

Settings: **S1**
S2*

* Factory Setting

Selecting the type of paused image to display

Expert

This function lets you view a clear still-image when DVD playback is paused.

Make changes in the **[Still Picture]** setting in the Setup screen **Video** menu in the **[Expert]** menu mode (page 29).

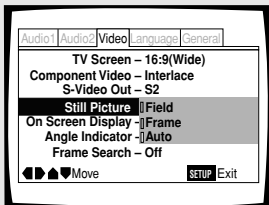

Settings: **Field**
(Picture shake will be eliminated during a paused picture.)

Frame
(Select to obtain higher picture quality.)

Auto*
(Selects **[Field]** or **[Frame]** automatically according to the disc.)

* Factory setting

Setting the position of the on-screen display

Expert

When watching conventional software on a wide screen TV, the operation display is at the very top of the screen, and may be difficult to see. Changing the position of the display lets you see operation indicators clearly even on a wide screen TV.

Alternatively, you can choose to turn them off completely with the **[Off]** setting.

Make changes in the **[On Screen Display]** in the Setup screen **Video** menu in the **[Expert]** menu mode (page 29).

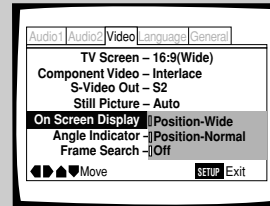

Settings: **Position-Wide**
Position-Normal*
Off

* Factory Setting

Note

This setting is only effective with DVDs that contain a 4:3 aspect ratio video presentation.

Viewing from a Desired Camera Angle (Multi-Angle)

– DVD

You can select a camera angle when viewing DVDs with the multi-angle option.

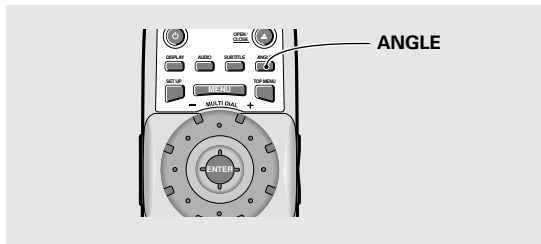

Press ANGLE during playback.

The camera angle changes each time you press the button.

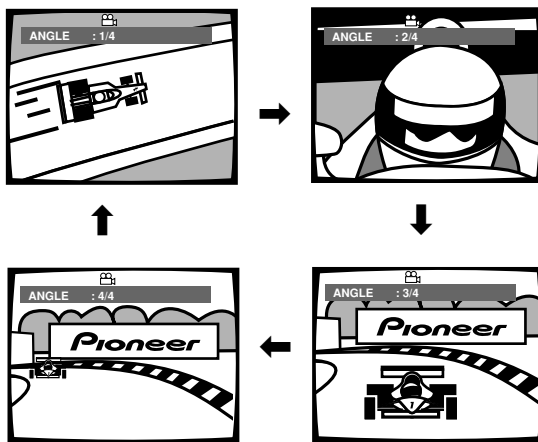

Notes

- You can use the Multi-Angle function only with discs featuring recordings of images shot from different camera angles.
- During Multi-Angle playback, the **ANGLE** indicator in the display lights.
- For some discs, selection can be made using the DVD menu. In this case, press **MENU** to display the DVD menu screen and then make your selection.

To check whether or not a disc is recorded with angles:

The jacket of discs that are recorded with angles will be marked with . When locations on discs that are recorded with angles are played back, the **ANGLE** indicator can be displayed.

To cancel the angle mark, set [**Angle Indicator**] to [**Off**] in the Setup screen **Video** menu described in the section below.

Turning the angle indicator on and off Expert

When a picture recorded in different angles is played back is displayed on the screen. This setting lets you see clearly whether the playback picture is recorded in multiple angles or not.

Turn the angle indicator on or off in the [**Angle Indicator**] setting in the Setup screen **Video** menu in the [**Expert**] menu mode (page 29).

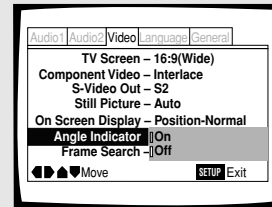

Settings: **On*** (is displayed)

Off (Not Displayed)

* Factory setting

Note

Even when the [**Angle Indicator**] setting is set to [**Off**], the **ANGLE** indicator in the display panel of the player lights during multi-angle playback. Therefore, it is possible to know when the multi-angle function can be used without having to display the icon on the screen.

Selecting the type of search mode Expert – DVD-Video

Set this On if you want to be able to do frame-accurate searching of DVD-Video discs (see page 55 for how to do a time & frame search).

Make changes in the [**Frame Search**] in the Setup screen **Video** menu in the [**Expert**] menu mode (page 29).

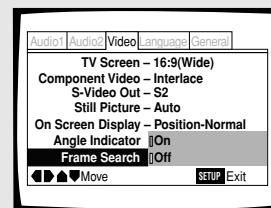

Settings: **On**

Off*

* Factory setting

Note

Time/time & frame search is not possible with DVD-Audio and DVD-RW (DV-S88A only) discs.

Setting the Language Options

DVDs have the capacity to contain a great deal of audio information, which includes the ability to hold up to 8 different language tracks and subtitle information in as many as 32 different languages. This section outlines the variety of audio language and subtitle options available with this player.

Notes

- DVDs differ in content and do not all contain multiple language or subtitle information. Therefore making settings in this section may have no effect on some DVDs.
- If you have already completed the Setup Navigator screen operations, the settings on this page have already been set by the player.

Setting the on-screen display (OSD) language

This setting is used to establish the language that operation indicators and on-screen messages and operations display. Change this setting in the Setup screen **Language** menu **[OSD Language]** setting.

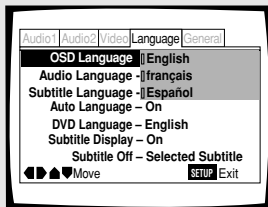

Settings: **English***
français
Español

* Factory setting

Note

The **[OSD Language]** setting is factory set to **[English]**. If you want English to be displayed, it is not necessary to adjust this setting.

Setting Language and Subtitle Preferences in the Setup Screen Menus

The Setup screen **Language** menu contains a number of settings related to the audio and subtitle language preferences.

Selecting an audio language preference

The audio language that you normally listen to can be selected from the various audio languages on a DVD. Even when the audio language is changed during playback by pressing **AUDIO**, the language selected at this setting will be selected as the default when the DVD is changed.

Make changes to the **[Audio Language]** setting in the Setup screen **Language** menu.

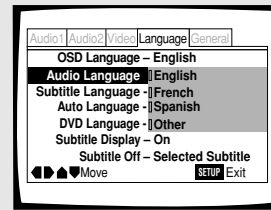

Settings: **English***

French

Spanish

Other

(For details on how to select other languages, see 'When "Other" is selected' on page 43.)

* Factory setting

Changing the Audio Language (Multi-Language Function) – DVD

Dolby Digital, PCM, and other audio data can be recorded on DVDs in a number of languages or audio tracks, letting you choose the desired language or audio.

On DVD-RW (DV-S88A only) discs that have both a MAIN and a SAP audio channel, you can switch between the MAIN, SAP, or MAIN and SAP.

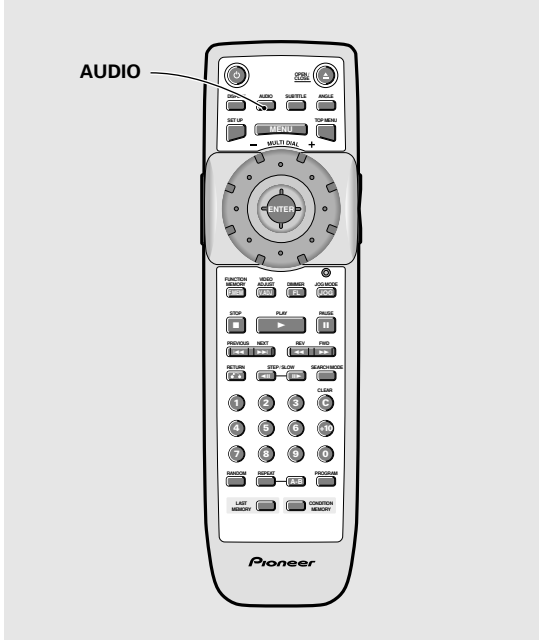

Press **AUDIO** repeatedly to select the desired language.

Pressing **AUDIO** once displays the currently selected language. Subsequent presses rotates through the audio languages available on the DVD.

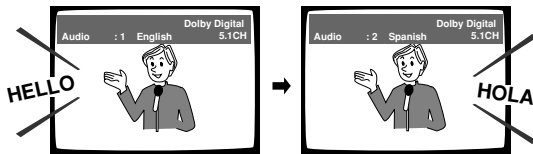

Notes

- You cannot switch languages if there is only one language recorded on the disc.
- Switching the audio language may not be possible with some titles. In this case, the  mark is displayed.
- For some titles, selection can be made using the DVD menu. In these cases, press **MENU** to display the DVD menu screen and then make your selection.
- If **[Digital Out]** is set to **[On]** and **[Linear PMC Out]** is set to **[Down Sample On]**, you'll see the message "Digital Out Converted" appear on-screen when either the **AUDIO** button is pressed or when playing 192 kHz source material.
- When changing the audio language during playback of a DVD Slideshow (page 69), the sound is not output for approximately 30 seconds.

Changing Audio Type – Video CD/CD

For enjoyment of karaoke or similar format Video CDs and CDs, it is possible to select stereo audio, or either right or left channel depending on the requirements of the source.

Press **AUDIO** repeatedly during playback to switch the audio type.

Audio output changes from **[1/L]** (Left channel) to **[2/R]** (Right channel) to **[Stereo]**.

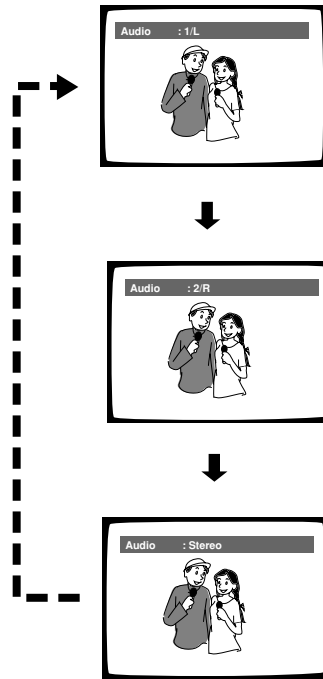

Note

With karaoke and other discs, set the appropriate audio type for singing and accompaniment after referring to information on the disc jacket or accompanying material.

Selecting a Subtitle Language (Multi-Language Subtitles)

– DVD/DVD-RW

You can select a desired subtitle language with DVDs that have subtitle data in multiple languages recorded on them.

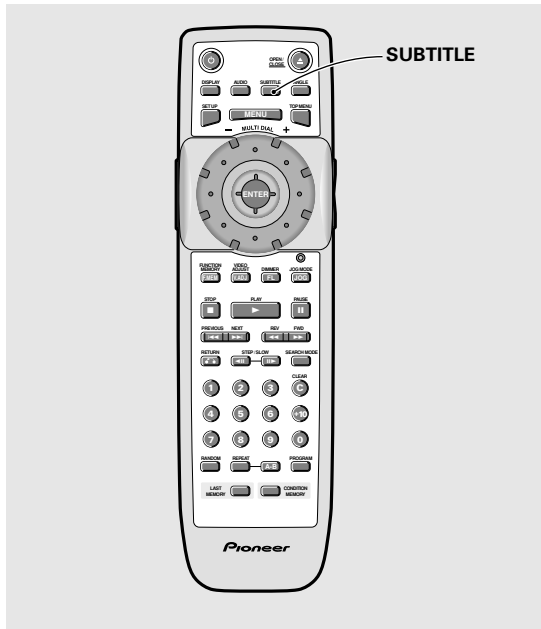

Selecting a subtitle language preference

The subtitle language that you will normally display can be selected from the subtitles programmed on a disc. Even when the subtitle language is changed during playback by pressing **SUBTITLE**, the language selected at this setting will be selected when the disc is changed. Make changes to the **[Subtitle Language]** setting in the Setup screen **Language** menu.

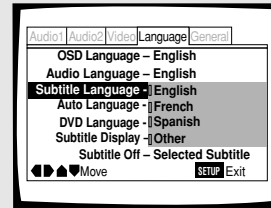

Settings: **English***

French

Spanish

Other

(For details on how to select other languages, see *'When "Other" is selected'* on page 43.)

*Factory setting

Press SUBTITLE repeatedly during playback.

Pressing **SUBTITLE** once displays the currently selected subtitle language. Subsequent presses rotates through the subtitle languages available on the DVD.

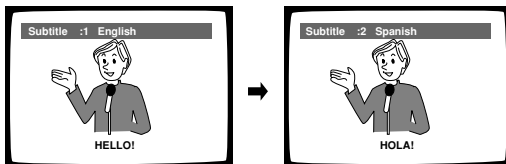

Notes

- The subtitle language cannot be switched if the subtitle language is not recorded, or if only one language is recorded.
- Switching the subtitle language may not be possible with some discs. In this case, the  mark will be displayed.
- To clear subtitles during playback, press **SUBTITLE** and then press **CLEAR**, or press **SUBTITLE** until **[Off]** appears.
- For some discs, subtitle language selection can be made using the menu on the DVD. In this case, press **MENU** to display the DVD menu screen and then make your selection.

When "Other" is selected

When you want to select one of the 136 languages as the main audio language, follow the steps below when the following screen appears.

A language code list can be found on page 64.

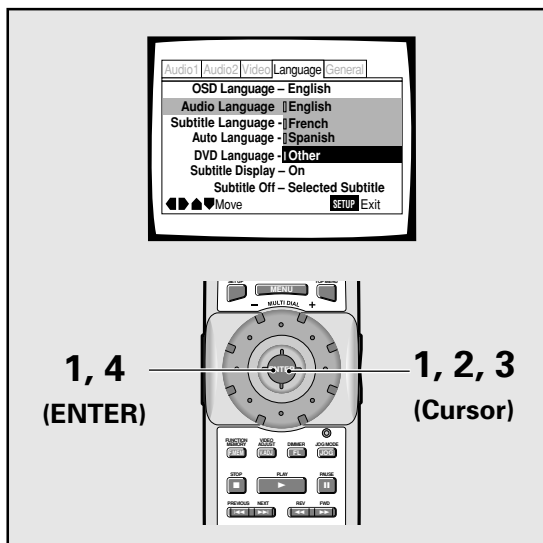

- 1 Move the cursor control joystick to select [Other] and press ENTER.

The language selection screen appears.

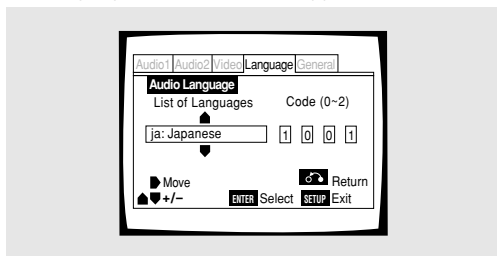

- 2 Move the cursor control joystick to select either [List of Languages] or [Code].
- 3 If you select [List of Languages], move the cursor control joystick up or down to select the language.

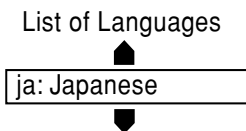

If you select [Code], move the cursor control joystick up or down to input the numbers of the input code.

Move the cursor control joystick right or left to change the position of the cursor. You can also use the number buttons to enter the code.

Code (0~2)

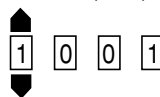

- 4 Press ENTER to set the new language.

To exit the screen without making any changes, press RETURN.

Setting Auto Language to control subtitle and audio language based on program content

When the Auto Language function is used, foreign movies are shown with the original audio soundtrack and subtitles in the language selected in the [Subtitle Language] menu option. Domestic films are shown with the original audio soundtrack and no subtitles. (This setting may not be effective with all DVD discs.) Make changes to the [Auto Language] setting in the Setup screen Language menu.

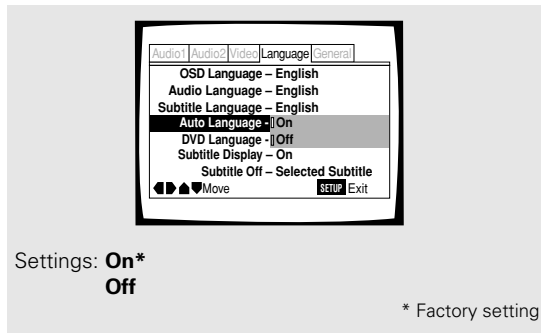

Note

The Auto Language function operates only when this function is set to [On], and the language set for the [Audio Language] and [Subtitle Language] settings is the same.

Selecting a DVD menu language preference Expert

In addition to containing different audio languages, DVD may also contain menu screens in different languages as well. Setting a DVD language preference, sets the selected language as a default when DVDs with menu information in that language are encountered.

Selecting **[w/ Subtitle Language]** automatically assigns the language selected in the **[Subtitle Language]** setting.

Make changes to the **[DVD Language]** setting in the Setup screen **Language** menu in the **[Expert]** menu mode (**page 29**).



Settings: **w/ Subtitle Language***

English
French
Spanish
Other

(For details on how to select other languages, see *'When "Other" is selected'* on **page 43**.)

* Factory setting

Notes

- The menu settings may look different from the one shown above.
- If this function is not effective, the languages that can be selected may also be selected in the DVD menu. Press **MENU** to open the DVD menu and make your selection accordingly.

Selecting subtitles, assist subtitles or no subtitles Expert

Use this function to turn the subtitles on or off.

Additionally, some DVDs provide assist subtitles that provide additional explanations of scenes in addition to the standard subtitles for viewers who are hard of hearing. Select **[Assist Subtitle]** to display these subtitles on DVDs where this function is offered.

Make changes to the **[Subtitle Display]** setting in the Setup screen **Language** menu in the **[Expert]** menu mode (**page 29**).

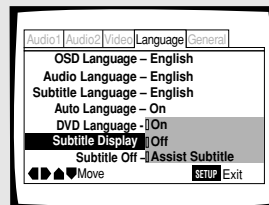

Settings: **On***

Off

Assist Subtitle

* Factory setting

Notes

- If there is no subtitle information recorded on the DVD, no subtitles are displayed even if this function is set to **[On]**.
- This setting serves as a default as to whether or not to display subtitles. Even if this option is set to **[Off]**, subtitles can be displayed by pressing **SUBTITLE**. Similarly, if this option is set to **[On]**, the subtitles can be turned off by pressing **SUBTITLE** and then **CLEAR**.

Forcing subtitles to be displayed Expert

Even when the subtitles are turned off, some DVDs will nevertheless display them on the screen. This setting allows you to select the language of the subtitles to be displayed with this type of DVD.

Select **[With Audio]** to display the subtitles in the same language as the currently selected audio language. Select **[Selected Subtitle]** to display the subtitles in the language set in the **[Subtitle Language]** setting.

Make changes to the **[Subtitle Off]** setting in the Setup screen **Language** menu in the **[Expert]** menu mode (**page 29**).

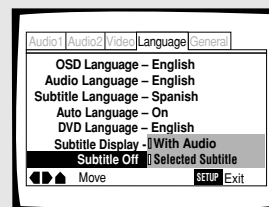

Settings: **With Audio**

Selected Subtitle*

* Factory setting

Advanced Functions

This player is compatible with DVD, Video CD, and CD disc formats. Users already familiar with Video CD or CD will already be familiar with some of the functions the player is capable of performing. With DVD, an even greater number of possibilities and functions are available.

Note

DVDs differ in content and do not all contain the same information. Therefore some functions in this section may not work or have no effect on some DVDs.

Setting the Parental Lock Level – DVD

This player lets you set the Parental Lock if the DVD has a parental lock level recorded on it. With Parental Lock capable discs, you can block access to material you feel is inappropriate for your children. Refer to the DVD disc jacket and the accompanying documentation to see if a particular disc contains a parental lock level.

Make changes to the **[Parental Lock]** setting in the Setup screen **General** menu. Please note that changes to the Parental Lock level can only be made when the player is stopped.

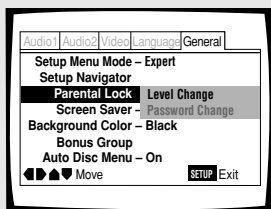

Settings: **Level Change**

(For information, refer to *'Setting the Parental Lock level'* on the following page.)

Password Change

(For information, refer to *'Changing the password'* on the following page.)

When a DVD with a set Parental Lock level is loaded

Playback cannot be started until the code number has been correctly input by using the **cursor control joystick** or the **number buttons**, and **ENTER** has been pressed.

Entering the password

When you select either **[Level Change]** or **[Password Change]**, it is necessary to enter the password (4-digit code number). Use the following steps at any time you are asked to enter or confirm your password.

- 1 Move the cursor control joystick up or down or the number buttons to select a number between 0 and 9.**

You can also use the **number buttons** to enter the numbers directly. When entering your password for the first time, or changing it, you will be asked to reenter your password. When using the **number buttons** to confirm the password, the numbers appear as asterisks, and the cursor advances automatically to the next position.

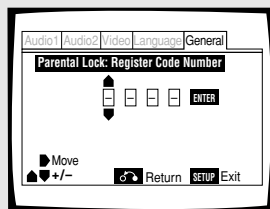

- 2 Move the cursor control joystick right or left to move the cursor to a different position in the password.**

When all four numbers of the password have been entered, **ENTER** appears on the screen.

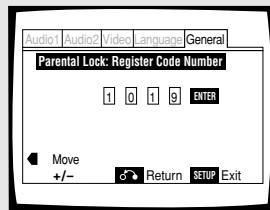

- 3 Press ENTER to set the new password.**

The password is entered.

Note

Be sure not to forget your password. If you should forget it, reset the system, and enter a new password. To reset the system, see *'Resetting the Player to System Settings'* (page 63). Please note that this procedure resets the system, and clears all saved settings, not just the password.

Setting the Parental Lock level

Change the Parental Lock level to a higher or lower level according to the settings printed on the DVD disc jacket or accompanying documentation. If you use the Condition Memory function to save the settings for a particular disc, the Parental Lock level is saved as well. Because it is saved in memory, Parental Lock levels can be set for individual discs according to their content rather than a set level for all DVDs.

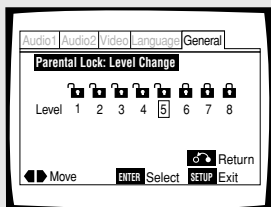

1 Select [Level Change] in the [Parental Lock] setting.

The screen changes to the password input screen. If you have not yet set a password, you will be asked to do so at this time. To enter the password, refer to *'Entering the password'* on the previous page.

2 Move the cursor control joystick right or left to adjust the Parental Lock level.

The lock icons appear **"unlocked"** up to the selected level to indicate that access is available.

3 Press ENTER to set the new level.

The new Parental Lock level is set and the screen returns to the **General** menu screen. To go back to the **General** menu screen without making any changes, press **RETURN** ↵.

Changing the password

Change your password whenever you feel it is necessary. However, if you forget your existing password, you cannot enter this screen to change it.

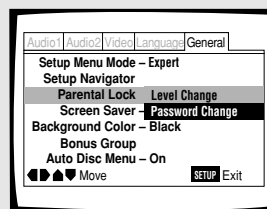

1 Select [Password Change] in the [Parental Lock] setting.

The screen changes to the password input screen. To enter the password, refer to *'Entering the password'* on the previous page.

If you have not yet set a password, you cannot select this setting. Establish a password by selecting **[Level Change]** first.

2 Move the cursor control joystick right or left to or the number buttons to enter the new password.

3 When the new password has been entered, press ENTER.

The new password is set and the screen returns to the **General** menu screen. To go back to the **General** menu screen without making any changes, press **RETURN** ↵.

Turning the Screen Saver On and Off Expert

As a protective function against residual images on the TV screen or monitor, a phenomenon referred to as "screen burn", the screen saver appears when the same screen has been displayed for a length of time. By default, the screen saver is turned off. However, the screen saver function can be turned on and off at your discretion.

Make changes to the **[Screen Saver]** setting in the Setup screen **General** menu in the **[Expert]** menu mode (page 29).

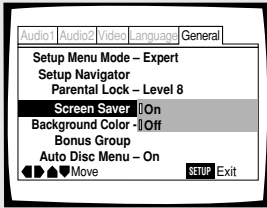

Settings: **On**
Off*

*Factory setting

Changing the Background Color of the Screen Expert

You can select a blue or black background to appear when the player is in the stop mode.

Make changes to the **[Background Color]** setting in the Setup screen **General** menu in the **[Expert]** menu mode (page 29).

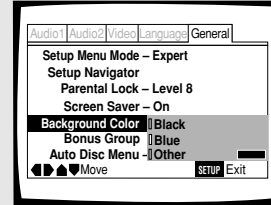

Settings: **Black***
Blue
Other

*Factory setting

When "Other" is selected

This player gives you the option of creating your own background color by adjusting the red, green and blue levels.

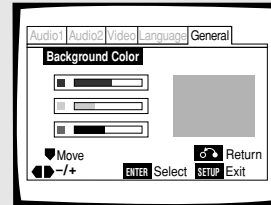

1 Move the cursor control joystick up or down to select a color bar.

The selected color bar becomes highlighted.

2 Move the cursor control joystick right or left to adjust the level of the color.

As the color bar is adjusted, the square on the right side of the screen indicates how the current mix of the three colors appears.

3 Repeat steps 1 and 2 until you have achieved a color that you like.

4 Press ENTER to set the color as the background color.

Bonus Group Expert

Some DVD-Audio discs have an extra ‘bonus’ group that requires a 4-digit key number to access. See the disc packaging for details and the key number. When you try and play the bonus group, the key number input screen will automatically appear, although it is also available from the **General** menu. Input the number and press **ENTER**.

Make changes to the **[Bonus Group]** setting in the Setup screen **General** menu in the **[Expert]** menu mode (page 29).

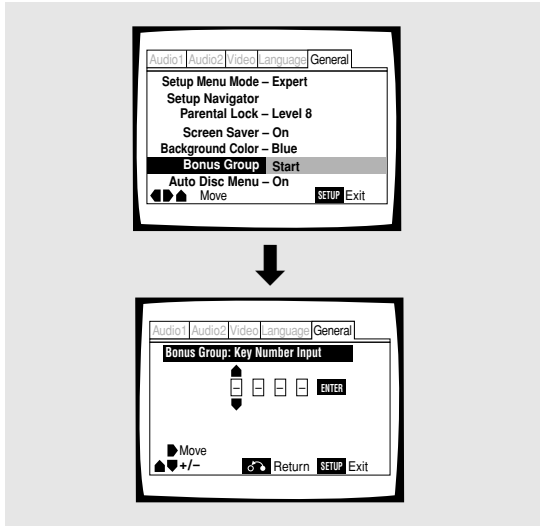

Auto Disc Menu Expert

This specifies whether the menu (Top menu) is automatically displayed after loading a disc. Set to **[On]** if you want the menu displayed automatically, or **[Off]** if you don't want it displayed.

Make changes to the **[Auto Disc Menu]** setting in the Setup screen **General** menu in the **[Expert]** menu mode (page 29).

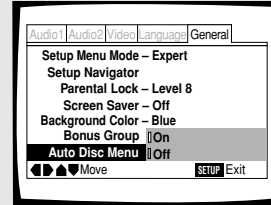

Settings: **On***
Off

*Factory setting

Note:

Some DVD discs display a menu automatically regardless of this setting. If you press **PLAY** ► while a disc is loading, this setting is ignored.

Adjusting the Video Quality (Digital Noise Reduction)

– DVD/Video CD

You can either select a preprogrammed setting designed to match certain program types or make adjustments to match your own preferences and save them in the player's memory.

Selecting a preprogrammed setting

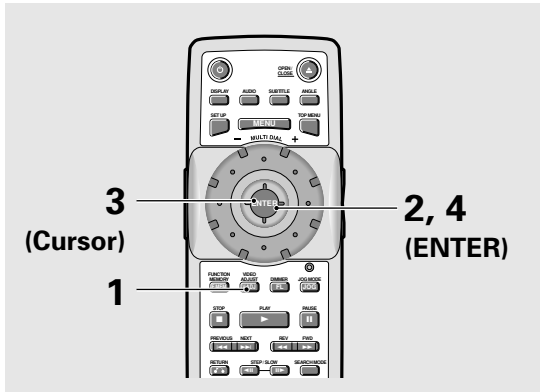

1 Press VIDEO ADJUST (V.ADJ.).

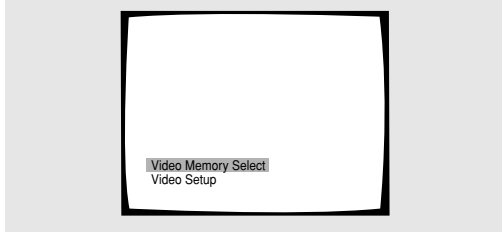

2 Press ENTER.

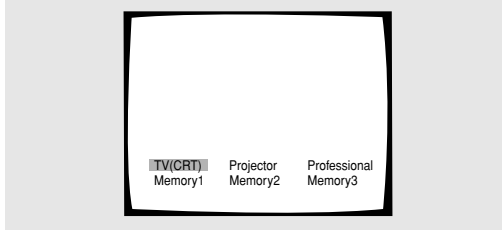

3 Move the cursor control joystick to select one of the preprogrammed picture quality settings.

TV(CRT)* – (default setting) optimized settings for a standard television set.

Projector – optimized for a projector or projection TV.

Professional – optimized for a professional monitor.

Memory1–3 – user setups (see page 50 for more on these).

*Factory setting

4 Press ENTER.

The new selection is set.

Adjusting the picture quality settings

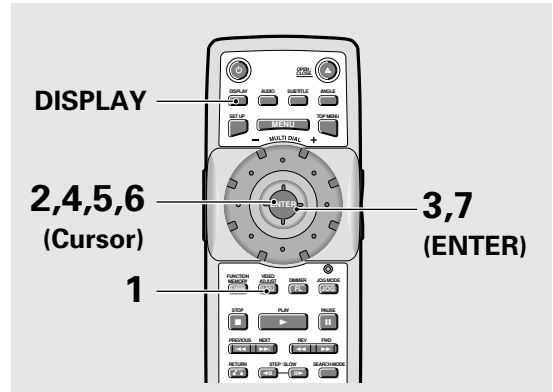

1 Press VIDEO ADJUST (V.ADJ.).

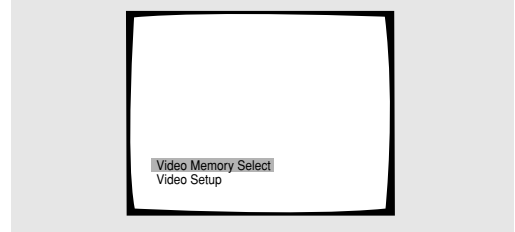

2 Move the cursor control joystick down to select "Video Setup".

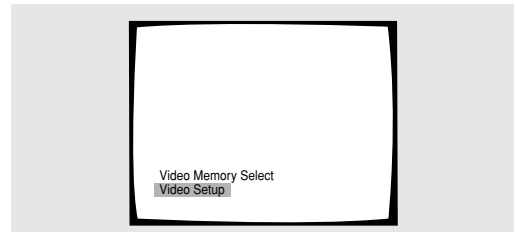

3 Press ENTER.

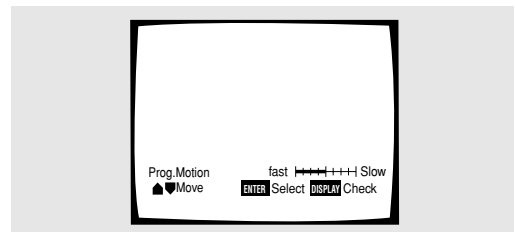

4 Move the cursor control joystick up or down to select the setting to adjust.

To create your own setting (1):

You can adjust any or all of the following picture quality factors:

Prog. Motion – When using progressive scan, this adjusts the motion and still picture quality.

PureCinema – When watching DVD movies, PureCinema optimizes the picture quality. The default setting is Auto, but if the picture appears unnatural, then set to On or Off as desired and adjust the Prog. Motion setting (see above). See PureCinema in the glossary starting on **page 69**.

YNR – Adjusts the amount of noise reduction (NR) applied to the Y (brightness) component.

CNR – Adjusts the amount of noise reduction (NR) applied to the C (colour) component.

MNR (Mosquito Noise Reduction) – Adjusts the amount of noise reduction applied to the mosquito noise (video artifacts on the edge of the image resulting from MPEG compression).

BNR (Block Noise Reduction) – Adjusts the amount of noise reduction applied to the block noise.

Sharpness High – Adjusts the sharpness of the high-frequency (finely detailed) elements in the picture.

Sharpness Mid – Adjusts the sharpness of the mid-frequency (less detailed) elements in the picture.

Detail – Adjusts how sharp edges appear in the picture.

White Level – Adjusts the intensity of white in the picture.

Black Level – Adjusts the intensity of black in the picture.

Black Setup – For correction of floating black colour.

Hue – Adjusts the overall colour balance between red and green.

(This is only effective with NTSC video when the player is connected using the **VIDEO OUT** or **S-VIDEO OUT** signals.)

Chroma Level – Adjusts how saturated colours appear.

Chroma Delay – Compensates for misalignment of the Y (brightness) and the C (colour) components.

5 Move the cursor control joystick right or left to adjust the settings.

If a DVD or Video CD is playing, the changes will be visible on the screen as they are adjusted.

6 Repeat steps 4 and 5 to make adjustments to other settings.

If you would like to save the settings in the player's memory, be sure to select either "1", "2", or "3" in the **[Memory]** setting to establish which memory location to save the new settings in. Please note that if you select a location where settings have already been saved, the old settings will be replaced by the new ones.

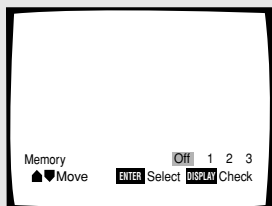

7 When you are finished making adjustments, press ENTER to establish the new settings.

To create your own setting (2):

1 Press VIDEO ADJUST (V.ADJ).

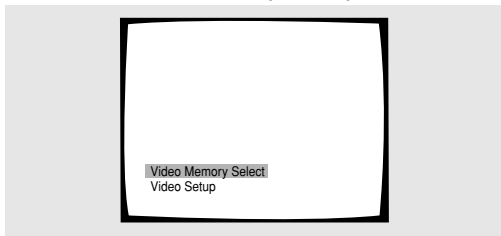

2 Select Video Setup, then press ENTER.

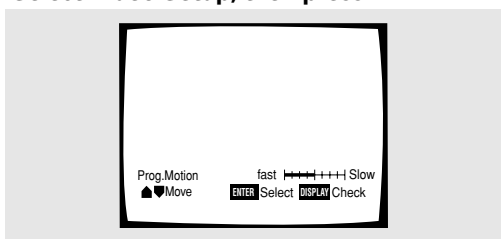

3 Press DISPLAY.

4 Move the cursor control joystick up or down to select a setting; move it left or right to adjust that setting.

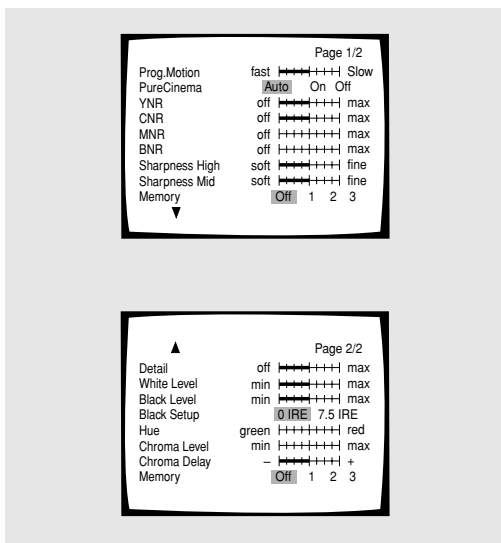

Adjust these while a disc is playing to see the effect of changes immediately.

5 To memorize the setting, select memory 1, 2 or 3, then press ENTER.

The previous setting will be erased.

Still Frame/Slow Play/Frame Advance Playback

– DVD/Video CD

The video images on DVD and Video CD can be viewed as a still frame, played back at slow speeds and even advanced frame by frame.

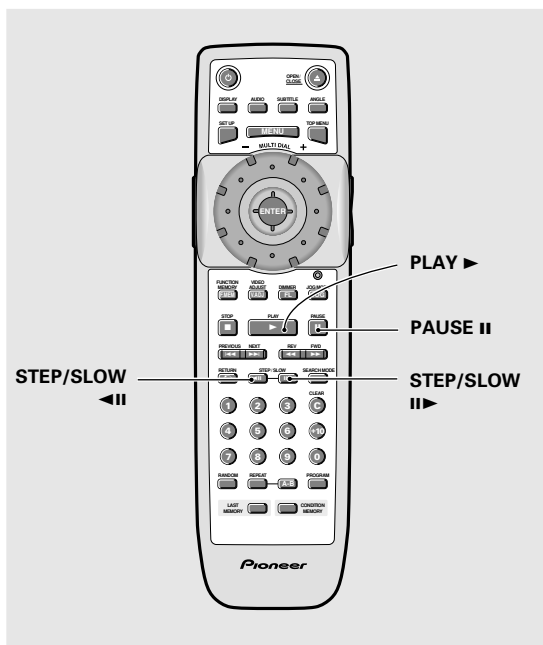

Viewing a still frame

Press PAUSE II.

When viewing a DVD, if the paused picture shakes, select the **[Field]** setting in the Setup screen **Video** menu **[Still Picture]** setting as described on **page 38**.

To return to normal playback

When viewing a still frame playback, pressing **PAUSE II** or **PLAY ►** restores normal playback operation.

Viewing slow playback

Press and hold STEP/SLOW II► for about 2 seconds during playback.

- Slow playback is engaged.
- During slow playback, the speed of playback can be adjusted from 1/2 normal playback speed to 1/16 normal playback speed in four steps using **STEP/SLOW ◀II** and **STEP/SLOW II►**.

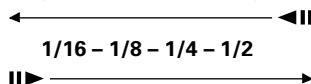

Press and hold STEP/SLOW ◀II for about 2 seconds during DVD playback.

- Slow playback in the reverse direction is engaged.

To return to normal playback

When viewing still frames or slow playback, pressing **PLAY ►** restores normal playback operation.

Frame by frame advance playback: Viewing one frame at a time

With this function, DVDs can be viewed in both forward and reverse directions. Video CDs can only be moved in the forward direction.

1 Press PAUSE II.

2 Press STEP/SLOW ◀II or STEP/SLOW II►.

STEP/SLOW II►: The picture advances one frame each time the button is pressed.

STEP/SLOW ◀II: The picture backs up a DVD a few frames each time the button is pressed.

To return to normal playback

When viewing frame by frame playback, pressing **PLAY ►** restores normal playback operation.

Notes

- There is no sound when viewing still frames or slow playback, or when advancing one frame at a time.
- Still frame, slow play, or frame advance playback may not be possible with certain titles. In this case, the  mark is displayed.
- If a Browsable picture (**page 68**) is recorded on a DVD-Audio disc, frame advance playback is possible.

Scanning in Forward and Reverse Directions at Different Speeds

– DVD/Video CD

This player incorporates technology that enables smooth playback of DVDs and Video CDs not only at different speeds but also in both forward and reverse directions. Video CDs cannot be played slowly in the reverse direction.

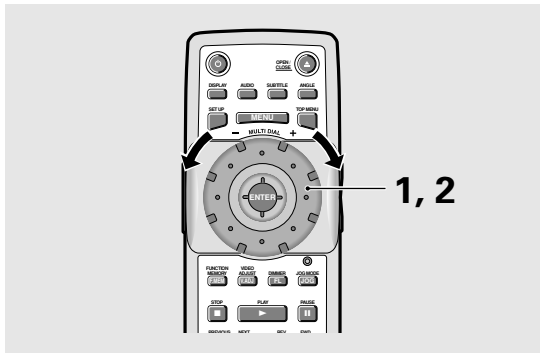

1 Rotate MULTI DIAL in the direction you want to scan until the appropriate scan speed is displayed on the screen.

- Rotate **MULTI DIAL** clockwise to scan in the forward direction.
- Rotate **MULTI DIAL** counterclockwise to scan in the reverse direction.

The incremental rate of scanning is the same in both directions, however, differs depending on the speed at which **MULTI DIAL** is turned as follows.

When MULTI DIAL is turned slowly

Clockwise rotation:



PLAY → 1/16 → 1/8 → 1/4 → 1/2 → 1/1 → SCAN 1 → SCAN 2 → SCAN 3

Counterclockwise rotation:

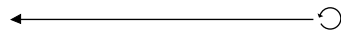

SCAN 3 ← SCAN 2 ← SCAN 1 ← 1/1 ← 1/2 ← 1/4 ← 1/8 ← 1/16 → PLAY

- It is possible to return to slower scan rates by turning **MULTI DIAL** in the opposite direction.
- If the dial is turned rapidly after being first turned slowly, the rates of search will jump to the type of scanning described below.
- Rates preceding "1/1" are slowed playback. "1/1" refers to the normal playback rate. "SCAN 1", "SCAN 2", and "SCAN 3", refer to progressively faster rates of scanning.

When MULTI DIAL is turned quickly

Clockwise rotation:



DVD: SCAN 1 → SCAN 2 → SCAN 3
Video CD: SCAN 1 → SCAN 2

Counterclockwise rotation:

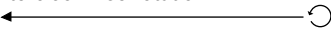

DVD: SCAN 3 ← SCAN 2 ← SCAN 1
Video CD: SCAN 2 ← SCAN 1

2 During scanning, turn MULTI DIAL quickly in the opposite direction of the search to resume normal playback.

Note

Pressing **PLAY** ► also ends slow or scan playback and returns to normal playback of the disc.

Manual scanning using the Jog Mode – DVD/Video CD

The Jog Mode can additionally be used to locate a frame you want to view, or a scene in a movie you wish to watch at a slow speed.

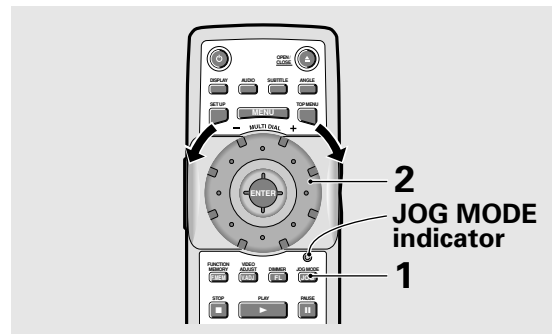

1 Press JOG MODE.

The **JOG MODE** indicator lights red.

2 Rotate MULTI DIAL clockwise to scan frame by frame in the forward direction. Rotate MULTI DIAL counterclockwise to scan frame by frame in the reverse direction. Video CDs cannot be scanned in the reverse direction.

When **MULTI DIAL** is not being turned, the video image is paused.

3 Press JOG MODE again to turn the Jog Mode off.

The **JOG MODE** indicator turns off.

Notes

- There is no audio when a slow or scan playback function is being performed, even when the speed is "1/1" in forward play.
- If a Browsable picture (page 68) is recorded on a DVD-Audio disc, scan playback is possible.
- Slow or scan playback may not be possible with certain titles. In this case, the mark is displayed.
- With Video CDs, slow or scan playback is not possible when the menu is displayed (PBC playback).
- With Video CDs, slow playback in the reverse direction is not possible.
- Depending on the DVD, slow reverse playback may not be smooth (picture shake or frames jump) and there may be some degradation of the picture quality. This is not a malfunction.
- Depending on the DVD, slow reverse playback or reverse frame by frame scanning may be canceled when the beginning of a chapter is encountered. This is not a malfunction.

Searching for a Title/Group, Chapter/Track, or Location on a Disc – DVD/Video CD/CD

This player offers different ways of accessing the information on a DVD, Video CD or CD. Using **SEARCH MODE**, you can search for titles or chapters on a DVD, tracks on a Video CD or CD, and even select the point in time to start playback.

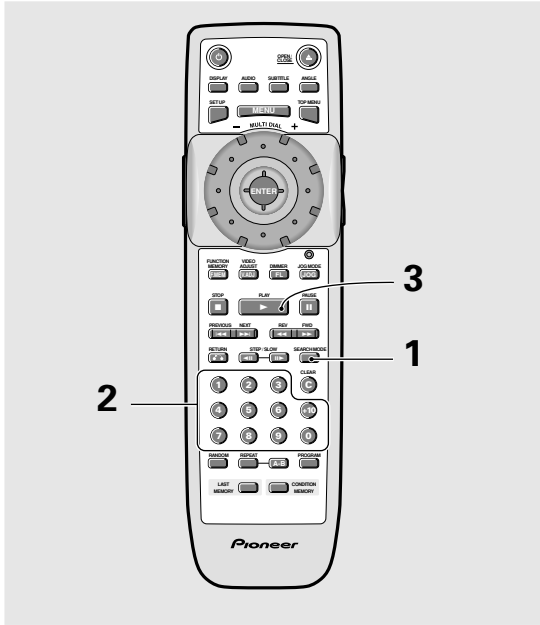

1 Press SEARCH MODE repeatedly to select the type of search.

The type of search changes with each press as follows.

Some DVD-Audio feature Browsible Pictures (page 68). You can search the still image you want to see by specifying the "page" number.

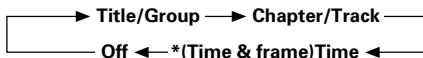

* The [Frame Search] option in the **Video** menu must be [On] to use this.(DVD)

2 Press the number button(s) of the desired title, chapter or track or of the specific time where you would like to begin playback.

- To select number 3, press **3**.
- To select number 10, press **1** and **0**.
- To select number 87, press **8** and **7**.

When performing a time/time & frame search: (Frame search is only possible with DVD discs.)

- To select 21 minutes, 43 seconds, press **2, 1, 4,** and **3**.
- To select 1 hour, 14 minutes, press **7, 4, 0,** and **0**.
- To select 21 minutes, 43 seconds and 16 frames, press **2, 1, 4, 3, 1** and **6**.

3 Press PLAY ►.

- Playback of the selected title/group or chapter/track starts.
- When a time search is performed, playback begins at the appointed time.
- When you do a time & frame search, the selected frame is displayed as a still.

To perform a direct title/group or chapter/track search using the number buttons

Press the number buttons while the disc is stopped to select a title or group number.

Press the number buttons while the disc is playing to select a chapter or track number.

- To select number 3, press **3**.
- To select number 10, press **+10** and **0**.
- To select number 37, press **+10, +10, +10** and **7**.

Notes

- For some discs, selection can be made using the top menu on the DVD. In this case, press **TOP MENU** to display the menu screen and then make your selection.
 - With some DVDs, the search operation may not be possible and may stop shortly after being performed. In this case, the mark is displayed.
 - Time search is not possible with CDs.
 - When performing DVD time search, playback may start from a slightly different time than that specified.
 - Time/time & frame search is not possible during when the disc is stopped.
 - Search using **SEARCH MODE** is not possible during PBC playback of Video CDs.
 - NTSC display 30 frames per seconds, number 0–29.
PAL display 25 frames per seconds, number 0–24.
- The Frame Search option in the **Video** menu must be [On] to use this. Press **DISPLAY** while a still picture is displayed to see the frame number.

Depending on the disc, it may not be possible to search for a specific frame. Also, when using frame advance, forward step or reverse step, it may not possible to view every frame. Each frame may not be appear in exact order when stepping through them. The number assigned to a specific frame may be different when stepping through the frames in forward or reverse mode.

Repeat Play – DVD/Video CD/CD

You can repeat an entire title or group, chapter or track, or just a part.

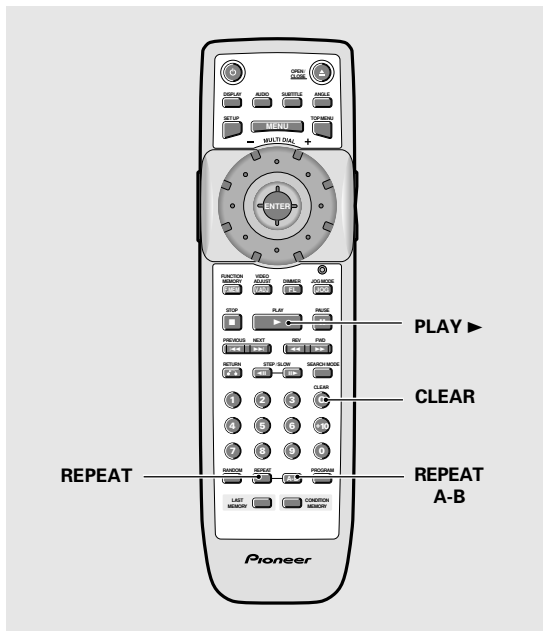

Repeat play of a chapter/track

Press **REPEAT** once during playback of the chapter or track you want to repeat.

Repeat play of a title

Press **REPEAT** twice during playback of the title or group you want to repeat.

- With DVDs, the title/group continues playing until the end, and then playback starts once more from the beginning of that title/group.
- With CDs and Video CDs, a disc is considered a single title, so the entire disc is repeated.

To repeat a program

Press **REPEAT** once during program playback to repeat the program.

To cancel repeat play

Press **CLEAR**. Playback continues, but the repeat function is canceled.

Repeat play of a specified section

Press **REPEAT A-B** at the beginning and end of the section you want to repeat.

- When **REPEAT A-B** is pressed a second time, the disc returns to the location where **REPEAT A-B** was pressed first and plays the selected section repeatedly.
- You can only perform A-B repeat within the same title.

To cancel A-B repeat play

Press **CLEAR**. Playback continues, but the repeat function is canceled.

Return to a specified location on a disc

- 1 Press **REPEAT A-B** at the desired location.
- 2 When you want to return to the specified location, press **PLAY** ►.

To clear the specified location

Press **CLEAR** to cancel repeat play or to clear the specified location that was set using **REPEAT A-B**.

Notes

- With some DVD discs, there may be times when repeat playback is not possible. In these cases, the  mark will appear on the screen.
- With Video CDs, repeat play is not possible when the menu is displayed (PBC playback). To perform repeat play, start playback without displaying a menu by pressing the track number to be repeated when the disc is stopped, and then press **REPEAT**.
- If you switch camera angle during repeat play, repeat play is cancelled.
- When using the still frame, A-B repeat or A-B return features with a DVD-RW (DV-S88A only), the player may sometimes return to a point earlier than the one you specified.

Random Play – DVD/Video CD/CD

Play titles, groups, chapters, or tracks on a disc in random order.

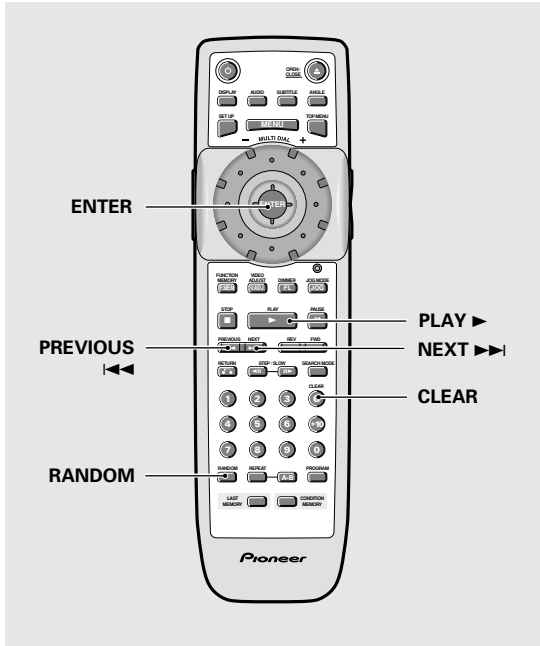

Random playback of chapters/ tracks within one title/group – DVD

Press **RANDOM** once, then press **ENTER** or **PLAY** ►.

“Random Chapter/Track” appears on the screen, and chapters/tracks within the title/group will be played back in random order.

Random playback of titles/groups – DVD

Press **RANDOM** twice, then press **ENTER** or **PLAY** ►.

“Random Title/Group” appears on the screen, and titles/groups will be played back in random order.

Random playback of tracks – Video CD/CD

Press **RANDOM**.

“Random” appears on the screen, and random playback begins.

To change titles, chapters, or tracks during random play

- Press **NEXT** ►► and the next randomly selected track starts playing.
- Press **PREVIOUS** ◄◄ and playback of the current track starts again from the beginning.

To stop random play

Press **CLEAR**. This returns you to normal playback of chapters/tracks in order from the chapter/track currently playing.

Notes

- With Video CDs, random play is not possible during playback when the menu is displayed (PBC playback). To perform random play, start playback without displaying a menu by pressing a track number button while in the stop mode, and then press **RANDOM**.
- Random play of programmed chapters/tracks is not possible.
- In the case of DVDs, random playback may not be possible with some discs.
- Repeat playback of random playback is not possible. In these cases, the  mark will appear on the screen.

Playback in a Desired Order (Program Play) – DVD/Video CD/CD

The titles and chapters within a title on a DVD and similarly the tracks on a Video CD or CD can be arranged to play in the order you want.

Programming DVDs

A program with a maximum of 24 steps can be memorized.

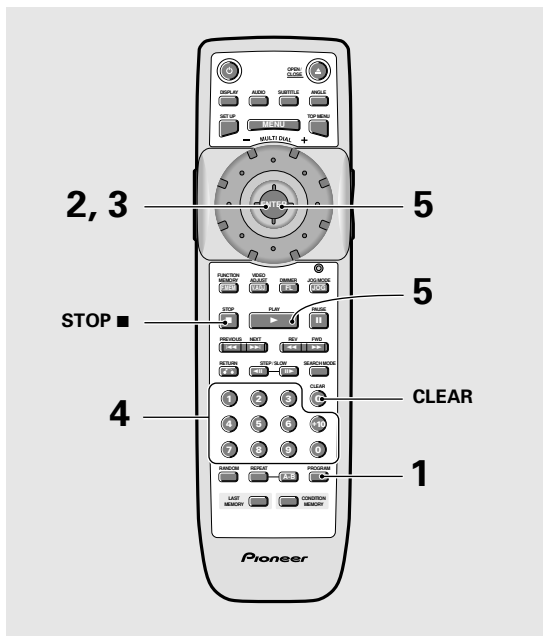

1 Press PROGRAM.

The Program screen appears.

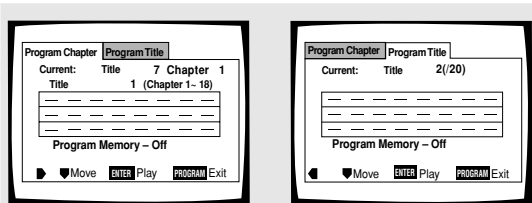

2 Move the cursor control joystick right or left to select either Chapter/Track or Title/Group program.

3 Once the program type is selected. Move the cursor control joystick down to enter the program window.

When [Program Chapter] is selected, you must also select what title the chapters to be programmed are in. Use the **cursor control joystick** up to highlight "Title (or Group)" and then use the **number buttons** to enter the title number to be used.

4 In the program window, use the number buttons to enter the numbers of the titles/groups or chapters/tracks in the order you want to program them in.

- To program DVD titles/chapters 9, 7, and 18 in order, press **9, 7, +10** and **8**.

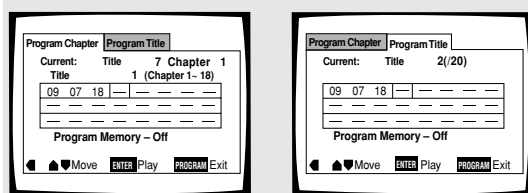

5 Press ENTER or PLAY.

- Playback starts in the set order.
- Press **PROGRAM** to return to the previous display. The program will not begin until **PLAY** is pressed.

To program a pause in a program

Press **PAUSE** instead of a number button.

"II" appears on the screen and the pause can be programmed.

A pause cannot be programmed as the first or last position in a program, and two or more pauses cannot be programmed in succession.

To delete a number:

Use the **cursor control joystick** to highlight the incorrect number and then press **CLEAR**.

The number is deleted. If the number was before another number, the later numbers are reordered automatically.

To insert a number:

Use the **cursor control joystick** to highlight the number to be placed after the new number and then press the **number button(s)** of the number to be inserted.

The new number is inserted before the previously selected number.

To stop program play

Press **STOP**.

Notes

- When programming chapters, chapters not programmed may appear on the screen. This is not a malfunction.
- Programming may not be possible with certain DVD discs. On these types of discs, the mark will appear on the screen when programming is attempted.
- Only chapters/tracks within the same title/group can be programmed during chapter/track programming.

Programming Video CDs, CDs

A program with a maximum of 24 steps can be memorized.

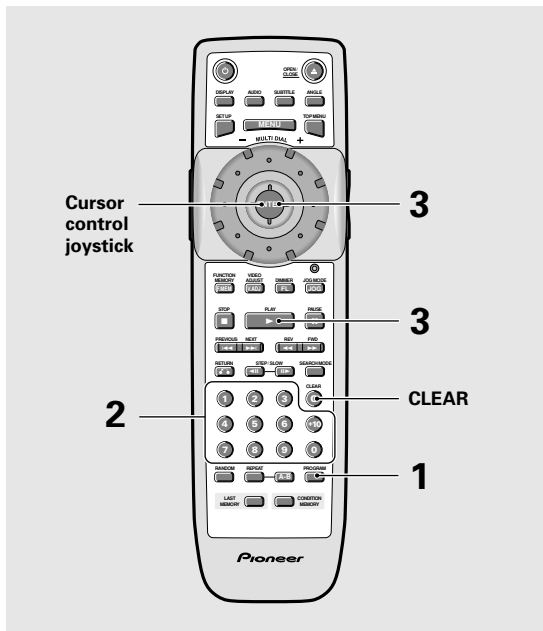

1 Press PROGRAM.

The program screen appears. When a Video CD or CD is loaded, the cursor appears in the program window.

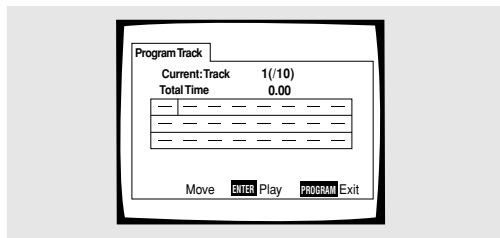

2 Use the number buttons to enter the numbers of the tracks in the order you want to program them in.

- To program tracks 9, 7, and 18 in order, press **9**, **7**, **+10** and **8**.
- To edit the program, refer to the procedures on the previous page.

3 Press ENTER or PLAY ►.

- Playback starts in the specified track order.
- To stop the program play, press **STOP** ■.

Notes

- To program a pause, or to add or delete a number, refer to the procedures for programming DVDs on **page 56**.
- You cannot program when playing a Video CD using menu selections (during PBC).

Additional programming options

– DVD/Video CD/CD

After you have made a program, it is then possible to confirm, add, or clear the contents of the program.

To confirm the contents of a program:

On a CD or Video CD track program, press **PROGRAM** to confirm. The program screen displays the current program.

On a DVD, select the program type (title/group or chapter/track) by moving the **cursor control joystick** right or left. The current DVD title/group or chapter/track program can then be confirmed on the appropriate program screen.

To add to a program:

- 1 Press **PROGRAM**.
- 2 Press a **number button** to add a new title, chapter, or track at the end of the program.
- 3 Press **PROGRAM** to exit the program screen.

To delete a program:

- 1 Press **PROGRAM**.
- 2 Select the program by moving the **cursor control joystick** right or left, then press **CLEAR**.
- 3 Press **PROGRAM** to exit the program screen.

Notes

- The complete program will be deleted even if the disc tray is open.
- Pressing **CLEAR** when the disc is stopped will clear all programs.

To make a program of your favorite parts of a disc as it plays – DVD/Video CD/CD

With this player, it is possible to make a program as you watch a DVD or Video CD or while listening to a CD.

Press and hold PROGRAM for at least 2 seconds at any point during playback of a title, group, chapter, or track you want to program, and it will be made into or added to a program without displaying a Program screen. When a title, group, chapter, or track is successfully added to the program, it is shown momentarily in the display as well as its position in the program.

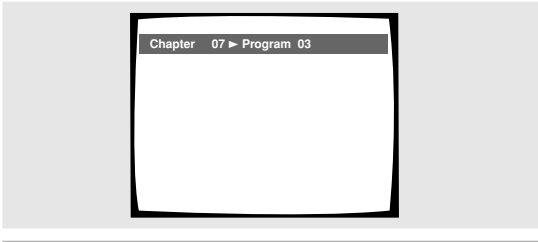

To confirm the contents of a program:

Press **PROGRAM**.

Notes

- When using this function to program DVDs, the program being created corresponds to the Program screen (chapter/track or title/group) that appears when **PROGRAM** is pressed. Be sure to check that the appropriate program type is selected.
- You cannot make a program containing chapters/tracks in different titles/groups.

To save a program in memory – DVD-Video

This player can memorize the programs on up to 24 DVDs. By turning the **[Program Memory]** to **[On]**, the player will save your program and recall it the next time you use the same DVD. When the program memory exceeds 24, programs will be erased in chronological order from the oldest program in memory.

- 1 Move the cursor control joystick down to highlight [Program Memory] and then right to select [On].**

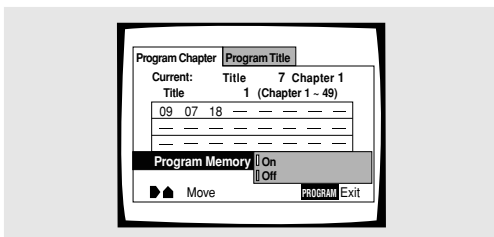

- 2 Press ENTER.**

The program is saved in memory.

Notes

- When a DVD with a program stored in memory is loaded, program playback may start automatically.
- You can't use Program Memory with DVD-Audio discs.

To erase a program saved in memory – DVD-Video

The player erases programs in chronological order when the maximum number of programs that can be held in memory is exceeded. To prevent the player from erasing older programs that you may still use regularly, or when you don't want to use a program anymore, it is possible to manually erase programs stored in memory.

- 1 Load a DVD that has a program stored in memory.**

- 2 Press PROGRAM.**

The program screen appears.

- 3 Move the cursor control joystick down to highlight [Program Memory] and then right and down to select [Off].**

- 4 Press ENTER.**

The program is cleared from memory.

Continuing Playback from a Specified Location (Last Memory) – DVD-Video/Video CD

The Last Memory function is convenient when you want to continue viewing a disc from the point where you were watching before. Unlike the resume function, the Last Memory function is effective even if the DVD is removed from the player (Last Memory locations saved for Video CDs are effective only if the disc remains loaded in the player).

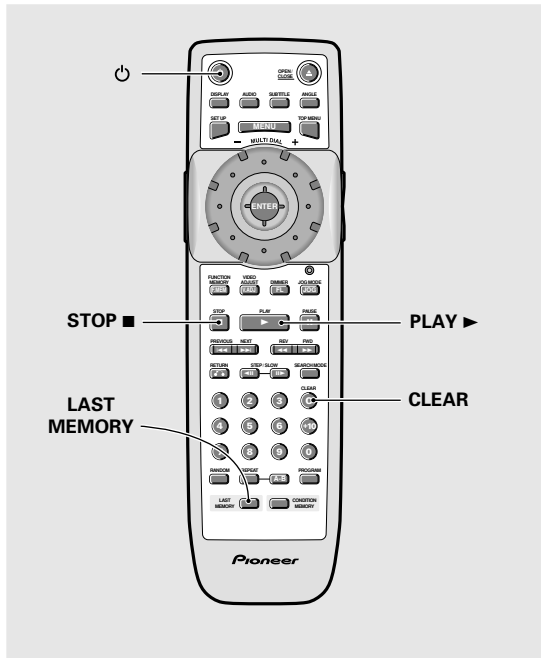

Memorizing a Last Memory location to return to later

1 Press LAST MEMORY during play.

The “LAST MEMORY” indicator lights on the player.

2 Press \odot to turn the power to standby, or stop playback with STOP ■.

Once memorized, the memorized point will be recalled even if the power is turned off, or if the disc is ejected. Points on up to 5 discs can be memorized, and those points are recalled the next time any of the discs are played back.

- A Last Memory point can be memorized for only one Video CD at a time as the function is only effective until the Video CD is removed from the player.

Resuming playback from where LAST MEMORY was pressed

1 Load a disc that has a Last Memory point memorized.

Some DVDs will start playback automatically when loaded. In this case, press **STOP** ■ to stop playback.

2 Press LAST MEMORY while in the stop mode.

The disc begins playback at the memorized point.

- Last Memory mode may not function for some DVDs.
- If you register more than five DVDs, details of the latest disc are memorized, while details of the least recent disc (the disc you registered first) is erased.
- Even with a disc you have memorized with Last Memory, playback begins at the start of the disc if you press **PLAY** ►.
- This function is for playback of DVD-Videos or Video CDs only. You cannot use it with CDs and DVD-Audios.

To clear the Last Memory location

Call up the Last Memory location by pressing **LAST MEMORY**. Then press **CLEAR** while “Last Memory” is still being displayed on the screen.

The “LAST MEMORY” indicator disappears from the display.

Memorizing Regularly Used Menu Settings (Function Memory) – DVD/Video CD/CD

You can create a shortcut menu that contains settings that you frequently change and call up this menu whenever you need to change one of the stored settings. Settings remain in memory regardless of the disc loaded in the player.

Creating the Function Memory item list

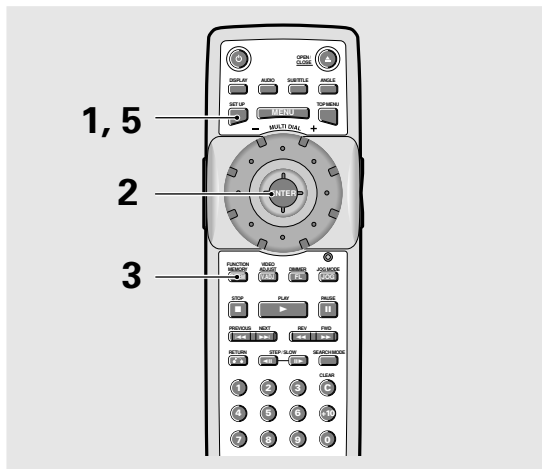

1 Press SETUP to display the Setup screen.

2 Move the cursor control joystick to select the menu and then the menu item you want to add to the Function Memory.

3 Press FUNCTION MEMORY.
If “FM” appears next to the menu item, the item has been successfully added to the Function Memory.

4 Repeat steps 2 and 3 to add as many as 5 items to the Function Memory.
When 5 items have already been stored, “FM” does not appear next to the item when **FUNCTION MEMORY** is pressed.

5 Press SETUP to close the Setup screen.

Note

Items that cannot be changed when the disc is playing cannot be added to Function Memory if the disc is currently playing. When these items are selected, on-screen information or  will be displayed.

Calling up the Function Memory item list

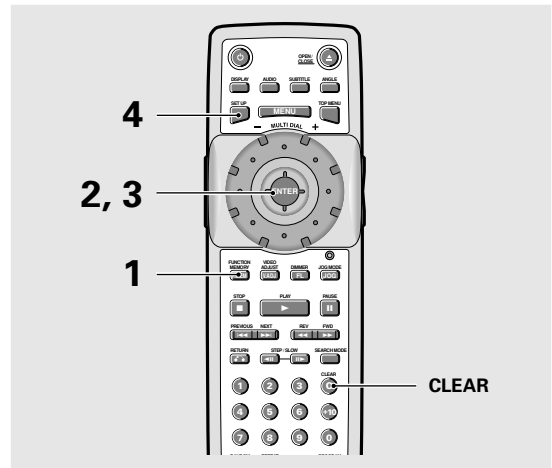

1 Press FUNCTION MEMORY.
The Function Memory item list appears on the screen.

2 Move the cursor control joystick to select the item you want to adjust and press ENTER.
The Setup screen opens, and the cursor is moved to the appropriate menu and menu item as selected in the Function Memory item list.

3 Move the cursor control joystick to make setting adjustments, then press ENTER.
The setting is changed. For more information on making adjustments in the Setup screen menus, refer to the section “Using the Setup Screen Menus” on page 28.

4 Press SETUP to close the Setup screen.

To clear an item from the FUNCTION MEMORY

- 1 Press **SETUP** to open the Setup screen.
- 2 Move the cursor control joystick to the menu and menu item marked with “FM”.
- 3 Press **FUNCTION MEMORY** to clear the item from the Function Memory. If “FM” disappears, the item has been cleared.
- 4 Press **SETUP** to close the Setup screen.

Memorizing Settings for Often Viewed DVDs (Condition Memory) – DVD-Video

You can store in memory settings for DVDs you often watch. Settings remain in memory even if you remove the disc from the player, or switch power to the player to standby. If you load a disc that has its settings memorized, **"COND. MEMORY"** appears in the display. When you start playing the disc, the memorized settings are automatically recalled.

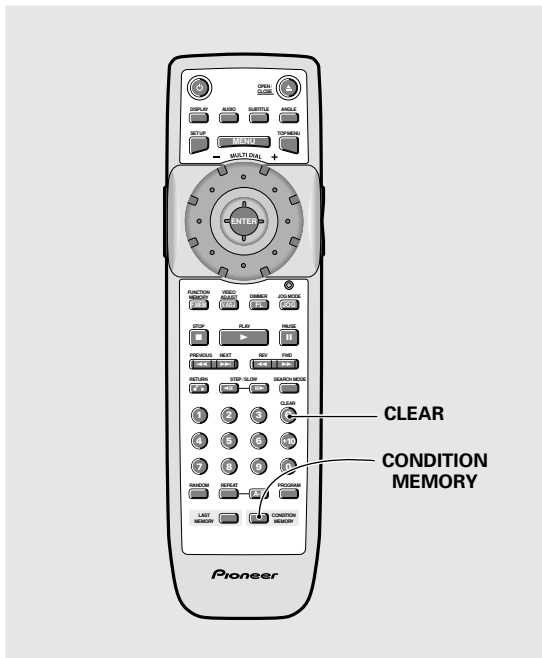

Press **CONDITION MEMORY** during playback.

Settings are memorized for the disc currently playing.

The following six settings are memorized:

- On Screen Display (page 38)
- Multi-Angle (page 39)
- Multi-language (pages 40, 41)
- Multi-Language subtitles (page 42)
- Parental Lock Level (page 45)
- Video Quality (page 49)

When a disc that has memorized settings is loaded

"Condition Memory" will appear on the screen, and the previously memorized settings will be selected.

Erasing the recorded contents

Load a disc that has memorized settings, and press **CLEAR** while **"Condition Memory"** is being displayed. The disc's recorded data will be erased.

Notes

- Settings are stored in memory for use any time.
- You can store settings for up to 15 DVDs in memory. If you memorize settings for more than 15 DVDs, previously memorized settings are erased in chronological order from the least recently memorized. Subsequently, if you load a disc with erased settings, the settings of the most recently played disc are used.
- If you make changes to any of the settings memorized in Condition Memory, press **CONDITION MEMORY** during playback to memorize new settings.
- Switching of the multi-language mode etc., is automatic on some discs.
- Condition Memory does not work with DVD-Audio discs.

Viewing Disc Information

– DVD/Video CD/CD

Use **DISPLAY** to get current information about the disc currently loaded. You can get information about the titles and chapters on a DVD or tracks on a Video CD or CD. When viewing DVDs, you can also check the digital bitstream transmission rate.

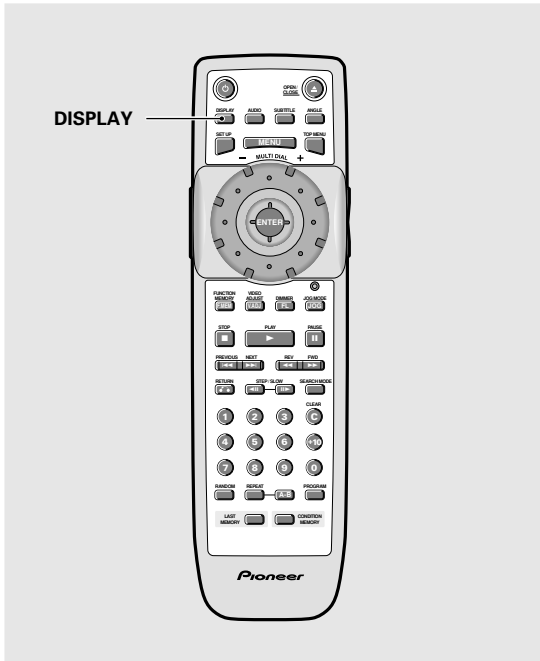

Press **DISPLAY** during while a disc is playing. Press **DISPLAY** repeatedly to change the information being displayed.

The disc information is displayed superimposed over the video image on the screen.

Press and hold **DISPLAY** to display the time remaining on the disc.

When you release the button, the information disappears.

Note

Depending on the format and type of disc being used, not all screens may be displayed.

The display changes for each type of disc as follows each time the button is pressed.

DVD-Video



TITLE information:

Top Row: title and chapter number, elapsed time of current title

Bottom Row: remaining time in title, total time of title

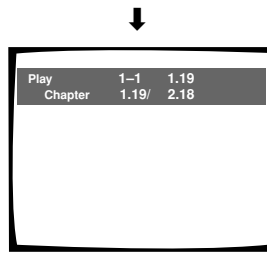

CHAPTER information:

Top Row: title and chapter number, elapsed time of current title

Bottom Row: time in current chapter, total time of chapter

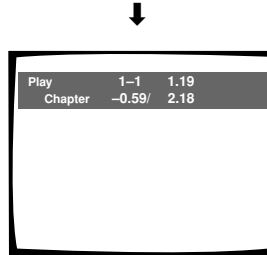

CHAPTER information:

Top Row: title and chapter number, elapsed time of current title

Bottom Row: remaining time in current chapter, total time of chapter

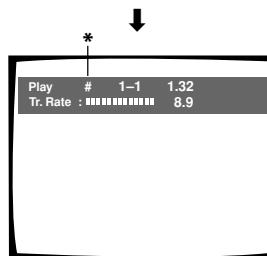

Data transmission rate information:

Top Row: title and chapter number, total elapsed time of DVD

Bottom Row: bitstream transmission rate level

* The hash mark (#) indicates that the current disc content is film material ([page 69](#))

Display off

DVD-Audio

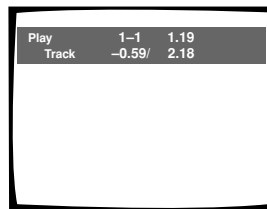

Track information

Top Row
Current group and track number, elapsed time of current track

Bottom Row
Remaining time in current track, total time of track

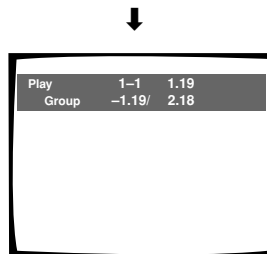

Group information

Top Row
Current group and track number, elapsed time of current track

(Bottom Row)
Remaining time in current group, total time of group

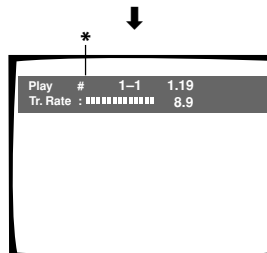

Bitstream transmission information

Top Row
Current group and track number, elapsed time of current track

Bottom Row
Bitstream transmission rate level

* The hash mark (#) indicates that the current disc content is film material ([page 69](#))

Display off

CD



Track Information:

Top Row: current track number, track time

Bottom Row: remaining time of current track, and total time of track



Disc information:

Top Row: current track number, total number of tracks on CD, total elapsed time of track

Bottom Row: remaining time of CD, total time of CD



Display off

Video CD (with PBC disabled)



Disc information:

Top Row: current track number, total number of tracks, total elapsed time of Video CD

Bottom Row: remaining time of Video CD, total time of Video CD

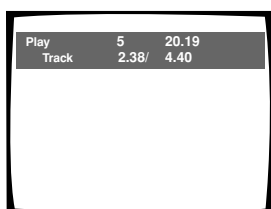

Track information:

Top Row: current track number, total elapsed time of Video CD

Bottom Row: track time, total time of track

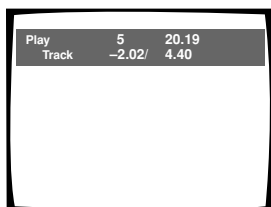

Track information:

Top Row: current track number, total elapsed time of Video CD

Bottom Row: remaining time of track, total time of track



Display off

Note

When playing Video CDs in PBC mode or unfinalized CD-Rs not all the above information is displayed.

Press **DISPLAY** during while a disc is stopped to display DVD title/group and chapter/track information or Video CD and CD track information. Press **DISPLAY** again to turn the display off.

Information about the titles/groups or chapters/tracks on a disc is displayed. When the information exceeds the space on the screen, use the **cursor control joystick** right or left to move to other screens.

DVD-Video

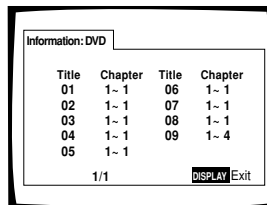

DVD-Video information

When a DVD-Video is loaded, each title and the number of chapters within each title is displayed.

DVD-Audio

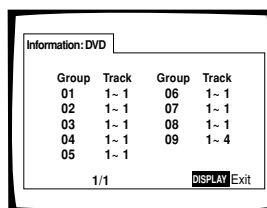

DVD-Audio information

When a DVD-Audio is loaded, each group and the number of tracks within each group is displayed.

DVD-RW (DV-S88A only)

Disc name (if programmed)

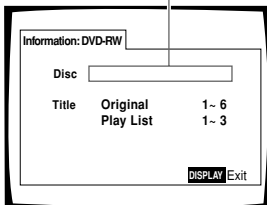

DVD-RW information

Disc name (if programmed) and number of titles in the Original recording and the Play List.

CD and Video CD

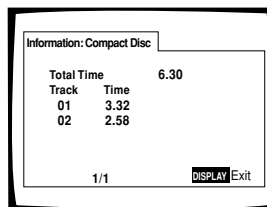

CD and Video CD information

When a CD or Video CD is loaded, the total time of the disc and the time of each track on the disc is displayed.

Resetting the Player to System Settings

To reset the player, press and hold **■/▲** on the front panel when pressing **⏻** **STANDBY/ON** (or **POWER**) on the front panel to turn the unit from standby to on.

All program memory, saved settings from functions such as Last Memory and Condition Memory are cleared, and all Setup screen menus are returned to factory settings.

Language Code List

Language codes are used when setting the audio and subtitle language preferences (**page 43**).

Language	Input-code
Japanese (ja)	1001
English (en)	0514
French (fr)	0618
German (de)	0405
Italian (it)	0920
Spanish (es)	0519
Chinese (zh)	2608
Dutch (nl)	1412
Portuguese (pt)	1620
Swedish (sv)	1922
Russian (ru)	1821
Korean (ko)	1115
Greek (el)	0512
Afar (aa)	0101
Abkhazian (ab)	0102
Afrikaans (af)	0106
Amharic (am)	0113
Arabic (ar)	0118
Assamese (as)	0119
Aymara (ay)	0125
Azerbaijani (az)	0126
Bashkir (ba)	0201
Byelorussian (be)	0205
Bulgarian (bg)	0207
Bihari (bh)	0208
Bislama (bi)	0209
Bengali (bn)	0214
Tibetan (bo)	0215
Breton (br)	0218
Catalan (ca)	0301
Corsican (co)	0315
Czech (cs)	0319
Welsh (cy)	0325
Danish (da)	0401
Bhutani (dz)	0426
Esperanto (eo)	0515
Estonian (et)	0520
Basque (eu)	0521
Persian (fa)	0601
Finnish (fi)	0609
Fiji (fj)	0610
Faroese (fo)	0615
Frisian (fy)	0625
Irish (ga)	0701
Scots-Gaelic (gd)	0704
Galician (gl)	0712
Guarani (gn)	0714

Language	Input-code
Gujarati (gu)	0721
Hausa (ha)	0801
Hindi (hi)	0809
Croatian (hr)	0818
Hungarian (hu)	0821
Armenian (hy)	0825
Interlingua (ia)	0901
Interlingue (ie)	0905
Inupiak (ik)	0911
Indonesian (in)	0914
Icelandic (is)	0919
Hebrew (iw)	0923
Yiddish (ji)	1009
Javanese (jw)	1023
Georgian (ka)	1101
Kazakh (kk)	1111
Greenlandic (kl)	1112
Cambodian (km)	1113
Kannada (kn)	1114
Kashmiri (ks)	1119
Kurdish (ku)	1121
Kirghiz (ky)	1125
Latin (la)	1201
Lingala (ln)	1214
Laothian (lo)	1215
Lithuanian (lt)	1220
Latvian (lv)	1222
Malagasy (mg)	1307
Maori (mi)	1309
Macedonian (mk)	1311
Malayalam (ml)	1312
Mongolian (mn)	1314
Moldavian (mo)	1315
Marathi (mr)	1318
Malay (ms)	1319
Maltese (mt)	1320
Burmese (my)	1325
Nauru (na)	1401
Nepali (ne)	1405
Norwegian (no)	1415
Occitan (oc)	1503
Oromo (om)	1513
Oriya (or)	1518
Panjabi (pa)	1601
Polish (pl)	1612
Pashto, Pushto (ps)	1619
Quechua (qu)	1721

Language	Input-code
Rhaeto-Romance (rm)	1813
Kirundi (rn)	1814
Romanian (ro)	1815
Kinyarwanda (rw)	1823
Sanskrit (sa)	1901
Sindhi (sd)	1904
Sangho (sg)	1907
Serbo-Croatian (sh)	1908
Sinhalese (si)	1909
Slovak (sk)	1911
Slovenian (sl)	1912
Samoa (sm)	1913
Shona (sn)	1914
Somali (so)	1915
Albanian (sq)	1917
Serbian (sr)	1918
Siswati (ss)	1919
Sesotho (st)	1920
Sundanese (su)	1921
Swahili (sw)	1923
Tamil (ta)	2001
Telugu (te)	2005
Tajik (tg)	2007
Thai (th)	2008
Tigrinya (ti)	2009
Turkmen (tk)	2011
Tagalog (tl)	2012
Setswana (tn)	2014
Tonga (to)	2015
Turkish (tr)	2018
Tsonga (ts)	2019
Tatar (tt)	2020
Twi (tw)	2023
Ukrainian (uk)	2111
Urdu (ur)	2118
Uzbek (uz)	2126
Vietnamese (vi)	2209
Volapük (vo)	2215
Wolof (wo)	2315
Xhosa (xh)	2408
Yoruba (yo)	2515
Zulu (zu)	2621

Additional Information

For Proper and Long Use of This Unit

Disc Care

How to hold discs

When loading or removing discs, try not to touch their playing surfaces.



Cleaning

Fingerprints or other dirt on the disc may affect sound and picture quality.

To clean your discs, use a soft clean cloth to wipe them. If necessary, moisten a soft cloth with diluted neutral detergent to remove heavy dirt or fingerprints.



Do not wipe in a circular direction (Concentric scratches in the disc groove tend to cause noise).



Gently wipe from the inside toward the outer edge.

Discs must not be cleaned with record cleaning sprays, or static prevention sprays, etc. Also do not use volatile liquids such as benzine, or thinner, etc.

Never play cracked or warped discs

The disc revolves in the player at high speed when it is played. Never play a cracked, scratched or warped disc. This may damage the player or cause it to malfunction.

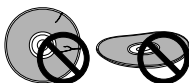

Never use discs with special shapes

CD's with special shapes (heart-shaped CDs, octagonal CDs, etc.) cannot be played on this set. Attempting to do so may damage the set. Do not use such CDs.

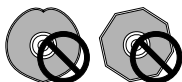

After using discs, store them upright

After playing a disc, always remove it from the player and return it to its jacket. Then store it standing upright away from heat and humidity.

- Store discs carefully. If you store discs at an angle, or stacked on top of each other, discs may become warped even when in their jackets.
- Do not leave discs in locations such as the seat of a car, which may become excessively hot.

CAUTION WHEN USING THE DISC

All rights reserved.

Unauthorized public performance, broadcasting or copying is a violation of applicable laws.

Do not move the unit during playback

During playback, the disc rotates at high speed. Do NOT lift or move the unit during playback. Doing so may damage the disc.

When moving the unit

When changing places of installation or packing the unit for moving, be sure to remove the disc and return the disc table to its original position in the player. Then, press **STANDBY/ON** and switch the power to standby. **Check that the "--OFF--" indication on the display goes off**, then disconnect the power cord. Moving this unit with the disc loaded may result in damage to this unit.

Installation

- Select a stable place to the side of a TV set or stereo system to be connected to the unit.
- When using the unit with a stereo system, install the speakers a little bit away from the TV.
- Do NOT install the unit on top of a TV or color monitor. Install the unit away from equipment that may be affected by magnetism, such as a cassette deck.
- Do NOT place objects on top of the unit.

Avoid installing in a place that is:

- Exposed to direct sunlight
- Exposed to humidity or where ventilation is poor
- Extremely hot or cold
- Exposed to vibration
- Exposed to dust
- Exposed to oily smoke, steam or heat (for example, a kitchen)

Do not block vents

Do NOT use the player on top of a long-fibered carpet, bed or sofa, and do not cover it with a cloth, etc. This will prevent heat radiation and could result in damage.

Avoid heat

Do NOT place the unit on equipment which generates heat, such as an amplifier. When installing the unit in a rack, place it on the lowest shelf possible (however, not where it is exposed to dust) and separated from the amplifier to avoid the heat generated by the amplifier or other audio equipment.

CAUTION: WHEN PLACING THE UNIT IN A STEREO RACK WITH GLASS DOORS

Be sure there is ample space between the unit and the glass doors when opening the disc table using the remote control. If the disc table opens against strong resistance, such as a closed glass door, damage to the unit may result.

Lens cleaner

The player's pickup lens should not become dirty in normal use, but if for some reason it should malfunction due to soiling, contact your nearest PIONEER authorized service center. Lens cleaners are commercially available, but special care should be exercised in their use since some may cause damage to the lens.

Condensation

Moisture may form in the operating section of the player if the player is brought from cool surroundings into a warm room or if the temperature of the room rises suddenly. When this happens, the player's performance will be impaired.

To prevent this, let the player stand in its new surroundings for about an hour before switching it on, or make sure that the room temperature rises gradually. Condensation may also form during the summer if the player is exposed to the breeze from an air conditioner. In such cases, change the location of the player.



Switch POWER to STANDBY when not using the unit

Depending on the strength of the TV or radio broadcast signal, having the TV or radio on while power to the unit is on may result in stripes on the TV screen or noise.

However, this is not a malfunction of this unit or the TV or radio. In such a case, switch the power of the unit to standby.

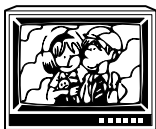

Power-cord caution

Handle the power cord by the plug. Do not pull out the plug by tugging the cord and never touch the power cord when your hands are wet as this could cause a short circuit or electric shock. Do not place the unit, a piece of furniture, etc., on the power cord, or pinch the cord. Never make a knot in the cord or tie it with other cords. The power cords should be routed in such a way that they are not likely to be stepped on. A damaged power cord can cause a fire or give you an electrical shock. Check the power cord once in a while. When you find it damaged, ask your nearest PIONEER authorized service center or your dealer for a replacement.

Cleaning the player

To clean the PLAYER, wipe with a soft, dry cloth. For stubborn dirt, wet a soft cloth with a mild detergent solution made by diluting one part detergent to 5 or 6 parts water, wring well, then wipe off the dirt. Also use a dry cloth to wipe the surface dry. Do not use volatile liquids such as benzene and thinner which are harmful to the unit.

Notes on using optical cables

- Do not route cords around sharp angles. When storing, wind the cords so that they have a diameter of at least 15 cm.
- When connecting, push all the way into the terminal.
- Do not use cords with a length of over 3 m.
- If moisture or dust has collected on the plug, wipe it with a soft cloth before connecting.



Troubleshooting

Incorrect operations are often mistaken for trouble and malfunctions. If you think that there is something wrong with this component, check the points below. Sometimes the trouble may lie in another component. Inspect the other components and electrical appliances being used. If the trouble cannot be rectified even after exercising the checks listed below, ask your nearest PIONEER authorized service center or your dealer to carry out repair work.

The disc table comes back out automatically, shortly after the disc table is closed.

The disc is dirty or warped.

- ➔ Refer to 'Disc Care' (page 65).

The disc is not placed properly on the disc table.

- ➔ Use the disc table guide to align the disc (page 24).

Region number does not conform with this unit.

- ➔ If the region number on the disc does not match the number on the player, the disc cannot be used (page 69).

There is condensation on the operating section of the player.

- ➔ Allow time for condensation to evaporate. If player is near an air conditioning unit, you should move the player (page 66).

Playback is not possible.

The disc has been loaded upside down.

- ➔ Check that the disc has been loaded with the label side facing up.

DVD-Audio playback stops.

- ➔ The disc may have been illegally copied.

mark appears on screen.

The selected function does not operate for that disc.

mark appears on screen.

The operation is prohibited by the player.

Picture playback stops and the operation buttons cannot be used.

Player malfunctions.

- ➔ Stop disc playback (press **STOP** ■), then start playback again.

New settings made in the Setup screen menus while a disc is playing are ineffective.

Some settings can be changed while a disc is playing, but are not effective. This is not a malfunction.

- ➔ Make the same setting when the player is stopped.
- ➔ Stop disc playback (press **STOP** ■), then start playback again. When playback is resumed, the new settings should be in effect. Please note that making settings in the Setup screen menus may cancel the resume function.

When making changes in the Setup screen menus, DVD is displayed.

There is a Video CD or CD loaded in the player and the setting that was changed only applies to DVD performance.

- ➔ The setting will be effective the next time a DVD is loaded.

Settings are canceled.

When the power is turned off by power failure or by unplugging the power cord, settings will be canceled.

- ➔ Before unplugging the power cord, press \odot on the remote control checking that "--OFF--" disappears in the display.
Additionally, press **POWER** on the front panel to turn the player off (DV-S838A).

No picture.

Connection is incorrect.

- ➔ Check that cord connections are correct and that plugs are firmly connected.

Operation (settings) of TV or AV amplifier is not appropriate.

- ➔ Be sure that your TV, receiver, or amplifier is set up to view DVD playback.

The screen is stretched or aspect does not change.

The multi aspect setting is not appropriate.

- ➔ Change the aspect setting in the **[TV Screen]** setting in the Setup screen **Video** menu to the screen type most appropriate to the TV or monitor you are using (**page 36**).

The screen is suddenly squeezed when the Setup screen is opened.

If the Setup screen is opened during playback of a DVD being viewed in the letter box format, the screen may switch to the wide screen format.

- ➔ This is not a malfunction. The screen will return to normal when the Setup screen is closed.

Picture disturbance during playback or dark.

This is not a malfunction.

- ➔ This player is compatible with Macro-Vision System copy guard. Some discs include a copy prevention signal, and when this type of disc is played back, stripes etc., may appear on some sections of the picture depending on the TV.

When using a component video connection, if progressive scan output is selected with a TV that is not compatible with progressive scan video, you will not be able to see any picture. To, remedy this, do one of the following:

- ➔ Set the rear panel **COMPONENT VIDEO OUT** switch to **525i (480i)**. (This overrides the Setup menu setting.)

When recorded on a VCR or passed through an AV selector, there is disturbance in the playback picture.

This is not a malfunction.

- ➔ Due to the player's copy protection circuits, connection of this device through a VCR or an AV selector may prevent recording or cause picture problems.

Remote control operation is not possible.

The rear panel control input jack on the player is being used.

- ➔ Point the remote control at the component that the player is connected to (**page 19**).

The remote control is too far from the player, or the angle with the remote sensor is too wide.

- ➔ Be sure to operate the remote from a location within its operating range (**page 8**).

The batteries are exhausted.

- ➔ Replace the exhausted batteries with all new batteries (**page 8**).

Audio is not output or is distorted.

The Setup screen **Audio 1** menu **[Linear PCM Out]** setting is set to **[Down Sample On]**. Digital output is prohibited on some discs.

- ➔ Be sure to make analog audio connections as well as digital connections (**page 17**).

The disc is dirty.

- ➔ Refer to '*Disc Care*' (**page 65**).

The connection plugs are not inserted fully into the terminals or are not connected.

- ➔ Check that all connection plugs are firmly inserted.

The connection plug or terminal is dirty.

- ➔ Check that the plugs and terminals are wiped clean of dirt, etc.

Audio cable connection is wrong.

- ➔ Check to make sure that the audio cables are connected correctly (**page 14**).

Connection is made to the stereo amplifier's PHONO input terminal.

- ➔ Change connection to any input terminal except PHONO.

The pause mode is engaged.

- ➔ Press **PLAY ▶** or **PAUSE II** to exit the pause mode.

Stereo amplifier operation is incorrect.

- ➔ Check input (CD, AUX, etc.) selector to determine if it is selected for DVD playback.

Noticeable difference in DVD and CD volume.

DVDs and CDs use different recording methods.

- ➔ This is not a malfunction.
- ➔ When playing DVDs with the Gain Setting set to **[Variable]**, the overall volume may seem lower than on the **[Fix]** setting.

Audio mix does not sound right or sounds incomplete (for example, the dialog of the actors cannot be heard).

Audio output selection is incorrect.

- ➔ When **[5.1 Channel]** is selected, Dialog is not output from the front left and right speakers. When **[2 Channel]** is selected, sound is only output through the front left and right speakers.

Caution

Static electricity or other external influence may cause malfunctioning of this unit. In this case, unplugging the power cord and then re-plugging it in will usually reset the unit for proper operation. If this does not correct the problem, please consult your nearest PIONEER service center.

Terms

Aspect ratio

Aspect ratio refers to the length to height ratio of TV screens. The ratio of a standard TV is 4:3, while the ratio of a high-definition or wide TV is 16:9. The latter allows you to enjoy a picture with a wider perspective.

Bonus Group (DVD-Audio only)

An 'extra' group on some DVD-Audio discs that requires a key number to access. See also Group.

Browsable pictures (DVD-Audio only)

A feature of some DVD-Audio discs in which the user can browse still pictures recorded on the disc as the audio is played. See also Slideshow.

Chapter number

Chapter numbers are the numbers assigned to sections of a title on the disc, similar to chapters in a book. If the disc includes chapter numbers, you can locate the section you want very quickly using search and other functions.

Component (color difference) video output

The color signal of the TV is divided into the luminance (Y) signal and the color (P_B and P_R) signals and then output. In this way mutual interference of each signal is avoided. On a TV with component input jacks, these signals are synthesized to produce the picture.

Condition memory

"Condition" refers to the various mode settings, etc. On this player, various conditions, such as those set during playback, can be memorized. This function allows you to play back the same disc at any time without having to redo your preferred settings.

Digital bitstream

The bitstream does not refer to the audio signal, but rather to the digital data that, once converted, becomes the audio signal. The player outputs digital bitstreams via the digital optical or digital coaxial output. If the bitstream cannot be decoded by the connected AV amplifier etc., digital noise is produced. Digital bitstream formats compatible with different entertainment systems can be selected in the Setup screen **Audio 1** menu.

Digital output (Coaxial)

Output of the digital audio signal is transmitted electronically using a coaxial cable. Because the signal being transmitted is digital, connection must be made to the coaxial digital input of another component. Noise will be output if connected to the analog audio inputs as the digital signal cannot be decoded.

Digital output (Optical)

Normally, audio is converted to an electric signal and transmitted through an electric wire from the player to the amplifier, etc. Changing this signal to a digital signal and transmitting it through a fiber-optic cable is called optical digital output. Similarly, optical digital input receives digital signals from external units such as an AV amplifier or receiver.

Dolby Digital

Using a maximum of 5.1 channels of audio, this high quality surround system is used in many of the finer movie theaters around the world.



DTS

DTS stands for Digital Theater System. DTS is a surround system different from Dolby Digital that has become a popular surround sound format for movies.



Dynamic range

Dynamic range refers to the difference between the maximum and minimum levels of the audio soundtrack as measured in decibels (dB).

Compressing the dynamic range raises the minimum signal level and lowers the maximum signal level. This allows you to hear voices and other low level audio signals clearly while lowering strong audio signals like the sound of explosions.

Group (DVD-Audio only)

A collection of tracks on a DVD-Audio disc. Equivalent to a DVD-Video title. See also Title and Track.

Interlaced video

A method of displaying a picture in which odd-numbered lines are updated in one pass, then even-numbered lines updated in the next. See also Progressive scan video.

MPEG Audio

An audio format used on Video CDs and some DVD discs. This unit can convert MPEG audio to PCM format for wider compatibility with digital recorders and AV amplifiers. See also PCM.

MPEG Video

Short for Moving Picture Experts Group. This is an international standard for compression of moving images. On some DVDs, digital audio has been compressed and recorded in this format.

Multi-angle

When you watch a TV program, you are watching the image filmed through the TV camera. Because of this, the picture is displayed on your TV from the viewpoint of the TV camera's position. In a TV studio, the image is filmed by many cameras at the same time, and one of those images is selected by the program director and transmitted to your TV. If all the filmed images were transmitted to your TV you would be able to select the camera image you want. Some DVD discs are recorded with the angles of more than one camera used for filming, and these can be selected using this player. These types of discs are called multi-angle discs.

Packed PCM (DVD-Audio only)

A lossless compression system that enables more PCM audio to be stored on a DVD-Audio disc than would otherwise be possible.

Parental lock level

This function was suggested by parents concerned about what type of media their children were able to watch. Parental lock restrictions are restrictions incorporated into titles which include scenes that parents may not wish their children to view.

PCM

PCM stands for Pulse Code Modulation and is digital audio. The digital audio of CDs is PCM. This player also has a function that converts Dolby Digital and MPEG digital bitstreams into PCM to enable you to listen to quality digital sound even without a special decoder.

Playback Control (PBC)

This refers to signals recorded on a Video CD (Version 2.0) enabling playback control. You can use menus recorded on discs with PBC for easy, interactive search for desired scenes, and playback. You can also enjoy viewing high-resolution/standard resolution still images.

Progressive scan video

Also called non-interlaced video, this method of displaying a picture updates all the lines in one pass, resulting in a more stable, flicker-free image than interlaced video (for a given scanning rate). See also Interlaced video.

PureCinema

Video on a DVD discs may be either video material (originally shot on video) or film material (originally shot on film). Video material has a frame rate of 30 frames/sec., compared with 24 frames/sec. for film. This player converts film material to 60 frames/sec. (in progressive scan mode). PureCinema adjusts the picture so that it matches more closely the picture quality of a cinema screen.

You can see whether video on a DVD disc is film or video material by displaying the video transmission rate. If a hash mark (#) appears above the transmission rate display, it is film material.

Regional restriction codes (region number)

Regional restriction codes are built in to DVD players and DVD discs for each sales region. If the regional code of the DVD player does not match one of the regional codes of the DVD disc, playback is not possible.

The region number can be found on the rear panel of the DVD player. The illustration below shows the regions and corresponding region numbers.

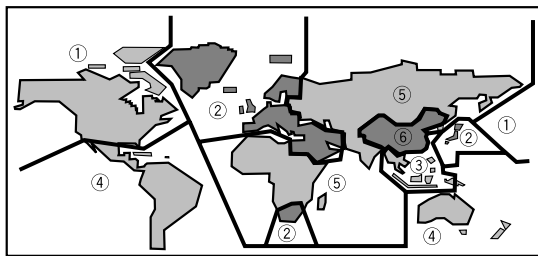

Sampling Frequency

When a sound wave is converted to a digital signal, the sound is sampled and converted to data at a specific frequency rate. For example, a signal with a 96 kHz sampling rate indicates that in one second, the analog signal was sampled 96000 times to produce the digital signal.

Slideshow

A feature of some DVD discs in which still pictures recorded on the disc cycle automatically as the audio is played. See also Browsable pictures.

Subtitle

Subtitles are language titles superimposed on movies, or other media. Up to 32 different subtitle languages can be recorded on a DVD disc. The subtitle function can be used to select the language of your choice.

S-video

Connecting the S-video output on the player to a TV or monitor with S-video input via an S-video cable produces clearer picture reproduction by sending separate signals for the luminance and the color. These signals are then combined by the television to produce a better quality picture.

System control

When you connect this player via a cord with a mini plug to another Pioneer component such as a receiver or an amplifier bearing the  mark, you can control the player as though it were a component in a system. To control the player, point the player's remote control at the component that the player is connected to, and not the player itself.

Specifications

General

System .. DVD system and Compact Disc digital audio system
Power requirements

DV-S88A AC 110 V, 60 Hz

DV-S838A AC 220-240 V, 50/60 Hz

Power consumption

DV-S88A 29 W

DV-S838A 31 W

Power consumption in standby mode less than 1 W

Weight 9.0 kg

Dimensions 420 (W) x 371 (D) x 130 (H) mm
(Not including protruding cables, etc.)

Operating temperature +5°C to +35°C

Operating humidity 5% to 85% (no condensation)

S-Video output (2 individual outputs)

Y (luminance) - Output level 1 Vp-p (75 Ω)

C (color) - Output level 286 mVp-p (75 Ω)

Jacks S-VIDEO jack

Video output (2 individual outputs)

Output level 1 Vp-p (75 Ω)

Jacks RCA jack

Component video output

(Y, P_B, P_R)

Output level Y: 1.0 Vp-p (75 Ω)

P_B, P_R: 0.7 Vp-p (75 Ω)

Jacks RCA jack

D2 video output

Output level Y: 1.0 Vp-p (75 Ω)

P_B, P_R: 0.7 Vp-p (75 Ω)

Jacks D terminal

Audio output (2 individual outputs)

Output level

During audio output 200 mVrms (1 kHz, -20 dB)

Number of channels 2

Jacks RCA jack

Audio output (5.1 Channel)

Output level

During audio output 200 mVrms (1 kHz, -20 dB)

Number of channels 6

Jacks RCA jack

Digital audio characteristics

Frequency response ... 4 Hz to 88 kHz (DVD fs: 192 kHz)

S/N ratio more than 115 dB

Dynamic range more than 110 dB

Total harmonic distortion 0.001%

Wow and flutter Limit of measurement
(±0.001% W. PEAK) or lower

Digital output

Optical digital output Optical digital jack

Coaxial digital output RCA jack

Other terminals

CONTROL IN Minijack (3.5 ø)

CONTROL OUT Minijack (3.5 ø)

Accessories

Audio cord 1

Video cord 1

Power cord 1

Remote control unit 1

AA (R6P) dry cell batteries 2

Operating Instructions 1

Note

The specifications and design of this product are subject to change without notice, due to improvement.

Published by Pioneer Corporation.
Copyright © 2000 Pioneer Corporation.
All rights reserved.

PIONEER CORPORATION 4-1, Meguro 1-Chome, Meguro-ku, Tokyo 153-8654, Japan **K002AEn**
PIONEER ELECTRONICS [USA] INC. P.O. BOX 1540, Long Beach, California 90801-1540, U.S.A.
PIONEER ELECTRONICS OF CANADA, INC. 300 Allstate Parkway, Markham, Ontario L3R 0P2, Canada
PIONEER EUROPE NV Haven 1087, Keetberglaan 1, B-9120 Melsele, Belgium TEL: 03/570.05.11
PIONEER ELECTRONICS AUSTRALIA PTY. LTD. 178-184 Boundary Road, Braeside, Victoria 3195, Australia, TEL: [03] 9586-6300
PIONEER ELECTRONICS DE MEXICO S.A. DE C.V. San Lorenzo 1009 3er Piso Desp. 302 Col. Del Valle Mexico D.F. C.P. 03100
TEL: 5-688-52-90