

Register your product and get support at
www.philips.com/welcome

User manual

Руководство пользователя



PHILIPS



Manufactured under license from Dolby Laboratories. Dolby and the double-D symbol are trademarks of Dolby Laboratories.



DivX Certified products: "DivX Certified, and associated logos are trademarks of DivX, Inc. and are used under license.



Windows Media and the Windows logo are trademarks, or registered trademarks of Microsoft Corporation in the United States and/or other countries.

This product incorporates copyright protection technology that is protected by method claims of certain U.S. patents and other intellectual property rights owned by Macrovision Corporation and other rights owners. Use of this copyright protection technology must be authorized by Macrovision Corporation, and is intended for home and other limited viewing uses only unless otherwise authorized by Macrovision Corporation. Reverse engineering or disassembly is prohibited.

CONSUMERS SHOULD NOTE THAT NOT ALL HIGH DEFINITION TELEVISION SETS ARE FULLY COMPATIBLE WITH THIS PRODUCT AND MAY CAUSE ARTIFACTS TO BE DISPLAYED IN THE PICTURE. IN CASE OF 525 OR 625 PROGRESSIVE SCAN PICTURE PROBLEMS, IT IS RECOMMENDED THAT THE USER SWITCH THE CONNECTION TO THE 'STANDARD DEFINITION' OUTPUT. IF THERE ARE QUESTIONS REGARDING OUR TV SET COMPATIBILITY WITH THIS MODEL 525p AND 625p DVD PLAYER, PLEASE CONTACT OUR CUSTOMER SERVICE CENTER.

English ----- 4

Русский ----- 41

General Information

Features	6
Supplied accessories	6
Environmental information	6
Safety information	6~7
Maintenance	7
Hearing Safety	7

Connections

Step 1: Placing speakers and subwoofer	8
Step 2: Connecting speakers and subwoofer .	8
Step 3: Connecting TV set	9~10
Using Video In jack (CVBS)	
Using Headphone jack	
Using component Video In jack (Pr Pb Y)	
Using S-Video In jack	
Using an accessory RF modulator	
Step 4: Connecting the FM antenna	11
Step 5: Connecting the power cord	11
Step 6: Connecting a VCR or cable/satellite box	11
Step 7: Connecting digital audio equipment .	12
Step 8: Connecting portable audio player	12

Functional Overview

Controls on the system	13
Remote control	14~15

Getting Started

Step 1: Using the Remote Control	16
Step 2: Setting up the TV	16~18
Selecting the color system that matches your TV set	
Setting up Progressive Scan feature (for Progressive Scan TV only)	
To deactivate Progressive manually	
Step 3: Setting language preference	18
Setting the OSD Language	
Setting the Audio, Subtitle and Disc Menu language	

Basic Operations

Plug and Play (for tuner installation)	19
Switching the system on/off	19
Power saving automatic standby	19
Volume control	20
Sound Control	20
DBB (Dynamic Bass Boost)	
DSC (Digital Sound Control)	
LOUDNESS	

Disc Operations

Playable Discs	21
Region Codes	21
Playing discs	22
Using the Disc Menu	22
Resuming playback	22
Selecting and searching	22~23
Selecting a different track/chapter	
Fast forwarding/reversing	
Slow forwarding/reversing	
Different play modes: REPEAT, SHUFFLE and REPEAT A-B	23
REPEAT	
Repeat A-B	
Programming favourite chapters/tracks	24
Display information	24
Moving to another title/chapter	24
Viewing from another angle	25
ZOOM	25
AUDIO	25
SUBTITLE	25
Playing MP3/Picture disc (Kodak, JPEG) .	25~26
Playing MP3 music and JPEG pictures simultaneously	26
Playing a Divx disc	27

System Menu Options

Basic operations	28
General Setup Page	28
OSD Lang	
Screen Saver	
DIVXVOD	
Audio Setup Page	28~29
Night Mode	
Digital Output	
Dolby Digital Setup	
Video Setup Page	29~30
TV Display	
Progress	
TV Type	
Preference Page	30~31
Audio	
Subtitle	
Disc Menu	
Parental	
Password	
Divx Subtitle	
Default	

Radio Reception

Tuning to radio stations	32
Programming radio station	32
Automatic programming	
Manual programming	
Tuning to preset radio stations	32

USB Connection

Using USB connectivity	33~34
------------------------------	-------

Clock/Timer

Viewing clock	35
Setting clock	35
Setting wake-up timer	35
Setting sleep timer	35

Specifications

36

Troubleshooting

37~39

Glossary

40

General Information

Congratulations on your purchase and welcome to Philips!

To fully benefit from the support that Philips offers, register your product at www.philips.com/welcome.

This product complies with the radio interference requirements of the European Community.

Features

Your DVD MICRO THEATRE System with 2.1-channel full analog amplifier creates the same dynamic sound qualities that you find in full fledged cinemas and incorporates some of the best features in home theater technology. Other features include:

Additional Component Connections

Lets you connect other audio and audio/visual components to the DVD micro system.

Parental Control (Rating Level)

Lets you set a ratings level so that your children cannot watch a DVD that has a rating higher than you set.

Sleep/Wake-up Timer

Enables the system to switch on/off automatically at a preset time.

Progressive Scan

Provides high quality flicker-free images for film based sources. When a picture refreshes, its vertical resolution can double to 525 lines.

Note:

– *To fully enjoy the progressive scan feature, you need a progressive scan TV.*

Supplied accessories

- Remote control with one CR2025 battery
- Two speakers and one subwoofer
- DIN cable
- A/V cable (yellow/red/white)
- Component cable (red/green/blue)
- FM wire antenna
- User Manual and Quick Start Guide

If any item is damaged or missing, contact your retailer or Philips.

Environmental information

All unnecessary packaging has been omitted. We have tried to make the packaging easy to separate into three materials: cardboard (box), polystyrene foam (buffer) and polyethylene (bags, protective foam sheet).

Your system consists of materials which can be recycled and reused if disassembled by a specialised company. Please observe the local regulations regarding the disposal of packaging materials, exhausted batteries and old equipment.

Disposal of your old product

Your product is designed and manufactured with high quality materials and components, which can be recycled and reused.

When this crossed-out wheeled bin symbol is attached to a product it means the product is covered by the European Directive 2002/96/EC. Please inform yourself about the local separate collection system for electrical and electronic products.

Please act according to your local rules and do not dispose of your old products with your normal household waste. The correct disposal of your old product will help prevent potential negative consequences for the environment and human health.



Safety information

- Before operating the system, check that the operating voltage indicated on the typeplate (or the voltage indication beside the voltage selector) of your system is identical with the voltage of your local power supply. If not, please consult your dealer.
- Where the MAINS plug or an appliance coupler is used as the disconnct device, the disconnect device shall remain readily operable.
- Place the system on a flat, hard and stable surface.
- The apparatus shall not be exposed to dripping or splashing.
- Install the unit near the AC outlet and where the AC power plug can be easily reached.

- Place the system in a location with adequate ventilation to prevent internal heat build-up in your system. Allow at least 10 cm (4 inches) clearance from the rear and the top of the unit and 5 cm (2 inches) from each side.
- The ventilation should not be impeded by covering the ventilation openings with items, such as newspapers, table-cloths, curtains, etc.
- Do not expose the system, batteries or discs to excessive moisture, rain, sand or heat sources caused by heating equipment or direct sunlight.
- No naked flame sources, such as lighted candles, should be placed on the apparatus.
- No objects filled with liquids, such as vases, shall be placed on the apparatus.
- If the system is brought directly from a cold to a warm location, or is placed in a very damp room, moisture may condense on the lens of the disc unit inside the system. Should this occur, the CD player would not operate normally. Leave the power on for about one hour with no disc in the system until normal playback is possible.
- The mechanical parts of the set contain self-lubricating bearings and must not be oiled or lubricated.
- Batteries (battery pack or batteries installed) shall not be exposed to excessive heat such as sunshine, fire or the like.
- **When the system is switched to Standby mode, it is still consuming some power. To disconnect the system from the power supply completely, remove the AC power plug from the wall socket.**

Maintenance

- When a disc becomes dirty, clean it with a cleaning cloth. Wipe the disc from the center out, in a straight line.
- Do not expose the player, batteries or discs to humidity, rain, sand or excessive heat (caused by heating equipment or direct sunlight). Always keep the disc tray closed to avoid dust on the lens.
- Do not use solvents such as benzene, thinner, commercially available cleaners, or anti-static spray intended for colour discs.



- The lens may cloud over when the player is suddenly moved from cold to warm surroundings, making it impossible to play a disc. Leave the player in the warm environment until the moisture evaporates.

Hearing Safety

Listen at a moderate volume.

- Using headphones at a high volume can impair your hearing. This product can produce sounds in decibel ranges that may cause hearing loss for a normal person, even for exposure less than a minute. The higher decibel ranges are offered for those that may have already experienced some hearing loss.
- Sound can be deceiving. Over time your hearing "comfort level" adapts to higher volumes of sound. So after prolonged listening, what sounds "normal" can actually be loud and harmful to your hearing. To guard against this, set your volume to a safe level before your hearing adapts and leave it there.

To establish a safe volume level:

- Set your volume control at a low setting.
- Slowly increase the sound until you can hear it comfortably and clearly, without distortion.

Listen for reasonable periods of time:

- Prolonged exposure to sound, even at normally "safe" levels, can also cause hearing loss.
- Be sure to use your equipment reasonably and take appropriate breaks.

Be sure to observe the following guidelines when using your headphones.

- Listen at reasonable volumes for reasonable periods of time.
- Be careful not to adjust the volume as your hearing adapts.
- Do not turn up the volume so high that you can't hear what's around you.
- You should use caution or temporarily discontinue use in potentially hazardous situations.
- Do not use headphones while operating a motorized vehicle, cycling, skateboarding, etc.; it may create a traffic hazard and is illegal in many areas.

Step 1: Placing speakers and subwoofer

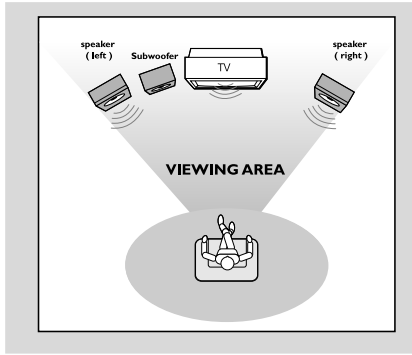

For best possible surround sound, locate your speakers and subwoofer as follows:

- Place the left and right speakers at equal distances from the TV set and at an angle of approximately 45 degrees from the listening position.
- Place the subwoofer on the floor.

Notes:

- To avoid magnetic interference, position the speakers, subwoofer as far as possible from the main unit, TV set or other radiation source.
- Allow adequate ventilation around the DVD System.

IMPORTANT!

The type plate is located on the bottom of the system.

To avoid overheating of the system, a safety circuit has been built in. Therefore, your system may switch to Standby mode automatically under extreme conditions. If this happens, let the system cool down before reusing it.

Step 2: Connecting speakers and subwoofer

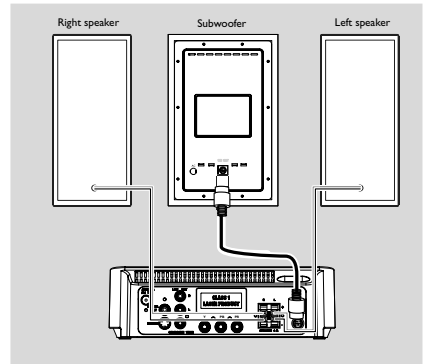

- Connect the supplied DIN cable to DVD player's DIN jack and the subwoofer's DIN jack.
- Connect the speaker wires to the **SPEAKER** terminals, right speaker to "R" and left speaker to "L", coloured (marked) wire to "+" and black (unmarked) wire to "-". Fully insert the stripped portion of the speaker wire into the terminal as shown.

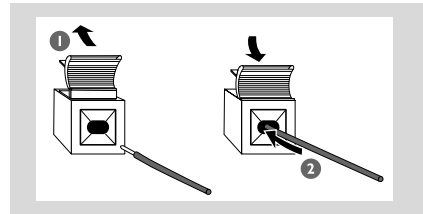

Notes:

- For optimal sound performance, use the supplied speakers.
- Do not connect more than one speaker to any one pair of +/- speaker terminals.
- Do not connect speakers with an impedance lower than the speakers supplied. Please refer to the SPECIFICATIONS section of this manual.

Step 3: Connecting TV set

IMPORTANT!

- You only need to make one video connection from the following options, according to the capabilities of your TV system.
- S-Video or Component Video connection provides higher picture quality. These options must be available on your TV set.
- Connect the system directly to the TV set.

Using Video In jack (CVBS)

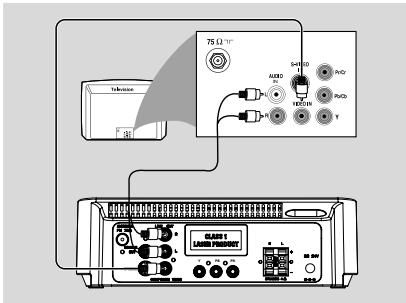

- Use the supplied composite video cable (yellow) to connect the system's **COMPOSITE VIDEO** jack to the video input jack (or labeled as A/V In, Video In, Composite or Baseband) on the TV set.
- To hear the sound of this DVD Player through your TV, use the audio cables (white/red, supplied) to connect **LINE OUT (L/R)** jacks of the DVD Player to the corresponding AUDIO IN jacks on the TV.

Using Headphone jack

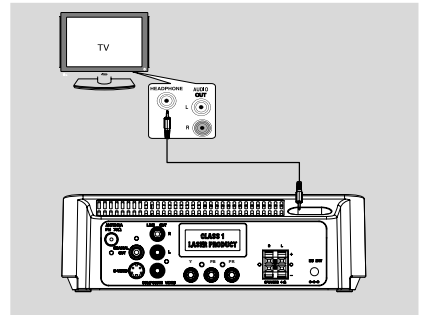

- To listen to TV through this system, use a cinch cable (not supplied) to connect **AUX IN** jack (3.5mm) to the HEADPHONE jack on the TV set (with a 3.5mm-diameter stereo jack).
Or, you may use a cinch cable (not supplied) to connect **AUX IN** jack (3.5mm) to audio out jacks on the TV set.

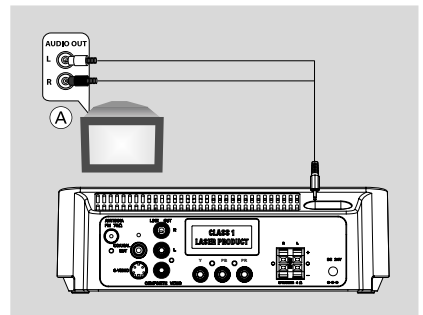

Before starting operation, press **AUX** on the remote control to select "AUX" in order to activate the input source.

Connections

Using component Video In jack (Pr Pb Y)

- Use the component video cables (red/blue/green, supplied) to connect the system's **PR/PB/Y** jacks to the corresponding Component video input jacks (or labeled as Pr/Cr Pb/Cb Y or YUV) on the TV set.
- To hear the sound of this DVD Player through your TV, use the audio cables (white/red, supplied) to connect **LINE OUT (L/R)** jacks of the DVD Player to the corresponding AUDIO IN jacks on the TV.

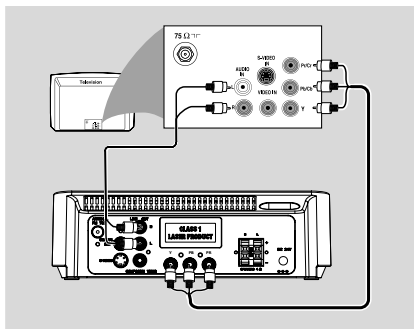

Notes for progressive scan video:

- The progressive scan video quality is only possible when using Y Pb Pr, and a progressive scan TV is required.
- If you are using a Progressive Scan TV (TV must indicate Progressive Scan or ProScan capability), to activate TV Progressive Scan, please refer to your TV user manual. For DVD system's Progressive Scan function, see "Getting Started - Setting up Progressive Scan feature".
- If your TV does not support Progressive Scan, you will not be able to view the picture. Turn off progressive scan in PROGRESSIVE menu of the system setup menu.

Using S-Video In jack

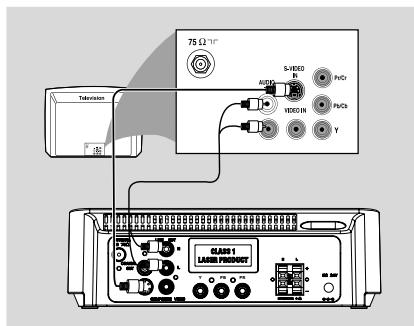

- Use the S-Video cable (not supplied) to connect the system's **S-VIDEO** jack to the S-Video input jack (or labeled as Y/C or S-VHS) on the TV set.
- To hear the sound of this DVD Player through your TV, use the audio cables (white/red, supplied) to connect **LINE OUT (L/R)** jacks of the DVD Player to the corresponding AUDIO IN jacks on the TV.

Using an accessory RF modulator

IMPORTANT!

- If your TV set only has a single Antenna In jack (or labeled as 75 ohm or RF In), you will need a RF modulator in order to view the DVD playback via TV. See your electronics retailer or contact Philips for details on RF modulator availability and operations.

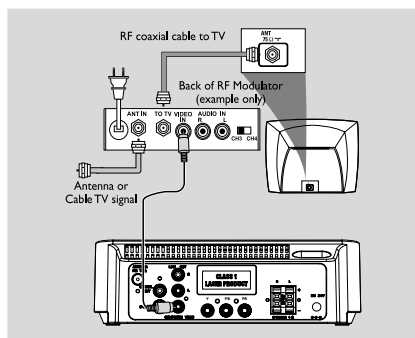

- Use the supplied composite cable (yellow) to connect the system's **COMPOSITE VIDEO** jack to the video input jack on the RF modulator.
- Use the RF coaxial cable (not supplied) to connect the RF modulator to your TV's RF jack.

Step 4: Connecting the FM antenna

- Connect the supplied FM antenna to the FM (75 Ω) jack at the back of the main unit. Extend the FM antenna and fix its end to the wall.

Step 5: Connecting the power cord

IMPORTANT!

- Never make or change any connection with the power switched on.

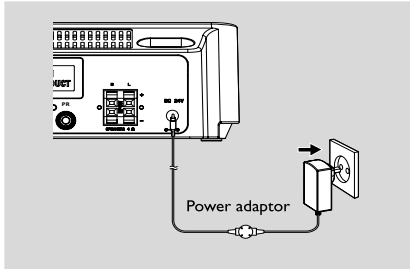

- After everything is connected properly, plug in the AC power cord to the power socket.

Step 6: Connecting a VCR or cable/satellite box

Using the VCR for recording DVDs

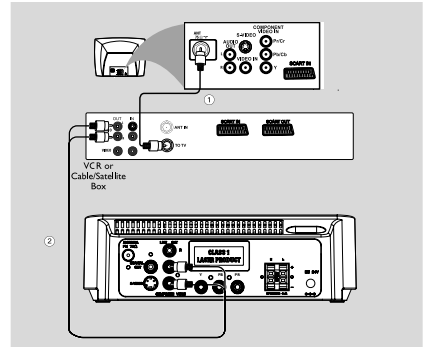

Some DVDs are copyright-protected. You cannot record or dub protected discs using VCR.

- 1 Connect the system's **COMPOSITE VIDEO** jack to the VIDEO IN jacks on the VCR.
- 2 Connect the system's LINE OUT (R/L) jacks to the AUDIO IN jacks on the VCR. This will allow you to make analog stereo (two channels, right and left).

Connections

Step 7: Connecting digital audio equipment

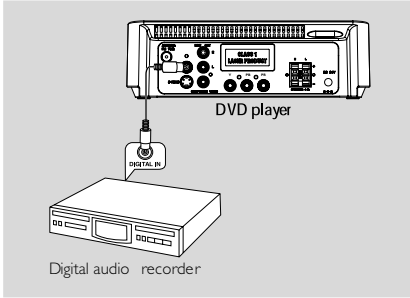

Recording (digital)

Connect the system's COAXIAL OUT (digital out) jack to the DIGITAL IN jack on a digital recording device (DTS-Digital Theater System compatible, with a Dolby Digital decoder, for example).

Before operation, set COAXIAL OUTPUT according to the audio connection.

Step 8: Connecting portable audio player

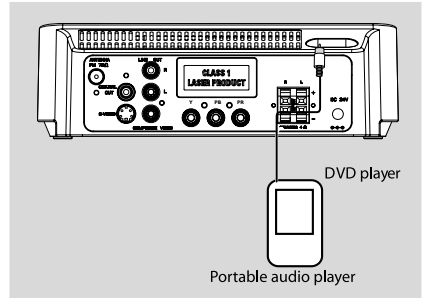

Portable audio player(MP3)

Connect the system's AUX jack (diameter 3.5mm) to the HEADPHONE jack (diameter 3.5mm) on a portable audio player.

Before starting playback, press **AUX** on the remote control to select "AUX" in order to activate the input source. The music will be heard through the speakers.

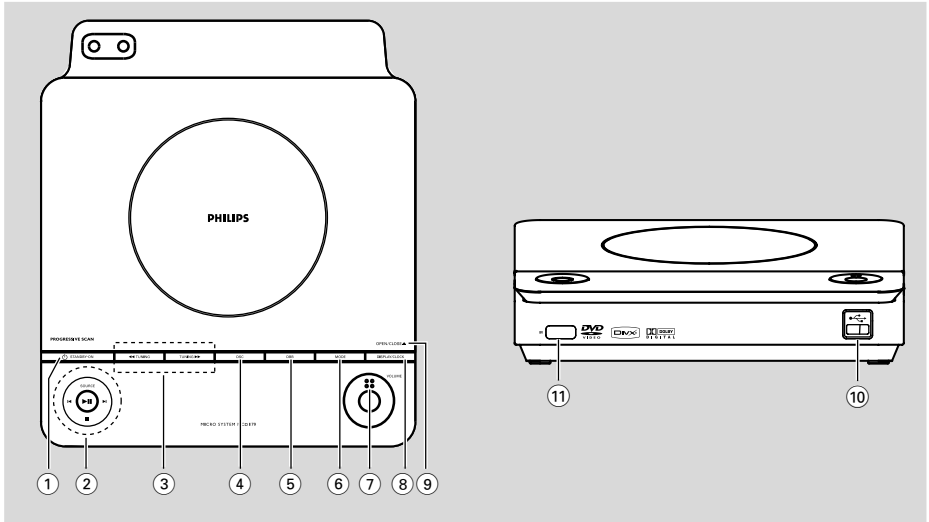

Controls on the system

① STANDBY ON (⏻)

- switches the system on or to Eco-power standby /standby mode.

② SOURCE

- selects the respective sound source: DISC/USB/ FM/AUX.
- switches on the system.
- ▶▶ starts or interrupts disc playback.
- stops disc playback or erases a programme.



Disc press to skip to the previous/ next chapter/title/track.

Tuner selects a preset radio station

clock/timer adjusts the minutes for the clock/ timer function.

③ TUNING ◀◀ / ▶▶

Tuner tunes to a radio station

Disc fast searches backward/forward in a disc at different speeds.

clock/timer adjusts the hours for the clock/ timer function.

④ DSC (Digital Sound Control)

- selects different types of preset sound equalizer settings.

⑤ DBB (Dynamic Bass Boost)

- enables or disables bass enhancement.

⑥ MODE

- selects various repeat modes or the shuffle play mode for a disc (For VCD with PBC feature, PBC must be turned off).

⑦ VOLUME

- adjusts the volume upward/downward.

⑧ DISPLAY/CLOCK

Disc displays the current status and/or disc information.

clock sets and views the clock.

⑨ OPEN/CLOSE ▲

- opens/closes the disc door.

⑩ USB port

- connects to external USB mass storage device.

⑪ IR SENSOR

- point the remote control towards this sensor.

Functional Overview

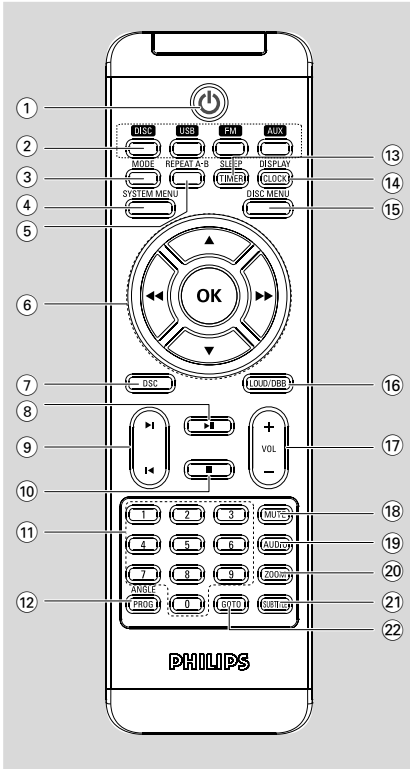

Remote control

- ① **Power**
 - switches the system on or to Eco-power standby /standby mode.
- ② **Source buttons**
 - selects the respective sound source: DISC/USB/ FM/AUX.
 - switches on the system.
- ③ **MODE**
 - selects various repeat modes or the shuffle play mode for a disc (For VCD with PBC feature, PBC must be turned off).
- ④ **SYSTEM MENU**
 - enters or exits the system menu.
- ⑤ **REPEAT A-B**
 - repeats playback of a specific section within a chapter or a track.

- ⑥ **OK**
 - confirms a selection.
 - selects an item in a menu.
 - moves an enlarged picture up/down/left/right.
- ⑦ **DISC (Digital Sound Control)**
 - selects different types of preset sound equalizer settings.
- ⑧ **Play/Pause**
 - starts or interrupts disc playback.
- ⑨ **Previous/Next**
 - Disc press to skip to the previous/ next chapter/title/track.
 - Tuner selects a preset radio station
- ⑩ **Stop**
 - stops disc playback or erases a programme.
- ⑪ **Numeric Keypad (0-9)**
 - inputs a track/title/chapter number of the disc.
- ⑫ **ANGLE/PROG**
 - Picture CD during playback, to select a slide show mode.
 - DVD selects a DVD camera angle.
 - Tuner program the favourite stations.
 - Tuner: press and hold to start automatic preset programming.
 - Disc/USB program the favourite tracks.
- ⑬ **SLEEP/TIMER**
 - activates/deactivates or selects the sleep timer.
 - activates/deactivates or sets the wake-up timer.
- ⑭ **DISPLAY/CLOCK**
 - Disc displays the current status and/or disc information.
 - clock..... sets and views the clock.
- ⑮ **DISC MENU**
 - for DVD, enters or exits disc contents menu.
 - for VCD/SVCD, toggle between PBC ON or OFF.

⑩6 LOUD/DBB

- enables or disables automatic loudness adjustment.
- enables or disables bass enhancement.

⑩7 VOL +/-

- adjusts the volume upward/downward.

⑩8 MUTE

- disables or enables sound output.

⑩9 AUDIO

for VCD

- sets stereo, mono left, mono right or mix mono sound mode.

for DVD

- selects an audio language.

⑩0 ZOOM

- zoom in or out the picture.

⑩1 SUBTITLE

- selects a subtitle language.

⑩2 GOTO

- In DISC mode, to fast search in a disc by entering a time, title, chapter or track.

Notes for remote control:

- **First select the source you wish to control by pressing one of the source select keys on the remote control (for example DISC, FM).**
- **Then select the desired function (for example ► ||, |◀, ▶|).**

Getting Started

Step 1: Using Remote Control

IMPORTANT!

- Before using the remote control, remove the insulation plastic tab as shown in the picture below.
- If the remote control does not function correctly or the operating range is reduced, replace the battery with a new (CR2025) battery.

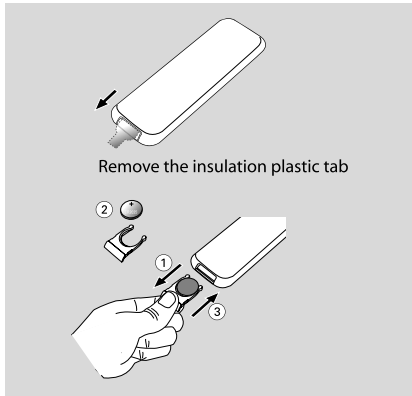

- 1 Push to open the battery tray.
- 2 Replace a new battery according to the indicated polarity.
- 3 Push the battery tray back to close it.

Using the Remote Control to operate the Player

- 1 Aim the Remote Control directly at the remote sensor (IR) on the front panel.
- 2 Select the source you wish to control by pressing one of the source select buttons on the remote.
- 3 Then select the desired function (for example, ►, II, I, ◀ or ▶).

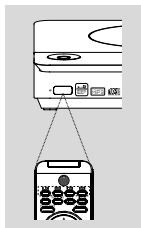

CAUTION!

- Remove the battery if it is exhausted or if the Remote Control is not being used for a long time.
- Batteries contain chemical substances, so they should be disposed of properly.

Step 2: Setting up the TV

IMPORTANT!

Make sure you have completed all the necessary connections. (See “Connecting TV”).

- 1 Switch the DVD system on and then select DISC source. (See “Switching the system on/off”).
- 2 Turn on the TV and set to the correct video-in channel. You should see the blue Philips DVD background screen on the TV.
 - Usually these channels are between the lowest and highest channels and may be called FRONT, A/V IN, or VIDEO. See your TV manual for more details.
 - Or; you may go to channel 1 on your TV, then press the Channel up button repeatedly until you see the Video In channel.
 - Or; the TV Remote Control may have a button or switch that chooses different video modes.
 - Or; set the TV to channel 3 or 4 if you are using an RF modulator.

Selecting the color system that matches your TV set

This DVD system is compatible with both NTSC and PAL. For the playback of a DVD disc on this DVD system, the color systems of the DVD, TV set and DVD System should match.

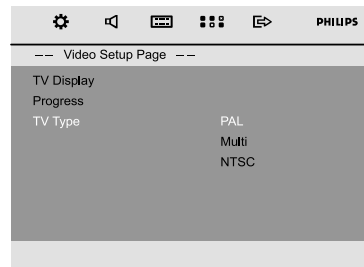

- 1 In disc mode, press **SYSTEM MENU**.
- 2 Press ◀ / ▶ / ▼ / ▲ keys on the remote control to navigate in the menu.
 - Move to "Video Setup Page" and press ▼.
 - Move to "TV TYPE" and press ▶.

PAL

– Select this if the connected TV set is PAL system. It will change the video signal of an NTSC disc and output to PAL format.

NTSC

– Select this if the connected TV set is NTSC system. It will change the video signal of a PAL video disc and output to NTSC system.

MULTI

– Select this if the connected TV set is compatible with both NTSC and PAL (multi system). The output format will be consistent with the video signal of the disc.

- 3 Select an item and press **OK**.
 - The screen messages for further setting confirmation may appear. Follow the on-screen instructions to proceed to confirm the setting or not.

To remove the menu

Press **SYSTEM MENU**.

Setting up Progressive Scan feature (for Progressive Scan TV only)

The progressive scan display twice the number of frames per seconds than interlaced scanning (ordinary normal TV system). With nearly double the number of lines, progressive scan offers higher picture resolution and quality.

IMPORTANT!

Before enabling the progressive scan feature, you must ensure:

- 1) Your TV can accept progressive signals, a progressive scan TV is required.
- 2) You have connected the DVD player to your TV using Y Pb Pr (see "Connecting TV set")
- 3) Make sure Component has been set to YUV.

- 1 Turn on your TV.
- 2 Turn off your TV progressive scan mode or turn on interlaced mode (refer to your TV user manual).
- 3 Press **STANDBY-ON**  to turn on the DVD player.
- 4 Select the correct Video Input channel.
- 5 In disc mode, press **SYSTEM MENU**.
- 6 Press ◀ / ▶ / ▼ / ▲ keys on the remote control to navigate in the menu.
 - Move to "Video Setup Page" and press ▼.
 - Move to "Progressive">"On" and press **OK**.

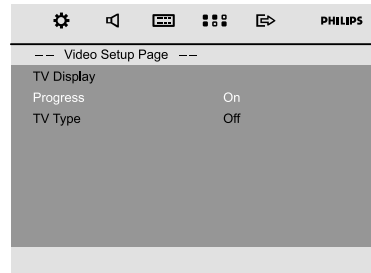

There will be a distorted picture on your TV at this state until you turn on the progressive scan mode on your TV.

- 7 Turn on your TV progressive scan mode (refer to your TV user manual).
- 8 In the confirmation menu, press ◀ / ▶ to highlight OK in the menu and press **OK** on the remote to confirm.
 - Progressive scan is now set on.
 - If distorted picture still appears, it indicates that your TV doesn't support progressive scan. In this case, turn off progressive scan as described in "To deactivate Progressive manually".
- 9 Press **SYSTEM MENU** on the remote to exit the system menu.
 - The setup is complete now and you can start enjoying the high quality picture.

Getting Started

To deactivate Progressive manually

- **When the distorted sign still appears on the TV**, it may be because the connected TV does not accept progressive signals, and progressive is set by mistake. You must reset the unit to interlace format.
- 1 Turn off your TV progressive scan mode or turn on to interlaced mode (refer to your TV user manual).
- 2 Turn off progressive scan by selecting "OFF" under PROGRESSIVE menu, then pressing **OK** on the remote control.
→ Progressive scan is turned off.

Step 3: Setting language preference

You can select your own preferred language settings. This DVD system will automatically switch to the selected language whenever you load a disc. If the language selected is not available on the disc, the disc's default language will be used instead. The OSD language in the system menu will remain once selected.

Setting the OSD Language

- 1 In disc mode, press **SYSTEM MENU**
- 2 Press **◀ / ▶ / ▼ / ▲** keys on the remote control to navigate in the menu.
→ Move to "General Setup Page" and press **▼**.
→ Move to "OSD Lang" and press **▶**.
- 3 Press **▼ / ▲** to select a language and press **OK**.

To remove the menu

Press **SYSTEM MENU**.

Setting the Audio, Subtitle and Disc Menu language

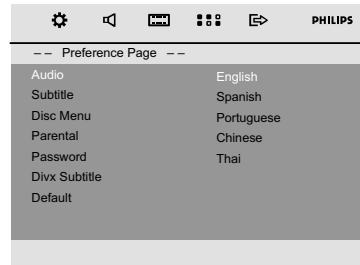

- 1 In disc mode, press **SYSTEM MENU**
- 2 Press **◀ / ▶ / ▼ / ▲** keys on the remote control to navigate in the menu.
→ Move to "Preference Page" and press **▼**.
→ Move to one of the following and press **▶**.
 - "Audio" (disc's soundtrack)
 - "Subtitle" (disc's subtitles)
 - "Disc Menu" (disc's menu)
- 3 Press **▼ / ▲** to select a language and press **OK**.

To remove the menu

Press **SYSTEM MENU**.

IMPORTANT!

- Before you operate the system, complete the connection procedures.
- When the system is switched to Standby mode, it is still consuming power. To disconnect the system from the power supply completely, remove the AC power plug from the wall socket.

Plug and Play (for tuner installation)

Plug and Play allows you to store all available radio stations automatically.

First time setup/power up

- 1 When you turn on the main supply, "AUTO INSTALL - PRESS PLAY" is displayed.
- 2 Press ► **II** on the system to start installation.
 - "PLUS AND PLAY" ... "INSTALL" is displayed, followed by "TUNER" and "AUTO".
 - **PROG** starts flashing.
 - The system will automatically store the radio stations (FM only) with sufficient signal strength.
 - When all the available radio stations are stored or the memory for 20 presets are used, the last preset radio station will be played.

To reinstall Plug and Play

- 1 In standby mode, press and hold ► **II** on the system until "AUTO INSTALL - PRESS PLAY" is displayed.
- 2 Press ► **II** again to start installation.
 - All previously stored radio stations will be replaced.

To exit without storing the Plug and Play

- Press **■** on the system.
 - If you do not complete the Plug and Play installation, the function will be restarted when you next turn on the main supply again.



Notes:

- If no stereo frequency is detected during Plug and Play, "CHECK ANTENNA" will be displayed.



Switching the system on/off

- In standby/Eco-power standby mode, press **STANDBY-ON**  or **SOURCE** on the set, or **DISC, USB, FM** or **AUX** on the remote to switch on the system.
 - The system will switch to the selected or last selected source.

To switch the system to standby mode

- In power-on mode, press briefly **STANDBY-ON**  ( on the remote).
 - The clock time will be displayed. Or "----:--" will be displayed if clock time is not set.

To switch the system to Eco-power standby mode

- In power-on mode, press and hold **STANDBY-ON**  ( on the remote).
 - "ECO POWER" is displayed briefly.
 - Eco-power lamp  on the front panel will light up.
 - The LCD display will go blank.

Helpful hints:

- Pressing and holding  on the remote can switch between Eco-power standby and normal standby.

Power saving automatic standby

As a power-saving feature, the system will automatically switch to Standby mode if you don't press any button within 15 minutes in the stop mode.

Basic Operations

VOLUME CONTROL

Press **VOLUME** (or **VOL +/-** on the remote) to increase or decrease the volume level.

→ The display briefly shows "VOL" and a volume value from "0" to "31" ("MIN" or "MAX" is displayed when adjusted to the lowest or highest volume level).

To switch off the volume temporarily

- Press **MUTE** on the remote.
→ Playback will continue without sound and "MUTE" appears.
- To activate sound reproduction, you can:
 - press **MUTE** again;
 - adjust the volume controls;
 - change source.

SOUND CONTROL

DBB (Dynamic Bass Boost)

DBB enhances the bass response.

- Press briefly **LOUD/DBB** to enable or disable DBB feature.
→ If DBB is activated, "DBB" will be shown.

Helpful hints:

– Some discs might be recorded in high modulation, which causes a distortion at high volume. If this occurs, switch off DBB or reduce the volume.

DSC (Digital Sound Control)

DSC provides a different type of preset sound equalizer setting.

- Press **DSC** on the remote (or on the system) repeatedly to select:
POP(default), CLASSIC, ROCK, JAZZ.

LOUDNESS

LOUDNESS feature enables the system to automatically increase the treble and bass sound effect at low volume (the higher the volume, the lower the treble and bass increase).

- Press and hold **LOUD/DBB** on the remote control to enable/disable LOUDNESS feature.
→  icon appears/disappears after this feature is enabled/disabled.

IMPORTANT!

- Depending on the DVD or VIDEO CD, some operations may be different or restricted.
- Do not push on the disc tray or put any objects other than disc on the disc tray. Doing so may cause the disc player malfunction.
- If the inhibit icon appears on the TV screen when a button is pressed, it means the function is not available on the current disc or at the current time.

Playable Discs

Your DVD Player will play:

- Digital Versatile Discs (DVDs)
- Video CDs (VCDs)
- Super-Video CDs (SVCDs)
- Finalised DVD recordable (DVD±R)
- Digital Versatile Discs + Recordable (DVD+R)
- Digital Versatile Discs + Rewritable (DVD+RW)
- Audio Compact Discs (CDs)
- MP3/WMA discs, picture (Kodak, JPEG) files on CD-R (W)
- ISO 9660/UDF format
- JPEG resolution support up to 3073x2048
- Supported sampling frequencies: 32kHz, 44.1kHz, 48kHz.
- Supported Bit-rates: 32~256 (kbps), variable bit rates (average 128kbps)
- DivX files on CD-R(W)/DVD+R(W):
 - DivX 3/4/5

Region Codes

DVD discs and players are designed with regional restrictions. Before playing a disc, make sure the disc is for the same region as your player. The regional code for this unit is indicated at the bottom panel.



Note:

- If you are having trouble playing a certain disc, remove the disc and try a different one. Improperly formatted disc will not play on this DVD Player.



Playing discs

- 1 For DVDs and VCDs, make sure that the system is properly connected to your TV (See Connecting a TV), and your TV is turned on and set to video-in channel (See Setting up the TV).
- 2 Press **SOURCE** on the system once or more to select DVD mode (or **DISC** on the remote control).
→ You should see the blue Philips DVD background screen on the TV.
- 3 Push **OPEN/CLOSE** on the top of the system to open the disc tray.
- 4 Insert a disc with the print side facing up and close the disc tray.
- 5 Playback will start automatically (depending on the disc type).
→ If a disc menu appears on the TV, see "Using the Disc Menu".
→ If the disc is locked by parental control, you must enter your six-digit password. (See "Changing the password").

To interrupt playback

- Press **▶ II**.
→ "II" is displayed on the TV screen.
- To resume playback, press **▶ II** again.

To stop playback

- Press **■**.

Using the Disc Menu

- 1 Press **DISC MENU** on the remote control.
→ If the current title has a menu, the menu will appear on the screen. Otherwise, the disc menu will be displayed.
- 2 Press **◀◀ / ▶▶ / ▼ / ▲** to select the desired title or chapter; and then press **▶ II** or **OK**.
→ Playback starts from the selected title or chapter.
- 3 Press **DISC MENU** on the remote control to go to disc menu of the disc.

Note:

– If no title menu or root menu is recorded in the DVD disc, pressing this button will restart playback from the first track.

Playback control (PBC)

PBC playback allows you to play Video CD interactively, following the menu on the display.

- Press **DISC MENU** to toggle between PBC ON and PBC OFF.

Playing a disc with PBC function

- If PBC OFF, the system will start playback automatically.
- If PBC ON, the PBC menu (if available) will appear on the TV screen for selection. Use the **numeric keys (0-9)** to enter your choice.

Note:

– This function is not available for DVD/CD/MP3/DivX disc.

Resuming playback

- During playback, press **■** once to stop the playback in resume mode, then press **▶ II** to start playback from where you have stopped.

To cancel the resume mode

- In the stop position, press **■** again to fully stop the playback. Or open the disc door, or switch the system to standby mode.

Selecting and searching

Selecting a different track/chapter

For DVD/VCD/CD/MP3:

- During playback, briefly press **◀ / ▶** to select the previous or next track/chapter.

Or,

use the **Numeric Keypad (0-9)** on the remote control to directly input your track number:

→ After selecting, playback will automatically start from the beginning of the selected track.

Helpful hints:

– Some VCDs have a single track, so track selecting or an invalid input value for the current disc will be ignored.

– If the player has been set to repeat chapter (track), pressing this button will replay the same chapter (track) from its beginning.

Fast forwarding/reversing

For DVD/VCD/DivX/WMA/MP3:

- 1 During playback, press ◀◀ / ▶▶ repeatedly to select fast search speed in forward or reverse playback.
- 2 To resume to normal playback, press ▶ II.
Or; press ◀◀ / ▶▶ repeatedly until “▶” is displayed on the TV screen.

Helpful hints:

– Fast searching forward/backward is available only within the same track.

Slow forwarding/reversing

For DVD/VCD:

- 1 During playback, press ▲ / ▼ repeatedly to select slow search speed in forward or reverse playback.
- 2 To resume to normal playback, press ▶ II.
Or; press ▲ / ▼ repeatedly until “▶” is displayed on the TV screen.

Helpful hints:

– For VCD, slow reverse is unavailable.

Different play modes: REPEAT, SHUFFLE and REPEAT A-B

REPEAT

For DVDs/VCD/CD/MP3

- During playback, press repeatedly **MODE** on the system to choose desired repeat play modes.
→ For VCD with PBC feature, PBC must be turned off first.

For DVDs

CHAPTER REPEAT: Repeats the current chapter

TITLE REPEAT: Repeats the current title

REPEAT ALL: Plays all the content repeatedly

SHUFFLE: Random play

REPEAT OFF: Switches off play mode

For VCDs/SVCDs/CDs

REPEAT TRACK: Repeats the current track

REPEAT ALL: Plays all the tracks repeatedly

SHUFFLE: Random play

REPEAT OFF: Switches off play mode

For MP3/WMA/JPEG/DivX

REPEAT ONE: Repeats the current track

REPEAT ALL: Plays all the tracks repeatedly

SHUFFLE: Random play

REPEAT OFF: Switches off play mode

- To return to normal playback, press **MODE** repeatedly until various play modes are no longer displayed.

In shuffle playback mode:

- Press ▶ button to select another track in a shuffle order.
- Press ■ to stop shuffle playback.

To cancel Shuffle mode:

- Press **MODE** repeatedly to select repeat off to cancel Shuffle mode.

Notes:

– In Tuner or AUX mode, this button does not function.

– When the disc tray is opened, Shuffle/Repeat function will be cancelled automatically.

Repeat A-B

You can play a specific section in a chapter/track repeatedly.

- 1 Press **REPEAT A-B** at your chosen start point.
- 2 Press **REPEAT A-B** again at your chosen end point.
→ The passage will now repeat continuously.
- 3 To resume normal play, press **REPEAT A-B** again.

Note:

– The A-B function can only be set within the same chapter or track.

Disc Operations

Programming favourite chapters/tracks

You can play the contents of the disc in the order you want.

For DVD/VCD/SVCD/CD/CDG

- 1 Press **PROG** on the remote control.
→ The programming menu appears.

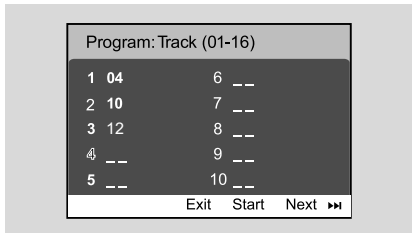

- 2 Use the **numeric keys (0-9)** to input the track /chapter number in the order you want. (two digits must be entered, e.g., **06**).
→ If there are more than ten tracks to be programmed in total, select **{NEXT}** on the screen and press **OK** (or press **▶** on the remote control) to access the next programming page.
→ To remove the track/chapter from the programming menu, select the track/chapter and press **OK**.
- 3 Select **{Start}** to play the program.
- 4 To stop playback, press **■** once.
- 5 To exit the program mode, press **■** twice.

For MP3/WMA/JPEG

- 1 Press **▼ / ▲** to select a track/picture on the disc menu. Then press **PROG** to add the track/picture to playlist.
→ "AddTo Playlist" will show on the disc menu.
- 2 Press **DISC MENU** three times.
→ playlist menu will appear.
- 3 Press **▼ / ▲** to select a track/picture on the disc menu. Then press **PROG** to add the track/picture to playlist.
- 4 Press **▼ / ▲** to select a track/picture and press **OK** to start playback.
→ You can select a track/picture and press

PROG to remove it from programme playlist.

- 5 Press **STOP** to stop program playback .
- 6 Press **DISC MENU** return to disc menu.

Notes:

- At most **20** tracks can be stored for DVD/VCD/ SVCD/CD/CDG.
- At most **100** tracks can be stored for MP3/ WMA/JPEG.

Display information

In disc mode, press **DISPLAY/CLOCK** repeatedly to select the following display information.

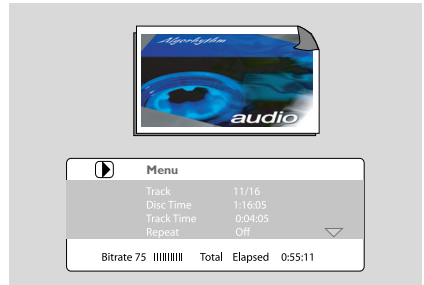

Moving to another title/chapter

Some discs may contain more than one title or chapter. If the disc has a title or chapter menu recorded on it, you can start playback from the selected item.

- 1 Press **DISPLAY/CLOCK** to display the message of title and chapter:
- 2 Use **▼ / ▲** to highlight an item and press **OK**.
- 3 Use **numeric keys (0-9)** to select a desired title/chapter number.
- 4 Press **DISPLAY/CLOCK** to exit the disc information menu.

Note:

- *Selecting a title or chapter might not be possible on certain discs.*

Viewing from another angle

If the playing DVD disc is recorded with multiple camera angles, this function allows you to view the picture from different angles. Angle selection is determined by the disc format.

- 1 Press **DISPLAY/CLOCK** on the remote control to display the message of title and chapter.
- 2 Use **▼ / ▲** to highlight "Angle" and press **OK**.
- 3 Use **numeric keys (0-9)** to select desired angle.
- Or, you may directly press **ANGLE** to change the views from different angles.

ZOOM

Zooming allows you to enlarge the video/ JPEG image during playback.

For DVDs/VCDs

- Press **ZOOM** repeatedly to change the zooming scale.
2X -->3X -->4X -->1/2X-->1/3X--> 1/4X
- For **JPEG**
- Press **ZOOM** repeatedly to change the zooming scale.
100% -->125%-->150%-->200%-->75%-->50%
- To pan through the enlarged image, press **◀◀ / ▶▶ / ▲ / ▼** buttons.
- Press **ZOOM** repeatedly to exit ZOOM mode.

AUDIO

For DVDs

- On the remote control, press **AUDIO** repeatedly to select the desired language for sound track.
→ The feature is disc dependant.

For VCDs

- Press **AUDIO** repeatedly to select the audio channel for sound output displayed on the TV screen.

STEREO, MONO LEFT, MONO RIGHT
or **MIX MONO**.

SUBTITLE

- Press repeatedly **SUBTITLE** on the remote control to select different subtitle languages.
→ The feature is disc dependant.

Playing MP3/Picture disc (Kodak, JPEG)

IMPORTANT!

– **You have to turn on your TV set and set to the correct Video In channel.**

MP3/JPEG Picture disc

- 1 Load an MP3/Picture (JPEG) disc.
→ The disc reading time may exceed 30 seconds due to complexity of the directory/file configuration.
→ The disc menu appears on the TV
- 2 Select a track in the menu and press **OK** to start playback.
- For MP3/WMA, playback will start automatically.

(MP3 disc menu)

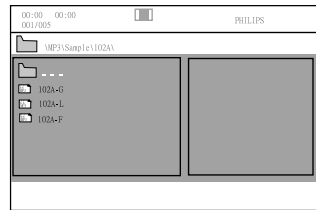

- 3 During music playback, press **▲ / ▼** or use the **numeric keys (0-9)** to select a desired picture file from the disc menu and press **OK**.
→ If the disc main menu contains various folders, use **▲ / ▼** to select a desired folder, and press **OK** to open the folder.
- 4 Press **◀ / ▶** to select previous/next track.
- 5 To stop simultaneous playback, press **DISC MENU** followed by **STOP**.

Disc Operations

If the MP3 menu is switched off

- While in playback mode, press ◀ or ▶ to select the previous/next track.

Note:

– No album search function in menu off mode.

- During JPEG or Kodak Picture disc playback, press **PROG** repeatedly to select different scan effect. There are 16 types of scan effect for selection. The selected scan effect will be displayed on the TV screen.

Playing MP3 music and JPEG pictures simultaneously

You can create a musical slide show if the disc contains both the MP3 music and JPEG picture files.

- Insert a MP3/WMA disc that contains music and pictures.
- Select a track in the menu and press **OK** to start playback.
- During music playback, press ▼ / ▲ keys to select a desired picture file from the disc menu and press **OK**.
 - The picture files will be played back through to the end of the folder.
 - The music keeps playing back and will be repeated when reaching the end of the selected album, playlist or track.
- To stop simultaneous playback, press **DISC MENU** followed by **STOP**.

Kodak Picture disc

- Load a Kodak Picture disc.
 - The disc reading time may exceed 30 seconds due to complexity of the directory/file configuration.
- During playback, press ■.
 - 12 thumbnail pictures will appear on the TV screen.

(example for picture disc menu)



- Press ◀ / ▶ to view the previous/next page (if available).
- Press ◀◀ / ▶▶ / ▼ / ▲ to move within the menu and press **OK** to select the desired picture to play.
- Press **PROG** to select the slide-show mode.

During playback, you can:

- Press ◀ or ▶ to select another title/picture in the current folder.
- Press ◀◀ / ▶▶ / ▲ / ▼ on the remote control to rotate or flip the picture files.
- Press **ZOOM** repeatedly to zoom the picture in and out.
- Press ▶▶ to pause/resume playback.

Notes:

- Due to the recording nature of Digital Audio MP3 (DAM), only digital audio music will play.
- It is normal to experience an occasional “skip” while you are listening to your MP3 discs.
- For multi-session discs with different formats, only the first session can be read and played.

Playing a Divx disc

The unit supports the playback of Divx movies which you can copy from your computer onto a recordable disc. See {DVD Menu Operations} - Divx(R)VOD Code for details.

- ① Insert a Divx disc.
- ② Use ◀◀ / ▶▶ / ▼ / ▲ keys to navigate to the title you want to play.
- ③ Press **OK** to start playback.

During playback:

- If the Divx disc has multilingual subtitles, you can press **SUBTITLE** on the remote control to change the subtitle language.
- If the Divx disc has different audio tracks, you can press **AUDIO** on the remote control to change the audio stream.
- Press ◀◀ / ▶▶ keys on the remote control to perform fast reverse and forward.
- Press **DISPLAY/CLOCK** repeatedly until the time search menu appears, key in the time where playback should start.
→ Playback skips to the time entered.

Helpful Hints:

- Subtitle files with the following file name extensions (.srt, .smi, .sub, .ssa, .ass) are supported but do not appear on the file navigation menu.
- The subtitle file name has to be the same as the file name of the movie.
- The subtitle can only be displayed up to an average of 45 characters.

System Menu Options

Basic operations

- 1 Press **SYSTEM MENU** to enter the Setup Menu.
- 2 Press **◀▶** to select a page to be set.
- 3 Press **▲▼** to highlight an option.
- 4 Enter its submenu by pressing **▶▶** or **OK**.
- 5 Move the cursor by pressing **▲▼** to highlight the selected item.
→ In cases of value setting, press **▲▼** to adjust values.
- 6 Press **OK** to confirm.

To return to the upper-level menu

- Press **◀◀**.

To exit from the menu

- Press **SYSTEM MENU** again.
→ The settings will be stored in the player's memory even if the player is switched off.

Note:

– *Some of the features in the System Menu Options are described in "Getting Started".*

General Setup Page

The options included in General Setup Page are: "OSD Lang", "Screen Saver" and "Divx VOD".

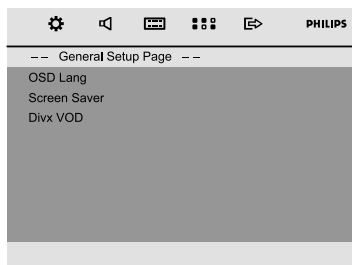

OSD Lang

See "Getting Started-Step 3: Setting language preference" for details.

Screen Saver

This function is used to turn the screen saver on or off.

DIVX VOD

Philips provides you with the Divx(R)VOD registration code that allows you to rent or purchase videos from Divx(R) VODE service at www.divx.com/vod. All the downloaded videos from Divx(R)VOD can only be displayed back on this unit.

Press **▶▶** or **OK** to enter its submenu, then press **OK** again to see the registration code.

Audio Setup Page

The options included in Audio Setup Page are: "Night Mode", "Digital Output" and "Dolby Digital Setup".

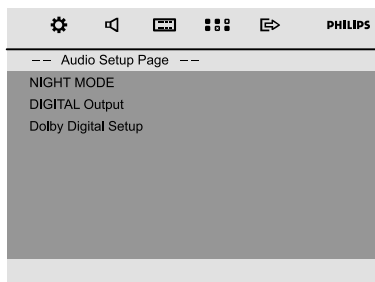

Night Mode

- **On:** Select this to level out the volume. High volume outputs will be softened and low volume outputs are brought upward to an audible level.
- **Off:** Select this when you want to enjoy the surround sound with its full dynamic range.

This feature is only available for movies with Dolby Digital mode.

Digital Output

- **Digital Off:** Turns off the digital output.
- **Digital / Raw:** If you have connected your DIGITAL OUT (COAXIAL or OPTICAL) to a multi-channel decoder/receiver.
- **SPDIF / PCM:** Only if your receiver is not capable of decoding multi-channel audio.

Dolby Digital Setup

The options included in the Dolby Digital Setup page is: "Dynamic".

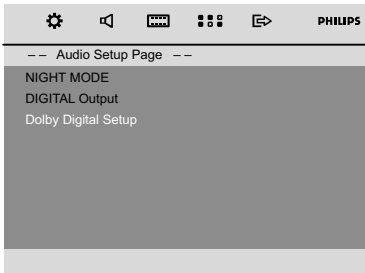

Dynamic

Optimises the dynamic sound output. High volume outputs are softened, enabling you to watch your favourite movie without disturbing others.

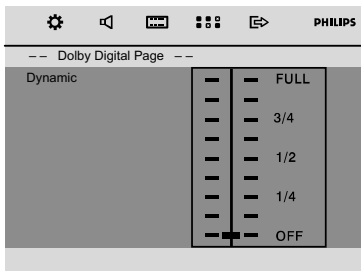

→ The levels for dynamic selection: FULL, 3/4, 1/2, 1/4 and OFF.

Note:

– DTS surround audio output is not available in this DVD player.

Video Setup Page

The options included in Video Setup Page are: "TV Display", "Progress" and "TV Type".

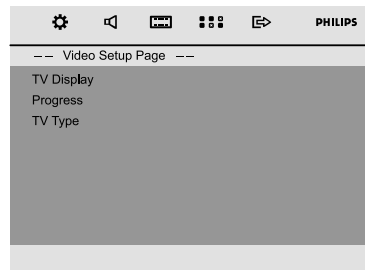

TV Display

Set the aspect ratio of the DVD Player according to the TV you have connected.

→ **4:3** (panscan): If you have a normal TV and want both sides of the picture to be trimmed or formatted to fit your TV screen.

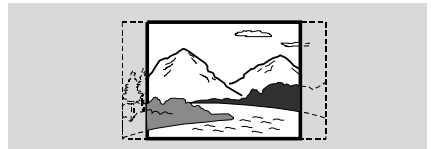

→ **4:3** (letterbox): If you have a normal TV. In this case, a wide picture with black bands on the upper and lower portions of the TV screen will be displayed.

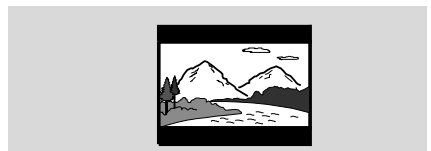

→ **16:9**: If you have a wide-screen TV.

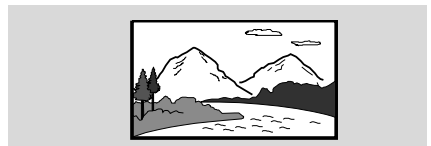

System Menu Options

Progress

See "Getting Started-Step 2: Setting up the TV" for details.

TV Type

See "Getting Started-Step 2: Setting up the TV" for details.

Preference Page

The options included in Preference Page are: "Audio", "Subtitle", "Disc Menu", "Parental", "Password", "Divx Subtitle" and "Default".

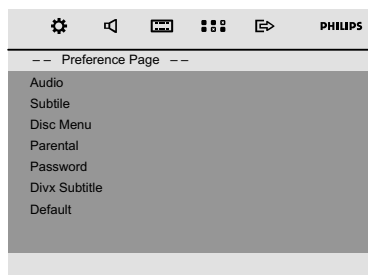

Audio

See "Getting Started-Step 3: Setting language preference" for details.

Subtitle

See "Getting Started-Step 3: Setting language preference" for details.

Disc Menu

See "Getting Started-Step 3: Setting language preference" for details.

Parental

Some DVDs may have a parental level assigned to the complete disc or to certain scenes on the disc. This feature lets you set a playback limitation level.

The rating levels are from 1 to 8 and are country dependent. You can prohibit the playing of certain discs that are not suitable for your children or have certain discs played with alternative scenes.

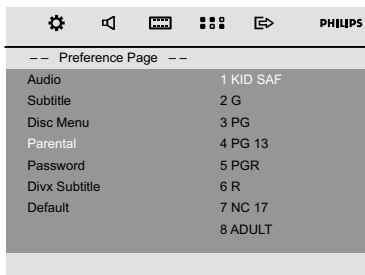

- VCD, SVCD and CD have no level indication, so parental control function has no effect on those kinds of discs. This applies to most illegal DVD discs.

- 1 Press ▲/▼ to highlight "Parental".
- 2 Enter its submenu by pressing ►►.
- 3 Use ▲/▼ to highlight a rating level for the disc inserted.

→ DVDs that are rated above the level you selected will not play unless you enter your four-digit password and choose a higher level rating.

Note:

– Some DVDs are not encoded with a rating though the movie rating may be printed on the Disc cover. The rating level feature does not work for such Discs.

Rating explanations

1 KID SAFE

– Suitable for children.

2 G

– General Audience; recommended as acceptable for viewers of all ages.

3 PG

– Parental Guidance suggested.

4 PG 13

- Material is unsuitable for children under age 13. Parental Guidance suggested.

5-6 PG-R, R

- Parental Guidance – Restricted; recommended that parents restrict children under 17 from viewing or allow them to view only when supervised by a parent or adult guardian.

7 NC-17

- No children under age 17; not recommended for children under age 17.

8 ADULT

- Material for adults only; viewed only by adults due to graphic sexual scenes, violence, or language.

Password

You can enter your four-digit password to activate or deactivate rating control.

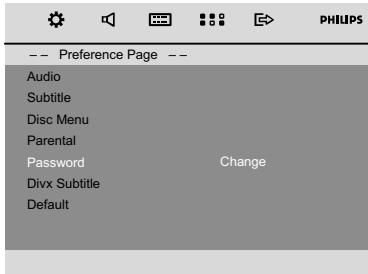

To change password

- 1 Move to "Password" and press **▶▶** or **OK** to enter its submenu.
- 2 Press **OK** to enter the menu below.



- 3 Use the **Numeric Keypad (0-9)** to enter your four-digit code.
→ The password supplied by default is 1234.

- 4 Enter your new four-digit password using **Numeric Keypad (0-9)**.
- 5 Enter the new password again for confirmation.
- 6 Press **OK** to confirm and the new password takes effect.

Note:

- *The default password (1234) is always active even if the password has been changed.*

Divx Subtitle

Select the font type that supports the recorded Divx subtitle.

- **Standard:** Display a standard list of Roman subtitle fonts provided by this unit.
- **Central Europe:** Display Central Europe fonts.
- **Cyrillic:** Display Cyrillic font.

Default

Setting the "Default" function will reset all options and your personal settings to the factory defaults and all your personal settings will be erased.

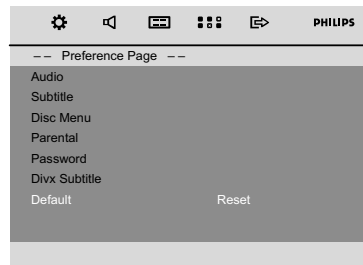

- 1 Press **▲/▼** to highlight "Default".
- 2 Highlight "Reset" by pressing **▶▶**.
- 3 Press **OK** to confirm selection.

Caution!

- **When this function is activated, all settings will be reset to factory defaults.**

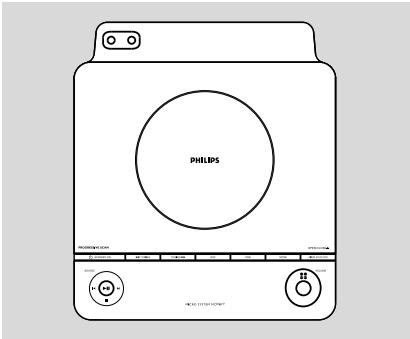

Tuning to radio stations

- 1 Press **SOURCE** on the set (or **FM** on the remote control) repeatedly until FM is displayed.
- 2 Press down on **TUNING ◀◀ / ▶▶** (or ◀◀ / ▶▶ on the remote control) and release the button.
→ The radio automatically tunes to a station with sufficient reception. Display indication during automatic tuning: SEARCH.
- 3 Repeat step 2 if necessary until you find the desired station.
- To tune to a weak station, press **TUNING ◀◀ / ▶▶** (or ◀◀ / ▶▶ on the remote control) briefly and repeatedly until you have found optimal reception.

Programming radio stations

You can store up to a total of 20 FM radio stations in the memory.

Automatic programming

Autostore automatically starts programming radio stations from preset 1. Any previous presets e.g. manually programmed will be erased.

- In tuner mode, press and hold **PROG** until "AUTO" appears on the display panel.
→ All previously stored radio stations will be replaced.

Manual programming

- 1 Tune to your desired station (see Tuning to radio stations).
- 2 Press **PROG** on the remote control to activate programming.
→ **PROG** flashes in the display.
- 3 Press **◀ / ▶** to allocate a number from 1 to 20 to this station.
- 4 Press **PROG** on the remote control again to confirm the setting.
→ **PROG** disappears. The preset number and the frequency of the preset station are shown.
- 5 Repeat the above four steps to store other stations.
- You can override a preset station by storing another frequency in its place.

Tuning to preset radio stations

- Press **◀ / ▶** until the desired preset station is displayed.

Using USB connectivity

- MCD179 is fitted with a USB port in the front panel, offering a plug and play feature which allows you to play, from your MCD179, digital music and spoken contents stored on a USB mass storage device.
- Using a USB mass storage device, you can also enjoy all the features offered by MCD179 which are explained and instructed in the sections of disc operation.

Compatible USB mass storage devices

With the MCD179, you can use

- USB flash memory (USB 2.0 or USB 1.1)
- USB flash player (USB 2.0 or USB 1.1)
- USB device which requires driver installation under Windows XP is not supported.

Note:

- *In some USB flash players (or memory devices), the stored contents are recorded using copyright protection technology. Such protected contents will be unplayable on any other devices (such as MCD179 device).*

Supported formats:

- USB or memory file format FAT12, FAT16, FAT32 (sector size: 512 - 4096 bytes)
- MP3 bit rate (data rate): 32-320 kbps and variable bit rate
- WMA v9 or earlier
- Directory nesting up to a maximum of 8 levels
- Number of albums: maximum 99
- Number of tracks: maximum 800
- ID3 tag v2.0 or later
- File name in Unicode UTF8 (maximum length: 128 bytes)

The system will not play or support the following:

- Empty albums: an empty album is an album that does not contain MP3/WMA files, and will not be shown in the display.
- Non-supported file formats are skipped. This means that e.g.: Word documents .doc or MP3 files with extension. dlf are ignored and will not be played.
- AAC, WAV, PCM, NTFS audio files
- DRM protected WMA files
- WMA files in Lossless format

Playing a USB mass storage device

- 1 Make sure that your MCD177 is being powered on.
- 2 Plug a compatible USB mass storage device to MCD179's USB port marked . If needed, use a suitable USB cable to connect between the device and MCD179's USB port.
 - The device will automatically power on.
- If the device is not powered on, turn on the power manually, then re-connect it.
- 3 Press **SOURCE** repeatedly (or **USB** on the remote) to enter USB mode.
 - **NO AUDIO** appears if no audio file is found in the USB device.
- 4 Press **▶||** on your MCD179 to start play.
- To use other playback features, see the section of CD/MP3 Operation.

Helpful hints:

- *Make sure that file names of MP3 files end with .mp3. and the file names of WMA files end with .wma.*
- *For DRM protected WMA files, use Windows Media Player 10 (or later) for conversion. Visit www.microsoft.com for details about Windows Media Player and WM DRM (Windows Media Digital Rights Management).*
- *For USB device playing, if the display shows "OL", it means that the USB device is electrically overloading MCD179. You need to change a USB device.*

INFORMATION REGARDING USB DIRECT:

1. *Compatibility of the USB connection on this micro system:*
 - a) *This micro system supports most USB Mass storage devices (MSD) that these devices are compliant to the USB MSD standards.*
 - i) *Most common Mass storage class devices are flash drives, memory sticks, jump drives and etc.*
 - ii) *If you see a "Disc Drive" showing up on your computer after you have plugged the mass storage device into your computer, most likely it is MSD compliant and it will work with this micro system.*
 - b) *If your Mass storage device requires a battery/power source, please make sure you have a fresh battery in it or charge the USB device first and then plug it into the micro system again.*
2. *Supported Music type:*
 - a) *This device only supports unprotected music with file extension: .mp3 .wma*
 - b) *Music bought from on-line music stores are not supported because they are secured by Digital Rights Management protection (DRM).*
 - c) *File name extensions that ended with the following are not supported: .wav; .m4a; .m4p; .mp4; .aac and etc.*
3. *No Direct connection can be made from a Computer USB port to the micro system even you have either or both mp3 or wma file in your computer.*

Viewing clock

- The clock (if it is set) is shown in normal standby mode.

To view the clock in any sound source (CD or FM for example)

- Press briefly **DISPLAY/CLOCK** (or **CLOCK** on the remote control).

Setting clock

- 1 In standby mode, press and hold **DISPLAY/CLOCK**.
 - The clock digits flash on the display panel.
 - If the clock has not been set, "00: 00" flashes
- 2 Press **TUNING ◀/▶** (or **◀/▶** on the remote) to set the hours.
- 3 Press **◀/▶** to set the minutes.
- 4 Press **PROG** to select between 12 hour and 24 hour display.
- 5 Press **DISPLAY/CLOCK** again to store the setting.
 - The clock starts working.

Notes:

- The clock setting will be erased when the system is disconnected from the power supply.
- The system will exit clock setting mode if no button is pressed within 90 seconds.
- To exit clock setting without storing, press **STOP** on the system to exit.

Setting wake-up timer

The system can switch on to DISC, TUNER or USB mode automatically at a preset time, serving as an alarm to wake you up.

IMPORTANT!

- Before setting the timer, ensure that the clock is set correctly.
- To set a new timer, you need to deactivate the previously set timer.

- 1 In standby mode, press and hold **SLEEP/TIMER** on the remote for more than 2 seconds to enter timer setting mode.
 - The source and timer digits will be lighted on the display panel.
 - "00: 00" will be displayed briefly if wake-up timer is not set.

- 2 Press **DISC, USB** or **TUNER** to select the desired source.
 - Before setting timer, make sure the music source has been prepared.
 - DISC** – load the disc.
 - TUNER** – tune to the desired radio station.
 - USB** – connect a USB device.
- 3 Press **TUNING ◀/▶** (or **◀/▶** on the remote) to set the hours.
- 4 Press **◀/▶** to set the minutes.
- 5 Press **SLEEP/TIMER** to store the time.
- At the preset time, the selected source will play.

To deactivate the wake-up timer

- In standby mode, press **SLEEP/TIMER** until "TIMER OFF" is displayed on the panel.

Notes:

- The system will exit timer setting mode if no button is pressed within 90 seconds.
- Display shows **⏸** if activated, and disappears if deactivated.

Setting sleep timer

The sleep timer enables the system to switch off by itself after a set period of time.

- 1 During playback, press **SLEEP/TIMER** on the remote control repeatedly to select sleep options.
 - The selections are as follows (time in minutes):
15 → 30 → 45 → 60 → 90 → 120 → OFF
- 2 Press **SLEEP/TIMER** until you reach the desired length of time.

To deactivate the sleep timer

- Press **SLEEP/TIMER** repeatedly until "OFF" is displayed, or press the **STANDBY ON** **⏻** button.

Specifications

AMPLIFIER

Output power	
L/R speakers	25 W /channel RMS
Subwoofer	50 W RMS
Speaker channel	
Frequency Response	200 Hz - 18 kHz / \pm 3 dB
Signal-to-Noise Ratio	> 60dB (A-weighted)
Input Sensitivity	
AUX In	500 mV
Output Sensitivity	
Line Out(1KHZ 0dB)	2 + 0.2V

TUNER

Tuning Range	FM 87.5 – 108 MHz
Signal-to-Noise Ratio	FM \geq 50 dB

DVD

Laser Type	Semiconductor
Disc Diameter	12cm / 8cm
Video Decoding	MPEG-2 / MPEG-1
Video DAC	12 Bits
Signal System	PAL / NTSC
Video Format	4:3 / 16:9
Video S/N	56 dB (minimum)
Composite Video Output	1.0 Vp-p, 75 Ω
S-Video Output	Y - 700 Vp-p, 75 Ω
	C - 300 Vp-p, 75 Ω
Audio DAC	24 Bits / 96 kHz

USB PLAYER

USB	12 Mb/s,V1.1
	support MP3 and WMA files
Number of albums/folders	maximum 99
Number of tracks/titles	maximum 800

Main unit

Power Supply Rating	220 -240V / 50 Hz
Power Consumption	
Active	60 W
Eco-power standby	<1 W
Dimensions (w x h x d)	232 x 85 x 275 (mm)
Weight	1.24 kg
Package Dimension (w x h x d)	
	615 x 515 x 225 (mm)
Gross weight	11.5 kg

SPEAKERS

System	1-way, Bass reflex
Impedance	4 Ω
Speaker drivers	3" fullrange
Frequency response	80 Hz – 20 kHz
Dimension (w x h x d)	160 x 250 x 180 (mm)
Weight	1.8 kg each

SUBWOOFER

Impedance	6 Ω
Speaker driver	5.25" subwoofer
Frequency response	60HZ—1K HZ
Dimensions(w x h x d)	160 x 250 x 310 (mm)
Weight	3.7 kg

Specifications and external appearance are subject to change without notice.

WARNING

Under no circumstances should you try to repair the system yourself, as this will invalidate the warranty. Do not open the system as there is a risk of electric shock.

If a fault occurs, first check the points listed below before taking the system for repair. If you are unable to remedy a problem by following these hints, consult your dealer or Philips for help.

Problem	Solution
No power.	<ul style="list-style-type: none"> ✓ Check if the AC power cord is properly connected. ✓ Press STANDBY ON  on the DVD System or source buttons on the remote to turn on the power.
No picture.	<ul style="list-style-type: none"> ✓ Check if the TV is switched on. ✓ Check the video connection. ✓ Press SOURCE on the DVD player repeatedly to select "DVD" or press DISC on the remote. ✓ Set your TV to the correct Video In channel. This channel is usually near channel 00. Or; you may have a button on the TV remote control that selects Auxiliary or A/V IN channel. See your TV owner's manual for details. Or; change channels at the TV until you see DVD screen on the TV. ✓ If the progressive scan feature is activated but the connected TV does not support progressive signals or the cables are not connected accordingly, see "Getting Started-Setting up Progressive Scan feature (for Progressive Scan TV only)" for proper progressive scan setup or deactivate the progressive scan feature as below: <ol style="list-style-type: none"> 1) Turn off your TV progressive scan mode or turn on to interlaced mode. 2) Select "OFF" in PROGRESSIVE menu of system setup menu to turn off progressive, then press SYSTEM MENU to exit the menu.
Distorted or poor picture.	<ul style="list-style-type: none"> ✓ Sometimes a small amount of picture distortion may appear. This is not a malfunction. ✓ Clean the disc.
Completely distorted picture or black/white picture.	<ul style="list-style-type: none"> ✓ TV has a colour system standard. If the disc's or DVD system's colour system is different than your TV's colour system, the picture may be distorted or colourless.

Troubleshooting

The aspect ratio of the screen cannot be changed even though you have set the TV shape.

- ✓ The aspect ratio is fixed on the DVD disc.
- ✓ Depending on the TV, it may not be possible to change the aspect ratio.

No sound or distorted sound.

- ✓ Adjust the volume.
- ✓ Check that the speakers are connected correctly.
- ✓ Replace the speaker cables.
- ✓ Disconnect the headphones.
- ✓ The system is in pause, slow motion or fast forward/reverse mode, press ► || (or ► || on the remote) to resume normal play mode.

The micro DVD player does not start playback.

- ✓ Insert a readable disc with the playback side facing down.
- ✓ Check the disc type, colour system and regional code. Check for any scratches or smudges on the disc.
- ✓ Press SYSTEM MENU to turn off the setup menu screen.
- ✓ Cancel the parental control rating function or change the rating level.
- ✓ Moisture has condensed inside the system. Remove the disc and leave the system turned on for about an hour.

The DVD micro system does not respond when the buttons are pressed.

- ✓ Disconnect the power plug from the outlet and insert again.

Cannot activate some features, such as Subtitles, or multi-language Audio.

- ✓ Multi-language sound or subtitle is not recorded on the DVD.
- ✓ Changing the language for the sound or subtitle is prohibited on the DVD.
- ✓ The features may not be available on the disc.

Radio reception is poor.

- ✓ If the signal is too weak, adjust the antenna or connect an external antenna for better reception.
- ✓ Increase the distance between the Mini HiFi System and your TV or VCR.

The timer is not working.

- ✓ Set the clock correctly.

The Clock/Timer setting is erased.

- ✓ Power has been interrupted or the power cord has been disconnected. Reset the clock/timer.

The remote control does not function.

- ✓ Select the correct source (DISC or AUX for example) before pressing the function button.
- ✓ Point the remote control at the remote sensor of the unit.
- ✓ Reduce the distance to the player.
- ✓ Remove any possible obstacles.
- ✓ Replace the battery with new one.
- ✓ Check that the battery is loaded correctly.

Low hum or buzz sound.

- ✓ Place the DVD micro system as far away as possible from electrical devices (such as speakers, TV) that may be causing interference.

Low bass response.

- ✓ Check all speakers for correct polarity.

Unable to select Progressive Scan

- ✓ Check that the output of the video signal is switched to 'Ypbpr'.

Analog: Sound that has not been turned into numbers. Analog sound varies, while digital sound has specific numerical values. These jacks send audio through two channels, the left and right.

Aspect ratio: The ratio of vertical and horizontal sizes of a displayed image. The horizontal vs. vertical ratio of conventional TVs is 4:3, and that of wide-screens is 16:9.

AUDIO OUT Jacks: Jacks on the back of the DVD System that send audio to another system (TV set, Stereo, etc.).

Bit Rate: The amount of data used to hold a given length of music; measured in kilobits per second, or kbps. Or, the speed at which you record. Generally, the higher the bit rate the better the sound quality. However, higher bit rates use more space on a Disc.

Chapter: Sections of a picture or a music piece on a DVD that are smaller than titles. A title is composed of several chapters. Each chapter is assigned a chapter number enabling you to locate the chapter you want.

Component Video Out Jacks: Jacks on the back of the DVD System that send high-quality video to a TV set that has Component Video In jacks (R/G/B, Y/Pb/Pr, etc.).

Disc menu: A screen display prepared for the selection of images, sound, subtitles, multi-angles, etc recorded on a DVD.

Digital: Sound that has been converted into numerical values. Digital sound is available when you use the DIGITAL AUDIO OUT COAXIAL or OPTICAL jacks. These jacks send audio through multiple channels, instead of just two channels as analog does.

Dolby Digital: A surround sound system developed by Dolby Laboratories containing up to six channels of digital audio (front left and right, surround left and right and center).

JPEG: A still-picture data compression system proposed by the Joint Photographic Expert Group, which features small decrease in image quality in spite of its high compression ratio.

MP3: A file format with a sound data compression system. "MPE" is the abbreviation of Motion Picture Experts Group 1 (or MPEG-1) Audio Layer 3. Through the MP3 format, one CD-R or CD-RW can contain about 10 times as much data volume as a regular CD can.

Multichannel: DVD is specified to have all sound tracks constitute one sound field. Multichannel refers to a structure of sound tracks having three or more channels.

Parental control: A function of the DVD to limit playback of the disc by the age of the users according to the limitation level in each country. The limitation varies from disc to disc; when it is activated, playback will be prohibited if the software's level is higher than the user-set level.

PCM (Pulse Code Modulation): A system for converting analog sound signal to digital signal for later processing without data compression.

Playback control (PBC): Refers to the signal recorded on video CDs or SVCDs for reproduction control. By using screen menus recorded on a Video CD or SVCD that supports PBC, you can enjoy interactive-type software as well as software having a search function.

Progressive Scan (P-Scan): It displays all the horizontal lines of a picture at one time, as a signal frame. This system can convert interlaced video from DVD into progressive format for connection to a progressive display. It dramatically increases the vertical resolution. A progressive scan TV set is needed to receive progressive scan output from the system.

Region code: A system allowing discs to be played only in preset regions. This unit will only play discs that have compatible region codes. You can find the region code of your unit from the product label. Some discs are compatible with more than one region (or ALL regions).

S-Video: Produces a clear picture by sending separate signals for luminance and the color. You can use S-Video only if your TV set has S-Video In Jack.

Sampling Frequency: Frequency of data sampling when analog data is converted to digital data. Sampling frequency numerically represents how many times the original analog signal is sampled per second.

Surround: A system for users to create realistic three-dimensional sound fields full of realism by arranging multiple speakers around the listener.

Title: The longest section of a picture or music feature on DVD, music, etc., in video software, or the entire album in audio software. Each title is assigned a title number enabling you to locate the title you want.

VIDEO OUT jack: Jack on the back of the DVD System that sends video to TV.

Meet Philips at the Internet
<http://www.philips.com>

English

Русский

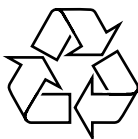

MCD179



Printed in China

PDCC-ZYL-0811