

DVD CHANGER
LECTEUR DE DVD CHANGEUR

DV-C6860

*OWNER'S MANUAL
MODE D'EMPLOI
BEDIENUNGSANLEITUNG
ИНСТРУКЦИЯ ПО ЭКСПЛУАТАЦИИ*



Important notes for users in the U.K.

Mains plug

This apparatus is fitted with an approved 13 Amp plug. To change a fuse in this type of plug proceed as follows:

- 1 Remove fuse cover and fuse.
- 2 Fix new fuse which should be a BS1362 5 Amp, A.S.T.A. or BSI approved type.
- 3 Refit the fuse cover.

If the fitted plug is not suitable for your jack outlets, it should be cut off and an appropriate plug fitted in its place.

If the mains plug contains a fuse, this should have a value of 5 Amp. If a plug without a fuse is used, the fuse at the distribution board should not be greater than 5 Amp.

Note: The severed plug must be disposed to avoid a possible shock hazard should it be inserted into a 13 Amp jack elsewhere.

How to connect a plug

The wires in the mains lead are coloured with the following code: blue = neutral (N), brown = live (L).

- As these colours may not correspond with the colour markings identifying the terminals in your plug, proceed as follows:
 - Connect the blue wire to the terminal marked N or coloured black.
 - Connect the brown wire to the terminal marked L or coloured red.
 - Do not connect either wire to the earth terminal in the plug, marked E (or e) or coloured green (or green and yellow).

Before replacing the plug cover, make certain that the cord grip is clamped over the sheath of the lead - not simply over the two wires.

Copyright in the U.K.

Recording and playback of material may require consent. See Copyright Act 1956 and The Performer's Protection Acts 1958 to 1972.

VAROITUS

Muiden kuin tässä esitettyjen toimintojen säädön tai asetusten muutto saattaa altistaa vaaralliselle säteilylle tai muille vaarallisille toiminnoille.

DK

Advarsel: Usynlig laserstråling ved åbning når sikkerhedsafbrydere er ude af funktion. Undgå udsættelse for stråling.

Bemærk: Netafbryderen STANDBY/ON er sekundært indkoblet og afbryder ikke strømmen fra nettet. Den indbyggede netdel er derfor tilsluttet til lysnettet så længe netstikket sidder i stikkontakten.

N

Observer: Nettbryteren STANDBY/ON er sekundert innkoplek. Den innebygdenettdelen er derfor ikke frakoplek nettet så lenge apparatet er tilsluttet nettkontakten.

S

Klass 1 laseraparat

Varning! Om apparaten används på annat sätt än i denna bruksanvisning specificerats, kan användaren utsättas för osynlig laserstråling, som överskrider gränsen för laserklass 1.

Observera! Strömbrytaren STANDBY/ON är sekundärt kopplad och inte bryter inte strömmen från nätet. Den inbyggda nät delen är därför ansluten till elnätet så länge stickproppen sitter i vägguttaget.

SF

Luokan 1 laserlaitte

Varoitus! Laitteen käyttäminen muulla kuin tässä käyttöohjeessa mainitulla tavalla saattaa altistaa käyttäjän turvallisuusluokan 1 ylittävälle näkymättömälle lasersäteilylle.

Oikeus muutoksiin varataan. Laitte ei saa olla alltiina tippu-ja roiskevedelle.

Toiminnanvalitsin STANDBY/ON on kytketty toisiopuolelle, eikä se kytke laitetta irti sähköverkosta. Sisäänrakennettu verkko-osa on kytkettynä sähköverkkoon aina silloin, kun pistoke on pistorasiassa.

VARO!

AVATTAESSA JA SUOJALUKITUS OHITETTAESSA OLET ALTTIINA NÄKYMÄTTÖMÄLLE LASERSÄTEILYLLE. ÄLÄ KATSO SÄ TEeseen.

VARNING!

OSYNLIG LASERSTRÅLNING NÄR DENNA DEL ÄR ÖPNAD OCH SPÄREN ÄR URKOPPLAD. BETRakta EJ STRÅLEN.

**CLASS 1 LASER PRODUCT
LASER KLASSE 1 PRODUKT
LUOKAN 1 LASERLAITE
KLASS 1 LASER APPARAT
PRODUIT LASER DE CLASSE 1**

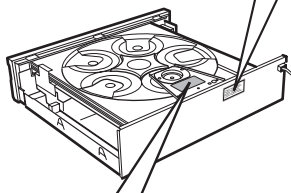

CAUTION VISIBLE AND INVISIBLE LASER RADIATION WHEN OPEN. AVOID EXPOSURE TO BEAM

ADVARSEL SYNLIG OG USYNLIG LASERSTRÅLING VED ÅBNING
UNDGÅ UDSÆTTELSE FOR STRÅLING

ADVARSEL SYNLIG OG USYNLIG LASERSTRÅLING NÅR DEKSEL
ÅPNES UNNGÅ EKSPONERING FOR STRÅLEN

VARNING SYNLIG OCH OSYNLIG LASERSTRÅLNING NÅR
DENNA DEL ÄR ÖPPNAD BETRakta EJ STRÅLEN

VARO ! AVATTAESSA OLET ALTTIINA NÄKYVÄLLE JA

NÄKYMÄTTÖMÄLLE LASER SÄTEHYLLE, ÄLÄ KATSO SÄTEESEEN

VORSICHT SICHTBARE UND UNSICHTBARE LASERSTRAHLUNG
WENN ABDECKUNG GEÖFFNET NICHT DEM STRAHL AUSSETZEN

DANGER VISIBLE AND INVISIBLE LASER RADIATION WHEN
OPEN AVOID DIRECT EXPOSURE TO BEAM

ATTENTION RAYONNEMENT LASER VISIBLE ET INVISIBLE EN
CAS D'OUVERTURE EXPOSITION DANGEREUSE AU FAISCEAU

ПРЕДУПРЕЖДЕНИЕ ПРИ ОТКРЫТИИ УСТРОЙСТВА
ВЫ МОЖЕТЕ ПОДВЕРГНУТЬСЯ ВОЗДЕЙСТВИЮ
ВИДИМОГО И НЕВИДИМОГО ЛАЗЕРНОГО ИЗЛУЧЕНИЯ.
ИЗБЕГАЙТЕ ВОЗДЕЙСТВИЯ ЛУЧА.

LASER SAFETY

This unit employs a laser. Due to possible eye injury, only a qualified service person should remove the cover or attempt to service this device.

SECURITE LASER

L'appareil utilise un laser. En raison des risques de blessure des yeux, le retrait du couvercle ou les réparations de l'appareil devront être confiés exclusivement à un technicien d'entretien qualifié.

VORSICHT MIT DEM LASER

Dieses Gerät enthält einen Laser. Um unnötige Augenverletzungen zu vermeiden, sollten Sie alle Wartungs- und Reparaturarbeiten einem qualifizierten Wartungstechniker überlassen.

БЕЗОПАСНОЕ ИСПОЛЬЗОВАНИЕ ЛАЗЕРА

Данное устройство содержит лазер. Из-за опасности травмирования глаз снимать крышку или обслуживать данное устройство должен только сертифицированный специалист по техническому обслуживанию.

DANGER

This unit emits visible laser radiation when open. Avoid direct eye exposure to beam. When this unit is plugged into a wall outlet, do not place your eyes close to the opening of the disc tray and other openings or look inside.

DANGER

Risque d'exposition au laser en cas d'ouverture. Eviter toute exposition au faisceau. Lorsque cet appareil est branché à la prise de courant, ne pas approcher les yeux de l'ouverture du plateau changeur et des autres ouvertures pour regarder à l'intérieur.

GEFAHR

Sichtbare Laserstrahlen bei geöffneter Abdeckung. Achten Sie darauf, nicht direkt in den Laserstrahl zu blicken. Wenn das Gerät an die Wandsteckdose angeschlossen ist, halten Sie die Augen von der Öffnung des Disc-Fachs oder anderen Öffnungen fern, und blicken Sie in diesem Fall nicht in das Innere des Geräts.

ОПАСНОСТЬ

Данное устройство излучает в открытом состоянии видимые лазерные лучи. Не допускайте непосредственного воздействия лазерных лучей на глаза. Когда данное устройство подключено к настенной розетке, не приближайте глаза к отверстию лотка для диска и других отверстий и не смотрите на внутренние части.

CAUTION

Use of controls or adjustments or performance of procedures other than those specified herein may result in hazardous radiation exposure.

ATTENTION

L'emploi de commandes, de réglages ou un choix de procédures différents des spécifications de cette brochure peut entraîner une exposition à d'éventuelles radiations pouvant être dangereuses.

ACHTUNG

Die Verwendung von Bedienungselementen oder Einstellungen oder die Durchführung von Bedienungsvorgängen, die nicht in dieser Anleitung aufgeführt sind, kann zu einem Kontakt mit gefährlichen Laserstrahlen führen.

ПРЕДУПРЕЖДЕНИЕ

Использование органов управления или настроек или выполнение процедур, отличных от описанных в данном руководстве, могут привести к опасному облучению.

CAUTION: READ THIS BEFORE OPERATING THIS UNIT.

- 1 To assure the finest performance, please read this manual carefully. Keep it in a safe place for future reference.
- 2 Install this unit in a well ventilated, cool, dry, clean place — away from direct sunlight, heat sources, vibration, dust, moisture, or cold. In a cabinet, allow about 2.5cm (1 inch) of free space all around this unit for adequate ventilation.
- 3 Locate this unit away from other electrical appliances, motors, or transformers to avoid humming sounds.
- 4 Do not expose this unit to sudden temperature changes from cold to hot, nor locate this unit in an environment with high humidity (i.e., a room with a humidifier) to prevent condensation inside this unit, which may cause an electrical shock, fire, damage to this unit, and/or personal injury.
- 5 Avoid installing this unit where foreign objects may fall onto this unit and/or this unit may be exposed to liquid dripping or splashing. On the top of this unit, do not place:
 - Other components, as they may cause damage and/or discoloration on the surface of this unit.
 - Burning objects (i.e., candles), as they may cause fire, damage to this unit, and/or personal injury.
 - Containers with liquid in them, as they may fall, spilling the liquid and causing an electrical shock to the user and/or damage to this unit.
- 6 Do not cover this unit with a newspaper, tablecloth, curtain, etc. in order not to obstruct heat radiation. If the temperature inside this unit rises, it may cause fire, damage to this unit, and/or personal injury.
- 7 Do not plug in this unit to a wall outlet until all connections are complete.
- 8 Do not operate this unit upside-down. It may overheat, possibly causing damage.
- 9 Do not use excessive force on switches, knobs and/or cords.
- 10 When disconnecting the power cord from the wall outlet, grasp the plug; do not pull the cord.
- 11 Do not clean this unit with chemical solvents; this might damage the finish. Use a clean, dry cloth.
- 12 Only voltage specified on this unit must be used. Using this unit with a higher voltage than specified is dangerous and may cause fire, damage to this unit, and/or personal injury. YAMAHA will not be held responsible for any damage resulting from use of this unit with a voltage other than as specified.
- 13 Do not attempt to modify or fix this unit. Contact qualified YAMAHA service personnel when any service is needed. The cabinet should never be opened for any reason.
- 14 When not planning to use this unit for long periods of time (i.e., vacation), disconnect the AC power plug from the wall outlet.
- 15 Be sure to read the “Troubleshooting” section on common operating errors before concluding that this unit is faulty.
- 16 Before moving this unit, press STANDBY/ON to set the unit in standby mode, and then disconnect the AC power plug from the wall outlet.
- 17 Install this unit near the wall outlet and where the AC power plug can be reached easily.

The unit is not disconnected from the AC power source as long as it is connected to the wall outlet, even if this unit itself is turned off. This state is called the standby mode. In this state, this unit is designed to consume a very small quantity of power.

WARNING

TO REDUCE THE RISK OF FIRE OR ELECTRIC SHOCK, DO NOT EXPOSE THIS UNIT TO RAIN OR MOISTURE.

Be sure to place this unit on a level surface.

If you do not do so, PLAYXCHANGE operation of this unit will not function correctly, and may damage the disc(s) and/or this unit itself.

LASER

Type	Semiconductor laser GaAlAs
Wave length	650 nm (DVD) 780 nm (VCD/CD)
Output Power	7 mW (DVD) 10 mW (VCD/CD)
Beam divergence	60 degree

Refer to pages i and ii at the beginning of the manual for more information.

Introduction

Region codes	2
Supplied accessories.....	2
Notes on discs	2
Cleaning discs	2
Patent information.....	2

Functional Overview

Front panel.....	3
Rear panel	4
Remote control.....	5

Connections

General notes on connections	6
Audio connections	6
Digital connection.....	6
Analog connection.....	6
Video connections.....	7
SCART terminal <A>.....	7
Component video jacks	7
Composite video jack <C>.....	7

Getting Started

Inserting batteries into the remote control.....	8
Using the remote control	8
Turning on the power.....	9
About the auto standby function	9
Setting a TV type and display.....	9
Setting a color system for your TV	9
Setting an aspect ratio for your TV.....	10
Setting a language preference	11
Setting the OSD language	11
Setting the audio, subtitle and disc menu languages.....	11

Disc Operations

Basic playback.....	12
General operation.....	12
Pausing playback.....	12
Selecting a track/chapter.....	13
Searching backward/forward.....	13
Stopping playback.....	13
Selecting the various repeat/shuffle functions.....	13
Repeat.....	13
Repeating a section within a chapter/track.....	14
Shuffle (except DVD/VCD/SVCD).....	14
Operations for video playback (DVD/VCD/SVCD).....	14
Using the disc menu.....	14
Slow motion	14
Zooming in.....	15
Resuming playback from the last stopped point.....	15
On-screen display (OSD).....	15

Special DVD features	16
Playing by title.....	16
Camera angle	16
Audio.....	17
Subtitles.....	17
Special VCD & SVCD features	17
Playback control (PBC).....	17
Audio CDs.....	17
Playing by discs.....	17
Playing MP3/JPEG/Kodak picture CDs.....	17
General operation.....	17
Selecting a folder and track/file.....	18
Special picture disc features	18
Preview function (JPEG).....	18
Zooming pictures	18
Playback with multi-angles.....	18
Scan effect.....	19
Playing MP3 music and JPEG pictures simultaneously.....	19

Setup Menu

General setup menu	20
Locking/Unlocking the disc for viewing.....	20
Dimming the front panel display.....	20
Programming disc tracks and discs	20
OSD language.....	22
Screen saver.....	22
Sleep timer	22
Audio setup menu.....	22
Setting the analog output.....	23
Setting the digital output.....	23
CD upsampling	24
Night mode.....	24
Video setup menu	24
TV type.....	24
Setting the TV display	25
Progressive.....	26
Picture settings.....	26
Switching the YUV/RGB.....	27
Preference setup menu.....	27
Audio, subtitle and disc menu.....	28
Restricting playback with parental control	28
PBC (Playback control)	28
MP3/JPEG menu	28
Changing the password.....	29
Resetting the system.....	29

Language Code 30

Troubleshooting 32

Glossary 34

Specifications 35

Introduction

Thank you for purchasing this unit. This Owner's Manual explains the basic operation of this unit.

Region codes

DVD discs must be labeled ALL regions or Region 2 in order to play on this unit.



You cannot play discs labeled for other regions.



Supplied accessories

- Remote control
- Two batteries (AA, R06, UM-3) for the remote control
- Audio pin cable
- Video pin cable
- Owner's Manual

Notes on discs

- This unit is designed for use with the following discs: DVD-Video, Video CD, Super Video CD, Audio CD, CD-R, CD-RW, DVD+RW, DVD+R, DVD-R and DVD-RW.
- This unit can play:
 - MP3 and picture (Kodak, JPEG) files recorded on CD-R(W).
 - JPEG/ISO 9660 format
 - Maximum 30 characters per display
- CD-R and CD-RW cannot be played unless finalized.
- Some discs cannot be played depending on the recording conditions, such as the PC environment and application software. The characteristics and conditions of some discs (materials, scratches, curvature, etc.) may result in playback failure.
- Be sure to use only CD-R and CD-RW discs made by reliable manufacturers.

- Do not use any non-standard shaped discs (heart-shaped, etc.).
- Do not use discs with tape, seals, or paste on their surface. Doing so may damage this unit.
- Do not use discs affixed with labels printed by a commercially available label printer.

Cleaning discs

- When a disc becomes dirty, clean it with a cleaning cloth. Wipe the disc from the center out. Do not wipe in a circular motion.
- Do not use solvents such as benzene, thinner, commercially available cleaners, or antistatic spray intended for analog records.

Patent information



Manufactured under license from Dolby Laboratories. "Dolby", "Pro Logic" and the double-D symbol are trademarks of Dolby Laboratories.



"DTS" and "DTS Digital Out" are trademarks of Digital Theater Systems, Inc.

This product incorporates copyright protection technology that is protected by method claims of certain U.S. patents and other intellectual property rights owned by Macrovision Corporation and other rights owners. Use of this copyright protection technology must be authorized by Macrovision Corporation, and is intended for home and other limited viewing uses only unless otherwise authorized by Macrovision Corporation. Reverse engineering or disassembly is prohibited.

Front panel

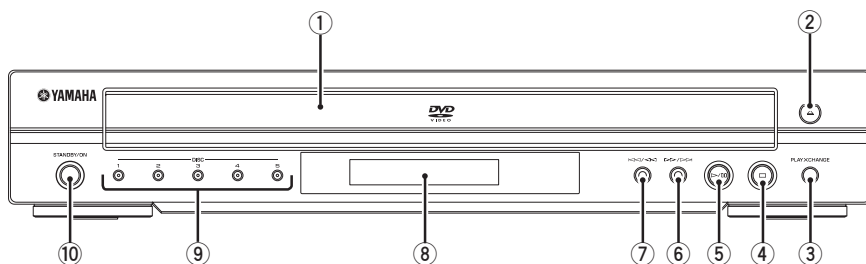

- ① **Disc tray**
Loads up to 5 discs in the disc tray.
- ② **▲ (OPEN/CLOSE)**
Opens or closes the disc tray.
- ③ **PLAYXCHANGE**
Reloads or unloads discs without interrupting current disc playback.
- ④ **■ (STOP)**
Stops playback.
- ⑤ **▶/|| (PLAY/PAUSE)**
Starts or pauses playback.
- ⑥ **▶▶▶▶▶**
Searches forward.*
Moves to the next chapter or track.
- ⑦ **◀◀◀◀◀**
Searches backward.*
Moves to the previous chapter or track.
- ⑧ **Front panel display**
Shows the current status of this unit.
- ⑨ **DISC (1, 2, 3, 4, 5) / LEDs**
Selects and directly plays back the preferred disc.
Each LED lights up in orange when this unit recognizes that the corresponding disc has been loaded.
- ⑩ **STANDBY/ON**
Turns on this unit or sets it to the standby mode.
While this unit is in the standby mode, it consumes a small amount of power.

* Press the button for about two seconds.

Functional Overview

Rear panel

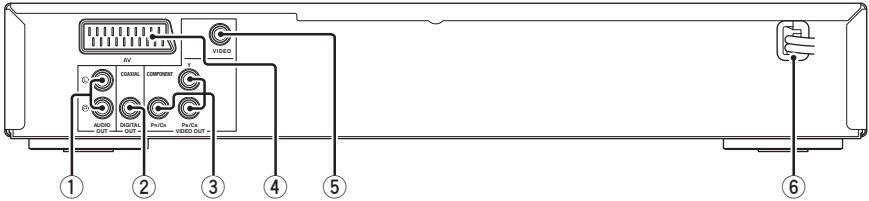

- ① **AUDIO OUT (L, R) jacks**
Connect to the audio input jacks of your AV receiver or stereo system.
- ② **DIGITAL OUT - COAXIAL jack**
Connect to the coaxial input jack of your AV receiver.
- ③ **VIDEO OUT - COMPONENT (Y, PB/CB, PR/CR) jacks**
Connect to the component input jacks of your AV receiver.
- ④ **AV terminal**
Connect to SCART input terminal of your TV.
- ⑤ **VIDEO OUT - VIDEO jack**
Connect to the composite video input jack of your AV receiver.
- ⑥ **AC power cord**
Connect to a standard AC outlet.

Caution: Do not touch the inner pins of the jacks on the rear panel of this unit. Electrostatic discharge may cause permanent damage to this unit.

Remote control

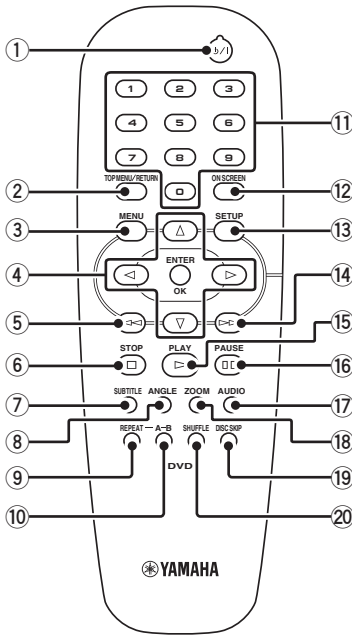

- ① **⏻/I**
Turns on this unit or sets it to the standby mode.
- ② **TOP MENU/RETURN**
Displays the top-level disc menu (DVD). Moves back to the previous menu (DVD*/VCD).
- ③ **MENU**
Accesses the menu of a disc (DVD). Switches PBC on or off (VCD).
- ④ **◀/▶/▲/▼**
Selects an item in the currently displayed menu. Search or slow playback.
ENTER/OK
Confirms the menu selection.
- ⑤ **◀◀**
Searches backward.*
Moves to the previous chapter or track.

- ⑥ **STOP (■)**
Stops playback.
- ⑦ **SUBTITLE**
Selects the subtitle language.
- ⑧ **ANGLE**
Selects the DVD camera angle.
- ⑨ **REPEAT**
Repeats the chapter, track, title, disc or all discs.
- ⑩ **A-B**
Repeats a specific segment.
- ⑪ **Numeric buttons (0-9)**
Selects numbered items in the currently displayed menu.
- ⑫ **ON SCREEN**
Accesses or exits from the on-screen display (OSD) menu of this unit.
- ⑬ **SETUP**
Accesses or exits from the setup menu of this unit.
- ⑭ **▶▶|**
Searches forward.*
Moves to the next chapter or track.
- ⑮ **PLAY (▶)**
Starts playback.
- ⑯ **PAUSE (||)**
Pauses playback temporarily.
Frame-by-frame playback.
- ⑰ **AUDIO**
Selects the audio language or format.
- ⑱ **ZOOM**
Enlarges the video image.
- ⑲ **DISC SKIP**
Selects another disc.
- ⑳ **SHUFFLE**
Plays tracks in a random order.

* Press and hold the button for about two seconds.

Connections

General notes on connections

Be sure to turn off this unit and unplug the power supply cable before you make or change connections.

- Depending on the component you wish to connect, there are various ways to make connections. Possible connections are described below.
- Refer to the manuals of your other components as necessary to make the best connections.
- Do not connect this unit via your VCR. The video quality could be distorted by the copy protection system.
- Do not connect the audio out jack of this unit to the phono in jack of your audio system.

Audio connections

Digital connection

This unit has a coaxial digital out jack. Connect DIGITAL OUT - COAXIAL jack of this unit to your AV receiver equipped with a Dolby Digital, DTS, or MPEG decoder using a commercially available coaxial cable.

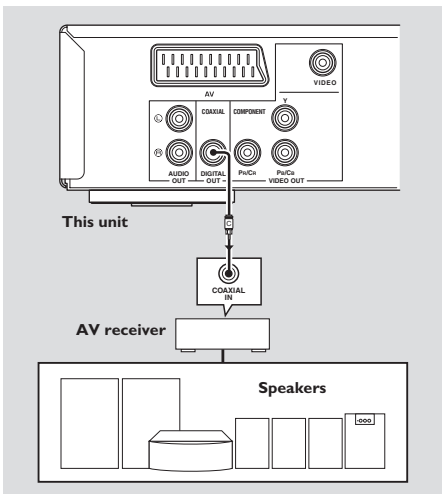

You need to set “DIGITAL OUTPUT” to “ALL” (see “DIGITAL OUTPUT” on page 23).

Notes:

- If the audio format of the digital output does not match the capabilities of your receiver, the receiver produces a distorted sound or no sound at all. Make sure to select the appropriate audio format from the menu screen on the disc. Pressing AUDIO on the remote control once or more may change not only the audio language but also the audio format. The selected format appears in the front panel display for several seconds.
- If you wish to enjoy Dolby Digital, DTS, and MPEG formats, you must connect this unit to an AV receiver that supports these formats.

Analog connection

This unit has analog output jacks. Connect AUDIO OUT (L, R) jacks of this unit to the corresponding input jacks of your audio component (such as a stereo amplifier) using the supplied audio cable.

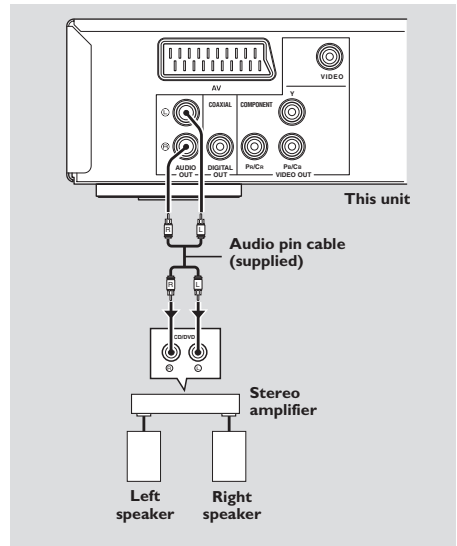

Video connections

If your AV receiver has video output jacks, connect your receiver and then your TV so that you can use one TV for several different video sources (LD, VCR, etc.) by simply switching the input source selector of your AV receiver.

This unit has three types of video output jacks. Use the one that corresponds to the input jacks of the component to be connected.

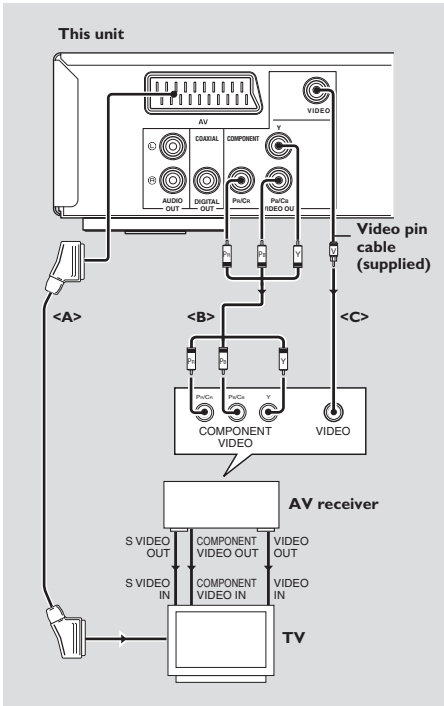

SCART terminal <A>

If your TV has only a terminal for video input, you can connect the TV directly to this unit.

Connect AV terminal of this unit to SCART input terminal of your TV using a commercially available SCART cable.

Note:

- Ensure that the “TV” indication on SCART cable is connected to the TV set and “DVD” indication on SCART cable is connected to this unit.

Component video jacks

Component video connections achieve higher fidelity color reproduction than S-video connections by transmitting video signals on separate wires for luminance (Y: green) and chrominance (Pb: blue, Pr: red).

Connect VIDEO OUT - COMPONENT (Y, Pb/Cb, Pr/CR) jacks of this unit to component input jacks of your AV receiver and then to those of your TV using a commercially available component cable. Observe the color of each jack when you make connections. If your AV receiver does not have component output jacks, you can achieve a better video image by connecting the component output jacks of this unit directly to the component input jacks of your TV.

Composite video jack <C>

Connect VIDEO OUT - VIDEO jack of this unit to the video input jack of your AV receiver and then to that of your TV using the supplied video cable.

Getting Started

Step 1: Inserting batteries into the remote control

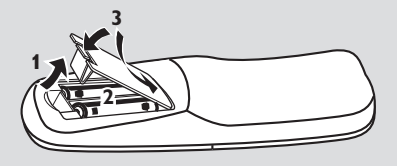

- 1 Open the battery compartment.
- 2 Insert the two supplied batteries (AA, R06, UM-3) following the indications (+/-) inside the compartment.
- 3 Close the cover.

Notes:

- Insert batteries correctly according to the polarity markings (+/-). The batteries inserted in the opposite direction may leak.
- Replace the exhausted batteries immediately with new ones to prevent a leakage.
- Remove the batteries from the compartment if the remote control is not used for more than a month.
- If the batteries have leaked, dispose of them immediately. Avoid touching the leaked material or letting it come into contact with clothing, etc. Clean the battery compartment thoroughly before installing new batteries.
- Do not use old batteries together with new ones.
- Do not use different types of batteries (such as alkaline and manganese batteries) together. Read the packaging carefully as these different types of batteries may have the same shape and color.
- Dispose of the batteries correctly in accordance with your local regulations.

Using the remote control

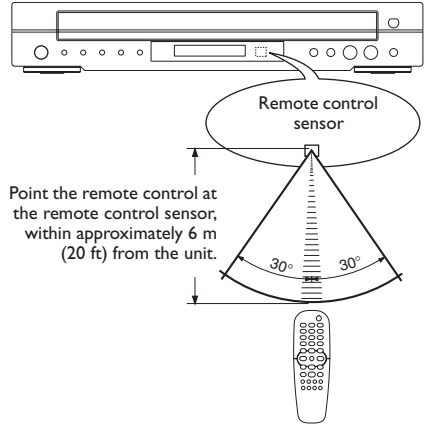

Handling the remote control

- Do not spill water or other liquids on the remote control.
- Do not drop the remote control.
- Do not leave or store the remote control in the following types of conditions:
 - places of high humidity, such as near a bath
 - places of high temperature, such as near a heater or stove
 - places of extremely low temperatures
 - dusty places

Step 2: Turning on the power

- 1 Connect the AC power cord to an AC outlet.
- 2 Turn on your TV and AV receiver.
- 3 Select the appropriate input source of the AV receiver connected to this unit. Refer to the manual supplied with your AV receiver for details.
- 4 Turn on this unit.
- 5 Set the TV to the correct Video IN channel (e.g. EXT1, EXT2, AV1, AV2, AUDIO/VIDEO, etc. Refer to the manual supplied with your TV for details).
→ The front panel display lights up and the default screen appears on the TV.

About the auto standby function

This unit is automatically set to the standby mode when disc playback is stopped or paused for more than 30 minutes.

When “SCREEN SAVER” is set to “ON” (see page 22):

The background is displayed when disc playback is stopped or the paused picture is displayed for 15 minutes.



Background

OR



Example of a paused picture



The screen saver is displayed for another 15 minutes.

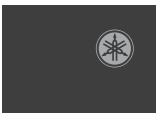

This unit is set to the standby mode.

When “SCREEN SAVER” is set to “OFF” (see page 22):

The background or the paused picture is displayed for 30 minutes.



This unit is set to the standby mode.

Step 3: Setting a TV type and display

Setting a color system for your TV

This unit is compatible with both NTSC and PAL video formats. Select the color system that matches your TV.

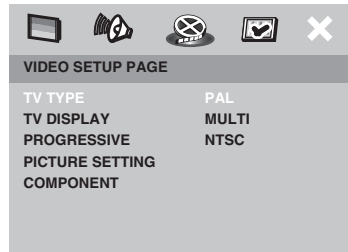

- 1 Press **SETUP**.
- 2 Press **▶** repeatedly to select “VIDEO SETUP PAGE”.
- 3 Press **▲/▼** to highlight [TV TYPE], and then press **▶**.
- 4 Press **▲/▼** to highlight one of the following options.

TIPS: To return to the previous menu, press **◀**.
To exit from the menu, press **SETUP**.

Getting Started

PAL

Select this if the connected TV is a PAL system TV. It will change the video signals of NTSC discs and output them in PAL format.

MULTI

Select this if the connected TV is compatible with both NTSC and PAL formats (such as a multi-system TV). The output format will be in accordance with the video signals of the disc.

NTSC

Select this if the connected TV is an NTSC system TV. It will change the video signals of PAL discs and output them in NTSC format.

- 5 Select an item, and then press **ENTER/OK** to confirm your selection.

Notes:

- *Before changing the current TV standard setting, ensure that your TV supports the selected TV type.*
- *If the picture is not displayed properly on your TV, wait for 15 seconds for this unit to activate automatic recovery.*

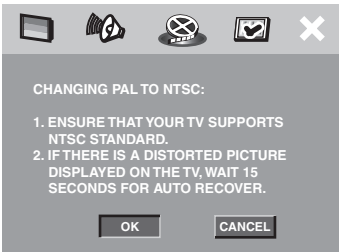

Setting an aspect ratio for your TV

You can set the aspect ratio of this unit to match your TV. If the aspect ratio of your TV is 4:3, you do not need to change this setting. If you have a widescreen TV, change this setting according to the following procedure. For details, see “Setting the TV display” on page 25.

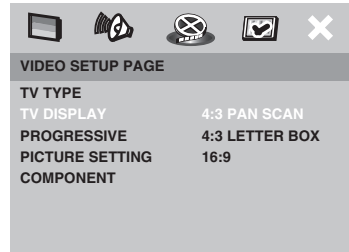

- 1 Press **SETUP**.
- 2 Press **▶** repeatedly to select “VIDEO SETUP PAGE”.
- 3 Press **▲/▼** to highlight [TV DISPLAY], and then press **▶**.
- 4 Press **▲/▼** to highlight [16:9], and then press **ENTER/OK** to confirm the selection.

TIPS: To return to the previous menu, press **◀**.
To exit from the menu, press **SETUP**.

Step 4: Setting a language preference

You can select your own preferred language settings. This unit automatically switches to your preferred language whenever you load a disc. If the selected language is not available on the disc, the default language of the disc will be used instead. The OSD language in the system menu remains once selected.

Setting the OSD language



- 1 Press **SETUP**.
- 2 Press **◀/▶** to select “GENERAL SETUP PAGE”.
- 3 Press **▲/▼** to highlight [OSD LANGUAGE], and then press **▶**.
- 4 Press **▲/▼** to select a language, and then press **ENTER/OK** to confirm your selection.

Setting the audio, subtitle and disc menu languages



- 1 Press **STOP (■)** twice, and then press **SETUP**.
- 2 Press **▶** repeatedly to select “PREFERENCE PAGE”.
- 3 Press **▲/▼** to highlight one of the options below at a time, and then press **▶**.
 - AUDIO (audio language)
 - SUBTITLE (subtitle language)
 - DISC MENU (disc menu language)
- 4 Press **▲/▼** to select a language, and then press **ENTER/OK** to confirm your selection.

If the language you want is not in the list, select [OTHERS], and then use the **numeric buttons (0-9)** on the remote control to enter the 4-digit language code (see “Language Code” on page 30), and then press **ENTER/OK** to confirm the code.
- 5 Repeat steps 3–4 for other language settings.

TIPS: To return to the previous menu, press **◀**.
To exit from the menu, press **SETUP**.

Disc Operations

IMPORTANT!

- If the inhibition icon (⊘ or X) appears on the TV screen when a button is pressed, the function for that button is not available on the current disc or at the current time.
- Depending on the DVD or VIDEO CD disc, some operations may operate differently or be restricted.
- Do not push on the disc tray or put any objects other than discs on the disc tray. Doing so may cause the disc player to malfunction.

Basic playback

- 1 Press **STANDBY/ON** on the front panel or ϕ /I on the remote control.
- 2 Press **▲ (OPEN/CLOSE)** on the front panel to open the disc tray.
- 3 Place discs in the disc tray with the printed side up.

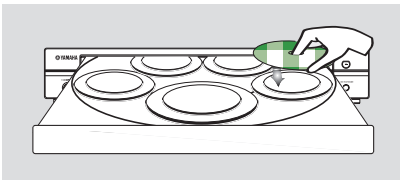

- 4 Press **▶/II (PLAY/PAUSE)** on the front panel or **PLAY (▶)** on the remote control.
→ The disc tray closes and playback starts automatically for all of the loaded discs in the tray in sequence.

- 5 To stop playback, press **■ (STOP)** on the front panel or **STOP (■)** on the remote control.
 - To play back a specific disc directly, press **DISC SKIP** repeatedly on the remote control or press **DISC (1, 2, 3, 4, 5)** on the front panel.
 - Press **PLAYXCHANGE** on the front panel to open the disc tray, and then reload or unload discs without interrupting current disc playback.
 - Playback stops after all discs have been played.
 - When the disc tray is open, press **▶/II (PLAY/PAUSE)**, **▲ (OPEN/CLOSE)**, **PLAYXCHANGE** or **DISC (1, 2, 3, 4, 5)** to close the disc tray automatically.

General operation

Unless stated otherwise, all operations described here are carried out using the supplied remote control.

Pausing playback

- 1 During playback, press **PAUSE (II)**.
→ Playback is paused and the sound is muted.
- 2 Press **PAUSE (II)** again to select the next picture frame.
- 3 To resume normal playback, press **PLAY (▶)**.

TIPS: The operating features described here might not be possible for certain discs. Always refer to the instructions supplied with the disc.

Selecting a track/chapter

- Press **◀◀ / ▶▶** or use the **numeric buttons (0-9)** to select a track/chapter number.
- During repeated playback of a track/chapter, press **◀◀ / ▶▶** to replay the same track/chapter.

Searching backward/forward

- 1 Press and hold **◀◀ / ▶▶** or press **◀ / ▶**.
- 2 While searching, press **◀◀ / ▶▶** or **◀ / ▶** repeatedly to select the desired speed.
- 3 To resume normal playback, press **PLAY (▶)**.

Notes:

- **◀ / ▶** key may not be available with some discs.
- For MP3 and WMA, the search function allows you to search the track currently being played.

Stopping playback

- Press **STOP (■)**.

Selecting the various repeat/shuffle functions

Repeat

Repeating chapter/title/disc (DVD)

Each time you press **REPEAT**, the display changes as follows:

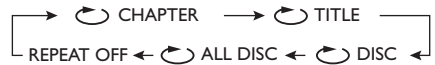

CHAPTER*: repeats the current chapter

TITLE: repeats the current title

DISC*: repeats the entire disc

ALL DISC*: repeats all discs loaded in the tray

REPEAT OFF: exits from the repeat mode

* This feature may not be available with some discs.

Repeating track/disc (except DVD)

Each time you press **REPEAT**, the display changes as follows;



TRACK: repeats the current track

DISC: repeats the entire disc

ALL DISC: repeats all discs loaded in the tray

REPEAT OFF: exits from the repeat mode

Notes:

- When only one disc is available in the disc tray, it is continuously played when **ALL DISC** is selected.
- For VCD, repeat playback is not available when the PBC mode is selected.

TIPS: The operating features described here might not be possible for certain discs. Always refer to the instructions supplied with the disc.

Disc Operations

Repeating a section within a chapter/track

- 1 While playing a disc, press **A-B** at the desired starting point.
- 2 Press **A-B** again at the desired end point.
 - A and B can only be set within the same chapter/track.
 - The selected section repeats continuously.
- 3 To exit from the sequence, press **A-B**.

Shuffle (except DVD/VCD/SVCD)

With the shuffle function, you can play tracks in a random order.

- 1 During playback, press **SHUFFLE** repeatedly to select between SHUFFLE DISC, SHUFFLE ALL DISC, and SHUFFLE OFF.
 - The selected mode appears in the front panel display for several seconds.
 - In the SHUFFLE DISC mode, all tracks on the disc currently playing are played in a random order.
 - In the SHUFFLE ALL DISC mode, tracks from all discs are played in a random order:
 - If the disc currently playing is a CD, only tracks from CDs will be played.
 - If the disc currently playing is formatted in MP3 or WMA, tracks on the disc currently playing are played in a random order. When all the tracks on that disc have been played, shuffle playback continues with the next disc.

Operations for video playback (DVD/VCD/SVCD)

Using the disc menu

Depending on the disc, a menu may appear on the TV screen once you load the disc.

To select a playback feature or item

- Use **◀/▶/▲/▼** or the **numeric buttons (0-9)** on the remote control, and then press **ENTER/OK** to start playback.

To access or exit from the menu

- Press **MENU** on the remote control.

Slow motion

You can play back in slow motion.

- 1 Press **▲** for reverse slow motion or **▼** for forward slow motion.
- 2 During slow motion, press **▲/▼** repeatedly to select the desired speed.
- 3 To resume normal playback, press **PLAY (▶)**.

Note:

- Reverse slow motion is not available for VCDs and SVCDs.

TIPS: The operating features described here might not be possible for certain discs. Always refer to the instructions supplied with the disc.

Zooming in

This function allows you to enlarge or lessen the picture on the TV screen and pan through the enlarged picture.

- 1 During playback, press **ZOOM** repeatedly to display the picture at different scales.
 - Use ◀/▶/▲/▼ to pan through the enlarged picture.
 - Playback continues.
- 2 Press **ZOOM** repeatedly to return to the original size.

Resuming playback from the last stopped point

You can resume playback of the last 10 discs, even if the discs were ejected or the power of this unit was turned off.

- 1 Load one of the last 10 discs.
 - “LOADING #” (#: the disc tray number (1-5)) appears on the TV screen.
- 2 Press **PLAY** (▶) while “LOADING #” is displayed on the TV screen.
 - “RESUME PLAY” appears on the TV screen and the disc is played back from the last point.

To cancel the resume mode

- When playback is stopped, press **STOP** (■) again.

On-screen display (OSD)

The OSD menu shows disc playback information (e.g., the title or chapter number, elapsed playing time or audio/subtitle language). A number of operations are possible without interrupting disc playback.

- 1 During playback, press **ON SCREEN**.
 - A list of available disc information appears on the TV screen.

DVD

MENU	
TITLE	02/14
CHAPTER	02/14
AUDIO	5.1CH
SUBTITLE	ENG
BITRATE 16 TITLE ELAPSED 0:02:25	

VCD/SVCD

MENU	
TRACK	02/14
DISC TIME	0:49:17
TRACK TIME	0:03:43
REPEAT	OFF
BITRATE 16 TOTAL ELAPSED 0:02:25	

- 2 Press ▲/▼ to view the information, and then press **ENTER/OK** to access the selected item.
- 3 Use the **numeric buttons (0-9)** to input the number/time or press ▲/▼ to make a selection, and then press **ENTER/OK** to confirm the selection.
 - Playback changes to the selected time or to the selected title/chapter/track.

TIPS: The operating features described here might not be possible for certain discs. Always refer to the instructions supplied with the disc.

Disc Operations

Title/Chapter/Track selection (DVD/VCD)

- 1 Press **▲/▼** to select [TITLE] or [CHAPTER] (DVD) or [TRACK] (VCD).
- 2 Press **ENTER/OK** to confirm the selection.
- 3 Select a title, chapter or track number using the **numeric buttons (0-9)**.

Time search (DVD/VCD)

- 1 Press **▲/▼** to select [TT TIME] or [CH TIME] (DVD) or [TRACK TIME] or [DISC TIME] (VCD).
 - [TT TIME] refers to the total time of the current title, and [CH TIME] refers to the total time of the current chapter.
- 2 Press **ENTER/OK** to confirm the selection.
- 3 Enter hours, minutes and seconds from left to right using the **numeric buttons (0-9)** (e.g. 0:34:27).

Audio/Subtitle/Angle (DVD)

You can change [AUDIO], [SUBTITLE] or [ANGLE] if these functions are available on the disc you are playing.

- 1 Press **▲/▼** to select [AUDIO], [SUBTITLE] or [ANGLE].
- 2 Press **ENTER/OK** to confirm the selection.
- 3 For Audio and Subtitle:
Press **▲/▼** to highlight your selection, and then press **ENTER/OK**.

OR

For Angle:

Select an angle using the **numeric buttons (0-9)**.

Repeat/Time display (DVD/VCD)

- 1 Press **▲/▼** to select [REPEAT] or [TIME DISP].
- 2 Press **ENTER/OK** to confirm the selection.
- 3 Press **▲/▼** to highlight your selection, and then press **ENTER/OK**.

Time display (CD)

Each time you press **ON SCREEN**, the time display changes as follows:

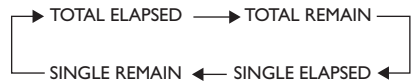

Special DVD features

Playing by title

- 1 Press **MENU**.
→ The disc title menu appears on the TV screen.
- 2 Use **◀/▶/▲/▼** or the **numeric buttons (0-9)** to select a playback option.
- 3 Press **ENTER/OK** to confirm your selection.

Camera angle

- Press **ANGLE** repeatedly to select the desired angle.

TIPS: The operating features described here might not be possible for certain discs. Always refer to the instructions supplied with the disc.

Audio

Changing the audio language and/or format

- Press **AUDIO** repeatedly to select an audio language.

Subtitles

- Press **SUBTITLE** repeatedly to select a subtitle language.

Special VCD & SVCD features

Playback control (PBC)

For VCD with playback control (PBC) feature (version 2.0 only)

- 1 Press **MENU** to toggle between “PBC ON” and “PBC OFF”.
→ If you select “PBC ON”, the disc menu (if available) appears on the TV.
- 2 Use **◀◀/▶▶** or the **numeric buttons (0-9)** to select a playback option.
- 3 During playback, press **TOP MENU/RETURN** to return to the menu screen (if PBC is selected).

If you want to skip the index menu and play back a disc directly from the beginning,

- Press **MENU** on the remote control to turn off PBC.

Audio CDs

Playing by discs

- 1 Load a disc.
→ Playback starts automatically.
→ The TV screen displays the current playback status and the number of tracks to select the desired track.
- 2 Playback stops at the end of the disc.
- 3 To stop playback, press **STOP (■)**.

Playing MP3/JPEG/Kodak picture CDs

General operation

- 1 Load a disc.
 - The disc reading time may exceed 30 seconds due to the complexity of the directory/file configuration.
 - The data disc menu appears on the TV screen.
- 2 Playback starts automatically. If not, press **PLAY (▶)**.

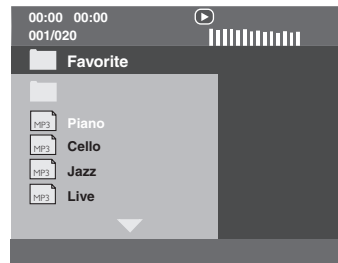

TIPS: The operating features described here might not be possible for certain discs. Always refer to the instructions supplied with the disc.

Disc Operations

During playback, you can:

- Press **◀◀ / ▶▶** to select another track/file in the current folder.
- Press **PAUSE (II)** to pause playback.

Note:

- It may not be possible to play certain MP3/JPEG discs due to the configuration and characteristics of the discs or the recording conditions.

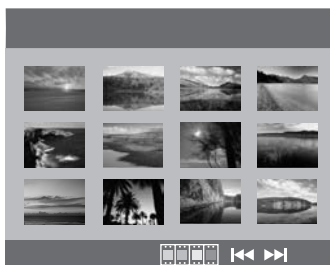

Selecting a folder and track/file

- 1 Press **▲/▼** to select a folder, and then press **ENTER/OK** to open the folder.
- 2 Press **▲/▼** to select a track/file.
- 3 Press **ENTER/OK** to confirm your selection.
→ Playback starts from the selected track/file, and continues to all the tracks/files on all available folders.

Special picture disc features

- 1 Load a picture disc (Kodak Picture CD or JPEG).
→ For Kodak discs, the slideshow begins.
→ For JPEG discs, the picture menu appears on the TV screen.
- 2 Press **PLAY (▶)** to start the slideshow.

Preview function (JPEG)

This function displays the content of the current folder or the entire disc.

- 1 Press **STOP (■)** during playback.
→ 12 thumbnail pictures appear on the TV screen.

- 2 Press **◀◀ / ▶▶** to display the other pictures on the previous/next page.
- 3 Use **◀/▶/▲/▼** to highlight one of the pictures, and then press **ENTER/OK** to start playback.

OR

Move the cursor to highlight  on the bottom of the page to start playback from the first picture on the current page.

- 4 Press **MENU** to return to the picture CD menu.

Zooming pictures

- 1 During playback, press **ZOOM** repeatedly to display the picture at different scales.
- 2 Use **◀/▶/▲/▼** to view the zoomed picture.

Playback with multi-angles

- During playback, press **◀/▶/▲/▼** to rotate the picture on the TV screen.
◀: rotates the picture counter-clockwise
▶: rotates the picture clockwise
▲: flips the picture vertically
▼: flips the picture horizontally

TIPS: The operating features described here might not be possible for certain discs. Always refer to the instructions supplied with the disc.

Scan effect

- Press **ANGLE** repeatedly to choose a scan effect.
- Various scan effects appear in the top left corner of the TV screen.

Playing MP3 music and JPEG pictures simultaneously

- 1 Load a disc that contains both music and picture data.
→ The disc menu appears on the TV screen.
- 2 Select an MP3 track.
- 3 During MP3 music playback, select a picture from the TV screen, and then press **PLAY (▶)**.
→ The picture files are played back one after another, and playback continues to all the files on all available folders.
- 4 To quit simultaneous playback, press **MENU**, and then press **STOP (■)**.

Note:

- *Some files on Kodak or JPEG discs may be distorted during playback due to the configuration and characteristics of the discs.*

TIPS: The operating features described here might not be possible for certain discs. Always refer to the instructions supplied with the disc.

Setup Menu

Setup is carried out on the TV screen, enabling you to customize this unit to suit your own particular requirements.

General setup menu

- 1 Press **SETUP**.
- 2 Press **◀/▶** to select the “General Setup” icon.
- 3 Press **ENTER/OK** to confirm your selection.

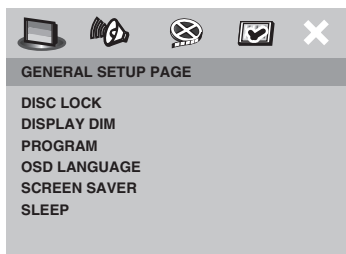

Locking/Unlocking the disc for viewing

Not all discs are rated or coded by the manufacturer of the disc. You can prevent playback of a specific disc by locking the disc. You can lock up to 40 discs on this unit.

- 1 In “GENERAL SETUP PAGE”, press **▲/▼** to highlight [DISC LOCK], and then press **▶**.

LOCK

Select this to lock playback of the current disc. Subsequent access to a locked disc requires a six-digit password. The default password is “000 000” (see “Changing the password” on page 29).

UNLOCK

Select this to unlock the disc and allow future playback.

- 2 Press **▲/▼** to select a setting, and then press **ENTER/OK** to confirm your selection.

Dimming the front panel display

You can select different levels of brightness for the front panel display.

- 1 In “GENERAL SETUP PAGE”, press **▲/▼** to highlight [DISPLAY DIM], and then press **▶**.

100%

Select this for full brightness.

70%

Select this for medium brightness.

40%

Select this for dimming display.

- 2 Press **▲/▼** to select a setting, and then press **ENTER/OK** to confirm your selection.

Programming disc tracks and discs

Program: Track (except picture CD/MP3/WMA)

You can play back the contents of a disc in the desired order by programming the tracks to be played. You can store up to 20 tracks per disc with a maximum of 10 discs.

- 1 In “GENERAL SETUP PAGE”, press **▲/▼** to highlight [PROGRAM], and then press **▶** to select [FTS].

TIPS: To return to the previous menu, press **◀**.
To exit from the menu, press **SETUP**.

- 2 Press **ENTER/OK** to confirm your selection.

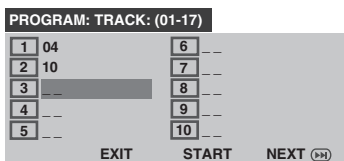

To input your favorite tracks/chapters

- 3 Use the **numeric buttons (0-9)** to enter a valid track/chapter number.
- 4 Use **◀/▶/▲/▼** to move the cursor to the next position.
 - If you want to program more than ten tracks/chapters, press **▶▶|** to move to the next page, and then proceed with programming.

OR

- Use **◀/▶/▲/▼** to highlight **[NEXT]** on the program menu, and then press **ENTER/OK**.
- 5 Repeat step 3 to input another track/chapter number.

To remove a track

- 6 Use **◀/▶/▲/▼** to move the cursor to the track you want to remove.
- 7 Press **ENTER/OK** or **0** on the **numeric buttons (0-9)** to remove the track from the program menu.

Program: Disc

You can play back discs in the desired order by programming the discs to be played. You can store up to 5 discs.

- 1 In "GENERAL SETUP PAGE", press **▲/▼** to highlight **[PROGRAM]**, and then press **▶** to select **[FDS]**.
- 2 Press **ENTER/OK** to confirm your selection.



To input your favorite discs

- 3 Use the **numeric buttons (0-9)** to enter a valid disc number.
- 4 Use **◀/▶/▲/▼** to move the cursor to the next position.
- 5 Repeat steps 3–4 to input another disc number.

To remove a disc

- 6 Use **◀/▶/▲/▼** to move the cursor to the disc you want to remove.
- 7 Press **0** on the **numeric buttons (0-9)** to remove the disc from the program menu.

TIPS: To return to the previous menu, press **◀**.
 To exit from the menu, press **SETUP**.

Setup Menu

To start program playback

- Use ◀/▶/▲/▼ to highlight [START] on the program menu, and then press **ENTER/OK**.
- Playback starts for the selected tracks or discs in the programmed sequence.

To exit from program playback

- Use ◀/▶/▲/▼ to highlight [EXIT] on the program menu, and then press **ENTER/OK**.

OSD language

This menu contains various options for the on-screen display (OSD) language. For details, see “Setting the OSD language” on page 11.

Screen saver

Use this feature to turn on or off the screen saver.

- 1 In “GENERAL SETUP PAGE”, press ▲/▼ to highlight [SCREEN SAVER], and then press ▶.

ON

Select this if you wish to turn on the screen saver when disc playback is stopped or paused for more than 15 minutes.

OFF

Select this to disable the screen saver function.

- 2 Press ▲/▼ to select a setting, and then press **ENTER/OK** to confirm your selection.

Sleep timer

This feature automatically sets this unit to standby mode after a certain elapsed period.

- 1 In “GENERAL SETUP PAGE”, press ▲/▼ to highlight [SLEEP], and then press ▶.
- 2 Press ▲/▼ to select a setting.
 - You can select from 15, 30, 45 and 60 minutes. Select [OFF] to cancel the sleep timer function.
- 3 Press **ENTER/OK** to confirm your selection.

Audio setup menu

- 1 Press **SETUP**.
- 2 Press ◀/▶ to select the “Audio Setup” icon.
- 3 Press **ENTER/OK** to confirm your selection.

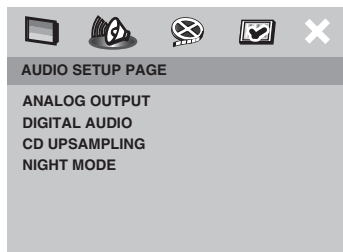

TIPS: To return to the previous menu, press ◀.
To exit from the menu, press **SETUP**.

Setting the analog output

Set the analog output to match the playback capability of this unit.

- 1 In "AUDIO SETUP PAGE", press ▲/▼ to highlight [ANALOG OUTPUT], and then press ►.

STEREO

Select this to change the channel output to stereo, which only delivers sound from the two front speakers.

LT/RT

Select this if this unit is connected to a Dolby Pro Logic decoder.

- 2 Press ▲/▼ to select a setting, and then press **ENTER/OK** to confirm your selection.

Setting the digital output

The [DIGITAL AUDIO] options are: "DIGITAL OUTPUT" and "LPCM OUTPUT".

- 1 In "AUDIO SETUP PAGE", press ▲/▼ to highlight [DIGITAL AUDIO], and then press ►.
- 2 Press ▲/▼ to highlight an option.
- 3 Press ► to enter a submenu.

DIGITAL OUTPUT

Set the digital output according to your optional audio component connections.

OFF

Select this to turn off the digital output.

ALL

Select this if you have connected the digital audio output jack to a multi-channel decoder/receiver.

PCM ONLY

Select this only if your receiver is not capable of decoding multi-channel audio signals.

Note:

- If your receiver cannot decode DTS, no sound output from DTS signals in any mode.

LPCM OUTPUT

Select this if you have connected this unit to a PCM-compatible receiver via a digital terminal, such as the coaxial terminal. In this case, you may need to adjust "LPCM OUTPUT".

Discs are recorded at a certain sampling rate. The higher the sampling rate, the better the sound quality.

48KHz

Select this to play back discs recorded at the sampling rate of 48 kHz. All 96 kHz PCM data streams (if available) are converted to the sampling rate of 48 kHz.

96KHz

Select this to play back discs recorded at the sampling rate of 96 kHz. If the 96 kHz disc is copy protected, the digital output is automatically converted to the sampling rate of 48 kHz.

- 4 Press ▲/▼ to select a setting, and then press **ENTER/OK** to confirm your selection.

TIPS: To return to the previous menu, press ◀.
To exit from the menu, press **SETUP**.

Setup Menu

CD upsampling

Use this feature to convert your music CD to a higher sampling rate using sophisticated digital signal processing for better sound quality. If you activate the upsampling function, this unit automatically switches to the stereo mode.

- 1 In "AUDIO SETUP PAGE", press ▲/▼ to highlight [CD UPSAMPLING], and then press ►.

OFF

Select this to disable CD-upsampling.

88.2kHz (X2)

Select this to convert the sampling rate of CDs to twice that of the original.

176.4kHz (X4)

Select this to convert the sampling rate of CDs to four times that of the original.

- 2 Press ▲/▼ to select a setting, and then press **ENTER/OK** to confirm your selection.

Note:

- This setting is only valid for signals output at the analog jacks.

Night mode

In the night mode, high volume output is softened and low volume output is brought upward to an audible level. It is useful when you watch your favorite action movie without disturbing others at night.

- 1 In "AUDIO SETUP PAGE", press ▲/▼ to highlight [NIGHT MODE], and then press ►.

ON

Select this to level out the volume. This feature is only available for movies with the Dolby Digital mode.

OFF

Select this when you want to enjoy the full dynamic range of surround sound.

- 2 Press ▲/▼ to select a setting, and then press **ENTER/OK** to confirm your selection.

Video setup menu

- 1 Press **SETUP**.
- 2 Press ◀/▶ to select the "Video Setup" icon.
- 3 Press **ENTER/OK** to confirm your selection.

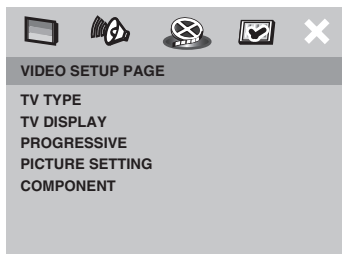

TV type

Use this feature to select a color system that matches your TV. For details, see "Setting a TV type and display" on page 9.

TIPS: To return to the previous menu, press ◀.
To exit from the menu, press **SETUP**.

Setting the TV display

Set the aspect ratio of this unit to match your TV. The format you select must be available on the disc. Otherwise, the TV display setting will not affect the picture during playback.

- In "VIDEO SETUP PAGE", press ▲/▼ to highlight [TV DISPLAY], and then press ►.
- Press ▲/▼ to highlight one of the following options.

4:3 PAN SCAN

Select this if the aspect ratio of your TV is 4:3 and you want both sides of the picture to be trimmed or formatted to fit your TV screen.

4:3 LETTER BOX

Select this if the aspect ratio of your TV is 4:3. In this case, a wide picture with black bands on the upper and lower portions of the TV screen are displayed.





16:9

Select this if you have a widescreen TV.



- Select an item, and then press **ENTER/OK** to confirm your selection.

The relationship between the setting of this unit and the TV display

When the aspect ratio of your TV is 4:3:

Setting	Playback disc	TV display	
4:3 PAN SCAN	16:9		*1
	4:3		
4:3 LETTER BOX	16:9		
	4:3		

When the aspect ratio of your TV is 16:9 (widescreen):

Setting	Playback disc	TV display	
16:9	16:9		
	4:3		*2

*1: If the disc is not assigned to playback with panscan, it is played with letterbox.

*2: The side of the picture may be stretched depending on the TV. In this case, check the screen size and aspect ratio of your TV.

TIPS: To return to the previous menu, press ◀.
To exit from the menu, press **SETUP**.

Setup Menu

Progressive

This feature is only valid if you have connected this unit to a progressive scan TV through the component video jacks (see “Component video jacks ” on page 7).

- 1 In “VIDEO SETUP PAGE”, press ▲/▼ to highlight [PROGRESSIVE], and then press ►.

ON

Select this to enable the progressive scan function.

OFF

Select this to disable the progressive scan function.

- 2 Press ▲/▼ to select a setting, and then press **ENTER/OK** to confirm your selection.

Notes on activating progressive scan:

- Ensure that your TV is equipped with progressive scan.
- Connect using a component video cable.
- Ensure that “COMPONENT is set to “YUV” (see “Switching the YUV/RGB” on page 27).
- When the progressive scan is active, the VIDEO (CVBS) jack and the AV (SCART) terminal do not output video signals.
- If no picture is displayed, wait for 15 seconds for this unit to activate automatic recovery, or deactivate progressive scan manually as follows:
 - 1 Press **▲ (OPEN/CLOSE)** on the front panel to open the disc tray.
 - 2 Press **◀**.
 - 3 Press **ANGLE**.

CONSUMERS SHOULD NOTE THAT NOT ALL HIGH DEFINITION TELEVISION SETS ARE FULLY COMPATIBLE WITH THIS PRODUCT AND MAY CAUSE ARTIFACTS TO BE DISPLAYED IN THE PICTURE. IN CASE OF 525 OR 625 PROGRESSIVE SCAN PICTURE PROBLEMS, IT IS RECOMMENDED THAT THE USER SWITCH THE CONNECTION TO THE “STANDARD DEFINITION” OUTPUT. IF THERE ARE QUESTIONS REGARDING OUR VIDEO MONITOR COMPATIBILITY WITH THIS MODEL 525P AND 625P DVD PLAYER, PLEASE CONTACT OUR CUSTOMER SERVICE CENTER.

This unit is compatible with the complete line of YAMAHA products, including the projectors DPX-1300, DPX-830 and the plasma monitor PDM-4220.

Picture settings

This unit comes with three predefined sets of picture color settings and one personal setting that you can define yourself.

- 1 In “VIDEO SETUP PAGE”, press ▲/▼ to highlight [PICTURE SETTING], and then press ►.

STANDARD

Select this for the standard picture setting.

BRIGHT

Select this to make the TV picture brighter.

SOFT

Select this to make the TV picture softer.

PERSONAL

Select this to personalize your picture color by adjusting the brightness, contrast, tint and color (saturation).

- 2 Press ▲/▼ to select a setting, and then press **ENTER/OK** to confirm your selection.

TIPS: To return to the previous menu, press **◀**.
To exit from the menu, press **SETUP**.

- 3 If you selected [PERSONAL] in step 1, proceed to steps 4–7:

→ The “PERSONAL PICTURE SETUP” menu appears.

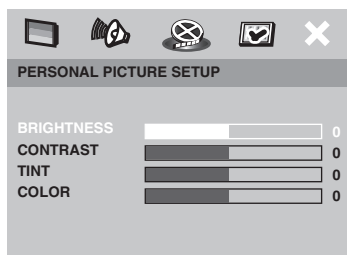

- 4 Press ▲/▼ to select one of the following options.

BRIGHTNESS

Increase the value to brighten the picture or vice versa. Zero (0) is the average brightness setting value.

CONTRAST

Increase the value to sharpen the picture or vice versa. Zero (0) is the average contrast setting value.

TINT

Increase the value to darken the picture or vice versa. Zero (0) is the average tint setting value.

COLOR

Increase the value to enhance the color in your picture or vice versa. Zero (0) is the average color setting value.

- 5 Press ◀/▶ to adjust the setting that best suits your personal preference.
- 6 Repeat steps 4–5 to adjust other color features.
- 7 Press **ENTER/OK** to confirm your selection.

Switching the YUV/RGB

Use this feature to toggle the video signal output between YUV (Y P_B P_R) and RGB (on SCART).

- 1 In “VIDEO SETUP PAGE”, press ▲/▼ to highlight [COMPONENT], and then press ▶.

YUV

Select this for the component video connection.

RGB

Select this for SCART connection.

- 2 Press ▲/▼ to select a setting, and then press **ENTER/OK** to confirm your selection.

Preference setup menu

- 1 Press **STOP** (■) twice to stop playback (if necessary), and then press **SETUP**.
- 2 Press ◀/▶ to select the “Preference Setup” icon.
- 3 Press **ENTER/OK** to confirm your selection.

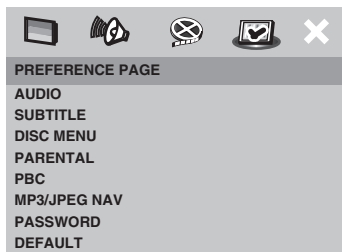

TIPS: To return to the previous menu, press ◀.
To exit from the menu, press **SETUP**.

Setup Menu

Audio, subtitle and disc menu

These menus contain various language options for the audio, subtitles and disc menus recorded on the DVD. For details, see “Setting the audio, subtitle and disc menu languages” on page 11.

Restricting playback with parental control

Some DVDs may have a parental level assigned to the complete disc or to certain scenes on the disc. This feature lets you set a playback limitation level.

The rating levels are from 1 to 8 and are country dependent. You can prohibit playback of certain discs that are not suitable for your children or play certain discs in alternative scenes.

- 1 In “PREFERENCE PAGE”, press ▲/▼ to highlight [PARENTAL], and then press ►.

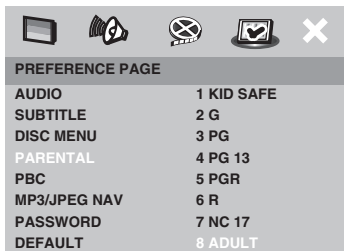

- 2 Press ▲/▼ to highlight a rating level for the inserted disc, and then press **ENTER/OK** to confirm your selection.
 - To disable parental controls and have all discs play, select [8 ADULT].

- 3 Use the **numeric buttons (0-9)** to enter the six-digit password (see “Changing the password” on page 29).

→ DVDs that are rated above the level you selected do not play unless you enter the six-digit password.

Notes:

- VCD, SVCD, and CD have no level indication, so the parental control function has no effect with these types of discs. This also applies to most illegal DVD discs.
- Some DVDs are not encoded with a rating though the movie rating may be printed on the disc cover. The rating level feature does not work for such discs.

PBC (Playback control)

You can turn on or off PBC. This feature is available only on Video CD 2.0 with the playback control (PBC) feature. For details, see “Playback control (PBC)” on page 17.

MP3/JPEG menu

MP3/JPEG Navigator can be set only if the disc was recorded with a menu. It allows you to select different display menus for easy navigation.

- 1 In “PREFERENCE PAGE”, press ▲/▼ to highlight [MP3/JPEG NAV], and then press ►.

TIPS: To return to the previous menu, press ◀.
To exit from the menu, press **SETUP**.

WITH MENU

Select this to display only the folder menu of the MP3/Picture CD.

WITHOUT MENU

Select this to display all the files contained in the MP3/Picture CD.

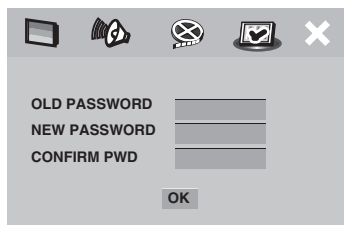

- 2 Press ▲/▼ to select a setting, and then press **ENTER/OK** to confirm your selection.

Changing the password

The same password is used for both Parental Control and Disc Lock. Enter your six-digit password when prompted on the screen. The default password is 000 000.

- 1 In "PREFERENCE PAGE", press ▲/▼ to highlight [PASSWORD], and then press ► to select [CHANGE].

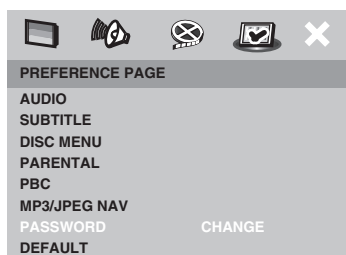

- 2 Press **ENTER/OK** to enter the "Password Change Page".

- 3 Use the **numeric buttons (0-9)** to enter your old six-digit password.
 - When doing this for the first time, enter "000 000".
 - If you forgot your old six-digit password, enter "000 000".
- 4 Enter the new six-digit password.
- 5 Enter the new six-digit password again to confirm the password.
 - ➔ The new six-digit password is now valid.
- 6 Press **ENTER/OK** to confirm your new password.

Resetting the system

Setting the DEFAULT function resets all options and your personal settings to the initial factory settings, except your password for PARENTAL and DISC LOCK.

- 1 In "PREFERENCE PAGE", press ▲/▼ to highlight [DEFAULT], and then press ► to select [RESET].
- 2 Press **ENTER/OK** to confirm your selection.
 - ➔ All settings are reset to the initial factory settings.

TIPS: To return to the previous menu, press ◀.
To exit from the menu, press **SETUP**.

Language Code

These codes can be used to select other languages. This does not affect the options in “AUDIO”, “SUBTITLE” or “DISC MENU”.

Abkhazian	6566	German	6869
Afar	6565	Gikuyu; Kikuyu	7573
Afrikaans	6570	Greek,	6976
Albanian	8381	Guarani	7178
Amharic	6577	Gujarati	7185
Arabic	6582	Hausa	7265
Armenian	7289	Hebrew	7269
Assamese	6583	Herero	7290
Avestan	6569	Hindi	7273
Aymara	6589	Hiri Motu	7279
Azerbaijani	6590	Hungarian	7285
Bashkir	6665	Icelandic	7383
Basque	6985	Ido	7379
Belarusian	6669	Indonesian	7368
Bengali	6678	Interlingua (International)	7365
Bihari	6672	Interlingue	7369
Bislama	6673	Inuktitut	7385
Bokmål, Norwegian	7866	Inupiaq	7375
Bosnian	6683	Irish	7165
Breton	6682	Italian	7384
Bulgarian	6671	Japanese	7465
Burmese	7789	Javanese	7486
Castilian, Spanish	6983	Kalaallisut	7576
Catalan	6765	Kannada	7578
Chamorro	6772	Kashmiri	7583
Chechen	6769	Kazakh	7575
Chewa; Chichewa; Nyanja	7889	Khmer	7577
Chichewa; Chewa; Nyanja	7889	Kikuyu; Gikuyu	7573
Chinese	9072	Kinyarwanda	8287
Chuang; Zhuang	9065	Kirghiz	7589
Church Slav; Slavonic;	6785	Komi	7586
Church Slavonic; Church	6785	Korean	7579
Chuvash	6786	Kuanyama; Kwanyama	7574
Cornish	7587	Kurdish	7585
Corsican	6779	Kwanyama; Kuanyama	7574
Croatian	7282	Lao	7679
Czech	6783	Latin	7665
Danish	6865	Latvian	7686
Dutch	7876	Letzeburgesch;	7666
Dzongkha	6890	Limburgan; Limburger;	7673
English	6978	Limburger; Limburgan;	7673
Esperanto	6979	Limburgish; Limburger;	7673
Estonian	6984	Lingala	7678
Faroese	7079	Lithuanian	7684
Fijian	7074	Luxembourgish;	7666
Finnish	7073	Macedonian	7775
French	7082	Malagasy	7771
Frisian	7089	Malay	7783
Gaelic; Scottish Gaelic	7168	Malayalam	7776
Gallegan	7176	Maltese	7784
Georgian	7565	Manx	7186

These codes can be used to select other languages. This does not affect the options in “AUDIO”, “SUBTITLE” or “DISC MENU”.

Maori	7773	Sotho, Southern	8384
Marathi	7782	South Ndebele	7882
Marshallese	7772	Spanish; Castilian	6983
Moldavian	7779	Sundanese	8385
Mongolian	7778	Swahili	8387
Nauru	7865	Swati	8383
Navaho, Navajo	7886	Swedish	8386
Navajo; Navaho	7886	Tagalog	8476
Ndebele, North	7868	Tahitian	8489
Ndebele, South	7882	Tajik	8471
Ndonga	7871	Tamil	8465
Nepali	7869	Tatar	8484
Northern Sami	8369	Telugu	8469
North Ndebele	7868	Thai	8472
Norwegian	7879	Tibetan	6679
Norwegian Bokmål; Bokmål,	7866	Tigrinya	8473
Norwegian Nynorsk;	7878	Tonga (Tonga Islands)	8479
Nyanja; Chichewa; Chewa	7889	Tsonga	8483
Nynorsk, Norwegian;	7878	Tswana	8478
Occitan (post 1500); Proven	7967	Turkish	8482
Old Bulgarian; Old Slavonic;	6785	Turkmen	8475
Old Church Slavonic; Old	6785	Twi	8487
Old Slavonic; Church	6785	Uighur	8571
Oriya	7982	Ukrainian	8575
Oromo	7977	Urdu	8582
Ossetian; Ossetic	7983	Uzbek	8590
Ossetic; Ossetian	7983	Vietnamese	8673
Pali	8073	Volapük	8679
Panjabi	8065	Walloon	8765
Persian	7065	Welsh	6789
Polish	8076	Wolof	8779
Portuguese	8084	Xhosa	8872
Provençal; Occitan (post)	7967	Yiddish	8973
Pushto	8083	Yoruba	8979
Quechua	8185	Zhuang; Chuang	9065
Raeto-Romance	8277	Zulu	9085
Romanian	8279		
Rundi	8278		
Russian	8285		
Samoan	8377		
Sango	8371		
Sanskrit	8365		
Sardinian	8367		
Scottish Gaelic; Gaelic	7168		
Serbian	8382		
Shona	8378		
Sindhi	8368		
Sinhalese	8373		
Slovak	8375		
Slovenian	8376		
Somali	8379		

Troubleshooting

Refer to the chart below when this unit does not function properly. If the problem you are experiencing is not listed below or if the instruction below does not help, set this unit to the standby mode, disconnect the power cord, and contact the nearest authorized YAMAHA dealer or service center.

Problem	Solution
No power	<ul style="list-style-type: none">– Check if the AC power cord is properly connected.– Press STANDBY/ON on the front panel of this unit to turn on the power.
No picture	<ul style="list-style-type: none">– Refer to the manual supplied with your TV for correct Video In channel selection. Change the TV channel until you see the DVD screen.– Check if the TV is turned on.– Make sure the video signal output setting of this unit matches the video connection (see “Switching the YUV/RGB” on page 27).– If you do not use progressive scan connections (using the component video (Y P_B P_R) jacks of this unit) and no picture is displayed on the TV, follow the steps below to turn off the progressive scan:<ol style="list-style-type: none">1. Press ▲ (OPEN/CLOSE) on the front panel to open the disc tray.2. Press ◀ on the remote control.3. Press ANGLE on the remote control to deactivate progressive scan. This unit is set to Component/Interlaced video.
Distorted picture	<ul style="list-style-type: none">– Occasionally, a small amount of picture distortion may appear depending on the disc being played back. This is not a malfunction.
Completely distorted picture or black/white picture with DVD	<ul style="list-style-type: none">– Make sure the disc is compatible with this unit (see “Notes on discs” on page 2).– Ensure that the TV type of this unit is set to match that of the disc and your TV (see “Setting a color system for your TV” on page 9).
The screen size looks unnatural, or the caption is displayed only partially on the TV monitor or is not displayed at all	<ul style="list-style-type: none">– Make sure the TV setting of this unit matches the screen size of your TV (see “Setting the TV display” on page 25).– Change the screen size and the aspect ratio of your TV.
No sound or distorted sound	<ul style="list-style-type: none">– Adjust the volume.– Check that the speakers are connected correctly.

Problem	Solution
No audio at digital output	<ul style="list-style-type: none"> – Check the digital connections. – If you are playing a DTS source, check that your receiver can decode DTS and “DIGITAL OUTPUT” is set to “ALL” (see page 23). – If you are playing an MPEG-2 source, check that your receiver can decode MPEG-2. Otherwise, make sure “DIGITAL OUTPUT” is set to “PCM ONLY” (see page 23). – Check if the audio format of the selected audio language matches your receiver capabilities.
Disc does not play	<ul style="list-style-type: none"> – The DVD+R/RW, DVD-R/RW, CD-R/RW must be finalized. – Ensure the disc label is facing up. – Check if the disc is defective by trying another disc. – If you have recorded a picture CD or MP3 CD yourself, ensure that your disc contains at least 10 pictures or 5 MP3 tracks. – Region code is incorrect (see “Region codes” on page 2).
Picture freezes momentarily during playback	<ul style="list-style-type: none"> – Check the disc for fingerprints/scratches and clean it with a soft cloth wiping from center to edge.
This unit does not respond to the remote control	<ul style="list-style-type: none"> – Aim the remote control directly at the remote control sensor on the front panel of this unit. – Reduce the distance of the remote control from this unit. – Replace the batteries in the remote control. – Reinsert the batteries with their polarities (+/– signs) as indicated.
Buttons do not work	<ul style="list-style-type: none"> – To completely reset this unit, unplug the AC cord from the AC outlet for 5-10 seconds.
This unit does not respond to some operating commands during playback	<ul style="list-style-type: none"> – Operations may not be permitted by the disc. Refer to the instructions of the disc jacket.
This unit cannot read CDs/ DVDs	<ul style="list-style-type: none"> – Use a commonly available CD/DVD lens cleaner to clean the lens before sending this unit for repair.
Menu items cannot be selected	<ul style="list-style-type: none"> – Press STOP (■) twice on the remote control before selecting Setup Menu. – Depending on the disc availability, some menu items cannot be selected.
Unable to turn on or off a progressive scan	<ul style="list-style-type: none"> – Check that the video signal output is switch to “YUV” (see “Switching the YUV/RGB” on page 27).

Glossary

Analog: Sound that has not been turned into numbers. Analog sound varies, while digital sound has specific numerical values. These jacks send audio through two channels, the left and right.

Aspect ratio: The ratio of vertical and horizontal sizes of a displayed image. The horizontal vs. vertical ratio of conventional TVs. is 4:3, and that of widescreens is 16:9.

AUDIO OUT Jacks: Jacks on the back of this unit that send audio to another system (TV, Stereo, etc.).

Bit Rate: The amount of data used to hold a given length of music; measured in kilobits per seconds, or kbps. Or, the speed at which you record. Generally, the higher the bit rate, or the higher the recording speed, the better the sound quality. However, higher bit rates use more space on a Disc.

Chapter: Sections of a picture or a music piece on a DVD that are smaller than titles. A title is composed of several chapters. Each chapter is assigned a chapter number enabling you to locate the chapter you want.

Component Video Out Jacks: Jacks on the back of this unit that send high-quality video to a TV that has Component Video In jacks (R/G/B, Y/Pb/Pr, etc.).

Disc menu: A screen display prepared for allowing selection of images, sounds, subtitles, multi-angles, etc. recorded on a DVD.

Digital: Sound that has been converted into numerical values. Digital sound is available when you use the digital audio output jacks. These jacks send audio through multiple channels, instead of just two channels as analog does.

Dolby Digital: A surround sound system developed by Dolby Laboratories containing up to six channels of digital audio (front left and right, surround left and right, center and subwoofer).

DTS: Digital Theatre Systems. This is a surround sound system, but it is different from Dolby Digital. The formats were developed by different companies.

JPEG: A very common digital still picture format. A still-picture data compression system proposed by the Joint Photographic Expert Group, which features small decrease in image quality in spite of its high compression ratio.

MP3: A file format with a sound data compression system. "MP3" is the abbreviation of Motion Picture Experts Group 1 (or MPEG-1) Audio Layer 3. By using MP3 format, one CD-R or CD-RW can contain about 10 times as much data volume as a regular CD can.

Parental Control: A function of the DVD to limit playback of the disc by the age of the users according to the limitation level in each country. The limitation varies from disc to disc; when it is activated, playback will be prohibited if the level of the software is higher than the user-set level.

PCM (Pulse Code Modulation): A system for converting analog sound signal to digital signal for later processing, with no data compression used in conversion.

Playback control (PBC): Refers to the signal recorded on video CDs or SVCDs for controlling reproduction. By using menu screens recorded on a Video CD or SVCD that supports PBC, you can enjoy interactive-type software as well as software having a search function.

Progressive scan: It displays all the horizontal lines of a picture at one time, as a signal frame. This system can convert the interlaced video from DVD into progressive format for connection to a progressive display. It dramatically increases the vertical resolution.

Region code: A system for allowing discs to be played back only in the region designated beforehand. This unit only plays discs that have compatible region codes. You can find the region code of your unit by looking on the product label. Some discs are compatible with more than one region (or ALL regions).

S-Video: Produces a clear picture by sending separate signals for the luminance and the color. You can use S-Video only if your TV has S-video In jack.

Surround: A system for creating realistic three dimensional sound fields full of realism by arranging multiple speakers around the listener.

Title: The longest section of a picture or music feature on DVD, music, etc., in video software, or the entire album in audio software. Each title is assigned a title number enabling you to locate the title you want.

VIDEO OUT jack: Jack on the back of this unit that sends video to a TV.

PLAYBACK SYSTEM

DVD-Video
 Video CD & SVCD
 CD
 PICTURE CD
 CD-R, CD-RW
 DVD+R, DVD+RW
 DVD-R, DVD-RW

VIDEO PERFORMANCE

Video (CVBS) output 1 Vpp into 75 ohm
 RGB (SCART) output 0.7 Vpp into 75 ohm
 Component video output Y: 1 Vpp into 75 ohm
 Pb/Cb Pr/Cr: 0.7 Vpp into 75 ohm

AUDIO FORMAT

Digital	Mpeg/Dolby Digital/ DTS	Compressed Digital
	PCM	16, 20, 24 bits fs, 44.1, 48, 96 kHz
	MP3(ISO 9660)	24, 32, 56, 64, 96, 128, 256 kbps fs, 16, 22.05, 24, 32, 44.1, 48 kHz
	WMA	32-192 kbps, mono, stereo
Analog Sound		Stereo

AUDIO PERFORMANCE

DA Converter	24 bit
Signal-Noise (1 kHz)	115 dB
Dynamic range (1 kHz)	100 dB
DVD	fs 96 kHz 2 Hz - 44 kHz fs 48 kHz 2 Hz - 22 kHz
SVCD	fs 48 kHz 2 Hz - 22 kHz fs 44.1 kHz 2 Hz - 20 kHz
CD/VCD	fs 44.1 kHz 2 Hz - 20 kHz
Distortion and Noise (1 kHz)	0.003%

TV STANDARD (PAL/50 Hz) (NTSC/60 Hz)

Number of lines	625	525
Playback	Multistandard	(PAL/NTSC)

CONNECTIONS

SCART	Euroconnector
Y Output	Cinch (green)
Pb/Cb Output	Cinch (blue)
Pr/Cr Output	Cinch (red)
Video Output	Cinch
Audio Output (L+R)	Cinch
Digital Output	1 coaxial
	IEC60958 for CDDA/LPCM
	IEC61937 for MPEG 1/2, Dolby
	Digital and DTS

CABINET

Dimensions (w x d x h)	435 x 425 x 75 mm
Weight	Approx. 5.5 Kg

POWER SUPPLY

Power inlet	230 V, 50 Hz
Power usage	Approx. 15 W
Power usage standby	< 1 W

Specifications are subject to change without prior notice.



©2006 YAMAHA CORPORATION All rights reserved.

YAMAHA ELECTRONICS CORPORATION, USA 6660 ORANGETHORPE AVE., BUENA PARK, CALIF. 90620, U.S.A.

YAMAHA CANADA MUSIC LTD. 135 MILNER AVE., SCARBOROUGH, ONTARIO M1S 3R1, CANADA

YAMAHA ELECTRONIK EUROPA G.m.b.H. SIEMENSSTR. 22-34, 25462 RELINGEN BEI HAMBURG, GERMANY

YAMAHA ELECTRONIQUE FRANCE S.A. RUE AMBROISE CROIZAT BP70 CROISSY-BEAUBOURG 77312 MARNE-LA-VALLÉE CEDEX02, FRANCE

YAMAHA ELECTRONICS (UK) LTD. YAMAHA HOUSE, 200 RICKMANSWORTH ROAD WATFORD, HERTS WD18 7GQ, ENGLAND

YAMAHA SCANDINAVIA A.B. J A WETTERGRENS GÅTA 1, BOX 30053, 400 43 VÄSTRA FRÖLUNDA, SWEDEN

YAMAHA MUSIC AUSTRALIA PTY, LTD. 17-33 MARKET ST., SOUTH MELBOURNE, 3205 VIC., AUSTRALIA

YAMAHA CORPORATION

Printed in China  3139 245 21861