

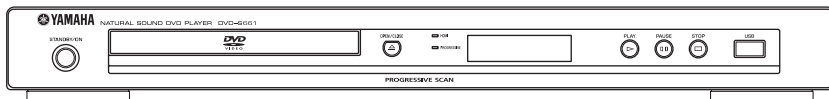

DVD PLAYER  
LECTEUR DE DVD

# DVD-S661

*OWNER'S MANUAL  
MODE D'EMPLOI  
MANUAL DE INSTRUCCIONES*



# IMPORTANT SAFETY INSTRUCTIONS

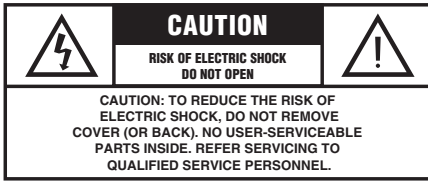

## • Explanation of Graphical Symbols



The lightning flash with arrowhead symbol, within an equilateral triangle, is intended to alert you to the presence of uninsulated "dangerous voltage" within the product's enclosure that may be of sufficient magnitude to constitute a risk of electric shock to persons.



The exclamation point within an equilateral triangle is intended to alert you to the presence of important operating and maintenance (servicing) instructions in the literature accompanying the appliance.

- 1 Read Instructions** — All the safety and operating instructions should be read before the product is operated.
- 2 Retain Instructions** — The safety and operating instructions should be retained for future reference.
- 3 Heed Warnings** — All warnings on the product and in the operating instructions should be adhered to.
- 4 Follow Instructions** — All operating and use instructions should be followed.
- 5 Cleaning** — Unplug this product from the wall outlet before cleaning. Do not use liquid cleaners or aerosol cleaners. Use a damp cloth for cleaning.
- 6 Attachments** — Do not use attachments not recommended by the product manufacturer as they may cause hazards.
- 7 Water and Moisture** — Do not use this product near water — for example, near a bath tub, wash bowl, kitchen sink, or laundry tub; in a wet basement; or near a swimming pool; and the like.
- 8 Accessories** — Do not place this product on an unstable cart, stand, tripod, bracket, or table. The product may fall, causing serious injury to a child or adult, and serious damage to the product. Use only with a cart, stand, tripod, bracket, or table recommended by the manufacturer, or sold with the product.  
Any mounting of the product should follow the manufacturer's instructions, and should use a mounting accessory recommended by the manufacturer.
- 9** A product and cart combination should be moved with care. Quick stops, excessive force, and uneven surfaces may cause the product and cart combination to overturn.
- 10 Ventilation** — Slots and openings in the cabinet are provided for ventilation and to ensure reliable operation of the product and to protect it from overheating, and these openings must not be blocked or covered. The openings should never be blocked by placing the product on a bed, sofa, rug, or other similar surface. This product should not be placed in a built-in installation such as a bookcase or rack unless proper ventilation is provided or the manufacturer's instructions have been adhered to.
- 11 Power Sources** — This product should be operated only from the type of power source indicated on the marking label. If you are not sure of the type of power supply to your home, consult your product dealer or local power company. For products intended to operate from battery power, or other sources, refer to the operating instructions.



- 12 Grounding or Polarization** — This product may be equipped with a polarized alternating current line plug (a plug having one blade wider than the other). This plug will fit into the power outlet only one way. This is a safety feature. If you are unable to insert the plug fully into the outlet, try reversing the plug. If the plug should still fail to fit, contact your electrician to replace your obsolete outlet. Do not defeat the safety purpose of the polarized plug.
- 13 Power-Cord Protection** — Power-supply cords should be routed so that they are not likely to be walked on or pinched by items placed upon or against them, paying particular attention to cords at plugs, convenience receptacles, and the point where they exit from the product.
- 14 Lighting** — For added protection for this product during a lightning storm, or when it is left unattended and unused for long periods of time, unplug it from the wall outlet and disconnect the antenna or cable system. This will prevent damage to the product due to lightning and power-line surges.
- 15 Power Lines** — An outside antenna system should not be located in the vicinity of overhead power lines or other electric light or power circuits, or where it can fall into such power lines or circuits. When installing an outside antenna system, extreme care should be taken to keep from touching such power lines or circuits as contact with them might be fatal.
- 16 Overloading** — Do not overload wall outlets, extension cords, or integral convenience receptacles as this can result in a risk of fire or electric shock.
- 17 Object and Liquid Entry** — Never push objects of any kind into this product through openings as they may touch dangerous voltage points or short-out parts that could result in a fire or electric shock. Never spill liquid of any kind on the product.
- 18 Servicing** — Do not attempt to service this product yourself as opening or removing covers may expose you to dangerous voltage or other hazards. Refer all servicing to qualified service personnel.
- 19 Damage Requiring Service** — Unplug this product from the wall outlet and refer servicing to qualified service personnel under the following conditions:
  - a) When the power-supply cord or plug is damaged,
  - b) If liquid has been spilled, or objects have fallen into the product,
  - c) If the product has been exposed to rain or water,
  - d) If the product does not operate normally by following the operating instructions. Adjust only those controls that are covered by the operating instructions as an improper adjustment of other controls may result in damage and will often require extensive work by a qualified technician to restore the product to its normal operation,
  - e) If the product has been dropped or damaged in any way, and
  - f) When the product exhibits a distinct change in performance - this indicates a need for service.
- 20 Replacement Parts** — When replacement parts are required, be sure the service technician has used replacement parts specified by the manufacturer or have the same characteristics as the original part. Unauthorized substitutions may result in fire, electric shock, or other hazards.
- 21 Safety Check** — Upon completion of any service or repairs to this product, ask the service technician to perform safety checks to determine that the product is in proper operating condition.
- 22 Wall or Ceiling Mounting** — The unit should be mounted to a wall or ceiling only as recommended by the manufacturer.
- 23 Heat** — The product should be situated away from heat sources such as radiators, heat registers, stoves, or other products (including amplifiers) that produce heat.

## FCC INFORMATION (for US customers)

1. **IMPORTANT NOTICE: DO NOT MODIFY THIS UNIT!**

This product, when installed as indicated in the instructions contained in this manual, meets FCC requirements. Modifications not expressly approved by Yamaha may void your authority, granted by the FCC, to use the product.

2. **IMPORTANT:** When connecting this product to accessories and/or another product use only high quality shielded cables.

Cable/s supplied with this product **MUST** be used. Follow all installation instructions. Failure to follow instructions could void your FCC authorization to use this product in the USA.

3. **NOTE:** This product has been tested and found to comply with the requirements listed in FCC Regulations, Part 15 for Class "B" digital devices.

Compliance with these requirements provides a reasonable level of assurance that your use of this product in a residential environment will not result in harmful interference with other electronic devices. This equipment generates/uses radio frequencies and, if not installed and used according to the instructions found in the users manual, may cause interference harmful to the operation of other electronic devices. Compliance with FCC regulations does not guarantee that interference will not occur in all installations. If this product is found to be the source of interference, which can be determined by turning the product "OFF" and "ON", please try to eliminate the problem by using one of the following measures:

Relocate either this product or the device that is being affected by the interference.

Utilize power outlets that are on different branch (circuit breaker or fuse) circuits or install AC line filter/s.

In the case of radio or TV interference, relocate/reorient the antenna. If the antenna lead-in is 300 ohm ribbon lead, change the lead-in to coaxial type cable.

If these corrective measures do not produce satisfactory results, please contact the local retailer authorized to distribute this type of product. If you can not locate the appropriate retailer, please contact Yamaha Electronics Corp., 6660 Orangethorpe Ave. Buena Park, CA90622.

The above statements apply **ONLY** to those products distributed by Yamaha Corporation of America or its subsidiaries.

## We Want You Listening For A Lifetime



Yamaha and the Electronic Industries Association's Consumer Electronics Group want you to get the most out of your equipment by playing it at a safe level. One that lets the sound come through loud and clear without annoying blaring or distortion - and, most importantly, without affecting your sensitive hearing.

Since hearing damage from loud sounds is often undetectable until it is too late, Yamaha and the Electronic Industries Association's Consumer Electronics Group recommend you to avoid prolonged exposure from excessive volume levels.

### For Customer Use:

Read carefully the information located at the rear panel of this unit and enter below the Serial No. Retain this information for future reference.

Model No. \_\_\_\_\_

Serial No. \_\_\_\_\_

### CAUTION

Use of controls or adjustments or performance of procedures other than those specified herein may result in hazardous radiation exposure.

### AVERTISSEMENT

L'utilisation de commandes et l'emploi de réglages ou de méthodes autres que ceux décrits ci-dessous, peuvent entraîner une exposition à un rayonnement dangereux.

### PRECAUCIÓN

El uso de los controles, los ajustes o los procedimientos que no se especifican en este manual pueden causar una exposición peligrosa a la radiación.

CLASS 1 LASER PRODUCT  
LASER KLASSE 1 PRODUKT  
LUOKAN 1 LASERLAITE  
KLASS 1 LASER APPARAT  
PRODUIT LASER DE CLASSE 1

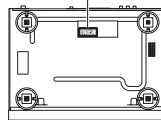

**DANGER:** AVOID DIRECT EXPOSURE TO THE BEAM  
INVISIBLE LASER RADIATION WHEN OPEN  
**CAUTION:** DO NOT STARE INTO BEAM  
INVISIBLE LASER RADIATION WHEN OPEN

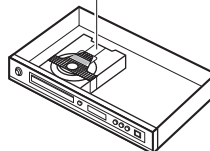

## CAUTION: READ THIS BEFORE OPERATING THIS UNIT.

- 1 To assure the finest performance, please read this manual carefully. Keep it in a safe place for future reference.
- 2 Install this unit in a well ventilated, cool, dry, clean place — away from direct sunlight, heat sources, vibration, dust, moisture, or cold. In a cabinet, allow about 2.5 cm (1 inch) of free space all around this unit for adequate ventilation.
- 3 Locate this unit away from other electrical appliances, motors, or transformers to avoid humming sounds.
- 4 Do not expose this unit to sudden temperature changes from cold to hot, nor locate this unit in an environment with high humidity (i.e., a room with a humidifier) to prevent condensation inside this unit, which may cause an electrical shock, fire, damage to this unit, and/or personal injury.
- 5 Avoid installing this unit in a location where foreign objects may fall onto this unit or where this unit may be exposed to liquid dripping or splashing. On the top of this unit, do not place:
  - Other components, as they may cause damage and/or discoloration on the surface of this unit.
  - Burning objects (i.e., candles), as they may cause fire, damage to this unit, and/or personal injury.
  - Containers with liquid in them, as they may fall, spilling the liquid and causing an electrical shock to the user and/or damage to this unit.
- 6 Do not cover this unit with a newspaper, tablecloth, curtain, etc. in order not to obstruct heat radiation. If the temperature inside this unit rises, it may cause fire, damage to this unit, and/or personal injury.
- 7 Do not plug in this unit to a wall outlet until all connections are complete.
- 8 Do not operate this unit upside-down. It may overheat, possibly causing damage.
- 9 Do not use excessive force on switches, knobs and/or cords.
- 10 When disconnecting the power cord from the wall outlet, grasp the plug; do not pull the cord.
- 11 Do not clean this unit with chemical solvents; this might damage the finish. Use a clean, dry cloth.
- 12 Use only the voltage specified on this unit. Using this unit with a higher voltage than specified is dangerous and may cause fire, damage to this unit, and/or personal injury. Yamaha will not be held responsible for any damage resulting from use of this unit with a voltage other than as specified.
- 13 Do not attempt to modify or fix this unit. Contact qualified Yamaha service personnel when any service is needed. The cabinet should never be opened for any reason.
- 14 When not planning to use this unit for long periods of time (i.e., vacation), disconnect the AC power plug from the wall outlet.
- 15 Be sure to read the “Troubleshooting” section on common operating errors before concluding that this unit is faulty.
- 16 Before moving this unit, press STANDBY/ON to set the unit in standby mode, then disconnect the AC power plug from the wall outlet.
- 17 Install this unit near the AC outlet and where the AC power plug can be reached easily.
- 18 The batteries shall not be exposed to excessive heat such as sunshine, fire or the like.

The unit is not disconnected from the AC power source as long as it is connected to the wall outlet, even if this unit itself is turned off. This state is called the standby mode. In this state, this unit is designed to consume a very small quantity of power.

### FOR CANADIAN CUSTOMERS

To prevent electric shock, match wide blade of plug to wide slot and fully insert.

This Class B digital apparatus complies with Canadian ICES-003.

### WARNING

TO REDUCE THE RISK OF FIRE OR ELECTRIC SHOCK, DO NOT EXPOSE THIS UNIT TO RAIN OR MOISTURE.

### LASER SAFETY

This unit employs a laser. Due to possible eye injury, only a qualified service person should remove the cover or attempt to service this device.

### DANGER

This unit emits visible laser radiation when open. Avoid direct eye exposure to beam.

When this unit is plugged into a wall outlet, do not place your eyes close to the opening of the disc tray and other openings or look inside.

<b>Introduction</b> .....	<b>3</b>
Supplied accessories .....	3
Region codes .....	3
Playable disc formats .....	3
Cleaning discs .....	4
Patent information .....	4
<hr/>	
<b>Functional Overview</b> .....	<b>5</b>
Front panel .....	5
Rear panel .....	6
Remote control .....	7
<hr/>	
<b>Connections</b> .....	<b>8</b>
General notes on connections .....	8
<b>Audio connections</b> .....	<b>8</b>
Digital connection .....	8
Analog connection .....	8
<b>Video connections</b> .....	<b>9</b>
Component video jacks <A> .....	9
S-video jack <B> .....	9
Composite video jack <C> .....	9
<b>HDMI connection</b> .....	<b>10</b>
HDMI jack .....	10
<b>Other connections</b> .....	<b>11</b>
USB port .....	11
Remote control jacks .....	11
<hr/>	
<b>Getting Started</b> .....	<b>12</b>
<b>Step 1: Inserting batteries into the remote control</b> .....	<b>12</b>
Using the remote control .....	12
<b>Step 2: Turning on the power</b> .....	<b>12</b>
<b>Step 3: Setting a TV type/display and language</b> .....	<b>13</b>
Setting a color system for your TV .....	13
Setting an aspect ratio for your TV .....	13
Setting the OSD language .....	14
Setting the audio, subtitle and disc menu languages (DVD-Video only) .....	14

<b>Playback Operation</b> .....	<b>15</b>
<b>Basic operation</b> .....	<b>15</b>
Selecting a track/chapter .....	15
Searching backward/forward .....	15
<b>Repeat/Shuffle functions</b> .....	<b>15</b>
Repeat/Shuffle playback .....	15
Repeating a section within a chapter/track .....	16
<b>Operations for video playback (DVD/VCD/SVCD)</b> .....	<b>16</b>
Using the disc menu .....	16
Playback in slow motion .....	16
Zooming pictures in/out .....	16
Resuming playback from the last stopped point .....	16
Using the on-screen display (OSD) .....	17
<b>Special DVD features</b> .....	<b>18</b>
Playing by title .....	18
Selecting an audio language/format and subtitle language .....	18
<b>Special VCD/SVCD features</b> .....	<b>18</b>
Using the playback control (PBC) menu .....	18
<b>Playing data discs (MP3/WMA/JPEG/DivX)</b> .....	<b>18</b>
Selecting a folder and track/file .....	19
<b>Special picture disc features</b> .....	<b>19</b>
Using the preview function .....	19
Zooming pictures in/out .....	19
Playback with multi-angles .....	20
Playing MP3 music and JPEG picture simultaneously .....	20
<b>Special DivX features</b> .....	<b>20</b>
Using the interactive menu .....	20
Selecting an audio/subtitle language .....	20
<b>Using a USB device</b> .....	<b>21</b>
Supported USB devices .....	21
Playing data files .....	21

# Contents

---

<b>Setup Menu .....</b>	<b>22</b>
<b>General setup menu .....</b>	<b>22</b>
Locking/Unlocking the disc for viewing .....	22
Dimming the front panel display .....	22
Programming disc tracks (except MP3/ WMA/JPEG/DivX) .....	22
OSD language .....	23
Setting the screen saver .....	23
Setting the sleep timer .....	24
Setting the auto standby function .....	24
Displaying the DivX® VOD registration code .....	24
<b>Audio setup menu .....</b>	<b>25</b>
Setting the analog output .....	25
Setting the digital output .....	25
Turning the HDMI audio on/off .....	26
Turning the night mode on/off .....	26
Setting the lip synchronization .....	27
<b>Video setup menu .....</b>	<b>27</b>
TV type .....	27
Setting the TV display .....	27
Turning the progressive scan function on/off ...	28
Adjusting picture settings .....	29
Turning the black level on/off .....	29
Turning the closed caption on/off .....	30
Setting the HDMI video .....	30
<b>Preference setup menu .....</b>	<b>31</b>
Audio, subtitle and disc menu .....	31
Restricting playback with parental control .....	31
Selecting playback of VR format .....	32
Selecting the MP3/JPEG menu .....	32
Displaying DivX external subtitle files .....	33
Selecting the PBC (playback control) function .....	33
Changing the password .....	34
Resetting the system .....	34

<b>Language Codes .....</b>	<b>35</b>
<b>Troubleshooting .....</b>	<b>36</b>
<b>Glossary .....</b>	<b>39</b>
<b>Specifications .....</b>	<b>41</b>

Thank you for purchasing this unit. This owner's manual explains the basic operation of this unit.











This manual is printed prior to production. Design and specifications are subject to change in part as a result of improvements, etc. In case of differences between the manual and the product, the product has priority.

## Supplied accessories

- Remote control
- Two batteries (AAA, R03, UM-4) for the remote control
- Audio/Video pin cable
- Owner's manual

## Region codes

This unit is designed to support the region management system. Check the regional code number on the DVD disc package. If the number does not match the region code of this unit (see the table below or the back of this unit), this unit may be unable to play the disc.

Destination	Region code of this unit	Playable discs
U.S.A., Canada		 
U.K., Europe		 
Asia, Korea		 
Australia, Central and South America		 

## Playable disc formats

This unit is designed for use with discs having the logos shown below. Do not attempt to load any other type of disc into this unit.



This unit can play:

- DVD-R/RW/R DL and DVD+R/RW/R DL discs recorded in DVD-Video compatible format
- DVD-RW discs recorded in VR format (compatible with CPRM)
- MP3, WMA and JPEG files recorded on CD-R/RW, DVD-R/RW, DVD+R/RW and USB
- KODAK picture CDs, FUJICOLOR CDs
- ISO 9660 Level1/Level2 for CD-R/RW
- Up to 298 folders per disc/USB device and up to 648 files per folder with up to 8 hierarchies
- DivX<sup>®</sup> files recorded on CD-R/RW, DVD-R/RW, DVD+R/RW and USB
  - Official DivX<sup>®</sup> Ultra Certified product
  - Plays all versions of DivX<sup>®</sup> video (including DivX<sup>®</sup> 6) with enhanced playback of DivX<sup>®</sup> media files and the DivX<sup>®</sup> Media Format

### Notes

- CD-R/RW, DVD-R/RW/R DL and DVD+R/RW/R DL cannot be played unless finalized.
- Progressive JPEG and copyright-protected WMA files cannot be played with this unit.
- Only the first session of DVD-R/RW/R DL and DVD+R/R DL can be played.
- Some discs cannot be played depending on disc characteristics or recording conditions.
- Do not use any non-standard shaped discs (heart-shaped, etc.).
- Do not use discs with tape, seals, paste or many scratches on their surface.
- For details about playable formats, see “Specifications” on page 41.

# Introduction

---

## Cleaning discs

- When a disc becomes dirty, clean it with a cleaning cloth. Wipe the disc from the center out. Do not wipe in a circular motion.
- Do not use solvents such as benzine, thinner, commercially available cleaners, or antistatic spray intended for analog records.

## Patent information



Manufactured under license from Dolby Laboratories. “Dolby”, “Pro Logic” and the double-D symbol are trademarks of Dolby Laboratories.



“DTS” and “DTS Digital Out” are registered trademarks of DTS, Inc.



DivX, DivX Ultra Certified, and associated logos are trademarks of DivX, Inc. and are used under license.



HDMI, the HDMI logo and High Definition Multimedia Interface are trademarks or registered trademarks of HDMI Licensing LLC.

This product incorporates copyright protection technology that is protected by method claims of certain U.S. patents and other intellectual property rights owned by Macrovision Corporation and other rights owners. Use of this copyright protection technology must be authorized by Macrovision Corporation, and is intended for home and other limited viewing uses only unless otherwise authorized by Macrovision Corporation. Reverse engineering or disassembly is prohibited.



## Front panel

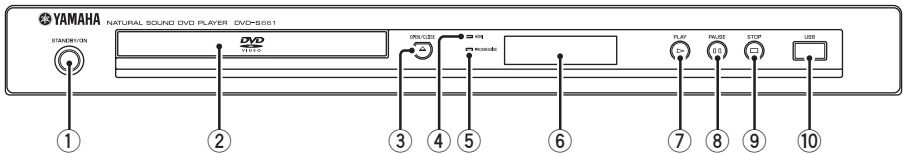

- ① **STANDBY/ON**  
Turns on this unit or sets it to the standby mode.
- ② **Disc tray**  
Loads a disc in the disc tray.
- ③ **OPEN/CLOSE (△)**  
Opens or closes the disc tray.
- ④ **HDMI indicator**  
Lights up when an HDMI component is connected, and signals output via the HDMI jack of this unit.
- ⑤ **PROGRESSIVE indicator**  
Lights up when this unit enters the progressive mode.
- ⑥ **Front panel display**  
Shows the current status of this unit.
- ⑦ **PLAY (▶)**  
Starts playback.
- ⑧ **PAUSE (▢▢)**  
Pauses playback.
- ⑨ **STOP (□)**  
Stops playback.
- ⑩ **USB port**  
Connect to the USB port of your USB device (see page 11).

# Functional Overview

## Rear panel

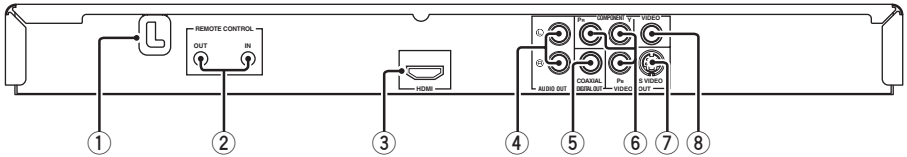

- ① **AC power cable**  
Plug the power cable into the AC wall outlet.
- ② **REMOTE CONTROL (IN, OUT) jacks**  
Connect the REMOTE CONTROL (IN) jack of this unit to the remote control output jack of your Yamaha AV receiver.  
Connect the REMOTE CONTROL (OUT) jack of this unit to the remote control input jack of your Yamaha component (see page 11).
- ③ **HDMI jack**  
Connect to the HDMI input jack of your HDMI component (see page 10).
- ④ **AUDIO OUT (L, R) jacks**  
Connect to the audio input jacks of your AV receiver or stereo system (see page 8).
- ⑤ **DIGITAL OUT - COAXIAL jack**  
Connect to the coaxial input jack of your AV receiver (see page 8).
- ⑥ **VIDEO OUT - COMPONENT (Y, Pb, Pr) jacks**  
Connect to the component input jacks of your AV receiver (see page 9).
- ⑦ **VIDEO OUT - S VIDEO jack**  
Connect to the S-video input jack of your AV receiver (see page 9).
- ⑧ **VIDEO OUT - VIDEO jack**  
Connect to the composite video input jack of your AV receiver (see page 9).

**Caution: Do not touch the inner pins of the jacks on the rear panel of this unit.  
Electrostatic discharge may cause permanent damage to this unit.**

## Remote control

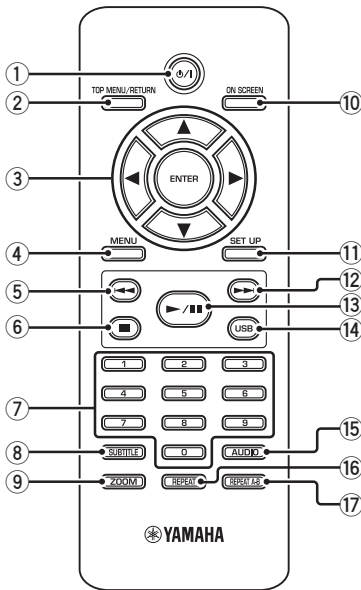

- ① **⏻/⏪**  
Turns on this unit or sets it to the standby mode.
- ② **TOP MENU/RETURN**  
Displays the top-level disc menu (DVD).  
Moves back to the previous menu (DVD\*/VCD)  
(see page 18).
- ③ **◀/▶/▲/▼**  
Selects an item in the currently displayed menu.  
Search or slow playback.  
**ENTER**  
Confirms the menu selection.
- ④ **MENU**  
Displays the menu of a disc (DVD/JPEG)  
(see pages 16, 18, 19 and 20).  
Switches PBC on or off (VCD) (see page 18).

- ⑤ **⏮**  
Moves to the previous chapter or track.  
Searches backward.\*
- ⑥ **■**  
Stops playback.  
Opens the disc tray.\*
- ⑦ **Numeric buttons (0-9)**  
Selects numbered items in the currently  
displayed menu.
- ⑧ **SUBTITLE**  
Selects the subtitle language (see pages 18 and  
20).
- ⑨ **ZOOM**  
Enlarges the video image (see pages 16 and 19).
- ⑩ **ON SCREEN**  
Accesses or exits from the on-screen display  
(OSD) menu of this unit (see page 17).
- ⑪ **SET UP**  
Accesses or exits from the setup menu of this  
unit (see pages 13 and 22).
- ⑫ **▶▶**  
Moves to the next chapter or track.  
Searches forward.\*
- ⑬ **▶/⏪**  
Starts or pauses playback.
- ⑭ **USB**  
Accesses the contents of the connected USB  
device or exits from the USB mode (see  
page 21).
- ⑮ **AUDIO**  
Selects the audio language or format (see  
pages 18 and 20).
- ⑯ **REPEAT**  
Accesses or exits from the repeat/shuffle mode  
(see page 15).
- ⑰ **REPEAT A-B**  
Repeats a specific segment (see page 16).

\* Press and hold the button for about two seconds.

# Connections

## General notes on connections

Be sure to turn off this unit and unplug the power cable before you make or change connections.

- Depending on the component you want to connect, there are various ways to make connections. Possible connections are described below.
- Refer to the manuals supplied with your other components as necessary to make the best connections.
- Do not connect this unit via your VCR. The video quality could be distorted by the copy protection system.
- Do not connect the audio out jack of this unit to the phono in jack of your audio system.

## Audio connections

### Digital connection

This unit has a digital coaxial output jack. Connect the DIGITAL OUT - COAXIAL jack of this unit to your AV receiver equipped with a Dolby Digital, DTS, or MPEG decoder using a commercially available coaxial cable.

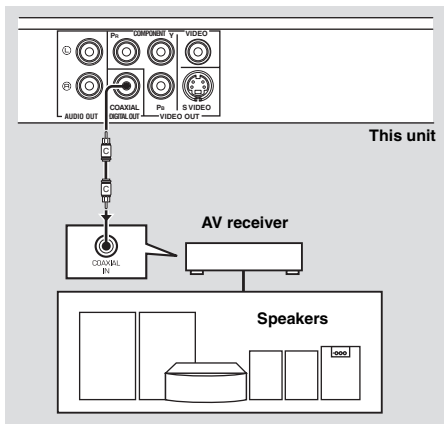

### Notes

- You need to set [DIGITAL OUTPUT] to [ALL] (see “DIGITAL OUTPUT” on page 25).
- If the audio format of the digital output does not match the capabilities of your receiver, the receiver produces a distorted sound or no sound at all. Make sure to select the appropriate audio format from the menu screen on the disc. Pressing AUDIO on the remote control once or more may change not only the audio languages but also the audio format. The selected format appears in the front panel display for several seconds.
- If you want to enjoy Dolby Digital, DTS and MPEG formats, you must connect this unit to an AV receiver that supports these formats.

### Analog connection

This unit has 2-ch analog output jacks. Connect the AUDIO OUT (L, R) jacks of this unit to the corresponding input jacks of your audio component (such as a stereo amplifier) using the supplied audio pin cable.

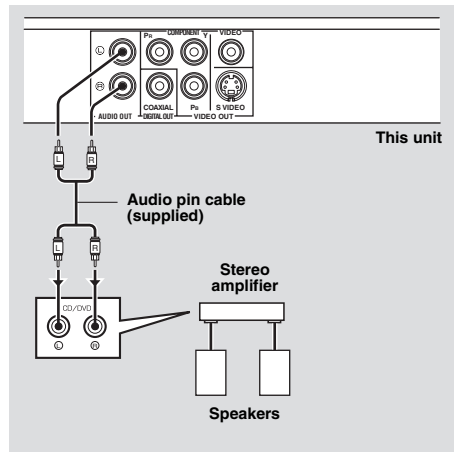

## Video connections

If your AV receiver has video output jacks, connect your receiver and then your TV so that you can use one TV for several different video sources (LD, VCR, etc.) by simply switching the input source selector of your receiver.

This unit has several types of video output jacks. Use the one that corresponds to the input jacks of the component to be connected.

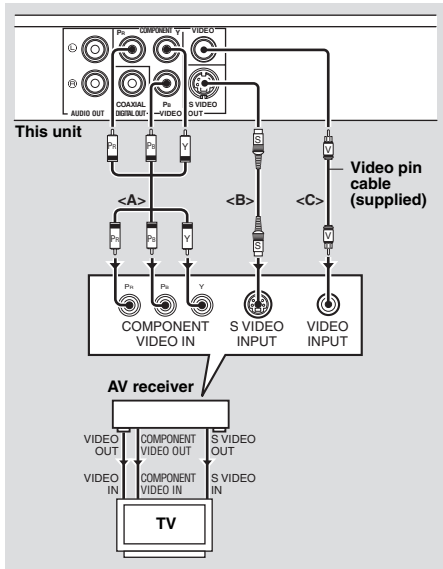

### Component video jacks <A>

Component video connections achieve higher fidelity color reproduction than S-video connections by transmitting video signals on separate wires for luminance (Y: green) and chrominance (PB: blue, PR: red).

Connect the VIDEO OUT - COMPONENT (Y, PB, PR) jacks of this unit to component input jacks of your AV receiver and then to those of your TV using a commercially available component cable. Observe the color of each jack when you make connections.

If your receiver does not have component output jacks, you can achieve a better video image by connecting the component output jacks of this unit directly to the component input jacks of your TV.

### S-video jack <B>

S-video connections achieve a clearer picture than composite video connections by transmitting video signals on separate wires for luminance (Y) and chrominance (C).

Connect the VIDEO OUT - S VIDEO jack of this unit to an S-video input jack of your AV receiver and then to that of your TV using a commercially available S-video cable.

### Composite video jack <C>

Connect the VIDEO OUT - VIDEO jack of this unit to a video input jack of your AV receiver and then to that of your TV using the supplied video pin cable.

# Connections

## HDMI connection

### HDMI jack

HDMI provides high quality digital audio and video on a single connection.

Connect the HDMI jack of this unit to an HDMI input jack of your AV receiver, and then to that of your TV using a commercially available HDMI cable.

If your receiver does not have an HDMI input jack, you can achieve a better video image by connecting the HDMI jack of this unit directly to the HDMI input jack of your TV.

This unit can display High-Definition JPEG images (720p or 1080i) when you connect this unit to an HDTV via the HDMI jack. For details, see “HD JPEG” on page 31.

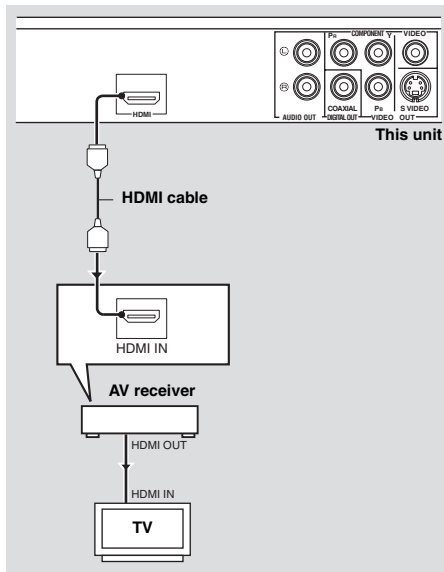

### Notes

- You need to set [HDMI AUDIO] (see page 26) and [HDMI VIDEO] (see page 30).
- You need to make an appropriate audio connections if the connected component does not output audio signals (see “Audio connections” on page 8).
- This unit is not compatible with HDCP-incompatible HDMI or DVI components.
- You need a commercially available HDMI/DVI conversion cable when you connect this unit to other DVI components. In this case, the HDMI jack of this unit does not output any audio signals.
- Depending on the connected DVI component, black and white in the image may not be distinct. In that case, adjust the picture setting of the connected DVI component.
- Do not disconnect or turn off the power of the HDMI/DVI component connected to the HDMI jack of this unit while data is being transferred. Doing so may disrupt playback or cause noise.
- When connecting an HDMI component, refer to the manual supplied with your component.

## Other connections

### USB port

This unit has a USB port and can access MP3, WMA, DivX and JPEG files saved on your USB device.

Connect the USB port on the front panel of this unit to a USB port of your USB device.

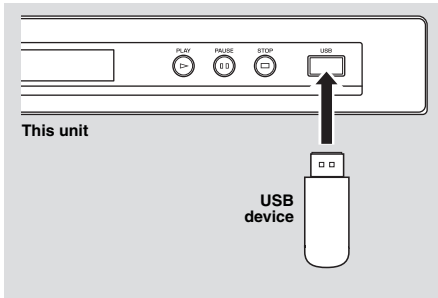

### Notes

- This unit may not recognize some USB devices.
- For details about the USB features, see “Using a USB device” on page 21.

### Remote control jacks

This unit has remote control input/output jacks. If your AV receiver is a Yamaha product and has the capability to transmit of SCENE control signals, you can use the SCENE function.

Connect the REMOTE CONTROL (IN) jack of this unit to a remote control output jack of your receiver using a commercially available monaural mini-jack cable so that this unit starts playback automatically by simply pressing a button of your receiver.

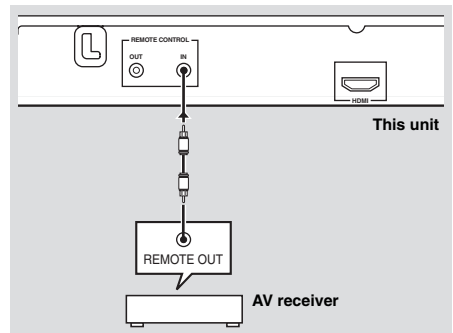

### Note

For details about the SCENE function, refer to the owner’s manual supplied with your Yamaha AV receiver.

# Getting Started

## Step 1: Inserting batteries into the remote control

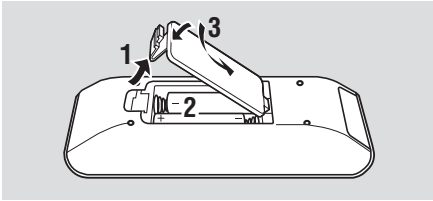

- 1 Open the battery compartment.
- 2 Insert the two supplied batteries (AAA, R03, UM-4) following the indications (+/-) inside the compartment.
- 3 Close the cover.

### Notes

- Insert batteries correctly according to the polarity markings (+/-). Batteries inserted in the opposite orientation may leak.
- Replace the exhausted batteries immediately with new ones to prevent leakage.
- Remove the batteries from the compartment if the remote control is not used for more than a month.
- If the batteries have leaked, dispose of them immediately. Avoid touching the leaked material or letting it come into contact with clothing, etc. Clean the battery compartment thoroughly before installing new batteries.
- Do not use old batteries together with new ones.
- Do not use different types of batteries (such as alkaline and manganese batteries) together. Read the packaging carefully as these different types of batteries may have the same shape and color.
- Dispose of the batteries correctly in accordance with your local regulations.

## Using the remote control

Use the remote control within 6 m (approximately 20 ft) of this unit and point it toward the remote control sensor.

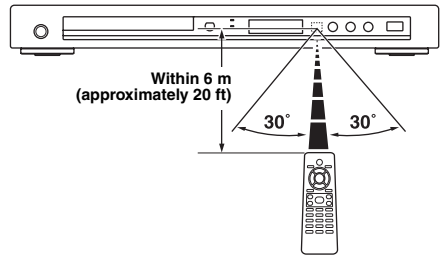

### Notes

- Do not spill water or other liquids on the remote control.
- Do not drop the remote control.
- Do not leave or store the remote control in the following types of conditions:
  - places of high humidity, such as near a bath
  - places of high temperature, such as near a heater or stove
  - places of extremely low temperature
  - dusty places
- When the remote control works unstably, point it at an angle upward to the sensor.

## Step 2: Turning on the power

- 1 Plug the power cable into the AC outlet.
- 2 Turn on your TV and AV receiver.
- 3 Select the appropriate input source of the AV receiver (refer to the manual supplied with your AV receiver).
- 4 Press **STANDBY/ON** on the front panel or **⏻/I** on the remote control to turn on this unit.
  - The front panel display lights up.
- 5 Set the TV to the correct video input (refer to the manual supplied with your TV).
  - The default screen appears on the TV.



### Step 3: Setting a TV type/display and language

You can customize this unit using the setup menu displayed on the TV screen.

#### Notes

- Unless stated otherwise, all operations described here are carried out using the supplied remote control.
- To return to the previous menu, press **◀**.
- To exit from the menu, press **SET UP**.

### Setting a color system for your TV

This unit is compatible with both NTSC and PAL video formats. Select the color system that matches your TV.

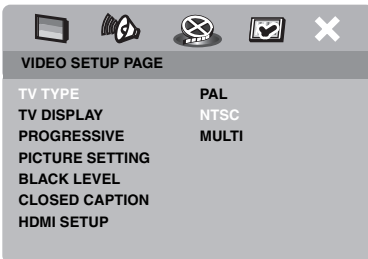

- 1 Press **SET UP**.
- 2 Press **▶** repeatedly to select “VIDEO SETUP PAGE”.
- 3 Press **▲/▼** to highlight [TV TYPE], and then press **▶**.
- 4 Press **▲/▼** to highlight one of the following options.

#### PAL

Select this if the connected TV is a PAL system TV. It will change the video signals of NTSC discs and output them in PAL format.

#### NTSC

Select this if the connected TV is an NTSC system TV. It will change the video signals of PAL discs and output them in NTSC format.

#### MULTI

Select this if the connected TV is compatible with both NTSC and PAL formats (such as a multi-system TV).

The output format will be in accordance with the video signals of the disc.

- 5 Select an item, and then press **ENTER**.

#### Notes

- Before changing the current TV standard setting, ensure that your TV supports the selected TV type.
- If the picture is not displayed properly on your TV, wait for 15 seconds for this unit to activate automatic recovery.
- When making HDMI connections, you cannot change or select [TV TYPE].



### Setting an aspect ratio for your TV

You can set the aspect ratio of this unit to match your TV. If the aspect ratio of your TV is 4:3, you do not need to change this setting. If you have a widescreen TV, change this setting according to the procedure below. For details, see “Setting the TV display” on page 27.

# Getting Started

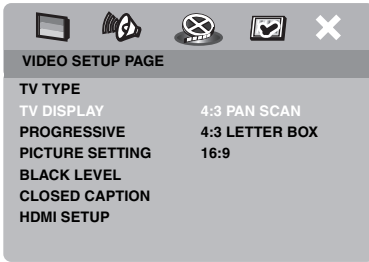

- 1 Press **SET UP**.
- 2 Press **▶** repeatedly to select "VIDEO SETUP PAGE".
- 3 Press **▲/▼** to highlight [TV DISPLAY], and then press **▶**.
- 4 Press **▲/▼** to highlight [16:9], and then press **ENTER**.

## Setting the OSD Language

You can select your own preferred language for the setup menu. This setting remains once selected.

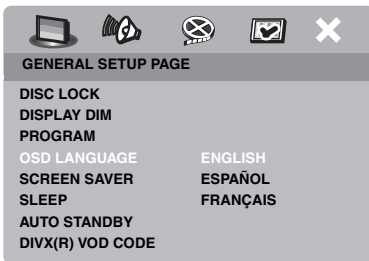

- 1 Press **SET UP**.
- 2 Press **◀/▶** to select "GENERAL SETUP PAGE".
- 3 Press **▲/▼** to highlight [OSD LANGUAGE], and then press **▶**.
- 4 Press **▲/▼** to select a language, and then press **ENTER**.

## Setting the audio, subtitle and disc menu languages (DVD-Video only)

You can select your own preferred language for the audio, subtitle and disc menu. This unit automatically switches to the selected language whenever you load a disc. If the selected language is not available on the disc, the default language of the disc will be used instead.



- 1 Press **■** twice, and then press **SET UP**.
- 2 Press **▶** repeatedly to select "PREFERENCE PAGE".
- 3 Press **▲/▼** to highlight one of the options below, and then press **▶**.
  - AUDIO (audio language)
  - SUBTITLE (subtitle language)
  - DISC MENU (disc menu language)
- 4 Press **▲/▼** to select a language, and then press **ENTER**.
- 5 Repeat steps **3-4** for other language settings.

### ■ To select a language not in the list

- 1 Select [OTHERS] in [AUDIO] or [SUBTITLE] or [DISC MENU].
- 2 Use the **numeric buttons (0-9)** to enter the 4-digit language code (see "Language Codes" on page 35), and then press **ENTER**.

## Notes

- If the prohibited icon (⊘) appears on the TV screen when a button is pressed, the function for that button is not available on the current disc or at the current time.
- Unless stated otherwise, all operations described here are carried out using the supplied remote control.
- Depending on the disc, some operations may operate differently or be restricted. Refer to the instruction supplied with the disc.
- Do not push on the disc tray or put any objects other than discs on the disc tray. Doing so may cause this unit to malfunction.

## Basic operation

- 1 Make sure this unit is turned on.
- 2 Press **OPEN/CLOSE** (△) on the front panel to open the disc tray.
- 3 Place the disc in the disc tray with the printed side up.
- 4 Press **OPEN/CLOSE** (△) again to close the disc tray.
  - After recognizing the disc, this unit starts playback automatically.
  - If you press ►/|| when the disc tray is open, the disc tray closes and playback starts automatically.
- 5 To pause playback, press ►/|| during playback.
  - Playback is paused and the sound is muted.
  - Frame-by-frame playback can be done by pressing **PAUSE** (⏏) on the front panel repeatedly.
- 6 To resume normal playback, press ►/|| again.
- 7 To stop playback, press ■ .

## Selecting a track/chapter

- 1 Press ◀◀ / ▶▶| or use the **numeric buttons (0-9)** to select a track/chapter number.
- 2 During repeated playback, press ◀◀ / ▶▶| to replay the same track/chapter.

## Searching backward/forward

- 1 Press and hold ◀◀ / ▶▶| or press ◀ / ▶ .
- 2 While searching, press ◀◀ / ▶▶| or ◀ / ▶ repeatedly to select the desired speed.
- 3 To resume normal playback, press ►/|| .

## Notes

- The ◀ / ▶ key may not be available with some discs.
- For MP3 and WMA, the search function allows you to search the track currently being played.

## Repeat/Shuffle functions

### Repeat/Shuffle playback

Each time you press **REPEAT** during playback, the front panel display changes as follows:

#### DVD

- RPT ONE (repeat chapter)
- RPT TT (repeat title)
- RPT ALL (repeat all)
- SHUFFLE (shuffle)
- RPT SHF (shuffle repeat)
- RPT OFF (repeat off)

#### VCD/SVCD/CD

- RPT ONE (repeat track)
- RPT ALL (repeat all)
- SHUFFLE (shuffle)
- RPT SHF (shuffle repeat)
- RPT OFF (repeat off)

# Playback Operation

## MP3/WMA/DivX

- RPT ONE (repeat track)
- RPT FLD (repeat folder)
- SHUFFLE (shuffle)
- RPT OFF (repeat off)

### Note

For VCD, repeat playback is not available when the PBC mode is on.

## Repeating a section within a chapter/track

- 1 While playing a disc, press **REPEAT A-B** at the desired starting point.
  - “SET A” appears in the front panel display.
- 2 Press **REPEAT A-B** again at the desired end point.
  - A and B can only be set within the same chapter/track.
  - “RPT AB” appears in the front panel display and the selected section repeats continuously.
- 3 To exit from the sequence, press **REPEAT A-B**.

## Operations for video playback (DVD/VCD/SVCD)

### Using the disc menu

Depending on the disc, a menu may appear on the TV screen once you load the disc.

#### ■ To select a playback feature or item

Use ◀ / ▶ / ▲ / ▼ or the **numeric buttons (0-9)**, and then press **ENTER** to start playback.

#### ■ To access or exit from the menu

Press **MENU**.

## Playback in slow motion

You can play back video in slow motion.

- 1 Press ▲ for reverse slow motion or ▼ for forward slow motion.
- 2 During slow motion, press ▲/▼ repeatedly to select the desired speed.
- 3 To resume normal playback, press ▶/|| or **ENTER**.

### Note

For VCD and SVCD, reverse slow motion is not available.

## Zooming pictures in/out

You can enlarge or shrink the picture on the TV screen and pan through the enlarged picture.

- 1 During playback, press **ZOOM** repeatedly to display the picture at different scales.
  - Use ◀ / ▶ / ▲ / ▼ to pan through the enlarged picture.
  - Playback continues.
- 2 Press **ZOOM** repeatedly to return to the original size.

## Resuming playback from the last stopped point

You can resume playback of the last ten discs, even if the discs were ejected or the power of this unit was turned off.

- 1 Load one of the last ten discs.
  - “LOADING” appears on the TV screen.
- 2 Press ▶/|| while “LOADING” is displayed on the TV screen.
  - “RESUME PLAY” appears on the TV screen and the disc is played back from the last point.

#### ■ To cancel the resume mode

When playback is stopped, press ■ again.

## Using the on-screen display (OSD)

The OSD menu shows disc playback information (e.g., the title or chapter number, elapsed playing time or audio/subtitle language). A number of operations are possible without interrupting disc playback.

- 1 During playback, press **ON SCREEN**.  
→ A list of available disc information appears on the TV screen.

### DVD

MENU	
TITLE	02/14
CHAPTER	02/14
AUDIO	5.1CH
SUBTITLE	ENG
BITRATE 16 III TITLE ELAPSED 0:02:25	

### VCD/SVCD

MENU	
TRACK	02/14
DISC TIME	0:49:17
TRACK TIME	0:03:43
REPEAT	OFF
BITRATE 16 III TOTAL ELAPSED 0:02:25	

- 2 Press **▲/▼** to scroll the information, and then press **ENTER** to access the selected item.
- 3 Use the **numeric buttons (0-9)** to input the number/time or press **▲/▼** to make a selection, and then press **ENTER**.  
→ Playback changes to the selected time or to the selected title/chapter/track.

## ■ Title/Chapter/Track selection (DVD/VCD)

- 1 Press **▲/▼** to select [TITLE] or [CHAPTER] (DVD) or [TRACK] (VCD).
- 2 Press **ENTER**.
- 3 Select a title, chapter or track number using the **numeric buttons (0-9)**.

## ■ Time search (DVD/VCD)

- 1 Press **▲/▼** to select [TT TIME] / [CH TIME] (DVD) or [TRACK TIME] / [DISC TIME] (VCD).
  - [TT TIME] refers to the total time of the current title, and [CH TIME] refers to the total time of the current chapter.
- 2 Press **ENTER**.
- 3 Enter hours, minutes and seconds from left to right using the **numeric buttons (0-9)** (e.g. 0:34:27).

## ■ Audio/Subtitle/Angle selection (DVD)

You can change [AUDIO], [SUBTITLE] or [ANGLE] if these functions are available on the disc you are playing.

- 1 Press **▲/▼** to select [AUDIO], [SUBTITLE] or [ANGLE].
- 2 Press **ENTER**.
- 3 For Audio and Subtitle:  
Press **▲/▼** to highlight your selection, and then press **ENTER**.

OR

For Angle:

Select an angle using the **numeric buttons (0-9)**.

# Playback Operation

## ■ Repeat/Time Display (DVD/VCD)

- 1 Press **▲/▼** to select [REPEAT] or [TIME DISP.].
- 2 Press **ENTER**.
- 3 Press **▲/▼** to highlight your selection, and then press **ENTER**.

## ■ Time display (CD)

Each time you press **ON SCREEN**, the time display changes as follows:

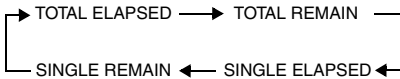

## Special DVD features

### Playing by title

- 1 Press **MENU**.  
→ The disc title menu appears on the TV screen.
- 2 Use **◀/▶/▲/▼** or the **numeric buttons (0-9)** to select a playback option.
- 3 Press **ENTER**.

### Selecting an audio language/format and subtitle language

#### ■ To select an audio language/format

Press **AUDIO** repeatedly to select an audio language and/or format.

#### ■ To select a subtitle language

Press **SUBTITLE** repeatedly to select a subtitle language.

## Special VCD/SVCD features

### Using the playback control (PBC) menu

#### For a VCD with a playback control (PBC) feature (version 2.0 only)

- 1 Press **MENU** to toggle between “PBC ON” and “PBC OFF”.  
→ If you select “PBC ON”, the disc menu appears (if available) on the TV screen.
- 2 Use the **numeric buttons (0-9)** to select a playback option.
  - Press **◀◀/▶▶** to move to the previous/next page (if available).
- 3 During playback, press **TOP MENU/RETURN** to return to the menu screen.

#### ■ To skip the index menu and play back a disc from the beginning

Press **MENU** to turn off the PBC function.

## Playing data discs (MP3/WMA/JPEG/DivX)

- 1 Load a data disc.
  - The disc reading time may exceed 30 seconds due to the complexity of the directory/file configuration.
  - The data disc menu appears on the TV screen.

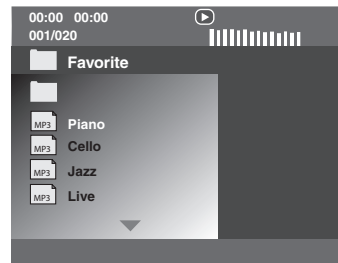

- 2 Playback starts automatically. If not, press **▶/||**.
- 3 Press **◀◀/▶▶** to select another track/file in the current folder.

## Notes

- It may not be possible to play certain MP3/WMA/JPEG/DivX discs due to the configuration and characteristics of the discs or the recording conditions.
- HD JPEG images may not be displayed correctly when the first image is displayed or the disc is ejected. For details about HD JPEG, see “HD JPEG” on page 31.
- Depending on the picture size, HD JPEG images may appear smaller in size.

## Selecting a folder and track/file

- 1 Press **▲/▼** to select a folder, and then press **ENTER** to open the folder.
- 2 Press **▲/▼** to select a track/file.
- 3 Press **ENTER**.  
→ Playback starts from the selected file to the end of the folder.

## Special picture disc features

- 1 Load a picture disc (JPEG, Kodak Picture CD or Fujicolor CD).  
→ For JPEG, the picture menu appears on the TV screen.  
→ For Kodak Picture CD and Fujicolor CD, the slideshow begins.

### ■ For JPEG

- 2 Press **▶/||** to start the slideshow.

## Using the preview function

This function displays the content of the current folder or the entire disc.

- 1 Press **■** during playback.  
→ 12 thumbnails appear on the TV screen.



- 2 Press **◀◀/▶▶** to display the other thumbnails on the previous/next page.
- 3 Use **◀/▶/▲/▼** to highlight one of the thumbnails, and then press **ENTER** to start playback.

OR

Move the cursor to highlight **■** on the bottom of the page to start playback from the first thumbnail on the current page.

### ■ For JPEG

- 4 Press **MENU** to return to the JPEG disc menu.

## Zooming pictures in/out

- 1 During playback, press **ZOOM** repeatedly to display the picture at different scales.
- 2 Use **◀/▶/▲/▼** to pan through the enlarged picture.

# Playback Operation

## Playback with multi-angles

During playback, press ◀ / ▶ / ▲ / ▼ to rotate the picture on the TV screen.

- ◀: rotates the picture counter-clockwise
- ▶: rotates the picture clockwise
- ▲: flips the picture vertically
- ▼: flips the picture horizontally

### Note

For HD JPEG, the ▲/▼ key is not available.

## Playing MP3 music and JPEG pictures simultaneously

- 1 Load a disc that contains both MP3 music and JPEG picture data.
  - The disc menu appears on the TV screen.
- 2 Select an MP3 music track.
- 3 During MP3 music playback, select a JPEG picture file from the TV screen, and then press ▶ / II .
  - The picture files are played back one after another until the end of the folder.
- 4 To quit simultaneous playback, press **MENU**, and then press ■ .

### Notes

- Some files cannot be played correctly depending on disc characteristics or recording conditions.
- This function is not available when [HD JPEG] is set to [ON] (see page 31).

## Special DivX features

### DivX files including DMF (DivX Media Format) features only

#### Using the interactive menu

- 1 Load a disc.
  - The interactive menu appears on the TV screen.
- 2 Use ◀ / ▶ / ▲ / ▼ to select a chapter.
- 3 Press **ENTER** or ▶ / II to start playback of the selected chapter.

#### ■ To access the interactive menu

During playback, press **MENU**.

#### ■ To return to the data disc menu screen

When the interactive menu is displayed, press ■ .

#### Selecting an audio/subtitle language

##### ■ To select an audio language

During playback, press **AUDIO** to switch the audio language recorded on the contents.

##### ■ To select a subtitle language

During playback, press **SUBTITLE** to switch or turn on/off the subtitle language recorded on the contents.

### Note

For information about external subtitle files, see “Displaying DivX external subtitle files” on page 33.



## Using a USB device

You can play back MP3, WMA, JPEG and DivX files saved on your supported USB device.

### Supported USB devices

This unit supports USB mass storage class devices (e.g., flash memories, card readers, portable audio players) using FAT16 or FAT32 format.

#### Notes

- Some devices may not work properly even if they meet the requirements.
- If “Device not supported” appears on the TV screen when you connect the USB device, follow the procedure below.
  - Set this unit to the standby mode, and then turn it on again.
  - Disconnect the device when this unit is in the standby mode, then connect it again and turn on this unit.
  - Connect the AC adapter if the adapter is supplied with the device.
- If “Device not supported” appears even after you perform this procedure, the device is not playable with this unit.
- If “USB current protection active. Device not supported” appears on the TV screen, the device is not playable with this unit because the power consumption of the device is too high.
- This unit cannot read more than two card reader slots at once, though it can recognize up to six slots. The first slot has priority.
- For an external hard disk drive, this unit is compatible with size of 80 GB or less.
- Do not connect devices other than USB mass storage class devices: USB chargers, USB hubs, PCs, etc.

## Playing data files

Yamaha and suppliers accepts no liability for the loss of data saved on the USB devices connected to this unit. As a precaution, it is recommended that the files are tested after they have been saved on.

- 1 Connect your USB device to the USB port of this unit (see “USB port” on page 11).
  - ➔ “Press USB mode key to switch device” appears on the TV screen.
- 2 Press **USB**.
  - The reading time may exceed 30 seconds due to the number of files/folders.
  - ➔ The file menu appears on the TV screen.
- 3 Follow the procedure in “Playing data discs (MP3/WMA/JPEG/DivX)” on page 18.

### ■ To exit from the USB mode

Press **■** to stop playback, and then press **USB**.

#### Notes

- You cannot access the USB mode while “LOADING” is displayed on the TV screen.
- If you disconnect the USB device or open the disc tray of this unit, the playback mode is automatically switched to the disc mode.
- For DivX, this unit is compatible with a bit rate range of 3 Mbps or less.
- Some files may not work properly depending on the USB device specification.
  - For DivX, the video may freeze shortly or the sound may break in the segments.
  - For MP3, the sound may break in the segments during MP3/JPEG simultaneous playback.
  - In this case, record the file at a lower bit rate and/or smaller size so that the file may work properly.
- Copyright-protected files cannot be played.
- This unit can display up to 648 files. However, less than 648 files may be displayed if some files are not playable with this unit.
- If the USB device is partitioned, only the first partition is displayed.
- This unit can play back files of 4 GB in size or less.

# Setup Menu

Setup is carried out on the TV screen, enabling you to customize this unit to suit your own particular requirements.

## Notes

- Unless stated otherwise, all operations described here are carried out using the supplied remote control.
- To return to the previous menu, press ◀.
- To exit from the menu, press **SET UP**.

## General setup menu

- 1 Press **SET UP**.
- 2 Press ◀ / ▶ to select “GENERAL SETUP PAGE”.
- 3 Press **ENTER**.

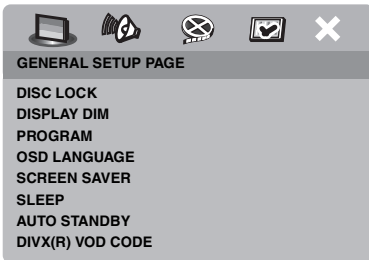

## Locking/Unlocking the disc for viewing

Not all discs are rated or coded by the manufacturer of the disc. You can prevent playback of a specific disc by locking the disc. You can lock up to 40 discs on this unit.

- 1 In “GENERAL SETUP PAGE”, press ▲/▼ to highlight [DISC LOCK], and then press ▶.

## LOCK

Select this to lock playback of the current disc. Subsequent access to a locked disc requires a six-digit password.

The default password is “000 000” (see “Changing the password” on page 34).

## UNLOCK

Select this to unlock the disc and allow future playback.

- 2 Press ▲/▼ to select a setting, and then press **ENTER**.

## Dimming the front panel display

You can select different levels of brightness for the front panel display.

- 1 In “GENERAL SETUP PAGE”, press ▲/▼ to highlight [DISPLAY DIM], and then press ▶.

### 100%

Select this for full brightness.

### 70%

Select this for medium brightness.

### 40%

Select this for dimming display.

- 2 Press ▲/▼ to select a setting, and then press **ENTER**.

## Programming disc tracks (except MP3/WMA/JPEG/DivX)

You can play back the contents of a disc in the desired order by programming the tracks to be played. You can store up to 20 tracks per disc with a maximum of ten discs.

- 1 In “GENERAL SETUP PAGE”, press ▲/▼ to highlight [PROGRAM], and then press ▶ to select [INPUT MENU].

- 2 Press **ENTER**.  
 → The input menu appears on the TV screen.

PROGRAM: TRACK (01-17)

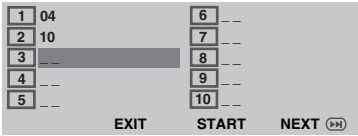

## ■ To input your favorite tracks/chapters

- 3 Use the **numeric buttons (0-9)** to enter a valid track/chapter number.
- 4 Use **◀ / ▶ / ▲ / ▼** to move the cursor to the next position.
- If the track/chapter number is more than ten, press **▶▶** to move to the next page, and then proceed with programming.
- OR
- Use **◀ / ▶ / ▲ / ▼** to highlight **[NEXT]** on the program menu, and then press **ENTER**.

- 5 Repeat steps **3-4** to input another track/chapter number.

## ■ To remove a track

- 6 Use **◀ / ▶ / ▲ / ▼** to move the cursor to the track you want to remove.
- 7 Press **ENTER** to remove this track from the program menu.

## ■ To start program playback

- 8 Use **◀ / ▶ / ▲ / ▼** to highlight **[START]** on the program menu, and then press **ENTER**.  
 → Playback starts for the selected tracks in the programmed sequence.

## ■ To exit from program playback

- 9 Use **◀ / ▶ / ▲ / ▼** to highlight **[EXIT]** on the program menu, and then press **ENTER**.

## OSD language

This menu contains various options for the on-screen display (OSD) language. For details, see “Setting the OSD Language” on page 14.

## Setting the screen saver

This function is used to turn on or off the screen saver.

- 1 In “GENERAL SETUP PAGE”, press **▲ / ▼** to highlight **[SCREEN SAVER]**, and then press **▶**.

### ON

Select this to turn off the TV screen when disc playback is stopped or paused for more than 15 minutes.

### OFF

Select this to disable the screen saver function.

- 2 Press **▲ / ▼** to select a setting, and then press **ENTER**.

# Setup Menu

---

## Setting the sleep timer

This feature automatically sets this unit to the standby mode after a certain elapsed period.

- 1 In “GENERAL SETUP PAGE”, press ▲/▼ to highlight [SLEEP], and then press ►.
- 2 Press ▲/▼ to select a setting.
  - You can select from 30, 60, 90, 120 and 150 minutes. Select [OFF] to cancel the sleep timer function.
- 3 Press **ENTER**.

## Setting the auto standby function

This function is used to turn the auto standby mode on or off when disc playback is stopped for more than 30 minutes.

- 1 In “GENERAL SETUP PAGE”, press ▲/▼ to highlight [AUTO STANDBY], and then press ►.

### ON

Select this to set this unit to the standby mode automatically when disc playback is stopped or paused for more than 30 minutes.

### OFF

Select this to disable the auto standby function.

- 2 Press ▲/▼ to select a setting, and then press **ENTER**.

## Displaying the DivX® VOD registration code

Yamaha provides you with a DivX® VOD (Video On Demand) registration code that allows you to rent and purchase videos using the DivX® VOD service.

For more information, visit <https://vod.divx.com/>.

- 1 In “GENERAL SETUP PAGE”, press ▲/▼ to highlight [DIVX(R) VOD CODE], and then press ►.
  - The registration code appears.
- 2 Press **ENTER** to exit.

### **Notes**

- To purchase or rent the videos from DivX® VOD service at <https://vod.divx.com/>, use the registration code and download the video onto a CD-R for playback on this unit.
- All of the downloaded videos from DivX® VOD can only be played back on this unit.
- For DivX, the time search feature is not available.

## Audio setup menu

- 1 Press **SET UP**.
- 2 Press ◀ / ▶ to select “AUDIO SETUP PAGE”.
- 3 Press **ENTER**.

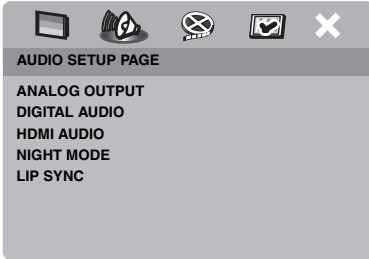

## Setting the analog output

Set the analog output to match the playback capability of this unit.

- 1 In “AUDIO SETUP PAGE”, press ▲/▼ to highlight [ANALOG OUTPUT], and then press ▶.

### STEREO

Select this to change channel output to stereo, which only delivers sound from the two front speakers.

### LT/RT

Select this if this unit is connected to a Dolby Pro Logic decoder.

- 2 Press ▲/▼ to select a setting, and then press **ENTER**.

## Setting the digital output

The [DIGITAL AUDIO] options are: [DIGITAL OUTPUT] and [LPCM OUTPUT].

- 1 In “AUDIO SETUP PAGE”, press ▲/▼ to highlight [DIGITAL AUDIO], and then press ▶.
- 2 Press ▲/▼ to highlight an option.
- 3 Press ▶ to open a submenu.

### DIGITAL OUTPUT

Set the digital output according to your optional audio component connections.

#### **OFF**

Select this to turn off the digital output.

#### **ALL**

Select this if you have connected the digital audio output jack to a multi-channel decoder/receiver.

#### **MPEG → PCM**

Select this if your receiver is not capable of decoding MPEG audio signals.

#### **PCM ONLY**

Select this only if your receiver is not capable of decoding multi-channel audio signals.

### LPCM OUTPUT

Select this if you have connected this unit to a PCM-compatible receiver via a digital terminal, such as the coaxial terminal. In this case, you may need to adjust [LPCM OUTPUT].

Discs are recorded at a certain sampling rate. The higher the sampling rate, the better the sound quality.

# Setup Menu

---

## **48KHz**

Select this to play back discs recorded at the sampling rate of 48 kHz. All 96 kHz PCM data streams (if available) are converted to the sampling rate of 48 kHz.

## **96KHz**

Select this to play back discs recorded at the sampling rate of 96 kHz. If the 96 kHz disc is copy protected, the digital output is automatically converted to the sampling rate of 48 kHz.

- 4** Press **▲/▼** to select a setting, and then press **ENTER**.

---

## **Turning the HDMI audio on/off**

When you connect this unit to an HDMI compatible component via the HDMI jack, select to turn on or off the HDMI audio output.

- 1** In “AUDIO SETUP PAGE”, press **▲/▼** to highlight [HDMI AUDIO], and then press **▶**.

### **ON**

Select this to turn on the HDMI audio output.

### **OFF**

Select this to turn off the HDMI audio output.

### **Notes**

- If you are not using the HDMI audio output, set this to [OFF].
- If the monitor/receiver connected to this unit using HDMI does not support HDMI audio signal input, set this to [OFF].
- This unit can output the following audio signals using HDMI: 32/44.1/48 kHz, 2ch linear PCM signals and bitstream signals (Dolby Digital, DTS and MPEG).
- When audio signals are being output by HDMI-compatible components, digital output signals are muted.

- When [DIGITAL OUTPUT] is set to [OFF] on this unit, HDMI audio is muted even if [HDMI AUDIO] is set to [ON] and an HDMI connection is established between the monitor and receiver.
- When [DIGITAL OUTPUT] is set to [ALL] on this unit, PCM signals are still output if the monitor and receiver only support the PCM format. However, the audio output is muted when audio format plays back the DTS source.

---

## **Turning the night mode on/off**

In the night mode, high volume output is softened and low volume output is brought upward to an audible level. It is useful when you want to watch your favorite action movie without disturbing others at night.

- 1** In “AUDIO SETUP PAGE”, press **▲/▼** to highlight [NIGHT MODE], and then press **▶**.

### **ON**

Select this to level out the volume. This feature is only available for movies with the Dolby Digital mode.

### **OFF**

Select this when you want to enjoy the full dynamic range of surround sound.

- 2** Press **▲/▼** to select a setting, and then press **ENTER**.

## Setting the lip synchronization

This feature allows you to delay the sound output in order to synchronize it with the video image. This may be necessary when you use certain LCD monitors or projectors.

- 1 In "AUDIO SETUP PAGE", press ◀ / ▶ to highlight [LIP SYNC], and then press ▶.
- 2 Press ◀ / ▶ to adjust the delay time (between 00 ms and 200 ms), and then press **ENTER**.

## Video setup menu

- 1 Press **SET UP**.
- 2 Press ◀ / ▶ to select "VIDEO SETUP PAGE".
- 3 Press **ENTER**.

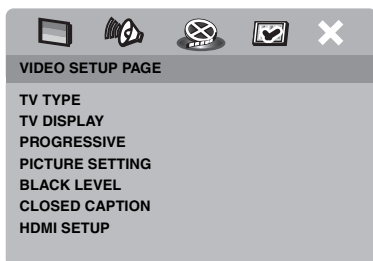

## TV type

This menu contains the options for selecting the color system that matches your TV. For details, see "Setting a color system for your TV" on page 13.

## Setting the TV display

Set the aspect ratio of this unit to match your TV. The format you select must be available on the disc. Otherwise, the TV display setting will not affect the picture during playback.

- 1 In "VIDEO SETUP PAGE", press ▲/▼ to highlight [TV DISPLAY], and then press ▶.
- 2 Press ▲/▼ to highlight one of the following options.

### **4:3 PAN SCAN**

Select this if the aspect ratio of your TV is 4:3 and you want both sides of the picture to be trimmed or formatted to fit your TV screen.

### **4:3 LETTER BOX**

Select this if the aspect ratio of your TV is 4:3. In this case, a wide picture with black bands on the upper and lower portions of the TV screen are displayed.

### **16:9**



Select this if you have a widescreen TV.

- 3 Select an item, and then press **ENTER**.

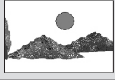

# Setup Menu

## ■ The relationship between the setting of this unit and the TV display

When the aspect ratio of your TV is 4:3:

Setting	Playback disc	TV display	
4:3 PAN SCAN	16:9		*1
	4:3		
4:3 LETTER BOX	16:9		
	4:3		

When the aspect ratio of your TV is 16:9 (widescreen):

Setting	Playback disc	TV display	
16:9	16:9		
	4:3		*2

\*1: If the disc is not assigned to playback in panscan, it is played in letterbox.

\*2: The side of the picture may be stretched depending on the TV. In this case, check the screen size and aspect ratio of your TV.

## Turning the progressive scan function on/off

This feature is only available if you have connected this unit to a progressive scan TV through the component video jacks (see “Component video jacks <A>” on page 9).

1 In “VIDEO SETUP PAGE”, press ▲/▼ to highlight [PROGRESSIVE], and then press ►.

### OFF

Select this to disable the progressive scan function.

### ON

Select this to enable the progressive scan function.

2 Press ▲/▼ to select a setting, and then press **ENTER**.

### Notes on activating progressive scan:

- Ensure that your TV is equipped with progressive scan.
- Connect using a component video cable.
- When making HDMI connections, you cannot select [PROGRESSIVE].

CONSUMERS SHOULD NOTE THAT NOT ALL HIGH DEFINITION TELEVISION SETS ARE FULLY COMPATIBLE WITH THIS PRODUCT AND MAY CAUSE ARTIFACTS TO BE DISPLAYED IN THE PICTURE. IN CASE OF 525 OR 625 PROGRESSIVE SCAN PICTURE PROBLEMS, IT IS RECOMMENDED THAT THE USER SWITCH THE CONNECTION TO THE “STANDARD DEFINITION” OUTPUT. IF THERE ARE QUESTIONS REGARDING OUR VIDEO MONITOR COMPATIBILITY WITH THIS MODEL 525P AND 625P DVD PLAYER, PLEASE CONTACT OUR CUSTOMER SERVICE CENTER. This unit is compatible with the complete line of Yamaha products, including the projectors DPX-1300, DPX-830 and the plasma monitor PDM-4220.



## Adjusting picture settings

This unit comes with three predefined sets of picture color settings and one personal setting that you can define yourself.

- 1 In “VIDEO SETUP PAGE”, press ▲/▼ to highlight [PICTURE SETTING], and then press ►.

### STANDARD

Select this for the standard picture setting.

### BRIGHT

Select this to make the TV picture brighter.

### SOFT

Select this to make the TV picture softer.

### PERSONAL

Select this to personalize your picture color by adjusting the brightness, contrast, tint and color (saturation).

- 2 Press ▲/▼ to select a setting, and then press **ENTER**.
- 3 If you select [PERSONAL] in step 1, proceed to steps 4-7.  
→ The “PERSONAL PICTURE SETUP” menu appears.

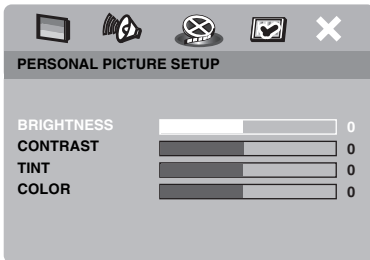

- 4 Press ▲/▼ to select one of the following options.

### **BRIGHTNESS**

Increase or decrease the value to brighten or dim the picture. Zero (0) is the average brightness setting value.

### **CONTRAST**

Increase or decrease the value to sharpen or dull the picture. Zero (0) is the average contrast setting value.

### **TINT**

Increase or decrease the value to darken or lighten the picture. Zero (0) is the average tint setting value.

### **COLOR**

Increase or decrease the value to enhance or fade the picture. Zero (0) is the average color setting value.

- 5 Press ◀ / ▶ to adjust the setting that best suits your personal preference.
- 6 Repeat steps 4-5 to adjust other color features.
- 7 Press **ENTER**.

### **Note**

All picture settings are not available for HDMI output.

## Turning the black level on/off

If [TV TYPE] is set to [NTSC] (see page 13), set the black level to on to improve the color contrast during playback. The black level setting has no effect if [TV TYPE] is set to [PAL].

- 1 In “VIDEO SETUP PAGE”, press ▲/▼ to highlight [BLACK LEVEL], and then press ►.

### **ON**

Select this to enhance the black level.

### **OFF**

Select this for the standard black level setting.

- 2 Press ▲/▼ to select a setting, and then press **ENTER**.

# Setup Menu

---

## **Turning the closed caption on/off**

Closed captions are data hidden in the video signals of specific discs and are invisible without the use of a special decoder. The difference between subtitles and captions is that subtitles are intended for hearing persons and captions are for the hearing impaired. Subtitles rarely show all of the audio. For example, captions show sound effects (e.g., “phone ringing”, “footsteps”), while subtitles do not.

Before you select this function, ensure that the disc contains closed caption information and your TV also supports this function.

- 1 In “VIDEO SETUP PAGE”, press ▲/▼ to highlight [CLOSED CAPTION], and then press ►.

### **ON**

Select this to enable the closed caption function.

### **OFF**

Select this to disable the closed caption function.

- 2 Press ▲/▼ to select a setting, and then press **ENTER**.

---

## **Setting the HDMI video**

When you connect this unit to an HDMI compatible component via the HDMI jack, select the following video output settings depending on the connected component.

- 1 In “VIDEO SETUP PAGE”, press ▲/▼ to highlight [HDMI SETUP], and then press ►.
- 2 Press ▲/▼ to highlight an option.
- 3 Press ► to enter a submenu.

## **WIDE SCREEN FORMAT**

Set the aspect ratio of the projected images on the screen. This feature is only available when making HDMI connections and [TV DISPLAY] is set to [16:9] (see page 27).

### **SUPERWIDE**

Select to display a 4:3 image on the 16:9 screen with non-linear stretching (center position of screen is stretched less than the sides). This feature is not available when the resolution is 480p or 576p.

### **4:3 PILLAR BOX**

Select to display a 4:3 image on the 16:9 screen without stretching. When playing a disc recorded in the 16:9 image, the image is displayed in its original aspect ratio (16:9) without pillar boxes.

### **OFF**

No aspect ratio adjustment is made when this option is selected.

## **HDMI VIDEO**

Set the resolution depending on the monitor you are using.

### **480P**

480 progressive-scan video

### **576P**

576 progressive-scan video

### **720P**

720 progressive-scan video

### **1080I**

1080 interlace video

### **AUTO**

The resolution is automatically selected to match the monitor you are using.

**Notes**

- For settings other than [AUTO], HDMI video signals may not be output properly if a resolution output setting is not supported by the HDMI component you are using. In that case, follow the steps below to return to the initial setting.
  - Press **OPEN/CLOSE (▲)** on the front panel to open the disc tray.
  - Press **◀**.
  - Press **SUBTITLE**.  
Do not perform this operation while playing back a disc on this unit.
- You cannot set [TV TYPE] and [PROGRESSIVE] when making HDMI connections.
- When disconnecting the HDMI cable, the setting of [TV TYPE] may be changed. If the component video, S-video or composite video signal is not output correctly, see “Troubleshooting” on page 36 to set the correct TV type again.

**HD JPEG**

This unit can display High-Definition JPEG images when connecting to an HDMI component.

**ON**

Displays JPEG pictures with high quality.

**OFF**

Displays JPEG pictures with standard quality.

**Notes**

- You can select [HD JPEG] when the HDMI video signals with 720p or 1080i are output.
- When [HD JPEG] is set to [ON] and HD JPEG pictures are displayed, video signals other than HDMI signals are not output.
- You cannot select [HDMI VIDEO] (see page 30) and [HD JPEG] when HD JPEG pictures are displayed.

**Preference setup menu**

- Press **■** twice to stop playback (if necessary), and then press **SET UP**.
- Press **◀ / ▶** to select “PREFERENCE PAGE”.
- Press **ENTER**.

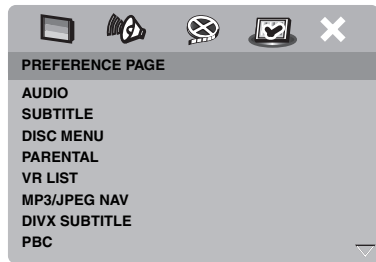
**Audio, subtitle and disc menu**

These menus contain various language options for the audio, subtitles and disc menus recorded on the DVD-Video. For details, see “Setting the audio, subtitle and disc menu languages (DVD-Video only)” on page 14.

**Restricting playback with parental control**

Some DVDs may have a parental level assigned to the complete disc or to certain scenes on the disc. This feature lets you set a playback limitation level. The rating levels are from 1 to 8 and are country dependent. You can prohibit playback of certain discs that are not suitable for your children or play certain discs in alternative scenes.

# Setup Menu

- 1 In "PREFERENCE PAGE", press ▲/▼ to highlight [PARENTAL], and then press ►.

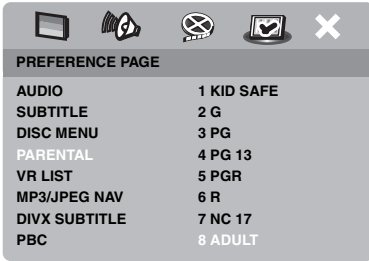

- 2 Press ▲/▼ to highlight a rating level for the inserted disc, and then press **ENTER**.
  - To disable parental controls and have all discs play, select [8 ADULT].
- 3 Use the **numeric buttons (0-9)** to enter the six-digit password (see "Changing the password" on page 34).
  - DVD discs that are rated above the level you selected do not play unless you enter your six-digit password.

## Note

Some DVD discs are not encoded with a rating though the movie rating may be printed on the disc cover. The rating level feature does not work for such discs.

---

## Selecting playback of VR format

There are two ways to play back a disc in VR (Video Recording) format: ORIGINAL and PLAY LIST. This feature is not available with non-VR format discs.

- 1 In "PREFERENCE PAGE", press ▲/▼ to highlight [VR LIST], and then press ►.

### ORIGINAL LIST

Select this to play the originally recorded titles on the disc.

### PLAY LIST

Select this to play the edited version of the disc. This feature is only available when a play list has been created.

- 2 Press ▲/▼ to highlight a setting, and then press **ENTER**.

## ■ To play back a disc in VR format

- 3 Press **SET UP** to close the setup menu.
- 4 Press ►/|| to begin to play back the disc with the setting you selected.

---

## Selecting the MP3/JPEG menu

MP3/JPEG navigator can be set only if the disc was recorded with a menu. It allows you to select different display menus for easy navigation.

- 1 In "PREFERENCE PAGE", press ▲/▼ to highlight [MP3/JPEG NAV], and then press ►.

### WITHOUT MENU

Select this to display all the files contained in the MP3/Picture CD.

### WITH MENU

Select this to display only the folder menu of the MP3/Picture CD.

- 2 Press ▲/▼ to select a setting, and then press **ENTER**.

## Displaying DivX external subtitle files

The font sets listed below are available for DivX external subtitle files. This setting allows you to see the proper font set on-screen to match the subtitle file.

- 1 In “PREFERENCE PAGE”, press ▲/▼ to highlight [DIVX SUBTITLE], and then press ►.

### GROUP1:

Albanian (sq), Basque (eu), Catalan (ca), Danish (da), Dutch (nl), English (en), Faroese (fo), Finnish (fi), French (fr), German (de), Icelandic (is), Irish (ga), Italian (it), Norwegian (no), Portuguese (pt), Rhaeto-Romanic (rm), Scottish (gd), Spanish (es), Swedish (sv)

### GROUP2:

Albanian (sq), Croatian (hr), Czech (cs), Hungarian (hu), Polish (pl), Romanian (ro), Slovak (sk), Slovenian (sl)

### GROUP3:

Bulgarian (bg), Byelorussian (be), Macedonian (mk), Russian (ru), Serbian (sr), Ukrainian (uk)

### GROUP4:

Hebrew (iw), Yiddish (ji)

### GROUP5:

Turkish (tr)

- 2 Press ▲/▼ to select a group, and then press **ENTER**.

### Notes

- Some discs cannot be played depending on disc characteristics or recording conditions.
- Some external subtitle files may be displayed incorrectly or not at all.
- For external subtitle files, the following subtitle format filename extensions are supported (note that these files are not shown within the disc navigation menu): .srt, .sub, .ssa, .smi
- The filename of the movie file has to be repeated at the beginning of the filename for the external subtitle file.
- The number of external subtitle files that can be switched for the same movie file is limited to a maximum of ten.

## Selecting the PBC (playback control) function

You can set playback control (PBC) to on or off. This function is available only on Video CD 2.0 with the playback control (PBC) feature.

- 1 In “PREFERENCE PAGE”, press ▲/▼ to highlight [PBC], and then press ►.

### ON

Select this to display a disc menu.

### OFF

Select this to not display a disc menu.

Playback starts from the beginning of a disc.

- 2 Press ▲/▼ to select a setting, and then press **ENTER**.

### Note

You can also use the MENU button on the remote control to turn on or off the playback control (PBC) function (see “Using the playback control (PBC) menu” on page 18).

# Setup Menu

## Changing the password

The same password is used for both parental control and disc lock. Enter your six-digit password when prompted on the screen. The default password is 000 000.

- 1 In “PREFERENCE PAGE”, press ▲/▼ to highlight [PASSWORD], and then press ► to select [CHANGE].

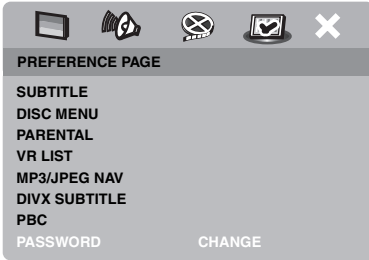

- 2 Press **ENTER** to enter the “Password Change Page”.

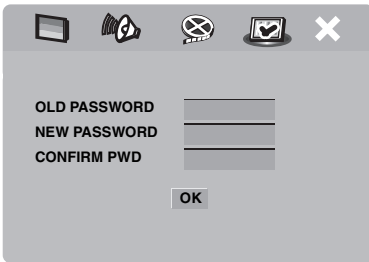

- 3 Use the **numeric buttons (0-9)** to enter your old six-digit password.
  - When doing this for the first time, enter “000 000”.
  - If you forget your old six-digit password, enter “000 000”.

- 4 Enter the new six-digit password.
- 5 Enter the new six-digit password again to confirm the password.
- 6 Press **ENTER** to confirm your new password.
  - The new six-digit password is now valid.

## Resetting the system

You can reset all options and your personal settings to the initial factory settings, excluding your password for [PARENTAL] and [DISC LOCK].









- 1 In “PREFERENCE PAGE”, press ▲/▼ to highlight [DEFAULT], and then press ► to select [RESET].
- 2 Press **ENTER**.
  - All settings are reset to the initial factory settings.

These codes can be used to select other languages. This does not affect the options in “AUDIO”, “SUBTITLE” or “DISC MENU”.

Abkhazian	6566	Gaelic	7168	Macedonian	7775	Sardinian	8367
Afar	6565	Gallegan	7176	Malagasy	7771	Scottish Gaelic	7168
Afrikaans	6570	Georgian	7565	Malay	7783	Serbian	8382
Albanian	8381	German	6869	Malayalam	7776	Shona	8378
Amharic	6577	Gikuyu	7573	Maltese	7784	Sindhi	8368
Arabic	6582	Greek	6976	Manx	7186	Sinhalese	8373
Armenian	7289	Guarani	7178	Maori	7773	Slovak	8375
Assamese	6583	Gujarati	7185	Marathi	7782	Slovenian	8376
Avestan	6569	Hausa	7265	Marshallese	7772	Somali	8379
Aymara	6589	Hebrew	7269	Moldavian	7779	Sotho, Southern	8384
Azerbaijani	6590	Herero	7290	Mongolian	7778	South Ndebele	7882
Bashkir	6665	Hindi	7273	Nauru	7865	Spanish	6983
Basque	6985	Hiri Motu	7279	Navaho	7886	Sundanese	8385
Belarusian	6669	Hungarian	7285	Navajo	7886	Swahili	8387
Bengali	6678	Icelandic	7383	Ndebele, North	7868	Swati	8383
Bihari	6672	Ido	7379	Ndebele, South	7882	Swedish	8386
Bislama	6673	Indonesian	7368	Ndonga	7871	Tagalog	8476
Bokmål, Norwegian	7866	Interlingua (International)	7365	Nepali	7869	Tahitian	8489
Bosnian	6683	Interlingue	7369	Northern Sami	8369	Tajik	8471
Breton	6682	Inuktitut	7385	North Ndebele	7868	Tamil	8465
Bulgarian	6671	Inupiaq	7375	Norwegian	7879	Tatar	8484
Burmese	7789	Irish	7165	Norwegian Bokmål	7866	Telugu	8469
Castilian	6983	Italian	7384	Norwegian Nynorsk	7878	Thai	8472
Catalan	6765	Japanese	7465	Nyanja	7889	Tibetan	6679
Chamorro	6772	Javanese	7486	Nynorsk, Norwegian	7878	Tigrinya	8473
Chechen	6769	Kalaallisut	7576	Occitan (post 1500)	7967	Tonga (Tonga Islands)	8479
Chewa	7889	Kannada	7578	Old Bulgarian	6785	Tsong	8483
Chichewa	7889	Kashmiri	7583	Old Church Slavonic	6785	Tswana	8478
Chinese	9072	Kazakh	7575	Old Slavonic	6785	Turkish	8482
Chuang	9065	Khmer	7577	Oriya	7982	Turkmen	8475
Church Slavic	6785	Kikuyu	7573	Oromo	7977	Twi	8487
Church Slavonic	6785	Kinyarwanda	8287	Ossetian	7983	Uighur	8571
Chuvash	6786	Kirghiz	7589	Ossetic	7983	Ukrainian	8575
Cornish	7587	Komi	7586	Pali	8073	Urdu	8582
Corsican	6779	Korean	7579	Panjabi	8065	Uzbek	8590
Croatian	7282	Kuanyama	7574	Persian	7065	Vietnamese	8673
Czech	6783	Kurdish	7585	Polish	8076	Volapük	8679
Danish	6865	Kwanyama	7574	Portuguese	8084	Walloon	8765
Dutch	7876	Lao	7679	Provençal	7967	Welsh	6789
Dzongkha	6890	Latin	7665	Pushto	8083	Wolof	8779
English	6978	Latvian	7686	Quechua	8185	Xhosa	8872
Esperanto	6979	Letzeburgesch	7666	Raeto-Romance	8277	Yiddish	8973
Estonian	6984	Limburgan	7673	Romanian	8279	Yoruba	8979
Faroese	7079	Limburger	7673	Rundi	8278	Zhuang	9065
Fijian	7074	Limburgish	7673	Russian	8285	Zulu	9085
Finnish	7073	Lingala	7678	Samoan	8377		
French	7082	Lithuanian	7684	Sango	8371		
Frisian	7089	Luxembourgish	7666	Sanskrit	8365		

# Troubleshooting

Refer to the chart below when this unit does not function properly. If the problem you are experiencing is not listed below or if the instruction below does not help, set this unit to the standby mode, disconnect the power cable, and contact the nearest authorized Yamaha dealer or service center.

Problem	Solution
<b>No power</b>	Connect the AC power cable properly.
	Press STANDBY/ON on the front panel to turn on the power.
<b>No picture</b>	Refer to the manual supplied with your TV to select the video input channel correctly. Change the TV channel until you see the DVD screen.
	Turn on your TV.
	Check the video connection.
	Video signals other than HDMI signals are not output when HD JPEG pictures are displayed (see “HD JPEG” on page 31).
<b>No picture is displayed when you make HDMI connections (using the HDMI jacks)</b>	Follow the steps below to change the [HDMI VIDEO] to [AUTO]. <ol style="list-style-type: none"> <li>1. Press OPEN/CLOSE (  ) on the front panel or press and hold  on the remote control to open the disc tray.</li> <li>2. Press  on the remote control.</li> <li>3. Press SUBTITLE on the remote control.</li> </ol>
<b>No picture is displayed when you do not use progressive scan connections (using the component video jacks)</b>	Follow the steps below to turn off the progressive scan. <ol style="list-style-type: none"> <li>1. Press OPEN/CLOSE (  ) on the front panel or press and hold  on the remote control to open the disc tray.</li> <li>2. Press  on the remote control.</li> <li>3. Press ZOOM on the remote control to deactivate the progressive scan.</li> </ol>
<b>Completely distorted picture or black/white picture or no picture</b>	Check that the disc is compatible with this unit (see “Playable disc formats” on page 3).
	Check that the TV type of this unit is set to match that of the disc and your TV (see “Setting a color system for your TV” on page 13). Follow the steps below to change the setting of [TV TYPE]. <ol style="list-style-type: none"> <li>1. Press OPEN/CLOSE (  ) on the front panel or press and hold  on the remote control to open the disc tray.</li> <li>2. Press  on the remote control.</li> <li>3. Press AUDIO on the remote control.</li> </ol>
<b>Distorted picture</b>	Occasionally, a small amount of picture distortion may appear depending on the disc being played back. This is not a malfunction.
<b>The screen size looks unnatural, or the caption is displayed only partially on the TV monitor or is not displayed at all</b>	Check that the TV setting of this unit matches the screen size of your TV (see “Setting the TV display” on page 27).
	Change the screen size and the aspect ratio of your TV.



Problem	Solution
<b>No sound or distorted sound</b>	Adjust the volume.
	Check that the speakers are connected correctly.
	For MP3/WMA, check that the sampling rate and bit rate are compatible with this unit (see “Specifications” on page 41).
<b>No audio at digital output</b>	Check the digital connections.
	If you are playing a DTS source, check that your receiver can decode DTS, and that [DIGITAL OUTPUT] is set to [ALL] (see page 25).
	If you are playing an MPEG-2 source, check that your receiver can decode MPEG-2. Otherwise, check that [DIGITAL OUTPUT] is set to [MPEG → PCM] (see page 25).
	Check that the audio format of the selected audio language matches your receiver capabilities.
<b>Disc does not play</b>	The CD-R/RW, DVD+R/RW/R DL and DVD-R/RW/R DL must be finalized.
	Check that the disc label is facing up.
	Check whether the disc is defective by trying another disc.
	If you have recorded a JPEG, MP3 or WMA disc yourself, check that your disc contains at least ten JPEG picture files or five MP3/WMA music tracks.
	For MP3/WMA, check that the sampling rate and bit rate are compatible. For JPEG, check that the resolution is compatible (see “Specifications” on page 41).
	Check the region code (see “Region codes” on page 3).
<b>Picture freezes momentarily during playback</b>	Check the disc for fingerprints/scratches and clean it with a soft cloth wiping from center to edge.
<b>This unit does not respond to the remote control</b>	Aim the remote control directly at the remote control sensor on the front panel.
	Reduce the distance of the remote control from this unit.
	Replace the batteries in the remote control.
	Reinsert the batteries with their polarities (+/- signs) as indicated.
<b>Buttons do not work</b>	To completely reset this unit, unplug the AC cord from the AC outlet for 5-10 seconds.
<b>This unit does not respond to some operating commands during playback</b>	Some operations may not be permitted by the disc. Refer to the instructions of the disc jacket.
	The ▲/▼ key is not available during HD JPEG playback.
<b>This unit cannot read CD or DVD</b>	Use a commonly available CD/DVD lens cleaner to clean the lens before sending this unit for repair.

# Troubleshooting

Problem	Solution
<b>“NO DISC” appears in the front panel display</b>	Check that the disc is placed in the disc tray correctly.
<b>“UN DISC” appears in the front panel display</b>	The disc being loaded is not supported by this unit. Check the disc type (see “Playable disc formats” on page 3).
<b>Menu items cannot be selected</b>	Press <b>■</b> twice on the remote control before selecting the setup menu.
	Depending on the disc availability, some menu items cannot be selected.
	To select [HD JPEG], check that the HDMI component is connected correctly and the HDMI video signals with 720p or 1080i are output.
<b>HD JPEG pictures cannot be displayed</b>	Check that [HD JPEG] is set to [ON] (see page 31).
	The disc reading time may exceed 30 seconds.
	MP3 music and HD JPEG pictures cannot be played simultaneously.
<b>No sound during DivX movie playback</b>	The audio code may not be supported by this unit.
<b>The USB device cannot be recognized</b>	Check that the USB device is connected correctly.
	Some devices may not work even if they are USB mass storage class devices.
	Set this unit to the standby mode, and then turn it on again.
	Disconnect the device when this unit is in the standby mode, then connect it again and turn on this unit.
	Connect the AC adapter if the adapter is supplied with the device.
	If “Device not supported” appears on the TV screen, check whether the device is supported by this unit (see “Supported USB devices” on page 21).
	If “USB current protection active. Device not supported” appears on the TV screen, the device is not playable with this unit (see page 21).

### ■ Analog

Sound that has not been converted into numerical values. Analog sound varies, while digital sound has specific numerical values. These jacks send audio through two channels, the left and right.

### ■ Aspect ratio

The ratio of vertical and horizontal sizes of a displayed image. The horizontal vs. vertical ratio of conventional TVs is 4:3, and that of widescreens is 16:9.

### ■ Audio output jacks

Jacks on the back of the DVD player that send audio to another system (TV, Stereo, etc.).

### ■ Bit rate

The amount of data used to hold a given length of music, measured in kilobits per seconds, or kbps. Or, the speed at which you record. Generally, the higher the bit rate, or the higher the recording speed, the better the sound quality. However, higher bit rates use more space on a Disc.

### ■ Chapter

Sections of a picture or a music piece on a DVD that are smaller than titles. A title is composed of several chapters. Each chapter is assigned a chapter number enabling you to locate the chapter you want.

### ■ Component video output jacks

Jacks on the back of the DVD player that send high-quality video to a TV that has component video input jacks (R/G/B, Y/Pb/Pr, etc.).

### ■ Disc menu

A screen display prepared for allowing selection of images, sounds, subtitles, multi-angles, etc. recorded on a DVD.

### ■ Digital

Sound that has been converted into numerical values. Digital sound is available when you use the digital audio output jacks. These jacks send audio through multiple channels, instead of just two channels as analog does.

### ■ DivX

DivX is a popular media technology created by DivX, Inc. DivX media files contain highly compressed video with high visual quality while maintaining a relatively small file size. DivX files can also include advanced media features like menus, subtitles, and alternate audio tracks. Many DivX media files are available for download online, and you can create your own using your personal content and easy-to-use tools from DivX.com.

### ■ DivX Ultra

DivX Ultra Certified products provide enhanced playback of advanced media features supported by the DivX Media Format. Key features include interactive video menus, subtitles, alternate audio tracks, video tags and chapter points.

### ■ DMF (DivX Media Format)

The DivX Media Format supports advanced media features, adding controls for an interactive media experience: interactive video menus, chapter points, multi-language subtitles and alternate audio tracks.

### ■ Dolby Digital

A surround sound system developed by Dolby Laboratories containing up to six channels of digital audio (front left and right, surround left and right, center and subwoofer).

### ■ DTS

Digital Theatre Systems. This is a surround sound system, but it is different from Dolby Digital. The formats were developed by different companies.

### ■ HDMI

HDMI (High-Definition Multimedia Interface) is the first industry-supported, uncompressed, all-digital A/V (audio/video) interface. Providing an interface between any A/V source (such as a set-top box or A/V receiver) and an audio/video monitor (such as a digital television-DTV), HDMI supports standard, enhanced or high-definition video as well as multi-channel digital audio using a single cable. HDMI transmits all ATSC HDTV standards and supports 8-channel digital audio, with bandwidth extra to accommodate future enhancements and requirements.

When used in combination with HDCP (High-bandwidth Digital Content Protection), HDMI provides a secure audio/video interface that meets the security requirements of content providers and system operations. For further information on HDMI, visit the HDMI website at "[www.hdmi.org/](http://www.hdmi.org/)".

### ■ HDCP

HDCP (High-bandwidth Digital Content Protection) developed by Intel corporation, is a method to encrypt digital video and audio data for purpose of content protection. For further information on HDCP, visit the HDCP website at "[www.digital-cp.com](http://www.digital-cp.com/)".

### ■ HD JPEG

HD (High-Definition) JPEG provides images in their enhanced resolution via HDMI connection.

# Glossary

---

## ■ **Interactive menu**

Interactive video menus offer unprecedented convenience and control so you can quickly navigate between various scenes or bonus features, and select from audio track and subtitle options.

## ■ **JPEG**

A very common digital still picture format. A still-picture data compression system proposed by the Joint Photographic Expert Group, which features small decrease in image quality in spite of its high compression ratio.

## ■ **MP3**

A file format with a sound data compression system. "MP3" is the abbreviation of Motion Picture Experts Group 1 (or MPEG-1) Audio Layer 3. By using MP3 format, one CD-R or CD-RW can contain about ten times as much data as a regular CD can.

## ■ **Parental control**

A function of the DVD to limit playback of the disc by the age of the users according to the limitation level in each country. The limitation varies from disc to disc; when it is activated, playback will be prohibited if the software's level is higher than the user-set level.

## ■ **PCM (Pulse Code Modulation)**

A system for converting analog sound signals to digital signals for later processing, with no data compression used in conversion.

## ■ **Playback control (PBC)**

Refers to the signal recorded on video CDs or SVCDs for controlling reproduction. By using menu screens recorded on a Video CD or SVCD that supports PBC, you can enjoy interactive-type software as well as software having a search function.

## ■ **Play list**

A list of selected titles to be played back in a specific order. This option is only available with VR format and must be created beforehand.

## ■ **Progressive scan**

It displays all the horizontal lines of a picture at one time, as a signal frame. This system can convert the interlaced video from DVD into progressive format for connection to a progressive display. It dramatically increases the vertical resolution.

## ■ **Region code**

A system for allowing discs to be played back only in the region designated beforehand. This unit will only play discs that have compatible region codes. You can find the region code of your unit by looking on the product label. Some discs are compatible with more than one region (or ALL regions).

## ■ **S-video**

Produces a clear picture by sending separate signals for the luminance and the color. You can use S-video only if your TV has S-video input jack.

## ■ **Surround**

A system for creating realistic three dimensional sound fields full of realism by arranging multiple speakers around the listener.

## ■ **Title**

The longest section of a picture or music feature on DVD, music, etc., in video software, or the entire album in audio software. Each title is assigned a title number enabling you to locate the title you want.

## ■ **Video output jack**

Jack on the back of the DVD player that sends video to a TV.

## ■ **VR (Video Recording) format**

A format which enables you to create a DVD disc that can be extensively re-edited.

## PLAYABLE DISC FORMATS

- DVD-Video
- DVD-R, DVD-RW, DVD-R DL
- DVD+R, DVD+RW, DVD+R DL
- Video CD, SVCD
- CD
- PICTURE CD
- CD-R, CD-RW
- MP3 (ISO 9660)..... fs 32, 44.1, 48 kHz /  
96, 128, 256, 320 kbps (CBR only)
- WMA.....fs 44.1 kHz, 62–192 kbps (CBR only) /  
fs 48 kHz, 128–192 kbps (CBR only)
- DivX
- JPEG..... 3072 x 2048 dpi or less

## VIDEO PERFORMANCE

- Video (CVBS) output.....1 Vpp into 75 ohm
- S-Video output.....Y: 1 Vpp into 75 ohm  
C: 0.3 Vpp into 75 ohm
- Component video output.....Y: 1 Vpp into 75 ohm  
Pb Pr: 0.7 Vpp into 75 ohm
- RGB (Scart) output (U.K. and Europe models only)  
..... Y: 0.7 Vpp into 75 ohm

## AUDIO FORMAT

- Digital  
Dolby Digital, DTS, MPEG..... Compressed digital  
PCM..... fs 44.1, 48, 96 kHz / 16, 20, 24 bits
- Analog sound.....Stereo

## AUDIO PERFORMANCE

- DA Converter.....24 bit
- Signal-Noise (1 kHz) ..... 105 dB
- Dynamic range (1 kHz)..... 97 dB
- DVD.....fs 96 kHz, 2 Hz–44 kHz /  
fs 48 kHz, 2 Hz–22 kHz
- SVCD.....fs 48 kHz, 2 Hz–22 kHz /  
fs 44.1 kHz, 2 Hz–20 kHz
- CD, VCD.....fs 44.1 kHz, 2 Hz–20 kHz
- Distortion and Noise (1 kHz)..... 0.0035%

## MULTIMEDIA APPLICATIONS

- Connections..... USB mass storage class device
- Playback formats (USB device)  
MP3..... fs 32, 44.1, 48 kHz /  
96, 128, 256, 320 kbps (CBR only)  
WMA.....fs 44.1 kHz, 62–192 kbps (CBR only) /  
fs 48 kHz, 128–192 kbps (CBR only)  
DivX..... 3 Mbps or less  
JPEG..... 3072 x 2048 dpi or less

## TV STANDARD

- Number of lines.....PAL: 625, NTSC: 525
- Vertical frequency.....PAL: 50 Hz, NTSC: 60 Hz
- Playback..... Multistandard (PAL/NTSC)

## CONNECTIONS

- Video output ..... RCA/Phono x 1 (yellow)
- S-video output..... Mini DIN, 4 pins x 1
- Component video output  
Y output.....RCA/Phono x 1 (green)  
Pb output.....RCA/Phono x 1 (blue)  
Pr output.....RCA/Phono x 1 (red)
- SCART (U.K. and Europe models only)  
..... Euroconnector x 1
- Audio output (L+R)..... RCA/Phono x 1 pair (white/red)
- Digital output  
Coaxial..... RCA/Phono x 1  
(IEC60958 for CDDA, LPCM /  
IEC61937 for MPEG 1/2, Dolby Digital, DTS)  
HDMI..... Type A x 1
- USB..... Type A x 1
- Remote Control  
Input.....  $\phi$  3.5 mm mini jack x 1  
Output.....  $\phi$  3.5 mm mini jack x 1

## CABINET

- Dimensions (W x D x H) .....435 x 310 x 51 mm  
(17-1/8 x 12-3/16 x 2 inch)
- Weight.....Approx. 2.6 kg (5 lbs. 12oz.)

## POWER SUPPLY

- Power inlet  
U.S.A. and Canada models.....AC 120 V, 60 Hz  
U.K. and Europe models.....AC 230 V, 50 Hz  
Australia, Asia, Central and South America models  
.....AC 110-240 V, 50 Hz/60 Hz  
Korea model .....AC 110-240 V, 60 Hz
- Power consumption..... Approx. 14 W
- Standby power consumption..... Less than 1 W

## LASER

Type	Semiconductor laser GaAlAs
Wave length	650 nm (DVD) 780 nm (VCD/CD)
Output Power	7 mW (DVD) 10 mW (VCD/CD)
Beam divergence	60 degrees

Specifications are subject to change without prior notice.



©2007 YAMAHA CORPORATION All rights reserved.

YAMAHA ELECTRONICS CORPORATION, USA 6690 ORANGETHORPE AVE., BUENA PARK, CALIF. 90620, U.S.A.

YAMAHA CANADA MUSIC LTD. 135 MILNER AVE., SCARBOROUGH, ONTARIO M1S 3R1, CANADA

YAMAHA ELECTRONIK EUROPA G.m.b.H. SIEMENSSTR. 22-34, 25462 RELLINGEN BEI HAMBURG, GERMANY

YAMAHA ELECTRONIQUE FRANCE S.A. RUE AMBROISE CROIZAT BP70 CROISSY-BEAUBOURG 77312 MARNE-LA-VALLEE CEDEX02, FRANCE

YAMAHA ELECTRONICS (UK) LTD. YAMAHA HOUSE, 200 RICKMANSWORTH ROAD WATFORD, HERTS WD18 7GQ, ENGLAND

YAMAHA SCANDINAVIA A.B. J Å WETTERGRENS GATA 1, BOX 30053, 400 43 VÄSTRA FRÖLUNDA, SWEDEN

YAMAHA MUSIC AUSTRALIA PTY. LTD. 17-33 MARKET ST., SOUTH MELBOURNE, 3205 VIC., AUSTRALIA

YAMAHA CORPORATION

Printed in China C 3139 245 26181