

TOSHIBA



DVD PLAYER

SD7200KU

SDK990KU

OWNER'S MANUAL



Introduction	2
Connections	11
Basic playback	16
Advanced playback	19
Function setup	29
Others	35

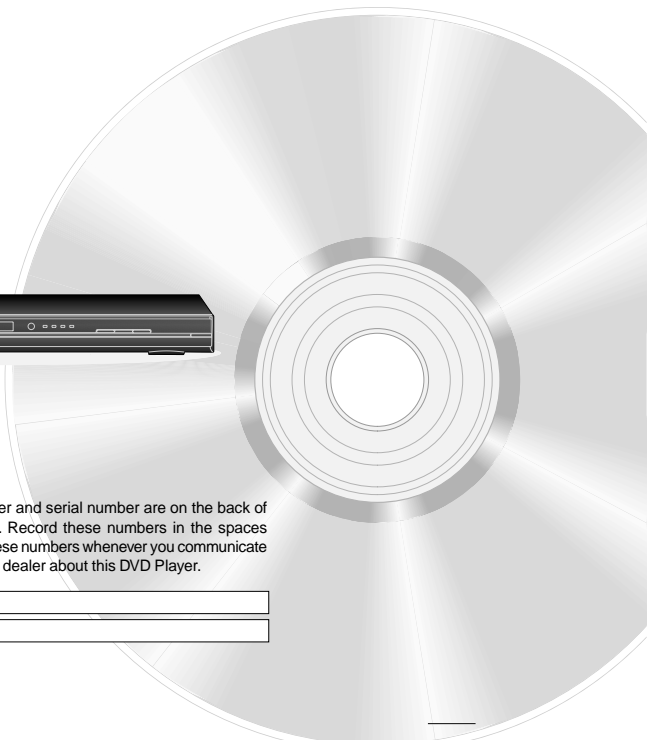

The model number and serial number are on the back of your DVD Player. Record these numbers in the spaces below. Refer to these numbers whenever you communicate with your Toshiba dealer about this DVD Player.

Model number:

Serial number:

SAFETY PRECAUTIONS

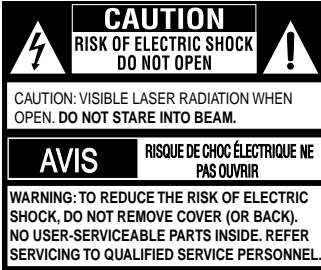

The lightning flash with an arrowhead symbol, within the equilateral triangle, is intended to alert the user to the presence of uninsulated "dangerous voltage" within the product's enclosure that may be of sufficient magnitude to constitute a risk of electric shock to persons.



The exclamation point within the equilateral triangle is intended to alert the user to the presence of important operating and maintenance (servicing) instructions in this owner's manual.



The symbol for Class II (Double Insulation)



WARNING: TO REDUCE THE RISK OF FIRE OR ELECTRIC SHOCK, DO NOT EXPOSE THIS APPLIANCE TO RAIN OR MOISTURE. DANGEROUS HIGH VOLTAGES ARE PRESENT INSIDE THE ENCLOSURE. DO NOT OPEN THE CABINET. REFER SERVICING TO QUALIFIED PERSONNEL ONLY.

CAUTION: TO PREVENT ELECTRIC SHOCK, MATCH WIDE BLADE OF PLUG TO WIDE SLOT OF AC POWER OUTLET, THEN FULLY INSERT.

WARNING: The apparatus shall not be exposed to dripping or splashing and that no objects filled with liquid, such as vases, shall be placed on the apparatus.

CAUTION: This Digital Video Disc Player employs a Laser System.
To ensure proper use of this product, please read this owner's manual carefully and retain for future reference. Should the unit require maintenance, contact an authorized service location.
Use of controls or adjustments or performance of procedures other than those specified herein may result in hazardous radiation exposure.
To prevent direct exposure to laser beam, do not try to open the enclosure.
Visible and invisible laser radiation when open and interlocks defeated.
DO NOT STARE INTO BEAM.

FCC NOTICE: This equipment has been tested and found to comply with the limits for a Class B digital device, pursuant to part 15 of the FCC Rules. These limits are designed to provide reasonable protection against harmful interference in a residential installation. This equipment generates, uses, and can radiate radio frequency energy and, if not installed and used in accordance with the instructions, may cause harmful interference to radio communications. However, there is no guarantee that interference will not occur in a particular installation. If this equipment does cause harmful interference to radio or television reception, which can be determined by turning the equipment off and on, the user is encouraged to try to correct the interference by one or more of the following measures:

- Reorient or relocate the receiving antenna.
- Increase the separation between the equipment and receiver.
- Connect the equipment into an outlet on a circuit different from that to which the receiver is connected.
- Consult the dealer or an experienced radio/TV technician for help.

WARNING: Changes or modifications to this unit not expressly approved by Toshiba, or parties authorized by Toshiba, could void the user authority to operate the equipment.

Warnings:

- The main plug is used as disconnect device and it should remain readily operable during intended used. In order to disconnect the apparatus from the mains completely, the main plug should be disconnected from the mains socket outlet completely.
- Minimum 10 cm (4 inches) distances around the apparatus for sufficient ventilations.
- The ventilation should not be impeded by covering the ventilation openings with items such as newspaper, table-cloths, curtains, etc.
- No naked flame sources such as lighted candles should be placed on the apparatus.
- The use of apparatus in moderate climates.



ENERGY STAR® qualified DVD. Products that earn the ENERGY STAR prevent green house gas emissions by meeting strict energy efficiency guidelines set by the U.S. Environmental Protection Agency and the U.S. Department of Energy. ENERGY STAR and the ENERGY STAR mark are registered U.S. marks.

IMPORTANT SAFETY INSTRUCTIONS

1. Read these instructions.
2. Keep these instructions.
3. Heed all warnings.
4. Follow all instructions.
5. Do not use this apparatus near water.
6. Clean only with a dry cloth.
7. Do not block any of the ventilation openings. Install in accordance with the manufacturer's instructions.
8. Do not install near any heat sources such as radiators, heat registers, stoves, or other apparatus (including amplifiers) that produce heat.
9. Do not defeat the safety purpose of the polarized or grounding-type plug. A polarized plug has two blades with one wider than the other. A grounding type plug has two blades and a third grounding prong. The wide blade or the third prong is provided for your safety. If the provided plug does not fit into your outlet, consult an electrician for replacement of the obsolete outlet.
10. Protect the power cord from being walked on or pinched particularly at plugs, convenience receptacles, and the point where they exit from the apparatus.
11. Only use attachments/accessories specified by the manufacturer.
12. Use only with the cart, stand, tripod, bracket, or table specified by the manufacturer, or sold with the apparatus. When a cart is used, use caution when moving the cart/apparatus combination to avoid injury from tip-over.
13. Unplug this apparatus during lightning storms or when unused for long periods of time.
14. Refer all servicing to qualified service personnel. Servicing is required when the apparatus has been damaged in any way, such as the power-supply cord or plug is damaged, liquid has been spilled or objects have fallen into the apparatus, the apparatus has been exposed to rain or moisture, does not operate normally, or has been dropped.



Portable Cart Warning

ADDITIONAL SAFETY INSTRUCTIONS

15. Do not overload wall outlets; extension cords, or integral convenience receptacles as this can result in a risk of fire or electric shock.
16. Never expose the apparatus to dripping or splashing or place items such as vases, aquariums, any other item filled with liquid, or candles on top of the unit.
17. Keep your fingers well clear of the disc tray as it is closing. Neglecting to do so may cause serious personal injury.
18. Do not place anything on top of this unit.
19. Do not place the apparatus on amplifiers or equipment that may produce heat.
20. Never block or cover the slots or openings in the unit.
Never place the unit:
 - on a bed, sofa, rug or similar surface;
 - too close to drapes, curtains, or walls; or
 - in a confined space such as a bookcase, built-in cabinet, or any other place with poor ventilation.The slots and openings are provided to protect the unit from overheating and to help maintain reliable operation.
21. Do not use a cracked, deformed, or repaired disc. These discs are easily broken and may cause serious personal injury and apparatus malfunction.
22. If the apparatus should emit smoke or an unusual odor, immediately disconnect the power cord from the wall outlet. Wait until the smoke or smell stops, then ask your dealer for a check and repair. Neglecting to do so may cause fire.
23. During thunderstorms, do not touch the connecting cables or the apparatus.
24. Warning: To prevent spread of fire, keep candles or other open flames away from this product at all times.

Location of the required label

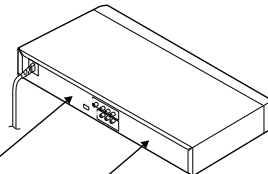

The rating plate and the safety caution are on the rear of the unit.

Precautions

Notes on handling

- When shipping the DVD player, the original shipping carton and packing materials come in handy. For maximum protection, repack the unit as it was originally packed at the factory. Take care not to give it a shock or shake when carrying.
- Do not use volatile liquids, such as insect spray, near the DVD player. Do not leave rubber or plastic products in contact with the DVD player for a long time. They will leave marks on the finish.
- The top and rear panels of the DVD player may become warm after a long period of use. This is not a malfunction.
- When the DVD player is not in use, be sure to remove the disc and turn off the power.
- If you do not use the DVD player for a long period, the unit may not function properly in the future. Turn on and use the DVD player occasionally.

Notes on locating

- Place the DVD player on a level surface. Do not use it on a shaky or unstable surface such as a wobbling table or inclined stand. The loaded disc may come off the proper position and cause damage to the DVD player.
- When you place this DVD player near a TV, radio, or VCR, the playback picture may become poor and the sound may be distorted. In this case, place the DVD player away from the TV, radio, or VCR.

Notes on cleaning

- Use a soft, dry cloth for cleaning.
- For stubborn dirt, soak the cloth in a weak detergent solution, wring well and wipe. Use a dry cloth to wipe it dry.
- Do not use any type of solvent, such as thinners and benzene, as they may damage the surface of the DVD player.
- If you use a chemical saturated cloth to clean the unit, follow that product's instructions.

Inspection and Maintenance

This DVD player is a high technology, precision device. If the optical pick-up lens and disc drive parts become dirty or worn down, the picture quality may be reduced. To avoid reduction in picture quality, it is recommended that regular inspection and maintenance (cleaning or parts replacement) be performed every 1,000 hours of use. For further details, contact your nearest consumer electronics dealer.

Notes on moisture condensation

Moisture condensation damages the DVD player. Please read the following carefully.

Moisture condensation occurs, for example, when you pour a cold drink into a glass on a warm day. Drops of water form on the outside of the glass. In the same way, moisture may condense on the optical pick-up lens inside this unit, one of the most crucial internal parts of the DVD player.

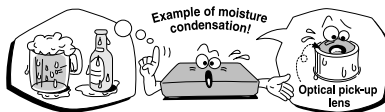

- Moisture condensation occurs during the following cases.

- When you bring the DVD player directly from a cold place to a warm place.
- When you use the DVD player in a room where you just turned on the heater, or a place where the cold wind from the air conditioner directly hits the unit.
- In summer, when you use the DVD player in a hot and humid place just after you move the unit from an air conditioned room.
- When you use the DVD player in a humid place.

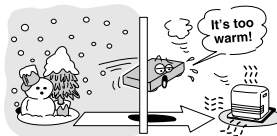

- Do not use the DVD player when moisture condensation may occur.

If you use the DVD player in such a situation, it may damage discs and internal parts. Remove the disc, connect the power cord of the DVD player to the wall outlet, turn on the DVD player, and leave it for two or three hours. After two or three hours, the DVD player will have warmed up and evaporated any moisture. Keep the DVD player connected to the wall outlet and moisture condensation will seldom occur.

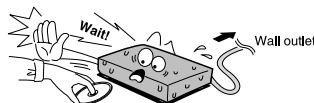

Notes on Discs

On handling discs

- Do not touch the playback side of the disc.

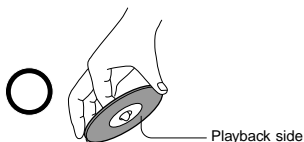

- Do not attach paper or tape to discs.



On cleaning discs

- Fingerprints and dust on the disc cause picture and sound deterioration. Wipe the disc from the center outwards with a soft cloth. Always keep the disc clean.



- If you cannot wipe off the dust with a soft cloth, wipe the disc lightly with a slightly moistened soft cloth and finish with a dry cloth.
- Do not use any type of solvent such as thinner, benzene, commercially available cleaners or antistatic spray for vinyl LPs. It may damage the disc.

On storing discs

- Do not store discs in a place subject to direct sunlight or near heat sources.
- Do not store discs in places subject to moisture and dust such as a bathroom or near a humidifier.
- Store discs vertically in a case. Stacking or placing objects on discs outside of their case may cause warping.

Structure of disc contents

Normally, DVDs are divided into titles, and the titles are sub-divided into chapters. VIDEO CDs and audio CDs are divided into tracks.

DVD

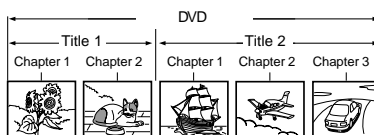

VIDEO CD/audio CD



Each title, chapter or track is assigned a number, which is called "title number", "chapter number" or "track number" respectively.

There may be discs that do not have these numbers.

Notes on copyright

The unauthorized recording, use, distribution, or revision of copyrighted materials including, without limitation, television programs, videotapes, and DVDs, is prohibited under the Copyright Laws of the United States and other countries, and may subject you to civil and criminal liability.

This product incorporates copyright protection technology that is protected by method claims of certain U.S. patents and other intellectual property rights owned by Macrovision Corporation and other rights owners. Use of this copyright protection technology must be authorized by Macrovision Corporation, and is intended for home and other limited viewing uses only unless otherwise authorized by Macrovision Corporation. Reverse engineering or disassembly is prohibited.



Notes on Discs (continued)

About this owner's manual

This owner's manual explains the basic instructions of this DVD player. Some DVDs are produced in a manner that allows specific or limited operation during playback. As such, the DVD player may not respond to all operating commands. This is not a defect in the DVD player. Refer to instruction notes of discs.

"⊘" may appear on the TV screen during operation. A "⊘" means that the operation is not permitted by the DVD player or the disc.

About



The    icons on the heading bar show the playable discs for the function described under that heading.

 : You can use this function with DVD discs.

 : You can use this function with Video CDs.

 : You can use this function with Audio CDs/CD-R/RW CDs.

Notes on region numbers

The region number of this DVD player is 1. If region numbers, which stand for their playable area, are printed on your DVD and you do not find  or , disc playback will not be allowed by the player. (In this case, the DVD player will display a message on-screen.)

On VIDEO CDs

This DVD player supports VIDEO CDs equipped with the PBC (Version 2.0) function. (PBC is the abbreviation of Playback Control.) You can enjoy two playback variations depending on types of discs.

- VIDEO CD not equipped with PBC function (Version 1.1) Sound and movie can be played on this DVD player in the same way as an audio CD.
- VIDEO CD equipped with PBC function (Version 2.0) In addition to operation of a VIDEO CD not equipped with the PBC function, you can enjoy playback of interactive software with search function by using the menu displayed on the TV screen (Menu Playback). Some of the functions described in this owner's manual may not work with some discs.

Playable discs

This DVD player can play the following discs.

	Disc Mark	Contents	Disc Size	Maximum playback time
DVDs		Audio + video (moving pictures)	12 cm	Approx. 4 hours (single sided disc)
				Approx. 8 hours (double sided disc)
			8 cm	Approx. 80 minutes (single sided disc)
				Approx. 160 minutes (double sided disc)
VIDEO CDs		Audio + video (moving pictures)	12 cm	Approx. 74 minutes
			8 cm	Approx. 20 minutes
Audio CDs		Audio	12 cm	Approx. 74 minutes
			8 cm (CD single)	Approx. 20 minutes
SUPER VIDEO CDs		Audio + video (moving pictures)	12 cm	35 min.
			8 cm	10 min.
DivX®		Audio + video (moving pictures)	12 cm	It depends on DivX® quality
			8 cm	

The following discs are also available.

- DVD±R/RW and DVD-ROM discs of DVD format
 - CD-R/CD-RW discs of CD-DA, Video CD, MP3, WMA or JPEG format
 - Official DivX® Certified product
 - Plays all versions of DivX® video (including DivX® 6) with standard playback of DivX® media files
- Some of these discs may be incompatible.

- You cannot play discs other than those listed above.
- You cannot play DVD-RAM discs or non-standardized discs, etc., even if they may be labeled as above.
- This DVD player uses the NTSC color system, and cannot play DVDs recorded in any other color system (PAL, SECAM, etc.).

Because of problems and errors that can occur during the creation of DVD and CD software and/or the manufacture of DVD and CD discs, Toshiba cannot assure that this DVD player will successfully play every disc bearing the DVD and CD logos. If you happen to experience any difficulty playing a DVD and/or CD disc on this DVD player, please contact Toshiba Customer Service.

 is a trademark of DVD Format/Logo Licensing Corporation.

Table of Contents

Introduction

● SAFETY PRECAUTIONS	2
● IMPORTANT SAFETY INSTRUCTIONS	3
● Precautions	4
● Notes on Discs	5
Notes on region numbers	6
● Table of Contents	7
● Identification of Controls	8
Front panel	8
Rear panel	8
DVD display	8
Remote control	9
Loading batteries	10
Operating with the remote control	10

Connections

● Connecting to a TV	11
Connecting to a TV	11
Connecting to a TV (Using the component video jacks)	11
Connecting to a display (Using a HDMI™ cable)	12
● Connecting to Optional Equipment	13
Connecting to an amplifier equipped with a Dolby® Digital decoder	14
Connecting to an amplifier equipped with Dolby Surround Pro Logic	14
Connecting to an amplifier equipped with a DTS® decoder	15
Connecting to an amplifier equipped with an MPEG2 audio decoder	15
Connecting to an amplifier equipped with a digital audio input	15

Basic playback

● Playing a Disc	16
Basic playback	16
● Variable Speed Playback	17
Playing in fast reverse or fast forward directions ..	17
Playing frame by frame	17
Playing in slow-motion	17
Resuming playback from the same location	17
● Locating a Desired Section	18
Locating a title using the top menu	18
Locating a specific chapter or track	18

Advanced playback

● Accessing a Specific Location Directly	19
Locating a specific title/chapter/time	19
● Repeating a Specific Segment	20
Repeating a specific segment	20
● Playing in a Varied Order	20
Playing titles, chapters or tracks in a varied order ..	20
● Playing in a Favorite Order	21
Setting titles, chapters or tracks in a favorite order ..	21
● Zooming a Picture	22
Zooming a picture	22
● Selecting the Sound Enhancement (E.A.M.)	22
Selecting the sound enhancement	22
● Selecting the Picture Enhancement (E.P.M) ..	23
Selecting the picture enhancement	23
● Selecting Subtitles	23
Selecting a subtitle language	23
● Selecting the Camera Angle	24
Changing the camera angle	24
● Selecting a Language	24
Selecting a playback audio setting	24
● On-screen Display Operation	25
On-screen display operation	25
● Playing MP3/WMA Files	26
Playing MP3/WMA files	26
● Viewing JPEG Files	27
Viewing JPEG files	27
Viewing a thumbnail view	27
● Playing DivX®/MPEG-4 Files	28
Playing DivX®/MPEG-4 files	28

Function setup

● Customizing the Function Settings	29
Setting procedure	29
Setting details	29

Others

● Table of Languages	35
● Before Calling Service Personnel	36
● Specifications	37
● Limited Warranty	38

Identification of Controls

See the page in □ for details.

Front panel

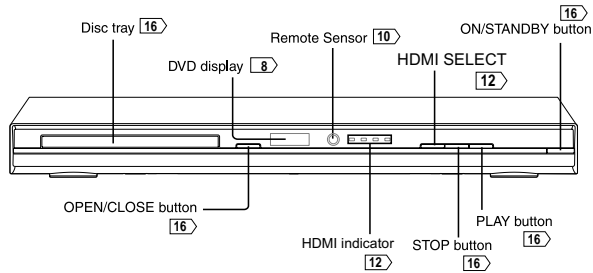

Rear panel

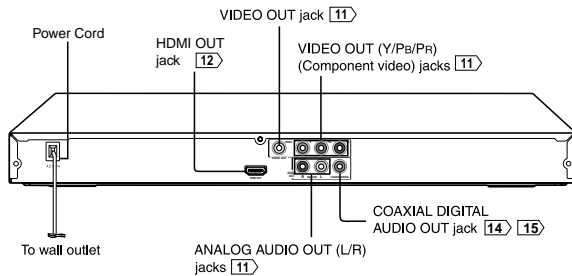

DVD display

The indicators vary depending on the kinds of discs you play.

<p>No disc</p>	<p>Bad disc</p>	<p>OPEN</p>	<p>LOAD/CLOSE</p>	<p>Power off</p>
<p>DVD VIDEO</p> <ul style="list-style-type: none"> • During playback: Example <p>Some discs may only display chapter numbers.</p>	<p>VIDEO CD</p> <ul style="list-style-type: none"> • During playback: Example <p>Some discs may only display track numbers.</p>	<p>Audio CD</p> <ul style="list-style-type: none"> • During playback: Example <p>Some discs may only display track numbers.</p>	<p>Picture</p> <ul style="list-style-type: none"> • During thumbnail viewing 	<p>Chapter/Track number Indicator</p> <p>Multifunctional indicator (indicates operating status or messages, etc.)</p>

Remote control

The instructions in this manual describe the functions on the remote control. See the page in □ for details.

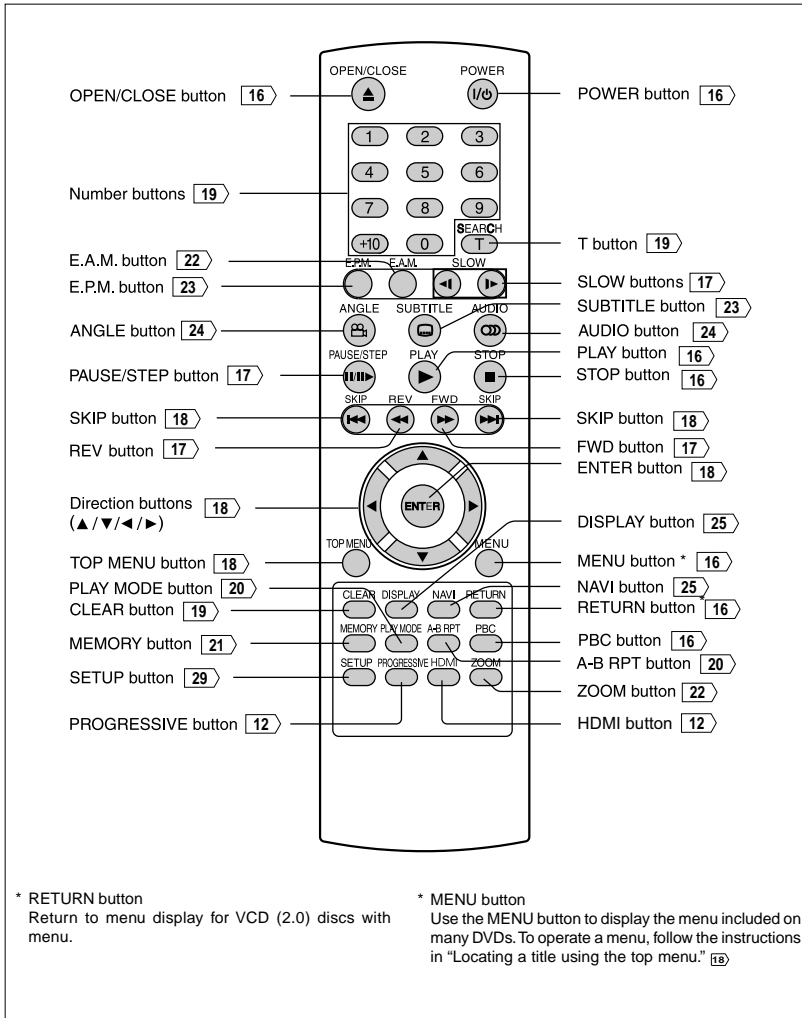

Identification of Controls (continued)

Loading batteries

1 Open the cover.

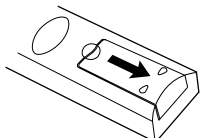

2 Insert batteries (R03/AAA size).

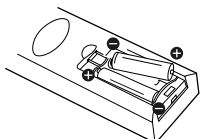

Make sure to match the + and – on the batteries to the marks inside the battery compartment.

Caution

Never throw batteries into a fire.

Notes

- Be sure to use R03/AAA size batteries.
- Dispose of batteries in a designated disposal area.
- Attention should be drawn to the environmental aspects of battery disposal.
- Do not mix different battery types or combine used batteries with new ones.
- If the remote control does not operate correctly, or if the operating range becomes reduced, replace both batteries with new ones.
- If the batteries are dead or if you will not be using the remote control for a long time, remove the batteries to prevent battery acid from leaking into the battery compartment.

Operating with the remote control

Point the remote control at the remote sensor and press the buttons.

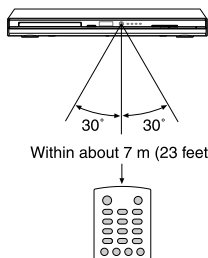

Distance: About 7 m (23 feet) from the front of the remote sensor

Angle: About 30° in each direction of the front of the remote sensor

* Do not expose the remote sensor of the DVD player to a strong light source such as direct sunlight or other illumination. If you do so, you may not be able to operate the DVD player via the remote control.

Notes on the remote control

- Direct the remote control at the remote sensor of the DVD player.
- When using the remote control, press the buttons at intervals of about 1 second to ensure the correct mode of operation.
- Do not drop or give the remote control a shock.
- Do not leave the remote control near an extremely hot or humid place.
- Do not spill water or put anything wet on the remote control.
- Do not open the remote control.
- If the remote control is not going to be used for a long time, remove the battery to avoid damage caused by battery leakage corrosion.

CAUTIONS:

- Danger of explosion if battery is incorrectly replaced. Replace only with the same or equivalent type.
- Batteries shall not be exposed to excessive heat such as sunshine, fire or the like.
- Do not dispose of battery in fire; battery may explode or leak.
- When discarding batteries, environmental problems must be considered and local rules or laws governing the disposal of these batteries must be strictly followed.

Connecting to a TV

Connect the DVD player to your TV.

Connecting to a TV

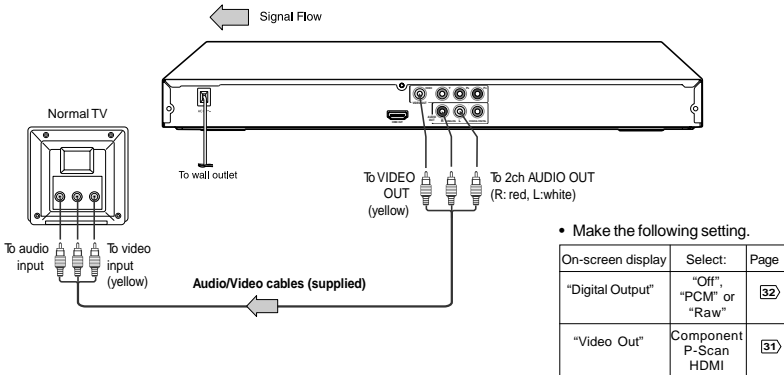

Notes

- Refer to the owner's manual of the connected TV as well.
- When you connect the DVD player to your TV, be sure to turn off the power and unplug both units from the wall outlet before making any connections.
- If your television set has one audio input, connect the left and right audio outputs of the DVD player to a Y cable adapter (not supplied) and then connect to your TV.
- Connect the DVD player directly to your TV. If you connect the DVD player to a VCR, TV/VCR combination or video selector, the playback picture may be distorted as DVDs are copy protected.
- Analog audio out will not have sound if DTS playback is selected.

Connecting to a TV (Using the component video jacks)

Interlaced outputs (ColorStream®)

Some TVs or monitors are equipped with component video inputs. Connecting to these inputs allows you to enjoy higher quality picture playback.

Actual labels for component video inputs may vary depending on the TV manufacturer. (ex. Y, R-Y, B-Y or Y, Cs, Cr)

In some TVs or monitors, the color levels of the playback picture may be reduced slightly or the tint may change. In such a case, adjust the TV or monitor for optimum performance.

Progressive outputs (ColorStream Pro®)

Some TVs or monitors are equipped with component video inputs that are capable of reproducing a progressively scanned video signal. Connecting to these inputs allows you to view the highest quality pictures with less flicker.

Consumers should note that not all high definition television sets are fully compatible with this product and may cause artifacts to be displayed in the picture. In case of 480 progressive scan picture problems, it is recommended that the user switch the connection to the "standard definition" output. If there are questions regarding our TV set compatibility with this model 480p DVD player, please contact our Customer Service Center.

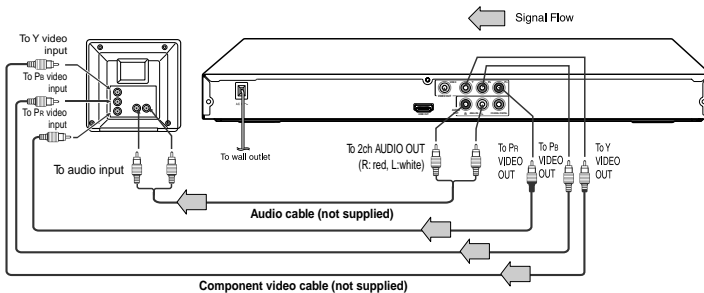

■ **Switching the output signal (interlaced / progressive) using the remote control**

You can temporarily switch the output signal for better picture quality. Press **PROGRESSIVE** button repeatedly on the remote control to select Video Output to P-Scan mode during stop.

If your TV does not support the progressive scan format, the picture will appear scrambled or blank. To return to normal picture, press **PROGRESSIVE** button repeatedly to turn off progressive mode.

Notes

- Refer to the owner's manual of the connected equipment as well.
- When you connect the DVD player to other equipment, be sure to turn off the power and unplug all of the equipment from the wall outlet before making any connections.
- If you place the DVD player near a tuner or radio, the radio broadcast sound might be distorted. In this case, place the DVD player away from the tuner and radio.
- The output sound of the DVD player has a wide dynamic range. Be sure to adjust the receiver's volume to a moderate listening level. Otherwise, high volume sound may damage your hearing as well as the speakers.
- Turn off the amplifier before you connect or disconnect the DVD player's power cord. If you leave the amplifier power on, the speakers may be damaged.
- Analog audio out will not have sound if DTS playback is selected.
- ColorStream® and ColorStream Pro® are registered trademarks of Toshiba America Consumer Products L.L.C.

- Make the following setting.

On-screen display	Select:	Page
"Digital Output"	"PCM" or "Raw"	[32]
"Video Out"	Component "P-Scan (Progressive)"	[31]

* Only for TV equipped with component video input jacks which support the progressive scan.

Connecting to a display (Using a HDMI™ cable)

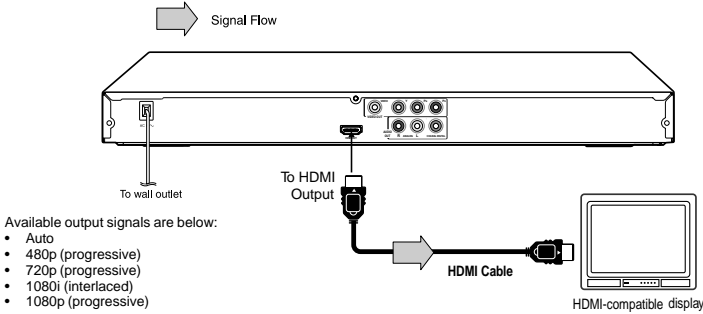

■ **Switching the video quality (HDMI mode) using HDMI button on the remote control or HDMI SELECT button on the front panel.**

Press **HDMI** button on the remote control or **HDMI SELECT** button on the front panel to receive a suitable video quality in STOP mode. The video quality is required to match your TV having HDMI feature and suitable quality. Please also check your TV owner's manual. Press this button to change the output signals as below. See the HDMI indicator and select the appropriate output signal.

- Make the following setting.

On-screen display	Select:	Page
"Digital Output"	"PCM"	[32]
"Video Out"	HDMI	[31]

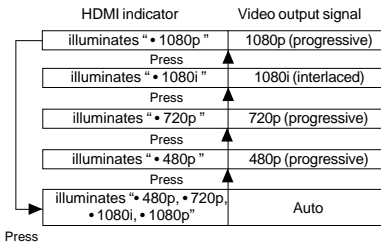

480p, 720p, 1080i and 1080p are signals created with this DVD Player from original 480i signal. The resolution of the picture may not be increased even if they are selected.

About HDMI

HDMI (High Definition Multimedia Interface) supports both video and audio on a single digital connection for use with DVD players, DTV, set-top boxes, and other AV devices. HDMI was developed to provide the technologies of High Bandwidth Digital Content Protection (HDCP) as well as Digital Visual Interface (DVI) in one specification. HDCP is used to protect digital content transmitted and received by DVI-compliant or HDMI-compliant displays.

HDMI has the capability to support standard, enhanced, or high-definition video plus standard to multi-channel surround-sound audio. HDMI features included uncompressed digital video, a bandwidth of up to 2.2 gigabytes per second (with HDTV) signals, one connector (instead of several cables and connectors), and communication between the AV source and AV devices such as DTVs.

HDMI, the HDMI logo and High-Definition Multimedia Interface are trademarks or registered trademarks of HDMI licensing LLC.

Content of the output for each output jack is shown in the following table and differ depending on the On-Screen Display Setting:

On-Screen Display Setting		Content of output for each output jack		
"Video Out" Setting	HDMI Output Setting *	HDMI Output	Video Output	Component Output
Component (Interlaced)	Invalid	-	Composite	480i
P-Scan (Progressive)	Invalid	-	Composite	480p
HDMI	480p	480p	Composite	480p
	720p	720p	Composite	480p
	1080i	1080i	Composite	480p
	1080p	1080p	Composite	480p

Note: Both Composite (Video) and Component do not have output when HD JPEG Mode is on (32), except 480p video resolution mode. You may view photos (JPEG) through HDMI connection. To watch disc playback through Composite and Component output, set HD JPEG Mode to "Off".

* Settings for HDMI output format are performed using the HDMI button on the remote control or HDMI SELECT button on the front panel.

Notes

- If Auto is selected, it follows preference HDMI aspect ratio of TV.
- Refer to the owner's manual of the connected TV as well.
- When you connect the DVD player to your TV, be sure to turn off the power and unplug both units from the wall outlet before making any connections.
- If you have a HDMI (with HDCP) equipped monitor or display, you can connect it to this player using a HDMI cable.
- The HDMI connector outputs uncompressed digital video, as well as almost every kind of digital audio that the player is compatible with, including DVD-Video, Video CD/Super VCD, CD, WMA, MP3 and DivX®.
- This unit has been designed to be compliant with HDMI (High Definition Multimedia Interface) depending on the component you have connected. Using a HDMI connection may result in unreliable signal transfers.
- Because HDMI is an evolving technology, it is possible that some devices with an HDMI input may not operate properly with this DVD player.
- When using HDMI cable, do not connect to other analog video outputs.
- No sound will be output from the HDMI cable if the digital out is not set to PCM.
- HDMI output is only available when the Video Output is set to "HDMI". Otherwise the HDMI button is invalid.

Connecting to Optional Equipment

You can enjoy high quality dynamic sounds by connecting the DVD player to optional audio equipment.

- For connection to your TV, see "Connecting to a TV".
- This section uses the following reference marks.

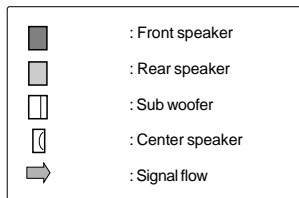

Warning

- When you are connecting (via the COAXIAL DIGITAL AUDIO OUT jack) an AV decoder that does not have Dolby Digital, Digital Theater Systems (DTS) or MPEG2 decoding function, be sure to set "Digital Output" to "PCM" from the on-screen displays. Otherwise, high volume sound may damage your hearing as well as the speakers.
- When playing DTS-encoded discs (DVDs and audio CDs), excessive noise may be output from the analog audio output jacks. To avoid possible damage to the audio system, you should take proper precautions when the analog audio output jacks of the DVD player are connected to an amplification system. To enjoy DTS Digital Surround™ playback, an external 5.1 channel DTS Digital Surround™ decoder system must be connected to the COAXIAL DIGITAL AUDIO OUT jack of the DVD player.

Notes

- Do NOT connect the COAXIAL DIGITAL AUDIO OUT jack of the DVD player to the AC-3 RF input of a Dolby Digital Receiver. This input on your A/V Receiver is reserved for Laser disc use only and is incompatible with the COAXIAL DIGITAL AUDIO OUT jack of the DVD player.
- Connect the COAXIAL DIGITAL AUDIO OUT jack of the DVD player to the "DIGITAL (COAXIAL)" input of a Receiver or Processor.
- Refer to the owner's manual of the connected equipment as well.
- When you connect the DVD player to other equipment, be sure to turn off the power and unplug all of the equipment from the wall outlet before making any connections.
- The output sound of the DVD player has a wide dynamic range. Be sure to adjust the receiver's volume to a moderate listening level. Otherwise, the speakers may be damaged by a sudden high volume sound.
- Turn off the amplifier before you connect or disconnect the DVD player's power cord. If you leave the amplifier power on, the speakers may be damaged.

Connecting to Optional Equipment (Continued)

Connecting to an amplifier equipped with a Dolby® Digital decoder

Dolby Digital

Dolby Digital is the surround sound technology used in theaters showing the latest movies, and is now available to reproduce this realistic effect in the home. You can enjoy motion picture and live concert DVDs with this dynamic realistic sound by connecting the DVD player to a 6 channel amplifier equipped with a Dolby Digital decoder or Dolby Digital processor. If you have a Dolby Surround Pro Logic decoder, you will obtain the full benefit of Pro Logic from the same DVD movies that provide full 5.1-channel Dolby Digital soundtracks, as well as from titles with the Dolby Surround mark.

Manufactured under license from Dolby Laboratories. Dolby and the double-D symbol are trademarks of Dolby Laboratories.

- Use DVDs encoded via the Dolby Digital recording system.
- Make the following setting.

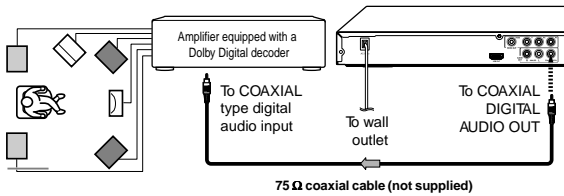

On-screen display	Select:	Page
"Digital Output"	"PCM" or "Raw"	32

Connecting to an amplifier equipped with Dolby Surround Pro Logic

Dolby Surround Pro Logic

You can enjoy the dynamic realistic sound of Dolby Surround Pro Logic by connecting an amplifier and speaker system (right and left front speakers, a center speaker, and one or two rear speakers).

- Make the following setting.

- With an amplifier equipped with Dolby Digital
Connect the equipment the same way as described in "Connecting to an amplifier equipped with a Dolby® Digital decoder." Refer to that amplifier's owner's manual and set the amplifier so you can enjoy Dolby Surround Pro Logic sound.
- With an amplifier not equipped with Dolby Digital
Connect the equipment as follows.

On-screen display	Select:	Page
"Digital Output"	"PCM" or "Raw"	32

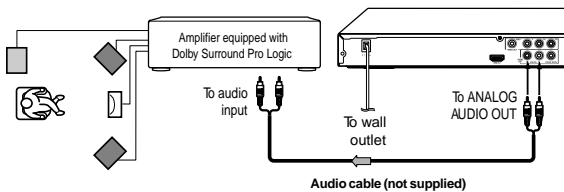

* Connect one or two rear speakers. The output sound from the rear speakers will be monaural even if you connect two rear speakers.

Connecting to an amplifier equipped with a DTS® decoder

Digital Theater Systems (DTS)

DTS is a high quality surround technology used in theaters and now available for home use, on DVDs or audio CDs.

If you have a DTS decoder or processor, you can obtain the full benefit of 5.1 channel DTS encoded sound tracks on DVDs or audio CDs.

Manufactured under license under U.S. Patent #: 5,451,942 & other U.S. and worldwide patents issued & pending. DTS and DTS Digital Out are registered trademarks and the DTS logos and Symbol are trademarks of DTS, Inc. © 1996-2008 DTS, Inc. All Rights Reserved.

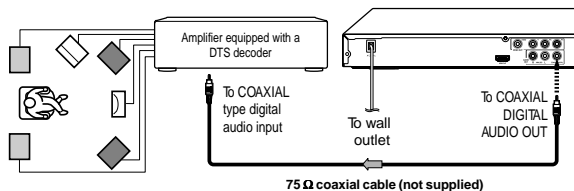

- Use DVDs or audio CDs encoded via the DTS recording system.
- Make the following setting.

On-screen display	Select:	Page
"Digital Output"	"Raw"	32

Connecting to an amplifier equipped with an MPEG2 audio decoder

MPEG2 sound

You can enjoy motion picture and live concert DVDs with dynamic realistic sound by connecting an amplifier equipped with an MPEG2 audio decoder or MPEG2 audio processor.

- Use DVDs encoded via the MPEG2 recording system.
- Make the following setting.

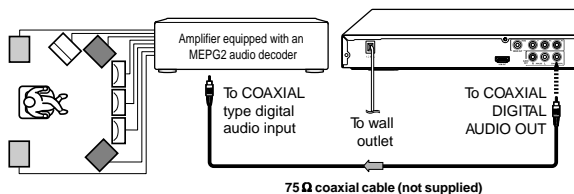

On-screen display	Select:	Page
"Digital Output"	"PCM" or "Raw"	32

Connecting to an amplifier equipped with a digital audio input

2 channel digital stereo

You can enjoy the dynamic sound of 2 channel digital stereo by connecting an amplifier equipped with a digital audio input and speaker system (right and left front speakers).

- Make the following setting.

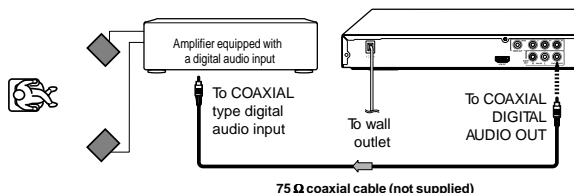

On-screen display	Select:	Page
"Digital Output"	"PCM"	32

Playing a Disc

This section shows you the basics on how to play a disc.

CAUTION

Keep your fingers well clear of the disc tray as it is closing. Neglecting to do so may cause serious personal injury.

Basic playback

Preparations

- When you want to view a disc, turn on the TV and select the video input connected to the DVD player.
- When you want to enjoy the sound of discs from the audio system, turn on the audio system and select the input connected to the DVD player.

1 Press the ON/STANDBY button on the front panel or the POWER button on the remote control.

 The DVD player turns on.

2 Press OPEN/CLOSE.

 The disc tray opens.

3 Place the disc on the disc tray.

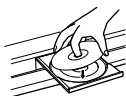

With the playback side down

- There are two different disc sizes. Place the disc in the correct guide on the disc tray. If the disc is out of the guide, it may damage the disc and cause the DVD player to malfunction.
- Do not place a disc which is unplayable in this DVD player.

4 Press OPEN/CLOSE to close the disc tray.

 Playback starts.

If you insert a DVD that contains a top menu, a menu may appear. Use ▲/▼/◀/▶ to select the title you want to view, then press ENTER to start playback.

- You may need to press the TOP MENU or MENU button to display disc menu (depending on the actual DVD.)

Notes

- If the disc tray is holding a disc you have already played, playback will begin from the location where you last stopped. For resuming playback, see (F7).
- Some video CD are recorded with PBC (Playback Control), a menu with recorded contents may appear on the TV if you have turned the PBC on. You can make your selection according to its PBC menu. Press the PBC button on the remote control to turn PBC on or off anytime during Video CD playback. When switching from PBC off to PBC on mode, playback will start from the beginning of the disc. To turn on the menu display again, press the RETURN button.

■ To obtain a higher quality picture

Occasionally, some picture noise not usually visible during a normal broadcast may appear on the TV screen while playing a DVD because the high resolution pictures on these discs include a lot of information. While the amount of noise depends on the TV you use with this DVD player, you should generally reduce the sharpness adjustment on your TV when viewing DVDs.

■ To start playback in the stop mode

Press PLAY.



■ To pause playback (still mode)

Press PAUSE/STEP during playback.



To resume normal playback, press the PLAY button.

- The sound is muted during still mode.

■ To stop playback

Press STOP.



■ To remove the disc

Press OPEN/CLOSE.



Remove the disc after the disc tray opens completely.

Be sure to press the OPEN/CLOSE button to close the disc tray after you remove the disc.

■ To turn the power off

Press ON/STANDBY on the front panel or POWER button on the remote control to turn the unit off.

■ Automatic Power Off function

If the DVD player is stopped, or the screen saver is engaged for approximately 20 minutes, the DVD player will automatically turn itself off.

Notes

- Do not move the DVD player during playback. Doing so may damage the disc.
- Use the OPEN/CLOSE button to open and close the disc tray. Do not push the disc tray while it is moving. Doing so may cause the DVD player to malfunction.
- Do not push up on the disc tray or put any objects other than discs on the disc tray. Doing so may cause the DVD player to malfunction.
- In many instances, a menu screen will appear after playback of a movie is completed. Prolonged display of an on-screen menu may damage your television set, permanently etching that image onto its screen. To avoid this, be sure to press the STOP button on your remote control once the movie is completed.

Variable Speed Playback

You can play discs at various speeds, and resume playback from the location where you stopped playback.

Playing in fast reverse or fast forward directions

Press REV or FWD during playback.

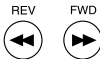

REV: Fast reverse playback
FWD: Fast forward playback

Each time you press the REV or FWD button, the playback speed changes.

■ To resume normal playback

Press PLAY.



Notes

- The DVD player mutes sound and subtitles during reverse and forward scan of DVDs.
- The playback speed may differ depending on the disc.

Playing frame by frame

Press PAUSE/STEP during still playback.



Each time you press the PAUSE/STEP button, the picture advances one frame.

■ To resume normal playback

Press PLAY.



Note: The sound is muted during frame by frame playback.

Playing in slow-motion

Press SLOW during playback.



Each time you press the SLOW button, the slow-motion speed changes in the following sequence:

◀1/8 ← ◀1/4 ← ◀1/2 ▶ 1/2 → ▶ 1/4 → ▶ 1/8

■ To resume normal playback

Press PLAY.



Notes

- The sound is muted during slow-motion playback.
- 3 speeds are available.

Resuming playback from the same location

1 Press STOP at the location where you want to interrupt playback.



The DVD player memorizes the location where playback is stopped.

2 Press PLAY.



The DVD player resumes playback from the location where you stopped playback.

Notes

- There may be a difference in the location where playback resumes depending on the disc.
- Settings you changed using the on-screen displays while the DVD player keeps a location in the memory may function only after the memory is cleared.
- Resuming playback does not work for VCD with PBC on.

■ **To start playback from the beginning regardless of the location where you stopped playback.**

- 1 Press **STOP** twice.





The DVD player deletes the memory of the location.

- If you want to return to the beginning of a DVD, open and close the disc tray once with the OPEN/CLOSE button before pressing the PLAY button.

- 2 Press **PLAY**.



 Playback starts from the beginning of the current title.

 Playback starts from the beginning of the disc.

 Playback starts from the beginning of the current track.

Locating a Desired Section

Normally, DVDs are divided into titles, and the titles are sub-divided into chapters. VIDEO CDs and audio CDs are divided into tracks. You can quickly locate any specific title, chapter, or track.

Locating a title using the top menu

- 1 Press **TOP MENU**.



The top menu appears on the TV screen.

e.g.

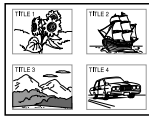

- 3 Press **ENTER**.





Playback starts from chapter 1 of the selected title.

Notes

- The instructions above describe basic procedures which may vary depending on the contents of the DVD. If different instructions appear on the TV screen, follow those instructions.
- If you display the top menu during playback and press the TOP MENU button again without selecting any title, the DVD player may resume playback from the point where you first pressed the TOP MENU button (depending on the actual DVD.)
- This method of locating a title is available only on a disc that contains a top menu.
- Instruction notes of discs may refer to the button that displays the top menu as TITLE button.

Locating a specific chapter or track

Press SKIP  or  repeatedly to access the chapter or track number you want.

Playback starts from the selected chapter or track.



To locate succeeding chapters or tracks.



Playback starts from the beginning of the current chapter or track.

When you press twice in quick successions, playback starts from the beginning of the preceding chapter or track.

Note

- Some titles may not display chapter numbers.

Accessing a Specific Location Directly

DVD VCD CD Locating a specific title/chapter/time

1 Press T.
Press ▲ / ▼ to select the Title/Chapter/Track/Time.

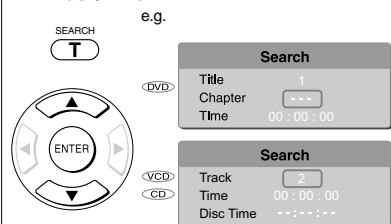

2 Press ◀ / ▶ to select a section you want to locate.

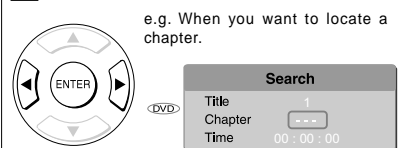

Or
Press the number buttons to enter title, chapter (track) number or time.

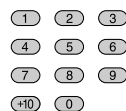

3 Press ENTER.

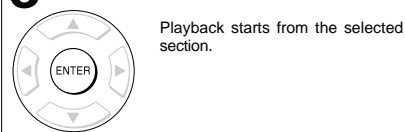

Notes

- Pressing the CLEAR button resets the numbers. To clear the display, press the T button several times.
- For VCD with PBC on, accessing tracks using number buttons does not work.

■ **Accessing chapters/tracks using number buttons:**

For chapter/track numbers 10 to 19, press +10 once and the number 10 appears then enter one digit. Press ENTER.

For chapter/track numbers 20 to 29, press +10 twice and the number 20 appears then enter one digit. Press ENTER.

For example, if you want to select chapter/track 25, first press +10 twice then press the number button "5". Then press ENTER.

■ **Accessing the time using number buttons:**

Just enter 2 digits in order.

The first two numbers you entered represent hours. The second two numbers you entered represent minutes.

The third two numbers you entered represent seconds.

■ **To set and play favorite bookmark during playback**

1. Press T twice, the display of Bookmark appears, then press ENTER to mark the desired scene.

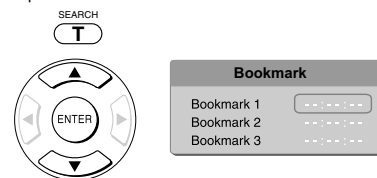

2. Press ENTER to play the favorite bookmark.

■ **To set other bookmarks.**

Follow step 1 and move through the menu by pressing the ▲ or ▼ button.

■ **Press T again to remove this display.**

■ **To cancel the Bookmark**

Follow step 1, then press the CLEAR button to cancel the bookmark. Move through the menu by pressing the ▲ or ▼ button to cancel other bookmarks.

Notes

- Some discs may not work with marking operation.
- The marking is canceled when you open the disc tray or turn the power off.
- Some subtitles recorded around the marker may fail to appear.

Repeating a Specific Segment

You can specify a desired segment and repeat it.

DVD VCD CD Repeating a specific segment

1 Press A-B RPT at the beginning of the segment (point A) you want to play repeatedly.



2 Press A-B RPT again at the end of the segment (point B).

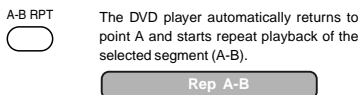

To resume normal playback

Press A-B RPT until **RepAB Off** is displayed.



Notes

- Some discs may not permit A-B repeat operation.
- You cannot set the A-B repeat function for a segment that includes multiple camera angles.
- You can specify a segment only within the current title or track (VIDEO CD).
- There may be a slight difference between point A and the location where playback actually resumes depending on the disc.

Playing in a Varied Order

You can play titles, chapters within a title, or tracks in a varied order.

For Audio CD, please see "Playing MP3/WMA files" [26](#).

DVD VCD Playing titles, chapters or tracks in a varied order

1 Press PLAY MODE.

PLAY MODE Press **▲ / ▼** button to select desired features and then press ENTER button to toggle desired mode.

e.g.

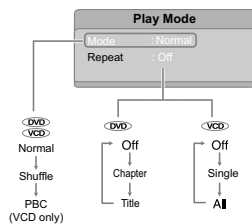

- Shuffle:** Playbacks in random order.
- PBC:** Playbacks in PBC On mode (VCD only).
- Chapter:** Repeats the current chapter.
- Title:** Repeats the current title.
- Single:** Repeats the current track.
- All:** Repeats the entire disc.
- Off:** Resumes normal playback.

2 Press PLAY.

PLAY Press the PLAY button, the DVD player starts playback in the selected mode.

To resume normal playback

Press ENTER until the Off/Normal is displayed.

Note

Some discs may not permit these operations.

Playing in a Favorite Order

You can combine your favorite titles, chapters or tracks and play them in the order you determine. You can program up to 12 selections into the memory (Memory playback).

Setting titles, chapters or tracks in a favorite order

1 Insert a disc and press MEMORY during stop.

MEMORY The following display appears.
 e.g. DVD

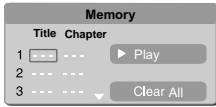

Chapter number
 Title number

e.g. VCD



Track number

2 Select the items in the order you want by pressing the number buttons.

Each time you press the \blacktriangle / \blacktriangledown / \blacktriangleleft / \blacktriangleright button, the space is highlighted in turn. Highlight where you want to enter, then press the corresponding number buttons.

To select another chapter in the same title, you need to select the title number.

To select tracks from a VIDEO CD/audio CD in order, press the number buttons for the track.

3 Press \blacktriangle / \blacktriangledown / \blacktriangleleft / \blacktriangleright to move the highlighted bar to Play, then press the ENTER.



The DVD player starts memory playback.

■ To change the programmed selections

1. While the display appears on the TV screen, press \blacktriangle / \blacktriangledown / \blacktriangleleft / \blacktriangleright to move the highlighted bar to the item you want to change, then press CLEAR.
2. Press number buttons to input the new title/chapter/track number.

■ To cancel the programmed selections

1. While the display appears on the TV screen, press \blacktriangle / \blacktriangledown / \blacktriangleleft / \blacktriangleright to move the highlighted bar to the item you want to cancel.
2. Press CLEAR.

■ To resume normal playback from memory playback

Press MEMORY button.

Press \blacktriangle / \blacktriangledown / \blacktriangleleft / \blacktriangleright to move the highlighted bar to "Clear All", then press ENTER. All the input programs will be cleared.

Press PLAY button to resume normal playback.

PLAY



Normal playback will start from first location.

■ To program during playback

If you press the MEMORY button during playback, a programming display appears. Follow steps 2 and 3.

Notes

- Some discs may not permit memory playback operation.
- If you select repeat during memory playback, the DVD player repeats the current memory playback.
- If you press the MEMORY button while the display appears on the TV screen, the display disappears.
- The programmed selections will be cleared when you open the disc tray or turn off the DVD player.

Zooming a Picture

You can magnify areas within a picture.



DVD VCD Zooming a picture

Press ZOOM during normal, slow or still playback.



The centre part of the image will be zoomed in.

e.g.

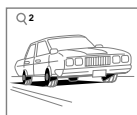

Each time you press the ZOOM button, the magnification level changes as follows:

Q 1 → Q 2 → Q 3 → Q Off

Press the ZOOM button to select the magnification level.

Press the ▲/▼/◀/▶ buttons to view a different part of the image. You may move the image from the centre position to UP, DOWN, LEFT and RIGHT direction.

When you reach the edge of the image, the display will not shift anymore in that direction.

■ To resume normal playback

Press ZOOM repeatedly until the Q Off is displayed. Original picture is restored.



Notes

- Some discs may not respond to zoom feature, for example, during VCD PBC On mode.
- During some scenes, the buttons may not work as described.
- Zooming does not work on subtitles or menus included on DVDs.
- The magnification level varies depending on the picture size you select.

Selecting the Sound Enhancement (E.A.M. *)

You can easily switch a preferred audio enhancement.

*E.A.M.: Enhanced Audio Mode

DVD Selecting the sound enhancement

1 Press E.A.M.



The sound enhancement will appear:

3D effect

Press the E.A.M. button again, the sound enhancement change to Off.

3D*:

To obtain expansive virtual surround sound effects from two speakers.

To use this enhancement on sounds output from the ANALOG AUDIO OUT jacks, be sure to set "Digital Output" to "PCM".

* Effective in playback of a DVD .

■ To exit the audio enhancement selection

Leave the DVD player unattended for about a few seconds after having made a selection.

Notes

- Actual effects to sounds may vary depending on the speaker system. Make selection according to your preference.
- Actual effects to sounds may vary depending on the disc.
- When the DVD player is connected to an amplifier equipped with Dolby Surround Pro Logic, select "3D effect". Otherwise, Dolby Surround Pro Logic may function differently than usual.

Selecting the Picture Enhancement (E.P.M.)*

You can easily select a preferred picture enhancement.

*E.P.M.: Enhanced Picture Mode

DVD VCD CD Selecting the picture enhancement

1 Press E.P.M.



The picture enhancement menu appears.

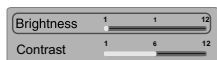

To exit the picture enhancement selection

Press E.P.M. again.



Note

Actual effect to picture may vary depending on the TV. Make selection according to your preference.

2 Select the picture enhancement by pressing \blacktriangle / \blacktriangledown , then press \blacktriangleleft / \blacktriangleright to make your selections.

Each time you press the \blacktriangleleft / \blacktriangleright button, the picture enhancement changes.

Advanced playback

Selecting Subtitles

You can display subtitles on the TV screen and select a subtitle language from those included on the DVD.



DVD Selecting a subtitle language

1 Press SUBTITLE during playback.



The current subtitle setting is displayed.



2 Press SUBTITLE while the subtitle setting is displayed on the TV screen.

Each time you press the SUBTITLE button, the subtitle languages included on the DVD change.



To turn off the subtitle setting display, press the SUBTITLE button repeatedly until or is displayed.

To turn subtitles on or off

1. Press SUBTITLE during playback.
2. Press SUBTITLE repeatedly until the or is displayed.

Notes

- Some DVDs are set to display subtitles automatically, and you cannot turn them off even if you set the subtitle function to off.
- During some scenes, the subtitles may not appear immediately after you select your desired.
- Some DVDs will allow you to make subtitle selections and turn subtitles on or off only via the disc menu.

Notes

- When you turn on the DVD player or replace a disc, the player returns to the initial default setting. When you select a subtitle language which is not included on the disc, the DVD player plays a prior language programmed on the disc.
- During some scenes, the subtitles may not appear immediately after you change the subtitle language.

Selecting the Camera Angle

If the scene was recorded from multiple angles, you can easily change the camera angle of the scene you are watching.

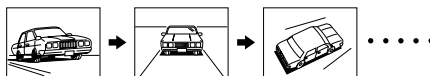

Changing the camera angle

1 Press ANGLE while playing a scene recorded with multiple angles.



While playing a scene recorded with multiple angles, press the ANGLE button.

e.g. 

Number changes to show the number of the current angle. (The maximum number of possible angles is 9)

2 Press ANGLE while the angle number is displayed on the TV screen.



Press the ANGLE button repeatedly to change the scene to the next angle in those recorded.

- About two seconds later, playback continues from the new angle you selected.
- If no button is pressed within 10 seconds, playback continues without changing the current angle.

■ To resume normal playback

Press ANGLE repeatedly until the "ANGLE 1/1" is displayed.

Notes:

- This function can only be used for discs on which scenes shot from multiple angles have been recorded.
- If only one angle is recorded, "ANGLE 1/1" is displayed.

Selecting a Language

You can select a preferred language and sound recording system from those included on the DVD.



Selecting a playback audio setting

1 Press AUDIO during playback.



The current audio setting is displayed.

e.g. 

Recorded audio format number changes sequentially. (The maximum number of possible audio formats is 8.)

If the abbreviation of the language appears instead of the language name, refer to the list of languages and their abbreviations [35](#).

2 Press AUDIO while the audio setting is displayed on the TV screen.



Each time you press the AUDIO button, the audio settings included on the DVD change.

The audio setting display will disappear after a few seconds.

Notes

- When you turn on the DVD player or replace a disc, player returns to the initial default setting. If you select a sound track which is not included on the disc, the DVD player plays a prior sound track programmed on the disc.
- Some discs allow you to change audio selections only via the disc menu. If this is the case, press the MENU button and choose the appropriate language from the selections on the disc menu.

■ Selecting sound channels of VIDEO CDs



Press AUDIO repeatedly during playback to hear a different audio channel (Stereo, Left, Right or Mix).

On-screen Display Operation

When you turn on the on-screen display, you can view information on operational status and access features and settings.

On-screen display operation

Press NAVI.

NAVI The following display appears.



e.g. When playing a DVD.



Select by pressing ◀ / ▶ then press ENTER to access the feature.

■ Features

Title number (Track number)

Chapter number

Elapsed time of the current title or track

Remaining time of the current title or track

▶ : To start playback.

⏸ : To pause playback.

■ : To stop playback.

◀◀ : Playback starts from the beginning of the current chapter or track.

When you press twice in quick successions, playback starts from the beginning of the preceding chapter or track.

▶▶ : To locate succeeding chapters or tracks.

■ Viewing the operational status

1. Press DISPLAY.

The following display appears.

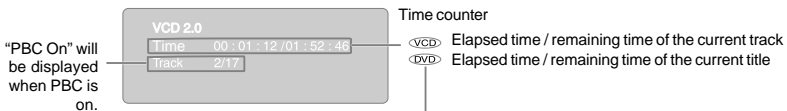

"PBC On" will be displayed when PBC is on.

Time counter

◀ VCD ▶ Elapsed time / remaining time of the current track

◀ DVD ▶ Elapsed time / remaining time of the current title

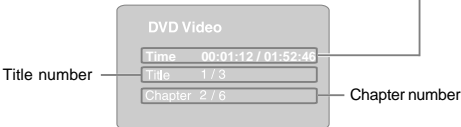

3. To turn off the display, press DISPLAY again.

2. Press DISPLAY again.

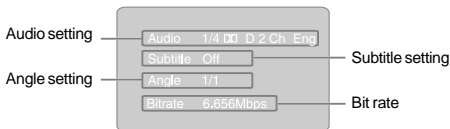

Bit rate (Mbit/s)

Amount of picture, sound and subtitle data in the DVD transferred per second.

The larger the value is, the more data processed, but this does not necessarily insure better picture quality.

Playing MP3/WMA Files

You can play MP3/WMA files that have been recorded on a CD-R or CD-RW on the DVD player.

Playing MP3/WMA files

■ Preparations

- Make sure that a disc you want to play is compatible with this DVD player.

1 Place a CD that contains MP3/WMA files on the disc tray.

2 Press OPEN/CLOSE to load the disc.



3 To stop playback, press STOP.



■ Selecting a specific time of the current track

1. Press T.
2. Enter the time to select a specific time you want to play.
3. Press ENTER to begin playback of the selected time.

Notes

- Letter of a file/folder name overflowing the given space are not displayed.
- You can play in fast reverse or fast forward during MP3/WMA playback.

■ To pause playback

Press PAUSE/STEP during playback.



To resume normal playback, press the PLAY button.

Notes

- Some discs may not permit this operation.
- The COAXIAL DIGITAL AUDIO OUT jack outputs MP3/WMA sounds in the linear PCM format regardless of the current "Digital Output" selection.
- The SKIP function is also available.

■ Playable files

MP3/WMA disc compatibility with this player is limited as follows:

- Playable discs: CD-R (650MB / 74 min. only)
CD-RW may not be compatible.
- Sampling Frequency: 44.1 kHz only
- Bit rate: MP3: 32 kbps - 320 kbps (CBR*)
WMA: 48 kbps - 192 kbps (CBR*)
- CD physical format: Mode 1, Mode 2 XA Form 1
- File system: ISO9660 Level 1, 2 or Joliet
- File name: A file name should be in alphabet and numerals only, and must incorporate "MP3" or "WMA" extension. e.g. "*****.MP3", "*****.WMA".
- Total number of folders: Less than 256
- Total number of files: Less than 1000
- WMA codec version: V7 or V8 (Stereo sound only)
* CBR = Constant Bit Rate

Note: When the MP3/WMA file is out of the above specifications, the song may be skipped or muted with counter moving.

■ Play modes for MP3/WMA/CD/DivX®

When you play MP3/WMA/CD/DivX®, you are able to modify the Play modes through the Toolkit which appears on the right of below picture on the screen. Press ◀/▶ buttons to navigate between the windows and ▲/▼ buttons to select files/tracks or play mode items. Then press ENTER button. Please refer to below steps to playback files/tracks in the Program view list.

1. Select Edit mode in the Toolkit then press ENTER button to start edit mode.
2. Select a file/track or more files/tracks you want in the original view list with the ENTER button.
3. Select Add to program in the Toolkit then press ENTER. "✓" will disappear from the screen. It means that the files/tracks you have selected already added into the program view list.
4. Select Program view in the Toolkit then press ENTER to open the files/tracks in the Program view list that you already selected in step 2.
5. Press PLAY to playback all files/tracks in the Program view list.



The Toolkit has the following play mode items:

- **Filter (Audio/Photo/Video):** Sets file filters. Filter is not applicable to Audio CD.
- **Repeat (Off/Track/All):**
Off: Resumes normal playback.
Track: Repeats the current track.
All: Repeats all files on the current folder or all tracks on the disc.
- **Mode (Normal/Shuffle/Music Intro):**
Normal: Resumes normal playback.
Shuffle: Plays back track/file in random order.
Music Intro: Only playbacks the first 10 seconds of all the files on the current folder or all tracks on the disc.
- **Edit mode:** Memory operation works only when Edit mode is selected. After finish storing the files/tracks you want into the Program view list, select "Edit mode" again and press ENTER to release edit mode.
- **Program view:** To view tracks/files in the Program view list. It is disabled when the Program view list is empty.
- **Add to program:** Add files/tracks to the Program view list. It is disabled if the Edit mode is not selected. (The maximum number of files/tracks can be added is 30.)
- **Browser view:** To view files/tracks in the original view list.
- **Clear program:** Delete the files/tracks in the Program view list. Select a file/track or more you want to delete in stop mode. "✓" will appear besides the deleted file/track. Select Clear program and then press ENTER. It is disabled if the Edit mode is not selected.

This DVD player requires discs/recordings to meet certain technical standards in order to achieve optimal playback quality. Pre-recorded DVDs are automatically set to these standards. There are many different types of recordable disc formats (including CD-R containing MP3/WMA files). Because this area of technology is still evolving, Toshiba cannot guarantee that all recordable discs will produce optimal playback quality. The technical criteria set forth in this owner's manual are meant only as a guide.

Please be advised that you must obtain permission from the applicable copyright owners to download copyrighted content, including music files, in any format, including the MP3 formats, prior to the downloading thereof. Toshiba has no right to grant and does not grant permission to download any copyrighted content.

Viewing JPEG Files

You can play JPEG files that have been recorded on a CD-R or CD-RW on the DVD player. You can select a preferred view: a page of 9 thumbnail images or a single image view. Also, rotating, enlarging and shifting of each image can be possible. To playback in HD JPEG resolution, see 62.

Viewing JPEG files

■ Preparations

- Prepare a disc that contains JPEG files you want to view (see next page for Jpeg files compatibility). In Setup Menu, it is preferred to select "Original" for "View Mode" 62.
- Make your TV shape conform to the 4:3 picture size. Only 4:3 pictures can be played regardless of the function settings via the on-screen displays of the DVD player. If the TV is adjusted to other sizes, e.g. "16:9", images will appear to be horizontally expanded. For details, refer to the owner's manual of your TV.

1 Press OPEN/CLOSE to open the disc tray, place a disc that contains JPEG files.

OPEN/CLOSE

Press OPEN/CLOSE to close the disc tray. A list of folders/files will appear on the screen.

A list of files in the disc appears. (Selection mode) e.g.

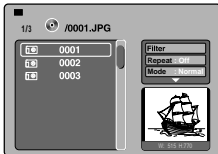

Press ▲ / ▼ button to select your desired file, and then press ENTER or PLAY button to start slide show playback 62.

Press STOP to display a folder list.

Note: When you press ▲ / ▼ button to select the left file, the selected picture will appear at the lower right corner.

STOP

Press the ▲ / ▼ / ◀ / ▶ buttons to view a different part of the image. You may move the image from the centre position to UP, DOWN, LEFT and RIGHT direction. When you reach the edge of the image, the display will not shift anymore in that direction.

■ To resume normal playback

Press the ZOOM repeatedly until the Q off is displayed.

ZOOM



- Original picture is restored when the Q off appears.
- Depending on the file size, some files may not display the entire image.

■ To rotate an image

During playback, press the ◀ / ▶ button repeatedly to rotate the picture on the TV screen.

- ◀ : rotate the picture anti-clockwise by 90°
- ▶ : rotate the picture clockwise by 90°.

■ To set transition effect

During playback, press the ANGLE button to select the transition effect: Wipe down transition, Wipe up transition, No transition.

Note

The transition effect only works in 480p video resolution if the HD JPEG Mode is set to "On".

■ To quit the JPEG playback, press STOP.

STOP



- Pressing the OPEN/CLOSE button to open the disc tray can also quit the playback.

■ To pause playback

Press PAUSE/STEP during playback

PAUSE/STEP



To resume normal playback, press PLAY.

■ To change the image

SKIP



To view the succeeding image, press SKIP ▶▶.



SKIP

To view the previous image, press SKIP ◀◀.

■ To magnify image

Press ZOOM repeatedly.

ZOOM



Each time you press the ZOOM button, the magnification level changes as follows:

Q 1 → Q 2 → Q 3 → Q off

Viewing a thumbnail view

1 Press TOP MENU in full-screen review.

TOP MENU



e.g.



Press the ▲ / ▼ / ◀ / ▶ to select an image, press PLAY to view one image in full-screen and automatically images will be displayed one by one again in a few seconds.

■ Turn the page if necessary

Press SKIP ◀◀ / ▶▶ to view other thumbnail screen.

JPEG files compatibility

Discs whose compatibility with this DVD player has been confirmed by TOSHIBA are as follows.

CANON QuickCD FUJICOLOR CD
 Kodak Picture CD NORITSU QSS CD

JPEG disc compatibility with this DVD player is limited as follows:

- Playable discs:
 - CD-R (650MB / 74 min. only)
 - CD-RW may not be compatible.
- CD physical format:
 - Mode 1, Mode 2 XA Form 1
- File system:
 - ISO9660 Level 1, 2 or Joliet
- File name:
 - A file name should be in alphabet and numerals only, and must incorporate "JPG" extension.
 - e.g. "*****.JPG" (Do not name the file with "JPE" or "JPEG" extension.)
- Total number of folders:
 - Less than 256
- Total number of files:
 - Less than 1000

Depending on the file size, some files may not display the entire image.

Some discs may not permit this operation. Especially, the following conditions of included files will increase the disc's disability.

1. Pixels over 2880 x 1920 in height and/or width
2. File size over 2M bytes
3. File format except Exif

Playing DivX®/MPEG-4 Files

You can play DivX® and MPEG-4 files that have been recorded on a CD-R or CD-RW on the DVD player.

Playing DivX®/MPEG-4 files

1 Press OPEN/CLOSE to open the disc tray, place a disc that contains DivX® or MPEG-4 files.

OPEN/CLOSE



Press OPEN/CLOSE to close the disc tray, after completion of reading, a list of folders in the disc will appear.

A list of folders in the disc appears.

e.g.

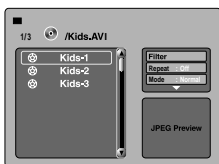

PLAY



Press ▲ / ▼ to select your desired file, and then press ENTER or PLAY button to start playback.

If your DivX® files include the subtitle file supported by this unit (see 30), the "External Subtitle File Selection" menu will appear, use ▲ / ▼ to select one extension and then press ENTER to start playback.

Press STOP to display a folder list.

■ Playable files

DivX® / MPEG-4 disc compatibility with this player is limited as follows:

- Playable discs:
 - CD-R (650MB / 74 min. only)
 - CD-RW may not be compatible.
- DivX® versions:
 - DivX® 3.11, 4.12, 5.0, 5.1
- Audio format:
 - CBR MP3, VBR MP3, Mono MP3, DivX® AC3
- Enhance video:
 - GMC, Qpel, Progressive B-frames
- Frame rate:
 - 8 to 25 fps
- CD physical format:
 - Mode 1, Mode 2 X A Form 1
- File system:
 - ISO9660 Level 1, 2 or Joliet
- File name:
 - A file name should be in alphabet and numerals only, and must incorporate "DIVX" or "AVI" extension.
 - e.g. "*****.DIVX ", "*****.AVI "
- Total number of folders:
 - Less than 256
- Total number of files:
 - Less than 1000

Notes

- It is recommended to record the same kind of files in a CD-R or CD-RW.
- Some DivX® Video-On-Demand files may require registration code of your DVD player, you may get the code in Misc settings 32).

DivX, DivX Certified, and associated logos are trademarks of DivX, Inc. and are used under license.

Customizing the Function Settings

You can change the default settings to customize performance to your preference.

Setting procedure

- 1 Press SETUP during stop.**

SETUP

The following on-screen display appears.

- 2 Press ▲ / ▼ to select an option for the setting you want to change, then press ►.**

Language settings
Video settings
Audio settings
Rating settings
Misc settings

- 3 Press ▲ / ▼ to select the setting you want to change, then press ENTER.**

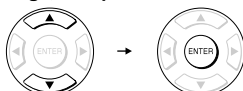
- 4 Change the selection by ▲ / ▼ buttons, by referring to the corresponding pages, then press ENTER.**

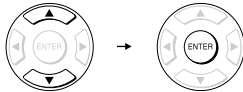
- 5 Repeat steps 3 and 4 to change other settings.**

To select another option, press ◀ to go back to step 2.
- 6 Press SETUP.**

SETUP

The on-screen display disappears.

Note
To quit the procedure, press the SETUP button to turn off the on-screen display.

Setting details

Language



Language DVD VCD CD

English: To view on-screen displays in English.
Français: To view on-screen displays in French.
Español: To view on-screen displays in Spanish.

- 1) Press SETUP button.
- 2) Press ► button to select **Language**.
- 3) Press ENTER button, then use the ▲ / ▼ button to select a preferred language.
- 4) Press ENTER button.
- 5) Press SETUP button to exit the menu.



Subtitle DVD

English: To display subtitles in English.
French: To display subtitles in French.
Spanish: To display subtitles in Spanish.
Auto: To display subtitles in different languages other than you selected.
Off: To disable subtitles.

- 1) Press SETUP button.
- 2) Press ► button then use the ▲ / ▼ button to select **Subtitle**.
- 3) Press ENTER button, then use the ▲ / ▼ button to select a preferred language.
- 4) Press ENTER button.
- 5) Press SETUP button to exit the menu.

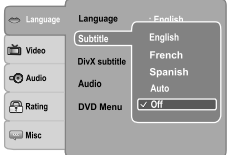

Notes

- Some DVDs may be set to display subtitles in a different language other than you selected. A prior subtitle language may be programmed on the disc.
- Some DVDs allow you to change subtitle selections only via the disc menu. If this is the case, press the MENU button and choose the appropriate subtitle language from the selection on the disc menu.

Function setup

Customizing the Function Settings (continued)

Setting details

DivX® Subtitle

If your DivX® files include a subtitle file, then you may select a supported DivX® subtitle language by region:

ASCII Unicode
 Turkish Central European
 Cyrillic

- 1) Press SETUP button.
- 2) Press ► button, then use the ▲ / ▼ button to select **DivX subtitle**.
- 3) Press ENTER button, then use the ▲ / ▼ button to select a preferred DivX® subtitle language.
- 4) Press ENTER button.
- 5) Press SETUP button to exit the menu.

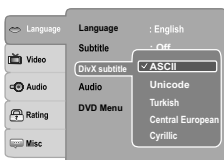

Notes

- If your DivX® files do not include the subtitle file, you cannot use this selection.
- Supported subtitle file formats:
 .srt, .sub, .txt, .smi, .ssa.

Audio DVD

English: To play sound tracks in English.
 French: To play sound tracks in French.
 Spanish: To play sound tracks in Spanish.

- 1) Press SETUP button.
- 2) Press ► button, then use the ▲ / ▼ button to select **Audio**.
- 3) Press ENTER button, then use the ▲ / ▼ button to select a preferred language.
- 4) Press ENTER button.
- 5) Press SETUP button to exit the menu.



Note

Some DVDs may not be played in a different language than you selected. A prior language may be programmed on the disc.

DVD Menu DVD

English: To display DVD Menus in English.
 French: To display DVD Menus in French.
 Spanish: To display DVD Menus in Spanish.

- 1) Press SETUP button.
- 2) Press ► button, then use the ▲ / ▼ button to select **DVD Menu**.
- 3) Press ENTER button, then the ▲ / ▼ button to select a preferred language.
- 4) Press ENTER button.
- 5) Press SETUP button to exit the menu.



Note

Some DVDs may not include your pre-selected language. In this case, the DVD player automatically displays disc menus consistent with the disc's initial language setting.

Video

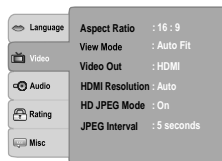

Aspect Ratio DVD

- 1) Press SETUP button.
- 2) Press ▲ / ▼ button to select **Video**.
- 3) Press ► button, then use the ▲ / ▼ button to select **Aspect Ratio**.
- 4) Press ENTER button, then use the ▲ / ▼ button to shift and change the TV type.
- 5) Press ENTER button.
- 6) Press SETUP button to exit the menu.

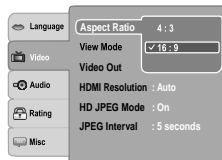

4:3



Select when a standard 4:3 TV is connected.
 Displays pictures cropped to fill your TV screen. Either or both sides of the picture are cut off.

16:9



Select when a 16:9 TV is connected.

Notes

- The displayable picture size is preset on the DVD. Therefore, the playback picture of some DVDs may not conform to the picture size you select.
- When you play DVDs recorded in the 4:3 picture size only, the playback picture always appears in the 4:3 picture size regardless of the TV shape setting. But, if Video Output is set to HDMI 720p/1080i/1080p, then picture will be 16:9 only.
- If you select "16:9" and you own a 4:3 TV set, the DVD playback picture will be horizontally distorted during playback. Images will appear to be horizontally compressed. Always be sure that your TV shape conforms to the actual TV in use.

View Mode

The user may select one of the following options:

Fill: Fill the screen with decoded image.

Original: Display image as its original size. "Original" is preferred for Jpeg viewing.

Height Fit: Fit the screen height with image height.

Width Fit: Fit the screen width with image width.

Auto Fit: Automatically fit the decoded image on screen without distortion.

Pan Scan: Automatically display decoded image on full screen without distortion.

- 1) Press SETUP button.
- 2) Press ▲ / ▼ button to select **Video**.
- 3) Press ► button, then use the ▲ / ▼ button to select **View Mode**.
- 4) Press ENTER button, then use the ▲ / ▼ button to select the options (Fill, Original, Height Fit, Width Fit, Auto Fit or Pan Scan).
- 5) Press ENTER button.
- 6) Press SETUP button to exit the menu.

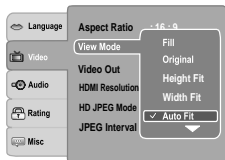

Pan Scan



Select when a standard 4:3 TV is connected. Displays pictures cropped to fill your TV screen. Either or both sides of the picture are cut off.



Automatically fit the decoded image on screen without distortion. Black bars will be present on top/bottom or left/right of screen.

Note: Depending on the DVDs, you may not be able to view the mode as selected.

Video Out

- 1) Press SETUP button.
- 2) Press ▲ / ▼ button to select **Video**.
- 3) Press ► button, then use the ▲ / ▼ button to select **Video Out**.
- 4) Press ENTER button, then use the ▲ / ▼ button to select the output mode (Component, P-Scan or HDMI).
- 5) Press ENTER button.
- 6) Press SETUP button to exit the menu.

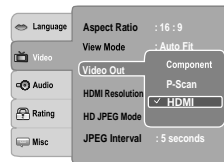

Component: Select if you connect the DVD player to your TV which has component video inputs.

P-Scan: Select if you connect the DVD player to your TV which has component video inputs that support progressive scan.

HDMI: High Definition Multimedia Interface. Select if you connect the DVD player to TV via HDMI input.

HDMI Resolution

- 1) Press SETUP button.
- 2) Press ▲ / ▼ button to select **Video**.
- 3) Press ► button, then use the ▲ / ▼ button to select **HDMI Resolution**.
- 4) Press ENTER button, then use the ▲ / ▼ button to select the options (Auto, 480p, 720p, 1080i or 1080p).
- 5) Press ENTER button.
- 6) Press SETUP button to exit the menu.

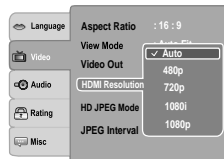

Notes

- If the Video Out is not set to "HDMI", you cannot select the "HDMI Resolution".
- Select the HDMI resolution according to the performance of the connected TV.

Customizing the Function Settings (continued)

Setting details

HD JPEG Mode

- 1) Press SETUP button.
- 2) Press ▲/▼ button to select **Video**.
- 3) Press ► button, then use the ▲/▼ button to select **HD JPEG Mode**.
- 4) Press ENTER button, then use the ▲/▼ button to select On or Off mode.
- 5) Press ENTER button.
- 6) Press SETUP button to exit the menu.

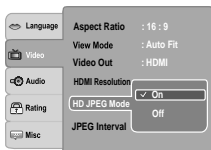

On: JPEG image is displayed in a suitable picture quality (480p, 720p, 1080i or 1080p).

Off: The picture quality is fixed to 480p.

Notes

- If the Video Out is not set to "HDMI", you cannot select the "HD JPEG Mode".
- All JPEG pictures will not be output through the VIDEO OUT jack and Component video (Y/Pa/Pr) jacks if the HD JPEG Mode is on and you may view pictures through HDMI jack.
- For HDMI output, DISPLAY and ZOOM buttons only work in 480p resolution mode when HD JPEG Mode is On.

JPEG Interval

- 1) Press SETUP button.
- 2) Press ▲/▼ button to select **Video**.
- 3) Press ► button, then the ▲/▼ button to select the **JPEG Interval**.
- 4) Press ENTER button, then the ▲/▼ button to still and change the JPEG Interval.
- 5) Press ENTER button.
- 6) Press SETUP button to exit the menu.

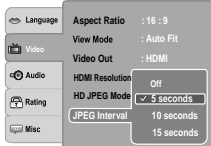

Off: Plays back one file at a time.

5 seconds: Plays back images in the form of a slide show at 5 seconds interval.

10 seconds: Plays back images in the form of a slide show at 10 seconds interval.

15 seconds: Plays back images in the form of a slide show at 15 seconds interval.

Audio

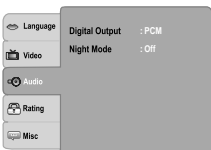

Digital Output DVD VCD CD

Selects the output sound format corresponding to your system connection.

- 1) Press SETUP button.
- 2) Press ▲/▼ button to select **Audio**.
- 3) Press ► button, then use the ▲/▼ button to select **Digital Output**.
- 4) Press ENTER button, then use the ▲/▼ button to select the output sound format (Off, PCM or Raw).
- 5) Press ENTER button.
- 6) Press SETUP button to exit the menu.

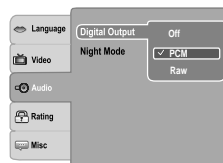

PCM: Select when connected to a Multi-channel digital stereo amplifier. The DVD player outputs sound in the PCM stereo format when you play a DVD recorded on the Dolby Digital, MPEG1 or MPEG2 recording system.

Raw: Disc audio raw data will be output. Select "Raw" if your amplifier supports "DTS".

Off: To disable Digital Output.

Notes

- When you make a connection to a TV, Dolby Surround Pro Logic or stereo system via the analog audio jacks, select "PCM" or "Raw".
- If this DVD player is connected to a TV using HDMI, make sure to select "PCM".

Night Mode DVD VCD CD

Night mode is equivalent to Dynamic Range Compress. When it is On, it reduces the variations between loud and soft sounds in audio output. You can still hear softer sounds and dialog even in very low volume.

- 1) Press SETUP button.
- 2) Press ▲/▼ button to select **Audio**.
- 3) Press ► button, then use the ▲/▼ button to select **Night Mode**.
- 4) Press ENTER button, then use the ▲/▼ button to select On or Off mode.
- 5) Press ENTER button.
- 6) Press SETUP button to exit the menu.

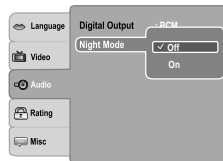

Note

Night mode is Dynamic Range Control (DRC) option for analog audio output.

Rating

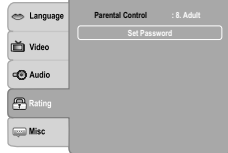

Parental Control (DVD)

DVDs equipped with the password function are rated according to their content. The contents allowed by a parental lock level and the way a DVD can be controlled may vary from disc to disc.

For example, if the disc allowed, you could edit out violent scenes unsuitable for children and replace them with more suitable scenes, or you could lock out playback of the disc altogether.

DVDs may or may not respond to the parental lock settings. This is not a defect in the DVD player. Make sure this function works with your DVDs.

1) Press SETUP button.

2) Press ▲ / ▼ to

select **Rating**.

3) Press ► button to select **Parental Control**, then press ENTER button. "Enter Password" screen will appear.

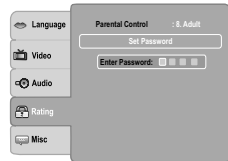

4) Press "8888" using number buttons. (Please note, this is presetting password of this unit). Then press ENTER. Press ENTER again to list the parental level.

The parental lock level is equivalent to the following ratings:

Level 1: Kid Safe	Level 5: PG-R
Level 2: G	Level 6: R
Level 3: PG	Level 7: NC-17
Level 4: PG-13	Level 8: Adult

5) Press ▲ / ▼ to select the rating from 1 to 8. Rating one (1) has the most restrictions while rating eight (8) can virtually playback all DVD software.

6) Press OPEN/CLOSE button to activate the Parental Level setting.

If the DVD has been designed to temporarily cancel the Parental Level, the screen will change depending on which disc is played. If you select "YES" with the ENTER button, "Enter Password" screen will appear. Input the 4-digit password as you have set then followed by ENTER button and playback will start. If "NO" is selected, press the OPEN/CLOSE to remove the disc.

Notes

- If you input a wrong password, press CLEAR button and re-enter your 4-digit password again.
- You cannot play DVDs rated higher than the level you selected unless you cancel the parental lock function.

Set Password (DVD)

New Password can be set to replace the default password.

- 1) Press SETUP button.
- 2) Press ▲ / ▼ button to select **Rating**.
- 3) Press ► button, then use the ▲ / ▼ button to select **Set Password**.
- 4) Press ENTER button. "Enter Password" screen will appear.
- 5) Press the number buttons to input the current password (If the password has not been set yet after you purchase this unit, it is "8888"). Then press ENTER.
- 6) Press ENTER button again, "New Password" screen will appear. Press the number buttons to input the new password.
- 7) Press ENTER button, "Confirm Password" screen will appear. Enter the same password again for confirmation.
- 8) Press ENTER button. Now your new password has been set. Be sure to remember this number!

If you forget the password, you can erase your current password by pressing number button 8 on the remote control four times, then press ENTER button to confirm the setting.

PASSWORD: 8888

Misc



Use Default Settings (DVD, VCD, CD)

If you want to return the initial language setting such as Language, Video, Audio and etc. to the factory default, do the following:

- 1) Press SETUP button.
- 2) Press ▲ / ▼ button to select **Misc**.
- 3) Press ► button to select **Use Default Settings**, then press ENTER button.
- 4) Press ◀ / ► button to select "Yes", then press ENTER button. The original setting will be restored.

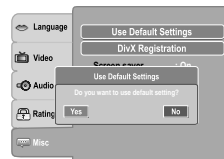

Note

When you reset the DVD player to the factory default, the DVD player will take 3-5 seconds to reset.

Customizing the Function Settings (continued)

Setting details

DivX® Registration

Some DivX® Video-On-Demand files required registration code, please get the code of your DVD player as follow:

- 1) Press SETUP button.
- 2) Press ▲ / ▼ button to select **Misc**.
- 3) Press ► button, then use the ▲ / ▼ button to select **DivX Registration**.
- 4) Press ENTER button, your registration code will be shown.
- 5) Press ENTER button.
- 6) Press SETUP button to exit the menu.



Note

This registration code is for DivX® Video-On-Demand only. Do not apply this code for other applications or websites.

Screen Saver

To turn on or off the screen saver (screen protection to prevent image burn).

- 1) Press SETUP button.
- 2) Press ▲ / ▼ button to select **Misc**.
- 3) Press ► button, then use the ▲ / ▼ button to select **Screen saver**.
- 4) Press ENTER button, then use the ▲ / ▼ button to select the On or Off mode.
- 5) Press ENTER button.
- 6) Press SETUP button to exit the menu.

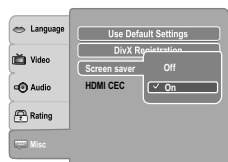

Note

When you leave the unit in DVD stop mode for approximately 2 minutes, the screen saver of the DVD player automatically appears if you set the Screen saver to On mode. To turn off the screen saver, press the PLAY button.

HDMI-CEC: REGZA-LINK®

You can control this DVD unit from TV's remote which is connected via HDMI cable.

- 1) Press SETUP button.
- 2) Press ▲ / ▼ button to select **Misc**.
- 3) Press ► button, then use the ▲ / ▼ button to select **HDMI CEC**.
- 4) Press ENTER button, then use the ▲ / ▼ button to select the On or Off mode.
- 5) Press ENTER button.
- 6) Press SETUP button to exit the menu.

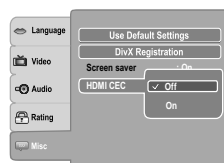

Off: To deactivate HDMI-CEC.

On: To activate HDMI-CEC.

Functions available for the HDMI-CEC

• One touch play

When the operations with following button of this unit's remote control are performed, the TV will automatically switch to appropriate input channel.
Button for one touch play: [PLAY] (make sure a disc is inserted.)

• System information

Get & Set Menu Language:

This unit recognizes the OSD languages set for the TV and automatically set the same language as the player menu language (OSD menu language) for this unit.

Power off:

When you turn the TV off, this unit will automatically turn off.

Receiving operational signal from TV's Remote:

You can operate this unit with TV's remote control. Check your TV owner's manual for details.

Notes

- This function may not work properly depending on the TV you are connecting.
- If the Video Out is not set to "HDMI", HDMI-CEC will not work.
- Other components must be compatible with HDMI-CEC in order to use this function.

Table of Languages

Table of languages and their abbreviations

Abbreviation	Language	Abbreviation	Language	Abbreviation	Language
---	No alternate language	GN	Guarani	PT	Portuguese
CHI (ZH)	Chinese	GU	Gujarati	QU	Quechua
DUT (NL)	Dutch	HA	Hausa	RM	Rhaeto-Romance
ENG (EN)	English	HI	Hindi	RN	Kirundi
FRE (FR)	French	HR	Croatian	RO	Rumanian
GER (DE)	German	HU	Hungarian	RU	Russian
ITA (IT)	Italian	HY	Armenian	RW	Kinyarwanda
JPN (JA)	Japanese	IA	Interlingua	SA	Sanskrit
KOR (KO)	Korean	IE	Interlingue	SD	Sindhi
MAY (MS)	Malay	IK	Inupiak	SG	Sango
SPA (ES)	Spanish	IN	Indonesian	SH	Serbo-Croatian
AA	Afar	IS	Icelandic	SI	Singhalese
AB	Abkhazian	IW	Hebrew	SK	Slovak
AF	Afrikaans	JI	Yiddish	SL	Slovenian
AM	Amharic	JW	Javanese	SM	Samoaan
AR	Arabic	KA	Georgian	SN	Shona
AS	Assamese	KK	Kazakh	SO	Somali
AY	Aymara	KL	Greenlandic	SQ	Albanian
AZ	Azerbaijani	KM	Cambodian	SR	Serbian
BA	Bashkir	KN	Kannada	SS	Siswati
BE	Belorussian	KS	Kashmiri	ST	Sesotho
BG	Bulgarian	KU	Kurdish	SU	Sundanese
BH	Bihari	KY	Kirghiz	SV	Swedish
BI	Bislama	LA	Latin	SW	Swahili
BN	Bengali, Bangla	LN	Lingala	TA	Tamil
BO	Tibetan	LO	Laotian	TE	Telugu
BR	Breton	LT	Lithuanian	TG	Tajik
CA	Catalan	LV	Latvian, Lettish	TH	Thai
CO	Corsican	MG	Malagasy	TI	Tigrinya
CS	Czech	MI	Maori	TK	Turkmen
CY	Welsh	MK	Macedonian	TL	Tagalog
DA	Danish	ML	Malayalam	TN	Setswana
DZ	Bhutani	MN	Mongolian	TO	Tongan
EL	Greek	MO	Moldavian	TR	Turkish
EO	Esperanto	MR	Marathi	TS	Tsonga
ET	Estonian	MT	Maltese	TT	Tatar
EU	Basque	MY	Burmese	TW	Twi
FA	Persian	NA	Nauru	UK	Ukrainian
FI	Finnish	NE	Nepali	UR	Urdu
FJ	Fiji	NO	Norwegian	UZ	Uzbek
FO	Faroese	OC	Occitan	VI	Vietnamese
FY	Frisian	OM	(Afan) Oromo	VO	Volapük
GA	Irish	OR	Oriya	WO	Wolof
GD	Scottish Gaelic	PA	Panjabi	XH	Xhosa
GL	Galician	PL	Polish	YO	Yoruba
		PS	Pashto, Pushto	ZU	Zulu

Others

Before Calling Service Personnel

Check the following guide for the possible cause of a problem before contacting service.

Symptoms and correction

Symptom	Cause	Correction	Page
No power.	<ul style="list-style-type: none"> The power plug is disconnected. 	<ul style="list-style-type: none"> Connect the power plug securely into the wall outlet. 	11-12
The DVD player turned off by itself.	<ul style="list-style-type: none"> The automatic power off function turned the unit off. 	<ul style="list-style-type: none"> Press the PLAY button. 	16
No picture or abnormal color (pinkish, greenish, etc.).	<ul style="list-style-type: none"> The TV is not set to receive DVD signal output. 	<ul style="list-style-type: none"> Select the appropriate video input mode on the TV so the picture from the DVD player appears on the TV screen. 	16
	<ul style="list-style-type: none"> The video/HDMI cable is not connected securely. 	<ul style="list-style-type: none"> Connect the video/HDMI cable securely into the appropriate jacks. 	11-12
	<ul style="list-style-type: none"> Mismatch setting between TV and this unit. 	<ul style="list-style-type: none"> Select the correct Video Output setting. 	31
	<ul style="list-style-type: none"> Wrong connection. PROGRESSIVE button is pressed on a TV equipped with component video input jacks but does not support progressive scan. 	<ul style="list-style-type: none"> Check the connection. Toggle PROGRESSIVE button to turn off progressive mode. 	11-12 12
No sound.	<ul style="list-style-type: none"> The equipment connected with the audio cable is not set to receive DVD signal output. 	<ul style="list-style-type: none"> Select the correct input mode of the audio receiver so you can listen to the sound from the DVD player. 	16
	<ul style="list-style-type: none"> The audio cable is not connected securely. 	<ul style="list-style-type: none"> Connect the audio cable securely into the appropriate jacks. 	11-15
	<ul style="list-style-type: none"> The audio receiver or TV is turned off. 	<ul style="list-style-type: none"> Turn on the equipment connected with the audio cable. 	16
	<ul style="list-style-type: none"> The setting of output sound format is incorrect. 	<ul style="list-style-type: none"> Select the proper audio setting. 	32
The playback picture has occasional distortion.	<ul style="list-style-type: none"> The disc is dirty. 	<ul style="list-style-type: none"> Remove the disc and clean it. 	5
	<ul style="list-style-type: none"> It is in fast forward or fast reverse playback. 	<ul style="list-style-type: none"> Sometimes a small amount of picture distortion may appear. This is not a malfunction. 	-
Brightness is unstable or noises are present in the playback pictures.	<ul style="list-style-type: none"> The effect of copy protection. 	<ul style="list-style-type: none"> Connect the DVD player directly to the TV. Avoid connecting the DVD player to a VCR or TV/VCR combination. 	11
The DVD player does not start playback.	<ul style="list-style-type: none"> No disc is inserted. 	<ul style="list-style-type: none"> Insert a disc. 	16
	<ul style="list-style-type: none"> An unplayable disc is inserted. 	<ul style="list-style-type: none"> Insert a playable disc. (Check the disc type and color system.) 	6
	<ul style="list-style-type: none"> The disc is placed upside down. 	<ul style="list-style-type: none"> Place the disc with the playback side down. 	16
	<ul style="list-style-type: none"> The disc is not placed within the guide. 	<ul style="list-style-type: none"> Place the disc correctly inside the guide on the disc tray. 	16
	<ul style="list-style-type: none"> The disc is dirty. 	<ul style="list-style-type: none"> Clean the disc. 	5
Playback does not follow the course of the disc's program.	<ul style="list-style-type: none"> The parental lock function is set. 	<ul style="list-style-type: none"> Cancel the parental lock function or change the parental lock level. 	33
	<ul style="list-style-type: none"> It is in the mode of repeat playback, memory playback, etc. 	<ul style="list-style-type: none"> These operations may prevent a proper progress of the contents. 	-
Buttons do not work.	<ul style="list-style-type: none"> Power supply fluctuations or other abnormalities such as static electricity may interrupt correct operations. 	<ul style="list-style-type: none"> Press and hold the ON/STANDBY button on the front panel for more than about 3 seconds. The DVD player turns off. Press the button again to turn it on. If the buttons still do not work, disconnect the power plug and insert it into the wall outlet again. 	-
The remote control does not work properly.	<ul style="list-style-type: none"> The remote control is not pointed at the remote sensor of the DVD player. 	<ul style="list-style-type: none"> Point the remote control at the remote sensor of the DVD player. 	10
	<ul style="list-style-type: none"> The remote control is too far from the DVD player. 	<ul style="list-style-type: none"> Operate the remote control within about 7 m. 	10
	<ul style="list-style-type: none"> The batteries in the remote control are exhausted. 	<ul style="list-style-type: none"> Replace the batteries with new ones. 	10

Specifications

DVD player / outputs / supplied accessories

DVD Player

Power supply	120 V AC, 60 Hz
Power consumption	8 W (standby: less than 1.0W)
Mass	1.26 kg
External dimensions	430 x 41 x 197 mm (W/H/D)
Signal system	NTSC
Laser	Semiconductor laser, wavelength 650/780 nm
Frequency range	DVD linear sound : 48 kHz sampling 4 Hz to 22 kHz 96 kHz sampling 4 Hz to 44 kHz
Signal-to-noise ratio	More than 93 dB
Audio dynamic range	More than 80 dB
Harmonic distortion	Less than 0.05 %
Wow and flutter	Below measurable level (less than ± 0.001 % (W.PEAK))
Operating conditions	Temperature: 5 °C to 35 °C, Operation status: Horizontal

Outputs

Video output	1.0 V (p-p), 75 Ω , negative sync., pin jack x 1
Component video output	(Y) 1.0 V (p-p), 75 Ω , negative sync., pin jack x 1 (P ₂)/(P ₂) 0.7 V (p-p), 75 Ω , pin jack x 2
Audio output (COAXIAL DIGITAL)	0.5V (p-p), 75 Ω , pin jack x 1
Audio output (ANALOG)	2.0 V (rms), 680 Ω , pin jacks (L, R) x 1
HDMI output	19 pin

Supplied Accessories

Audio/video cable	1
Remote control (SE-R0313)	1
Batteries (R03/AAA)	2
HDMI cable (for SDK990KU model only)	1

- This model complies with the above specifications.
- Designs and specifications are subject to change without notice.
- This model may not be compatible with features and/or specifications that may be added in the future.

Others

Limited United States Warranty

Digital Audio Video ("DAV") Product - Exchange Warranty

Toshiba America Consumer Products, L.L.C. ("TACP") makes the following limited warranties to original consumers in the United States.

THESE LIMITED WARRANTIES EXTEND TO THE ORIGINAL CONSUMER PURCHASER OR ANY PERSON RECEIVING THIS DAV PRODUCT AS A GIFT FROM THE ORIGINAL CONSUMER PURCHASER AND TO NO OTHER PURCHASER OR TRANSFEREE.

DAV PRODUCTS PURCHASED IN THE U.S.A. AND USED ANYWHERE OUTSIDE OF THE U.S.A., INCLUDING, WITHOUT LIMITATION, CANADA AND MEXICO, ARE NOT COVERED BY THESE WARRANTIES.

DAV PRODUCTS PURCHASED ANYWHERE OUTSIDE OF THE U.S.A., INCLUDING, WITHOUT LIMITATION, CANADA AND MEXICO, AND USED IN THE U.S.A., ARE NOT COVERED BY THESE WARRANTIES.

Limited Warranty

TACP warrants this DAV Product and its parts against defects in materials or workmanship for a period of ninety (90) days after the date of original retail purchase.

DURING THIS PERIOD, TACP WILL EXCHANGE A DEFECTIVE DAV PRODUCT WITH A NEW OR REFURBISHED DAV PRODUCT WITHOUT CHARGE TO YOU. DURING THE PERIOD THAT COMMENCES ON THE DATE THAT IS NINETY ONE (91) DAYS AFTER THE DATE OF ORIGINAL RETAIL PURCHASE AND ENDS ON THE DATE THAT IS THREE HUNDRED SIXTY FIVE (365) DAYS AFTER THE DATE OF ORIGINAL RETAIL PURCHASE, TACP WILL EXCHANGE A DEFECTIVE DAV PRODUCT WITH A NEW OR REFURBISHED DAV PRODUCT FOR A FEE.

Rental Units

The warranty for DAV Product rental units begins on the date of the first rental or thirty (30) days after the date of shipment to the rental firm, whichever comes first.

Commercial Units

DAV Products sold and used for commercial purposes have a limited warranty for all parts and labor, which warranty begins on the date of original retail purchase and ends on the date that is ninety (90) days thereafter.

Owner's Manual and Product Registration Card

Read this owner's manual thoroughly before operating this DAV Product. Complete and mail the enclosed product registration card or register your DAV Product on-line at www.tacp.toshiba.com/service as soon as possible. By registering your DAV Product you will enable TACP to bring you new products specifically designed to meet your needs and help us to contact you in the unlikely event a safety notification is required under the U.S. Consumer Product Safety Act. Failure to complete and return the product registration card does not diminish your warranty rights.

Your Responsibility

THE ABOVE WARRANTIES ARE SUBJECT TO FOLLOWING CONDITIONS:

- (1) You must retain your bill of sale or provide other proof of purchase.
- (2) All warranty servicing of this DAV Product must be made pursuant to the TACP DAV Product Warranty Exchange Program.
- (3) The warranties from TACP are effective only if the DAV Product is purchased and operated in the Continental U.S.A. or Puerto Rico.
- (4) Labor service charges for set installation, setup, adjustment of customer controls, and installation or repair of antenna systems are not covered by this warranty. Reception problems caused by inadequate antenna systems are your responsibility.
- (5) Warranties extend only to defects in materials or workmanship as limited above, and do not extend to any DAV Product or parts that have been lost or discarded by you or to damage to the DAV Product or parts caused by fires, misuse, accident, Acts of God (such as lightning or fluctuations in electric power), improper installation, improper

maintenance, or use in violation of instructions furnished by TACP; use or malfunction through simultaneous use of this DAV Product and connected equipment; or to units that have been modified or had the serial number removed, altered, defaced, or rendered illegible.

- (6) This warranty does not cover Product sold AS IS or WITH ALL FAULTS.

How to Obtain Warranty Services

If, after following all of the operating instructions in this manual and checking the section "Before Calling Service Personnel," you find that service is needed:

- (1) For instructions on how to obtain warranty service for your DAV Product under the TACP DAV Product Warranty Exchange Program, contact TACP's Consumer Solutions Center toll free at 1-800-631-3811.
- (2) You must include the original bill of sale (or a copy of the original bill of sale) or other proof of purchase along with the entire DAV Product when sending the DAV Product to the TACP Warranty Exchange Center specified by TACP's Consumer Solutions Center. You are responsible for all inbound transportation and insurance charges for the DAV Product to the TACP Warranty Exchange Center.

For additional information, visit TACP's website: www.tacp.toshiba.com

ALL WARRANTIES IMPLIED BY THE LAW OF ANY STATE OF THE U.S.A., INCLUDING THE IMPLIED WARRANTIES OF MERCHANTABILITY AND FITNESS FOR A PARTICULAR PURPOSE, ARE EXPRESSLY LIMITED TO THE DURATION OF THE LIMITED WARRANTIES SET FORTH ABOVE. WITH THE EXCEPTION OF ANY WARRANTIES IMPLIED BY THE LAW OF ANY STATE OF THE U.S.A. AS HEREBY LIMITED, THE FOREGOING WARRANTY IS EXCLUSIVE AND IN LIEU OF ALL OTHER WARRANTIES, GUARANTEES, AGREEMENTS, AND OF ALL OTHER WARRANTIES, GUARANTEES, AGREEMENTS, AND OR REPLACEMENT OF ANY PARTS. IN NO EVENT SHALL TACP BE LIABLE FOR CONSEQUENTIAL OR INCIDENTAL DAMAGES (INCLUDING, BUT NOT LIMITED TO, LOST PROFITS, BUSINESS INTERRUPTION, OR MODIFICATION OR ERASURE OF RECORDED DATA CAUSED BY USE, MISUSE OR INABILITY TO USE THIS DAV PRODUCT).

No person, agent, distributor, dealer, or company is authorized to change, modify, or extend the terms of these warranties in any manner whatsoever. The time within which an action must be commenced to enforce any obligation of TACP arising under the warranty or under any statute or law of the United States or any state thereof is hereby limited to ninety (90) days from the date you discover, or should have discovered, the defect. This limitation does not apply to implied warranties arising under state law.

THIS WARRANTY GIVES YOU SPECIFIC LEGAL RIGHTS AND YOU MAY ALSO HAVE OTHER RIGHTS WHICH MAY VARY FROM STATE TO STATE IN THE U.S.A. SOME STATES OF THE U.S.A. DO NOT ALLOW LIMITATIONS ON HOW LONG AN IMPLIED WARRANTY LASTS, WHEN AN ACTION MAY BE BROUGHT, OR THE EXCLUSION OR LIMITATION OF INCIDENTAL OR CONSEQUENTIAL DAMAGES, SO THE ABOVE PROVISIONS MAY NOT APPLY TO YOU UNDER SUCH CIRCUMSTANCES.

Limited Canadian Warranty

For Toshiba Brand Digital Audio/Video Products

Toshiba of Canada Limited ("TCL") makes the following limited warranties to original consumers in Canada. **THESE LIMITED WARRANTIES EXTEND TO THE ORIGINAL CONSUMER PURCHASER OR ANY PERSON RECEIVING THIS TOSHIBA BRAND DIGITAL AUDIO/VIDEO PRODUCT (the "DAV PRODUCT(S)" or "DAV Product (s)" AS A GIFT FROM THE ORIGINAL CONSUMER PURCHASER AND TO NO OTHER PURCHASER OR TRANSFEREE.**

DAV PRODUCTS PURCHASED IN CANADA, AND USED ANYWHERE OUTSIDE OF CANADA INCLUDING, WITHOUT LIMITATION, THE UNITED STATES AND MEXICO, ARE NOT COVERED BY THESE WARRANTIES.

DAV PRODUCTS PURCHASED ANYWHERE OUTSIDE OF CANADA, INCLUDING, WITHOUT LIMITATION, THE UNITED STATES AND MEXICO, AND USED IN CANADA, ARE NOT COVERED BY THESE WARRANTIES.

Limited One (1) Year Warranty on Parts and Labour

Subject to the more limited warranty if the DAV Product is used for any commercial or business purposes as set out below, TCL warrants the DAV Product and its parts against material defects in materials or workmanship that result in the DAV Product failing for a period of one (1) year after the date of original retail purchase. **DURING THIS PERIOD, TCL WILL, AT TCL'S OPTION, REPAIR OR REPLACE A DEFECTIVE PART WITH A NEW OR REFURBISHED PART, WITHOUT CHARGE TO YOU FOR PARTS OR LABOUR. YOU MUST DELIVER THE ENTIRE DAV PRODUCT TO A TCL DAV PRODUCT AUTHORIZED SERVICE PROVIDER ("ASP"). YOU MUST PAY FOR ALL TRANSPORTATION AND INSURANCE CHARGES FOR THE DAV PRODUCT TO AND FROM THE ASP.**

Rental Units

The warranty for DAV Product rental units begins with the date of first rental or thirty (30) days from the date of shipment to the rental firm, whichever comes first.

Limited Warranty for Commercial Units

TCL warrants DAV Products that are used for any commercial or business purposes as follows: all parts are warranted against material defects in materials or workmanship that result in the DAV Product failing for a period of ninety (90) days after the date of original retail purchase. **DURING THIS PERIOD, TCL WILL, AT TCL'S OPTION, REPAIR OR REPLACE A DEFECTIVE PART WITH A NEW OR REFURBISHED PART, WITHOUT CHARGE TO YOU FOR PARTS OR LABOUR. YOU MUST DELIVER THE ENTIRE DAV PRODUCT TO AN ASP. YOU MUST PAY FOR ALL TRANSPORTATION AND INSURANCE CHARGES FOR THE DAV PRODUCT TO AND FROM THE ASP.**

Your Responsibility

THE ABOVE WARRANTIES ARE SUBJECT TO THE FOLLOWING CONDITIONS:

- (1) You must provide your bill of sale or other proof of purchase.
- (2) All warranty servicing of this DAV Product must be performed by an ASP.
- (3) The warranties from TCL are effective only if the DAV Product is (i) purchased as new and unopened from TCL or from TCL's authorized distributors, dealers or resellers ("ADR's") and (ii) located/operated in Canada.
- (4) Warranties extend only to material defects in materials or workmanship as limited above, and do not extend to:
 - a. Service, repairs or replacement made necessary by accident, misuse, abuse, moisture, liquids, dust, dirt, neglect, accident, damage, 24/7 applications, improper installation, improper operation, improper cleaning, improper maintenance, normal wear and tear, or any other external cause or event, act or omission outside the

control of TCL, including fire, theft, acts of God, alteration, power failures, power surges or power shortages, lightning, other electrical faults, or repairs, modifications or replacements by persons other than those authorized by TCL to service the DAV Product;

- b. Replacement of missing, discarded or lost parts, the provision of retrofits, or preventive maintenance;
- c. Repair of damage that is cosmetic only or does not affect the DAV Product functionality, such as wear and tear, scratches and dents;
- d. Service on Toshiba-branded accessory items (such accessory items may be covered by their own warranty);
- e. Service on third party products or service made necessary by use of incompatible third party products;
- f. Service made necessary by the simultaneous use of this DAV Product and connected equipment;
- g. Modifications to the DAV Product not approved in writing by TCL, and service made necessary by the use or installation of non-Toshiba modifications to the DAV Product;
- h. Service of a DAV Product on which the TOSHIBA label or logo, rating label or serial number have been defaced or removed;
- i. On-site service and repair of the DAV Product;
- j. Damage to the DAV Product caused by failure to follow the specifications, User manuals or guides as to usage and/or storage.

Disclaimer and Limitation of Remedy

TO THE EXTENT NOT PRECLUDED BY LAW, ALL OTHER EXPRESS AND IMPLIED WARRANTIES, CONDITIONS AND REPRESENTATIONS FOR THIS DAV PRODUCT, INCLUDING THE IMPLIED WARRANTIES AND CONDITIONS OF MERCHANTABILITY AND FITNESS FOR A PARTICULAR PURPOSE, ARE HEREBY DISCLAIMED AND EXCLUDED. IF THE APPLICABLE LAW, STATUTORY OR OTHERWISE, PRECLUDES THE EXCLUSION OF ANY IMPLIED WARRANTIES, CONDITIONS AND REPRESENTATIONS THEN SUCH IMPLIED WARRANTIES, CONDITIONS AND REPRESENTATIONS ARE OTHERWISE LIMITED IN DURATION TO THE TEAM OF THIS EXPRESS WRITTEN LIMITED WARRANTY. TO THE EXTENT NOT PRECLUDED BY LAW, STATUTORY OR OTHERWISE, THIS WRITTEN WARRANTY SUPERCEDES AND SPECIFICALLY DISCLAIMS ANY OTHER WARRANTY, CONDITION OR REPRESENTATION NOT STATED IN THIS WARRANTY, WHETHER MADE BY TCL, TOSHIBA CORPORATION, THEIR AFFILIATES, ADRs AND ASPs AND WHETHER MADE ORALLY OR IN WRITING (INCLUDING ANY STATEMENT IN ANY BROCHURE, PRESS RELEASE, ANNOUNCEMENT, ADVERTISEMENT, POINT OF SALE DISPLAY, ETC.).

Others

YOU MUST READ AND FOLLOW ALL SET-UP AND USAGE INSTRUCTIONS IN THE APPLICABLE USER GUIDES AND/OR MANUALS. IF YOU FAIL TO DO SO, THIS DAV PRODUCT MAY NOT FUNCTION PROPERLY AND YOU MAY SUFFER DAMAGE. THIS WARRANTY WILL NOT COVER ANY SERVICE THAT IS REQUIRED, IN PART OR IN WHOLE, AS A RESULT OF ANY FAILURE TO FOLLOW THE SET-UP AND USAGE INSTRUCTIONS. THIS WARRANTY DOES NOT APPLY AND SHALL BE VOID AND UNENFORCEABLE IF THE DAV PRODUCT IS OPENED, SERVICED, OR REPAIRED BY PERSONS OTHER THAN THOSE AUTHORIZED BY TCL TO SERVICE OR REPAIR THE DAV PRODUCT.

IF THE DAV PRODUCT FAILS TO WORK AS WARRANTED ABOVE, YOUR SOLE AND EXCLUSIVE REMEDY SHALL BE REPAIR OR REPLACEMENT OF THE DEFECTIVE PART. IN NO EVENT WILL TCL, TOSHIBA CORPORATION, THEIR AFFILIATES, ADRs OR ASPs (THE "RELATED PARTIES") BE LIABLE TO YOU OR ANY THIRD PARTY FOR ANY DAMAGES, MONEY, REIMBURSEMENT, COSTS OR EXPENSES. THIS LIMITATION APPLIES TO DAMAGES, MONEY, REIMBURSEMENT, COSTS OR EXPENSES OF ANY KIND WHATSOEVER INCLUDING ANY DIRECT OR INDIRECT DAMAGES, DAMAGE TO PROPERTY OR PERSON, LOST PROFITS, LOST SAVINGS, INCONVENIENCE OR OTHER SPECIAL, INCIDENTAL, EXEMPLARY OR CONSEQUENTIAL DAMAGES, WHETHER FOR BREACH OF WARRANTY, BREACH OF CONTRACT, TORT (INCLUDING NEGLIGENCE), UNDER A STATUTE OR UNDER ANY OTHER LAW OR FORM OR ACTION, OR WHETHER ARISING OUT OF THE USE OF OR INABILITY TO USE THE DAV PRODUCT, EVEN IF ANY OF THE RELATED PARTIES HAS BEEN ADVISED OF THE POSSIBILITY OF SUCH DAMAGES OR OF ANY CLAIM BY ANY OTHER PARTY.

No person, agent, distributor, dealer or company is authorized to change, modify or extend the terms of these warranties in any manner whatsoever.

Arbitration and Dispute Resolution

To the extent not precluded by law, any claim, dispute, controversy or disagreement (whether for breach of warranty, breach of contract, tort (including negligence), under a statute or under any other law or form of action) against any of the Related Parties arising out of, or otherwise relating to: (i) this warranty; (ii) the DAV Product; (iii) any oral or written representations, statements, brochures, press releases, advertising, announcement, point of sale display, or promotional material relating to the DAV Product; (iv) the relationships that result from this warranty, (the foregoing claims, disputes controversies and disagreements are collectively referred to as the "Dispute"), shall be referred to and resolved by final and binding arbitration (to the exclusion of the courts). To the extent not precluded by law, you agree to waive any right that you may have to commence or participate in any representative or class proceeding against the Related Parties relating to any Dispute. If and where applicable and to the extent not precluded by law, you further agree to opt out of any such representative or class proceedings. Arbitration of any Dispute will be conducted in the forum and in the manner as agreed to between you and TCL. Failing such agreement, the arbitration will be conducted by one arbitrator pursuant to the laws and rules relating to arbitration generally in force in the jurisdiction in which you reside at the time that the Dispute arises. To the extent not precluded by law, no claim, dispute, controversy or disagreement of any other person may be joined or combined with any Dispute by you, without the prior written consent of TCL.

Critical Applications

The DAV Product you have purchased is not designed for any "critical applications." "Critical applications" means life support systems, medical applications, connections to implanted medical devices, commercial transportation, nuclear facilities or systems or any other applications where DAV Product failure could lead to injury to persons or loss of life or catastrophic property damage.

IF THE CUSTOMER USES THE DAV PRODUCT IN ANY CRITICAL APPLICATION, THE CUSTOMER AND NOT TCL, ITS AFFILIATES, ADRs OR ASPs - ASSUME SOLE AND FULL RESPONSIBILITY FOR SUCH USE. TCL RESERVES THE RIGHT TO REFUSE TO SERVICE ANY DAV PRODUCT USED IN A CRITICAL APPLICATION. TCL, ITS AFFILIATES, ADRs AND ASPs HEREBY DISCLAIM ANY AND ALL LIABILITY, DAMAGES AND CONSEQUENCES ARISING OUT OF THE SERVICE OR REFUSAL TO SERVICE SUCH DAV PRODUCT AND FURTHER DISCLAIM ANY AND ALL LIABILITY, CONSEQUENCES AND DAMAGES THAT MAY ARISE OR RESULT FROM THE USE OF THE DAV PRODUCT IN ANY CRITICAL APPLICATIONS.

General Provisions

If and to the extent that any provision of this limited warranty should generally be found to be unenforceable, the unenforceable provision shall be severed from the warranty and deemed not to form part of the warranty. The remaining provisions of this warranty shall be and remain valid and enforceable. If and to the extent that any provision of this limited warranty as it relates to any of the Related Parties is found to be invalid or unenforceable in respect of that party (the "Excluded Party"), the Excluded Party shall be deemed to be severed or excluded from the provision, and the provision shall remain valid, enforceable and applicable in respect of the other or remaining Related Parties.

To the extent permitted by law, this limited warranty shall be governed and construed in accordance with the laws of Ontario.

If there is any inconsistency between this limited warranty, on the one hand, and any statement in the packaging of the DAV Product or in any other document enclosed with, or used in the context of the promotion or sale of, the DAV Product, on the other hand, the provisions of this limited warranty shall prevail.

How to Obtain Warranty Services

If, after following all of the operating instructions in this manual and checking the "Before Calling Service Personnel" section, you find that service is needed:

- (1) To find the nearest ASP, visit TCL's web site at www.toshiba.ca, or call toll free 1-800-268-3404.
- (2) Present your bill of sale or other proof of purchase to the ASP.

For additional information, visit TCL's website: www.toshiba.ca

TOSHIBA