

WOOLWORTHS

Worthit!

DVD 1047UKW USER MANUAL



DVD/CD/CD-R/CD-RW PLAYER

Please read instructions carefully before use and retain for future reference.

IMPORTANT SAFETY INSTRUCTIONS



CAUTION
RISK OF ELECTRIC SHOCK
DO NOT OPEN



The lightning flash with arrowhead symbol within an equilateral triangle intended to alert the user to the presence of uninsulated dangerous voltage within the product's enclosure that may of sufficient magnitude to constitute a risk of electric shock to persons.



The exclamation point within an equilateral triangle is intended to alert the user to the presence of important operating and maintenance (servicing) instructions in the literature accompanying the appliance.

- 1. READ INSTRUCTIONS** - All the safety and operating instructions should be read before the product is operated.
- 2. RETAIN INSTRUCTIONS** - The safety and operating instructions should be retained for future reference.
- 3. HEED WARNINGS** - All warnings on the product and in the operating instructions should be adhered to.
- 4. FOLLOW INSTRUCTIONS** - All operating and use instructions should be followed.
- 5. CLEANING** - Unplug this product from the wall outlet before cleaning. Do not use liquid cleaners or aerosol cleaners. Use a soft dry cloth for cleaning.
- 6. ATTACHMENTS** - Do not use attachments not recommended by the product manufacturer as they may cause hazards.
- 7. WATER AND MOISTURE** - Do not use this product near water - for example, near a bath tub, wash bowl, kitchen sink, or laundry tub; in a wet basement; or near a swimming pool; and the like.
- 8. ACCESSORIES** - Do not place this product on an unstable trolley, stand, tripod, bracket, or table. The product may fall, causing serious injury to a child or adult, and serious damage to the product.

Use only with a cart, stand, tripod, bracket, or table recommended by the manufacturer, or sold with the product. Any mounting of the product should follow the manufacturer's instructions, and should use a mounting accessory recommended by the manufacturer.

A Product and Cart Combination Should Be Moved with Care - Quick stops, excessive force and uneven surfaces may cause the product and cart combination to overturn.



9. VENTILATION - Slots and openings in the cabinet are provided for ventilation and to ensure reliable operation of the product and to protect it from overheating, and these openings must not be blocked or covered. The openings should never be blocked by placing the product on a bed, sofa, rug or other similar surface. This product should not be placed in a built-in installation, such as a bookcase or rack, unless proper ventilation is provided or the manufacturer's instructions have been adhered to.

10. POWER SOURCES - This product should be operated only from the type of power source indicated on the marking label. If you are not sure of the type of power supply to your home, consult a professional electrician or local power company. For products intended to operate from battery power, or other sources, refer to the operating instructions.

11. POWER-CORD PROTECTION - Power supply cords should be routed so that they are not likely to be walked on or pinched by items placed upon or against them, paying particular attention to cords at plugs, convenience receptacles, and the point where exit from the product.

IMPORTANT SAFETY INSTRUCTIONS

12. NONUSE PERIODS - The power cord of the product should be unplugged from the outlet when left unused for long periods of time.

13. OUTDOOR ANTENNA GROUNDING - If an outside antenna or cable system is connected to the product, be sure the antenna or cable system is grounded so as to provide some protection against voltage surges and built-up static charges. Below diagram provides information with regard to proper grounding of the mast and supporting structure, grounding of the lead-in wire to an antenna discharge unit, size of grounding conductors, location of antenna-discharge unit, connection to grounding electrodes, and requirements for the grounding electrode. See Figure 1.

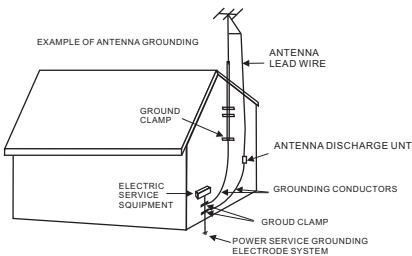

14. LIGHTNING - For added protection for this product during a lightning storm, or when it is left unattended and unused for long periods of time, unplug it from the wall outlet and disconnect the antenna or cable system. This will prevent damage to the product due to lightning and power-line surges.

15. POWER LINES - An outside antenna system should not be located in the vicinity of overhead power lines or other electric light or power circuits, or where it can fall into such power lines or other electric light or power circuits. When installing an outside antenna system, extreme care should be taken to keep from touching power lines or circuits as contact with them might be fatal.

16. OVERLOADING - Do not overload wall outlets, extension cords, or integral convenience receptacles as this can result in a risk of fire or electric shock.

17. OBJECT AND LIQUID ENTRY - Never push objects of any kind into this product through openings as they may touch dangerous voltage points or short-out parts that could result in a fire or electric shock. Never spill liquid of any kind on the product.

18. SERVICING - Do not attempt to service this product yourself as opening or removing covers may expose you to dangerous voltage or other hazards. Refer all servicing to qualified service personnel.

19. DAMAGES REQUIRING SERVICE -

Unplug this product from the wall outlet and refer servicing to qualified service personnel under the following conditions.

- When the power-supply cord or plug is damaged.
- If liquid has been spilled, or objects have fallen into the product.
- If the product has been exposed to rain or water.
- If the product does not operate normally by following the operating instructions. Adjust only those controls that are covered by the operating instructions as an improving adjustment of other controls may result in damage and will often require extensive work by a qualified technician to restore the product to its normal operation.
- When the product exhibits a distinct change in performance - this indicates a need for service.

20. REPLACEMENT PARTS -

When replacement parts are required, be sure the service technician has used replacement parts specified by the manufacturer or have the same characteristics as the original part. Unauthorized substitutions may result in fire, electric shock or other hazards.

21. SAFETY CHECK - Upon completion of any service or repair to this product, ask the service technician to perform safety checks to determine that the product is in proper operating condition.

22. HEAT - The product should be situated away from heat sources such as radiators, heat registers, stoves or other products (including amplifiers) that produce heat.

23. Keep minimum distances (5cm) around the apparatus for sufficient ventilation.

24. The ventilation should not be impeded by covering the rear panel for ventilation with items, such as newspapers, table-cloths, curtains, etc.

25. No naked flame sources, such as lighted candles, should be placed on the apparatus.

26. Don't use the apparatus in tropical climates.

27. Where the mains plug is used as the disconnect device, the disconnect device shall remain readily operable.

28. The apparatus shall not be exposed to dripping or splashing and that no objects filled with liquids, such as vases, shall be placed on the apparatus.

29. Attention should be drawn to the environmental aspects of battery disposal. Don't throw used batteries in dustbin. Please contact your retailer in order to protect the environment.

IMPORTANT SAFETY INSTRUCTIONS

To protect intellectual property, the involved organizations partition the world into six regions, each of which can only use the DVD player and DVD disc with the given regional code.

The illustration on the right shows symbols of the six regions. One DVD player with a given regional code cannot play disc of another regional code. The partition of regional codes is shown as follows:

1. Canada, USA;
2. Japan, Europe, South Africa, Middle East
3. Southeast Asia, East Asia
4. Australia, New Zealand, Oceania, Central America, Mexico, Latin America, Caribbean Sea;
5. Russia, India, Africa, Korea, Mongolia.
6. China.







Note: THE REGION CODE FOR THE UNIT IS 2.





TV connections for DVD discs recorded in PAL and NTSC systems

Generally, DVD discs are recorded in PAL or NTSC systems, please refer to the following table:





■ Connecting to the multi-system TV

DISC	TV MONITOR
 PAL	 Play in PAL system
 NTSC	 Play in NTSC system

■ Connecting to NTSC TV

DISC	TV MONITOR
 PAL	 No clear images are shown on the screen.
 NTSC	 Play in NTSC system

■ Connecting to PAL TV

DISC	TV MONITOR
 PAL	 Play in PAL system
 NTSC	 No clear images are shown on the screen.

Please read the user manual carefully before connection or operation

TABLE OF CONTENT

Important Safety	1
Features	5
Precautions	5
Accessories	6
Front Panel	6
Rear Panel	6
Remote Control	7
Basic Connection	8
Remote Control Preparation	10
Operations	11
Preparation	11
Play	11
Stop	11
Prev/Next	11
FB/FF	11
Slow	11
Step	11
Pause	11
Number(0-9,10+) button	11
Mute	12
VOL+/VOL-	12
Return	12
OSD	12
Zoom	12
A-B Repeat	12
Repeat	12
Angle	12
Audio	12
Program	12
PBC	12
GO TO	13
Title/Chapter search	13
Menu	13
Subtitle	13
Clear	13
N/P	13
Setup	14
Reference(Menu/Submenu/Options)	15
Handling Precautions	16
player Maintenance	16
Definition of terms	17
Specifications	17
Troubleshooting	18

FEATURES

DVD - A completely new dimension in video entertainment

- Subtitles may be displayed in one of a maximum of 32 languages available (multi-subtitles DVD only).
- Audio soundtrack can be heard in up to 8 languages (multi-languages DVD only).
- Multi-angle function allows you to choose the viewing angles of scene (for DVD with multiple camera angles only).

Other convenient features

- Parental lock settings to prevent playing unsuitable discs for some audiences (DVD only). A full function remote control provides quick access to DVD functions.

Compatible with PAL DVD and NTSC DVD

- This player can play discs recorded in either PAL or NTSC system.

Compatible with CD besides DVD, MP3, CD-R

- This player could play various discs such as DVD, CD (8cm/12cm discs).

PRECAUTIONS

- Please read these precautions before operating this unit.

Power cord protection

- To avoid any malfunctions of the unit, and to protect against electric shock, fire or personal injury, please observe the following.
- Hold the plug firmly when connecting or disconnecting the AC power cord to this unit.
- Do not connect or disconnect the AC power cord when your hands are wet.
- Keep the AC power cord away from heating appliances.
- Never put any heavy object on the AC power cord.
- Do not attempt to repair or reconstruct the AC power cord.
- Remove dust, dirt etc. on the plug regularly.
- If the unit has been dropped or otherwise damaged, turn off the power and disconnect the AC power cord.
- If you find smoke, unusual odour or noise from the unit, turn off the power and disconnect the AC power cord.

Placement

The internal parts may be seriously damaged if the unit is placed in areas of:

- Direct sunlight or heating radiators or closed automobiles;
- High temperature (over 35°C) or high humidity (over 90%)
- Excessive dust;
- Strong magnetic or static electricity;
- Vibration, impact or where the surface is tilted.

Non-use Periods

- Turn off the power when the unit is not used.
- It should be unplugged when the unit is idle for a long period of time.

No fingers or other objects inside

- Touching internal parts of this unit is dangerous, and may cause serious damage to the unit and even human injury.
- Do not try to disassemble this unit.
- Do not put any other object on the disc tray.

Keep away from water and magnets

- Keep the unit away from flower vases, tubs, sinks, etc. If liquids are spilled into the unit, serious damage could occur.
- Never place magnetic objects such as speakers near the unit.

Stacking

- Place the unit in a horizontal position and do not place anything heavy on it.
- Do not put the unit on amplifiers or other equipment.

Condensation

Moisture may form on the lens under the following conditions:

- In a steamy or very humid room.
- Immediately after a heater is turned on.
- If moisture forms inside this unit, it may not operate properly. In this case, turn on the power and wait for about 1 hour to evaporate it.

Interference for the TV broadcast

- Depending on the reception condition of the TV, interference may appear on the TV screen while you are watching a TV broadcast and the unit is turned on. This is not a malfunction of the unit of the TV. Just ensure that the unit is turned off when you watch a TV broadcast.

ACCESSORIES

(Please check whether all the following accessories are available after unpacking.)

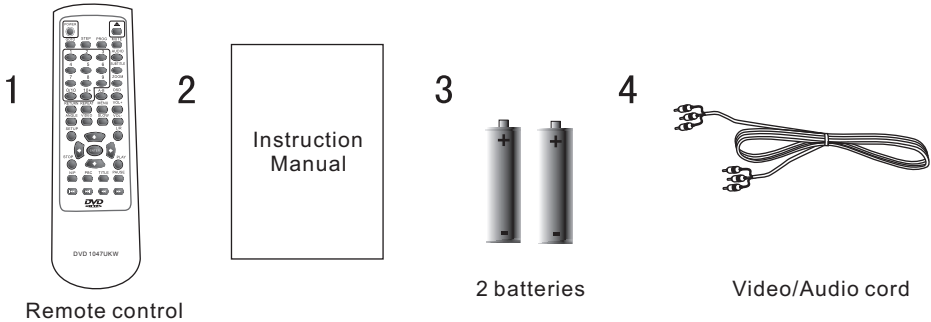

FRONT PANEL

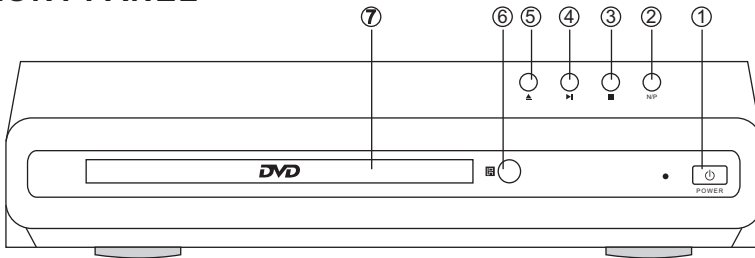

1. Power switch key
2. N/P key
3. Stop key
4. Play/Pause key

5. Open/Close key
6. Remote control sensor
7. Disc tray

REAR PANEL

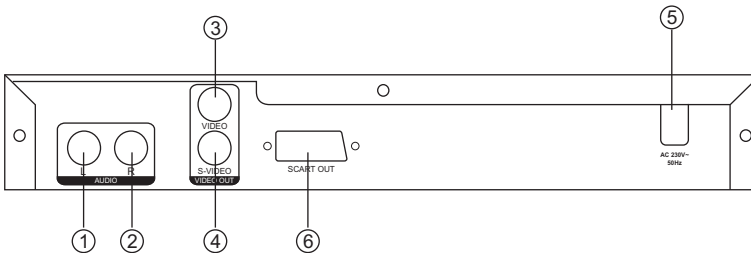

1. Left audio output jack
2. Right audio output jack
3. Video output

4. S-video output jack
5. AC power cord
6. Scart out output jack

REMOTE CONTROL

1. OPEN/CLOSE button
2. Program button
3. Mute button
4. Audio button
5. Subtitle button
6. Zoom button
7. A-B button
8. OSD button
9. Menu button
10. VOL+ button
11. Slow button
12. VOL- button
13. L/R button
14. Enter button
15. Play button
16. Title button
17. Pause button
18. Fast reverse button
19. Fast forward button
20. N/P button
21. Next button
22. N/P button
23. PBC button
24. Stop button
25. ◀▶▼▲ button
26. Setup button
27. Angle button
28. Clear button
29. Return button
30. Repeat button
31. Number (0-9) button
32. GO TO button
33. Step button
34. Power button

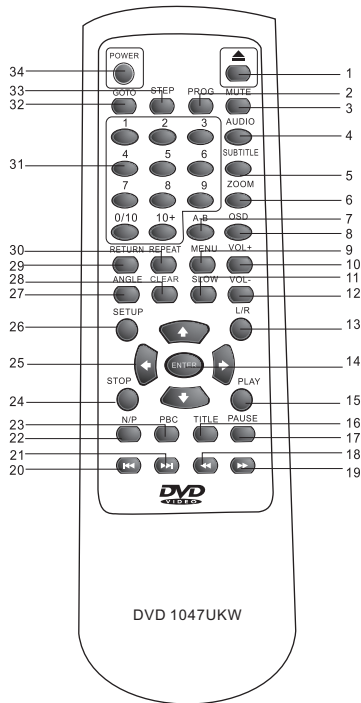

Note:

The same buttons on remote control and front panel have identical functions.

BASIC CONNECTION

- Ensure that the power switch of this unit and other equipment to be connected is turned off before commencing connection.
- Read through the instructions before connecting other equipment.
- Ensure that you observe the colour-coding when connecting audio and video cords.

A: Connecting to a stereo TV set

1. TV set (optional)
2. DVD/CD player
3. Connecting Video, R/L audio cords
4. To TV set audio input connector
5. Connecting cord to Scart jack (option)
6. To Scart jack
7. AC power cord

To get the best viewing quality you are advised to use S-video cord to connect the TV set with S-video input and to change the TV set to S-video input mode.

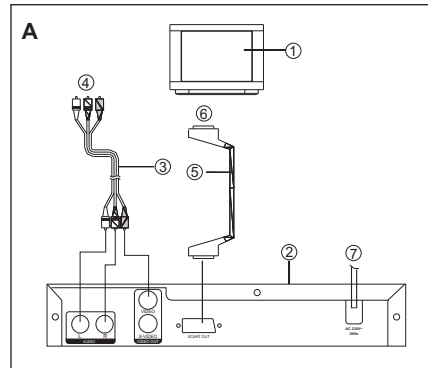

B: Connection to monophonic TV

1. TV set (optional)
2. DVD/CD player
3. Connecting L/R audio cords
4. To TV set audio input connector
5. Component connector cord (video)

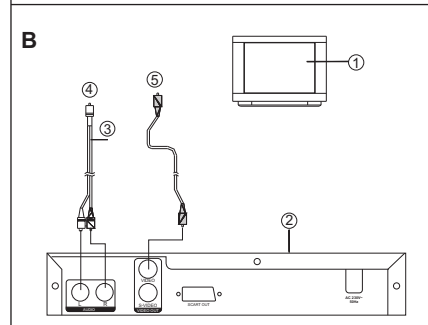

C: Connection to audio equipment

1. Audio player (optional)
2. TV set (optional)
3. DVD/CD players
4. To TV video input connector (yellow)
5. To audio input connectors (red, white)
6. To TV S-video input connector

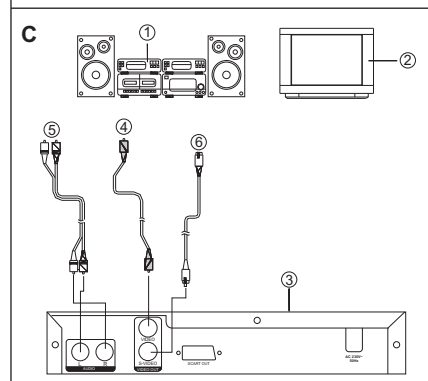

BASIC CONNECTION

D: Connecting to AV amplifier with 2-channel input connector

- 1.TV set (optional)
- 2.DVD / CD player
- 3.Video / S-video cord (optional)
- 4.Amplifier with 2 channel input jacks
- 5.To audio input connector (L,R)
- 6.Left speaker
- 7.Right speaker

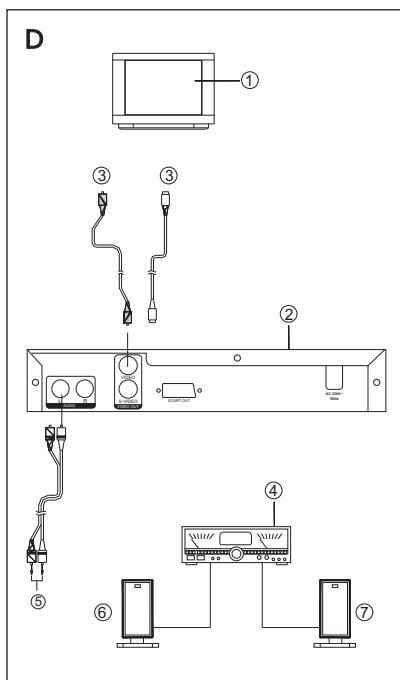

REMOTE CONTROL PREPARATION

Battery Installation

Insert the batteries while observing the positive (+) and Negative (-) polarities as Figure A.

Service life of batteries

The batteries normally last for a year although this depends on the operation and on how often the remote control is used.

If the remote control unit fails to work even when it is operated near the player, replace the batteries with new ones. Use size AAA UM-4 batteries (2 pieces).

Notes:

- Do not use rechargeable (Ni-Cd) batteries.
- Install batteries correctly observing the (+/-) polarity signs.
- Do not drop, step on the remote control, otherwise it may damage the parts or lead to malfunctioning.
- Use only the recommended battery type or equivalent (voltage and size).
- Always replace a complete set of batteries at the same time.
- Do not mix batteries of different types.
- Never mix new and used batteries in the same compartment.
- Remove exhausted batteries immediately.
- Remove batteries when product is not in use.
- Do not dispose of batteries in fire as they may explode.
- Do not recharge non-rechargeable batteries.
- Do not short circuit the supply terminals.
- Ensure batteries are stored away from metal objects as contact may cause a short circuit.
- Remote control operation range is no more than 5 m from and within about 60 degree wide in front of the unit (Figure B).

Notes:

- Do not point bright lights to the remote control sensor.
- Do not place objects between the remote control and the remote control sensor.
- Do not use this remote control together with the remote control of any other equipment.

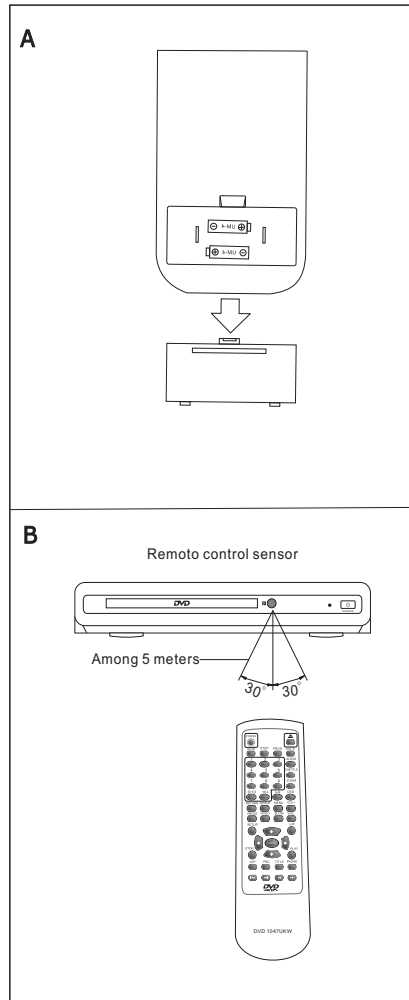

OPERATION

PREPARATION BEFORE PLAYING DISC

- The option of display language catalogue is preset to English. Please refer to Setup operation
- Most functions are operated by remote control. Either operation of remote control of front panel is effective when their buttons indicate the same function.

Preparation

- Turn the TV on and select AV as the TV input.
- Switch on the related system power if the player has been connected to amplifier equipment etc.

◆ PLAY

1. Connect AC power cord to AC outlet.
2. Switch on the power, the displayed LOADING indicates the normal power supply. (Note: the disc information appears after several seconds if there has disc after LOADING displayed otherwise appears NO DISC).
3. Press OPEN/CLOSE.
4. Place a disc (8cm or 12cm) onto the tray. (For one-sided disc, position it with printed title side facing up. For two-sided disc, position side to be playback facing down).
5. Press OPEN/CLOSE again to close disc tray.
6. Press PLAY to playback disc. You may operate according to MENU indication after MENU shows on screen then press ENTER button to play back. Some discs may play automatically after loaded.

◆ STOP

Press STOP button to stop playing (TV show "  "). When play back is stopped the unit records the point where STOP was pressed (resume function). Press PLAY again, and play will resume from this point. Press STOP button twice, resume function will be cancelled.

◆ PREV/NEXT

Press PREV button or NEXT button on remote control when playing a disc, a chapter (DVD) or a track (CD) is skipped backward or forward correspondingly each time the button is pressed.

◆ FB/FF

Press FB/FF button on the remote control during playback, the disc will be played in a status of forward or reverse correspondingly. Forward or Reverse speed is relatively slow at first. When press again, the speed becomes faster. The more times that you press the buttons, the faster the Fast forward or reverse speed will be. There are 5 levels of speed available: X2, X4, X8, X16 and X32. To return to normal play, press PLAY button on the player or the remote control.

Note: Some discs including MP3 disc have no such function.

◆ SLOW

Press SLOW button on the remote control during playback and the unit will enter slow forward status. There are 5 speeds available: 1/2, 1/4, 1/8, 1/16 and 1/32. To return to normal play. Press PLAY button on player or remote control again.

Note: Some discs including MP3 disc have no such function.

◆ STEP

Press STEP button during play, the player will enter the still picture mode. If the button is pressed again, the disc is advanced by one frame (step). When the button is kept pressed, consecutive frame advance works. To return to normal play, press PLAY button.

Note: Some discs do not have such function.

◆ PAUSE

Press PAUSE key to stop playing and restore play by pressing PLAY key again.

◆ Number (0-9,10+) button

By pressing the Number (0-9) button, you can access directly to the desired track or chapters while a disc is played. For track or chapter over 10, press 10+ and then 0-9 button.

OPERATION

◆ MUTE

Press MUTE button during play, the player shows  and there is no audio output (silence). Press again to cancel MUTE.

◆ VOL+/VOL-

Press VOL+/VOL- button play may change volume for audio output.

◆ RETURN

For VCD when playing 2.0 PBC is operating. Press RETURN key, it will return to menu mode. When playing DVD/MP3/JPG discs. Press RETURN key, it will return to menu mode.

◆ OSD

Press OSD button during play to show the disc's relevant information on TV screen (such as playing time, chapter number, playback status).

◆ ZOOM

Zoom function can only be operated in JPEG disc and VCD/DVD format disc. By pressing zoom button when playing DVD/VCD discs, there are 3 levels of zoom available (ZOOMx2, ZOOMx4, ZOOMx1). When playing JPEG disc, there are 5 levels of zoom available (150%, 200%, 25%, 50%, 100%).

Note: Zoom function is not working on PAL system DVDs.

MP3 does not have this function

◆ A-B REPEAT

Press A-B button during playback at the point where repeat play is to commence (a) then press again at the point where repeat play is to be concluded (B). Repeat playback between point (A) and point (b) starts. Press A-B button once more where TV screen appears REP OFF to return to normal play.

◆ REPEAT

Press the repeat key to choose repeat play chapter or title (DVD) and play single audio or full disc (VCD, CD, MP3).

Note: Some VCD do not have repeat function with PBC ON state.

◆ ANGLE

Press ANGLE continuously during playback DVD disc to toggle the disc between available angles recorded on the disc if the disc has multi-angle function.

◆ AUDIO

Press AUDIO button during playback to toggle between available audio language recorded on the disc if the disc has this multi-language.

Note: Press AUDIO button could toggle available audio language soundtracks.

◆ PROGRAM

Press PROG button, the program playback screen appears on the TV monitor, 20 tracks or chapters can be programmed. Use  button on the remote control to select your preferred track (CD/VCD) or title and chapter (DVD), then press ENTER button to confirm.

Use CLEAR button to amend false or unsatisfied settings. You can only press the PLAY button on the remote control to start playing after you finish the program setting. Press the PROG button directly to return to normal play mode. In this case, the program is not confirmed.

" : SELECT ▶ : PLAY" shown on screen is only used for indication, no function for cursor.

◆ PBC function (only VCD)

When playing VCD 2.0 press PBC button to display title menu use number key choice and ENTER button to play music.

OPERATION

◆ GO TO

In the play, you press GO TO button on the remote control. You can search the disc based on its title/ chapter/track as shown in the figure. Press GO TO button, a search menu will display. Use ◀ or ▶ button to select the search item/time/title/chapter. The selected will be shown in highlight.

Use number button to select the search item/time/title/chapter, and press ENTER button to play. For example:

- Time search(Press GO TO button twice when playing DVD disc): To search 16 min 50 seconds: input 1,6,5 and 0. To search 1 hr 14 min: input 1,1,4,0,0.
- Title/chapter search:(only DVD)

To search title 1/chapter 2: input 1 in the highlight title column, move the cursor right to the highlight area and input 2.

Note:

- For some DVD discs which cannot be searched, invalid will be appear on TV screen.
- Input the time, title and chapter of the disc to search.
- For VCD in PBC mode is OFF, it can only search for the time.

◆ MENU

Press MENU button on remote control when playing a disc, a list of titles on the disc (depends on discs) will be displayed on TV monitor. Use the direction or number button to select your preferred items then press ENTER button to play as selected.

◆ SUBTITLE

Press SUBTITLE button on remote control during playback. Subtitle: [1] will be displayed on TV monitor that means a kind of language. Press once more, Subtitle: [2] appeared on TV monitor means another kind of language and accordingly subtitles appear that represents how many kind of language being selected. Subtitle: [OFF] appears that toggle subtitle.

Note: This function is valid only for DVD discs with subtitle function. It is invalid for DVD disc with single subtitle function.

◆ CLEAR

This function is only available in program input mode.

◆ N/P

Press N/P button during stop state can switch output signal to NTSC, PAL or AUTO. The default setting is PAL.

SETUP

◆ SETUP

Once the initial settings have been completed, the player can always be operated under the same conditions (especially with DVD discs). The settings will be retained in the memory even after turning off the power until the settings are changed. We set the initial language to English when the player is out of factory. You may change the language into that you preferred.

Operation

1. In stop mode, Press SETUP button to enter setup interface as followed, you can setup Language, Screen, Audio, Custom.

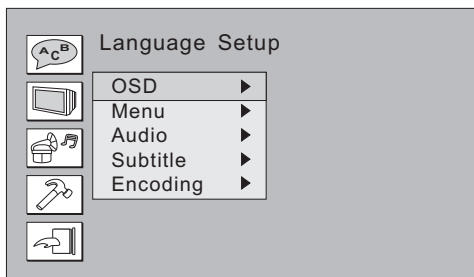

2. Press ◀ and ▶ to choose the desired section and ENTER button to enter submenu or press SETUP to leave the setup screen. Following is the language setup screen for your reference where you can set OSD menu, DVD menu, Audio Language and Subtitle Language.



REFERENCE

◆ Menu, Submenu and Options

MENU	SUBMENU	OPTIONS	DESCRIPTION	
LANGUAGE	OSD	English	English On Screen Display	
		French	French On Screen Display	
		German	German On Screen Display	
		Italian	Italian On Screen Display	
		Spanish	Spanish On Screen Display	
	MENU	MENU	English	English On Screen Display
			French	French On Screen Display
			German	German On Screen Display
			Italian	Italian On Screen Display
			Spanish	Spanish On Screen Display
			others	
	Audio	Audio	English	English On Screen Display
			French	French On Screen Display
			German	German On Screen Display
			Italian	Italian On Screen Display
			Spanish	Spanish On Screen Display
			others	
	Subtitle	Subtitle	English	English On Screen Display
			French	French On Screen Display
			German	German On Screen Display
			Italian	Italian On Screen Display
			Spanish	Spanish On Screen Display
			others	
Encoding	Encoding	Western European		
		Central European		

REFERENCE

MENU	SUBMENU	OPTIONS	DESCRIPTION
SCREEN	TV Type	4:3 PS	Set TV screen at 4:3 Pan Scan
		4:3 LB	Set TV at screen 4:3 Letter Box
		16:9	Set TV at screen 16:9
	Screen Saver	On	Set screen saver to ON or OFF.
		Off	
	TV System	NTSC	Output signal as NTSC
		PAL	Output signal as PAL
		AUTO	Output signal as per default of disc
	Video output	CVBS+S-Video	CVBS+S-Video output
		CVBS+RGB	CVBS+RGB output
	Brightness	Normal	Select normal, bright, or soft to personal preference.
		Bright	
		Soft	
	Contrast	-4	Select various levels to adjust the contrast according to personal preference.
-3			
-2			
-1			
0			
+1			
+2			
+4			
Audio Setup	Downmix	Lo/Ro	Left only/Right only
		Lt/Rt	Left total/Right total
CUSTOM	Parental Ctrl	1	No one under 8 admitted
		2	
		3	
		4	
		5	
		6	
		7	
		8	
	Password	Old	Input number by users to change password, default setting:8888
		New	
		Verify	
	Style	Style 1	Change the background colour of OSD
		Style 2	
		Style 3	
Style 4			
Angle Mark	On	Set the Angle mark to ON or OFF	
	Off		
Default	Read	Return to factory setup	

◆ Handling Precautions

Maintenance

Hold the disc by the edge so the surface will not be soiled with fingerprints. Fingerprints, dirt and scratches can cause skipping and distortion. Do not use record cleaning sprays, benzene, thinner. Static electricity prevention liquids or any other solvent. Be careful not to drop or bend the disc. Do not try to close the disc tray when disc is not installed properly. Be sure to store the disc in its exclusive case when not in use.

Handling

Wipe gently with a soft, damp (water only) cloth. Move the cloth from the centre hole towards the outer edge. Improper disc disc storage: Discs may be damaged if they are stored in the following places: Areas exposed to direct sunlight; Humid or dusty areas; Areas directly exposed to a heat outlet or heating appliance.

◆ Player Maintenance

Be sure to turn the unit off and disconnect the AC power cord before maintaining the unit. Keep the unit clean. If the surfaces are extremely dirty, wipe the unit with a dry soft cloth. Never use alcohol, benzene or other chemicals. Do not use compressed air to remove dust. Ask the technician to maintain the unit when trouble happens.

REFERENCE

◆ Definition of terms

Angle

Recorded onto some DVD discs are scenes which have been simultaneously shot from a number of different angles (i.e. The same scene is shot from the front, left side and right side etc.). With such discs, the ANGLE button can be used to view the scene from different angles.

Chapter Number

These numbers are recorded on DVD discs, A title is subdivided into many sections. Each of them is number and specific parts of video presentations can be searched quickly using these numbers.

DVD disc

This refers to a high-density optical disc on which high quality pictures and sound have been recorded by means of digital signals. Incorporating a new video compression technology (MPEG2) and high-density recording technology, DVD enables full-motion video to be recorded over long periods of time (for instance, a whole movie can be recorded).

Subtitles

These are the printed lines appearing at the bottom of the screen which translate or transcribe the dialogue. They are recorded on DVD discs and up to 32 languages.

PBC

The language indicates on TV screen to imply operation or disc information.

Audio

Language recorded on discs and the maximum languages are up to 8.

Time

This indicates the play time elapsed from the start of a disc or a title. It can be used to find a specific scene quickly (it may not work with some discs).

Title Number

These numbers are recorded on DVD discs. When a disc contains two or more movies, these movies are numbered as title1, title2, etc.

Track Number

These numbers are assigned to the tracks which are recorded on audio CDS. They enable specific tracks to be located quickly. RAW The original DTS, AC-3 signals non-decoded. If users choose RAW as audio setting, they must connect a decoder to decode those original audio signals.

SPECIFICATIONS

Power requirement:	AC 230V~50Hz
Power consumption:	15W
Signal system:	NTSC/PAL/AUTO
Dimension:	260mm x 38mm x 260mm

Disc played:

- | | |
|-----------------------------------|-------------|
| 1. DVD-video disc | 2. CD disc |
| ● 12cm single-sided, single-layer | ● 12cm disc |
| ● 12cm single-sided, double-layer | ● 8cm disc |
| ● 12cm double-sided, double-layer | |
| ● 8cm single-sided, single-layer | |
| ● 8cm single-sided, double-layer | |
| ● 8cm double-sided, double-layer | |

Video output

- Output level: 1±0.2Vp-p (75 ohm)
- Horizontal resolution: >500 lines
- S/N ratio: >60dB

Audio output (Impedance: 10k ohm):

- Output level: 1.8±0.2/-0.8Vrms (1KHz 0dB)
- Harmonic distortion: <0.01% (JIS-A 1KHz, typical)
- Dynamic range: >80 dB (JIS-A 1KHz, typical)
- S/N ratio: 90dB (JIS-A 1KHz, typical)

Weight and dimensions are approximate Specifications are subject to change with or without notice.

TROUBLESHOOTING

Check the chart below for a possible cause of the problem you are experiencing before requesting service for this unit. Some simple checks or minor adjustment on your part may eliminate the problem and restore proper operation. Let the technician maintain the unit. Keep away from static electricity properly before maintenance as loader, key IC are easy to be damaged by it.

Trouble	Suggested solution
No power	Plug the power cord into the power outlet tight to turn on/off once
Cannot read disc	Disc access time within 10-20 seconds is normal The disc is scratched or defiled (change disc) The code of disc is different from the code of unit (change the disc) PAL to NTSC error (Set video output as AUTO)
No picture	If your TV does not have P-Scan function, pressing VIDEO button on the remote may cause this. Press VIDEO button again to rectify.
No sound	Ensure that the equipment is connected properly. Ensure that the TV or audio equipments are not muted. Ensure that the audio output setting is correct.
Picture is distorted during fast forward or reverse	The picture will be somewhat distorted at times. This is normal advance or reverse.
No (4:3)(16:9) picture	Choose the correct setup at TV TYPE item that matches the TV set.
Remote control does not function	Check the batteries being installed with correct polarities. Replace the batteries depleted. Point at remote control sensor and operate it within 5 meters.
Unit's or remote control buttons are not functioning or other abnormal phenomena	Turn the unit off and then back to on. Alternatively, turn off the unit, disconnect the AC power cord for 5 to 10 minutes and then reconnect it.
Audio soundtrack and/or subtitle language not found in settings	If the audio soundtrack and/or subtitle language does not exist in the disc, the language selected at the initial settings will not be seen/heard. Alternative audio soundtrack (or An alternative language is not selected with discs which contain subtitle) language cannot be more than one language selected.
Can not change angle	This function depends on software availability. Even if a disc has a number of angles recorded, these angles may be recorded for specific scenes only.
No playback menu	This function is suitable for VCD with playback control disc.
Miscellaneous	In program playing mode, no repeat, A-B functions are available.

WOOLWORTHS PLC
Woolworth House, 242 Marylebone Road, London NW1 6JL



This quality product is warranted to be free from manufacturer's defects in material and workmanship, provided that the unit is used under the normal operating conditions intended by the manufacturer. Should any problems arise with this product, contact the Woolworths Technical Helpline on 0870 787 9602 and speak directly to one of our technical team.

Environmental Protection

Waste electrical products should not be disposed of with household waste. Please recycle where facilities exist. Check with your Local Authority or retailer for recycling advice.