

Specifications

DVD video player / Outputs / Supplied accessories

DVD video player

Power supply	230-240 V AC, 50 Hz
Power consumption	Operation: 12 W Standby: 3 W
Mass	2.0 kg
External dimensions	Width: 430 mm Height: 59 mm Depth: 206 mm
Signal system	PAL, NTSC
Laser	Semiconductor laser, wavelength 650/780 nm
Frequency response	DVD: 4 Hz - 22 kHz CD: 4 Hz - 20 kHz
Harmonic distortion	0.008 %
Wow and flutter	Below measurable level
Operating conditions	Temperature: 5 °C to 40 °C, Operation status: Horizontal

Outputs

Video output	1.0 V (p-p), 75 Ω, negative sync., pin socket x 1
Component video output	(Y) 1.0 V (p-p), 75 Ω, pin socket x 1 (P _b)/(P _r) 0.7 V (p-p), 75 Ω, negative sync., pin sockets x 2
Audio output (ANALOG)	-12 dBm, 1 k Ω, pin sockets (L, R) x 1
Audio/Video output (SCART)	Audio: -12 dBm, 1 k Ω, Video: 1.0 V (p-p), 75 Ω RGB: 0.7 V (p-p), 75 Ω, SCART socket x 1
Audio output (DIGITAL OPTICAL)	Optical connector x 1

Supplied accessories

Remote control	1
Batteries (R03/AAA)	2

• Designs and specifications are subject to change without notice.

TOSHIBA



J2C01921A

04/03 U

TOSHIBA

DEUTSCH (D)

ENGLISH (E)



DVD-VIDEOSPIELER DVD VIDEO PLAYER SD-190ESE

BEDIENUNGSANLEITUNG OWNER'S MANUAL

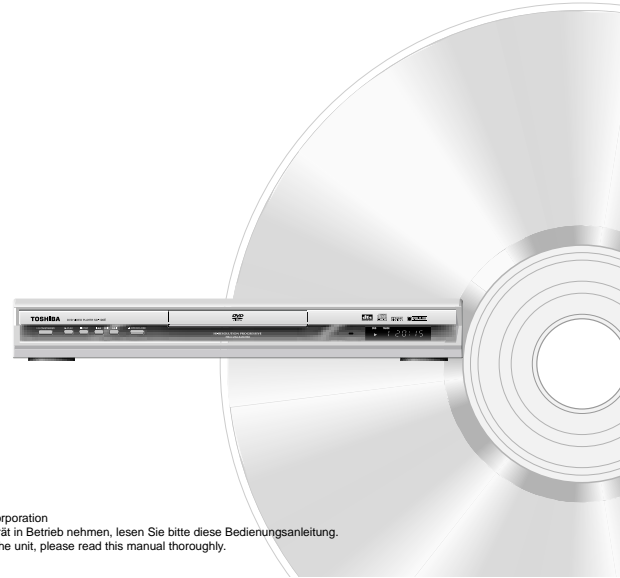

©2004 Toshiba Corporation
Bevor Sie das Gerät in Betrieb nehmen, lesen Sie bitte diese Bedienungsanleitung.
Before operating the unit, please read this manual thoroughly.

SAFETY PRECAUTIONS

WARNING: TO REDUCE THE RISK OF FIRE OR ELECTRIC SHOCK, DO NOT EXPOSE THIS APPLIANCE TO RAIN OR MOISTURE. DANGEROUS HIGH VOLTAGES ARE PRESENT INSIDE THE ENCLOSURE. DO NOT OPEN THE CABINET. REFER SERVICING TO QUALIFIED PERSONNEL ONLY.

CAUTION: This Digital Video Disc Player employs a Laser System. To ensure proper use of this product, please read this owner's manual carefully and retain for future reference. Should the unit require maintenance, contact an authorized service location -see service procedure.

Use of controls or adjustments or performance of procedures other than those specified herein may result in hazardous radiation exposure.

To prevent direct exposure to laser beam, do not try to open the enclosure. Visible and invisible laser radiation when open and interlocks defeated. DO NOT STARE INTO BEAM.



CAUTION: Servicing instructions are for use by qualified service personnel only. To reduce the risk of electric shock do not perform any servicing other than that contained in the operating instructions unless you are qualified to do so.

In the spaces provided below, record the Model and Serial No. located on the rear panel of your DVD video player.

Model No. _____ Serial No. _____
Retain this information for future reference.

Location of the required label

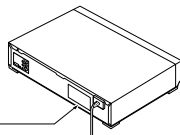

The rating plate and the safety caution are on the rear of the unit.

SOME DOS AND DON'TS ON THE SAFE USE OF EQUIPMENT

This equipment has been designed and manufactured to meet international safety standards but, like any electrical equipment, care must be taken if you are to obtain the best results and safety is to be assured.

DO read the operating instructions before you attempt to use the equipment.
DO ensure that all electrical connections (including the mains plug, extension leads and inter-connections between the pieces of equipment) are properly made and in accordance with the manufacturer's instructions. Switch off and withdraw the mains plug before making or changing connections.
DO consult your dealer if you are ever in doubt about the installation, operation or safety of your equipment.
DO be careful with glass panels or doors on equipment.

DON'T remove any fixed cover as this may expose dangerous voltages.
DON'T obstruct the ventilation openings of the equipment with items such as newspapers, tablecloths, curtains, etc. Overheating will cause damage and shorten the life of the equipment.
DON'T allow electrical equipment to be exposed to dripping or splashing, or objects filled with liquids, such as vases, to be placed on the equipment.
DON'T place hot objects or naked flame sources such as lighted candles or nightlights on, or close to equipment. High temperatures can melt plastic and lead to fires.
DON'T use makeshift stands and NEVER fix legs with wood screws - to ensure complete safety always fit the manufacturer's approved stand or legs with the fixings provided according to the instructions.
DON'T use equipment such as personal stereos or radios so that you are distracted from the requirements of traffic safety. It is illegal to watch television whilst driving.
DON'T listen to headphones at high volume, as such use can permanently damage your hearing.
DON'T leave equipment switched on when it is unattended unless it is specifically stated that it is designed for unattended operation or has a stand-by mode. Switch off using the switch on the equipment and make sure that your family know how to do this. Special arrangements may need to be made for infirm or handicapped people.
DON'T continue to operate the equipment if you are in any doubt about it working normally, or if it is damaged in any way -switch off, withdraw the mains plug and consult your dealer.

ABOVE ALL
—NEVER let anyone especially children push anything into holes, slots or any other opening in the case - this could result in a fatal electrical shock;

—NEVER guess or take chances with electrical equipment of any kind
—it is better to be safe than sorry!

EXCLUSION CLAUSE

Toshiba shall under no circumstances be liable for loss and/or damage to the product caused by:

- fire;
- earthquake;
- accidental damage;
- intentional misuse of the product;
- use of the product in improper conditions;
- loss and/or damage caused to the product whilst in the possession of a third party;
- any damage or loss caused as a result of the owner's failure and/or neglect to follow the instructions set out in the owner's manual;
- any loss or damage caused directly as a result of misuse or malfunction of the product when used simultaneously with associated equipment;

Furthermore, under no circumstances shall Toshiba be liable for any consequential loss and/or damage including but not limited to the following, loss of profit, interruption of business, the loss of recorded data whether caused during normal operation or misuse of the product.

Precautions

Notes on handling

- When shipping the DVD video player, the original shipping carton and packing materials come in handy. For maximum protection, repack the unit as it was originally packed at the factory.
- Do not use volatile liquids, such as insect spray, near the DVD video player. Do not leave rubber or plastic products in contact with the DVD video player for a long time. They will leave marks on the finish.
- The top and rear panels of the DVD video player may become warm after a long period of use. This is not a malfunction.
- When the DVD video player is not in use, be sure to remove the disc and turn off the power.
- If you do not use the DVD video player for a long period, the unit may not function properly in the future. Turn on and use the DVD video player occasionally.

Notes on locating

- Place the DVD video player on a level surface. Do not use it on a shaky or unstable surface such as a wobbling table or inclined stand. The loaded disc may come off the proper position and cause damage to the DVD video player.
- When you place this DVD video player near a TV, radio, or VCR, the playback picture may become poor and the sound may be distorted. In this case, place the DVD video player away from the TV, radio, or VCR.

Notes on cleaning

- Use a soft, dry cloth for cleaning.
- For stubborn dirt, soak the cloth in a weak detergent solution, wring well and wipe. Use a dry cloth to wipe it dry.
- Do not use any type of solvent, such as thinner and benzine, as they may damage the surface of the DVD video player.
- If you use a chemical saturated cloth to clean the unit, follow that product's instructions.

To obtain a clear picture

The DVD video player is a high technology, precision device. If the optical pick-up lens and disc drive parts are dirty or worn down, the picture quality becomes poor. To obtain a clear picture, we recommend regular inspection and maintenance (cleaning or parts replacement) every 1,000 hours of use depending on the operating environment. For details, contact your nearest dealer.

Notes on moisture condensation

Moisture condensation damages the DVD video player. Please read the following carefully.

Moisture condensation occurs, for example, when you pour a cold drink into a glass on a warm day. Drops of water form on the outside of the glass. In the same way, moisture may condense on the optical pick-up lens inside this unit, one of the most crucial internal parts of the DVD video player.

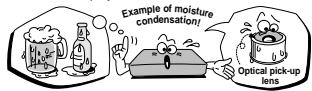

Moisture condensation occurs during the following cases:

- When you bring the DVD video player directly from a cold place to a warm place.
- When you use the DVD video player in a room where you just turned on the heater, or a place where the cold wind from the air conditioner directly hits the unit.
- In summer, when you use the DVD video player in a hot and humid place just after you move the unit from an air conditioned room.
- When you use the DVD video player in a humid place.



Do not use the DVD video player when moisture condensation may occur.

If you use the DVD video player in such a situation, it may damage discs and internal parts. Remove the disc, connect the power cord of the DVD video player to the wall outlet, turn on the DVD video player, and leave it for two or three hours. After two or three hours, the DVD video player will have warmed up and evaporated any moisture. Keep the DVD video player connected to the wall outlet and moisture condensation will seldom occur.

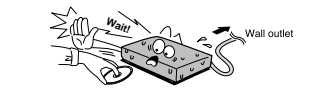

Notes on discs

On handling discs

- Do not touch the playback side of the disc.



- Do not attach paper or tape to discs.



On cleaning discs

- Fingerprints and dust on the disc cause picture and sound deterioration. Wipe the disc from the centre outwards with a soft cloth. Always keep the disc clean.



- If you cannot wipe off the dust with a soft cloth, wipe the disc lightly with a slightly moistened soft cloth and finish with a dry cloth.
- Do not use any type of solvent such as thinner, benzene, commercially available cleaners or antistatic spray for vinyl LPs. It may damage the disc.

On storing discs

- Do not store discs in a place subject to direct sunlight or near heat sources.
- Do not store discs in places subject to moisture and dust such as a bathroom or near a humidifier.
- Store discs vertically in a case. Stacking or placing objects on discs outside of their case may cause warping.

Structure of disc contents

Normally, DVD video discs are divided into titles, and the titles are sub-divided into chapters. Video CDs and Audio CDs are divided into tracks.

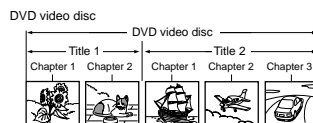

Video CD/Audio CD

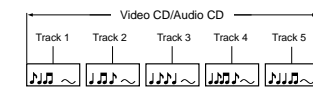

Each title, chapter or track is assigned a number, which is called "title number", "chapter number" or "track number" respectively. There may be discs that do not have these numbers.

Notes on copyright

It is forbidden by law to copy, broadcast, show, broadcast on cable, play in public, and rent copyrighted material without permission.

DVD video discs are copy protected, and any recordings made from these discs will be distorted.

This product incorporates copyright protection technology that is protected by method claims of certain U.S. patents and other intellectual property rights owned by Macrovision Corporation and other rights owners. Use of this copyright protection technology must be authorized by Macrovision Corporation, and is intended for home and other limited viewing uses only unless otherwise authorized by Macrovision Corporation. Reverse engineering or disassembly is prohibited.

Notes on discs

(continued)

About this owner's manual

This owner's manual explains the basic instructions of this DVD video player. Some DVD video discs are produced in a manner that allows specific or limited operation during playback. As such, the DVD video player may not respond to all operating commands. This is not a defect in the DVD video player. Refer to instruction notes of discs.

⚡ may appear on the TV screen during operation. A ⚡ means that the operation is not permitted by the DVD video player or the disc at the moment. For example, sometimes it is unable to stop the playback of copyright message of the disc when the STOP (■) button is pressed. Alternatively, the ⚡ may also indicate that the feature is not available for the disc.

Notes on region numbers

The region number of this DVD video player is 2. If region numbers, which stand for their playable area, are printed on your DVD video disc and you do not find (2) or (0), disc playback will not be allowed by the player. (In this case, the DVD video player will display a message on-screen.)

On Video CDs

This DVD video player supports Video CDs equipped with the PBC (Version 2.0) function. (PBC is the abbreviation of Playback Control.) You can enjoy two playback variations depending on types of discs.

- Video CD not equipped with PBC function (Version 1.1)**
Sound and movie can be played on this DVD video player in the same way as an audio CD.
- Video CD equipped with PBC function (Version 2.0)**
In addition to operation of a Video CD not equipped with the PBC function, you can enjoy playback of interactive software with search function by using the menu displayed on the TV screen (Menu Playback). Some of the functions described in this owner's manual may not work with some discs.

Playable discs

This DVD video player can play the following discs.

	Disc Mark	Contents	Disc Size	Maximum playback time
DVD video discs		Audio + Video (moving pictures)	12 cm	Approx. 4 hours (single sided disc)
			12 cm	Approx. 8 hours (double sided disc)
		8 cm	Approx. 80 minutes (single sided disc)	
Video CDs		Audio + Video (moving pictures)	12 cm	Approx. 74 minutes
			8 cm	Approx. 20 minutes
Audio CDs		Audio	12 cm	Approx. 74 minutes
			8 cm (CD single)	Approx. 20 minutes

- The following discs are also available.
- DVD-R/RW discs of DVD video format
 - CD-R/CD-RW discs of CD-DA, Video CD, SVCD, MP3, WMA or JPEG format
 - Kodak Picture CD and FUJICOLOR CD format
- Some of these discs may be incompatible.
- You cannot play discs other than those listed above.
 - You cannot play discs of DVD-RAM, DVD-ROM, Photo CD, etc., or non-standardized discs even if they may be labeled as above.
 - This DVD video player uses the PAL colour system, and cannot play DVD video discs recorded in any other colour system (SECAM, etc.).
 - NTSC DVD or VCD discs will be playback in black and white if PAL only TV is used. In this case, if your TV is RGB compatible, select "RGB" in the "Output" menu (34). Alternatively, use a multi-system TV.
 - For MP3/WMA/JPEG CD (27).

Table of contents

Introduction

SAFETY PRECAUTIONS	2
SOME DOS AND DON'TS ON THE SAFE USE OF EQUIPMENT	3
Notes on discs	4
Table of contents	5
Identification of controls	7
Front panel	8
Rear panel	8
FL display	9
Remote control	10
Loading batteries	11
Operating with the remote control	11

Connections

Connecting to a TV	12
Connecting to a TV (Using the SCART socket)	12
Connecting to a TV (Using the phono type sockets)	12
Connecting to an audio system and TV equipped with component video inputs	13
Connecting to optional equipment	14
Connecting to an amplifier equipped with a Dolby Digital decoder	14
Connecting to an amplifier equipped with Dolby Surround Pro Logic	14
Connecting to an amplifier equipped with a DTS decoder	14
Connecting to an amplifier equipped with an MPEG2 audio decoder	15
Connecting to an amplifier equipped with a digital audio input	15

Basic playback

Playing a disc	16
Basic playback	16
Playing in fast reverse or fast forward directions	18
Playing frame by frame	18
Playing in slow-motion	18
Locating a chapter or track	18

Advanced playback

Zooming	19
Locating desired scene	19
Marking the scenes	20
Returning to the scenes	20
Repeat playback	21
A-B Repeat playback	21
Program playback	22
Random playback	22
Changing angles	23
Title selection	23
DVD menu	23
Changing soundtrack language	24
Setting surround sound	24
Subtitles	25
Karaoke playback	25
Disc status	26
To turn off the PBC	26
MP3/WMA/JPEG operation	27
MP3/WMA/JPEG CD information	27
MP3/WMA CD playback	28
JPEG CD playback	29
Slide show playback	29

Function setup

Customizing the function settings	30
Setting procedure	30
Setting details	31
Temporary disabling of rating level by DVD disc	35
Language code list	36

Others

Before calling service personnel	37
Specifications	Backcover

Identification of controls

See the page in for details.

Front panel

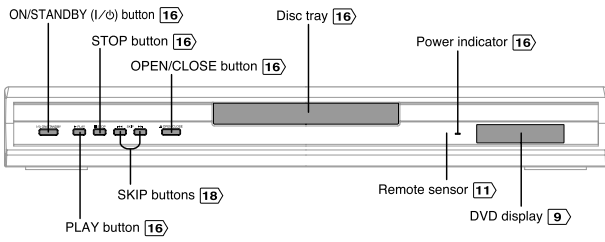

Rear panel

When connecting the optical digital cable, remove the cap and fit the connector into the socket firmly. When not using the socket, keep the cap inserted to protect it from dust intrusion.

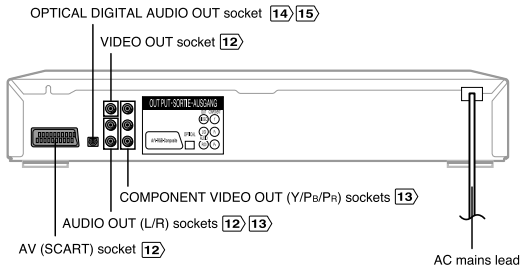

8

FL display

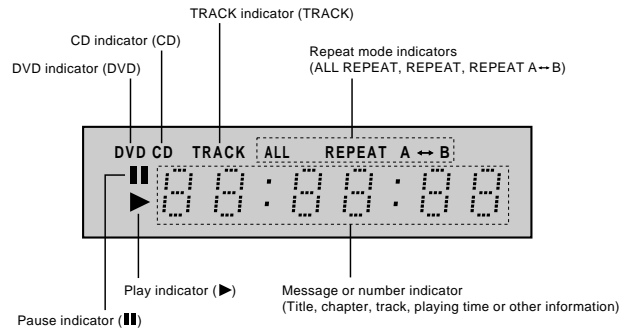

The display may vary depending on the types of discs you play.

DVD video disc	Video CD	Audio CD
<p>• During playback:</p> <p>Example</p> <p>Some discs may not display elapsed time.</p>	<p>• During playback:</p> <p>Example</p> <p>Playing track 1</p> <p>Some discs may not display track numbers or elapsed time.</p>	<p>• During playback:</p> <p>Example</p> <p>Playing track 6</p> <p>Some discs may not display track numbers or elapsed time.</p>

9

Identification of controls (continued)

The instructions in this manual describe the functions on the remote control. See the page in for details.

Remote control

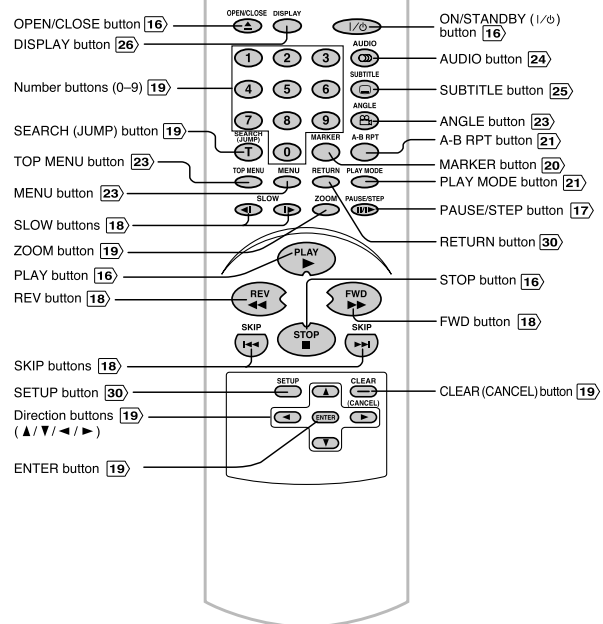

MENU button

Use the MENU button to display the menu included on many DVD video discs. To operate a menu, follow the instructions in "DVD menu." **23**

10

Loading batteries

- Slide the battery compartment cover in the direction of the arrow.

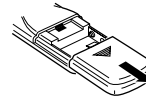

- Install two "R03/AAA" batteries (supplied), paying attention to the polarity diagram in the battery compartment.

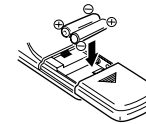

- Replace the compartment cover.

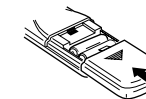

Notes on batteries

Improper use of batteries may cause battery leakage and corrosion. To operate the remote control correctly, follow the instructions below.

- Do not insert batteries into the remote control in the wrong direction.
- Do not charge, heat, open, or short-circuit the batteries. Do not throw batteries into a fire.
- Do not leave dead or exhausted batteries in the remote control.
- Do not use different types of batteries together, or mix old and new batteries.
- If you do not use the remote control for a long period of time, remove the batteries to avoid possible damage from battery corrosion.
- If the remote control does not function correctly or if the operating range becomes reduced, replace all batteries with new ones.
- If battery leakage occurs, wipe the battery liquid from the battery compartment, then insert new batteries.

Operating with the remote control

Point the remote control at the remote sensor and press the buttons.

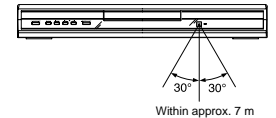

Distance: Approx. 7 m from the front of the remote sensor
Angle: Approx. 30° in each direction of the front of the remote sensor

* Do not expose the remote sensor of the DVD video player to a strong light source such as direct sunlight or other illumination. If you do so, you may not be able to operate the DVD video player via the remote control.

Notes on the remote control

- Direct the remote control at the remote sensor of the DVD video player.
- Do not drop or give the remote control a shock.
- Do not leave the remote control near an extremely hot or humid place.
- Do not spill water or put anything wet on the remote control.
- Do not disassemble the remote control.
- When using the remote control, press the button at intervals of approx. 1 second to ensure the correct mode of operation.

11

Connecting to a TV

Connect the DVD video player to your TV.
For details of output sound, see 34.

Connect the DVD video player directly to your TV. If you connect the DVD video player to a VCR, TV/VCR combination or video selector, the playback picture may be distorted as DVD video discs are copy protected.

Connecting to a TV (Using the SCART socket)

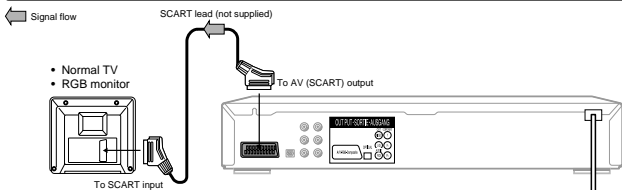

• Make the following setting.

TV	On-screen display	See "Output" selection 34.
Normal TV / RGB monitor		"Output"
		"RGB"

Connecting to a TV (Using the phono type sockets)

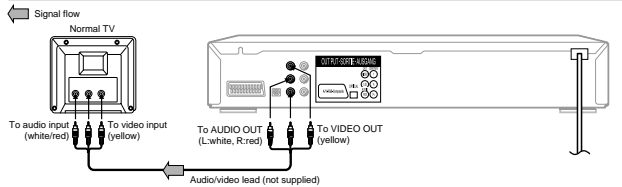

• Make the following setting.

TV	On-screen display	See "Output" selection 34.
Normal TV		"Output"
		No need to set.

Notes:

- In connecting to a TV using the SCART or video socket, do not select "Progressive" in "Output" menu. If you do it, the SCART or video output does not feed the correct signals and you can not see any picture 34.
- Refer to the owner's manual of the connected equipment as well.
- When you connect the DVD video player to other equipment, be sure to turn off the power and unplug all of the equipment from the wall outlet before making any connections.
- If you place the DVD video player near a tuner or radio, the radio broadcast sound might be distorted. In this case, place the DVD video player away from the tuner and radio.
- The output sound of the DVD video player has a wide dynamic range. Be sure to adjust the receiver's volume to a moderate listening level. Otherwise, the speakers may be damaged by a sudden high volume sound.
- Turn off the amplifier before you connect or disconnect the DVD video player's mains lead. If you leave the amplifier power on, the speakers may be damaged.
- If your television set has one audio input, connect the DVD video player to a Y lead adapter (not supplied) and then connect to your TV.

Component video outputs/inputs

PROGRESSIVE outputs/inputs

Some TVs or monitors are equipped with component video inputs that are capable of reproducing a progressively scanned video signal. Connecting to these inputs allows you to view the highest quality pictures with less flicker.

INTERLACED outputs/inputs

Some TVs or monitors are equipped with component video inputs. Connecting to these inputs allows you to enjoy the highest quality DVD picture playback.

Connecting to an audio system and TV equipped with component video inputs

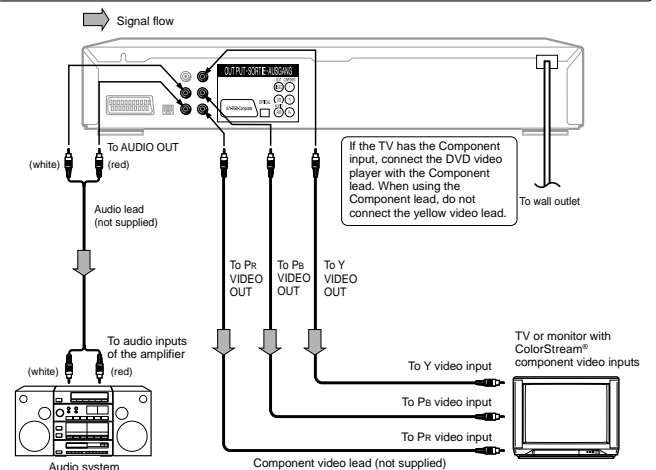

• Make the following setting.

TV	On-screen display	See "Output" selection 34.
Interlaced inputs		"Component"
Progressive inputs		"Progressive"

Notes:

- Actual labels for component video inputs may vary depending on the TV manufacturer. (ex. Y, R-Y, B-Y or Y, CB, CR)
- In some TVs or monitors, the colour levels of the playback picture may be reduced slightly or the tint may change. In such a case, adjust the TV or monitor for optimum performance.
- In connecting to a TV that are not capable of reproducing a progressively scanned video signal using the component sockets, do not select "Progressive" in "Output" menu. If you do it, the component video outputs does not feed the correct signals and you can not see any picture 34.
- Refer to the owner's manual of the connected equipment as well.
- When you connect the DVD video player to other equipment, be sure to turn off the power and unplug all of the equipment from the wall outlet before making any connections.
- If you place the DVD video player near a tuner or radio, the radio broadcast sound might be distorted. In this case, place the DVD video player away from the tuner and radio.
- The output sound of the DVD video player has a wide dynamic range. Be sure to adjust the receiver's volume to a moderate listening level. Otherwise, the speakers may be damaged by a sudden high volume sound.
- Turn off the amplifier before you connect or disconnect the DVD video player's mains lead. If you leave the amplifier power on, the speakers may be damaged.

Connecting to optional equipment

You can enjoy high quality dynamic sounds by connection the DVD video player to optional audio equipment.

• This section uses the following reference mark.

- : Front speaker
- : Center speaker
- : Rear speaker
- : Sub woofer
- : Signal flow

For connection to your TV, see "Connecting to a TV" 12 13.

Connecting to an amplifier equipped with a Dolby Digital decoder

Dolby Digital

Dolby Digital is the surround sound technology used in theaters showing the latest movies, and is now available to reproduce this realistic effect in the home. You can enjoy motion picture and live concert DVD video discs with this dynamic realistic sound by connecting the DVD video player to a 6 channel amplifier equipped with a Dolby Digital decoder or Dolby Digital processor. If you have a Dolby Surround Pro Logic decoder, you will obtain the full benefit of Pro Logic from the same DVD movies that provide full 5.1 channel Dolby Digital soundtracks, as well as from titles with the Dolby Surround mark.

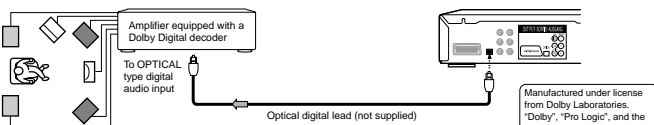

Connecting to an amplifier equipped with Dolby Surround Pro Logic

Dolby Surround Pro Logic

You can enjoy the dynamic realistic sound of Dolby Surround Pro Logic by connecting an amplifier and speaker system (right and left front speakers, a center speaker, and one or two rear speakers).

- With an amplifier equipped with Dolby Digital
Connect the equipment the same way as described in "Connecting to an amplifier equipped with a Dolby Digital decoder." Refer to that amplifier's owner's manual and set the amplifier so you can enjoy Dolby Surround Pro Logic sound.
- With an amplifier not equipped with Dolby Digital
Connect the equipment as follows.
• This connection is only suitable for Video CDs and Audio CDs.

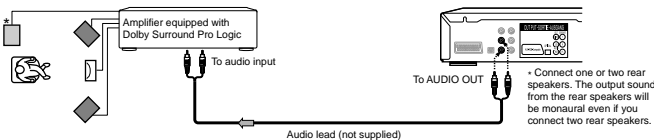

Connecting to an amplifier equipped with a DTS decoder

Digital Theater Systems (DTS)

DTS is a high quality surround technology used in theaters and now available for home use, on DVD video discs or audio CDs. If you have a DTS decoder or processor, you can obtain the full benefit of 5.1 channel DTS encoded sound tracks on DVD video discs or audio CDs.

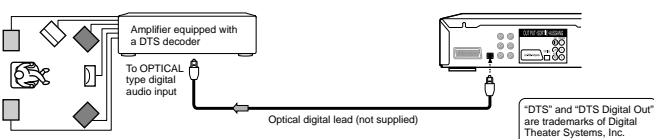

Warning

When playing DTS-encoded discs (DVD video discs and audio CDs), excessive noise may be output from the analog stereo sockets. To avoid possible damage to the audio system, you should take proper precautions when the AUDIO OUT (L/R) sockets of the DVD video player are connected to an amplification system. (Do not leave the ANALOG AUDIO OUT (L/R) leads dangling.) To enjoy DTS Digital Surround™ playback, an external 5.1 channel DTS Digital Surround™ decoder system must be connected to the OPTICAL DIGITAL AUDIO OUT socket or of the DVD video player.

Connecting to an amplifier equipped with an MPEG2 audio decoder

MPEG2 sound

You can enjoy motion picture and live concert DVD video discs with dynamic realistic sound by connecting an amplifier equipped with an MPEG2 audio decoder or MPEG2 audio processor.

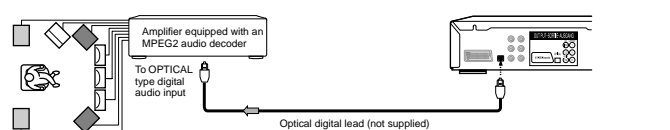

Connecting to an amplifier equipped with a digital audio input

2 channel digital stereo

You can enjoy the dynamic sound of 2 channel digital stereo by connecting an amplifier equipped with a digital audio input and speaker system (right and left front speakers).

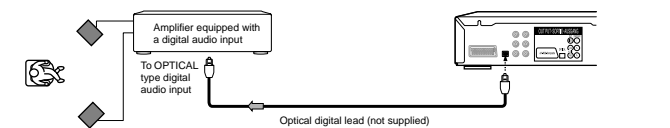

Notes:

- DO NOT connect the OPTICAL DIGITAL AUDIO OUT socket of the DVD video player to the AC-3 RF input of a Dolby Digital Receiver. This input on your A/V Receiver is reserved for Laserdisc use only and is incompatible with the OPTICAL DIGITAL AUDIO OUT socket of the DVD video player.
- Connect the OPTICAL DIGITAL AUDIO OUT socket of the DVD video player to the "OPTICAL" of a Receiver or Processor.
- Refer to the owner's manual of the connected equipment as well.
- When you connect the DVD video player to other equipment, be sure to turn off the power and unplug all of the equipment from the wall outlet before making any connections.
- The output sound of the DVD video player has a wide dynamic range. Be sure to adjust the receiver's volume to a moderate listening level. Otherwise, the speakers may be damaged by a sudden high volume sound.
- Turn off the amplifier before you connect or disconnect the DVD video player's mains lead. If you leave the amplifier power on, the speakers may be damaged.

Playing a disc

This section shows you the basics on how to play a disc.

CAUTION
Keep your fingers well clear of the disc tray as it is closing. Neglecting to do so may cause serious personal injury.

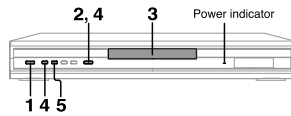

Basic playback

Preparations:

- When you want to view a disc, turn on the TV and select the corresponding video input connected to the DVD. This may include video or component video inputs which are exclusive to DVD playback.
- When you want to enjoy the sound of discs from the audio system, turn on the audio system and select the input connected to the DVD.

- Press ON/STANDBY (I/O).**
The DVD turns on and the Power indicator lights. "Reading" display will change to "No Disc". (If DVD disc has already loaded, playback will start automatically.)
- Press OPEN/CLOSE.**
The disc tray opens.
- Place the disc on the disc tray.**
With the playback side down

- There are two different disc sizes. Place the disc in the correct guide on the disc tray. If the disc is out of the guide, it may damage the disc and cause the DVD to malfunction.
- Do not place a disc which is unplayable in this DVD.

- Press OPEN/CLOSE or PLAY on the unit.**
The disc tray closes automatically. On the TV-screen, "▲" changes to "Reading" and then playback commences.
- Press STOP to end playback.**
The unit records the stopped point, depending on the disc. "■" appears on the screen. Press PLAY to resume playback (from the scene point).

To start playback in the stop mode

Press **PLAY**.

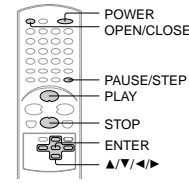

To obtain a higher quality picture
Occasionally, some picture noise not usually visible during a normal broadcast may appear on the TV screen while playing a DVD video disc because the high resolution pictures on these discs include a lot of information. While the amount of noise depends on the TV you use with this unit, you should generally reduce the sharpness adjustment on your TV when viewing DVD video discs.

About
The icons on the heading bar show the playable discs for the function described under that heading.
 ○ : You can use this function with DVD video discs.
 ○ : You can use this function with Video CDs.
 ○ : You can use this function with Audio CDs and CD-R/RW CDs.

To pause playback (still mode)

Press **PAUSE/STEP** during playback.
To resume normal playback, press **PLAY**.



To remove the disc

Press **OPEN/CLOSE**.
Remove the disc after the disc tray opens completely.

Screen saver function

The screen saver operates when you leave the unit in DVD stop mode for approx. five minutes. The screen will repeatedly get dark gradually and back to normal.

Notes:

- If a non-compatible disc is loaded, "Incorrect Disc", "Region Code Error" or "Parental Error" will appear on the TV screen according to the type of loaded disc. In this case, check your disc again (see pages 6 and 34).
- Some discs may take a minute or so to start playback.
- When you set a single-faced disc label downwards (ie. the wrong way up) and press the OPEN/CLOSE button or the PLAY button on the unit, "Reading" will appear on the display for 30 seconds and then "Incorrect Disc" will continue to be displayed.
- Some discs may not work the resuming facility.
- Resuming cannot function when you play a PBC-featured Video CD while the PBC is on. To turn off the PBC, see page 26.
- Some playback operations of DVDs may be intentionally fixed by software producers. Since this unit plays DVDs according to the disc contents the software producers designed, some playback features may not be available. Also refer to the instructions supplied with the DVDs.
- Do not move the unit during playback. Doing so may damage the disc.
- Use the OPEN/CLOSE button to open and close the disc tray. Do not push the disc tray while it is moving. Doing so may cause the unit to malfunction.
- Do not push up on the disc tray or put any objects other than discs on the disc tray. Doing so may cause the unit to malfunction.
- In many instances, a menu screen will appear after playback of a movie is completed. Prolonged display of an on-screen menu may damage your television set, permanently etching that image onto its screen. To avoid this, be sure to press the ON/STANDBY (I/O) button on your remote control once the movie is completed.
- There may be a slight delay between you pressing the button and the function activating.

Playing a disc (continued)

You can play discs at various speeds.

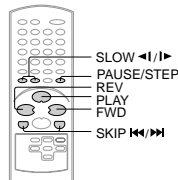

Playing in fast reverse or fast forward directions

Press **REV** or **FWD** during playback.

REV: Fast reverse playback
FWD: Fast forward playback

Each time you press the REV or FWD button, the playback speed changes.

To resume normal playback

Press **PLAY**.

Notes:

- The DVD video player mutes sound and subtitles during reverse and forward scan of DVD/VIDEO discs. However, this unit plays sound during fast forward or fast reverse play of audio CDs.
- The playback speed may differ depending on the disc.

Playing frame by frame

Press **PAUSE/STEP** during still playback.

Each time you press the PAUSE/STEP button, the picture advances one frame.

To resume normal playback

Press **PLAY**.

Note:
The sound is muted during frame by frame playback.

Playing in slow-motion

Press **SLOW** Forward or **SLOW** Reverse during playback.

Each time you press the button, the slow-motion speed changes.

To resume normal playback

Press **PLAY**.

Notes:

- The sound is muted during slow-motion playback.
- The Video CD can not play Reverse Slow.

Locating a chapter or track

Press **SKIP** repeatedly to display the chapter or track number you want.

Playback starts from the selected chapter or track.

SKIP To locate succeeding chapters or tracks.

SKIP Playback starts from the beginning of the current chapter or track. When you press twice in quick succession, playback starts from the beginning of the preceding chapter or track.

- Notes:**
- A "Prohibition" symbol may appear at the upper left of the screen. This symbol means either the feature you tried is not available on the disc, or the DVD can not access the feature at this time. This does not indicate a problem with the DVD.
 - The unit is capable of holding a still video image or On screen display image on your television screen indefinitely. If you leave the still video image or On screen display image displayed on your TV for an extended period of time, you risk permanent damage to your television screen. Projection televisions are very susceptible.

Zooming/Locating desired scene

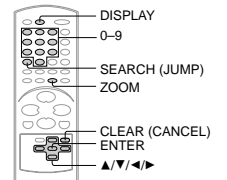

Zooming

This unit will allow you to zoom in on the frame image. You can then make selections by switching the position of the frame.

- Press ZOOM during playback.**
The centre part of the image will be zoomed in. Each press of ZOOM will change the ZOOM as follows.

DVD	Q 1 (x 1.3)	Q 2 (x 1.5)	Q 3 (x 2.0)
Video CD / JPEG CD	Q 1 (x 1.3)	Q 2 (x 1.5)	Q 3 (x 2.0)

- Press PAUSE/STEP to view a different part of the frame.**
You may move the frame from the centre position to UP, DOWN, LEFT or RIGHT direction.

- In the zoom mode press ZOOM repeatedly to return to a 1:1 view (Q Off).**

- Notes:**
- You can select the Pause, Slow or Search playback in the zoom mode.
 - Some discs may not respond to zoom feature.

Locating desired scene

Use the title, chapter and time recorded on the disc to locate the desired point to play back. To check the title, chapter and time, press **DISPLAY**.

- Press SEARCH (JUMP) during playback or stop mode.**

Jump Time : -----
Title : -----
Chapter : -----
▲▼/Enter/0-9/Cancel/Jump

- Press ▲ or ▼ to select the "Time", "Title" or "Chapter".**

Jump Time : -----
Title : -----
Chapter : -----
▲▼/Enter/0-9/Cancel/Jump

- Press Number buttons (0-9) to change the number.**

Jump Time : -----
Title : -----
Chapter : 12-----
▲▼/Enter/0-9/Cancel/Jump

- If you input a wrong number, press **CLEAR (CANCEL)**.
- Refer to the package supplied with the disc to check the numbers.

- Press ENTER. Playback starts.**

- When you change the title, playback starts from Chapter 1 of the selected title.
- Some discs may not work in the above operation.

- Note:**
In case of the Video CD playback with PBC, the Search (Jump) function does not work. To turn off PBC, see page 26.

Marking desired scenes

The unit stores the points that you want to watch again up to 3 points. You can resume playback from each scene.

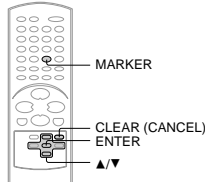

Marking the scenes

1 Press MARKER during playback.



2 Select the blank Marker using ▲ or ▼. Then press ENTER at the desired scene.

• Repeat this procedure to set the other 2 scenes.



3 Press MARKER to remove this display.



Notes:

- Some discs may not work with the marking operation.
- The marking is cancelled when you open the disc tray or turn the power off.
- Some subtitles recorded around the marker may fail to appear.

Returning to the scenes

1 Press MARKER during playback or stop mode.



2 Press ▲ or ▼ to select the Marker 1-3.



3 Press ENTER.

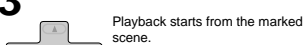

■ To cancel the Marker

Follow the above steps 1-2, then press CLEAR (CANCEL).

Repeat playback/A-B Repeat playback

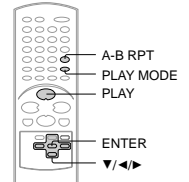

Repeat playback

1 Press PLAY MODE during playback or stop mode.



2 [DVD] Press ◀▶ or ENTER once or twice to select "Chapter" or "Title".

The unit automatically starts repeat playback after finishing the current title or chapter.



[Audio CD, Video CD, MP3/WMA CD] Press ▼ to select "Repeat". Press ◀▶ or ENTER once or twice to select "Track" or "All".

The unit automatically starts repeat playback after finishing the current track.



- If you set the repeat mode during stop mode, press PLAY to start Repeat playback.

3 Press PLAY MODE again to make the screen disappear.

■ To resume normal playback

Select Repeat : "Off" in step 2.

Notes:

- Some discs may not work with the repeat operation.
- In case of Video CD with PBC, repeat functions are prohibited during playback.

A-B Repeat playback

A-B repeat playback allows you to repeat material between two selected points.

1 Press A-B RPT during playback.

The start point is selected.



2 Press A-B RPT again.

The end point is selected. Playback starts at the point that you selected. Playback stops at the end point, returns to Point A automatically, then starts again.



■ To resume normal playback

Press A-B RPT again.

A-B RPT "Off" appears on the screen.

Notes:

- In A-B Repeat mode, subtitles near the A or B locations may not be displayed.
- You can not set the A-B Repeat for the scenes that include multiple angles.
- A-B Repeat playback does not work when Repeat playback is activated.
- You may not be able to set A-B Repeat, during certain scenes of the DVD.
- A-B Repeat does not work with an interactive DVD, MP3/WMA/JPEG CD.
- A-B Repeat is prohibited when PBC is on.

Program playback/Random playback

You can arrange the playback order of tracks or files on the disc. And also the unit selects tracks or files at random and playback them. These feature works for Audio CD, Video CD and MP3/WMA/JPEG CD.

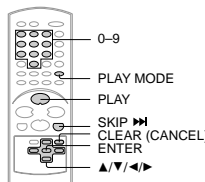

Program playback

1 Press PLAY MODE during stop mode.



2 Press ▲/▼ to select Play Mode, then press ◀▶ or ENTER to select "Program".



3 Press ▲/▼ or ◀▶ to select the programming position. Use Numbered buttons (0-9) to input the track or file numbers.

• To program others, repeat step 3. • If you input a wrong number, press CLEAR (CANCEL).

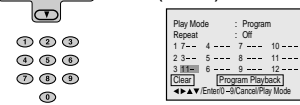

4 Press ▲/▼/◀▶ to select "Program Playback" and press ENTER.

The programs you selected will start to playback in the order.

- In case of JPEG file, press SKIP ▶▶ to continue the program playback.
- To resume normal playback, select Play Mode: "Off" in step 2.

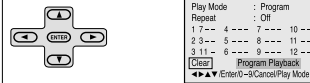

■ To change the program

1. In the program mode, press ▲/▼/◀▶ to select the track number.

2. Press Number buttons (0-9) to select the track number to be replaced.

■ To clear the program one by one In the program mode, press ▲/▼/◀▶ to select the track number. Then press CLEAR.

■ To clear all the programs In the program mode, press ▲/▼/◀▶ to select "Clear". Then press ENTER.

- In playing back the Video CD with PBC, you can not set Program playback.
- The program is cancelled when you open the disc tray or turn the power off.

Random playback

1 Press PLAY MODE during playback or stop mode.



2 Press ▲/▼ to select Play Mode, then press ◀▶ or ENTER to select "Random".

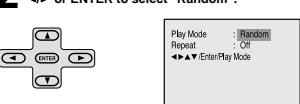

3 Press PLAY.

The Random Playback will start.

- If you set "Random" during playback mode, Random playback will begin after the track that is currently being played has ended.
- To resume normal playback, select Play Mode: "Off" in step 2.

Notes:

In playing back the Video CD with PBC, you can not set Random playback.

Changing angles/Title selection/DVD menu

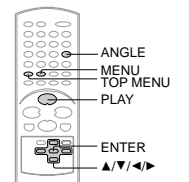

Changing angles

When playing back a disc recorded with multi-angle facility, you can change the angle that you are viewing the scene from.

1 Press ANGLE during playback.

The current angle will appear.

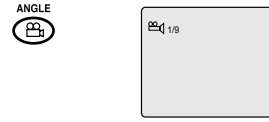

2 Press ANGLE repeatedly until the desired angle is selected.



Note: Depending on the DVD, you may not be able to change the angles even if multi-angles are recorded on the DVD.

Title selection

Two or more titles are recorded on some discs. If the title menu is recorded on the disc, you can select the desired title.

1 Press TOP MENU during playback.

Title menu appears on the screen.

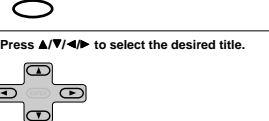

3 Press ENTER or PLAY.

The playback of the selected title will start.



Note: Depending on the DVD, you may not be able to select the title. Depending on the DVD, a "title menu" may simply be called a "menu" or "title" in the instructions supplied with the disc.

DVD menu

Some DVDs allow you to select the disc contents using the menu. When you play back these DVDs, you can select the subtitle language and sound-track language, etc. using the menu.

1 Press MENU during playback.

The DVD menu appears on the screen. • Press MENU again to resume playback at the scene when you pressed MENU.

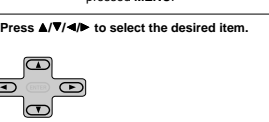

3 Press ENTER.

The menu continues to another screen. Repeat steps 2 and 3 to set the item completely.



Note: Depending on the DVD, you may not be able to resume playback from the scene point when you pressed the MENU button.

Changing soundtrack language/ Setting surround sound

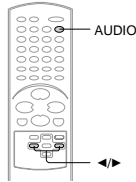

Changing soundtrack language

You can select the language when you play a multilingual disc.

1 Press AUDIO during playback.

AUDIO The current soundtrack language will appear.

2 Press AUDIO repeatedly until the desired language is selected.

The on screen display will disappear after a few seconds.

In case of Video CD playback

Audio type changes as follows each time you press **AUDIO**.



Notes:

- If the desired language is not heard after pressing the button several times, the language is not recorded on the disc.
- Changing soundtrack language is cancelled when you open the disc tray. The initial default language or available language will be heard if the disc is played back again.

Setting surround sound

This DVD video player equipped with a "SPATIALIZER VIRTUAL SURROUND". It can produce the effect of being in a cinema or a concert hall.

1 During disc playback press AUDIO.

AUDIO

2 Press ◀ or ▶ to select "On".

The on screen display will disappear after a few seconds.

To cancel Surround mode:

Follow the left steps 1-2, then press ◀ or ▶ to select the "Off" position.

Note:

The "SPATIALIZER VIRTUAL SURROUND" is effective only for the sound of disc.

Spatializer® 3-Dimensional Sound Processing provided by Desper Products, Inc. Certain audio features of this product manufactured under a license from Desper Products, Inc., Spatializer® and the circle-in-square device are trademarks owned by Desper Products, Inc.

Subtitles/Karaoke playback

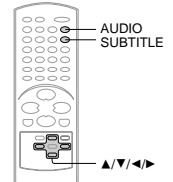

Subtitles

When playing back a disc recorded with subtitles, you can select the subtitle language or turn the subtitle off.

1 Press SUBTITLE repeatedly during playback until your desired language appears.

2 To turn off the subtitle, press SUBTITLE until "Off" appears.

The on screen display will disappear after a few seconds.

Karaoke playback

You can turn the vocal on or off recorded on the DVD KARAOKE.

1 During DVD KARAOKE disc playback, press AUDIO.

2 Press ▲ or ▼ until the KARAOKE symbol (K) appears.

If you play non-Karaoke disc, the KARAOKE symbol (K) does not appear.

3 Press ◀ or ▶ to select "On" or "Off".

On : The primary vocal is output when it is recorded on the disc.
Off : The primary vocal is not output.

The on screen display will disappear after a few seconds.

Notes:

- The vocal output feature is used during playback of Dolby Digital (multi-channel) recorded DVD KARAOKE discs. This feature allows you to turn off vocal audio tracks, or restore them for background accompaniment.
- When playing Karaoke, connect appropriate audio equipment such as an amplifier to the DVD video player.

Disc status/To turn off the PBC

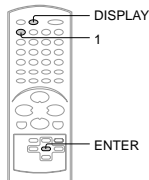

Disc status

With each press of **DISPLAY**, the status of the disc will appear on the screen and change as follows.

[DVD]

To make status display disappear, press **DISPLAY** again.

[Video CD]

To make status display disappear, press **DISPLAY** again.

[Audio CD]

When you playback the CD disc, the status display will appear on the screen and continue displaying.

To turn off the PBC

Press number button 1 in the stop mode, then press **ENTER**.



MP3/WMA/JPEG operation

This player can play back the MP3/WMA/JPEG-data which has been recorded on CD-R or CD-RW. To produce the MP3/WMA/JPEG-data, you need a Windows-PC with CD-RW drive and a MP3/WMA/JPEG-encoding Software (not supplied). The Apple-HFS-System can not be played.

MP3/WMA/JPEG CD information

Limitations on MP3/WMA/JPEG CD playback

- MP3/WMA/JPEG CD is the disc that is standardized by ISO9660, its file name must include 3-digits extension letters, "mp3", "wma", "jpg".
- MP3/WMA/JPEG CD must be correspond to the ISO standardized files.
- This unit can read 200 files per disc. If one directory has more than 200 files, it reads up to 200 files, the remaining files will be omitted.
- The unit is able to recognize up to a maximum of 50 directories per disc.
- MP3/WMA/JPEG CDs cannot be used for the purpose of recording.
- If the CD has both audio tracks and MP3/WMA/JPEG files, only audio tracks are played.
- It may take more than one minute for this unit to read MP3/WMA/JPEG files depending on its structure.
- Music recorded by "Joliet Recording Specification" can be played back, the file name is displayed (within 16 letters) on the screen. Long file names will be condensed.
- The music files recorded by "Hierarchical File System" (HFS) cannot be played.

Limitations on display

- The maximum number for display is 16 letters.
- Available letters for display are the following: capital or small alphabets of A through Z, numbers of 0 through 9, and _ (under score).
- Other letters than those above are replaced in hyphen.

Notes on MP3/WMA/JPEG files

- To play back MP3/WMA/JPEG CD in the recorded order.
- Use MP3/WMA/JPEG software that records data alphabetically or numerically.
- Name each file including two-digit or three-digit number (ex. "01" "02" or "001" "002").
- Refrain from making too many sub-folders.

CAUTION:

- Some MP3/WMA/JPEG CDs can not be played back depending on the recording conditions.
- The CD-R/RW that has no music data or non MP3/WMA/JPEG files can not be played back.

Standard, sampling frequency, and the bit rate:

- MP3 CD**
- MPEG-1 Audio
 - 32kHz, 44.1kHz, 48kHz
 - 32kbps ~ 320kbps (constant bit rate or variable bit rate)
 - The recommend recording setting for a high-quality sound is 44.1kHz of sampling frequency and 128kbps of constant bit rate.
- WMA CD**
- WMA version 7, and 8
 - 32kHz, 48kbps
 - 44.1kHz, 48kbps ~ 192kbps
 - 48kHz, 128kbps ~ 192kbps
 - The file recorded by mono, 48kHz, 48 kbps is not available to this unit.

MP3/WMA/JPEG operation (continued)

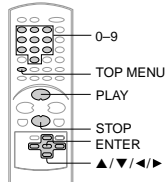

MP3/WMA CD playback

1 Place a disc on which MP3 or WMA files have been recorded onto the disc tray.

2 A file menu screen will appear on the screen. Press **◀▶** or **ENTER** to select folder.

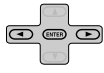

3 Press **▲▼/◀▶** or Number buttons (0-9) to select the desired file.



• In case the folder includes more than 15 files, press **◀▶** to display next file list.

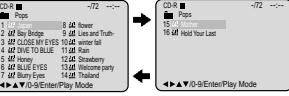

• When **PLAY** has been pressed after displaying the file menu, or when the disc tray has been closed using **PLAY**, playback begins automatically starting from the first file. In this case, if the first file is an MP3/WMA file, only MP3/WMA files are played back in order. If the first file is a JPEG file, the first JPEG file is played back.

4 Press **ENTER**. The selected file starts playing back.



5 Press **STOP** to end playback.



- The unit records the stopped point. "II" appears on the screen. Press **PLAY** to resume playback from the scene point.
- If you press **STOP** again or unload the disc, the unit will clear the stopped point.

About file menu

Operation	Elapsed time
Media type	File number
Folder	1:54 02:55
1 Pops	8 04 Pops
2 02 Say Stop	9 04 Love and Truth
3 04 CLOSE MY EYES 10:00 Pops	
4 02 DIVE TO BLUE 11:00 Pops	
5 04 Home 12:00 Pops	
6 02 BLUE EYES 13:00 Pops	
7 02 Berry Eyes 14:00 Pops	

: Indicates MP3-file
 : Indicates WMA-file
 : Indicates JPEG-file

- Notes:**
- The picture menu is displayed when the FUJICOLOR CD or the Kodak Picture CD are played. To display the file menu, press **TOP MENU**.
 - In the case of a CD containing a mixture of MP3, WMA and JPEG files, the files are played back by selecting them from the file menu.
 - MP3 or WMA file on the Kodak Picture CD is not recognized on this unit.

- Notes:**
- During MP3/WMA/JPEG-Playback, you can not use SEARCH, A-B Repeat functions.
 - You can use Repeat (Track or All), Random Functions and Program playback for MP3/WMA/JPEG CD Playback (see pages 21 and 22).
 - In the case of a CD containing a mixture of MP3, WMA and JPEG files, the files are played back by selecting them from the file menu.

Microsoft, Windows Media, and Windows Logo are trademarks or registered trademarks of Microsoft Corporation in both the United States and other countries.

JPEG CD playback

1 Place a disc on which JPEG files have been recorded onto the tray.

2 A file menu screen will appear on the screen. Press **◀▶** to select folder.



3 Press **▲▼/◀▶** or Number buttons (0-9) to select the desired file.

To display a picture menu, press **MENU**. (To return to a file menu, press **TOP MENU**.) Press **◀▶** or **▲▼** to select the desired file.

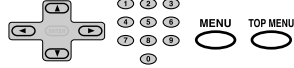

- To display next list, press **SKIP** .
- When **PLAY** has been pressed after displaying the file menu, or when the disc tray has been closed after pressing **PLAY**, playback begins automatically starting from the first file. In this case, if the first file is a JPEG file, the first JPEG file is played back. If the first file is an MP3/WMA file, only MP3/WMA files are played back in order.

4 Press **ENTER**. The selected picture appears on the screen.



Rotating an image
 You can rotate an image by 90 degrees by pressing **ANGLE** during playback of the image. , or appears briefly on the screen.

5 Press **STOP** to end playback. The file menu appears on the screen.

If you want to watch the other file, repeat steps 3 - 4.

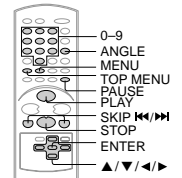

Slide show playback

The slide show enables you to view pictures (files) one after another automatically.

Preparation:
 • Set "JPEG Interval" setting to "5 Seconds", "10 Seconds" or "15 Seconds" (33).

1 Select your desired starting file for the slide show in the step 3 as left.

2 Press **ENTER** to start slide show from the selected file.



• If you press **PAUSE** during the slide show, the slide show stops temporarily. "II" appears briefly on the picture.

If the picture appears upside down or sideways, press **ANGLE** repeatedly until it's right side up. , or appears briefly on the screen.

Press **PLAY** or **SKIP** again to resume the slide show.

• When the slide show playback finished the file list appears.

• To stop the slide show, press **STOP**. The file list appears.

Customizing the function settings

You can change the default settings to customize performance to your preference.

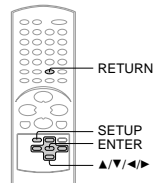

Setting procedure

1 Press **SETUP** during stop mode.



The following on-screen display appears.



2 Press **◀▶** to select the desired section, then press **▼** or **ENTER**.



3 Press **▲** or **▼** to select the desired option.



4 Change the selection using **▲▼/◀▶** or **ENTER**, by referring to the corresponding pages 32-34.



- Repeat step 3 and 4 to change other settings.
- To select another operation, go back to step 2.

5 To make **SETUP** screen disappear, press **SETUP** or **RETURN**.



Setting details

Section	Option	Details	Page
Language	Menu	To select the language of "Menu", "Subtitle" and "Audio" if their languages are recorded onto the disc more than one language.	32
	Subtitle		
Picture	Audio		
	E.B.L.	To select On or Off for E.B.L. (Enhanced Black Level).	32
	Tv Screen	To select a picture size according to the aspect ratio of your TV.	32
	Display	To turn on or de-activate the operational status display on the screen.	33
	JPEG Interval	To select a preferred setting for the slide show playback.	33
Sound	Select Files	To select a preferred file type for playing back a CD containing a mixture of file types.	33
	Dialogue	To select On or Off for DRC (Dynamic Range Control).	33
Parental	Password	Input 4-digit password to set the parental level.	34
	Parental	To select a preferred parental level for the parental setting.	
Other	OSD Language	To select a preferred language for on screen display.	34
	Output	To select a preferred video output signal of "RGB", "Component" or "Progressive".	

Customizing the Function Settings (continued)

Setting details

Language

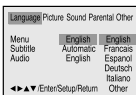

Menu, Subtitle, Audio

You can select the language of "Menu", "Subtitle" and "Audio" if more than one languages are recorded onto the disc.

English, Francais, Espanol, Deutsch, Italiano:
The selected language will be heard or seen.

Other:
Other language can be selected (see the "Language code list" on page 36).

Automatic: (Subtitle)

- The unit will automatically select the same language in the AUDIO setting.
- When the unit selects the same language as the AUDIO, the subtitles will not appear during playback.
- When you do not use the same language as the AUDIO, the subtitles will appear during playback.

Off: (Subtitle)
Subtitles do not appear.

Original: (Audio)
The unit will select the first priority language of each disc.

Note:
If the selected language is not recorded on the disc, the first-priority language is selected.

Picture

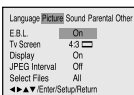

E.B.L.

To select the black level of playback pictures, set your preference and monitor's ability.

On: Enhanced grey scale (0 IRE cut off)
Off: Standard grey scale (7.5 IRE cut off)

Tv Screen

You have the following screen sizes to choose from:

4:3 Letter box:
Select this mode when connecting to a conventional TV. When playing back a wide screen-DVD disc, it displays the wide picture with black bands at the top and bottom of screen.

4:3 Pan scan:
It displays the wide picture on the whole screen with left and right edges automatically cut off.

16:9 Wide:
Select this mode when connecting to a wide-screen TV. A wide screen picture is displayed full size.

Note:
If the DVD disc is not formatted in the pan & scan style, it displays 4:3 style.

Display

On screen display can be switched on or off when you press the buttons.

- On:** On screen displays appear when you press the buttons (factory setting).
- Off:** On screen displays do not appear when you press any buttons.

JPEG Interval

You can continuously play back all JPEG files automatically. After the setting below, start playing the disc on which JPEG files have been recorded.

Off:
Plays back one file at a time.

5 Seconds:
Plays back images in the form of a slide show at 5 second intervals.

10 Seconds:
Plays back images in the form of a slide show at 10 second intervals.

15 Seconds:
Plays back images in the form of a slide show in 15 second intervals.

Select Files

When playing back a CD containing a mixture of MP3, WMA and JPEG files, only MP3/WMA or JPEG files can be displayed on the file menu.

All:
Displays all files.

Music Only:
Displays only MP3/WMA files.

Pictures Only:
Displays only JPEG files.

Sound

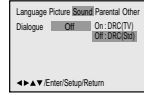

Dialogue

DRC (Dynamic Range Control) enables you to control the dynamic range so as to achieve a suitable sound for your equipment.

On: Loud sound such as explosion or similar is toned down slightly when played back. This makes it suitable for when it is connected to a stereo.

Off: It plays back at the recording level on the disc.

Notes:

- This function works only during playback of Dolby Digital recorded discs.
- The level of Dynamic Range Reduction may differ depending on DVD video disc.

Setting details

Parental

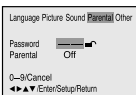

Parental control setting

Some discs are specified not suitable for children. Such discs can be limited not to play back with the unit.

- Press **▲** or **▼** to select "Parental", then press **◀** or **▶** until the level you require appears.
 - Level Off:** The parental control setting does not function.
 - Level 8:** All DVD software can be played back.
 - Level 1:** DVD software for adults cannot be played back.
- Press **▲** or **▼** to select "Password". Press **Number buttons (0-9)** to input a 4-digit password. Be sure to remember this number!
 - If you input a wrong number, press **CLEAR**.
- Press **ENTER** to store the password. Note: Now the rating is locked and the setting can not be changed unless you enter the correct password.

To change the parental level

- Press **▲** or **▼** to select "Password".
- Press **Number buttons (0-9)** to enter the password you have stored.
- Press **ENTER**.
 - The rating is now unlocked.
- Press **▲** or **▼** to select "Parental", then press **◀** or **▶** to change the parental level.
- Press **▲** or **▼** to select "Password", then press **Number buttons (0-9)** to enter the password. Note: You can change the password if you want.
- Press **ENTER**. Now the parental level is changed and locked.

If you forget the password...

- Press **OPEN/CLOSE** to open the disc tray.
- Remove the disc.
- Press **OPEN/CLOSE** again to close the disc tray. "No Disc" appears on the screen.
- While holding **STOP** down on the front panel, press **7** on the remote control. "PASSWORD CLEAR" appears on the screen.
- Enter a new password again.

Notes:

- Depending on the discs, the unit cannot limit playback.
- Some discs may not be encoded with specific rating level information though its disc jacket says "adult." For those discs, the age restriction will not work.

Other



OSD Language

You can select the language of On Screen Display.

English, Francais, Espanol, Deutsch, Italiano:
The selected language will be seen.

Output

You can select the video output signal of the DVD video player to the TV from "RGB", "Component" or "Progressive".

RGB:
Select when connecting to an RGB or composite TV.

Component:
Select when connecting to a TV equipped with component video inputs but progressive scan is not compatible.

Progressive:
Select when connecting to a TV equipped with component video inputs, progressive scan compatible.

Warning:

Once "Progressive" is selected when connecting to a TV progressive scan incompatible, no image will be seen on the video display.

In this case, you must reset the unit by pressing the STOP button on the front panel for five seconds. The video output will be restored to "RGB" setting, and a picture will once again be seen on a conventional analog display. (You may need to make the Scart connection if you connect a TV, progressive scan incompatible, with component lead only.)

Notes:

- Some discs may not be played back with the progressive scanning mode correctly because of the disc characteristics or recording condition.
- Once Progressive scan on, all other video outputs are disabled except component video outputs.

Note:
If each setup (pages 32-34) has been completed, the unit can always be worked under the same conditions (especially with DVD discs). Each setup will be retained in the memory even if you turn the power off.

Temporary disabling of rating level by DVD disc

Depending on the DVD disc, the disc may try to temporarily cancel the rating level that you have set. It is up to you to decide whether to cancel the rating level or not.

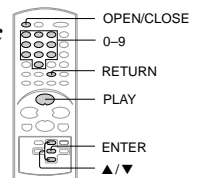

- Load a DVD disc and press **PLAY** or **OPEN/CLOSE** on the unit **(16)**.

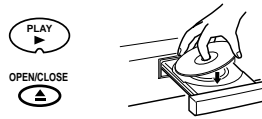

- If the DVD disc has been designed to temporarily cancel the Rating level, the screen which follows the "Reading" screen will change, depending on which disc is played. If you select "YES" with the **ENTER** key, "Your disc exceeds the parental control level" screen will then appear.

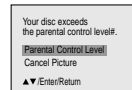

- If you wish to cancel the set rating level temporarily, select "Parental Control Level" with **▲** or **▼**, then press **ENTER**. If the 4-digit password at step 2 on page 34 has been set, the password entering screen will appear as shown in step 4. Alternatively, if the password has not been set, playback will commence. If you don't know (or have forgotten) the password, select "Cancel Picture". The setting screen will disappear. Press **OPEN/CLOSE** to remove the disc.

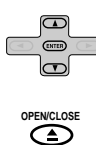

- Enter the password with **Number buttons (0-9)**. Then press **ENTER**. If you interrupt the entering, press **RETURN**.

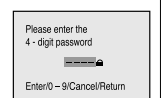
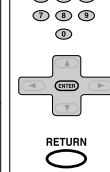

- Playback will commence if the entered password was correct.

Note:

This temporary cancellation of rating level will be kept until the disc is ejected. When the disc is ejected, the original rating level will be set again automatically.

Language code list

Enter the appropriate code number for the initial settings "Menu", "Subtitle" and/or "Audio" (32).

Language Name Code	Language Name Code	Language Name Code	Language Name Code
Abkhazian	1112	Fiji	1620
Afar	1111	Finnish	1619
Afrikaans	1116	French	1628
Albanian	2927	Frisian	1635
Amharic	1123	Galician	1722
Arabic	1128	Georgian	2111
Armenian	1835	German	1415
Assamese	1129	Greek	1522
Aymara	1135	Greenlandic	2122
Azerbaijani	1136	Guarani	1724
Bashkir	1211	Gujarati	1731
Basque	1531	Hausa	1811
Bengali; Bangla	1224	Hebrew	1933
Bhutani	1436	Hindi	1819
Bihari	1218	Hungarian	1831
Breton	1228	Icelandic	1929
Bulgarian	1217	Indonesian	1924
Burmese	2335	Interlingua	1911
Byelorussian	1215	Irish	1711
Cambodian	2123	Italian	1930
Catalan	1311	Japanese	2011
Chinese	3618	Javanese	2033
Corsican	1325	Kannada	2124
Croatian	1828	Kashmiri	2129
Czech	1329	Kazakh	2121
Danish	1411	Kirghiz	2135
Dutch	2422	Korean	2125
English	1524	Kurdish	2131
Esperanto	1525	Laothian	2225
Estonian	1530	Latin	2211
Faroese	1625	Latvian, Lettish	2232
		Lingala	2224
		Lithuanian	2230
		Macedonian	2321
		Malagasy	2317
		Malay	2329
		Malayalam	2322
		Maltese	2330
		Maori	2319
		Marathi	2328
		Moldavian	2325
		Mongolian	2324
		Nauru	2411
		Nepali	2415
		Norwegian	2425
		Oriya	2528
		Panjabi	2611
		Pashto, Pushto	2629
		Persian	1611
		Polish	2622
		Portuguese	2630
		Quechua	2731
		Rhaeto-Romance	2823
		Romanian	2825
		Russian	2831
		Samoan	2923
		Sanskrit	2911
		Scots Gaelic	1714
		Serbian	2928
		Serbo-Croatian	2918
		Shona	2924
		Sindhi	2914
		Slovak	2921
		Slovenian	2922
		Somali	2925
		Spanish	1529
		Sundanese	2931
		Swahili	2933
		Swedish	2932
		Tagalog	3022
		Tajik	3017
		Tamil	3011
		Tatar	3030
		Telugu	3015
		Thai	3018
		Tibetan	1225
		Tigrinya	3019
		Tonga	3025
		Turkish	3028
		Turkmen	3021
		Twi	3033
		Ukrainian	3121
		Urdu	3128
		Uzbek	3136
		Vietnamese	3219
		Volapük	3225
		Welsh	1335
		Wolof	3325
		Xhosa	3418
		Yiddish	2019
		Yoruba	3525
		Zulu	3631

Before calling service personnel

Check the following guide for the possible cause of a problem before contacting service.

Symptoms and correction

Symptom	Cause	Correction	Page
No power.	• The power plug is disconnected.	• Connect the power plug securely into the wall outlet.	–
No picture.	• The TV is not set to receive DVD signal output.	• Select the appropriate video input mode on the TV so the picture from the DVD video player appears on the TV screen.	16
	• The video cable is not connected securely.	• Connect the video cable securely into the appropriate jacks.	12
No sound.	• The equipment connected with the audio cable is not set to receive DVD signal output.	• Select the correct input mode of the audio receiver so you can listen to the sound from the DVD video player.	–
	• The audio cable is not connected securely.	• Connect the audio cable securely into the appropriate jacks.	12–15
	• The audio receiver or TV is turned off.	• Turn on the equipment connected with the audio cable.	16
	• The unit is in the special playback mode.	• Resume the normal playback.	17
The playback picture has occasional distortion.	• The disc is dirty.	• Eject the disc and clean it.	5
	• It is in fast forward or fast reverse playback.	• Sometimes a small amount of picture distortion may appear. This is not a malfunction.	–
Brightness is unstable or noises are present in the playback pictures.	• The effect of copy protection.	• Connect the DVD video player directly to the TV. Avoid connecting the DVD video player to a VTR or TV/VTR combination.	12
	• No disc is inserted.	• Insert a disc.	16
The DVD video player does not start playback.	• An unplayable disc is inserted.	• Insert a playable disc. (Check the disc type and colour system.)	6
	• The disc is placed upside down.	• Place the disc with the playback side down.	16
	• The disc is not placed within the guide.	• Place the disc correctly inside the guide on the disc tray.	16
	• The disc is dirty.	• Clean the disc.	5
	• The parental lock function is set.	• Cancel the parental lock function or change the parental lock level.	34
	•  appears on the screen.	• The function is prohibited with the unit or the disc.	6
Playback does not follow the course of the disc's programme.	• It is in the mode of repeat playback, programme playback, etc.	• These operations may prevent a proper progress of the contents.	–
Buttons do not work.	• Power supply fluctuations or other abnormalities such as static electricity may interrupt correct operations.	• Turn the power on or off with ON/STANDBY. Or disconnect the power plug and insert it into the wall outlet again.	–
The remote control does not work properly.	• The remote control is not pointed at the remote sensor of the DVD video player.	• Point the remote control at the remote sensor of the DVD video player.	11
	• The remote control is too far from the DVD video player.	• Operate the remote control within about 7 m.	11
	• The batteries in the remote control are exhausted.	• Replace the batteries with new ones.	11