

TOSHIBA
Leading Innovation >>>

HD DVD player



HD-EP35KB HD-EP35KE



* The DTS-HD Advanced Digital Out logo indicates that this product when properly upgraded can enable full DTS-HD Advanced Digital Out capabilities. Please contact Toshiba Customer Solutions for update information.

Owner's manual

SAFETY PRECAUTIONS

WARNING: TO REDUCE THE RISK OF FIRE OR ELECTRIC SHOCK, DO NOT EXPOSE THIS APPLIANCE TO RAIN OR MOISTURE. DANGEROUS HIGH VOLTAGES ARE PRESENT INSIDE THE ENCLOSURE. DO NOT OPEN THE CABINET. REFER SERVICING TO QUALIFIED PERSONNEL ONLY.

WARNING: THE MAINS PLUG IS USED AS THE DISCONNECT DEVICE, THEREFORE INSTALL THE PLAYER NEAR THE WALL OUTLET SO THAT THE MAINS PLUG CAN BE ACCESSED EASILY AT ALL TIMES.

CAUTION: This HD DVD player employs a Laser System.
To ensure proper use of this product, please read this owner's manual carefully and retain for future reference. Should the unit require maintenance, contact an authorized service location.

Use of controls or adjustments or performance of procedures other than those specified herein may result in hazardous radiation exposure.

To prevent direct exposure to laser beam, do not try to open the enclosure.
Visible and invisible laser radiation when open and interlocks defeated.
DO NOT STARE INTO BEAM.

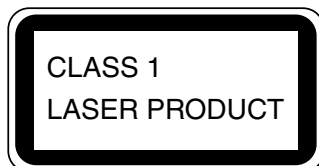

EU Conformity Statement



"This product is marked with "CE" and complies therefore with the applicable harmonized European standards listed under the Low Voltage Directive **2006/95/EC** and the EMC Directive **2004/108/EC**."

Responsible for CE-marking is TOSHIBA INFORMATION SYSTEM (U.K.) LTD,
Toshiba Court, Weybridge Business Park, Addlestone Road
Weybridge, Surrey KT15 2UL U.K.

Manufacturer:
Toshiba Corporation, 1-1 Shibaura 1-chome, Minato-ku, Tokyo, 105-8001, Japan

CAUTION: These servicing instructions are for use by qualified service personnel only. To reduce the risk of electric shock do not perform any servicing other than that contained in the operating instructions unless you are qualified to do so.

In the spaces provided below, record the Model and Serial No. located on the rear panel of your player.

Model No. _____ Serial No. _____

Retain this information for future reference.

Location of the required label

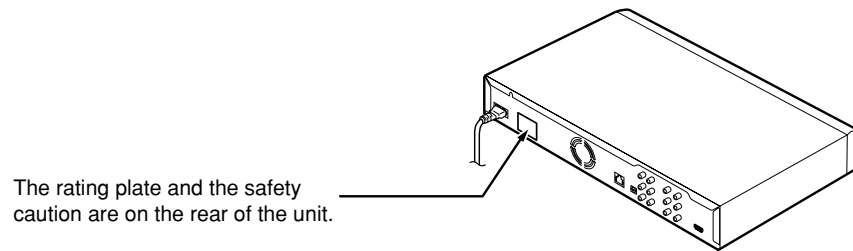

Following information is only for EU-member states:

The use of the symbol indicates that this product may not be treated as household waste. By ensuring this product is disposed of correctly, you will help prevent potential negative consequences for the environment and human health, which could otherwise be caused by inappropriate waste handling of this product. For more detailed information about recycling of this product, please contact your local city office, your household waste disposal service or the shop where you purchased the product.

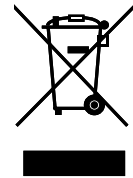

IMPORTANT SAFETY INSTRUCTIONS

CAUTION: PLEASE READ AND OBSERVE ALL WARNINGS AND INSTRUCTIONS GIVEN IN THIS OWNER'S MANUAL AND THOSE MARKED ON THE UNIT. RETAIN THIS BOOKLET FOR FUTURE REFERENCE.

This set has been designed and manufactured to assure personal safety. Improper use can result in electric shock or fire hazard. The safeguards incorporated in this unit will protect you if you observe the following procedures for installation, use and servicing. This unit is fully transistorized and does not contain any parts that can be repaired by the user. **DO NOT REMOVE THE CABINET COVER, OR YOU MAY BE EXPOSED TO DANGEROUS VOLTAGE. REFER SERVICING TO QUALIFIED SERVICE PERSONNEL ONLY.**

1. Read these instructions.

2. Keep these instructions.

3. Heed all warnings.

4. Follow all instructions.

5. Do not use this apparatus near water.

6. Clean only with dry cloth.

7. Do not block any ventilation openings. Install in accordance with the manufacturer's instructions.

8. Do not install near any heat sources such as radiators, heat registers, stoves, or other apparatus (including amplifiers) that produces heat.

9. Protect the power cord from being walked on or pinched particularly at plugs, convenience receptacles, and the point where they exit from the apparatus.

10. Only use attachments/accessories specified by the manufacturer.

11. Do not place a flaming object such as a burning candle on the apparatus.

12. Unplug this apparatus during lightning storms or when unused for long period of time.

13. Refer all servicing to qualified service personnel. Servicing is required when the apparatus has been damaged in any way, such as power-supply cord or plug is damaged, liquid has been spilled or objects have fallen into the apparatus, the apparatus has been exposed to rain or moisture, does not operate normally, or has been dropped.

ADDITIONAL SAFETY INSTRUCTIONS

14. Do not overload wall outlets; extension cords, or integral convenience receptacles as this can result in a risk of fire or electric shock.

15. Never expose the apparatus to dripping or splashing or place items such as vases, aquariums, any other item filled with liquid, or candles on top of the unit.

16. Keep your fingers well clear of the disc tray as it is closing. Neglecting to do so may cause serious personal injury.

17. Do not place anything on top of this unit.

18. Do not place the apparatus on amplifiers or equipment that may produce heat.

19. Never block or cover the slots or openings in the unit. Never place the unit:

- on a bed, sofa, rug or similar surface;
- too close to drapes, curtains, or walls; or
- in a confined space such as a bookcase, built-in cabinet, or any other place with poor ventilation.

The slots and openings are provided to protect the unit from overheating and to help maintain reliable operation.

20. Do not use a cracked, deformed, or repaired disc. These discs are easily broken and may cause serious personal injury and apparatus malfunction.

21. If the apparatus should emit smoke or an unusual odor, immediately disconnect the power cord from the wall outlet. Wait until the smoke or smell stops, then ask your dealer for a check and repair. Neglecting to do so may cause fire.

22. During thunderstorms, do not touch the connecting cables or the apparatus.

23. The mains plug is used as the disconnect device, therefore install the player near the wall outlet so that the mains plug can be accessed easily at all times.

Precautions

Notes on handling

- Never disconnect the power cord from a wall outlet while the player is turned on, unless it is in an emergency. Doing so may cause malfunction.
- When shipping the player, the original shipping carton and packing materials come in handy. For maximum protection, repack the unit as it was originally packed at the factory.
- Do not use volatile liquids, such as insect spray, near the player. Do not leave rubber or plastic products in contact with the player for a long time. They will leave marks on the finish.
- The top and rear panels of the player may become warm after a long period of use. This is not a malfunction.

When not in use

- For usual absence
Be sure to remove the disc from the player and turn off the power.
- Prolonged absence
Unplug the player from a wall outlet. (This will stop the clock. Display "SETUP MENU" by pressing SETUP (⇒ page 32), and reset the clock.)

Notes on locating

- Place the player on a level surface. Do not use it on a shaky or unstable surface such as a wobbly table or inclined stand. The loaded disc may dislodge from its proper position and cause damage to the player. Before placing the player, make sure that the surface can stand the weight of the player. Never place the player in a high location to avoid damage to the product or person by an accidental fall of the player.
- When you place this player near a TV, radio, or VTR, the playback picture may become poor and the sound may be distorted depending on the condition and location of said equipment. In such an event, place the player as far away as practical from the TV, radio, or VTR.
- To avoid damage to this product, never place or store the unit in direct sunlight; hot, humid areas; or areas subject to excessive dust, oily smoke, cigarette smoke or vibration.

Notes on cleaning

Use a soft, dry cloth for cleaning.

- Do not use any type of solvent, such as thinner or benzine, as they may damage the surface of the player.

About the volume level

The volume level of some commercial HD DVD and DVD discs may seem lower than that of audio CDs, other software, etc. If you turn up the volume of the TV or amplifier to play such discs, be sure to turn it back down after playback finishes.

Playback restrictions

This owner's manual explains the basic instructions for this player. Some HD DVD discs or DVD video discs are produced in a manner that allows specific or limited operation during playback. As such, the player may not respond to all operating commands. This is not a defect in the player. Please refer to the notes on compatible discs later in this Introduction and to the discussion of DVD playback and features later in this manual.

"⊗" may appear on the TV screen during operation. "⊗" means that the operation is not permitted by the player or the disc.

About software

Because of problems and errors that can occur during the creation of HD DVD, DVD and CD software and/or the manufacture of HD DVD, DVD and CD discs, Toshiba cannot assure that this player will successfully play every disc bearing the HD DVD, DVD or CD logos. If you happen to experience any difficulty playing an HD DVD, DVD or CD disc on this player, please contact Toshiba customer service.

Some differences

The HD DVD player operates more like a computer and differently than a standard DVD player. In addition to containing a microprocessor, it contains an operating system, random access memory (RAM), and an HD DVD drive. The operating system includes software that is transferred to the RAM when the machine is turned on and at other times during operation. This transfer can take time. Therefore, when you turn the HD DVD player on, it may take a little while before it is ready to use. Likewise, other functions may not be performed as quickly as they would on other AV equipment. Please take these factors into consideration as you use the HD DVD player.

Precautions (Continued)

Notes on moisture condensation

Moisture condensation damages the unit. Please read the following carefully.

Moisture condensation occurs, for example, when you pour a cold drink into a glass on a warm day. Drops of water form on the outside of the glass. In the same way, moisture may condense on the optical pick-up lens inside this unit, one of the most crucial internal parts of the unit.

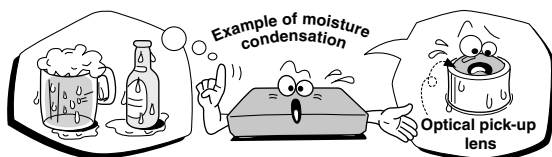

Moisture condensation occurs during the following cases.

- When you bring the unit directly from a cold place to a warm place.
- When you use the unit in a room where you just turned on the heater, or a place where the cool air from an air conditioner blows directly on the unit.
- When the unit is moved from an air conditioned room to a hot, humid location.
- When you use the unit in a humid place.

Do not use the unit when moisture condensation may occur.

If you use the unit in such a situation, it may damage discs and internal parts. Connect the power cord of the unit to the wall outlet, turn on the unit, remove the disc, and leave it for two or three hours. After two or three hours, the unit will have warmed up and evaporated any moisture. Keep the unit connected to the wall outlet and moisture condensation will seldom occur.

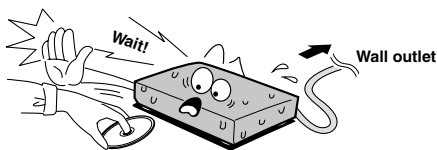

Notes on copyright

- The unauthorized recording, use, display, distribution, or revision of television programs, videotapes, HD DVDs, DVDs, CDs and other materials, is prohibited under the Copyright Laws of the United States and other countries, and may subject you to civil and/or criminal liability.
- This product incorporates copyright protection technology that is protected by method claims of certain U.S. patents and other intellectual property rights owned by Macrovision Corporation and other rights owners. Use of this copyright protection technology must be authorized by Macrovision Corporation, and is intended for home and other limited viewing uses only unless otherwise authorized by Macrovision Corporation. Reverse engineering or disassembly is prohibited.

Dolby and the double-D symbol are registered trademarks of Dolby Laboratories.

Manufactured under license from DTS, Inc. under one or more of the following U.S. Pat. No's: 5,451,942; 5,956,674; 5,974,380; 5,978,762; 6,226,616; 6,487,535 and other U.S. and world-wide patents issued and pending. "DTS" is a registered trademark of DTS, Inc. and "DTS-HD Advanced Digital Out" is a trademark of DTS, Inc. Copyright 1996, 2002-2006 DTS, Inc. All Rights Reserved.

HDMI, the HDMI logo and High-Definition Multimedia Interface are trademarks or registered trademarks of HDMI Licensing LLC.

SHARC and Melody are registered trademarks of Analog Devices, Inc.

VRS is a trademark of Anchor Bay Technologies, Inc.

HD DVD and **DVD** are trademarks of DVD Format/Logo Licensing Corporation.

All other brand and product names mentioned in this manual are trademarks and/or registered trademarks of their respective holders.

Table of contents













SAFETY PRECAUTIONS	2	Customizing the function settings	32
IMPORTANT SAFETY INSTRUCTIONS	4	Settings	33
Precautions	5	Picture	33
Table of contents	7	Audio	34
Features	8	Language	35
Disc compatibility.....	8	Ethernet	37
Customer support.....	9	General	37
Index to parts and controls	10	Firmware update	38
Accessories	12	Before calling service personnel	39
Remote control	12	Specification	Back cover
Loading batteries.....	12	INFORMATION ON CUSTOMER	
TV control.....	13	SUPPORT	Back cover
Preparation	14		
Resolution and connections	14		
Step 1: Connecting to a TV	15		
Step 2: Connecting to audio system.....	16		
Step 3: LAN connection.....	17		
Step 4: Power connection	18		
Step 5: Powering on.....	18		
Step 6: Setting up the player	19		
A: Language.....	19		
B: Time.....	20		
C: Resolution.....	21		
D: Audio output	22		
E: Ethernet	24		
Playing	26		
Playing a disc	26		
To pause playback.....	27		
To stop playback	27		
To resume playback from the location last stopped.....	27		
To change playback speed	27		
To select the sound	28		
To select subtitles	28		
To select the camera angle.....	28		
To locate a position	29		
To play repeatedly.....	29		
To check the current status.....	29		
HD DVD playing options in the future.....	30		
A/B/C/D buttons	30		
Cursor controls.....	30		
Controller port	30		
Requirements for HD DVD discs/ Web-enabled network content	30		
Output sound conversion table	31		

Features

Disc compatibility

Discs which can be played on this player are as follows.

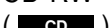
The icons () are used in this manual to indicate features and/or functions that are applicable to various types of discs.

Disc	Specification		
Prerecorded discs			
HD DVD video disc  ()	12cm (4 ³ / ₄ in.) HD DVD video discs are high-density, high-capacity discs. • The HD DVD disc standard has been approved by the DVD forum. • HD DVD (single layer): 15 GB • HD DVD (dual layer): Maximum capacity of 30 GB • A single layer single sided disc (15 GB) has capacity of about 8 hours in 1125 line high definition picture; about 48 hours in 525 line standard definition picture (depending on bitrate of pre-recorded contents). *1GB means 1,000,000,000 bytes. • HD DVD Twin Format Discs have both HD DVD and DVD layers on one side. HD DVD Combination Format Discs have HD DVD material on one side and DVD material on the other side.		
DVD video disc  ()	12cm (4 ³ / ₄ in.) / 8cm (3 ¹ / ₄ in.) Region number 2 or ALL The region number of this HD DVD player is 2. If region numbers, corresponding to a specific playable area, are printed on your DVD video disc and you do not find "2" or "ALL", or the disc is encoded to permit playback only in regions other than Region 2, disc playback will not be allowed by the player.		
Audio CD  ()	12cm (4 ³ / ₄ in.) / 8cm (3 ¹ / ₄ in.)		
Recordable discs			
DVD-RW  ()	DVD VR mode recording (CPRM compatible discs supported.) DVD Video mode recording Finalized discs only.	DVD-R  ()	DVD VR mode recording (CPRM compatible discs supported.) DVD Video mode recording Finalized discs only.
CD-RW ()	CD-DA (audio CD) format Finalized discs only.	CD-R ()	CD-DA (audio CD) format Finalized discs only.

Notes

- This player can play pictures of the PAL/NTSC colour system only.
- You cannot play non-standardized discs even if they may be labeled as above.
- Discs other than the above cannot be played. Even some of the above discs may not be able to be played depending on their state.
- Blu-ray Discs cannot be played on this player.

Notes on handling discs

- Do not touch the playback side of the disc.
- Do not stick paper or tape to discs.
- Fingerprints and dust on the disc may cause picture and/or sound deterioration or prevent playback. Wipe the disc from the centre outwards with a soft cloth. Always keep the disc clean.
- Do not use any type of solvent such as thinner, benzene, commercially available cleaners or antistatic spray for vinyl LPs. It may damage the disc.
- Refer to the instructions of the disc as well.
- Do not store discs in a place subject to direct sunlight or near heat sources.
- Do not store discs in places subject to moisture and dust such as a bathroom or near a humidifier.
- Store discs vertically in a case. Stacking or placing objects on discs outside of their case may cause warping.

Important notes about HD DVD

HD DVD with high-definition content required for HD viewing. Viewing high-definition content and up-converting DVD content may require an HDCP capable DVI or HDMI input on your 50/60 Hz display device. Up-conversion of DVD content will result in near HD picture quality. Firmware update may be required for some interactive features depending on content, which may also require an always-on broadband internet connection. Some features may require additional bandwidth. Some recordable media may not be supported. Dolby Digital Plus, Dolby TrueHD and DTS support for up to 5.1 channels (DTS HD support for DTS core only). MP3/WMA audio files not supported. Because HD DVD is a new format that makes use of new technologies, certain disc, digital connection and other compatibility and/or performance issues are possible. This may, in rare cases, include disc freezing while accessing certain disc features, or functions, or certain parts of the disc not playing back or operating as fully intended. If you experience such issues, please contact Toshiba customer service for your country or <http://www.highdefinitiondvd.eu/>. Some features subject to delayed availability. 1080p capable display required for 1080p output resolution. Deep Color feature as specified in HDMI 1.3a requires compatible Deep Color capable HD display and/or device. In some cases, the included remote control may not operate additional devices or certain features of such devices, in which case, it is suggested that you use the original remote control for the applicable device. Use of REGZA-Link which is a feature based on HDMI-CEC requires an HDMI-CEC compatible display device. For 24p output, content that was created in 1080p / 24 frames/sec is required. Viewing 24p output requires an HD display capable of accepting a 1080p/24Hz signal. While every effort has been made at the time of publication to ensure the accuracy of the information provided herein, product specifications, configurations, system/component/options availability are all subject to change without notice.

Note

- The firmware in this player can be updated. See ⇒ page 38 for details.

Notes on web-enabled network content

Certain HD DVD discs may contain or have the capability of downloading studio-provided, web-enabled network content. To minimize any potential compatibility and/or connectivity issues, before viewing such content, it is recommended that you perform the firmware update process to ensure that your HD DVD player is using the latest firmware version. Do not unplug or turn off the HD DVD player when downloading studio-provided, web-enabled network content. Doing so may cause data stored in the player's persistent storage to be lost.

HD output jacks

- An HDMI jack for connecting a single cable to output video and audio signals
- Component jacks
- 5.1 channel surround analog audio jacks

Certain system requirements

For high definition video playback:

- 50/60 Hz compatible HD display (some discs may require HDCP capable input)
- HD DVD disc with HD content

For Dolby® Digital Plus and Dolby TrueHD multi-channel audio playback:

- A/V Receiver with HDMI™ multi-channel LPCM capable audio input and 5.1 channel speaker setup.

Customer support

Please contact Toshiba customer service for your country or <http://www.highdefinitiondvd.eu/>.

Before accessing, try updating this player's firmware. For details on how to update, see "Update (Firmware update)" (⇒ page 38).

This HD DVD player is manufactured under the HD DVD Format adopted by the DVD Forum. The DVD Forum approved AACCS (Advance Access Content System) as content protection system for HD DVD format like it approved CSS (Content Scramble System) for DVD format. Therefore, certain restrictions are imposed on play, analog signal output, etc. of AACCS protected contents. When you use pre-recorded contents, the contents may designate whether or not to apply such restrictions. As those restrictions may be adopted and/or changed and announced by AACCS after the production of this product, the operation of this product and restrictions thereon may vary depending on the time you purchase this product as well as during the life of this product.

To obtain updated information about AACCS and this product, please contact Toshiba customer service for your country or <http://www.highdefinitiondvd.eu/>.

Index to parts and controls

Front panel

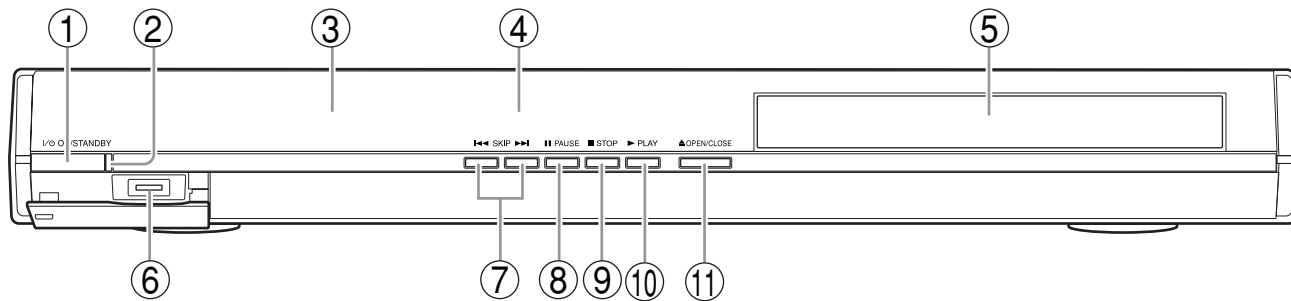

No.	Control	Function	Page
①	ON/STANDBY button	Turns the power on or restores the unit to the standby mode.	18
②	ON/STANDBY indicator	Blue: power on / Red: standby mode	18
③	Front panel display	See the next page.	11
④	Remote sensor	Receives infrared signals from the remote control.	12
⑤	Disc tray	Loads a disc into the disc drive.	26
⑥	Extension port	For future functions.	30
⑦	⏮ / ⏭ (SKIP) buttons	Locates a chapter or track. ⏭ : forward direction / ⏮ : reverse direction	27
⑧	⏸ (PAUSE) button	Stops playback momentarily.	27
⑨	■ (STOP) button	Stops playback.	27
⑩	▶ (PLAY) button	Starts playback.	26
⑪	⏪ / ⏩ (OPEN/CLOSE) button	Opens and closes the disc tray.	26

Rear panel

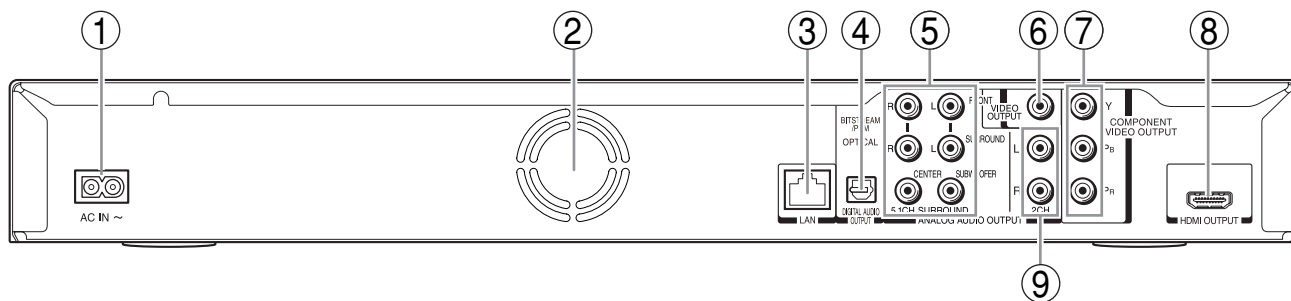

No.	Control	Function	Page
①	AC IN socket	Connect the supplied power cord.	18
②	Ventilation fan	Do not cover the ventilation holes.	—
③	LAN port	Use this to connect to a network with an always-on broadband connection.	17
④	DIGITAL AUDIO OUTPUT BITSTREAM/PCM OPTICAL jack	Outputs digital audio signals. Connect to a digital audio input on an amplifier equipped with digital audio decoder. When connecting the optional digital cable, fit the connector into the jack firmly.	16
⑤	ANALOG AUDIO OUTPUT 5.1CH SURROUND jacks	Outputs analog audio signals. Connect to an amplifier equipped with 5.1 channel audio input.	16
⑥	VIDEO OUTPUT jack	Outputs video signals to a connected TV or amplifier.	15
⑦	COMPONENT VIDEO OUTPUT jacks	Outputs video signals to a connected TV or monitor. Connect to a TV or monitor equipped with component video jacks.	15
⑧	HDMI OUTPUT jack	Outputs video/audio signals to a connected TV, monitor or AV amplifier. Connect to a TV, monitor or AV amplifier equipped with HDMI input.	15
⑨	ANALOG AUDIO OUTPUT jacks	Outputs audio signals to a connected TV or AV amplifier.	16

Display

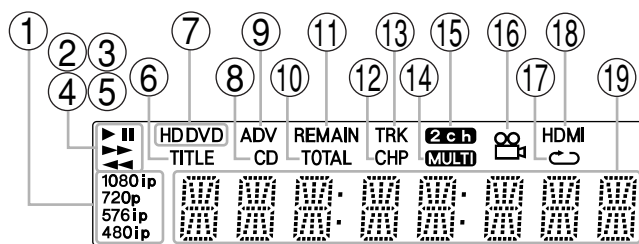

No.	Function
①	Displays the video output format currently selected. (i: interlaced, p: progressive)
②	▶ : Playing
③	⏸ : Pausing
④	▶▶ : Fast forward playback
⑤	◀◀ : Fast reverse playback
⑥	Shows a title number.
⑦	HD DVD: An HD DVD is loaded. DVD: A DVD is loaded.

No.	Function
⑧	A CD is loaded.
⑨	A disc which contains advanced content is loaded.
⑩	Total playing time is displayed.
⑪	Remaining playing time is displayed.
⑫	Shows a chapter number.
⑬	Shows a track number.
⑭	Multi channel sound is output.
⑮	2ch sound is output.
⑯	Playing a scene recorded with multi angles.
⑰	Playing in repeat mode.
⑱	HDMI connection is verified between the player and another device.
⑲	Displays the total playing time of the disc, elapsed time, remaining time, a number of title, chapter or track, messages, etc.

Pressing DIMMER button on the remote control changes the brightness of the display. (Normal / dimmed / off)

- Turning off the power resets this setting.

Remote control

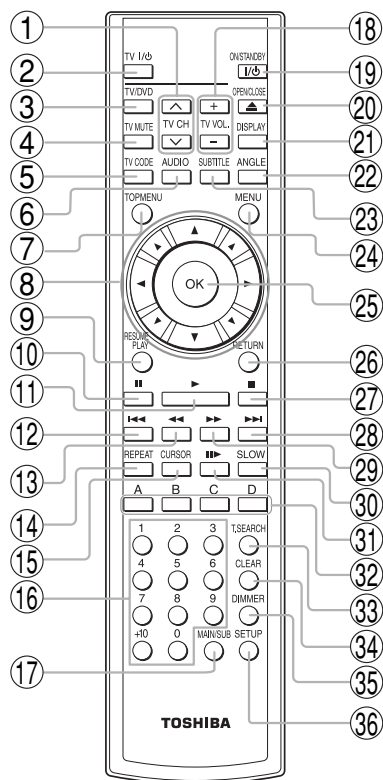

No.	Function	Page
①	To change TV channels.	13
②	To turn the TV on or off.	13
③	To change inputs of the TV.	13
④	To mute the TV.	13
⑤	To program the remote control to control a TV.	13
⑥	To select the sound.	28
⑦	To display a top menu.	26
⑧	To select a content or position to enter.	20, 26

No.	Function	Page
⑨	To resume playback while playing an HD DVD.	27
⑩	To pause playback.	27
⑪	To start playback.	26
⑫	To locate a title, chapter or track in the reverse direction.	27
⑬	To play fast in reverse direction.	27
⑭	To display a repeat mode menu.	29
⑮	To set the 8 direction buttons to move the cursor during HD DVD playback.	30
⑯	To enter numbers.	29
⑰	For future functions which may become available by software update.	-
⑱	To adjust TV volume.	13
⑲	To turn the power on or off.	18
⑳	To open/close the disc tray.	26
㉑	To display operating status.	29
㉒	To select a camera angle.	28
㉓	To display subtitles.	28
㉔	To display a menu included on many DVD video discs.	26
㉕	To enter a selected content.	20, 26
㉖	To return to the previous menu.	20
㉗	To stop playback.	27
㉘	To locate a title, chapter or track in the forward direction.	27
㉙	To play fast in forward direction.	27
㉚	To play in slow motion.	27
㉛	To play frame by frame.	27
㉜	To operate as indicated by the video display during HD DVD playback.	30
㉝	To display a window to locate a title, chapter or track.	29
㉞	To clear entered information.	29
㉟	To change the brightness of the display on the player.	11
㊱	To display the setup menu.	32

Accessories

Supplied accessories

Check that the following accessories are supplied.

Remote control Batteries (R03)

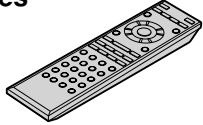

HDMI cable

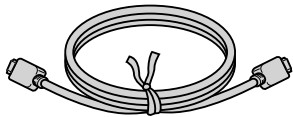

Power cord

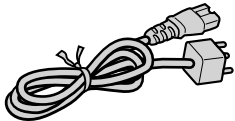

(For HD-EP35KB)

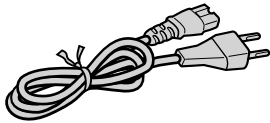

(For HD-EP35KE)

Caution

- Do not use this power cord with any device other than this player.

Remote control

Loading batteries

1 Open the cover and load batteries (R03 size).

Make sure to match the + and – on the batteries to the marks inside the battery compartment.

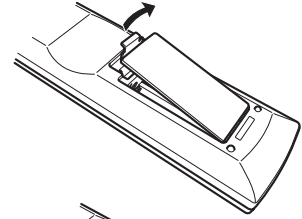

2 Close the cover.

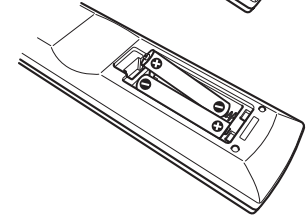

Operating range

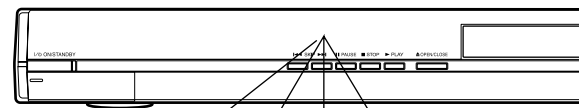

Remote sensor

Within about 7 m



Notes

- Do not drop or give the remote control a shock.
- Do not leave the remote control near an extremely hot or humid place.
- Do not spill water or put anything wet on the remote control.
- Do not disassemble the remote control.
- Dispose of batteries in a designated disposal area.
- Batteries should always be disposed of with the environment in mind.
- Always dispose of batteries in accordance with applicable laws and regulations.
- If the remote control does not operate correctly, or if the operating range becomes reduced, replace all batteries with new ones.
- When necessary to replace batteries in the remote control, always replace all batteries with new ones. Never mix battery types or use new and used batteries in combination.
- Always remove batteries from remote control if they are dead or if the remote control is not be used for an extended period of time. This will prevent battery acid from leaking into the battery compartment.

Caution

Never throw batteries into a fire.

TV control

The remote control of this player is compatible with TV controls.

Once you program the remote control (see the next paragraph), the following controls are available. Operate the remote control toward your TV.

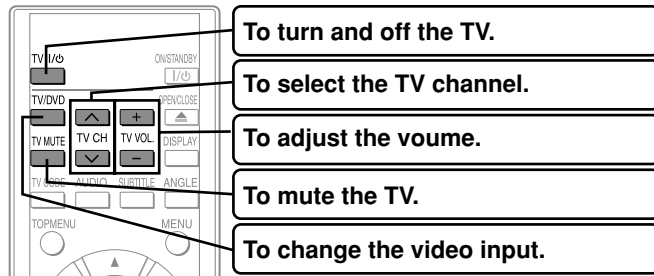

■ To program the remote control to operate your TV

- 1 While holding TV CODE, press the number buttons to enter a corresponding brand code (see below) of your TV.

Some brands have several codes. Try one by one until the remote control can operate your TV.

- 2 Release TV CODE.

The brand code is memorized.

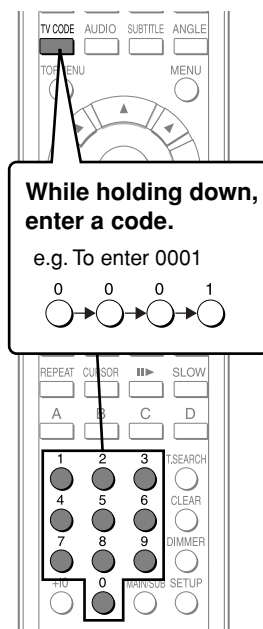

Notes

- TOSHIBA code is already set when you operate this player for the first time.
- When replacing the batteries of the remote control, re-enter the brand code of your TV.

Brand name	Brand code
LG Goldstar	2491
Loewe	2621 2771 2961 3311
Luxor	2701
Marantz	2991
Matsui	2541 2581 2611 2651 2671 2691 2781 2851 2861 3151
Metz	2621
Mitsubishi	2621 2701 2961 3371 4521
National	2701
Orion	2691 2781 2851 3381
Panasonic	2701 2711 2741 3001 3251 3531 3551 3761 3911 3951
Philco	2621
Philips	2561 2571 2591 2621 2811 2821 2881 2991 3461 3581 3731 3881 3981 4531 4541 4551
Pioneer	2761 3481 3681 3921 3931 3941
Saba	2621 2761 2841 3321
Saisho	2541 2651 2691 2731
Samsung	2541 2631 2731 2991 3161 3231 3521 3541 3711 3721 3901 3961 4271 4561
Sanyo	2611 2671 3391
Schneider	2571 2681 2811 2861 3991 4571 4581 4591 4601 4611
SEG	2731 3051
Seleco	2661 2721
Sharp	2641 3401 3611 3631 3781 3791 3801 3811 3821 3831 3971
Singer	2621
Sinudyne	2551 2621 2651 2691 3011 3051
Sony	2551 2951 3621 3641 3651 3871 3891 4281 4621
Tatung	2611
Technics	2711 3001
Telefunken	2841 3421
Tensai	2681 2781
Thomson	6641 2701 2761 2831 3431 3601 4631 4641 4651 4661
Thorn	2581 2611 2951 2961 3221
Universum	2731
Zanussi	2661

Brand name	Brand code
Toshiba	2581 2601 3281 3491 3771 4291 4301 4311 4321 4671
Aiwa	3241
Akai	2671
Bang & Olufsen	2621
Beko	2941 3331 4471
Blaupunkt	2711 2801
Brionvega	2621
Bush	2541 2681 2691 2751 2781 2851 2861 2881 3291 4261 4481
Crown	2541 2871 2921
Daewoo	2541 2881 3221 3271
Decca	2611
Ferguson	2761 2841 3351
Finlux	2601 2611 2621
Fisher	2671 2981
Funai	2731 2781
GEC	2591 2611
Goodmans	2611 2691 2861 2881 3221 3841
Granada	2611 2671
Grundig	2601 2701 3151 3441 4491
Hinari	2541 2681 2691 2901
Hitachi	2591 3301 3471 3501 3511 3701 3671 4501
Inno Hit	2611
JVC	2861 3361 3591 4511

Preparation

Proceed the following steps to set the player ready.



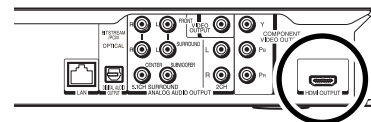

- Step 1: Connecting to a TV** Page 15
- Step 2: Connecting to audio system** Page 16
- Step 3: LAN connection** Page 17
- Step 4: Power connection** Page 18
- Step 5: Powering on** Page 18
- Step 6: Setting up the player** Page 19

Resolution and connections

Check the type of video input on your TV. To view high definition content, use the HDMI OUTPUT jack or the COMPONENT VIDEO OUTPUT jacks to connect to a TV. Some discs may require use of the HDMI OUTPUT jack.

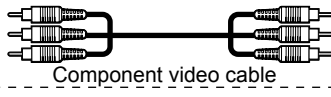
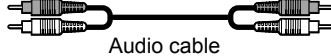

HDMI OUTPUT jack

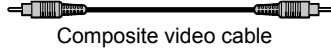
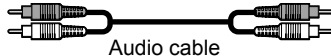
TV input	Connection to this player			Resolution from this player				
	Signal	Cable	Page	HD (High Definition)			SD (Standard Definition)	
				1080p	1080i	720p	480p/576p	480i/576i
 HDMI INPUT Most recommended*	Video	 HDMI cable	15	Yes	Yes	Yes	Yes	Yes
	Audio		(16)					
 Y Pb Pr	Video	 Component video cable	15	No	Yes*	Yes*	Yes*	Yes*
	Audio		 Audio cable	16				
 VIDEO	Video	 Composite video cable	15	No	No	No	No	Yes
	Audio		 Audio cable	16				

* Some discs may prohibit output in this format. In this case, use the HDMI connection.

*Why HDMI connection is most recommended?

HD DVD and DVD video disc creators have the option to include copy protection instructions in their discs that prohibit the output of some standard video or high definition video (original 720p, 1080i or 1080p or up-converted 480i/576i or 480p/576p) from the COMPONENT VIDEO OUTPUT jacks. If such instructions are present in the disc you are playing, you must use the HDMI OUTPUT jack to view the disc in a high definition format and the COMPONENT VIDEO OUTPUT jacks, if activated, will output video only in 480i/576i or 480p/576p resolution.

Step 1: Connecting to a TV

- Connect the player directly to your TV. If you connect the player to a VTR, TV/VTR combination, video selector or AV amplifier, the playback picture may be distorted due to copy protection.
- Be sure to turn off the power and unplug both units from the wall outlet before making any connections.

Via HDMI input

To view 1080p output, make this connection.

HDMI transfers digital audio and uncompressed digital video on a single cable. As a result, audio cables and video cables don't need to be connected separately to a device.

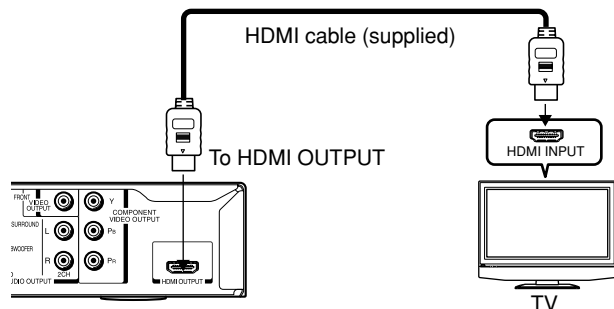

Depending on the TV connected, you can use the CEC function. For detail, see ⇒ page 35.

Notes

- When the HDMI connection is not verified, an error message appears on the front panel display. In this case, disconnect the HDMI cable then connect it again, or turn off the connected HDMI device then turn it on.
 - HDMI output is digital only, DVI analog is not supported.
 - HDMI is an evolving technology, so it is possible that some devices may not operate properly with this player.
 - To get the most possible benefit from Dolby Digital Plus, you should connect your HD DVD player to your AV receiver using its HDMI input. If your AV receiver has this type of input, make sure it is connected to your HD DVD player and that the input is set to use audio from HDMI (and not the SPDIF coaxial or optical input). If your AV receiver does not have an HDMI input, then the next best choice is to use the SPDIF (coaxial or optical) input on your AV receiver.
 - If you use the SPDIF optical output or analog outputs to connect your audio system and have the "Digital Out HDMI" (⇒ page 22) set to "Auto" or "PCM", the audio output level from these jacks will be reduced when listening to a multichannel disc. To restore the audio output level, set "Digital Out HDMI" to "Downmixed PCM".
 - Be sure to confirm compatibility of a cable when connecting a Deep Color compatible display device.
- When the output resolution (⇒ page 21) is set to "480i" or "up to 1080p/24Hz", Deep Color output is disabled.

Via component video input

Some discs may be down converted or require HDMI connection. Not compatible with 1080p. To view 1080p output, select HDMI connection.

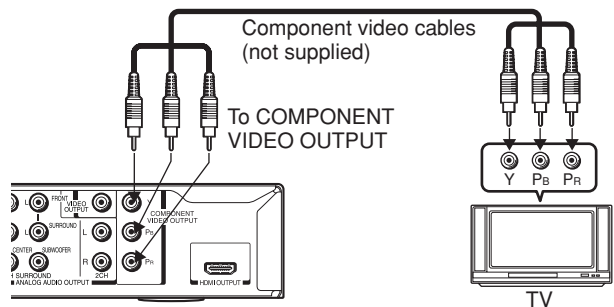

This connection only sends video signals. Be sure to make audio connection on ⇒ page 16.

Via VIDEO (yellow) input

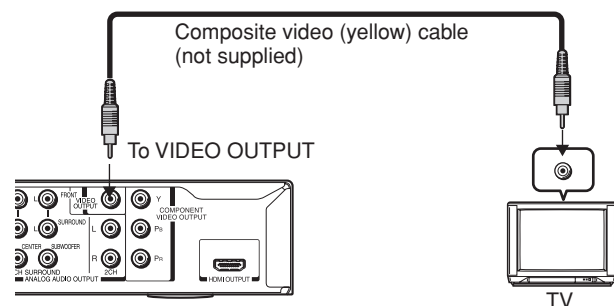

480i/576i output only regardless of the resolution settings (⇒ page 21) or the connections of other output jack.

This connection only sends video signals. Be sure to make audio connection on ⇒ page 16.

Note

- This player supports simultaneous output of video on its HDMI and component video ports. However, some discs may restrict output of video on the component video ports when viewing high definition content or up-converted DVD content. The resolution on the HDMI output will be the same as the resolution output on the component video output. Thus, because the HDMI output can change automatically to match the maximum available resolution of your display, if you connect both the HDMI output and component output, the resolution on the component output will change if the HDMI output auto-adjusts.

Preparation (Continued)

Step 2: Connecting to audio system

Sound can output from connected audio system.

If you made the HDMI connection between the player and a TV, this step is unnecessary. Skip to Step 3.

Via HDMI output

You can enjoy the benefits of Dolby Digital Plus or Dolby TrueHD by connecting the HDMI OUTPUT jack of your player to an AV receiver with an HDMI input.

This connection requires selection of "Digital Out HDMI" (Step 16, ⇨ page 22).

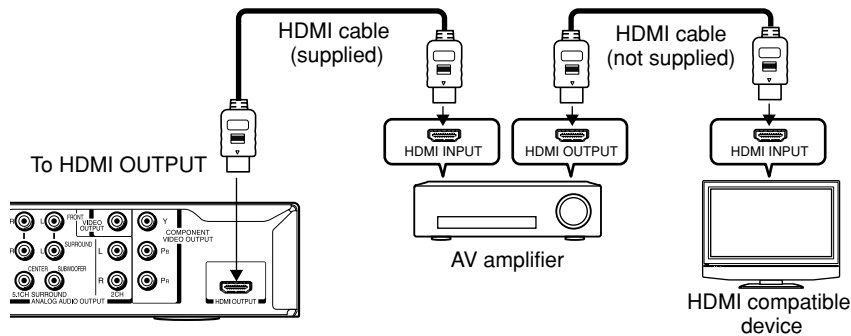

Caution

- When you are connecting (via the HDMI OUTPUT jack) an AV decoder that does not have Dolby Digital or DTS decoding capability, be sure to set "Digital Out HDMI" (⇨ page 22) to "PCM" or "Downmixed PCM". Otherwise, high volume sound may damage your hearing as well as the speakers.

Note

- You may need to adjust the HDMI audio output to match the capabilities of your AV amplifier. In this case, set "Digital Out HDMI" (⇨ page 22) to "PCM".

Via optical digital audio output

You can listen to down-converted Dolby Digital Plus and Dolby TrueHD as well as Dolby Digital and DTS using a receiver with Dolby Digital and DTS decoding capabilities and an optical digital input.

This connection requires selection of "Digital Out SPDIF" (Step 16, ⇨ page 22).

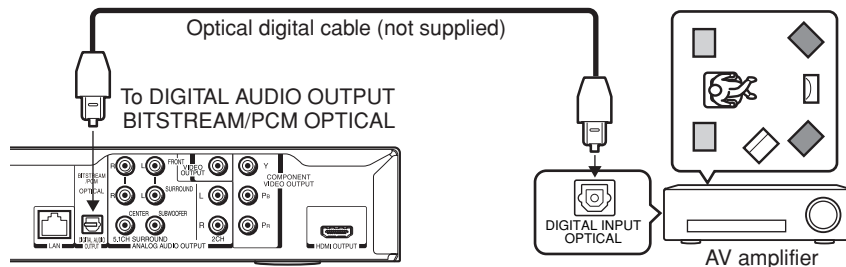

*To use the optical digital output, use an optical cable to connect this jack to an optical audio input on a device capable of processing Dolby Digital, DTS bitstream, or PCM audio.

Via 5.1ch analog audio output

This connection requires selection of "Speaker Setting" (Step 16, ⇨ page 23).

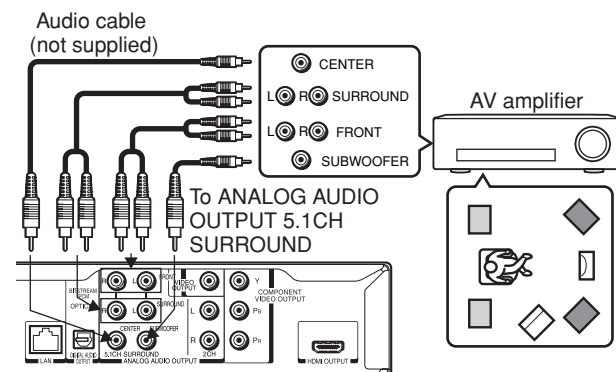

Via analog audio output

Sound is output only in 2ch format.

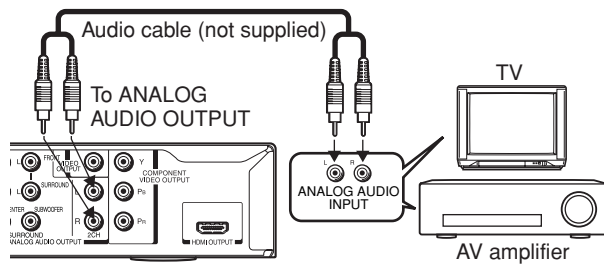

Step 3: LAN connection

You may use the internet connection feature to update the player's firmware. See ⇒ page 35.

Some HD DVD discs may enable you to access special HD DVD sites, if you connect the player to the Internet via an always-on broadband connection. For example, if an HD DVD site includes content such as links to future movie trailers, you can watch the content on the player via the Internet. You do not need to connect to a PC to use this function.

Read the notes on ⇒ page 28 as well.

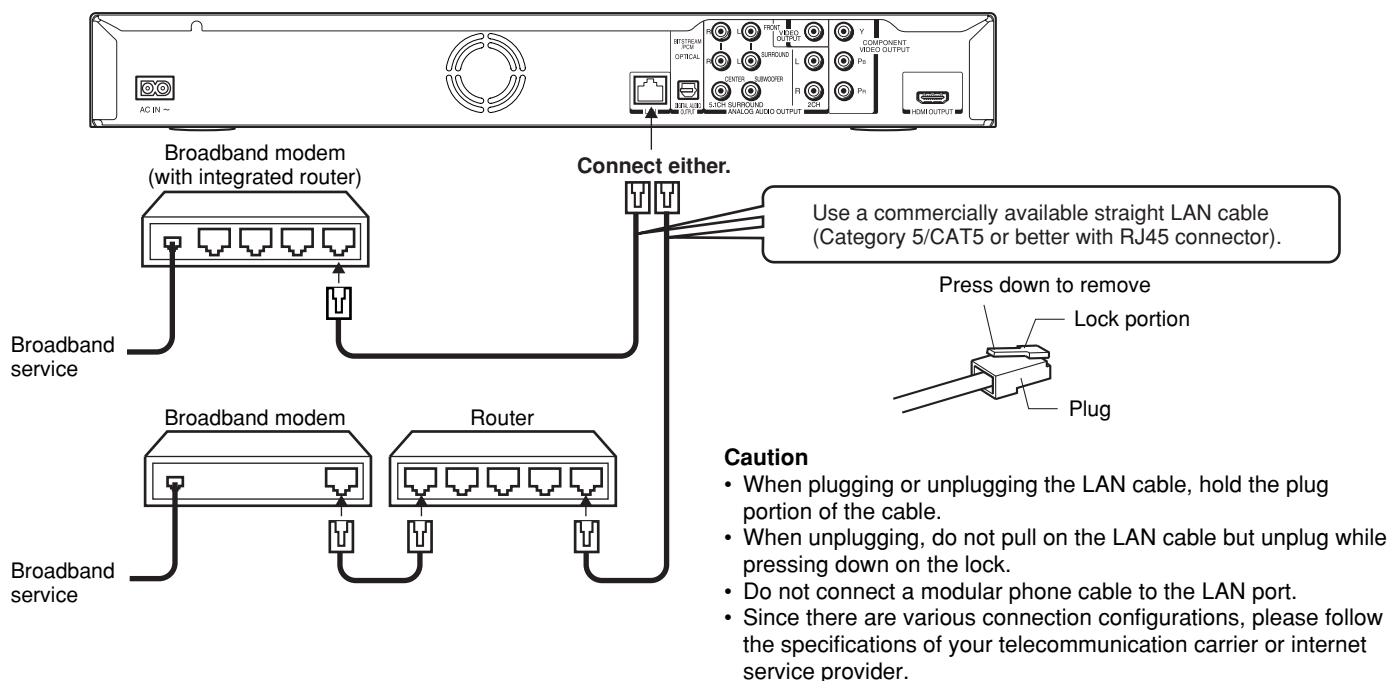

Note

- Depending on the internet service provider (ISP), the number of devices that can receive internet service may be limited by the applicable terms of service. For details, contact your ISP.

Preparation (Continued)

Step 4: Power connection

After completing all connections, connect the supplied power cord to the AC IN socket and a wall outlet.

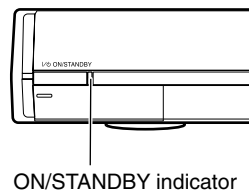
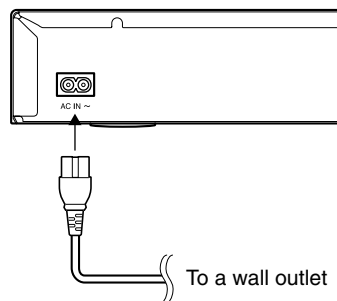

ON/STANDBY indicator on the player illuminates in red.

Caution

- Do not power this player using any power cord other than the one supplied with this player.
- Do not use the supplied power cord with any device other than this player.

Step 5: Powering on

- 1 Turn on the TV or monitor, and select the input which the player is connected to.
- 2 Press ON/STANDBY.

When the power turns on, ON/STANDBY indicator on the front panel changes colour from red (standby mode) to blue (operation).

Start up (and disc loading (⇒ page 26)) may take time.

When you power on this player for the first time, the setting menu will appear. Go to Step 6 to make the necessary setup.

ON/STANDBY button

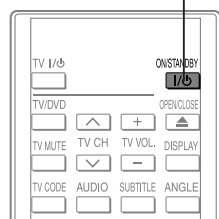

ON/STANDBY button

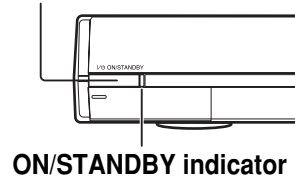

■ To power off the player

Press ON/STANDBY.

Step 6: Setting up the player

Make the settings which are necessary to operate the player.

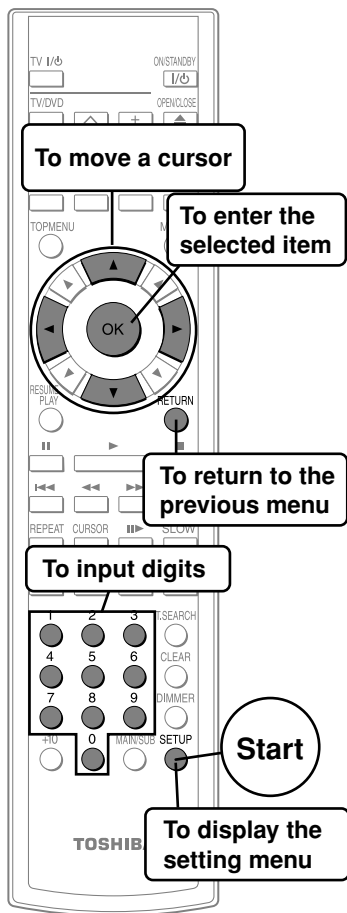

- 1 Make sure that the following menu is displayed.
(If not, press SETUP to display it.)

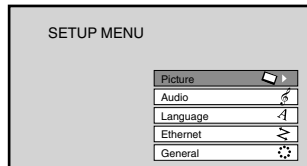

A: Language

- 2 Press ▲ / ▼ to select “Language”, then press OK.

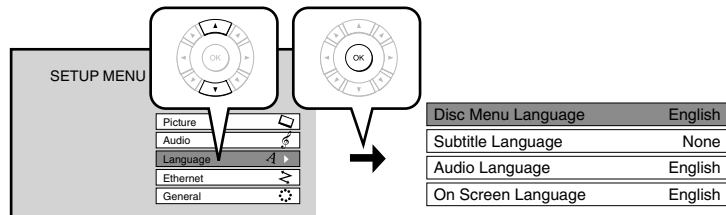

- 3 Press ▲ / ▼ to select “On Screen Language”, then press OK.

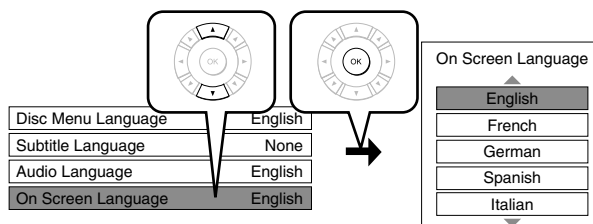

- 4 Press ▲ / ▼ to select the language you want use for on-screen displays, then press OK.
- 5 Press RETURN or ◀ to return to the menu of step 1.

Preparation (Continued)

B: Time

6 Press ▲ / ▼ to select “General”, then press OK.

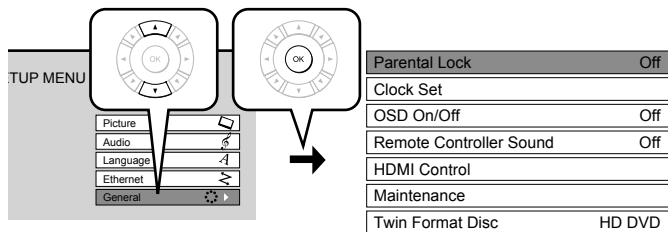

10 Press RETURN or ◀ to return to the menu of step 1.

7 Press ▲ / ▼ to select “Clock Set”, then press OK.

8 Confirm the time is correct.

9 If the time is correct, select “OK” by ▲ / ▼, then press OK to return to the menu of step 2.

When the time needs to be corrected, set each item using the following buttons.

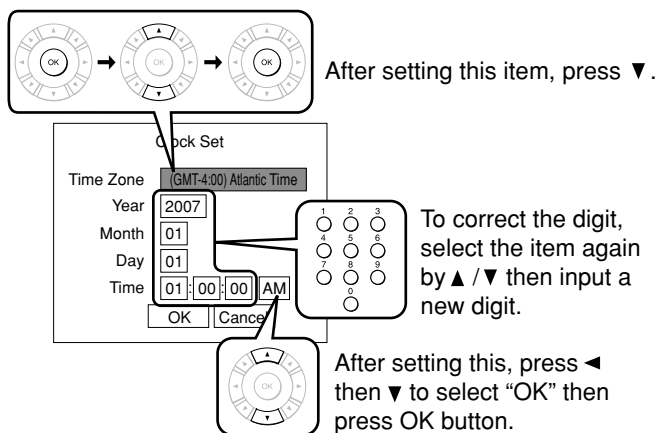

C: Resolution

11 Press ▲ / ▼ to select “Picture”, then press OK.

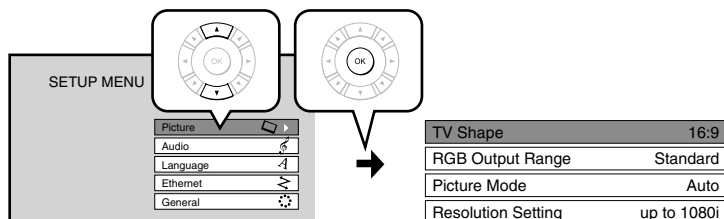

12 Press ▲ / ▼ to select “Resolution Setting”, then press OK.

13 Press ▲ / ▼ to select the resolution according to the performance of your TV as shown in the table below, then press OK.

TV input	“Resolution Setting”
<p>HDMI input</p>	<p>Select the resolution. e.g.</p> <ul style="list-style-type: none"> 480i/576i up to 480p/576p up to 720p up to 1080i up to 1080p up to 1080p/24Hz
<p>Component video input</p>	<p>Select the resolution (except “up to 1080p” and “up to 1080p/24Hz”) according to the performance of the connected TV. e.g.</p> <ul style="list-style-type: none"> 480i/576i up to 480p/576p up to 720p up to 1080i up to 1080p up to 1080p/24Hz
<p>VIDEO (yellow) input</p>	<p>Select any resolution except “up to 1080p/24Hz”.</p>

You may find that setting the output resolution of the player to match as closely as possible the native resolution of your display provides the best picture performance (e.g., 720p for 720p and 1080p for 1080p).

Note

- In case the menu of “Resolution Setting” disappears, make composite video (yellow) connection to restore it, then select the resolution which is compatible with the connected TV.

For best viewing of film movie material (24p output) **HD DVD** **DVD-Video**

Movies that are produced on film, as opposed to video, are traditionally captured at a frame rate of 24 frames per second. Your player can maintain the 24 frames per second frame rate of such movies, allowing you to enjoy them in their native form. To enable this feature, connect an HD display capable of accepting a 1080p/24Hz signal and select “up to 1080p/24Hz.”

Note

- Most film based HD DVDs display images at 24 frames per second and video based HD DVDs display images at 30 frames or 60 fields per second. Depending on the content, “up to 1080p/24Hz” may lower smoothness of playback and/or reduce vertical resolution. In the case of video based HD DVDs, we recommend that the output resolution setting is changed from “up to 1080p/24Hz”.

14 Press RETURN or ◀ to return to the menu of step 1.

Preparation (Continued)

D: Audio output

15 Press ▲ / ▼ to select “Audio”, then press OK.

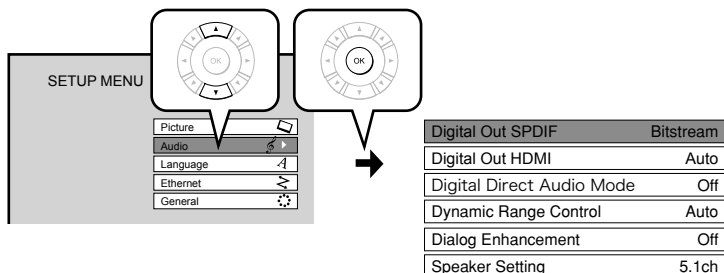

16 When you connected an audio system to the DIGITAL AUDIO OUTPUT BITSTREAM/PCM jack (⇒ page 16):

Press ▲ / ▼ to select “Digital Out SPDIF”, then press OK.

Select one of the followings according to your connection, and press OK.

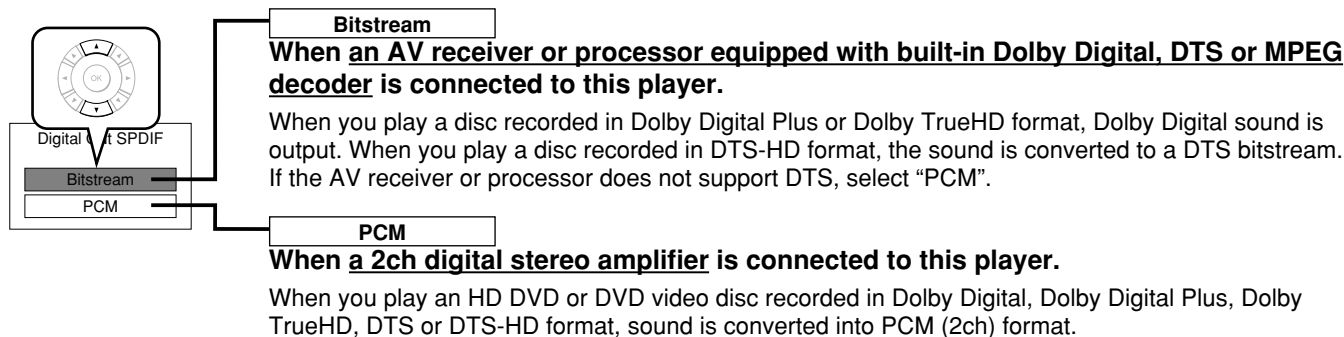

When you connected an HDMI device to the HDMI OUTPUT jack (⇒ page 15, 16):

Press ▲ / ▼ to select “Digital Out HDMI”, then press OK.

Select one of the followings according to your connection, and press OK.

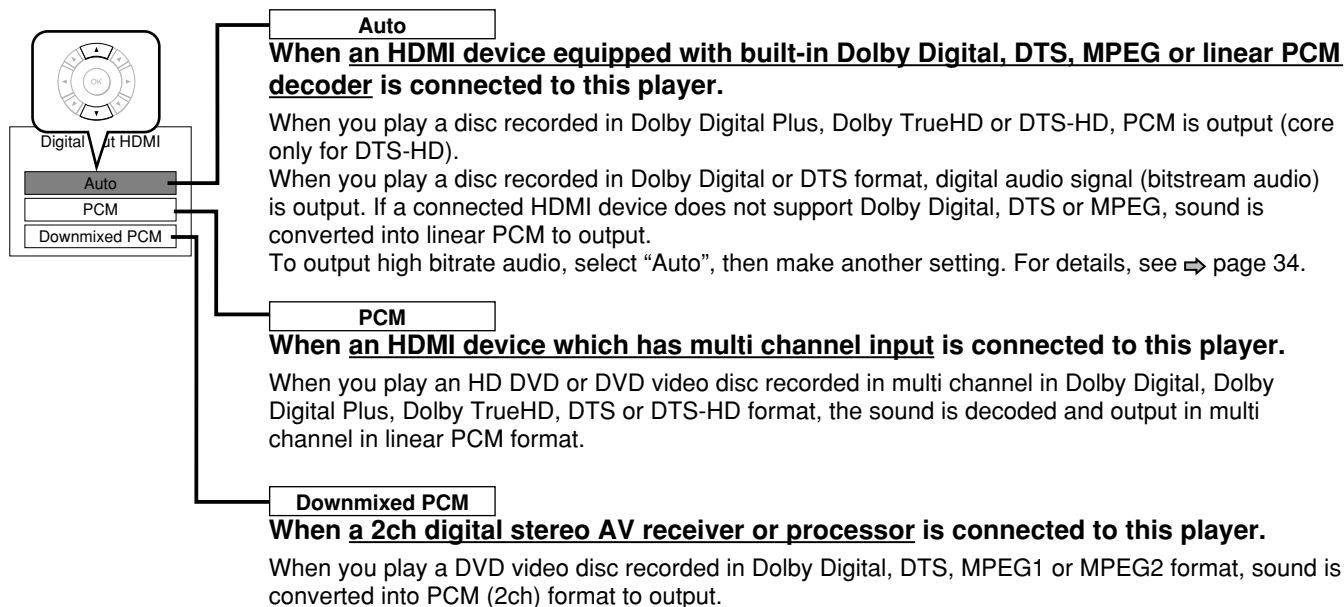

Note

- Setting “Auto” or “PCM” will reduce output level of multi channel sound from the ANALOG AUDIO OUTPUT jacks and the DIGITAL AUDIO OUTPUT BITSTREAM/PCM jack if you:
 - view the playback picture on an HDMI TV connected to this player.
 - play an HD DVD video disc of a certain type, recorded in linear PCM format.
 In this case, the output level will be restored by setting to “Downmixed PCM”.

When you connected an audio system to the **ANALOG AUDIO OUTPUT** jacks (⇒ page 16, 17):

Press ▲ / ▼ to select “Speaker Setting”, then press OK.

Select one of the followings according to your connection, and press OK.

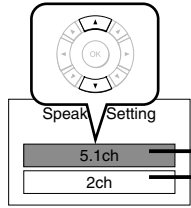

Speak Setting

5.1ch

2ch

5.1ch

When a 5.1 channel surround system is connected to this player.

- Set the speaker sizes, distance to each speaker and the crossover frequency.
 - Front Left / Front Right**
Small: Select if the speaker cannot output low frequency.
Large: Select if the speaker can output low frequency.
 - Center / L Surround / R Surround**
Small: Select if the speaker cannot output low frequency.
Large: Select if the speaker can output low frequency.
None: When the speaker is not connected.
 - Subwoofer**
Use: When a subwoofer is connected.
Don't Use: When a subwoofer is not connected.
 - Crossover Setting**
Low frequency under this frequency (80Hz / 100Hz / 120Hz) will be output to a connected subwoofer.
 - m**
Select a distance to each speaker from the listening position.
- Select “Next”, then press OK.
To cancel to return to the previous screen, select “Clear”, then press OK.
To save your selection and finish the setting, select “End”, then press OK.
- Select “Automatic Test Tone”, then press OK.
A test signal is set to each speaker.
- Adjust each of the volumes by ▲ / ▼, selecting speakers by ◀ / ▶ so that each speaker can sound at the same volume.
For further adjustment, check the channel balance on the amplifier.
- When complete, select “End”, then press OK.

Note

- This setting is effective only when “Digital Out SPDIF” (⇒ page 22) is set to “PCM”.

2ch

When a 2ch stereo system is connected to this player.

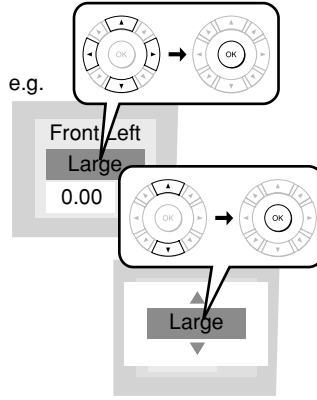

e.g.

Front/Left Large 0.00

Large

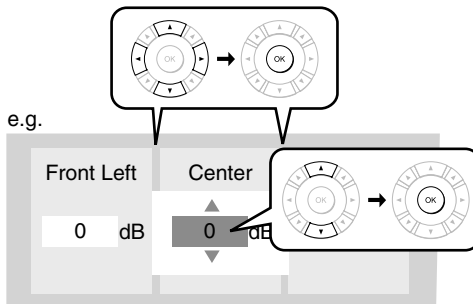

e.g.

Front Left Center 0 dB 0 dB

17 Press RETURN or ◀ to return to the menu of step 1.

(Continued)

Preparation (Continued)

E: Ethernet

Perform this setting if you connect the player to your LAN (⇒ page 17).

After performing this setting, you need to turn off this player and turn it on again to activate this setting.

If you do not connect, skip to Step 20.

18 Press ▲ / ▼ to select “Ethernet”, then press OK.

19 Press ▲ / ▼ to select each of the followings, then press OK.

DHCP	Off	①	To set your network information.
Proxy Setting	Off	②	To input proxy server address (when your provider requires the setting).
MAC Address		③	To display the Mac address of the player. (Fixed. No need to set.)
NTP Server	Off	④	To adjust the player’s clock via the network time protocol.
Network Speed	56kbps Modem	⑤	To select the speed according to the specification of your LAN.
Cookie Setting	Accept		To select whether you access “Cookies” or not.

① DHCP

1 Set “DHCP” to “On” and press OK button.
The network information is automatically set.

2 Set “DNS” to “On” and press OK button.
The DNS server is obtained automatically from the DHCP server.

3 Select “Confirm”, then press OK button.
Confirming starts.
If the setup is successful, an IP address appears.
Press OK button.

Skipped when “DHCP” is set to “On”.

Skipped when “DNS” is set to “On”.

If the setup is not successful:

a) Set “DHCP” to “Off” and press OK button.
The network information is automatically set.

b) Input the addresses using the number buttons.

“IP Address”	This sets a different address within the same subnet of the PC on your network. e.g. if the IP address of the PC is 192.168.1.10, set 192.168.1.15 (or some other unused address.)
“Subnet Mask”	This sets the subnet mask of the network environment that will be connected. e.g.: 255.255.255.0
“Gateway”	This sets the gateway used by the player (e.g.: 192.168.1.1).
“DNS Server”	This sets the DNS server to be used by the player (e.g.: 192.168.1.1).

c) Select “OK” and press OK button.

② Proxy Setting

Enter the proxy server address when your provider requires proxy setting.

1 Set “Proxy” to “On” and press OK button.

2 Enter the specified data from the provider.
Refer to the instructions below for inputting characters. (Server, Port)

3 Select “OK” and press OK button.

How to input characters	
OK button	To begin or finish input.
▲ / ▼ buttons	To select a character.
◀ / ▶ buttons	To move to the next character.
CLEAR button	To erase to correct.
Number buttons	To input a number.

③ NTP Server

Select “On” or “Off” and press OK button.

“On”	The player automatically accesses an internet server to adjust time protocol.
“Off”	The player does not access an internet server to adjust its clock.

④ Network Speed

Select the speed and press OK button.

For other speeds:
1 Select "Other" and press OK button.

Network Speed	
28.8kbps Modem	33.6kbps Modem
56kbps Modem	64kbps ISDN
128kbps ISDN	256kbps DSL/Cable
384kbps DSL/Cable	512kbps DSL/Cable
768kbps DSL/Cable	1Mbps Cable
1.5Mbps T1	Over 10Mbps
Other	

Network Speed (Other)

1 kbps

OK Cancel

2 Specify the speed by number buttons.
3 Select "OK" and press OK button.

⑤ Cookie Setting

Select "Accept" or "Not Accept" and press OK button.

"Accept" Cookies are accepted.

"Not Accept" Cookies are rejected. This may disable some services on web pages.

Cookie Setting	
Accept	
Not Accept	

20 Press RETURN or ◀ to return to the menu of step 1.

21 Press SETUP to close the menu.

22 If you made the LAN setting ("E: Ethernet", ⇒ page 24), press ON/STANDBY to turn the player off, then press the button again to turn it on.

Your player is ready.

Playing

Preparation

- Turn on the TV or audio system and select the corresponding input source that the player is connected to.
- Turn the power on. (⇒ page 18)

Playing a disc

HD DVD DVD-Video DVD-RW DVD-R CD

1 Press OPEN/CLOSE to open the disc tray.

2 Place a disc in the hollow of the disc tray with the playback side down.

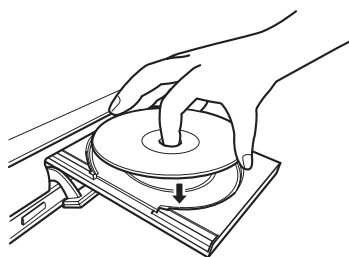

When using a double-sided disc, turn the label of the playing side up.

3 After placing a disc, press OPEN/CLOSE.

Playback starts.

If playback does not start, press ► (PLAY).

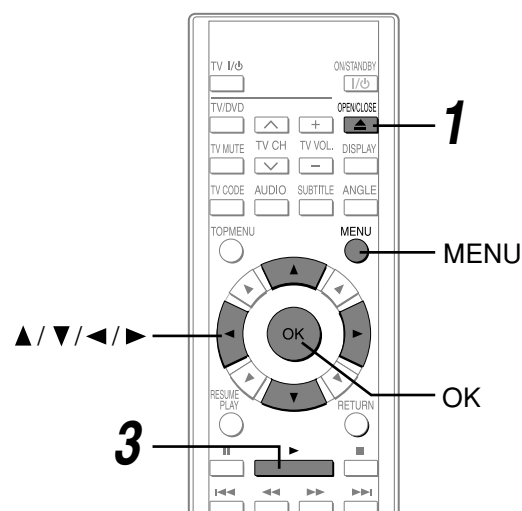
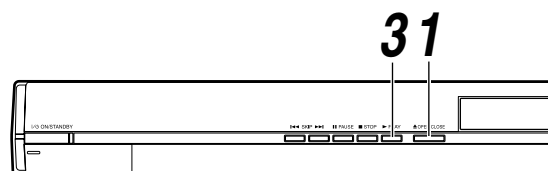

HD DVD DVD-Video

If a loaded disc contains a top menu, a top menu appears when you start playback.

Select a title by ▲ / ▼ / ◀ / ▶ (or **number buttons**), then press **OK**.

Playback starts from chapter 1 of the selected title.

- Depending on the disc, you may need to press TOP MENU or MENU to display a top menu.

DVD-RW DVD-R

Discs recorded on personal devices such as DVD recorders may contain menus, on which items can be easily selected.

Press **MENU**, and select a title by ▲ / ▼ / ◀ / ▶, then press **OK**.

Playback starts from the selected item.

- Discs recorded in DVD VR mode display the recorded contents not in thumbnails but in a list. Select an item on the list and press OK button.

Notes

- Use the button on the front panel or the remote control to open and close the disc tray. Do not push or hold the disc tray while it is moving. Doing so may cause the player to malfunction.
- Do not load a disc which is unplayable, or any object other than a playable disc.
- Do not apply downforce to the disc tray. Doing so may cause the player to malfunction.
- If the disc tray stops while closing, the mechanical protection system of this player will open it. Do not force it to close. Doing so may damage the disc tray.
- If the disc tray will not open, turn the player off, and press OPEN/CLOSE on the front panel. This may turn the player on and open the disc tray. If it still won't open, contact TOSHIBA customer service.

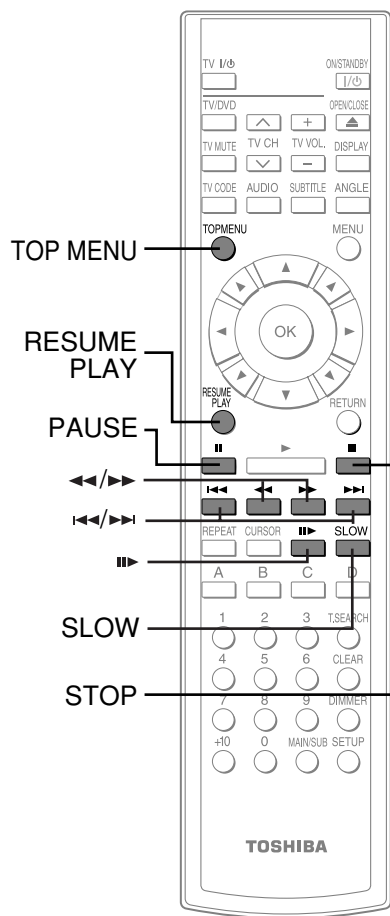

To pause playback

HD DVD DVD-Video DVD-RW DVD-R CD

Press **II** (PAUSE).

To resume press **▶** (PLAY).

To stop playback

HD DVD DVD-Video DVD-RW DVD-R CD

Press **■** (STOP).

To resume playback from the location last stopped

HD DVD DVD-Video DVD-RW DVD-R

After stopping playback, press **RESUME PLAY** (HD DVD) or **▶** (PLAY) (DVD-Video DVD-RW DVD-R CD).

If you want to return to the beginning, press **■** (STOP), then press **▶** (PLAY).

Notes

- Pressing **▶** (PLAY) after stopping playback then turning the power off may also resume playback from the location last stopped.
- Resume feature cannot function when:
 - you select a disc menu language (⇒ page 35) or change the parental lock setting (⇒ page 37).
 - you open the disc tray.
- There may be a difference in the location where playback resumes depending on the disc.
- It is possible to change the setting from the setup menu while the player retains a location in memory, however, the new setting can be valid only after the player clears the location memory, i.e., starts resume playback.
- Some discs or scenes may not permit this operation.
- While the ADV indicator on the front panel illuminates, this feature is not available.

To change playback speed

HD DVD DVD-Video DVD-RW DVD-R CD

Button	Function	Operation	To cancel
◀◀	Fast reverse playback	Pressing this button repeatedly changes the playback speed.	PLAY
▶▶	Fast forward playback	Pressing this button repeatedly changes the playback speed.	PLAY
SLOW*	Playing in slow-motion	Pressing this button repeatedly changes the playback speed.	PLAY
II▶**	Playing frame by frame	1 Press II to pause playback. 2 Press this button repeatedly.	PLAY
▶▶I	To skip to the next chapter/track	Press this button once.	-
I◀◀	To return to the previous chapter/track	Pressing this button once locates the beginning of the current chapter or track. Pressing this button twice locates the beginning of the previous chapter or track.	-
TOP MENU	To display a top menu	1 Press this button. 2 Press ▲/▼/◀/▶ to select a title. 3 Press OK.	TOP MENU

* Not available in CD playback.

**Some discs may not permit this operation.

Note

- If the player freezes for about 15 minutes or more and will not respond to any buttons, holding down ON/STANDBY button on the front panel for about 10 seconds can force the player to turn off. However, this is an emergency measure, which may cause damage to the player. Avoid casual use of this measure.

Playing (Continued)

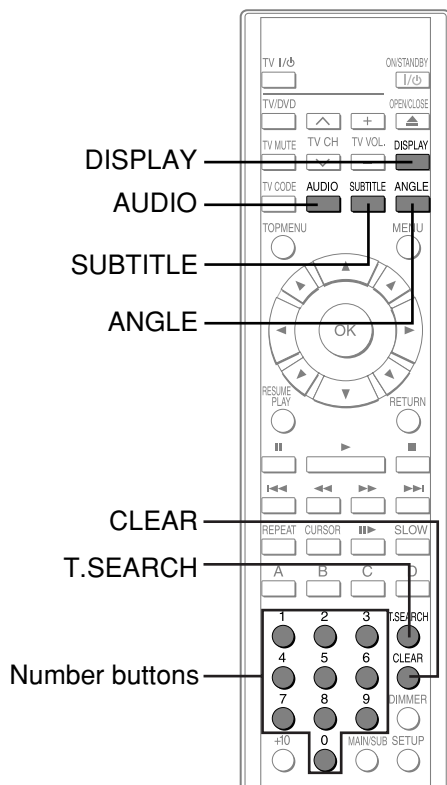

To select the sound

HD DVD DVD-Video DVD-RW DVD-R

If a disc contains several languages, you can select a preferred language from them to hear.

1 During playback, press AUDIO.

The current audio setting appears. (except for some HD DVD discs)

e.g. **Audio** **(English)1**

A language code (⇒ page 36) may appear.

2 Press AUDIO while the audio setting is displayed on the TV screen.

Notes

- Some discs allow you to change audio selections only via the disc menu. If this is the case, press MENU button and choose the appropriate language from the selections on the disc menu.
- When you turn on the player or replace a disc, the player returns to the initial default setting (⇒ page 35). Depending on a disc, a specific type of audio the disc has is output.
- Immediately after you have switched audio output modes, there may be a temporary discrepancy between the display and actual sound.

To select subtitles

HD DVD DVD-Video

You can display subtitles on the TV and select a subtitle language from those included on the disc.

1 During playback, press SUBTITLE.

The current subtitle setting appears. (except for some HD DVD discs)

e.g. **Subtitle** **(English)1** **Off**

A language code (⇒ page 36) may appear.

Each time you press ◀/▶, “On” and “Off” alternates. Select “On” to view subtitles.

2 Press SUBTITLE while the subtitle setting is displayed on the TV screen.

Subtitle languages which do not appear in the setting are not included in the disc.

Notes

- Some discs are set to display subtitles automatically.
- Depending on the scene, subtitles may not appear immediately after you set the subtitle function to on.
- Some discs will allow you to change subtitle languages and turn subtitles on or off only via the disc menu.
- When you turn on the player or replace a disc, the player returns to the initial default setting (⇒ page 35). Depending on a disc, a specific type of subtitles the disc has is output.
- Depending on the scene, the subtitle language may not change immediately after selected.

To select the camera angle

HD DVD DVD-Video

If the scene was recorded with multiple angles, you can easily change the camera angle of the scene you are watching.

1 While playing a scene recorded with multiple angles (angle icon (📷) displayed on the TV and the front panel), press ANGLE.

The current angle setting appears. (except for some HD DVD discs)

e.g. **Angle** **(1/6)**

Number of angles in the current title

Angle number

2 While the angle number is displayed, press ANGLE repeatedly to select the angle number.

Notes

- You can also change the camera angle during still playback. The camera angle changes to the new setting when you resume normal playback.
- If you pause a picture immediately after changing a camera angle, the resumed playback picture may not display the new camera angle.

To locate a position

HD DVD DVD-Video DVD-RW DVD-R CD

- 1 Press **T.SEARCH** repeatedly to select the category.

Category	To search by specifying:
Title	Title number
Chapter	Chapter number
Time	Elapsed time of the current title (track)
Track	Track number

- 2 Press the number buttons to enter a number.

e.g. To enter 25:

"2" → "5"

e.g. To enter 1 hour, 25 minutes, and 30 seconds:

"1" → "2" → "5" → "3" → "0"

Pressing **CLEAR** resets the numbers.

- 3 Press **OK**.

Playback starts from the specified location.

Notes

- Some discs may not permit these operations.
- While the **ADV** indicator on the front panel illuminates, these features are not available.

- 3 Press **OK**.

Repeat playback starts.

Notes

- Some discs may not permit repeat playback operation.
- You can cancel repeat playback also by pressing **■** (**STOP**).

To check the current status

HD DVD DVD-Video DVD-RW DVD-R CD

- 1 Press **DISPLAY**.

The following on-screen display appears.

HD DVD DVD-Video DVD-RW DVD-R

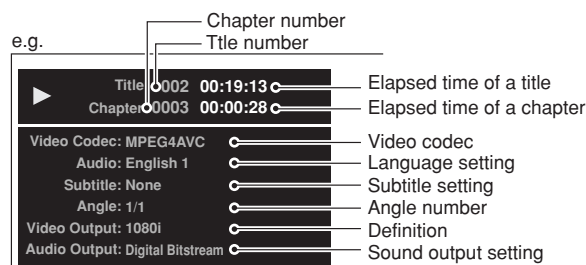

CD

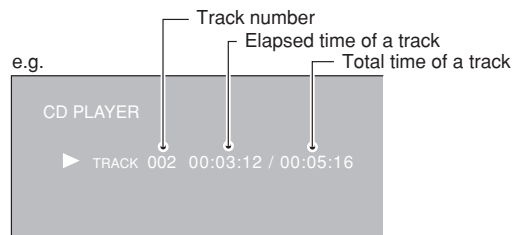

To play repeatedly

DVD-Video DVD-RW DVD-R CD

- 1 Press **REPEAT**.

The repeat modes are listed.

- 2 Press **▲** / **▼** to select the repeat mode.

(The selections on the list vary depending on category or status of a disc.)

Mode	To repeat:
All Repeat	Entire disc
Title Repeat	Current title
Chapter Repeat	Current chapter
Track Repeat	Current track
Disc Repeat	Entire disc
A-B Repeat	You can specify a segment to repeat. Select this and press OK . " A B Repeat A Point " appears. Perform steps 1) and 2) below, and skip step 3. 1) While the above display appears, press OK at a start point of a segment where you want to repeat. The display changes to " A B Repeat B Point ". • To cancel the setting, press RETURN . 2) Press OK at an end point of a segment where you want to repeat. Playback returns to the point A and repeats between A and B.

- 2 After confirming, press **DISPLAY** to turn off the display.

Playing (Continued)

HD DVD playing options in the future

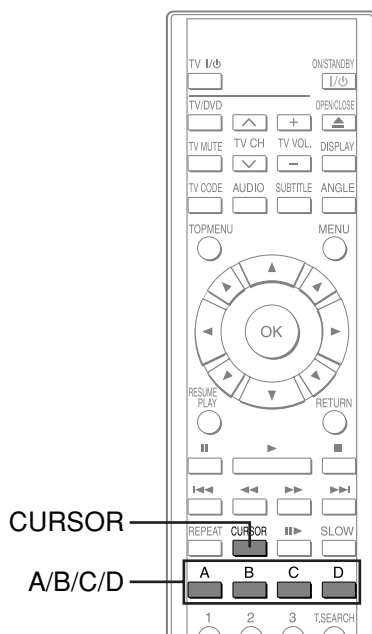

Extension port



A/B/C/D buttons

HD DVD

Use these buttons as indicated by the video display during HD DVD disc playback. Depending on the disc contents, the functions of each button may differ.

Cursor controls

HD DVD

Future HD DVD discs may include game software and drawing software. If they do you can use the cursor function for some software.

- 1 Press **CURSOR** while a disc with support for cursor use is playing.
- 2 Use the **eight direction buttons** to move the cursor.

Move the cursor to select the game target or selection item. For details on actual operations, also refer to the operations guide for the disc.

Controller port

HD DVD

The extension port may be used in the future for additional control options.

Requirements for HD DVD discs/Web-enabled network content

- An always-on broadband internet connection
- An HD DVD disc containing or having the capability of downloading studio-provided, web-enabled network content.

Notes

- To minimize any potential compatibility and/or connectivity issues, before attempting to view any studio-provided web-enabled, network content, it is recommended that you perform the firmware update process to ensure that your HD DVD player is using the latest firmware version.
- Toshiba is not responsible for any malfunction of the player and/or the internet connection feature due to communication errors/malfunctions associated with your broadband internet connection, or other connected equipment.
- Toshiba is not responsible for any trouble in your internet connection.
- If you wish to use a wireless network to connect the player, you will need to use a wireless LAN ethernet adapter to connect the player to the network.
- The features of HD DVD discs made available through the Internet Connection feature are not created or provided by Toshiba, and Toshiba is not responsible for their functionality or continued availability. Some disc related material available by the Internet Connection may not be compatible with this player. If you have questions about such content, please contact the producer of the disc.
- Some internet contents may require a higher bandwidth connection.
- Even if the player is properly connected and configured, some internet contents may not operate properly because of internet congestion, the quality or bandwidth of your internet service, problems at the provider of the content or compatibility issues.
- Some internet connection operations may not be possible due to certain restrictions set by the Internet service provider (ISP) supplying your broadband Internet connection.
- Any fees charged by an ISP including, without limitation, connection charges are your responsibility.
- A 10 Base-T or 100 Base-TX LAN port is required for connection to this player. If your internet service does not allow for such a connection, you will not be able to connect the player.
- A DSL modem is required to use DSL service and a cable modem is required to use cable modem service. Depending on the access method of and subscriber agreement with your ISP, you may not be able to use the internet connection feature contained in this player or you may be limited to the number of devices you can connect at the same time. (If your ISP limits subscription to one device, this player may not be allowed to connect when a PC is already connected.)
- The use of a "Router" may not be allowed or its usage may be limited depending on the policies and restrictions of your ISP. For details, contact your ISP directly.

Output sound conversion table

Disc	ADV indicator	Audio format	"Digital Out SPDIF"		"Digital Out HDMI"		
			Bitstream	PCM	Auto	PCM ²	Downmixed PCM
HD DVD Video Advanced content	ADV	DD Plus/Dolby TrueHD	Dolby Bitstream	2ch PCM	Depend on HDMI receiver	up to 5.1ch PCM ³	2ch PCM ¹
		dts-HD/L-PCM	DTS Bitstream	2ch PCM			
HD DVD Video Standard content	(off)	DD plus	Bitstream	2ch PCM	Depend on HDMI receiver	up to 5.1ch PCM ²	2ch PCM
		True HD 48kHz	Dolby Bitstream	2ch PCM	Depend on HDMI receiver	up to 5.1ch PCM	2ch PCM
		96kHz	Dolby Bitstream	2ch PCM ¹	Depend on HDMI receiver	up to 5.1ch PCM	2ch PCM ¹
		192kHz	Dolby Bitstream	2ch PCM ¹	Depend on HDMI receiver	2ch PCM ¹	2ch PCM ¹
		dts-HD	Bitstream	2ch PCM	Depend on HDMI receiver	up to 5.1ch PCM ²	2ch PCM
		L-PCM 48kHz	DTS Bitstream	2ch PCM	Depend on HDMI receiver	up to 5.1ch PCM	2ch PCM
		96kHz	DTS Bitstream	2ch PCM ¹	Depend on HDMI receiver	up to 5.1ch PCM ³	2ch PCM ¹
		192kHz	DTS Bitstream	2ch PCM ¹	Depend on HDMI receiver	2ch PCM ³	2ch PCM ¹
DVD-Video	(off)	MPEG	Bitstream	2ch PCM	Depend on HDMI receiver	2ch PCM	2ch PCM
		DD	Bitstream	2ch PCM	Depend on HDMI receiver	up to 5.1ch PCM	2ch PCM
		L-PCM 48kHz	2ch PCM	2ch PCM	2ch PCM	2ch PCM	2ch PCM
		96kHz	2ch PCM ¹	2ch PCM ¹	2ch PCM	2ch PCM ³	2ch PCM ¹
		dts	Bitstream	2ch PCM	Depend on HDMI receiver	up to 5.1ch PCM	2ch PCM
CD	(off)	MPEG	Bitstream	2ch PCM	Depend on HDMI receiver	2ch PCM	2ch PCM
		L-PCM 44.1kHz	2ch PCM	2ch PCM	2ch PCM	2ch PCM	
		dts 44.1kHz	Bitstream	2ch PCM	Depend on HDMI receiver	up to 5.1ch PCM	2ch PCM
DVD-VR	(off)	DD	Bitstream	2ch PCM	Depend on HDMI receiver	2ch PCM	2ch PCM
		L-PCM	2ch PCM	2ch PCM	2ch PCM	2ch PCM	
		MPEG	Bitstream	2ch PCM	Depend on HDMI receiver	2ch PCM	2ch PCM

Disc	ADV indicator	Audio format	ANALOG AUDIO OUTPUT 5.1CH SURROUND
HD DVD Video Advanced content	ADV	DD Plus/Dolby TrueHD	up to 5.1ch PCM
		dts-HD/L-PCM	up to 5.1ch PCM
HD DVD Video Standard content	(off)	DD plus	up to 5.1ch PCM
		True HD 48kHz	up to 5.1ch PCM
		96kHz	up to 5.1ch PCM
		192kHz	2ch PCM
		dts-HD	up to 5.1ch PCM
		L-PCM 48kHz	up to 5.1ch PCM
		96kHz	up to 5.1ch PCM
		192kHz	2ch PCM
DVD-Video	(off)	MPEG	2ch PCM
		DD	up to 5.1ch PCM
		L-PCM 48kHz	2ch PCM
		96kHz	2ch PCM
		dts	up to 5.1ch PCM
CD	(off)	MPEG	2ch PCM
		L-PCM 44.1kHz	2ch PCM
		dts 44.1kHz	up to 5.1ch PCM
DVD-VR	(off)	DD	2ch PCM
		L-PCM	2ch PCM
		MPEG	2ch PCM

1: Downsampled PCM.

2: Up to 5.1 channel PCM audio output is possible only when the connected device supports multi channel output.

3: This output format is possible when the resolution setting is "720p", "1080i" or "1080p". When the resolution setting is set to "480p/576p", this output format depends on HDMI receiver.

Notes

- The main title content of most movie HD DVD discs is "advanced content". The player turns on the ADV indicator when an HD DVD disc which includes such content is loaded.
- The DIGITAL AUDIO OUTPUT BITSTREAM/PCM jack may not output sound you select. In this instance, set "Digital Out SPDIF" to "PCM".
- The ANALOG AUDIO OUTPUT jacks always output 2ch sound only.

Customizing the function settings

You can change the default settings to customize performance to your preference.

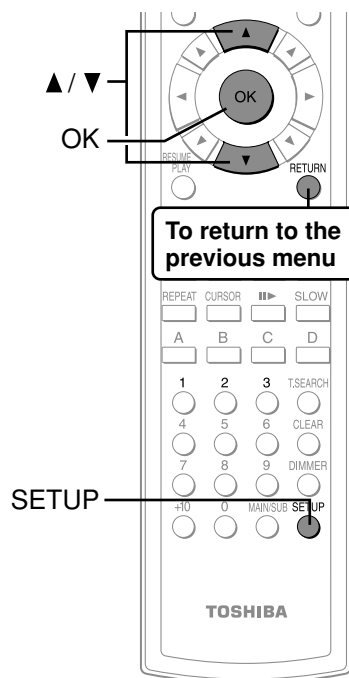

- 1** During stop, press **SETUP**.
"SETUP MENU" appears.
- 2** Press **▲ / ▼** to select the group that contains a desired item, then press **OK**.
- 3** Press **▲ / ▼** to select the setting item, then press **OK**.
- 4** Refer to the explanations on pages beginning from 33, to change the selection by **▲ / ▼** or other buttons, then press **OK**.
- 5** Repeat step 3 and 4 to set other items if necessary.
- 6** Press **SETUP**.
"SETUP MENU" disappears and the setting is completed.

Group	Setting	Disc	Details	Page
Picture	TV Shape	HD DVD DVD-Video DVD-RW DVD-R CD	To select a picture size according to the aspect ratio of your TV.	33
	RGB Output Range	HD DVD DVD-Video DVD-RW DVD-R	To select the RGB range according to the capacity of the connected DVI monitor.	33
	Picture Mode	HD DVD DVD-Video DVD-RW DVD-R	To select the system of output signal corresponding to playback source. (Only when connected to a PROGRESSIVE TV.)	34
	Resolution Setting	HD DVD DVD-Video DVD-RW DVD-R	To select the resolution of the player's output, according to the connected TV.	21
Audio	Digital Out SPDIF	HD DVD DVD-Video DVD-RW DVD-R CD	To select the output sound format when connecting the DIGITAL AUDIO OUTPUT jack.	22
	Digital Out HDMI	HD DVD DVD-Video DVD-RW DVD-R CD	To select the output sound format when connecting the HDMI OUTPUT jack.	22
	Digital Direct Audio Mode	HD DVD	To output high bitrate audio to a connected amplifier equipped with Dolby Digital Plus, Dolby TrueHD or DTS-HD decoder.	34
	Dynamic Range Control	HD DVD DVD-Video DVD-RW DVD-R	To turn on or off a function that makes faint sounds easier to hear even if you lower the volume during late-hour playback.	34
	Dialog Enhancement	HD DVD DVD-Video DVD-RW DVD-R	To turn on or off a function that increases dialog volume of a disc playback.	35
	Speaker Setting	HD DVD DVD-Video DVD-RW DVD-R CD	To select various parameters for the analog 5.1ch output.	23
Language	Disc Menu Language	HD DVD DVD-Video	To select a preferred language for disc menus.	35
	Subtitle Language	HD DVD DVD-Video	To select a preferred language for subtitles.	35
	Audio Language	HD DVD DVD-Video	To select a preferred language for the sound track.	35
	On Screen Language	HD DVD DVD-Video DVD-RW DVD-R CD	To select a preferred language for on-screen displays.	35
Ethernet		HD DVD	To set up internet connection feature.	24

Group	Setting	Disc	Details	Page
General	Parental Lock	HD DVD DVD-Video	To turn the parental lock function on or off.	37
	Clock Set	HD DVD DVD-Video DVD-RW DVD-R CD	To set the clock of the player.	20
	OSD On/Off	HD DVD DVD-Video DVD-RW DVD-R CD	To activate or deactivate the operational status display on the TV screen.	38
	Remote Controller Sound	HD DVD DVD-Video DVD-RW DVD-R CD	To turn on or off the confirmation beeper announcing when each remote command is received.	38
	HDMI Control	HD DVD DVD-Video DVD-RW DVD-R CD	To turn on or off the features offered with CEC (Consumer Electronics Control).	38
	Maintenance	HD DVD DVD-Video DVD-RW DVD-R CD	To reset player options to factory defaults or check for firmware updates.	38
	Twin Format Disc	HD DVD	To select the layer to play of an HD DVD Twin Format Disc. (Not available while a disc is loaded.)	38

Settings

Picture

Note

- Actual effects of these settings may vary depending on performance of connected device.

TV Shape	
16:9	Select when a 16:9 wide TV is connected.
4:3	Select when a standard 4:3 TV is connected. Displays pictures cropped to fill your TV screen. Both of the picture's sides are cut off.
4:3 Letter Box	Select when a standard 4:3 TV is connected. Displays theatrical images with masking bars above and below the picture.

Notes

- When an HD DVD disc or a DVD video disc has a particular available picture shape, the contents may not be compatible with other picture shapes.
- DVD video discs containing 4:3 picture only always display 4:3 pictures regardless of this setting.
- If "16:9" is selected while connecting a 4:3 TV, playback pictures may be distorted horizontally or shrink vertically. Make this setting according to your TV shape.
- Actual picture shape may depend on signal types of broadcasts or input sources, or settings on the connected TV. Refer to the owner's manual of your TV.

RGB Output Range	
Standard	For a monitor of RGB range 16-235.
Enhanced	For a monitor of RGB range 0-255.

Note

- If "Standard" pales black of "Enhanced" blackens too much, change the setting.

(Continued)

Customizing the function settings (Continued)

Picture Mode

There are two types of source content in pictures recorded in DVD video discs: film content (pictures recorded from films at 24 frames per second) and video content (video signals recorded at 25 frames in PAL (30 frames in NTSC) per second). Make this selection according to the type of content being viewed.

Film	The player converts film content pictures in the progressive output format appropriately. Suitable for playback of film content pictures.
Video	The player filters video signal, and converts it in the progressive output format appropriately. Suitable for playback of video content pictures.
Auto	Select this position normally. The player automatically detects source content, film or video, of playback source, and converts that signal in the progressive output format in an appropriate method.

Note

- The player may not be able to detect the source (film or video) of some material. If you notice undesirable picture performance, try selecting "Film" or "Video".

Resolution Setting

See ⇒ page 21.

Audio

Digital Out SPDIF

See ⇒ page 22.

Digital Out HDMI

See ⇒ page 22.

Digital Direct Audio Mode

To output high bitrate audio to a connected amplifier equipped with Dolby Digital Plus, Dolby TrueHD or DTS-HD decoder.

On	High bitrate audio output is enabled. (Sub audio and effect audio are disabled.)
Off	High bitrate audio output is disabled.

Notes

- This selection is available only when the player is connected to an amplifier equipped with Dolby Digital Plus, Dolby TrueHD or DTS HD decoder.
- To obtain high bitrate audio output, "Digital Out HDMI" (⇒ page 22) needs to be set to "Auto".

Dynamic Range Control

To turn on or off a function that makes faint sounds easier to hear even if you lower the volume during late-hour playback.

Auto	While playing an HD DVD video disc recorded in Dolby TrueHD format, this function will be automatically activated or disabled according to certain command included in the content. For other discs, this function is activated.
On	This function is activated.
Off	This function is disabled.

Notes

- This function is effective only in playback of HD DVD or DVD video discs recorded in Dolby Digital, Dolby Digital Plus or Dolby TrueHD format.
- The effect level of this function vary depending on the disc.
- Not effective in Dolby TrueHD 96 kHz 5.1 channel sound.

Dialog Enhancement

To turn on or off a function that increases dialog volume of a disc playback.

On	This function is activated.
Off	This function is disabled.

Notes

- This function is effective only in playback of Dolby Digital recorded HD DVD or DVD video discs.
- The effect level of this function vary depending on the disc.

Speake Setting

See ⇒ page 23.

Language

Disc Menu Language

To select a preferred language for disc menus.

English / French / German / Spanish / Italian / Dutch / Russian / Swedish / Finnish / Greek / Turkish	
Other	To make a further language choice. Refer to “How to select a language” (⇒ page 36).

Note

- Some discs may be played in a different language from that you selected, as the disc may contain alternate language.

Subtitle Language

To select a preferred language for subtitles.

English / French / German / Spanish / Italian / Dutch / Russian / Swedish / Finnish / Greek / Turkish	
None	To disable subtitles.
Other	To make a further language choice. Refer to “How to select a language” (⇒ page 36).

Notes

- Some discs may be set to display subtitles in a different language from that you selected, as the disc may contain alternate language.
- Some discs allow you to change subtitle selections only via the disc menu. In this case, press MENU button and choose the appropriate subtitle language from the selection on the disc menu.

Audio Language

To select a preferred language for the sound track.

English / French / German / Spanish / Italian / Dutch / Russian / Swedish / Finnish / Greek / Turkish	
Other	To make a further language choice. Refer to “How to select a language” (⇒ page 36).

Note

- Some discs may be played in a different language from that you selected, as the disc may contain alternate language.

On Screen Language

To select a preferred language for on-screen displays.

English / French / German / Spanish / Italian / Dutch / Russian / Swedish / Finnish / Greek / Turkish	
--	--

Customizing the function settings (Continued)

How to select a language:

- 1) Obtain the code from the list below.
- 2) Enter the code as below.
- 3) Select "OK" and press OK button.

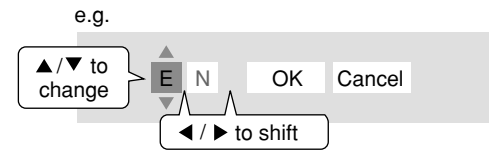

Language code list

Code	Language	Code	Language	Code	Language	Code	Language	Code	Language
---	No alternate language	DZ	Bhutani	KS	Kashmiri	SA	Sanskrit	VI	Vietnamese
		EL	Greek	KU	Kurdish	SD	Sindhi	VO	Volapük
CHI (ZH)	Chinese	EO	Esperanto	KY	Kirghiz	SG	Sango	WO	Wolof
DUT (NL)	Dutch	ET	Estonian	LA	Latin	SH	Serbo-Croatian	XH	Xhosa
ENG (EN)	English	EU	Basque	LN	Lingala	SI	Singhalese	YO	Yoruba
FRE (FR)	French	FA	Persian	LO	Laotian	SK	Slovak	ZU	Zulu
GER (DE)	German	FI	Finnish	LT	Lithuanian	SL	Slovenian		
ITA (IT)	Italian	FJ	Fiji	LV	Latvian, Lettish	SM	Samoan		
JPN (JA)	Japanese	FO	Faroese	MG	Malagasy	SN	Shona		
KOR (KO)	Korean	FY	Frisian	MI	Maori	SO	Somali		
MAY (MS)	Malay	GA	Irish	MK	Macedonian	SQ	Albanian		
SPA (ES)	Spanish	GD	Scottish Gaelic	ML	Malayalam	SR	Serbian		
AA	Afar	GL	Galician	MN	Mongolian	SS	Siswati		
AB	Abkhazian	GN	Guarani	MO	Moldavian	ST	Sesotho		
AF	Afrikaans	GU	Gujarati	MR	Marathi	SU	Sundanese		
AM	Amharic	HA	Hausa	MT	Maltese	SV	Swedish		
AR	Arabic	HI	Hindi	MY	Burmese	SW	Swahili		
AS	Assamese	HR	Croatian	NA	Nauru	TA	Tamil		
AY	Aymara	HU	Hungarian	NE	Nepali	TE	Telugu		
AZ	Azerbaijani	HY	Armenian	NO	Norwegian	TG	Tajik		
BA	Bashkir	IA	Interlingua	OC	Occitan	TH	Thai		
BE	Belorussian	IE	Interlingue	OM	(Afan) Oromo	TI	Tigrinya		
BG	Bulgarian	IK	Inupiak	OR	Oriya	TK	Turkmen		
BH	Bihari	IN	Indonesian	PA	Panjabi	TL	Tagalog		
BI	Bislama	IS	Icelandic	PL	Polish	TN	Setswana		
BN	Bengali, Bangla	IW	Hebrew	PS	Pashto, Pushto	TO	Tongan		
BO	Tibetan	JI	Yiddish	PT	Portuguese	TR	Turkish		
BR	Breton	JW	Javanese	QU	Quechua	TS	Tsonga		
CA	Catalan	KA	Georgian	RM	Rhaeto-Romance	TT	Tatar		
CO	Corsican	KK	Kazakh	RN	Kirundi	TW	Twi		
CS	Czech	KL	Greenlandic	RO	Rumanian	UK	Ukrainian		
CY	Welsh	KM	Cambodian	RU	Russian	UR	Urdu		
DA	Danish	KN	Kannada	RW	Kinyarwanda	UZ	Uzbek		

Ethernet

See ⇨ page 24.

General

Parental Lock

HD DVD and DVD video discs equipped with the Parental Lock function have a predetermined limitation level. The limitation level or limitation method may differ depending on the disc. For example the whole contents of a disc may not be played back, or an extreme violent scene may be cut or replaced automatically by another scene.

Important

- Depending on discs, it may not be evident whether the disc is compatible with Parental Lock function. Make sure that Parental Lock function you set is activated correctly.

1 Enter a 4-digit password by using the number buttons, then press OK button.

When you use the player for the first time, set a new password of 4-digit. If you make a mistake entering your password, press CLEAR button before pressing OK button, and re-enter the correct password.

2 Set the details.

a) Select "On" or "Off" by pressing ▲ / ▼ buttons.

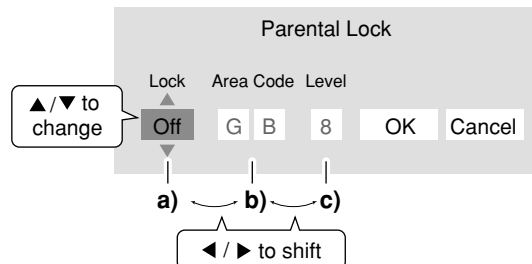

On

Select this to activate Parental Lock function or to change the setting.

Off

Deactivates the Parental Lock function. Skip b) and c) to go to 3.

b) Enter the code of a country/area whose standards were used to rate a disc, referring to the list below.

Country/Area	Code	Country/Area	Code	Country/Area	Code
AUSTRALIA	AU	INDONESIA	ID	SPAIN	ES
BELGIUM	BE	ITALY	IT	SWEDEN	BE
CANADA	CA	JAPAN	JP	SWITZERLAND	CH
CHINA	CN	MALAYSIA	MY	TAIWAN	TW
CHINA HONG KONG	HK	NETHERLANDS	NL	THAILAND	TH
DENMARK	DK	NORWAY	NO	UNITED KINGDOM	GB
FINLAND	FI	PHILIPPINES	PH	UNITED STATES	US
FRANCE	FR	RUSSIAN FEDERATION	RU		
GERMANY	DE	SINGAPORE	SG		

c) Select the desired limitation level.

Unless the Parental Lock function is set to "Off", a disc that has a higher limitation level than your selected limitation level cannot be played back. For example, if you select level 7, discs exceeding level 8 are locked and cannot be played back.

When "US" is selected, its limitation level corresponds to the following settings.

Level 7: NC-17 Level 6: R Level 4: PG13 Level 3: PG Level 1: G

3 Select "OK" then press OK button.

■ To change the limitation level of Parental Lock function

Follow steps 1 - 3 above.

■ To change the password

1 At step 1, press STOP button 4 times then press OK button.

The password is cleared.

2 Enter a new 4-digit password by using the number buttons.

3 Press OK button.

Customizing the function settings (Continued)

Clock Set

See ⇨ page 20.

OSD On/Off

To activate or deactivate the operational status display on the TV screen.

On	Activates the operational status display (e.g., ►) on the TV screen.
Off	Deactivates the operational status display (e.g., ►) on the TV screen.

Remote Controller Sound

To turn on or off the confirmation beeper announcing when each remote command is received.

On	Turns on the beep sound.
Off	Turns off the beep sound.

HDMI Control (REGZA-Link)

To turn on or off the features offered with CEC (Consumer Electronics Control) when an HDMI device is connected to this player. Use of HDMI Control which is a feature based on HDMI-CEC requires an HDMI-CEC compatible display device.

Enable HDMI control	Select "On" to control this player using the remote control of your TV. To disable this function, select "Off".
OneTouchPlay	(Only when "Enable HDMI control" is set to "On") Select "On" to turn the connected TV on if it is off and set its input to the player automatically to display the player's picture, by pressing one of ► (PLAY), MENU, RESUME PLAY, TOP MENU buttons. To disable this function, select "Off".
SystemStandby	(Only when "Enable HDMI control" is set to "On") Select "On" to turn off both the player and the connected TV from the TV's remote control. To disable this function, select "Off".

When complete, select "OK" then press OK button.

Notes

- Depending on the specifications of your TV, this function does not work even when your TV is HDMI-compatible.
- All the above features may not always work on all compatible TVs.

Maintenance

Initialize	To reset all the settings listed on ⇨ page 30, 31 to factory set default. Press ◀ / ▶ buttons to select "Yes" then press OK button.
Update (Firmware update)	If you have a broadband internet service, you may obtain firmware update over the internet using the LAN port on the back of your player. <ul style="list-style-type: none"> • BEFORE BEGINNING THE FIRMWARE UPDATE PROCESS, BE SURE TO REMOVE ANY DISCS FROM YOUR PLAYER. Please configure the LAN port (⇨ page 17). You may need to turn on DHCP and DNS (⇨ page 24). • Press SETUP and select "General" > "Maintenance". Follow the instructions on the screen. • If a firmware update is available for your player, the player will download it. Once the firmware update download process has finished, the player's power will automatically switch off. You must wait until this process has finished. • DO NOT UNPLUG, TURN OFF, OR USE ANY OTHER FEATURE OF YOUR PLAYER DURING THE FIRMWARE UPDATE PROCESS. Doing so will cause the writing of the firmware update to the player to be halted and the player may no longer operate properly. If the player stops working, please contact Toshiba customer service for your country or http://www.highdefinitiondvd.eu/. • If no firmware update is available, the player will quickly exit the firmware update process.
Persistent Storage	To open the menu to control player's memory allocated for content. (Not available while a disc is loaded.) The menu selections will vary depending on the content. Operate following the instructions displayed on your screen.

Twin Format Disc

To select a layer to play, HD DVD or DVD of an HD DVD Twin Format Disc. (Not available if a disc is loaded.)

HD DVD	Only the HD DVD layer is played.
DVD	Only the DVD layer is played.

Note

- For combination discs, select the desired version by disc side (see label for information).

Before calling service personnel

Before accessing, try updating this player's firmware. For details on how to update, see "Update (Firmware update)" (⇒ page 38).

If you experience any of the following difficulties while using this unit, check the list below before consulting your nearest Toshiba dealer.

Symptom	Remedy	Page
No power.	<ul style="list-style-type: none"> Is the power plug disconnected? Check the power connection. 	17
No picture.	<ul style="list-style-type: none"> Is the cable for connecting the player and TV disconnected or not connected properly? Check the connections. 	15
	<ul style="list-style-type: none"> Switch the input of the connected TV to the signal from the player. 	—
	<ul style="list-style-type: none"> Are both the HDMI OUTPUT jack and the COMPONENT VIDEO OUTPUT jacks connected simultaneously? Select either connection and make the appropriate setting. 	15
	<ul style="list-style-type: none"> In case the menu of "Resolution Setting" disappears, make composite video (yellow) connection to restore it, then select the resolution which is compatible with the connected TV. 	21
No sound.	<ul style="list-style-type: none"> Is the audio cable disconnected? 	14, 16
	<ul style="list-style-type: none"> Is the volume of the device turned down to the minimum level? Check the volume. 	—
	<ul style="list-style-type: none"> Switch the audio input of the device connected by the audio cable to the input from the player. 	—
	<ul style="list-style-type: none"> Set "Digital Out SPDIF" or "Digital Out HDMI" properly in accordance with the connected device and connection procedure. 	22
	<ul style="list-style-type: none"> Change the output resolution so that sound can be heard. 	21
	<ul style="list-style-type: none"> If using the optical digital output for a Dolby Digital Plus, Dolby TrueHD, DTS-HD or DTS soundtrack, be sure your AV receiver or processor is set to use the input connected to your player and is set to decode a DTS bitstream. If your AV receiver or processor does not support DTS, select PCM output on the player. 	22
Sounds of sub pictures such as commentaries and/or accessory sounds in menu operation cannot be heard.	<ul style="list-style-type: none"> "Digital Direct Audio Mode" > "On" is selected. To obtain these sounds, select "Off". 	34
The disc does not play.	<ul style="list-style-type: none"> Make sure the disc type can be played with the player. 	8
	<ul style="list-style-type: none"> Is the disc dirty or scratched? Check or clean the disc. 	8
	<ul style="list-style-type: none"> If the disc is a DVD-RW or DVD-R disc, finalize the disc before attempting to play it with the player. 	—
	<ul style="list-style-type: none"> If the disc includes parent lock support, playback is restricted while the parent lock of the player is set. Cancel Parental Lock or change the restriction level. 	37
Playback picture has noise.	<ul style="list-style-type: none"> If video from the player is watched via a video recorder or on a TV with a built-in video recorder, the copy guard may prevent images from being displayed properly. Be sure to connect the player directly to the TV. 	15
Playback picture does not move smoothly.	<ul style="list-style-type: none"> "Resolution Setting" > "up to 1080p/24Hz" is selected. Change the setting. 	21
The remote control does not work.	<ul style="list-style-type: none"> Are the batteries of the remote control dead? Replace the batteries. 	12
	<ul style="list-style-type: none"> Make sure the remote control is within range and pointed in the correct direction. 	12
HDMI Control (REGZA-Link) does not work.	<ul style="list-style-type: none"> Make sure the HDMI cable is firmly connected, then turn on both the TV and the player again. 	38
Screen freezes and no buttons work.	<ul style="list-style-type: none"> Pressing ON/STANDBY button on the player for approximately ten seconds forces the player to turn off. Turn the player off and then on again. 	—
After powering on, "Clock Set" menu appears.	<ul style="list-style-type: none"> The power supply to the player may have been disconnected. Reset the clock. 	20

Specification

- **Power requirement**
36.0W
- **Power supply**
220 - 240V AC 50/60Hz
- **Mass**
3.3kg
- **External dimension**
Width 430 x Height 59.5 x Depth 327mm
- **Signal system**
Standard PAL/NTSC colour system
- **Laser**
Semiconductor laser
Wavelength: 405nm/650nm/780nm
- **VIDEO output**
1.0Vp-p (75Ω), Sync signal negative,
Pin jack x 1 system
- **Component output (Y, P_B, P_R)**
Y output (green), 1.0Vp-p (75Ω),
Pin jack x 1 system
P_B, P_R output (blue, red), 0.7Vp-p (75Ω),
Pin jack x 1 system each
- **Analog audio output**
2.0V (rms), 2.2kΩ or below, pin jack
(L, R) x 1 system
2.0V (rms), 2.2kΩ or below, pin jack x 6
- **Digital audio output (BITSTREAM/PCM jack)**
Optical connector x 1 system
- **LAN port**
100BASE-TX/10BASE-T x 1
- **Extension port**
1 system
- **HDMI output**
19 pin, Type A connector
- **Remote control**
Wireless remote control (SE-R0252-WEEE)
- **Operating conditions**
Temperature: 41°F ~ 95°F (5°C ~ 35°C)
Position: Horizontal
- **Clock accuracy**
Quartz (monthly deviation: approximately ±30 seconds)

- Designs and specifications are subject to change without notice.
- This model may not be compatible with features and/or specifications that may be added in the future.
- The illustrations and screens described in this manual may be exaggerated or simplified for easy recognition and may be slightly different from the actual unit.

INFORMATION ON CUSTOMER SUPPORT

HD DVD is a new and evolving format, so changes and improvements are possible. To obtain updated information about HD DVD and this product, as well as customer support information about this product, please contact Toshiba customer service for your country or <http://www.highdefinitiondvd.eu/>.

©2007 TOSHIBA CORPORATION



Printed on 70% Recycled Paper

TOSHIBA

Printed in China
GX1D00001780

