

To begin

About your device

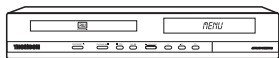

DTH 8640 → 80 Gb

DTH 8650 → 160 Gb

Your DVD recorder is a digital video player and recorder. Thanks to its tuner you can record TV programmes on DVD R/RW (DVD +R/-R/+RW/-RW) discs or on the integrated hard disc. It can play the majority of 8 cm and 12 cm discs, with the exception of DVD Ram and DVD audio.

Precautions to take

- Ensure that the mains supply in your house complies with that indicated on the identification sticker located at the back of your device
- Install your device horizontally, on a suitable base (furniture), with enough space around it for ventilation (7 to 10 cm)
- Ensure that the ventilation slots, and the device itself, are not covered by objects such as a mat, newspapers, curtain, etc.
- Do not stack any other equipment on top of your DVD recorder
- Do not place the device on top of an amplifier or any other equipment that gives off heat
- The appliance should not be in contact with liquids or exposed to the risk of dripping or splashing. Therefore be careful not to place any object containing a liquid (vase, glass, bottle, ...) on or near your appliance
- The DVD recorder must not be near or exposed to a flame. For instance, do not place a candle on or near the device
- Protect the DVD recorder from moisture and excess heat (e.g. fireplace) or equipment creating strong magnetic or electric fields (i. e. speakers...).

Before moving the DVD recorder, ensure the disc tray is empty. Switching off the DVD recorder to the stand-by mode does not disconnect the electricity supply. In order to separate the device completely from the mains, it has to be disconnected by unplugging the mains plug; this is recommended if you haven't used the device for a certain time. When connecting, ensure that the plugs of the various cables are pushed securely into their corresponding sockets. Your DVD recorder is not intended for industrial use but for domestic purposes only. Use of this product is for personal use only. Copying CDs or downloading music files for sales or other business purpose is or may be a violation of copyright law.

Important: Please read the recommendations given on the last page.



The content in brief...

- **Connections and initial set up3**
Basic connections - Other Audio-Video connections - Your recorder's front panel - Main messages on the display - About other displays (menus and banners)
- **Recording functions8**
Watching TV programmes - Taking a break (Time Shift function) - Recording the current programme - Programming a recording or transfer - Programming a transfer - Automatic programming (Naviclick) - Recording from a connected device - Library
- **Playing a disc16**
Playable discs - Interactive banners - Loading and playing a disc - Displaying banners - Playing images and sounds (JPEG, mp3, wma) - Playing DivX files
- **Menus25**
The Disc menu - Playlist - Title functions - Disc options - Recording options menu - Language selection - Parental check - Naviclick settings
- **Further information34**
Advice and information about discs - Troubleshooting - Other important information - Technical characteristics

**THIS DVD RECORDER LETS YOU RECORD TV PROGRAMMES
IN DIGITAL QUALITY AND ARCHIVE YOUR OWN VIDEOS
FROM VIDEO CAMERAS OR VHS CASSETTES TO DVD DISCS.**

**YOU CANNOT COPY PRE-RECORDED FILMS
TO DVD IF THEY HAVE BEEN COPY PROTECTED.**

Remote control

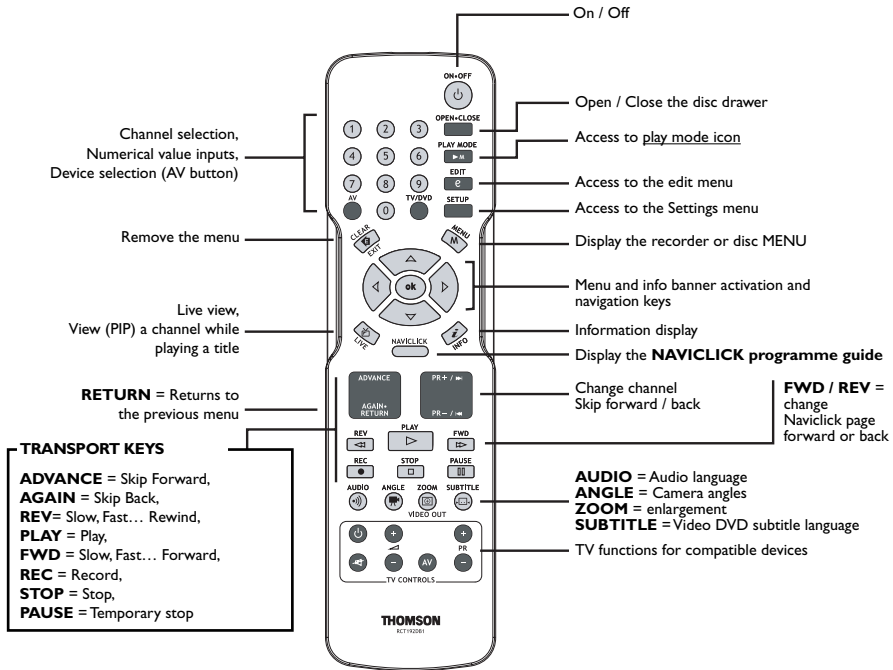

Inserting the batteries

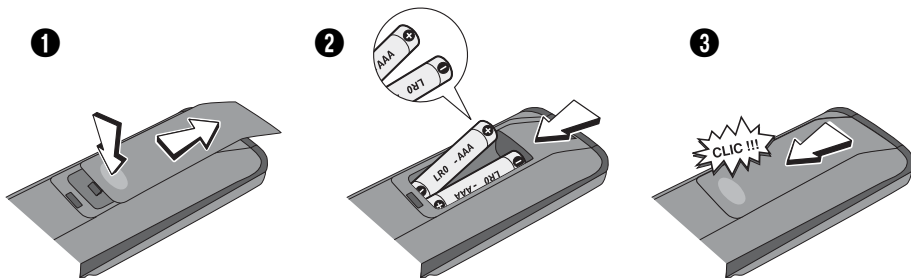

Important information about batteries

- Respect the polarities. Do not mix different types of batteries or new and old batteries. Do not use rechargeable batteries. Do not expose batteries to excessive heat, do not incinerate them and do not recharge them. Do not try to open them as they may leak or explode. Remove the batteries from the remote control unit if you are not going to use it for several weeks. Immediately remove any leaking batteries. Take care in doing this, as leaking batteries may cause burns to the skin or other physical injury.



- Please respect the environment and prevailing regulations! Before you dispose of batteries ask your dealer whether they are subject to special recycling and if he accepts to take them back.

Connections and initial set up

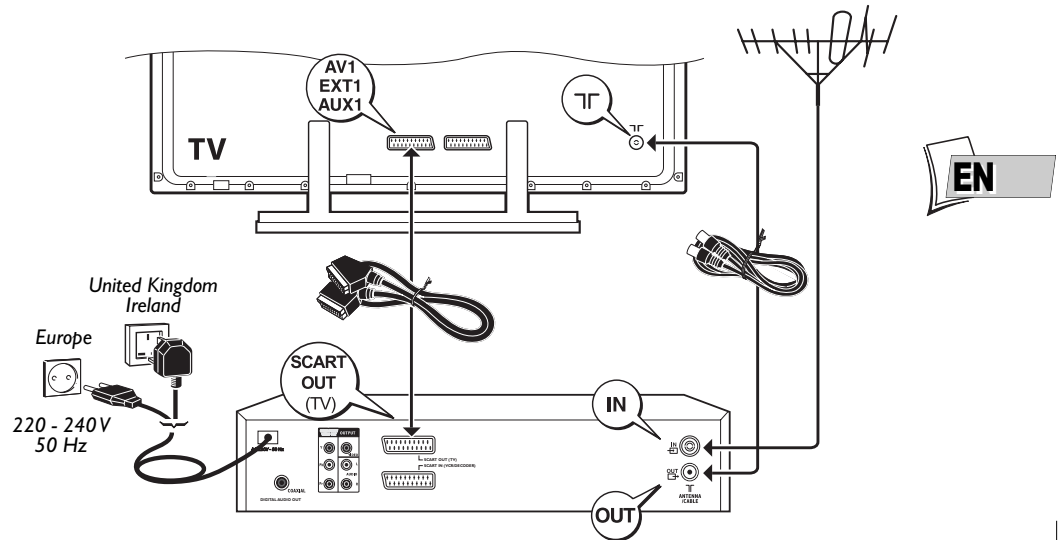

Automatic channel search

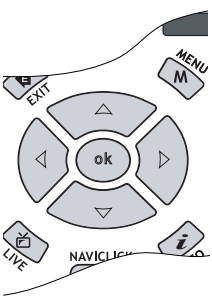

1. Turn on your TV set.
2. Press the recorder's **ON/STANDBY** key once. Wait a few seconds until the language menu appears. If this menu is not displayed, after a few seconds on your TV screen select the AV socket to which you connected your recorder.
3. Select a language with the **▼, ▲, OK** keys.
The language selection determines the language of the recorder's menus, but also the language for the dialogues and subtitles on DVD discs if the language selected is also offered by the discs being played.
4. Select your country of residence then the installation method using the **▼, ▲, OK** keys.
The channel set-up begins. Wait until the end of the channel search and continue set-up according to the indications which appear on the screen for the different steps.

Connections and initial set up

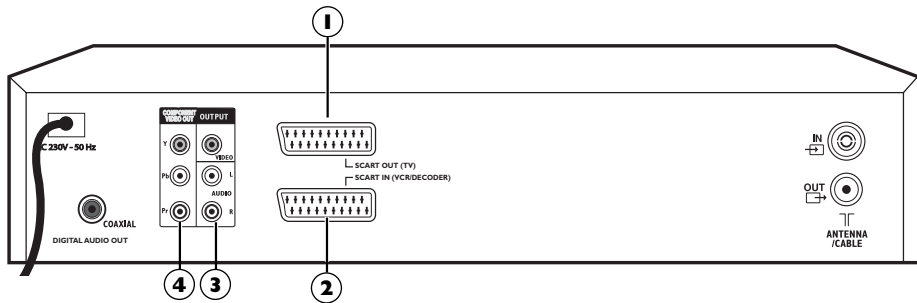

There are several ways in which you can incorporate your DVD player into an Audio-Video system. This depends on the sockets and other appliances you have. Sound and image quality depend to a large extent on the types of connections used.

Familiarise yourself with the characteristics of the different sockets on your recorder. If you cannot use Scart-Peritel sockets, the following explanations pages should enable you to choose the method of connection best suited to the sockets and appliances you have.

1 - SCART OUT (TV) (Audio-Video outputs)



This socket allows you to transfer Audio and Video (sound and images) from your DVD recorder to a television set or other device (flat screen, audio-video amplifier, etc.) that is fitted with the same type of socket. This transfer is performed in **RGB** which ensures good image quality.

*Caution: If a YUV or PS video signal mode is selected, there will be no output signal on the SCART OUT (TV) socket, and therefore no image. To get an image (RGB video signal) on this socket, press the **ZOOM/VIDEO OUT** key one or more times on the remote controle to display **RGB ON**. The main menu must appear on the television screen (make sure that it is not switched off).*

2 - SCART IN (VCR/DECODER)

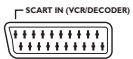

This socket allows to enter Audio Video (sound and images) from another device (video recorder or decoder) fitted with the same type of socket.

Note: the PÉritel socket is also known by the name of PÉritelévision or Scart. The latter is an abbreviation of « Syndicat des Constructeurs d'Appareils Radioélectriques et de Télévision ».

Connections and initial set up

Other Audio - Video connections

If there is no Peritel-Scart socket available on the television, check to see if there are any other Video sockets (Components, S-Video or Composite) to connect your player by using the corresponding sockets. In this case, do not forget to also connect the player's Audio outputs (**AUDIO OUT**) to the Audio input sockets (**AUDIO IN**) on your television.

3 - Audio - Video Output



Audio outputs (OUTPUT L, R), Composite Video Out socket (CVBS) (COMPOSITE VIDEO OUTPUT)

The analog sound and the composite images (CVBS) from a disc being read are permanently available at the two audio sockets, L and R, of your DVD recorder.



4 - Composite Video Outputs (Y, Pb, Pr) (YUV)

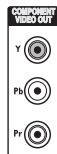

The **Y, Pb, Pr** sockets deliver an optimum image quality due to the separation of the video signal into three separate components (comparable with RGB separation in a Scart-Peritel cable). To obtain the best image quality possible, use very high quality cables for connections. Your dealer can provide YUV cables that are sold together and come in the standard colour codes (red, green and blue) used for these types of sockets and cables.

*Note: if you use the Composite sockets Y, Pb, Pr (also called YUV), you must configure the output video signal so that these sockets deliver either an interlaced YUV signal (**component interlaced**) or a progressive PS signal (**component progressive**). With the main menu displayed (STOP mode), press the **ZOOM/VIDEO OUT** key several times. The output video signal then switches from RGB to YUV then PS. The display then indicates **RGB** then **PS ON** (Progressive Scan) and **YUV ON**.*

Caution: do not forget to also connect the audio cables, because Component cables only transmit images, and not sound.

Connections and initial set up

The front of your player recorder

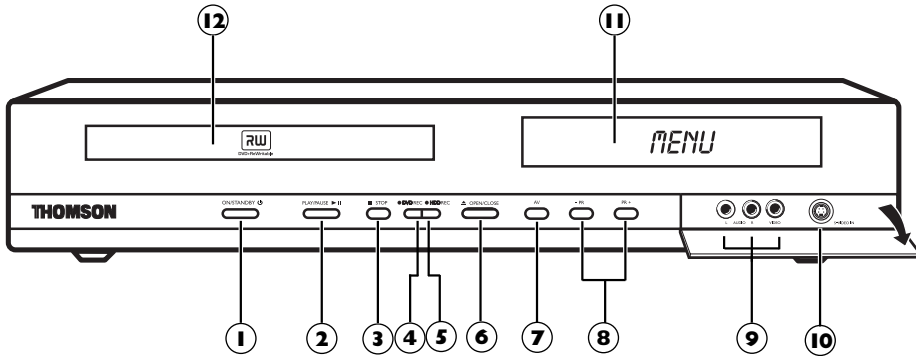

- ① On / Off
- ② Playback or freeze frame.
- ③ Stops the playback or recording.
- ④ **DVD REC** - To record to a DVD R/RW.
- ⑤ **HDD REC** - To record to the hard disc.
- ⑥ Open and close the drawer.
- ⑦ To select the audiovisual sources (appliances connected to the AV sockets):
AV 2 - Appliance connected to **SCART IN** (satellite received, decoder, etc.).
AV 3 - **AUDIO/VIDEO** sockets on the front panel.
- ⑧ Change channel or skip chapter.
- ⑨ The **AUDIO-VIDEO** sockets (inputs) allow the viewing or copying of your video sequences from a camcorder or any other AV device that provides a composite video signal and analogue stereo sound.
Note: View the images using the AV key.
- ⑩ **S-Video** socket (input) to connect a camcorder or any other S-Video device.
Note: do not forget to connect the audio cables since the S-Video socket handles only images and not sound. View the images using the AV key.
- ⑪ Displays your DVD recorder's modes of operation.
- ⑫ Disc tray.

Connections and initial set up

Main messages on the display

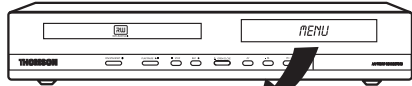

- Main menu of the recorder on the screen (device stopped). No function selected.
- Channel 1 being watched.
- Images from a device connected to the SCART socket **AV2 (SCART IN)**.
- Start of the recording.
- Indication of the selected source:
AV3: AUDIO/VIDEO input sockets on the front.



About other displays (menus and banners)

- **The disc menus** – Each DVD video disc offers menus and for which the presentation and organisation depends on the disc's editor. The disc menu is displayed on the screen when a DVD disc is loaded and it starts to play. You can also, at any time, display the main menu of the disc by using the **MENU** button.
- **Player banners** – while a disc is playing back you can display or remove banners using the **INFO** key on the remote control unit. The banners appear in the form of a succession of icons at the top of the screen.
- **Player menus** – your DVD recorder has menus enabling you to use functions that are not accessible using the remote control unit keys.
Move around in the menus using the navigation keys and confirm your selections with the **OK** key.

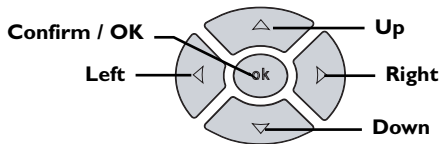

Note: settings will only function if the corresponding function has been provided by the editor. For instance, if you select the subtitle icon in the banner, subtitles will only appear if they actually exist on the disc. Check the sleeve to see what subtitles are provided. Check the jacket to see whether there are any subtitles. If a menu or icon appears in "grey" it means that the function is not available.

Function indicator not available: with certain discs, direct access to a scene is not possible even if the time elapsed is shown on the banner.

A question mark in the counter zone indicates an input error.

This  symbol is sometimes displayed. It indicates that the function is not available or that the key used is incorrect.

Recording functions

To watch TV Programmes

1. Turn on your TV set.
2. Turn on your DVD recorder using the **ON/STANDBY**. The time displayed on your DVD recorder is replaced by the word **MENU**.
 - After a few seconds the main menu of the player appears on the television screen.
 - The **Watch TV** function is already selected.



Note: turn off any unused devices to avoid problems of selecting sockets or other types.

If the main menu of the player is not displayed on the television screen, check and/or select the Scart socket to which you connected your DVD recorder. Generally the selection is carried out using the AV key on the television set remote control.

*If the THOMSON logo temporarily appears, it is because the screen saver has been triggered; press the **OK** button to display the menu*

3. Press the **OK** key of the remote control or one of the **PR+/PR-** keys on the front panel.
 - The images of the last watched channel appear.
 - Encrusted within the image for a few seconds is information on the current channel and programme. This disappears after several seconds.

*Note: when the information banner is displayed at the top of the screen you have the possibility of choosing an audio channel (if this is provided by the channel) using the **▶** key on the remote control.*

*To display information again, press the **INFO** key of the remote control.*

To change channel

Change the channel with the **PR+/PR-** key or the remote control number keys. To select the channel of a device connected to your DVD recorder (satellite receiver) or to view images from a video recorder, use the **AV** button on the remote control.

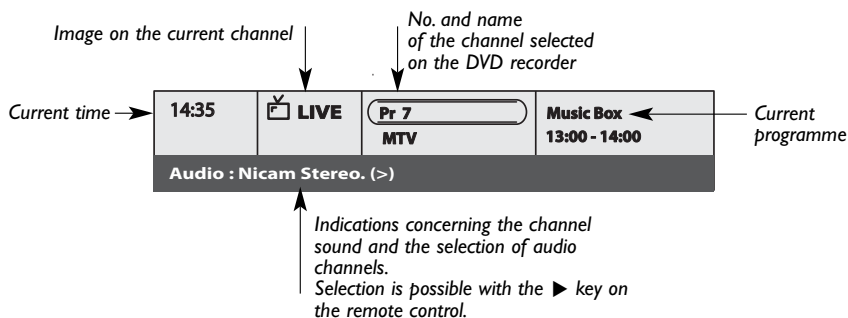

Recording functions

Taking a break (Time Shift function)

Your recorder can save in its memory images of the last 60 or 120 minutes of the programmes viewed. Use the scroll keys (**PAUSE**, **PLAY**, **REV◀/▶**...) to use this function.

The **•••** symbol in the information banner indicates that you are watching a delayed programme. The delay between the images being watched and the live images is indicated to the left of the banner. You can return to the live broadcast using the **LIVE** key.

*Note: This function which is associated with the **Save Buffer** function lets you save a programme for which you missed the start to the DVR hard disc.*



Record the current programme

Recordable discs

DVD R/RW - The majority of DVD R (write once) and DVD RW (re-recordable) of 4.7 Gb capacity with the following characteristics.

Recommended brands and types

Certain **brands of discs** have been "approved" for your DVD recorder. Other brands can be used but the discs must be good quality to produce successful recordings. Recommended brands:

Imation, Maxell, Philips, Ricoh, Sony, TDK, Verbatim.

The DVD discs are certified for certain recording speeds. These speeds must correspond to the capabilities of your player, i.e.:

Note: The brands mentioned in this manual are registered trademarks

Disc	DVD RW DVD R	Recording speed
2,4 x DVD R / DVD RW		2,4 x
4 x DVD R / DVD RW		4 x
8 x DVD R / DVD RW		4 x
16 x DVD R		4 x

Configured recording (HDD or DVD discs)

Configured recording lets you record the programme after a quick adjustment of the duration, the quality and the destination of the programme to be recorded to the hard disc (HDD) or to a DVD R/RW disc.

*Note: You can start a recording at any time by pressing the **DVD REC** button on the front twice to record to a DVD R/RW disc or the **HDD REC** button on the front to record to the hard disc (also using the **REC** button on the remote control).*

- 1. Load a disc** - Open the disc tray by pressing **OPEN/CLOSE**. Put in a disc with the printed side upwards. Close the tray using the **OPEN/CLOSE** key.
- 2. Press the REC key** on the remote control.
*Note: for an immediate recording to the hard disc, press the **REC** button on the remote control twice.*
- 3. You can choose a duration** using the **▶** key. Each time you press the **▶** key the duration is increased by 30 minutes up until the maximum time remaining on the disc is attained. When the maximum duration is reached, pressing again on **▶** displays --h--min which indicates the precise time remaining, for example 1 hour 12 min.
- 4. The time remaining on the disc is indicated next to Recording quality.** If you modify the quality you will also modify the duration, which may be useful with a DVD R/RW disc which has little space. Select **Recording Quality** with the **▼** key, then select a lower recording quality using the **▶** key, this will increase the amount of time available on the disc. However, for a recording to the hard disc that you can copy later to a DVD R/RW disc, increase the quality.

Recording functions

5. Destination

The default recording destination is set for the DVR hard disc. To record to a DVD R/RW disc, change the setting with the key ►.

6. Start the recording by choosing **Start record** with the ▼ key then by pressing **OK**.

- Recording starts.
- The indication *REC* (RECORD) is displayed for a few moments on the display of the DVD recorder. The red lamp on the front lights up. It confirms that recording has started.
- The information banner appears for several seconds on the screen of your television. The information that is displayed confirms the channel, the programme being recorded and the time remaining on the disc.

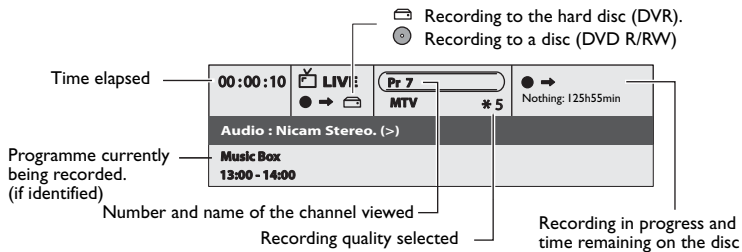

Note: after several seconds the information banner disappears. You can redisplay it using the **INFO** key on the remote control.

Changing the channel during recording is not possible. To watch another channel during the recording session, select it directly on the television set, using its own remote control handset.

Saving the buffer

This function lets you start to record a programme to the DVR hard disc even if you missed the start thanks to the **Time Shift** function.

In the recording menu which appears, select then activate (position **YES**) the **Save Buffer** function with the ▼ and ► keys. Confirm with **OK**.

The programme is recorded to the hard disc and its references (name, times, etc.) are stored in the video library.

Stop recording

Press the **STOP** button twice.

Note: if you only press once on the **STOP** key, the confirmation window appears. Press a second time to definitively stop the recording or select continue using the ▲ and **OK** keys. At the end of each recording, your DVD recorder takes a few seconds to prepare the disc welcome menu. This menu is made up of pictures which represent the first images of each title.

- With a DVD R disc, if you do not have another recording to make, you need to "Finalize" the disc in order that it can be read by other DVD R compatible players. Closing a DVD R disc is described in detail below. If you do not close a DVD R disc, it will still be possible to make other recordings on it later on, providing there is enough disc space. You can therefore safely store it. You may also erase recordings but the corresponding duration will be lost. You may not record other titles in their place.
- With DVD RW discs, this function does not exist. It is replaced by a function that renders the disc compatible in such cases where you have added or removed chapter bookmarks using the edit menu. For some players, it is necessary to render the disc compatible even though you haven't carried out modifications to the chapters.

Recording functions

Programming a recording or a transfer

Your DVD recorder lets you program recordings or transfers. Programming several recordings is really useful when it uses the high capacity of the hard disc, thereby enabling you to go beyond the limited capacities of DVD R/RW discs. You can programme recordings using the manual 9 step method or by choosing, for channels which broadcast the programme guide, the Naviclick programming.

Manual programming



Note: your DVD recorder can memorise the parameters of 16 different programmings, or 15 programmings and 1 transfer. In the case of double programming, a warning message is displayed.

Name - Press the **INFO** key to access the keyboard table. Enter the name of the recording letter by letter and confirm.

Channel - a) Enter the channel number using the digit keys of the remote control (**Pr --** must be displayed) or browse the list of channels in the memory of the DVD recorder using the **PR+/PR-**.
b) Or select one of the Audio-Video (AV2, AV3) sockets to which is connected a device (satellite receiver or other) using the **►** key.

*Note: selecting the AV2 connector allows you to program the recording of a satellite receiver programme (either left switched on or also programmed) connected to this connector. The selecting of the AV2 connector is activated by default by the **AV Timer** function (triggering of programming via the AV connector).*

Day(s) - Using the digit keys on the remote control type in the date, if the recording is not made the same day, and / or select a period using the **►** key.

Once: to record the selected programme according to the parameters you have defined.

Each Tue: to record the same programme the same day every week starting from today (supposing today is Tuesday).

MON-FRI: to record the same programme, everyday at the same time from Monday to Friday.

Time - Enter the recording start time and then the stop time.

To this end, and according to the features of the receivers, you must:

- either program the receiver with the same beginning and end times, then switch off the DVD recorder and the receiver,
- or leave the satellite receiver switched on, on the channel to record, program the DVD recorder, then switch it off.

Note: if you selected AV2 during channel setting, you do not need to enter the start and stop times, since it is the device that is connected that triggers the start and stop of the recording at the times set via its programming menu.



Recording functions

VPS/PDC - If the channel broadcasts the VPS/PDC signals, activate the **VPS/PDC** function to start the recording at the time when the programme actually starts.

Recording destination - Select the disc where the programme will be recorded (DVD R/RW or internal DVR)

Quality - Choose a recording quality.

*Note: selecting the quality enables you to adapt the recording time on the DVD disc. The lower the quality, the longer the time available on the disc. For example, the time available with a clean 4.7 Gb disc with "Low" quality will be approximately 8 hours while in "Best" quality the time will be approximately 60 minutes. The figure 1 à 6 is displayed in the information banner when playing the recording. The quality selection will only be valid for this programming. For an automatic quality selection according to the time remaining on the disc, activate the **SmartRecord™** function (page 28).*

Store your programming by selecting **Keep** and confirming.

Return to the main menu using the **MENU** key in order to continue to use your DVD recorder or turn it off using the **ON/STANDBY** key, after having loaded a DVD R/RW disc with remaining time compatible with your programming, if DVD R/RW is selected for recording.

Programming a transfer



- The **Programming** screen appears. If you didn't programme anything, the screen displayed only indicated **Timers** and **Set transfer**.

1. Select **Set transfer** and confirm.

The transfer programming menu appears. This menu allows you to define all the parameters necessary for a deferred transfer.

Note: your DVD recorder can memorise the parameters of 16 different programmings, but only one transfer. In the case of double programming, a warning message is displayed.

2. Select **Copy from / to** then select the source and destination of the titles to be copied.
3. Select **Day(s)** then type the date for the transfer.
4. Select **Start time** then type the transfer time.
5. Store your programming by selecting **Keep Timer** and confirm with **OK**.

Recording functions

Automatic programming (Naviclick)

Your DVD recorder offers you a TV programming guide for certain channels. The information it provides you comes from the Teletext log and the NexTV service broadcast for certain channels. The updating of Naviclick information is carried out once every 24 hours. Naviclick allows you to display on your screen the programmes of those channels and to select the broadcasts you wish to record simply by clicking on them.

Consulting the TV guide with Naviclick



Use the keys ◀, ▶ to move from one channel to another or to move around in the channel programme list (▲, ▼ → moving from one programme to another) (**FWD**, **REV** → moving from 6 to 6 programmes).

To consult the programs of the channels at a given time, choose a program from the list (e.g.: 9 o'clock news) and use the (◀, ▶) keys to move on to the programs of the other channels.

Recording through the Naviclick TV guide

1. Select a channel on your DVD recorder.
2. Press the **NAVICLICK** key and wait for the Naviclick page to appear.
3. Go to the programme you want to record. Move from one channel to another with **PR+/PR-** or ◀, ▶.
4. Confirm by pressing **OK**.
5. To select another programme to record, press ◀ to display the Naviclick page.
6. Leave the menu using **EXIT**. Switch off your DVD recorder or leave it switched on (don't forget to load a DVD R or DVD RW disc if you modify the default internal DVR destination to DVD R/RW in the programming setup menu). In this case the DVD recorder will automatically seek the channel to automatically record at the correct recording time.

Note: for the correct downloading of the programme guide, the clock of your DVD recorder must be set.

Recording from a connected device

1. **Satellite receiver** - When you are watching a channel, select the DVD recorder's AV2 input with the **AV** key on the remote control. **AV2-SAT-CABL** is displayed in the banner and on the display (*LIVE AV2*) on the DVD recorder for the SCART IN socket.
2. **Video camera or other device** - When you are watching a channel, use **AV** to select the AV3 socket if your video camera is connected to the front of your DVD recorder. Record with **REC (RECORD)**. Stop the recording by pressing twice on the **STOP** key.

Recording functions

Library

The library lets you locate the various recordings present on the DVR hard disc or the different DVD R/RW discs in your DVD library. The library groups together the recording names and parameters and lets you look for them using the search functions.

The names of the recordings are distributed according to the nature of the files and title in four sub-libraries. Each one will let you access functions specific to the nature of the recordings. The contents of the library are not lost even if the recorder is no longer connected to the mains supply for a while.



The **Library** screen appears. It lets you access the 4 sub-libraries: **Video library**, **Library** (discs), **Music library**, **Picture library**.

Depending on the recording you are looking for, select the library and confirm with **OK**.

The screen specific to the library appears.

Video library (on the hard disc)

To look for a video or DivX title.

The video library brings together all the names of titles of DivX files saved to the hard disc (TV programmes or films in DivX format).

*Note: **Playing a Video and PIP title (picture in picture)***

Select a title with the **▼** key and change to play mode with the **PLAY** key.

While a video title (from a video DVD, DVD R/RW or DVR hard disc) is playing, you can superimpose TV pictures from your recorder's tuner using the **LIVE** key. This will let you monitor programmes on a channel while you are watching a video recording. You can change channel with the **PR+/PR-** key.

Managing titles (on the hard disc)

Select a title and confirm it with **OK**.

Among other things, the management functions let you rename, copy or delete a title. To access them, when a title in the Video library is selected, press **OK**. The functions to manage the chosen title appear:

- **Play title**, to play the title except for the hidden chapters.
 - **Play all chapters**, to play the title, even the hidden chapters.
- Note: Vital if you want to split a title with the **Edit** menu (page 22).*
- **Rename the title** to give it the name of your choice letter by letter using the character grid.
 - **Delete the title** to free up space on the hard disc.
 - **Lock the title** (or unlock it) to avoid (or enable) its erasure.
 - **Copy to disc** to conserve (archive) a title to a DVD R/RW disc and then erase it from the hard disc.
 - **Clear chapter** to delete all the electronic bookmarks positioned automatically at regular intervals in order to define others.

Note: This is useful when you only want to copy the chapters you want to keep to a DVD R/RW disc.

Note: Jpeg, mp3, wma and DivX files cannot be copied using this menu.

Recording functions

Disc Library (DVD)

The (disc) library brings together the names of all the titles recorded to the different DVD R/RW discs in your DVD collection.

Note: if a disc appears in front of a title it means that the disc is loaded in your DVD recorder.

Note: For recordings that you have made directly or for those you have programmed, without providing them with names, appear along with the name of the channel, the time and date.

Note: the Library may be accessed even if there is no disc in the recorder.

Note: The titles and names of programmes (Pr1, Pr2, AV2, ...) and times correspond to those recordings that you have not renamed (Modify title function).

Note: Depending on the duration of the recordings, the number of titles and/or the number of discs, we may estimate that the library may contain the names of 400 titles created on the different discs in your DVD collected (DVD R/RW discs only) on the internal DVR hard disc. In order to assist you to find a title, the library offers a range of functions (sort by title, sort by type, etc.).



Music library (on the hard disc)

The musical library brings together the names of all the MP3 or WMA files recorded on the hard disc. When the musical library screen is displayed, you can play a title or file, create or edit playlists, rename a title, delete it or sort titles.

Picture library (on the hard disc)

The picture library lets you look for and view photos one by one or look at them using a slideshow. The library displays the last six photos recorded on a screen which brings together the six snapshots with selection buttons. The other photos can be accessed using the ▼ key. Select a photo using the ◀, ▶, ▲, ▼ keys and confirm with **OK** or start the slideshow with the **PLAY** key.

Export

You can copy one or more titles to a DVD R/RW disc.

*Note: **EXPORT Function***

*Your recorder has a separate setting for the recording quality on the DVR hard disc or on the DVD R/RW discs. This lets you copy titles which were recorded with very high quality (example ***1: Best**), from the DVR hard disc to a DVD R/RW while adapting the quality (example ***3: Good**) so that the title can "fit" the disc. **Caution:** To be able to use this function, **SmartRecord** must be disabled in the **Rec. options** menu.*

Title and disc management functions

The management functions let you sort titles according to the criteria proposed by your recorder. To access them, when a title in the Video library is selected, press **OK**. The functions to manage the chosen title appear:

The management functions can be accessed by selecting the **button in the frame with the ▶ key** then by displaying another choice with this same key. Confirm your choice with **OK**.

Note: If you delete a disc, it is still possible to "reload" the titles of the disc by adding a new recording.

*Note: Deleting a title or a disc is not immediate, it may take several seconds. Wait until the **"Please wait"** message at the bottom of the screen disappears.*

*Note: The number of the disc to load may appear in a superimposed window. To remove the window press the **EXIT/CLEAR** or **OK** key.*

Other disc management functions

Access: **Main Menu, Disc, OK, Disc Actions** and **OK**. You may:

- **Rename disc** to give it the name of your choice letter by letter using the character grid.
- **Erase disc**
- **Unlock or Lock disc** to enable or avoid an accidental erasure.
- **Make the disc compatible** to enable it to be read by other players.
- **Copy to DVR** to copy one or more titles on the hard disc

Copying to DVR

To copy one or all the titles to the DVR hard disc.

Playing a disc

Readable discs



- **DVD - Video** - 12 cm and 8 cm, single or double sided, single or dual layer. DVDs are high density optical discs on which high quality picture and audio are recorded by means of digital signals.



Region code number - Your DVD recorder responds to the regional management information recorded on DVDs. The regional code of your DVD recorder is 2. Before buying a DVD, make sure that it bears the correct logo. ALL means all regions.

Note: for your information: the other areas are - 1: USA, Canada - 3: Southeast Asia, Taiwan - 4: Central America, South America, Australia, Mexico, New Zealand - 5: Russian federation, Africa (except Egypt and Rep. of South Africa), India, Pakistan - 6: China.



- **DVD+/-R, DVD+/-RW** - Most DVD-R and DVD+R (one recording only), and DVD-RW and DVD+RW discs (rewritable). Recordings on DVD-R and DVD-RW discs must be made in Video DVD mode. Recordings on DVD+RW discs must be made in accordance with the specifications for the 4.7 Gb capacity DVD+RW disc format.



- **Audio CDs** - Audio Compact Discs (8 and 12 cm).
- **CD-R, CD-RW** - Most CD-R (one recording only) and CD-RW discs (rewritable). Compatibility is dependent on which DVD writer, writer software and discs are used.



- **Video CD (VCD)** - Video Compact Disc. Disc which enables you to record to a CD up to 74 minutes of VHS quality video associated with fixed pictures, audio tracks and interactive menus.



- **Super Video CD (S-VCD)** - Most S-VCD discs conform to the IEC 62107 standard. They can be used to record up to 70 minutes of digital sound and video, with MPEG-2 standard video and MPEG-1 standard audio. S-VCD disc compatibility is dependent on which MPEG coding software, disc design software and disc writer software are used, and the discs themselves.

Note: in spite of progress made to ensure playability of all disc types, it is not possible to guarantee playback of discs which are not in conformity with DVD, CD, VCD or S-VCD standards. Moreover, this unit may not play some recordings or files on CD-R, CD-RW, DVD-R, DVD-RW, DVD+R, DVD+RW due to differences in recordings formats, software used & Disc types.

The files which your player can read



- Discs containing sound files in MP3 format.



- Discs containing images in JPEG format. Compatibility is dependent on the disc creation software used and file sizes, stated in millions of pixels. Certain JPEG files such as Progressive JPEG files cannot be read by this equipment.



- Discs containing sound files in WMA format (Low bit rate files are not supported for WMA playback. Playback of files with bit rate lower than 44 KHz is not guaranteed).



- Discs containing audio and image files in the certified DivX format.

Playing a disc

Interactive banners

In addition to menus, your DVD recorder has **interactive information banners** with icons representing functions or information. Some banners provide access to disc playback functions (for DVDs, CDs, VCDs, etc.) while others give you information on the channels and related functions.

While watching a channel

Access: **INFO** key.

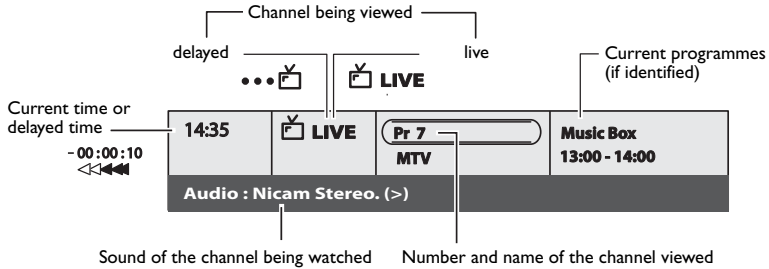

While playing a disc

Access: **INFO** key.

1. Select an icon using the **◀**, **▶** keys, or enter a number using the number buttons to access a chapter, a title or a track depending on the disc being played (when the corresponding **T**, **C**, **P** icon is selected).
2. Remove the banner using the yellow **INFO** key or the **CLEAR** key, or wait a few seconds until it disappears.

With a DVD

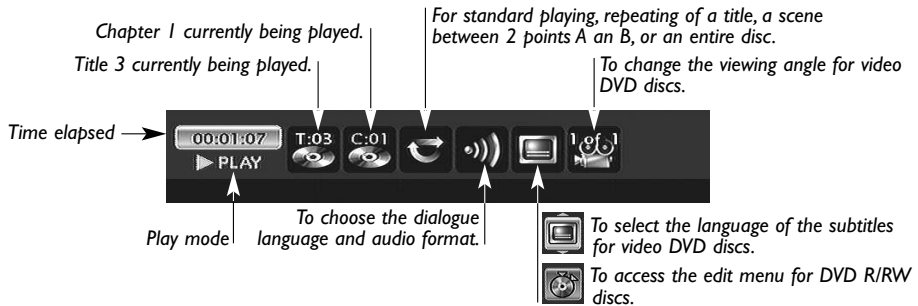

With an audio CD or VCD (Video CD) disc

P:01 I:01 Track / Title / Index while playing

To select the play mode (**Standard**, **Random**)

To control the repeat reading of a disc, a musical track or repeating of a music track between 2 points A and B.

♪ introscan - To play the first seconds of each track.

))) To select the **Stereo**, **Mono**, **Left** or **Right** audio channel.

PBC To select the PBC function where available on the disc.

PLAY MODES (**PLAY**, **PAUSE**, **REV**, **FWD** buttons)

▶ **PLAY** (Play) Fast forward (**▶** x3, x6...), or reverse (**◀** -x3, -x6...).

|| **PAUSE** (Pause) Slow motion, forward (**||▶** 1/2, 1/6 ...), or backward (**◀||** -1/2, -1/6 ...).

Playing a disc

Loading and playing a disc

Switch on your TV set and DVD recorder. It may be necessary to turn off other appliances. If the player menu is not displayed on TV screen, select the TV set Scart Peritel socket to which you connected your DVD recorder.

*Note: the **Disc** heading is shown as transparent when there is no disc in the device or if the disc is not compatible.*

Note: the disc label must face upwards (double sided discs have a small label on both sides around the centre).

Play functions

The playback options depend on the discs and/or files being played.

Quick search

Keys **PLAY** then **FWD** or **REV** (press one or more times)

Normal playback, with **PLAY**.

Still picture and frame advance

Keys **PLAY** then **PAUSE**. Press **PAUSE** again to go into "frame" mode (the **PAUSE** icon is then replaced by the **FRAME** icon on the TV screen). Press **FWD** or **REV** to view images one after the other forward or backward. To resume normal playback press **PLAY**.

Slow motion (in Pause mode on an image)

Keys **PLAY** then **PAUSE** then **FWD/REV**. Press one or more times.

Normal playback, with **PLAY**.

Skipping a chapter or track

Keys **PLAY** then **PR ►►/PR ◄◄**.

*Note: Forward or backward skips can also be made by using the ◄◄ **SKIP** and **SKIP** ►► keys on the DVD recorder.*

Scene Again™ (DVD)

Keys **PLAY** then **AGAIN** (go back approximately 10 seconds).

Advance (DVD)

Keys **PLAY** then **ADVANCE** (go forward approximately 30 seconds).

Zoom

Keys **PLAY** then **ZOOM**. Move the enlarged image with the ▲, ▼, ◀ et ▶ keys to see a specific part of it. If this does not work, try again after pressing **PAUSE**. To resume normal playback press the key several times to return to the original format.

Titles, chapters, time elapsed, audio and subtitles

From the banner, you can access certain functions directly using the ◀, ▶ keys. Choose a title or a chapter (DVD), or a track (CD, VIDEO CD). Change the language of DVD dialogues or subtitles.



For direct access to a specific scene on the disc, select the first icon with the ◀ ▶ keys. Enter the requested place in the scene (expressed in hour, minutes, seconds) with the remote control number keys. (enter 001205 to access a scene which is 12 minutes and 5 seconds away from the start of the disc (DVD) or track (Video CD)).

Playing a disc

Playing discs – Displaying the information banner

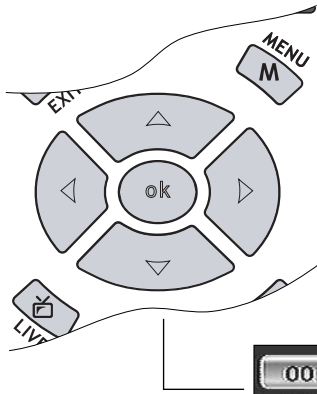

To access the information banner, press **INFO** on your remote control unit during playback. Use the arrow keys ◀ and ▶ on the remote control unit to select the various icons. When an icon is selected it is highlighted. The line under the banner is an information and instruction line. When small arrows appear above and below the selected icon these point to other possible options. Now use the ▲ and ▼ keys to scroll through the various options.



Banner with a DVD video disc.

Note: the icons displayed in the banner depend on the type of disc being played.

The playback options depend on the discs and/or files being played.

Important notice: the icons displayed in the banner depend on the type of disc being played. The icons proposed and their use in the banners depend on the nature of the discs and the files being played. In all cases, follow the help line at the bottom of your screen.

Time counter



The timer provides direct access to a scene or a musical passage by keying in the starting time. Select the time elapsed icon and use the numbered keys on the remote control unit to access the place from which you want to play back. Use two digits for each field. For instance, if you enter 01:35:12, you will access the sequence beginning 1 hour, 35 minutes and 12 seconds after the start of the title.

Note: for VCDs, the timer refers to the track currently being played.

Title or Track



Most DVD discs only contain one title. However some discs may contain several titles each of which is itself divided into several chapters. Select icon **T** then use the ▲ or ▼ keys to scroll the titles or tracks.

Chapter



Most DVD discs contain several chapters. Select icon **C** then use ▲ or ▼ keys to scroll the titles or tracks.

Note: follow your progress below the banner.

Playing a disc

Subtitle and dialogue language



Selecting the subtitle language



Selecting the dialogue language

Select the subtitle or dialogue language if they are available on the disc. The name of the language selected appears under the banner.

Note: selecting the language of subtitles only involves the disc being played. If you remove the disc or if you switch off the DVD recorder your selection will be cancelled. In this case the default language, chosen when your DVD recorder was first installed, will be reactivated. If the preferred language is not available on the DVD disc the preferred language of the disc (default language) will be selected automatically. With some discs you can only access the dialogue or subtitle languages through the menu provided on the disc.

Disc play mode



Play modes

The DVD recorder has several play modes that depend on the type of disc being played: standard play respects the order of the titles and chapters on the disc; repeat between 2 points or repeat a disc, a title. The icon of the play mode is accessible via the information banner during playback.

Repetition between 2 points A and B

A-B Repeat mode allows you to select exactly the sequence you wish to repeat.

1. Select A-B repeat mode and confirm to store the start of the sequence you wish to repeat.
2. Wait a few seconds before pressing **OK** again to mark the end of the scene to be repeated (point B). To stop repeat, select another mode using the **▲** or **▼** keys, or by pressing **STOP**.

Note: repeat functions remain active until you turn them off, open the disc tray or turn off the power. Repeat play only works with discs that show the elapsed time on the display. This may not work correctly with certain discs (Video CDs in PBC mode).

Playing a disc

Camera angles



Changing camera angles

A few DVD discs contain scenes shot from various different angles. If a disc being played back offers different camera angles the icon in the banner will show the number of the angle on the screen. With the disc in playback, press **ANGLE** on the remote control unit and choose the angle using the same key or the **▲** or **▼** keys.

PBC - Playback control menu (VCD)



Selecting a play mode

This function enables you to make interactive selections of some scenes or information through an on-screen menu. Moreover, high resolution images may be viewed if they are included on the disc. During playing of a disc, press the **INFO** key (the information banner is displayed). Press **◀** or **▶** to select the PBC icon. Use the **▲** or **▼** key to see other screens or deactivate the functions on offer.



Play mode for Audio CDs



Standard play

Your player has several play modes for Audio CDs: standard play that respects the order of the tracks; random play that reads music tracks in a random order; repeat play: Repeat A-B, Repeat track, Repeat disc, Repeat de-activated.

IntroScan



IntroScan

The IntroScan function enables you to listen to the first few seconds of each track of an audio CD.

Note: when the first few seconds of all tracks have been played the player starts playback from track one.

Repetition



Rotating an image



90°, 180°, 270°

Zooming in on an image (zoom)



1X, 1.5X, 2X, 4X

Speed of the slide show



Playing a disc

Edit menu (DVD RW disc and DVR hard disc)



The edit menu can be accessed from the information banner while you are playing a title on a DVD R/RW disc or on the internal DVR.

Access to the edit menu

1. DVD R/RW Disc in playback, **INFO** then **OK**.
2. Select the edit icon then **OK**.

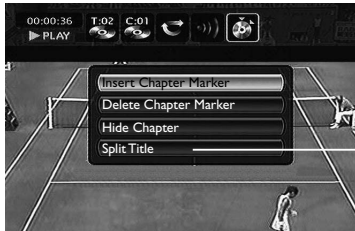

Note: the edit menu cannot be accessed while playing a title or chapter list. To delete the list being played, eject the disc or delete the list.

*Carry out your searches in a title using the **PLAY, PAUSE, REV, FWD, STOP** keys and select a function.*

Split title for a title played from a DVR if you selected **Play all chapters** in the title menu.
or
New title image with a DVD R/RW.

- **Insert chapter markers (DVD RW and DVR)**
To position marks in order to easily find your favourite passages. Since it is not possible to delete a passage in title, you can use this function to mark the start and end of undesirable sequences (e.g. advertising) in order to mask it from being played using the Hide Chapter function (see further on).
- **Delete chapter markers (DVD RW and DVR)**
To delete undesirable markers in order to form longer chapters within a title, or to redefine the position of bookmarks to your own requirements.
- **Hide Chapter (DVD RW and DVR)**
To mask the chapter being played (the passage between two bookmarks) in order not to play an undesirable passage (advertising, violent scenes...). If you do not wish to play the masked chapters, you must select **Play Title** in the title menu. If you wish to play all the chapters, including those you have masked, select **Play All Chapters** in the title menu. With this function, you can, for example, hide chapters on a title present on the DVR before copying the title to a DVD RW. In this way, only chapters which are not hidden will be copied to the DVD RW.
- **Create a new title image (DVD R/RW and DVR)**
Replaces the title image (on the Play menu) displayed by your DVD recorder with an image of your choice.
- **Split title (DVR)**
This function can only be used for the title present on the DVR hard disc (not for DVD RW discs). To access it you must first select **Play all chapters** in the **Video library** title menu as before you can divide a title on the DVR, no titles must be hidden.
To cut a title in two to separate then rename the sequences with different themes.
To delete the end of a recording which too long and free up some space on a disc.
*Note: You can also access this function by pressing the **EDIT** button on the remote control.*

Playing a disc

Playing image and audio (JPEG, mp3, wma)

Your player can play JPEG files with a resolution of up to five million pixels. However beyond 400,000 pixels there is no perceptible improvement in the quality of pictures displayed on your TV screen.



Note: the play menu depends on the content of the disc being played.

Sound: Select a folder or a title, possibly a playback function and press **OK**. Choose a play mode and confirm with **OK**.

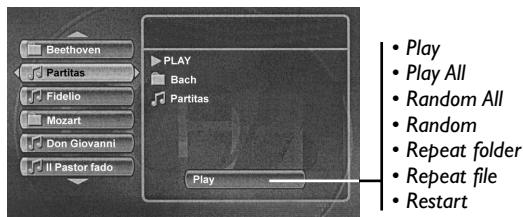

Playback of files begins with the file selected and continues with the following files. Where there are sub-folders in the folder, these are also played. Playback then moves to the next folder located at the same level in the tree diagram as the folder containing the first file you selected.

Stop playback using the **STOP** key.

Images: Select an image or start the slideshow from the selected image. Choose a play mode and confirm with **OK** (*Play, Play all, Random, Random all*).

Changing images

During the picture sequence change images using the **PR ►►** or **PR ◄◄** keys on the remote control unit. According to the type of image (Kb or Mb) the change may take several seconds.

To play DivX files

Your player is an Officially Certified DivX™ device. It can play DivX®5, DivX®4, DivX®3 and DivX®VOD files according to the DivX Certified™ technical specifications.

The correct playing of DivX in your player, depends on the preparation and production of the audio and video files, the codecs used, the type of recording equipment employed and the parameters of your computer. It is therefore possible that you cannot play a DivX file or that part or all of it is defective. It can also sometimes happen that you can play the images (video) but not the sound (audio). Your recorder can only recognize and read DivX files if their titles do not contain more than 12 characters.

Note: To guarantee playback of DivX files the audio must be mp3 format. DivX Certified devices can play back any interleaved mp3 audio at any bitrate, both CBR and VBR. The audio must be sampled at standard frequencies, such as 32 khz, 44.1 khz, and 48khz, and must conform to the AVI file specification. Apart from mp3, the audio formats recognised by your player are MPEG layer 1/2, AC3, DTS, PCM. The most common is mp3. Formats such as AAC and Ogg Vorbis are not supported by this player.

Playing a disc

To rent (purchase) DivX® VOD files

DivX VOD files are comparable to rental video DVD discs. They both allow you to view the video (film). The difference lies in the access to the media. DivX VOD files are downloaded after paying a rental from certain commercial Internet sites. To allow you to download VODs you must enter the record number of your DVD player in the purchase form on the site.

Your player's record number is available in the menu **Disc Options** of the **Setup** menu.

Write down this VOD 8 character recording number, in order to complete the form on the web site where you purchase your DivX® VOD files.

Note: If you cannot play a DivX VOD file, recorded on a CD-R disc after downloading, it is possible that the rental period allocated during purchasing from the web site has expired. It may also be that the recorded file is incompatible with your player because of different versions or incorrect download parameters. The parameters used during the copying to CD-R may also be a cause. Since it is not possible here to supply all the information, parameters and advice relating to the use of DivX® VOD files, we recommend that you visit a specialised web site such as www.divx.com/vod.

Concerning DivX files

You can find DivX files for download as well as generating them your self from your own content. In the same way as mp3 files are used for audio, DivX and mpeg4 can be used for video. Files can be recorded from your computer on to a CD-R or RW disc, which, owing to the much higher compression than that used for DVDs can contain a complete movie.

The DivX, XviD and RV9 formats are all file formats using the same type of compression known as MPEG-4. Though these formats all utilize a different codec.

A note on copying: before making use of DivX or mpeg4 files, please be sure of their origin and that you have legally purchased or rented the content. Pirate copying is illegal and may result in sanctions. Private copies of your own material for your own use may be legal in some countries. Make sure you are aware of applicable laws.

Disc menu

The **Disc** menu is only accessible if a disc is inserted in your DVD recorder. This menu allows access to the list of titles of the **Disc Title Menu** or the images menu of the **Player Menu** for your recorded discs (DVD R/RW). With DVD video discs you directly access the disc menu, the selection of the language, chapter, play order and contents varies depending on the disc.

*Note: if no disc has been inserted the line **Disc** remains greyed out.*

Access: **Main menu, Disc, then OK.**

Note: depending on the discs and/or files, all functions may not be available.



Play Disc

- To start playing a disc from the beginning, press the **OK** key.

Note: this function allows the playing of the last title on a DVD R/RW disc.

If your DVD recorder is locked (small padlock displayed), a message appears asking you to enter your secret code.

Disc Title menu (DVD R/RW)

This menu allows you to access recordings that you have made on your DVD R/RW discs, or those carried out by other DVD recorders if they are compatible with your player.

Playlist

Allows you to customize the playing order of a disc by changing the play order of titles and/or chapters on DVD, DVD R and RW discs, or the play order of music tracks on Audio CDs.

*Note: to remove a chapter from the list, select it and press **OK**. To delete the list, press the **STOP** button and confirm your request in the following screen using the **◀** and **OK** keys*

Disc actions

Rename Disc, allows you to change the name chosen by the DVD recorder (Thomson xx) for a name of your choice selected using a table of alphabetic characters.

Erase Disc, deletes all the titles on the disc.

Lock Disc (or Unlock Disc) protects the disc against accidental recording. This choice is not final; you may unlock the disc if necessary.

Finalize Disc / Make compatible (depending on the DVD R/RW disc inserted in your DVD recorder).

Your DVD recorder, closes the disc session and prepares a home screen made up from images representing each recorded title.

Note: you need to make a DVD RW disc compatible if you have added or deleted chapter bookmarks in order that the disc can be played on other DVD players.

Note: the space occupied by titles on the disc are represented by coloured bands at the bottom of the Title menu.

Copy to DVR

Enables you to copy titles and files to your recorder's hard disc.

Menus

Title menu



Rename Title

Using a character chart your DVD recorder allows you to change the names of discs or titles allocated when the recording was made.

Select **Rename Title** in the **Rename Title** or **Rename Disc** in the **Disc** menu using the **▲** or **▼** keys and press the **OK** key. In the following screen select **YES** and confirm with **OK**. The character chart is displayed. Use the **◀**, **▶**, **▲**, **▼** and **OK** keys to move around in this chart to compose the name of the disc or title you want.



Note: The **CLEAR/EXIT** key on the remote control or **Clear** in the menu allows the displayed name to be deleted.

1. Erase the default name with **DEL** and **OK**.
2. Compose the name by selecting letters one by one. Confirm with **OK**.
 - Delete a letter by selecting **DEL** and **OK**.
 - Add a space by selecting **SPACE** and **OK**.
3. When the name is complete, select **Done** and **OK**
4. Exit the menu using the **RETURN** key.

Play title, to play the title except for the hidden chapters.

Play Full Title, allows you to play all the chapters of the selected title, even those you have masked using the **Edit disc; Hide chapter function** (page 22).

Delete Title, allows you to delete the corresponding recording.

Clear Chapters, allows you to delete all the bookmarks (electronic markers) related to the recording. This function deletes the bookmarks automatically positioned by your DVD recorder and those that you may have added.

Note: The available functions differ depending on the type of disc.

Copy to DVR, lets you copy the selected title to the hard disc. **COPYING** is displayed while the copying is in progress.

Menus

Disc options

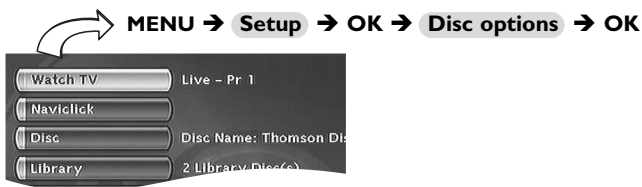

Disc Autoplay

- Select **Autoplay On**, if you want the disc to be played automatically once the DVD recorder tray is closed.

Screen Format - (DVD / VCD)

Depending on the format of the DVD disc being played, select the image format that corresponds best to the format of your television screen - cinema screen 16 x 9, classic screen 4 x 3 (Letter Box or Standard).

Note: on certain DVDs, the picture format cannot be changed.

Caution: the Automatic Format function of certain television sets may malfunction in 16x9. Set the Auto-Format of your television to Off in order to avoid conflicts.

- With a letterbox format TV (16x9) select **16 x 9 widescreen**. Films in 16x9 will be fully displayed. Films in 4x3 will have vertical black bands on each side of the picture.
- With a 4x3 television, select **4 x 3 Letterbox** to take advantage of the pictures recorded in that format or 16x9. Select **4 x 3 standard** to take advantage of a 4x3 Letterbox without distortion. For films in 16x9, the edges of the picture may extend beyond the edges of the screen.

DivX

Selecting DivX displays the authorisation number.

Menus

Recording Options Menu



Buffer Length (video memory)

Your recorder may save the last 60 or 120 minutes of TV programmes in its memory. You can define this duration here.

Default Rec. Quality

Your DVD recorder may record several hours of TV programmes or video sequences from a device connected to DVD R/RW discs or the internal DVR hard disc. This capacity depends on the space available and the quality set in the **Default quality** menu.

SmartRecord™

By activating the **SmartRecord™** function of your DVD recorder it will adapt the quality of your programmed recordings to one of the 6 settings so that you can record the entire desired programme on a disc that has already been partially recorded.

Note: deactivate this function if you want to divide a title while playing it from the video library (via the edit menu).

Chapter Markers

When recording a title, your recorder organises the chapters by creating chapters of 5 minutes in length. This then allows you to explore your recordings by jumping from chapter to chapter using the **Pr+** / **Pr-** key. You may select chapter lengths of 10 minutes if you wish, by positioning the function to 10 minutes. You may also decide not to create chapters by selecting **OFF** (function de-activated).

VPS/PDC

Triggers all your programming at the actual broadcast times (if the channel broadcasts VPS/PDC signals).

Note: the VPS (Video Programming System) and PDC (Program Delivery Control) signals are transmitted at the same time as certain programmes, by certain channels and in certain European countries. Leave this function active to benefit from its benefits for all your programming. If the channel does not broadcast VPS or PDC signals, your DVD recorder will record at the start and stop times selected during the programming of the recording.

Selecting Languages (DVD)

Your DVD recorder gives you a selection of languages to choose from. You can change the language of the DVD recorder menus, the language of the disc menus, the language of the dialogues and that of the subtitles. In the menu, choose your preferred language for dialogues and subtitles. If it is available on the DVD you will be playing, it will be selected automatically. The default language is the one which is selected in the main menu. During playback, you can display or remove the subtitles and change the language of the subtitles using the banners.

Access: **Main menu, Setup, OK, Languages** then **OK**.

Note: DVD disc menu language

The preferred language for the disc menus was selected during the installation. If the DVD disc that you are watching does not provide this language, you can select another language from the disc menus.



Display

The language of the DVD recorder menus was determined on installation. You can nevertheless change it by choosing one of the 5 languages offered.

Disc menu

To select the disc language menu if the disc proposes it.

Audio (DVD disc dialogues)

Certain discs offer several different languages for the dialogues. The default language is the one you selected during installation if this language is offered on the disc being played. To change the language of the dialogues your DVD recorder provides two possibilities:

From the menu of the DVD recorder

Select **Audio** and confirm with **OK**. Select your favourite language and confirm with **OK**.

Note: if the language chosen is also available on the DVD, it will be selected as the dialogue language. If it is not available, the preferred disc language will be selected.

From the banner

During **PLAYBACK**, display the information banner using **INFO** key and select the **Audio** icon. Select one of the languages proposed by the disc.



Note: with DVDs which have a DVD menu, we recommend that you use the disc menus rather than the DVD recorder menu. You can also change the language of the dialogues and subtitles (if they are available on the disc).

Menus

DVD disc subtitles

Certain discs propose several languages for subtitles. The default language is the one you selected during installation if this language is offered on the disc being played. To change the subtitles language, your DVD recorder provides two possibilities:

From the menu of the DVD recorder

Select **Subtitles**, **OK**. Select your favourite language and confirm with **OK**.

Note: if there is no English on the disc for menus, dialogues, and / or subtitles, the player selects the default language of the disc.

Original corresponds to the original soundtrack language of the film on the disc.

If you select the "**Automatic**" option, the default language of the subtitles will be the one you selected for the dialogues (see above). Because of this, if the default language for the dialogues is not available, but subtitles are available in this language, the subtitles will automatically display.

From the banner

During **PLAYBACK**, display the information banner using **INFO** key and select the **Subtitles** icon. Select one of the languages proposed on the disc with the keys or de-activate the display of subtitles.



Note: with DVDs which have a DVD menu , we recommend that you use the disc menus rather than the DVD recorder menu.

*If you chose "**English**" during the initial setting; the main menu will appear in English, the menus of the disc, in English (if available), the language of the dialogues, in English (if available).*

DivX subtitle selection

For files which offer them, select a language from the list which appears.

Menus

Parental control

Your DVD recorder has a child lock function which enables you to restrict access to certain DVDs. The discs whose content may be deemed unsuitable for your children will therefore not be visible unless a code that you have previously chosen is entered.

 MENU → Setup → OK → Parental control → OK.



Choose a play mode and confirm with **OK**.



Note: the padlock tells you whether or not the DVD recorder is locked. When the **Lock** function is activated, a padlock is displayed on the DVD recorder display.



Locked: you must enter the secret code to play the discs whose rating limits exceed the limit you have allocated.



Unlocked: you don't need the secret code to play the discs, even if you have set a rating limit.

Note: Your DVD recorder is delivered in the unlocked, position without any rating limit. If you want to use the **Child lock function**, you have to set a rating limit and position the **Lock** function on **On**.

Locking

1. The **Lock** line is already selected. Press **OK** to validate.
If no secret code has been chosen, your DVD recorder asks you to choose one.
2. Type four digits and confirm with **OK**.



Note: choose a four-digit number that you will be able to remember easily or note it down.



3. The first time a confirmation of the code is asked for. Enter the code again, then confirm with **OK**.

Changing the code

To change the code, you must deactivate the **Lock** function to be able to return afterwards.

1. From the **Parental Control** menu enter the 4 figure code, then confirm with **OK**.
2. The **Lock** line is selected. Press **OK**.
3. Select **No (deactivated)** and confirm with **OK**.
4. Exit the menu by pressing 3 times on the **RETURN** key.
5. See steps 1, 2 and 4, 5, 6 to allocate a new password.
6. See the **Locking** paragraph to enter a new code.

Note: if you forget your secret code, see the *Trouble Shooting Guide* at the end of this manual.

Menus

Ratings limits

This function makes it possible to restrict viewing of certain DVD discs by programming a restriction on your DVD recorder. This function can only be used with DVD discs provided with the function. Your DVD recorder proposes restriction ratings between 1 and 8. In Europe ratings limits are as yet uncommon on DVD discs on sale.

1. Access: **Main menu, Setup, OK, Parental control** then **OK**.
2. Select **Restriction level** and press **OK**.
3. Set the setting bar at the level you want.



Note: the DVD recorder is delivered with no restriction settings. If you want to prevent certain discs from being played you must select a restriction level.

4. Press **OK**.
5. To return to the DVD recorder menu, press **◀** until the menu is displayed on the screen.

Non categorized titles

Certain commercially available DVD video discs have restrictions. Unfortunately few discs in Europe have one. You can however restrict viewing of such discs by means of the **Unrated Titles** function by ticking the **Password Required**, option and then locking the DVD recorder. When this is done the password will be requested before playing any DVD disc, including those that would not normally need a restriction.



*Note: you may also restrict your own discs that you have recorded yourself by checking the **For DVD R/RW** box. In this case, the code will be requested for all the discs you have recorded.*

NAVICLICK Settings

The information relating to the Naviclick TV guide programmes comes from a combination of the TV programmes guide, Teletext and NexTV service transmitted by certain channels. To optimise the Naviclick programmes guide of your DVD recorder, you have the possibility of changing certain settings as shown below. The information from the NexTV service is more reliable than Teletext.

Download time

The programs are downloaded either at 3 AM or 8 AM.

1. Access: **Menu principal, Setup, Installation, Naviclick** and **OK**.
2. The line **Update Time** is already selected, press **OK**.
3. Select **3 am** or **8 am** and confirm.

Note: For those countries offering the NexTV service we recommend that you set the downloading time to 3am. For all other countries set it to 8am.



Choice of NexTV channel

The downloading of programmes, via the NexTV service, is only possible on certain channels. Access: **Menu principal, Setup, Installation, Naviclick** and **OK**.

Select **NexTV channel** and select a channel which broadcasts a programme guide. Hold the key down for a rapid selection.

Updating Naviclick (via Teletext)

Sometimes certain channels modify the organisation of their Teletext journal. In this case, unless there has been a total modification of the structure, you must update the number of the first page of Teletext allocated to the programmes guide. The list of pages is generally broadcast with the Teletext journal. Use the Teletext function of your television set to find this information. Look for the number of the page for the current day programmes and the number of the page for the following day programmes.

Access: **Main menu, Setup, Installation, Naviclick** and **OK**.

The menu that is displayed indicates, channel by channel, 2 Teletext page numbers (the first for current day programmes, the second for the following day programmes).

NexTV Channels

The number of channels offering the NexTV service is constantly increasing. At the time of printing these instructions, the channels diffusing NexTV were as shown below. For your information: there is an Internet web site in English and German that allows you to consult the list of the channels providing NexTV service ((<http://nxtvepg.sourceforge.net>), then consult the link **List of NexTV providers**).

France	: M6, Canal+, EuroNews, TV5
Germany/Austria	: RTL2, KABLE 1, 3 SAT, EuroNews
Switzerland	: SFI, TSR 1, TSI 1, KABLE 1, 3 SAT, EuroNews
Turkey	: TRT 1

Further information

Recommendations and information concerning discs (12 cm)

Choice of CD-R / CD-RW discs

This player can play most CD-R and CD-RW discs. However, depending on the recorder of your personal computer, the type of disc and recording method used, it may be that some discs cannot be played, or that the performance does not meet the expected standard of quality. When playing a CD-R disc, it is completely normal for the unit to take up to 30 seconds to recognize the disc before starting to play. If the disc is not recognized after a period of 120 seconds, remove the disc, and then insert it again.

- Whatever the actual recording capacity of a disc, do not fill it to maximum capacity.
- Use CD-R discs rather than CD-RW (re-recordable CDs), as replay of CD-RWs may sometimes not work properly.
- Use a reliable and good quality recording software.
- Before recording on a disc, close all applications on your personal computer in order to optimise the quality and reliability of recordings on the disc.

Video CD (VCD) discs

VCD (Video Compact Disc) discs enable up to 74 minutes of VHS quality video associated with still pictures, audio tracks and interactive menus to be recorded on a CD.

About DVD R/RW discs:

Choose good quality discs. To avoid any problems, choose brands such as: Imation, Maxell, Philips, Ricoh, Verbatim, Sony, etc.

Disc formatting

When you insert a DVD RW disc for the first time, your DVD recorder must format the disc. This operation will take several minutes, but you may begin recording onto the disc shortly after the formatting process starts (around 10 to 20 seconds). During these few seconds, the display indicates *FORMAT DISC*.

Disc maintenance

Always handle your discs with care. Hold a disc with fingers on the border or hole. Always place disc with the label facing upward (in case of a single-sided disc). Always place the disc properly into the tray using the proper guide area. Always use a soft cloth to clean discs if necessary, wipe from the centre to the border. Always put discs back into their cases after playing and store in a vertical position. Never use record cleaning sprays, benzine, static electricity liquids or any other solvent, if the disc surface is dirty. Wipe gently with a soft damp (water only) cloth, never wipe the disc in a circular motion, since circular scratches are likely to occur and could cause noise during playback.

Image files and CD-R / CD-RW discs

To view your JPEG images on a TV set you do not need to record your photographs with a resolution above 400,000 pixels (which corresponds to an image format of about 720 x 576 dots), for television screens do not allow a higher quality given their limited characteristics. In this case ensure that you reduce the quality of your photographs before recording on a disc in order not to impede the proper running of your player. This is because excessively loaded pictures would slow down or might prevent the proper functioning of the slide show during playback on your player. Compatibility of JPEG files depends on the software on which they were created and on the size of files expressed in pixels. Some JPEG files, including Progressive JPEG files (display in stages) cannot be played on this appliance.

Audio files and CD-R / CD-RW discs

In the case of discs that include mp3 files, follow not only the general recommendations for CD-R and CD-RW discs, but also the following specific recommendations:

- The format of your mp3 files must be ISO 9660 or JOLIET. These files are compatible with DOS and Windows applications, as well as with Mac OS.
- Your mp3 files must have a name no longer than 12 characters as well as the suffix ".mp3". They must be recorded in the form: title.mp3. Ensure that you do not leave spaces or use special characters such as (., /, \, =, +) in the name..

Further information

- Use a decompression transfer rate of at least 128 kb/sec (kilobytes/second) when recording mp3 files. Sound quality with mp3 files basically depends on the rate of compression/decompression you choose. To obtain sound quality equivalent to that of an audio CD, use files for which the sampling rate during conversion from analogue audio to mp3 format is between 128 kbps and 160 kbps. Higher compression rates, such as 192 kbps or more, will only rarely improve sound quality. Conversely, files with sampling rates below 128 kb/sec will not be played properly.
- Do not attempt to record protected mp3 files. Such files are coded and protected.

Important notice: The above recommendations cannot be taken as a guarantee that the DVD player will play mp3 recordings, or as an assurance of sound quality. You should note that certain technologies and methods for mp3 file recording on CD-Rs prevent optimal playback of these files on your DVD player (that is degraded sound quality and even, in some cases, inability of the player to read the file or files).

DivX files and CD-R / CD-RW discs

DivX is a compression format answering the MPEG-4 standard and that allows an entire film to be contained on a single CD.

The compatibility of DivX formats depends on MPEG-4 coding software, disc design software and the recording software employed, as well as the discs themselves.

What codecs can your player read ?

- Playback of DivX 3.11 content
- Playback of DivX 4 files (MPEG-4 simple profile)
- Playback of DivX 5 files (MPEG-4 simple profile and additional functions such as bi-directional frames. Qpel and GMC are not supported)
- Resolutions up to 720 x 480 at 30fps and 720 x 576 at 25fps are supported
- Macroblocks per second 40500
- Maximum average bitrate 4000 kbps
- Maximum peak bitrate during any 3 seconds of video 10000 kbps
- Minimum VBV buffer size (kbytes) 384k bytes

for DivX 3.11 content at Home Theater Profile, the required average bitrate is 1000 kbps, and the required maximum peak bitrate is 4000 kbps. Mpeg4 and Xvid content may or may not play back depending on the exact recording method and codec used.

Using the remote control unit correctly

When you use remote control, point the unit at the appliance you want to control (DVD recorder, TV set or satellite receiver). Ensure that there is no obstacle between the remote control unit and the appliance, otherwise the infrared signal carrying the remote control commands will be blocked. To control your DVD recorder, ensure that the remote control unit is in DVD mode by pressing once on the DVD key before using any other keys.

Recording

Your DVD recorder has recording functions similar to a video recorder. It lets you record programmes to a disc in the DVD family DVD (DVD R/RW) or to the internal hard disc (DVR or HDD). For the same disc, the recording time depends on the quality settings that you can adjust according to the time left on the disc. The recording may be immediate or deferred.

NICAM sound

NICAM sound is digital, compatible with analogue tv sets. It is broadcast by certain channels and relayed by certain emitters in some European countries. NICAM (Near Instantaneously Companded Audio Multiplex) is also used to broadcast Dolby Surround stereophonic programmes or for simultaneous broadcasting in two languages or for two different sounds (intended for blind and poorly sighted people).

Downloading Naviclick data

The downloading of Naviclick data (at 3am or 8am) can be quite long (up to 2 hours). During this time you should not use your DVD recorder, nor turn it on or have a programme programmed for recording during this updating time (from 3am to 5am or 8am to 10am) otherwise the information will be lost. For countries that provide the NexTV service we recommend that you set the downloading time to 3am. The full guide of TV programmes can only be consulted the following day after an initial installation. It is necessary to allow your DVD recorder to download the guide at the time set in the **Naviclick Setup**.



Further information

Troubleshooting guide

 **THOMSON HELPLINE**

You can contact **THOMSON** by dialling: **0871 712 1312**
(For Great-Britain, all calls will be charged 0,10£ / mn)
www.thomson-europe.com



This symbol indicates that your unusable electronic appliance must be collected separately and not thrown away with household waste.

Therefore, the European Union has created a specific collection and recycling system for which producers are responsible.

This appliance is designed and manufactured with high quality materials and components which can be recycled and reused.

The electrical and electronic appliances are likely to contain elements which, although vital for the system to operate, may be dangerous for health and the environment if they are handled or eliminated incorrectly.

Consequently, please do not throw your appliance away with your household waste.

If you own the appliance, you must leave it at the appropriate local collection point or hand it back to your retailer in exchange for a new product.

If you are a professional user, refer to your supplier's instructions.

If you rent the appliance or it is deposited to you, contact your service provider.

Please help us to protect the environment we live in!

Remote control

The remote control doesn't work

- Point the remote control at the front of your DVD recorder, not at your TV set.
- The operating range of the remote control is 6 to 8 metres. It gradually decreases as the batteries wear down. This is a good indicator of the state of the batteries.
- Make sure no objects (or animals) are in the path of the infrared beam between the remote control and your DVD recorder. They may block the beam and thereby cause a malfunction of your DVD recorder.
- The recorder is in copy mode. *COPYING* appears on the display.
- Some DVD players made by the Thomson group react to the same remote control codes. To avoid this inconvenience you can modify your DVD recorder's setting by setting it to the A or B password (press the **PLAY/PAUSE** and **AV** buttons on the front at the same time).

The remote control and the DVD recorder don't work anymore: everything seems blocked

- Unplug your DVD recorder from the mains for a few moments and plug it back in.

Image problems

You don't see any picture

- Turn on your TV set and your DVD recorder.
- On your TV set, select the socket which receives the signals from your DVD recorder (AVI, TVI, AUX1, etc., depending on the make, if connected).
- Make sure that all the connectors are correctly pushed into the various sockets.
- In STOP mode, press several times the **ZOOM/VIDEO OUT** button on the remote control in order to switch the video signal to the correct format accordingly to the socket used for TV connection (eg. *RGB ON* for SCART OUT).

The colours aren't natural

- Check that the scart cables are correctly pushed into the sockets of the various devices.

Further information

The image format doesn't match the screen format of your TV set

- The image format is adjustable. With certain discs the format is imposed and cannot be changed.

Sound problems

No sound

- Check that the DTS, Dolby Digital and MPEG settings are suited to the specifications of the device connected to the digital audio sockets (coaxial).

The sound is very low or inaudible

- The sound of the TV set has been cut or set at a very low level. Press the **(MUTE/🔊)** key on your TV set's remote control and/or adjust the volume on your TV set (or amplifier, if such is the case).

You can't change the camera angle

- Most DVDs do not have multiple viewing angles. When this option is available, it usually only applies to a few scenes.

There is no sound with the image

- Is the volume turned down? The audio codec of your player cannot play DivX files with the most recent codecs.
- The majority of applications on your computer require the video and audio to be coded separately. The two flows are mixed after coding. More information on this can be found using the various Internet search engines.

Playing problems

The DVD doesn't play, even when you press the PLAY button

- The disc rating is higher than the limit that you have set.

Fast forward or rewind doesn't work

- Some discs have scenes which do not allow fast forwarding, rewinding or chapter skips. When a command is prohibited or is not available for the current section or operating mode, a prohibition sign (⊘) appears on-screen for a few moments.

Your DivX files won't play

- Check that the file is actually DivX
When you encounter problems make sure that: the file that you are trying to play actually

contains DivX video. The files often use the term "DivX" in their filename even though they have in fact been coded in another format.

Problems playing DivX version 5.1 and the version 2.5 player

- With certain recent version, coding problems may arise with DivX files which are related directly to the capacities of your computer. The coding may require the entire capacity of the microprocessor and alter the quality of the image or desynchronise the image and the sound.

The display or reading of digital images in JPEG format is slow

- Image display can take a fairly long time, depending on the size of the images. If the images are too "bulky", your DVD recorder may not be able to display them correctly.

Recording problems

You cannot record on the disc

- If a message is displayed on the screen, press the **EXIT** key of the remote control to remove it.
- Check that you are using a DVD R/RW disc.
- Perhaps the DVD R disc is temporarily locked or definitively locked. If it is definitively locked you can no longer record on it. If it is locked you can unlock it.
- You cannot record on the same disc both video images and JPEG photos or mp3 music. Use different DVD R/RW discs for each type of recording.
- Dirt and finger prints may affect the recording and playback.

Other operating problems

Your DVD recorder doesn't switch on



- Is the mains socket to which you DVD recorder is connected receiving current? Check the corresponding fuse in your house's fuse box.

The menus or subtitles do not appear in the language you want

- With a DVD: the DVD menus are not displayed in your language. Check the disc jacket to see which languages are available. Choose the language of your choice, if available.



Further information

- With a DVD: there are no subtitles. Check the disc jacket to see whether subtitles are available. Choose the ones you want.
- The preferred language for DVD dialogues and subtitles was set upon initial installation of your DVD recorder.
- You can also change the language while a disc is playing by pressing the **INFO** key and selecting the  icon for dialogues or  for subtitles. This choice is only valid for the disc if it has not been removed from the disc drawer.

The menus of your DVD recorder do not appear in the language you want

- Check that your language is available in the settings menu. If not, choose another language.

You can't access the selected menu, even when you press OK

- If the name of the menu appears on a transparent background, it means that the corresponding menu or function is not available. The **Disc**, **Titles** and **Playlist** menus are contextual menus: they depend on operations performed beforehand such as:
 - **Disc** is only accessible if there is a disc in the disc tray of your DVD recorder.
 - **Titles** is only accessible once you have recorded a TV program or video sequence (from an external device).

Your DVD recorder menu disappears

- As with computers, your DVD recorder has a screen saver which replaces the fixed menu by a mobile THOMSON logo. Press on a navigation key to bring back the fixed menu.

You can't switch channels

- During the recording of a TV program (or video sequence from a connected device), switching channels is impossible. To change channels, you have to stop the recording completely.

In quiet moments, you hear a slight hum coming from your DVD recorder

- Your DVD recorder is equipped with a fan. It switches on as soon as your DVD recorder is turned on and produces a slight hum.

The TV guide (NAVICLICK) is not displayed

- Downloading may be disabled. Make sure that **Off** is not ticked.
- Does the channel broadcast a TV guide ?

Other problems

Reconfiguring your player's initial set-up

- Open the disc tray and make sure there is no disc in it. Close the tray. Hold down the **AV** key of your DVD recorder, then press the **OPEN/CLOSE** key by holding it down for 3 seconds, until *INIT* is displayed on the screen of your DVD recorder. When *MENU* reappears on your display, turn off and then turn on your DVD recorder using the **ON/STANDBY** button on the front. The menu displayed on screen is the menu which enables you to choose your DVD recorder's display language. It confirms that all settings made since initial installation have been deleted. The DVD recorder has been reconfigured as it was when purchased (factory settings). Restart the installation of your DVD recorder.

If you forget your password

- Open the player's disc tray and ensure that there is no disc on it. Close the tray. The player menu is now displayed on the TV screen. Now press the **STOP** key on your player and hold the **STOP** key on the remote control unit down for 3 seconds. The password that you chose for parental control is cancelled. The close padlock on your recorder's display disappears.

Further information

Other important information

For your safety

Never open the player or any of its components. It can be dangerous for you or for certain fragile components. You could receive an electric shock or touch the laser beam. Do not place your eyes close to the opening of the disc tray or any other opening to look inside the player.

Disclaimer of warranty!

To the extent allowed by applicable law, representations and warranties of non-infringement of copyrights or other intellectual property rights resulting from the use of this product under conditions other than as specified above, are hereby excluded.

DVD copy protection

In accordance with the DVD standard, your DVD recorder is equipped with a Copy Protection system, which can be triggered on and off by the DVD disc itself, in order to make any recording of the concerned DVD disc onto a videotape of very poor picture quality, or even impossible. "This product incorporates copyright protection technology that is protected by method claims of certain U.S. patents and other intellectual property rights owned by Macrovision Corporation and other rights owners. Use of this copyright protection technology must be authorized by Macrovision Corporation, and is intended for home use only unless otherwise authorized by Macrovision Corporation. Reverse engineering or disassembly is prohibited."

Condensation / moisture / heat

If your DVD recorder or a disc have been stored in a cold atmosphere, as for example during transportation in the winter, wait for approximately 2 hours until they have reached room temperature.

Protect the DVD recorder from moisture and excess heat (e.g. fireplace) or equipment creating strong magnetic or electric fields (i. e. speakers...). Disconnect the power cable from the mains electricity supply if the DVD recorder malfunctions.

Note: Dolby Digital is a sound compression technique developed by Dolby for multi-channel digital audio signals. The Dolby Digital system enables any audio channel configuration, from a stereo sound (2 channels) up to the digital "surround" sound 5.1.

Manufactured under license from Dolby Laboratories. "Dolby" and the double-D symbol are trademarks of Dolby Laboratories.

DTS - is a digital sound compression technique developed by Digital Theater Sound Systems for digital audio multichannel signals.

"DTS" and "DTS Digital Out" are registered trademarks of Digital Theater Systems inc.



Further information

Technical data

Power requirements 230 V - 50 Hz

Power consumption:

- Operating < 30 W
- Standby < 3 W

Hard disc capacity: 80Gb (DTH 8640)
160Gb (DTH 8650)

Functioning conditions +5°C to + 35°C surrounding humidity: 80 % maximum

Playback system 2 Laser diodes - Wave length: 655 / 780 nm, Laser power CLASS 2

Reception norms LL' - BG - I - DKK'

Number of storable channels 99

Nominal Specification - THOMSON reserves the right to change the specifications without notice. The characteristics and aspect of the product may be changed without prior notification. The colour and aspect of the product may differ from that represented in this manual.