



Emerson[®]

PORTABLE CD, CD-R / RW PLAYER
with AM/FM DIGITAL TUNER
and CASSETTE RECORDER



OWNER'S MANUAL

PD6850

Visit our web site at www.emersonradio.com





CAUTION

TO PREVENT FIRE OR SHOCK HAZARD, DO NOT USE THIS PLUG WITH AN EXTENSION CORD, RECEPTACLE OR OTHER OUTLET UNLESS THE BLADES CAN BE FULLY INSERTED TO PREVENT BLADE EXPOSURE. TO PREVENT FIRE OR SHOCK HAZARD, DO NOT EXPOSE THIS APPLIANCE TO RAIN OR MOISTURE.



The lightning flash with arrow-head symbol, within an equilateral triangle is intended to alert the user to the presence of uninsulated 'dangerous voltage' within the product's enclosure that may be of sufficient magnitude to constitute a risk of electric shock to persons.

CAUTION

RISK OF ELECTRIC SHOCK
DO NOT OPEN

WARNING: TO REDUCE THE RISK OF ELECTRIC SHOCK DO NOT REMOVE COVER (OR BACK), NO USER SERVICEABLE PARTS INSIDE REFER SERVICING TO QUALIFIED SERVICE PERSONNEL.



The exclamation point within an equilateral triangle is intended to alert the user to the presence of important operating and maintenance (servicing) instructions in the literature accompanying the appliance.

IMPORTANT SAFETY INSTRUCTIONS

- 1.) Read these instructions.
- 2.) Keep these instructions.
- 3.) Heed all warnings.
- 4.) Follow all instructions.
- 5.) Do not use this apparatus near water.
- 6.) Clean only with dry cloth.
- 7.) Do not block any ventilation openings. Install in accordance with the manufacturer's instructions.
- 8.) Do not install near any heat sources such as radiators, heat registers, stoves, or other apparatus (including amplifiers) that produce heat.
- 9.) Do not defeat the safety purpose of the polarized or grounding-type plug. A polarized plug has two blades with one wider than the other. A grounding type plug has two blades and a third grounding prong. The wide blade or the third prong are provided for your safety. If the provided plug does not fit into your outlet, consult an electrician for replacement of the obsolete outlet.
- 10.) Protect the power cord from being walked on or pinched particularly at plugs, convenience receptacles, and the point where they exit from the apparatus.
- 11.) Only use attachments / accessories specified by the manufacturer.
- 12.) Unplug this apparatus during lightning storms or when unused for long periods of time.
- 13.) Refer all servicing to qualified service personnel. Servicing is required when the apparatus has been damaged in any way, such as power-supply cord or plug is damaged, liquid has been spilled or objects have fallen into the apparatus, the apparatus has been exposed to rain or moisture, does not operate normally, or has been dropped.
- 14.) This appliance shall not be exposed to dripping or splashing water and no object filled with liquids such as vases shall be placed on the apparatus.
- 15.) Do not overload wall outlet. Use only power source as indicated.
- 16.) Use replacement parts as specified by the manufacturer.
- 17.) The product may be mounted to a wall only if recommended by the manufacturer.
- 18.) Upon completion of any service or repairs to this product, ask the service technician to perform safety checks.



BEFORE WE BEGIN

Thank you for purchasing this Emerson audio product. The Emerson brand is your assurance of quality, performance and value.

Our engineers have included many useful and convenient features in this product. Please be sure to read this Owner's Manual completely to make sure you are getting the maximum benefit from each feature.

This product was manufactured using the highest quality components and standards of workmanship. It was tested by Emerson inspectors and found to be in perfect working order before it left our factory. However, there is always the chance that some problem may occur because of rough handling during shipment to the retail store or to the final consumer.

If, after reading this Manual, you experience any problems with the operation of this product, please refer to the instructions for obtaining service at the end of this Manual. Emerson and Emerson retailers are committed to your satisfaction.

Once again, thanks for purchasing this Emerson audio product.

For future reference, record the serial number in the space provided.

Model No: PD6850

Serial No: _____



IMPORTANT NOTES

- Avoid installing this unit in places exposed to direct sunlight or close to heat radiating appliances such as electric heaters, on top of other stereo equipment that radiates too much heat, places lacking ventilation or dusty areas, places subject to constant vibration and/or humid or moist areas.
- Do not attempt to clean this unit with chemical solvents as this might damage the finish. Use a clean dry cloth.
- Operate controls and switches as described in the manual.
- Before turning 'On' the power, make certain that power cord is properly installed.
- Store your CDs, cassettes in a cool area to avoid damage from heat.
- When moving the set, be sure to first disconnect the power cord.

CLASS 1 LASER PRODUCT

CLASS 1 LASER PRODUCT
APPAREIL À LASER DE CLASSE 1
PRODUCTO LASER DE CLASE 1

CAUTION
INVISIBLE LASER RADIATION
WHEN OPEN AND INTERLOCKS
DEFEATED.
AVOID EXPOSURE TO BEAM



This product contains a low power Laser Device.

FCC INFORMATION

This equipment has been tested and found to comply with the limits for a Class B digital device, pursuant to Part 15 of the FCC Rules. These limits are designed to provide reasonable protection against harmful interference in a residential installation. This equipment generates, uses, and can radiate radio frequency energy and, if not installed and used in accordance with the instructions, may cause harmful interference to radio communications. However, there is no guarantee that interference will not occur in a particular installation. If this equipment does cause harmful interference to radio or television reception, which can be determined by turning the equipment off and on, the user is encouraged to try to correct the interference by one or more of the following measures:

- Reorient or relocate the receiving antenna.
- Increase the separation between the equipment and receiver.
- Connect the equipment into an outlet on a circuit different from that to which the receiver is connected.
- Consult the dealer or an experienced radio/TV technician for help.

This device complies with Part 15 of the FCC Rules. Operation is subject to the following two conditions:

- (1) This device may not cause harmful interference, and
- (2) This device must accept any interference received, including interference that may cause undesired operation.

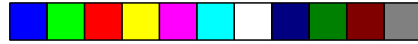

PREPARATION FOR USE

UNPACKING AND SET UP

- Carefully remove the unit and the accessories from the carton and remove all the packing material from the unit.
- Carefully remove any small strips of tape which may have been used to keep the CD and Cassette doors closed during shipment.
- Open the CD compartment by pressing the OPEN/CLOSE position on top right of CD door and lifting upward. Inside the CD compartment you will see a white transit card which is used to prevent the laser pick-up from moving during shipment. Carefully remove this card and close the CD compartment door.
- Please save the carton and packing materials in the event that your unit ever needs to be returned for service. The original carton and packing materials are the only way to protect the unit from damage during shipment.

POWER SOURCES

This unit is designed to operate on 8 pcs "C" batteries, not included, or on normal 120V 60Hz AC house current. Operating this unit from any other power source may cause damage to the unit, and such damage is not covered by your warranty.

AC Operation

Connect the small end of the AC Power Cord to the AC socket on the back cabinet, then insert the plug in any convenient household 120V 60Hz AC outlet.

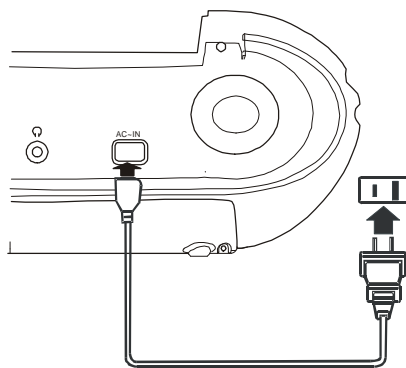



NOTE: This unit has a polarized AC plug with one wide blade and one narrow blade. This plug will only fit into a matching polarized AC outlet. This is a safety feature to reduce the possibility of electric shock. If this plug will not fit in your AC outlet, you probably have an outdated non-polarized outlet. You should have your outdated outlet changed by a qualified, licensed electrician. Do not file the wide blade on the plug, or use an adapter to make the plug fit into your outlet. This defeats the safety feature and could expose you to electric shock.

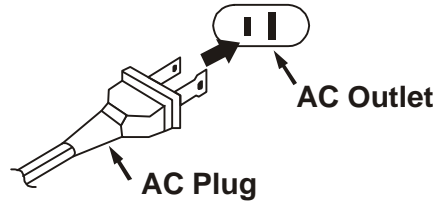

Battery Operation

- 1.) Remove the battery compartment door on the bottom of the cabinet by pressing down on the tab directly below the "OPEN" mark and slide in the direction of the arrow.

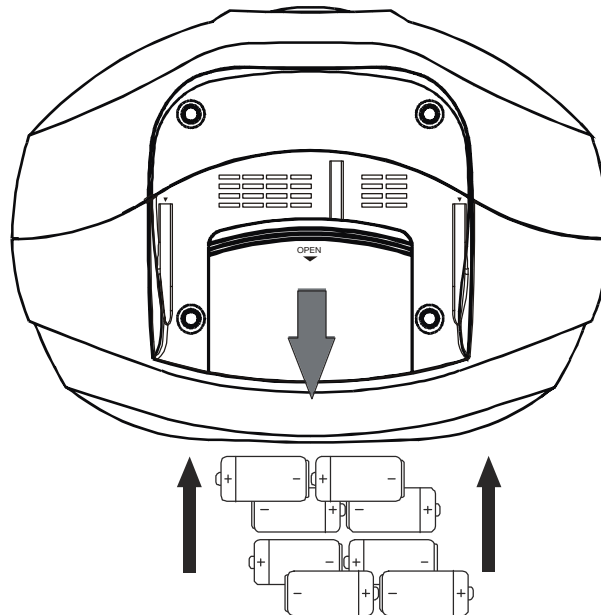



- 2.) Insert 8 pcs “C” size batteries into the battery compartment according to the polarity diagram engraved inside the compartment. If the batteries are inserted incorrectly the unit will not work.
- 3.) Replace the battery compartment door.

NOTE: In order to operate the unit on battery power the AC cord must be disconnected from the AC socket on the back cabinet.

BATTERY PRECAUTIONS

Follow these precautions when using batteries in this device:

1. Use only the size and type of batteries specified.
2. Be sure to follow the correct polarity when installing the batteries as indicated in the battery compartment. Reversed batteries may cause damage to the device.
3. Do not mix different types of batteries together (e.g. Alkaline and Carbon-Zinc) or old batteries with fresh ones.
4. If the device is not to be used for a long period of time, remove the batteries to prevent damage or injury from possible battery leakage.
5. Do not try to recharge batteries not intended to be recharged; they can overheat and rupture. (Follow battery manufacturer's directions.)

PROTECT YOUR FURNITURE !!

This model is equipped with non-skid rubber 'feet' to prevent the product from moving when you operate the controls. These 'feet' are made from non-migrating rubber material specially formulated to avoid leaving any marks or stains on your furniture. However certain types of oil based furniture polishes, wood preservatives, or cleaning sprays may cause the rubber 'feet' to soften, and leave marks or a rubber residue on the furniture. To prevent any damage to your furniture we strongly recommend that you purchase small self-adhesive felt pads, available at hardware stores and home improvement centers everywhere, and apply these pads to the bottom of the rubber 'feet' before you place the product on fine wooden furniture.



LOCATION OF CONTROLS AND INDICATORS

FRONT VIEW

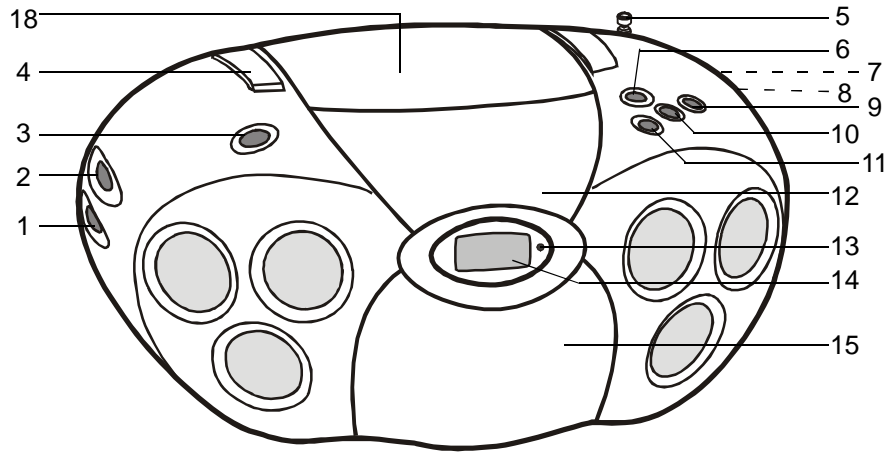

TOP VIEW

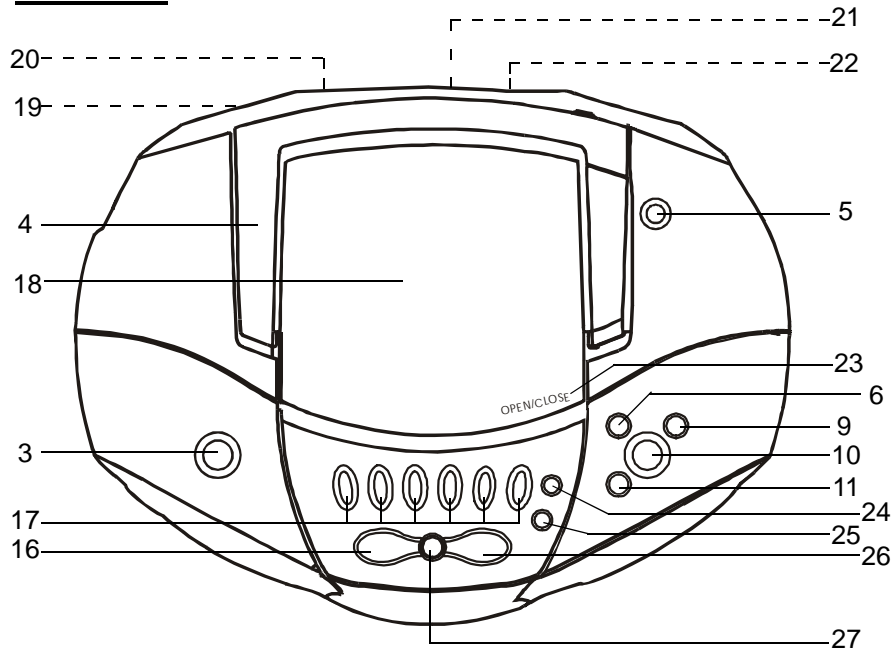

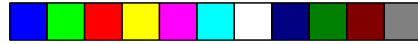

- 1.) VOLUME – Button.
- 2.) VOLUME + Button.
- 3.) POWER On/Off Button.
- 4.) Carrying Handle.
- 5.) FM Telescopic Antenna.
- 8.) FUNCTION Button (On Right Side Panel).
- 6.) SKIP/TUNING ◀◀ Button.
- 7.) SURROUND Button (On Right Side Panel).
- 9.) SKIP/TUNING ▶▶ Button.
- 10.) CD PLAY/PAUSE ▶|| Button.
- 11.) CD STOP ■ Button.
- 12.) Cassette Key Cover.
- 13.) POWER 'On' LED Indicator.
- 14.) Multifunction LCD Display.
- 15.) Cassette door.
- 16.) PRESET << Button (Inside Cassette Key Cover).
- 17.) Cassette Control keys.
(Pause ||/Stop/Eject ■▲/F.Fwd ◀◀/Rewind ▶▶/Play ◀/Record ●)
- 18.) CD door.
- 19.) Battery Compartment (Bottom Cabinet).
- 20.) AC Cord Socket (On Back Panel).
- 21.) BEAT CUT Switch (On Back Panel).
- 22.) Phones 📞 Jack (On Back Panel).
- 23.) CD door OPEN/CLOSE Position.
- 24.) MODE Button (Inside Cassette Key Cover).
- 25.) PROG/MEMORY Button (Inside Cassette Key Cover).
- 26.) PRESET >> Button (Inside Cassette Key Cover).
- 27.) BAND Button (Inside Cassette Key Cover).



OPERATING INSTRUCTIONS

VOLUME AND TONE CONTROLS

Volume Adjustments

Press the VOLUME + or – buttons on the left side panel to increase or decrease the volume. The volume level indicator appears in the main display. The range is from “00 db” (Minimum) to “30 db” (Maximum). The system remembers the volume level when the power is switched ‘Off’ and returns to the same level when the power is switched ‘On’ again.



SURROUND Control

To enjoy a Stereo Wide 3D sound effect, press SURROUND button on right side panel. The ((3D)) indicator appears in the display. The Surround circuit creates the impression that the speakers are further apart than they actually are.





LISTENING TO THE RADIO

- 1.) Press the POWER button on left top panel. The main display and the POWER LED indicator turns "On".
- 2.) If necessary, press the FUNCTION button on the right side panel to select the Radio function. The display will show an AM or FM station frequency. To select a different band, press the BAND button again.

- 3.) Tune to the desired frequency as follows:

- **Manual Tuning**

Repeatedly press the TUNING ►► / ◄◄ buttons on the top panel until the frequency of the desired station appears on the display.



- **Automatic Tuning**

Press and hold the TUNING ►► / ◄◄ buttons until the display begins to move, then release the buttons. The tuner will search up or down the band for the next strong station and stop on that station. Repeat this procedure until the tuner stops on your desired station.

- 4.) Adjust the VOLUME and SURROUND controls as desired.

- 5.) If you tuned to an FM Stereo station the ((ST)) indicator will appear in the main display. If the reception is noisy or weak, press the MODE button (inside the cassette key cover). The ((ST)) indicator will turn 'OFF'. The reception will normally improve although the sound will no longer be in stereo.

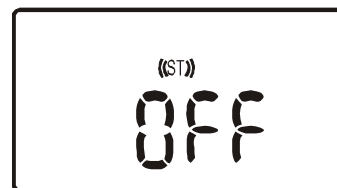

- 6.) When you are finished listening, press the POWER button. The main display and the POWER LED go 'Off'.

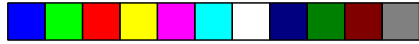

ANTENNA INFORMATION

AM

The AM antenna is inside the cabinet. IF AM reception is unsatisfactory try rotating the entire unit until you find the position that provides the best reception.

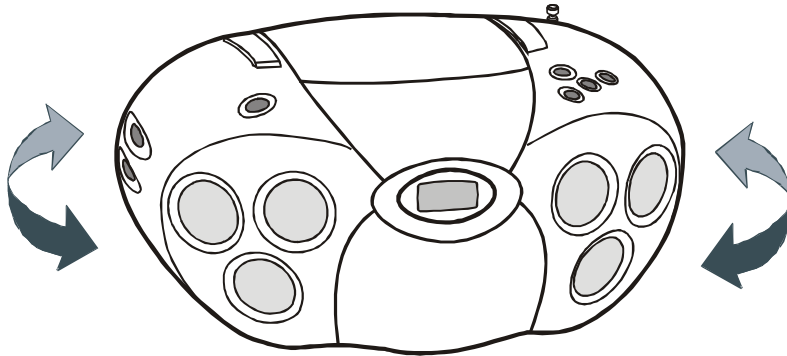

FM

Vary the direction of the FM antenna to find the position that provides the best reception.

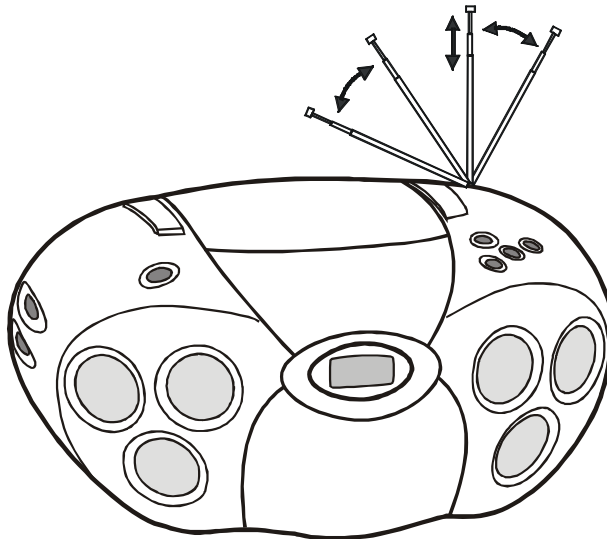



PRE-SETTING STATIONS IN THE TUNER MEMORY

This system includes a 20 station preset memory. You can store up to 10 FM stations and 10 AM stations in the tuner memory for immediate recall. The procedure for storing stations in memory is as follows:

- 1.) Follow step 3 under "LISTENING TO THE RADIO" in page 10 to select the first station you wish to memorize. Example FM 103.50 MHz.



- 2.) When the desired station appears on the display press the PROG/MEMORY button inside the cassette key cover. The Preset # "01" indicator flashes and the "MEMORY" indicator appears in the display.

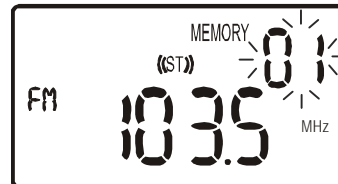

- 3.) Press the PRESET << / >> buttons inside the cassette key cover to select a preset channel number. (Example: Preset channel # 03.)

- 4.) Press the PROG/MEMORY button once more to enter the station in preset memory # 03.



- 5.) Repeat steps 1 through 4, selecting a different preset number in Step 3 each time until you have entered up to 10 FM stations in the tuner memory.
- 6.) Press the BAND button to select the AM band and follow the same procedure to enter up to 10 AM stations in the tuner memory.



RECALLING PRESET STATIONS

Press the POWER button to turn the unit 'On' and select the desired band. Press the PRESET << / >> buttons inside the cassette key cover repeatedly to scroll through the preset memories until the display shows the desired station.

CHANGING PRESET STATIONS

To change any preset station memory select the desired band and tune to the new station you wish to memorize. Press the PROG/MEMORY button and then press the PRESET << / >> buttons to display the memory number you wish to change. Press the PROG/MEMORY button again to enter the new station in the memory. The new station is memorized and the previous station is deleted from the memory.



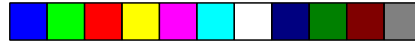

PLAYING COMPACT DISCS

IMPORTANT:

This CD player can play normal CDs plus CD Recordable (CD-R) and CD Rewriteable (CD-RW) discs. However the playability of CD-R and CD-RW discs may be affected by the type of software that was used in 'ripping' the tracks from the original discs and 'burning' the tracks onto the blank media. Playability may also be affected by the quality and condition of the blank media you use for recording. 100% compatibility cannot be guaranteed. This is not an indication of any problems with your player.

- 1.) Press the POWER button to turn the unit 'On'.
- 2.) Press the FUNCTION button on right side panel to select the CD function.

- 3.) Press the OPEN/CLOSE position on the CD door to open the CD door. The main display shows "OPEN". If you have not already done so, remove the 'dummy CD' from the player and discard it.



- 4.) Place a CD on the center spindle with the printed label side facing upward.

- 5.) Close the CD door. The disc will spin and '00:0000' will flash in the display as the player reads the table of contents on the disc. Within a few seconds the disc will stop spinning and the display will show the total playing time and total tracks on the disc.



Note: *If the disc is inserted upside down or if the disc is badly scratched and unreadable, playback will not be possible. In this case the main display will show "no disc". Remove the disc and re insert it properly, or try another disc.*

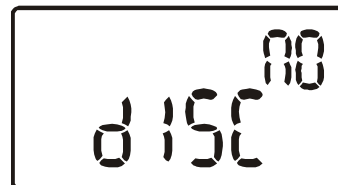



- 6.) Press the PLAY/PAUSE ►|| button on the top panel to begin playback on track 1. The display will show the elapsed playing time of each track as it plays.



- 7.) Adjust the VOLUME and SURROUND controls as desired.

- 8.) When the last track has played the player stops automatically and the display again shows the total playing time and tracks on the disc. You may also stop playback at any time by pressing the STOP ■ button on the top panel.



- 9.) When you are finished listening press the OPEN/CLOSE position to open the CD door and remove the disc.

- 10.) Press the POWER button to turn the unit "Off".

PAUSE CONTROL

To pause momentarily during CD playback press the PLAY/PAUSE ►|| button on the top panel again. The sound stops and the elapsed time display flashes, but the disc continues to spin. Press the PLAY/PAUSE ►|| button once more to cancel Pause mode and resume playback. The elapsed time display stops flashing.

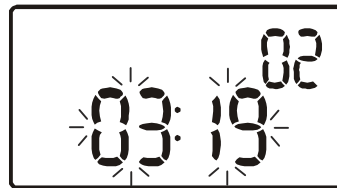



SKIP/SEARCH (▶▶/◀◀) CONTROLS

To skip to higher or lower numbered tracks during playback repeatedly press the SKIP ▶▶/◀◀ buttons on the top panel until the desired track number appears in the display. Playback will begin on the desired track.

To perform high speed search within a track to locate a specific musical passage depress and hold the SKIP ▶▶/◀◀ buttons. The player will move rapidly forward or backward as long as the buttons are depressed. When you hear the desired passage release the buttons and normal playback will resume at that point.

TO START PLAYBACK ON A SPECIFIC TRACK

Load the disc as usual and wait until the total playing time and track numbers appear on the display. Press the SKIP ▶▶/◀◀ buttons on the top panel until the desired track number appears in the display, then press the PLAY/PAUSE ▶▶ button to begin playback on that track.





REPEAT PLAYBACK

You can program the player to continuously repeat a single track or the entire disc. The Repeat function can be activated while a disc is playing or while the disc is stopped.

One Track Repeat

Press the SKIP **▶▶/◀◀** buttons on the top panel until the desired track number appears in the display, then press the MODE button (inside cassette key cover) once. The **↻** indicator appears in the display. Press the PLAY/PAUSE **▶||** button to begin playback on that track. The selected track will be repeated continuously.



All Tracks Repeat

Load the disc as usual and wait until the total playing time and track numbers appear on the display. Press the MODE button twice. The “**↻ ALL**” indicator appears in the display. Press the PLAY/PAUSE **▶||** button to begin playback. The entire disc will be repeated continuously.



To cancel Repeat Playback continue pressing the MODE button until the “**↻ ALL**” indicator disappears. Repeat is also canceled by opening the CD Door or changing to other function.



INTRO SCAN PLAYBACK

This feature allows you to play just the first 10 seconds of each track on the disc. This may be useful when you are trying to locate a specific song but you do not remember the title.

Load the disc as usual and wait until the display shows the total playing time and number of tracks. Press the MODE button inside cassette key cover, until the INTRO indicator flashes in the display.



Press the PLAY/PAUSE ►|| button. The player will play the first 10 seconds of each track automatically. When the first 10 seconds of the last track has played the player stops and the display again shows the total playing time and number of tracks on the disc.

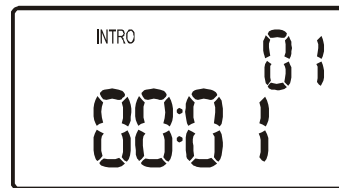

To cancel the Intro mode press the MODE button until the INTRO indicator disappears. Intro mode can also be canceled by pressing the STOP ■ button.



RANDOM PLAYBACK

This feature allows you to play all the tracks on a disc in random order.

Load the disc as usual and wait until the display shows the total playing time and number of tracks. Press the MODE button four times. The RANDOM indicator flashes in the display.



Press the PLAY/PAUSE ►|| button. The tracks will be played in random order. After all tracks have played the player stops and the display again shows the total playing time and number of tracks.



To cancel the Random mode press the MODE button until the RANDOM indicator disappears.

Random mode can also be canceled by pressing the STOP ■ button.





PROGRAMMED PLAYBACK

You can program up to **32** tracks on a disc to playback in any desired order. You may also program a specific track to play several times within the same program.

Note: *The player cannot be programmed while a disc is playing. If a disc is playing press the STOP ■ button to stop playback before you begin the programming steps below.*

- 1.) Press the FUNCTION button to select CD, insert your disc in the player, close the door, and wait until the total track number appears in the display.

- 2.) Press the PROG/MEMORY button once. The MEMORY indicator, Program memory "P-01" and Track # "00" appear in the display.

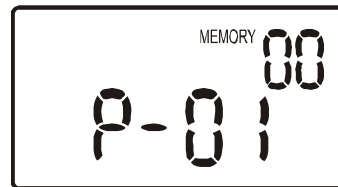

- 3.) Use the ►►/◄◄ buttons to select the first track to be programmed. (Example: Track 08).

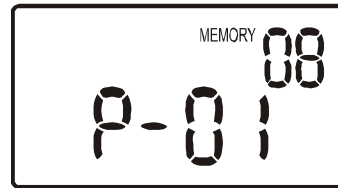

- 4.) When track number "08" appears in the display, press the PROG/MEMORY button once again to enter the track "08" in program memory number "01". The track number returns to "00" and the program memory advances to "P-02" indicating that you may now select a track to be entered in program memory number "02".

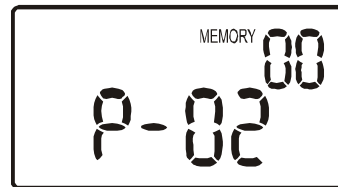

- 5.) Use the ►► or ◄◄ buttons to select the next track to be programmed. When the desired track number appears in the display press the PROG/MEMORY button again to enter that track in the program memory.

- 6.) Repeat Step 5 until you have entered up to 32 tracks in the program memory.



7.) To begin programmed playback press the PLAY/PAUSE ►|| button. The display will show the first programmed track and playback will begin on that track. The MEMORY Indicator remains in the display.

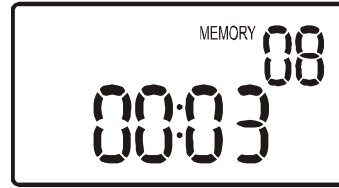

After the last programmed track has played the player stops but the programmed tracks remain in the memory. To play the programmed tracks again, press the PROG/MEMORY button and then the PLAY/PAUSE ►|| button.

To cancel the programmed sequence from memory, press the STOP ■ button at programming mode or open the CD door.

Program Repeat Playback

You can use the Program and Repeat features together to continuously repeat a programmed sequence of tracks. First, program the desired tracks according to Steps 1 through 7 on the previous page. When Programmed Playback begins press the MODE button twice to activate the All Tracks Repeat feature. The "⏮ ALL" Indicator appears in LCD display and all the tracks in your programmed sequence will be repeated continuously.

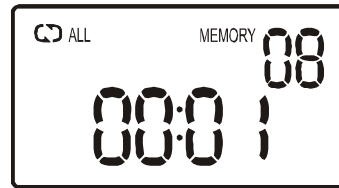

To cancel Programmed Repeat Playback press the STOP ■ button until both the MEMORY and "⏮ ALL" Indicators go 'Off'.



PLAYING CASSETTE TAPES

- 1.) Press the FUNCTION button to select TAPE mode. The TAPE indicator appears in the display.





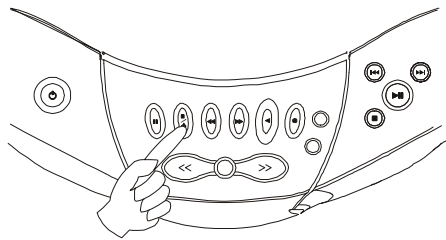

- 2.) Open the cassette door by pressing the Stop/Eject  key inside the cassette key cover.

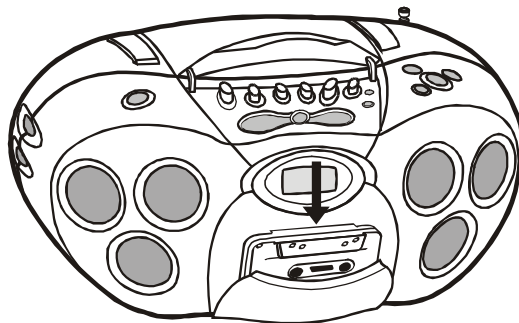

- 3.) Place a pre-recorded cassette tape into the slots on the inside of the door with the exposed tape facing up and the full reel on the right side. Close the cassette door.



- 4.) Press the cassette Play  key to begin playback.
- 5.) Adjust the VOLUME and SURROUND controls as desired.
- 6.) To advance the tape rapidly press the F. Fwd  key. When you reach the desired point press the Stop/Eject  key.
- 7.) To rewind the tape rapidly press the Rewind  key. When you reach the desired point press the Stop/Eject  key.



- 8.) When the tape ends the Automatic Stop System releases the Play ◀ key and shuts off the tape motor. You may then open the cassette door, remove your tape, turn it over and play the other side if desired.
- 9.) When you are finished listening press the Stop/Eject ■▲ key to stop the tape, open the door, remove the tape and close the door. If you are playing a tape and then change to the RADIO or CD function be sure to press the Stop/Eject ■▲ key to disengage the tape mechanism. This prevents excess wear and tear on the mechanism.

IMPORTANT:

Always press the Stop/Eject ■▲ key to shut off the tape motor before opening the cassette door to remove your tape. The Automatic Stop System does not function in the F. Fwd ◀◀ and Rewind ▶▶ modes. When the tape ends in the F. Fwd◀◀ and Rewind ▶▶ modes the motor continues to run. You must press the Stop/Eject ■▲ key to shut off the motor before opening the door to remove your tape.









MAKING A TAPE RECORDING

This model allows you to make tape recordings directly from the CD player, or the radio.

- Refer to **“PLAYING COMPACT DISCS”** if necessary to operate the CD player.
- Refer to **“LISTENING TO THE RADIO”** if necessary to tune in the station you wish to record from radio.

- 1.) Press the Stop/Eject  key to open the cassette door.
- 2.) Insert a good quality blank cassette tape into the slots on the cassette door with the open end facing up and the full reel on the right. Use normal tape only. Do not use tape identified as “CrO₂” (Chrome) or “Metal” tape formulations. For best results use tapes of 60 minutes (C-60) or less. Do not use 90 minute or 120 minute tapes as these thinner tapes are more likely to jam in the mechanism.
- 3.) Close the cassette door.
- 4.) When you are ready to start recording press the Record  key. The Play  key will also engage. The CD you are playing, or radio program you selected will be recorded directly on to the tape.
- 5.) Press the Pause  key during recording to stop the tape temporarily and avoid recording unwanted material such as radio commercials.
- 6.) When you have finished recording press the Stop/Eject  key to stop and remove the tape.

BEAT CUT SWITCH (On back Cabinet)

Occasionally when recording from the AM radio a repetitive whistle or ‘beat’ sound may be heard. If this occurs slide the BEAT CUT switch to its other position to eliminate the unwanted sound.



CD CASSETTE SYNCHRO RECORDING

When recording from CD to cassette, the CD cassette synchro recording feature in this unit allows you to start both the CD player and the cassette recorder with the push of a single button.

- 1.) Open the CD door and place the CD to be recorded in the CD player as usual. Close the CD door.
- 2.) Open the cassette compartment and insert a blank cassette tape.
- 3.) Press the FUNCTION button to select the CD mode.
- 4.) Press the cassette Record ● key. The SYNC indicator appears in the display. The cassette recorder and the CD player will start simultaneously and all of the material on your CD will be recorder directly onto the blank cassette.

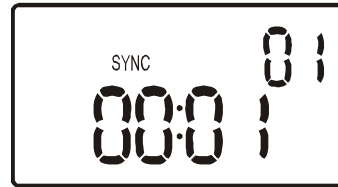

Note: If a CD is already playing and you press the cassette Record ● key, the CD player will begin recording at that point automatically.

Automatic Recording Volume Level Control

This unit has an Automatic Level Control (ALC) circuit which controls the recording volume level and prevents overloaded and distorted recordings. The VOLUME and SURROUND controls have no effect on recording volume level. You may change the control settings during the recording or even reduce the volume level to "Minimum". This will not effect the level of the recording.

STEREO HEADPHONE JACK

Connect a set of stereo headphones (not included) with a 3.5mm mini plug to the Phones  jack (located at back cabinet) for private listening without disturbing others. Before putting on the headphones reduce the VOLUME control to a low level, then put the headphones on and gradually increase the VOLUME control to a comfortable listening level. The built in speakers are automatically disconnected when headphones are connected to the headphone jack.



CARE AND MAINTENANCE

ABOUT CASSETTE TAPES

Whenever you record on a cassette any previously recorded material is erased as the new material is recorded. To prevent you from accidentally erasing material which you wish to save, blank cassettes are equipped with erase prevention tabs for each side of the tape. If the erase prevention tab for side A is removed, you cannot accidentally record on side A. The record key cannot be depressed if the erase prevention tab on the cassette has been removed.

To prevent accidental erasing on side A of a cassette use a small screw driver or similar tool to break off the erase prevention tab for side A. This prevents the record key from locking.

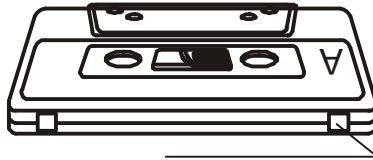

TAB FOR SIDE A
BREAK OUT TO PREVENT RECORDING

If later you do wish to record on side A of the cassette, cover the tab opening with a piece of cellophane tape. This will allow the record key to function again.

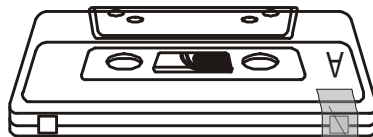

COVER OPENING WITH TAPE
IN ORDER TO RECORD AGAIN.



CASSETTE CARE

Two common causes of trouble experienced when using cassettes are:

- 1.) Tape jamming — Leading to uneven speed in playback, and
- 2.) Tape tangling — Where the tape wraps itself around vital parts of the mechanism.

To reduce the likelihood of these problems occurring, the following precautions should be observed:

- Check that there are no loose layers of tape visible through the cassette center window (see Fig. 1). Take up any loose layers, using a pencil or hexagonal barrelled ballpoint pen, before inserting the cassette into the machine (see Fig. 2).

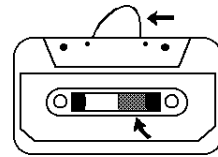

Fig.1

- If the cassette feels “tight” while performing operation shown (see Fig. 2), the tape may be jamming due to “ridges” formed in the winding of the tape (visible through the center window). These may be removed, in most cases, by fast winding of the cassette from one end to the other and back again.

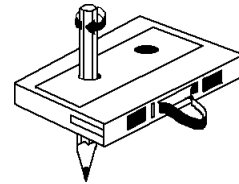



Fig.2

- Use only well-known brands of tape. Avoid use of C-120 cassettes.

Furthermore, do not expose cassettes to direct sunlight, dust or oil, and do not touch the tape surfaces.

HEAD CLEANING

The tape heads, pinch roller and capstan require periodic cleaning. This removes particles of the metal oxide coating that wear off the tape and accumulate on these parts and impair performance. Switch off the power, press the Stop/Eject  key to open the cassette door, and press the Play  key. Clean the tape heads, pinch roller and capstan with a soft cloth or cotton pad dampened in isopropyl alcohol or special tape head cleaner.

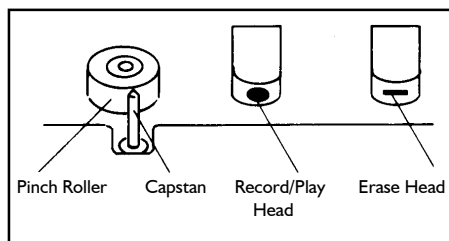

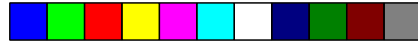

COMPACT DISC CARE

- To remove a disc from its storage case, press down on the center of the case and lift the disc out, holding it carefully by the edges.



- Fingerprints and dust should be carefully wiped off the disc's recorded surface with a soft cloth. Unlike conventional records, compact discs have no grooves to collect dust and microscopic debris, so gently wiping with a soft cloth should remove most particles. Wipe in a straight line from the inside to the outside of the disc. Small dust particles and light stains will have absolutely no effect on reproduction quality.

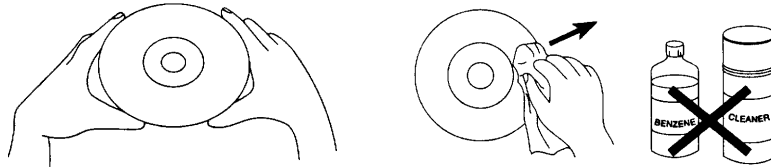

- Clean the disc periodically with a soft, lint-free, dry cloth. Never use detergents or abrasive cleaners to clean the disc. If necessary, use a CD cleaning kit.
- Never write on or affix labels to the surface of compact discs.

CARE OF THE CABINET

If the cabinet becomes dusty wipe it with a soft dry dust cloth. Do not use any wax, polish sprays, or abrasive cleaners on the cabinet.

CAUTION

Never allow any water or other liquids to get inside the unit while cleaning.



LIMITED WARRANTY

Emerson Radio Corp. warrants manufacturing defects in original material, including original parts and workmanship, under normal use and conditions, for a period of ninety (90) days from the date of original purchase in the U.S. With your dated proof of purchase, we will provide repair service at no charge for labor and parts at an authorized Depot Repair Facility, or replace the product in our discretion. For repair or replacement, pack your unit in a padded box, enclose your check or money order payable to Emerson Radio Corp. in the amount of \$9.00 (not required by California residents) to cover shipping and handling costs, and enclose a copy of your proof of purchase. Send your unit to:

Emerson Radio Corp.
1901 Diplomat Drive.
Farmers Branch, TX 75234.

This warranty does not cover damage from negligence, misuse, abuse, accident, failure to follow operating instructions, commercial use, rental, repairs by an unauthorized facility, or products purchased, used, serviced or damaged outside of the United States.

THIS WARRANTY GIVES YOU SPECIFIC LEGAL RIGHTS, AND YOU MAY ALSO HAVE OTHER RIGHTS WHICH VARY FROM STATE TO STATE.

AU898M

 Emerson [®] SERVICE	TO FIND THE LOCATION AND PHONE NUMBER OF YOUR NEAREST SERVICE CENTER PERMITTED TO PERFORM WARRANTY...
CALL TOLL FREE: 1-800-695-0098	
FOR ADDITIONAL SET-UP OR OPERATING ASSISTANCE PLEASE CALL: 1-800-898-9020	
FOR CUSTOMER SERVICE, PLEASE WRITE TO: Emerson Radio Corp. Consumer Affairs Dept. 1901 Diplomat Drive, Farmers Branch, TX 75234.	



EMERSON RADIO CORP.

EMERSON
Part No.: 16-2906
306-01

Printed in China