

ALESIS Q20

User Manual

Introduction

Thank you for purchasing the Alesis Q20 Professional 20-Bit Master Effects Processor. To take full advantage of of the Q20's fuctions, and to enjoy long and trouble free use, please read this user's manual carefully.

How To Use This Manual

This manual is divided into the following sections describing the various modes of the Q20. Though we recommend you take time to read through the entire manual once carefully, those having general knowledge about effects devices should use the table of contents and index to reference specific functions while using this device. If you are planning to use the digital I/O, read Chapter 7 carefully.

Chapter 1: Setting Up. Deals with the necessary preparation before using, including connections to other components, such as instruments, mixing consoles, and multitrack recorders, as well as digital connections to ADAT.

Chapter 2: Your First Session with the Q20. A basic introduction to getting the unit up and running, auditioning the factory Programs, adjusting levels, comparing and storing edited Programs.

Chapter 3: Overview. A detailed look at the signal processing capabilities of the Q20, the concepts of multi-effect programming, and a description of the many available effects.

Chapter 4: Making Your Own Programs. A guided tour for programming typical single and multi-effect applications.

Chapter 5: Description of Controls. A "dictionary" of all parameters, buttons and connectors, including Global and MIDI mode parameters.

Chapter 6: Advanced Applications. Advanced uses of the Q20, such as MIDI functions, Modulation, Local Generators, footswitches and using "tap tempo" to control delay times.

Chapter 7: Digital Connections. How to use the Q20's digital ins and outs in an all-digital studio.

Chapter 8: Troubleshooting. Contains the Troubleshooting Index, maintenance and service information, and MIDI implementation chart.

Conventions

The buttons, knobs, and rear panel connectors are referred to in this manual just as their names appear on the Q20, using all capital letters and in brackets (*Examples: [PROGRAM] button, [< BLOCK] button, [VALUE/ENTER] knob/button, [DIGITAL IN] connector, etc.*).



When something important appears in the manual, an icon (like the one on the left) will appear in the left margin. This symbol indicates that this information is vital when operating the Q20.

CONTENTS

1: Setting Up	7
Unpacking and Inspection.....	7
AC Power Hookup.....	7
Line Conditioners and Protectors.....	7
Audio Connections.....	8
Typical Applications.....	8
Interfacing Directly with Instruments.....	9
Interfacing to a Mixing Console.....	10
When to use Balanced Connectors.....	15
Avoiding Ground Loops.....	15
MIDI	16
Digital Connections.....	16
Footswitches.....	17
Advance	17
Bypass.....	17
Tap Tempo.....	18
2: Your First Session With The Q20	19
Powering Up	19
Setting Levels.....	19
The Value/Enter Knob.....	20
Adjusting the Display Contrast	20
Auditioning Internal Programs.....	21
Switching Between Preset and User Banks	21
Example Programs.....	22
96: "VerbOfMyDreams"	22
97: "Guitar Rack "	22
98: "Stereo Plates"	22
Adjusting Effects Levels.....	23
Comparing an Edited Program to its Original Settings.....	24
Restoring an Edited Program to its Original Settings	24
Storing Edited Programs.....	25
Auditioning Programs before Storing.....	25
Bypassing Effects.....	26
Global Direct Signal Muting.....	26
3: Overview	27
The Architecture of the Q20	27
What is a Block?	27
Selecting and Editing Blocks.....	27
Routing "Patch Cords" Between Blocks	28
Quick Route	29
Setting the Routing Levels.....	29
The L/R IN.....	30
Reaching the Outputs - L/R OUT.....	30
Limit Handling.....	30
Equalization.....	32
Filters	32
Shelving EQs.....	33
Single Band EQs.....	33

Multiband EQs.....	34
5 Band Graphic EQ.....	34
Resonator.....	35
Mono/Stereo Tremolo	35
Stereo Simulator.....	35
Overdrive.....	36
Triggered Panning with Doppler.....	37
Phase Inverter	38
Pitch Effects	39
Mono Chorus	39
Stereo Chorus.....	39
Quad Chorus.....	40
Mono Flanging.....	40
Stereo Flanging.....	41
Phasor.....	41
Mono/Stereo Lezlie Cabinet	41
Pitch Shifter	42
Pitch Detune.....	42
Ring Modulator.....	42
Triggered Flanging.....	42
Delay.....	44
Mono Delay and Stereo Delay	44
Ping Pong Delay.....	44
Multi Tap Delay.....	44
Tap Tempo Mono Delay and Ping Pong.....	44
Sampling.....	45
Reverberation.....	49
Mono Room.....	49
Room 1.....	49
Hall 1.....	49
Plate 1.....	49
Chamber 1	49
Room 2.....	49
Hall 2.....	49
Plate 2.....	50
Chamber 2	50
Large Plate.....	50
Large Room.....	50
Spring.....	50
Nonlinear.....	50
Reverse.....	50
Reverb Parameters.....	51
Decay.....	51
Damping – Hi & Lo	51
Reverb Density	51
Diffusion	51
Input High Frequency Roll Off.....	52
Predelay.....	52
Predelay Mix.....	52
Reflection Level and Spread.....	52
Reverberation Swirl.....	52
Reverberation Attack.....	52
Gating	53

4: Making Your Own Programs	55
Getting Started.....	55
Programming A Single Block.....	56
Type.....	56
Routing.....	57
Parameter.....	59
Mix.....	60
Programming Multiple Blocks.....	61
Defining New Blocks.....	61
Deleting Unnecessary Routings	62
Patching In The New Blocks.....	62
Adjusting Parameters	62
Moving , Swapping and Copying Blocks	64
Block Move.....	64
Block Copy & Paste.....	65
Changing Effect Types.....	66
5: Description of Controls.....	67
Front Panel	67
Input Level	67
Output Level.....	67
LED Meter	67
Display.....	67
Value /Enter.....	68
Program.....	69
Store.....	70
Compare.....	70
Bypass.....	71
< Block >.....	71
< Page >	71
Type.....	72
Parameter.....	72
Routing.....	73
Mix.....	73
Global	74
Name	76
MIDI	76
Modulation.....	78
Power	78
Rear Panel.....	79
Power	79
MIDI In.....	79
MIDI Thru/Out.....	79
Bypass.....- Bypass Footswitch.....	79
Advance	- Program Advance Footswitch
48kHz in.....	- Sample Clock Input
Digital In	- ADAT Digital Audio In.....
Digital Out.....	- ADAT Digital Audio Out.....
Digital In	- S/PDIF Digital Audio In.....
Digital Out.....	- S/PDIF Digital Audio Out
Left/Right In.....	- Analog Audio In.....
Left/Right Out	- XLR Analog Audio Out.....
Left/Right Out	- 1/4" Analog Audio Out.....

Effect Parameters.....	81
Equalization.....	81
Pitch.....	82
Delay.....	83
Reverberation.....	84
6: Advanced Applications.....	87
MIDI Functions.....	87
Global MIDI Channel.....	87
Receiving Program Changes.....	87
Selecting Banks via MIDI.....	88
Program Change Table.....	88
SysEx Storage.....	89
MIDI Thru.....	90
Realtime Modulation Functions.....	91
Selecting the Modulator.....	91
Choosing a Target.....	92
Choosing a Source.....	95
Setting the Amplitude.....	95
Local Generators.....	96
Footswitch Controls.....	101
Program Advance.....	101
Bypassing Effects.....	101
Block Bypass via MIDI.....	102
Controlling Delay Time via Tap Tempo.....	102
MIDI Control of Tap Tempo Delay.....	103
7: Digital Connections.....	105
Overview.....	105
Digital Clock Synchronization.....	105
Connections.....	107
To a Single ADAT.....	107
To Two or More ADATs.....	108
To Two or More ADATs with a BRC or AI-2.....	109
To a Digital Mixer.....	109
To the AI-1.....	110
From a QuadraSynth or QS-Series Synthesizer.....	110
Routings.....	111
To specific ADAT tracks.....	111
From ADAT through the Q20 back to ADAT.....	112
From the QuadraSynth or QS-Series through the Q20 back to ADAT.....	113
8: Trouble-Shooting.....	115
Trouble-Shooting Index.....	115
Checking the Software Version.....	116
Re-initializing.....	116
Total Reset.....	116
Error Messages.....	117
Maintenance/Service.....	118
Refer All Servicing To Alesis.....	118
Obtaining Repair Service.....	118
MIDI Implementation Chart.....	119
Specifications.....	120
Effects Processing Index.....	122

CHAPTER 1

SETTING UP

Unpacking and Inspection

Your Q20 was packed carefully at the factory, and the shipping carton was designed to protect the unit during shipping. Please retain this container in the highly unlikely event that you need to return the Q20 for servicing.

The shipping carton should contain the following items:

- This instruction manual
- Alesis Q20 with the same serial number as shown on shipping carton
- AC Power Cable
- Alesis warranty card
- Quick Reference Guide



It is important to register your purchase; if you have not already filled out your warranty card and mailed it back to Alesis, please take the time to do so now.

AC Power Hookup

The Q20 includes an internal universal power supply which is compatible with any line voltage from 90-265 VAC, 50-60 Hz. It also includes a removable IEC power cable suitable for use in the country shipped to.

Note that the Q20 uses a soft power switch which will turn the unit on when plugged in. It is good practice to turn your mixer inputs or returns down while connecting the Q20.



Alesis cannot be responsible for problems caused by using the Q20 or any associated equipment with improper AC wiring.

Line Conditioners and Protectors

Although the Q20 is designed to tolerate typical voltage variations, in today's world the voltage coming from the AC line may contain spikes or transients that can possibly stress your gear and, over time, cause a failure. There are three main ways to protect against this, listed in ascending order of cost and complexity:

- Line spike/surge protectors. Relatively inexpensive, these are designed to protect against strong surges and spikes, acting somewhat like fuses in that they need to be replaced if they've been hit by an extremely strong spike.
- Line filters. These generally combine spike/surge protection with filters that remove some line noise (dimmer hash, transients from other appliances, etc.).
- Uninterruptible power supply (UPS). This is the most sophisticated option. A UPS provides power even if the AC power line fails completely. Intended for computer applications, a UPS allows you to complete an orderly shutdown of a computer system in the event of a power outage, and the isolation it provides from the power line minimizes all forms of interference—spikes, noise, etc.

Audio Connections

The connections between the Q20 and your studio are your music's lifeline, so use only high quality cables. These should be low-capacitance shielded cables with a stranded (not solid) internal conductor and a low-resistance shield. Although quality cables cost more, they do make a difference. Route cables to the Q20 correctly by observing the following precautions:

- Do not bundle audio cables with AC power cords.
- Avoid running audio cables near sources of electromagnetic interference such as transformers, monitors, computers, etc.
- Use balanced cables whenever possible.
- Do not place cables where they can be stepped on. Stepping on a cable may not cause immediate damage, but it can compress the insulation between the center conductor and shield (degrading performance) or reduce the cable's reliability.
- Avoid twisting the cable or having it make sharp, right angle turns.
- Never unplug a cable by pulling on the wire itself. Always unplug by firmly grasping the body of the plug and pulling directly outward.
- Although Alesis does not endorse any specific product, chemicals such as Tweek and Cramolin, when applied to electrical connectors, are claimed to improve the electrical contact between connectors.

Typical Applications

The analog audio inputs and outputs are typically used in one of three ways:

- from one or two effect/aux send outputs of a mixer, and out to the effect return inputs of the mixer; or,
- from a line-level instrument (like a guitar or keyboard with either a mono or stereo output), and out to an amplifier or mixer input; or,
- from the stereo buss outputs of a mixer to a mix-down tape machine or amplifier.

When used with a mono source, the Q20 is placed between the source and the mixer/amplifier. Although the source may be mono, both the [LEFT] and [RIGHT] outputs can be connected to the inputs of a mixer/amplifier if stereo processing effects are desired. Alternatively, you could use the INSERTS on your mixer to "patch in" only the left or right channel of the Q20. If using the effect sends of a mixer, you have the advantage of sending any of the mixer's input channels to the Q20's input(s), and have control over the level of each channel being sent.

There are other combinations of input and outputs possible when you begin using the Alesis optical digital input and output. See the "Digital Connections" section later in this Chapter. For more information on interfacing with other digital audio equipment, see Chapter 7.

Interfacing Directly with Instruments



When connecting audio cables and/or turning power on and off, make sure that all devices in your system are turned off and the volume controls are turned down.

The Q20 has two balanced inputs and two balanced outputs. These provide three different (analog) audio hookup options:

- **Mono.** Connect a cable to the [L] INPUT of the Q20 from a mono source, and another cable from the [L] OUTPUT of the Q20 to an amplification system or mixer input.
- **Mono In, Stereo Out.** While still using a mono input, you could connect two cables to the [L] and [R] OUTPUTS of the Q20 to a stereo amplification system or two mixer inputs.

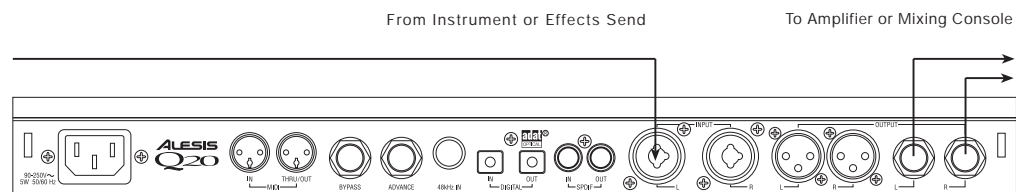

- **Dual Mono or Stereo Source.** The Q20 may be used with two different instruments simultaneously, or with a stereo instrument. The hookup is the same; the difference is in the routing used within a program. A program may process the two inputs discretely, using blocks dedicated to a single channel (for example, a delay for a guitar and a gated reverb for a bass), or process them in stereo (for example, with the left and right outputs of a keyboard routed through two reverb blocks). Connect two cables to the [L] and [R] INPUTS of the Q20 from two mono sources or from the stereo output of the instrument, then connect two other cables from the [L] and [R] OUTPUTS of the Q20 to a stereo amplification system or two mixer inputs.

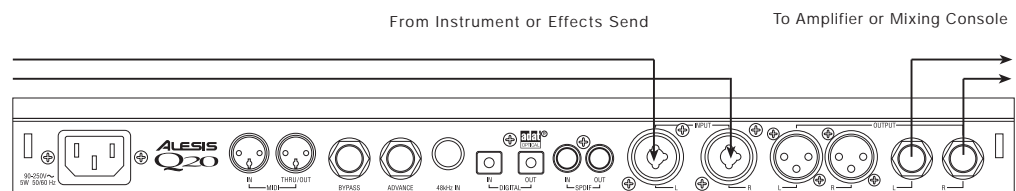

Note: In most cases when plugging an instrument directly into the Q20, you'll use Programs which route the "dry" signal at the input(s) directly to the output(s), where it will be mixed together with the effected signal to achieve the proper wet/dry mix at the Q20's outputs. If the program doesn't include this routing, you will only hear the effected signal by itself. Therefore, it may be necessary to edit such programs to add these "dry" routes when using the Q20 directly with an instrument. (The Factory Preset programs usually include these routes.)

Interfacing to a Mixing Console

The Q20 handles mono or stereo sends at all system levels. The input circuitry of the Q20 can easily handle +4 dBu levels (+17.5 dBu peaks), while having enough input and output gain to interface with the lower -10 dBV signal levels of many recording systems.

The Q20 may be connected to a mixing console in several ways. Usually, it is connected to the auxiliary send and return controls of the mixer. Another method of interfacing is to connect the unit directly to the insert send and return patch points of the channel that is to be effected. Still another way of interfacing the Q20 to a mixer or recording console would be in-line across the output of your mixing console. This last setup would be used only if you needed to effect the entire mix.

Using the Aux Sends

Generally, mixing consoles provide two types of auxiliary sends: pre-fader sends for creating a cue (headphone) mix, and individual, post-fader effect sends. Typically, if a mixer has more than two sends per channel (4, 6 or 8, perhaps), the first two sends are reserved for the cue sends, while the remaining sends are used to feed effects. If you are using a mixer with more than two sends, connect the Q20 using post-fader sends.

Using a mixer's aux sends poses a distinct advantage: each channel has its own level control feeding the aux output (and eventually the Q20 input). This allows you to make a mix of any channels you want to go to the effects by using the individual channels' aux send levels on the mixer. Most consoles also have aux master controls, which set the overall level of each aux output.

Coming back from the Q20's outputs into the mixer, you have two options:

- connecting to dedicated return inputs, or
- connecting to channel inputs.

The former is good if your mixer provides dedicated inputs (called returns) for effect devices like the Q20. If your mixer does not have these, or you have already used them all, consider connecting the Q20 to channel inputs or unused tape returns. You may also want to take advantage of better EQ, panning or automation options on your console's channel inputs.

Setting the Effect/Dry Balance

No matter where you connect the output of the Q20 into the mixer, you are in control of the balance between the mixer's channel inputs (the unaffected signal being routed to the aux sends and the Mix) and the effect returns coming from the Q20. The effect returns generally should only contain effected signal, and not have any unaffected signal mixed with it (since these two signals are blended together at the mixer).

If the Program you are using has the L/R IN connected to the L/R OUT, you may be getting some dry, unaffected signal at the return. Generally, this is not desirable when using the Q20 with a mixer, since the "dry" signal is already being heard through the original channel's fader. Therefore, in a mixer application you will want to cut the Q20's Program's path which connects the inputs to the outputs. This can be done in three ways:

- Go to the Mix parameters to bring down the direct level
- Go to the Routing function of each program and remove the patch cords connecting the inputs to the outputs
- Turn on the Global Direct Signal Mute function. This is the easiest method.



Most Preset Programs route the L/R IN signal to the L/R OUT. When connecting to a mixer's aux sends and returns, the Global Direct Signal Mute should be set to MUTE.

To remove all direct routings of inputs to outputs on all Programs simultaneously:

- ① Press [GLOBAL].
The [GLOBAL] LED will be lit.
- ② Press [< PAGE] once.
This selects Global Page 9. The display will read:

```
GLOBAL DIRECT SIGNAL: ON
```

- ③ Turn the [VALUE/ENTER] knob to the right until the display reads "ON."
The next Program recalled which has the inputs routed to the outputs will not display the patch cords for these connections nor will you hear any direct unaffected signal at the outputs.

Mono In - Stereo Out. If you only want to feed the Q20 a mono input, but wish to connect both of its outputs back to the mixer, you will need three audio cables. Connect a cable from an effect send to the [L] INPUT of the Q20, another cable from the [L] OUTPUT of the Q20 to an effect return or other mixer input, and another cable from the [R] OUTPUT of the Q20 to an adjacent mixer input.

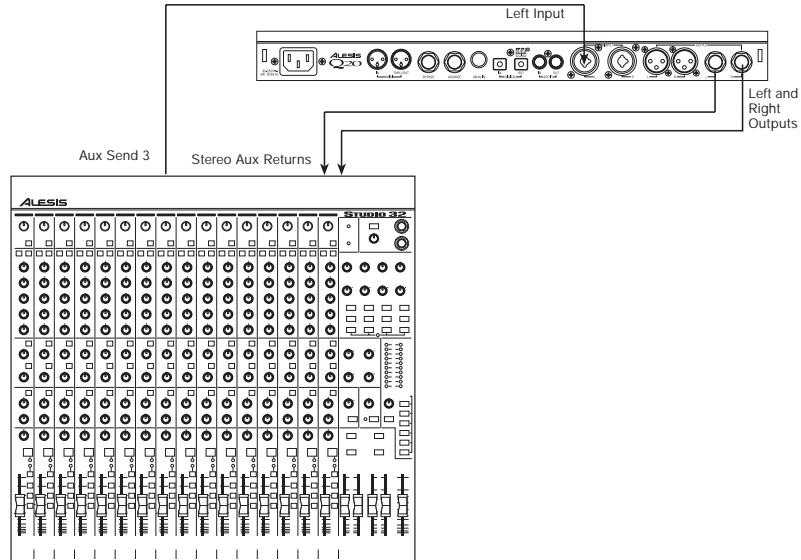

Stereo In - Stereo Out. This connection is similar to the one described above. However, by utilizing two sends from the mixer, we add one more cord and can now send a stereo signal to the Q20's inputs. Example, if you connected effect sends 3 and 4 to the [L] and [R] INPUTS, and had a stereo instrument (such as a keyboard) connected to two channel inputs of the mixer (either one panned hard left and hard right), you would send the left channel to send 3 and the right channel to send 4. Alternatively, you could have two discrete effect sends between the Left and Right channel, and process each separately within the Q20. For example, the Left channel (from send 3) could be a chorus, and the Right (from send 4) could be a reverb. This is similar to Dual Mono, described earlier.

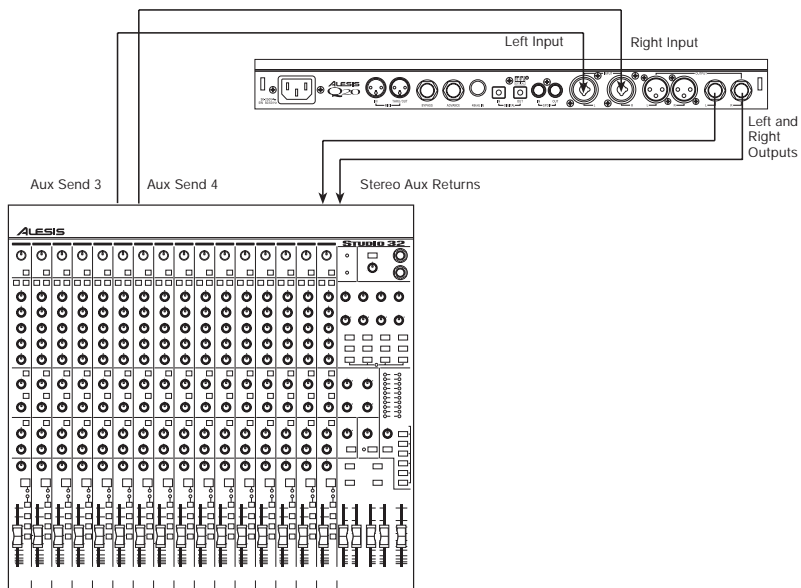

Using Inserts

By using individual channel inserts, you can dedicate the Q20 to a specific channel (or pair of channels) on the mixer. The Insert connections on the back of the mixer provide a way of “inserting” external processing equipment into the signal path. The insert occurs after the input amplifier, and before the main fader; essentially it is the same as connecting the source (instrument or microphone) into the Q20 before the mixer’s channel input. However, some mixing console’s inserts come after the EQ section, and may therefore be different from the original signal.

Usually, insert connections require a special, stereo-splitting Y-cord to be connected (one stereo plug provides both send and return while two mono plugs connect separately to an input and output). These are known as TRS connectors (tip-ring-sleeve). The tip of the stereo plug typically carries the send or output of the insert jack, while the ring carries back the return. The sleeve represents a common ground for both signals. Check the manual of your mixer because some are wired differently (for example, having two separate jacks for send and receive).

Mono. This involves connecting a 1/4" TRS (tip-ring-sleeve) to the Insert jack of a single channel on a mixing console. The other end of the cable (which splits into two, 1/4" mono connectors) are connected to the [L] INPUT and [L] OUTPUT, respectively. If you do not hear any audio after making these connections, swap the input and output cables at the Q20, as these may be wired backwards. If the cable is color-coded, usually the red jack represents the send (which connects to the Q20’s INPUT) and black is the return (which connects to the OUTPUT).

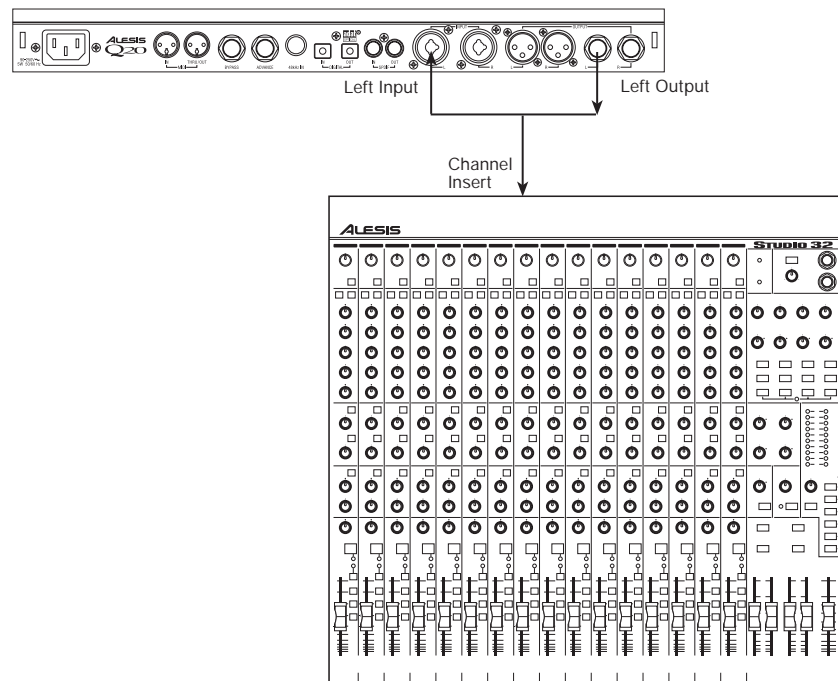

Stereo. In the case where a stereo instrument, such as a keyboard or sampler, is connected to two separate channels of a mixing console, you will need two 1/4" TRS cables, one for each channel. The connection is made in a similar fashion as described above.

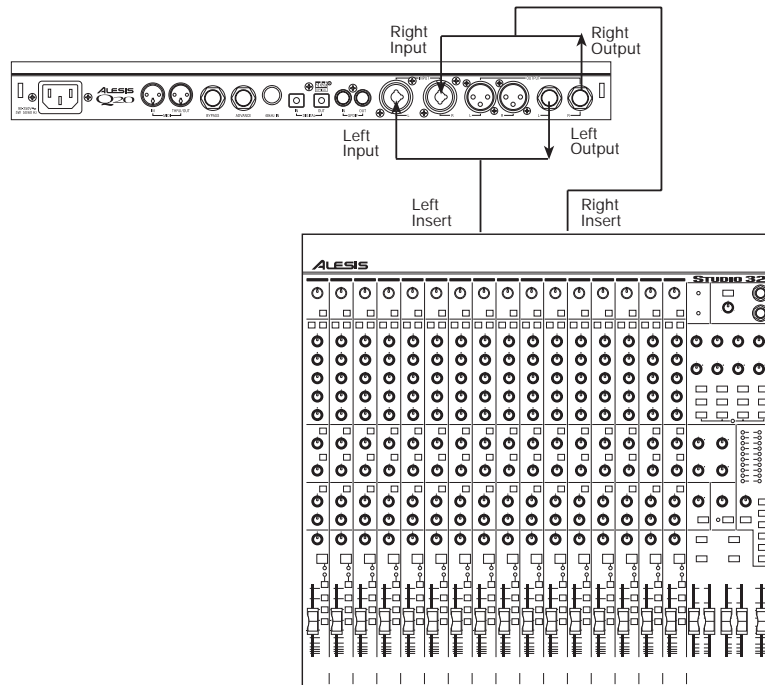

Using Main Outputs

When you want to effect everything on the mixer, you can connect the Q20 between the mixer's outputs and the amplifier's or tape machine's inputs. This is done by using two cables to connect the Left and Right Main Outputs of the mixing console to the [L] and [R] INPUTs of the Q20. The [L] and [R] OUTPUTs of the Q20 are then connected to a stereo amplifier, or two input channels of another mixing console (for sub-mixing applications).

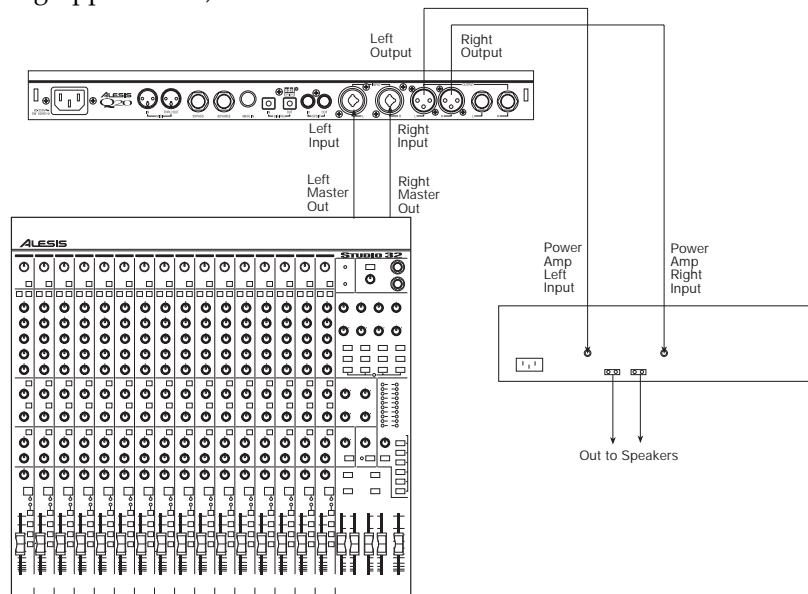

When to use Balanced Connectors

There are three options for connecting analog audio to the Q20: 1/4" unbalanced, 1/4" balanced (TRS) and XLR balanced. If your source and destination use balanced connectors, you should try to stay balanced throughout the chain. Balanced cables have a higher signal level and have the ability to cancel out hum and noise, which can make your mixes quieter. XLR connectors have the added bonus of locking into place, a good idea if you need to move your effects rack from place to place.

Keeping this in mind, your order of preference when connecting the Q20 to a mixer should be to use the XLR connectors first, then to use balanced 1/4" cables, then unbalanced 1/4" cables if your mixer doesn't have balanced sends and receives.

Avoiding Ground Loops

In today's complex studio there are many opportunities for ground loop problems to occur. These show up as hums, buzzes or sometimes radio reception, and can occur if a piece of equipment "sees" two or more different paths to ground. While there are methods to virtually eliminate ground loops and stray radio frequency interference, most of the professional methods are expensive and involve installing a separate power source just for the sound system. Here are some easy helpful hints that a professional studio installer might use to zap those stray hums and buzzes.

- ① KEEP ALL ELECTRONICS OF THE SOUND SYSTEM ON THE SAME AC ELECTRICAL CIRCUIT. Most stray hums and buzzes happen as a result of different parts of the sound system being plugged into outlets of different AC circuits. If any noise generating devices such as air conditioners, refrigerators, neon lights, etc., are already plugged into one of these circuits, you then have a perfect condition for stray buzzes. Since most electronic devices of a sound system don't require a lot of current (except power amplifiers), it's usually safe to run a multi-outlet box (or two) from a *SINGLE* wall outlet, and plug in all of the components of your system there.
- ② KEEP AUDIO WIRING AS FAR AWAY FROM AC WIRING AS POSSIBLE. Many hums come from audio cabling being too near AC wiring. If a hum occurs, try moving the audio wiring around to see if the hum ceases or diminishes. If it's not possible to separate the audio and AC wiring in some instances, make sure that the audio wires don't run parallel to any AC wire (they should only cross at right angles, if possible).
- ③ TO ELIMINATE HUM IF THE ABOVE HAS FAILED:
 - A) Disconnect the power from all outboard devices and tape machines except for the mixer and control room monitor power amp.
 - B) Plug in each tape machine and outboard effects device one at a time. If possible, flip the polarity of the plug of each device (turn it around in the socket) until the quietest position is found.
 - C) Make sure that all of the audio cables are in good working order. Cables with a detached ground wire will cause a very loud hum!!
 - D) Keep all cables as short as possible, especially in unbalanced circuits.

If the basic experiments don't uncover the source of the problem, consult your dealer or technician trained in proper studio grounding techniques. In some cases, a "star grounding" scheme must be used, with the mixer at the center of the star providing the shield ground on telescoping shields, which do NOT connect to the chassis ground of other equipment in the system.

MIDI

MIDI is an internationally-accepted protocol that allows music-related data to be conveyed from one device to another. The MIDI connections on the Q20 provide five different functions:

- To recall programs using MIDI program change messages
- To control various parameters inside the Q20 in realtime via MIDI controllers (*example: A keyboard's mod wheel, or pedals, etc.*)
- To convert MIDI Clock messages into delay settings on Tap Tempo Delay Blocks
- To send and receive SysEx (System Exclusive) dumps of individual programs or the entire bank of programs for storage and retrieval purposes
- To pass-on MIDI information thru the Q20 to another MIDI device.

To connect the Q20's MIDI ports to another MIDI device:

- ① Connect a MIDI cable from the Q20's MIDI [THRU/OUT] connector to the MIDI IN connector of the other MIDI device.
- ② Connect another MIDI cable from the Q20's MIDI [IN] connector to the other MIDI device's MIDI OUT connector.

For more information about MIDI, refer to Chapter 6.

Digital Connections

Digital connections provide better fidelity than the analog inputs and outputs because you avoid converting the audio from digital to analog (say from a digital mixer), then to digital (Q20 input), then analog (Q20 output), then digital again (back into the mixer).

The Q20 provides two formats for direct digital connections: ADAT Optical and S/PDIF. The Alesis Optical interface provides two EIAJ fiber optic connectors for [DIG IN] and [DIG OUT]. These connectors use a proprietary Alesis multichannel format first introduced with the ADAT Multitrack Recorder. The Q20 can send and/or receive digital audio directly to/from an ADAT (or other devices which use the same optical interface). The S/PDIF inputs and outputs are provided on coaxial (phono) jacks and conform to the consumer digital interface format (Sony/Philips Digital Interface Format).

The proprietary Alesis Optical format carries up to 8 audio channels on a single fiber optic cable. Since the Q20 has two channels (left and right), you may choose two of the incoming 8 channels for the Q20 to process or output.

ADAT Optical fiber optic cables of various lengths are available from your Alesis dealer. The shorter the cable, the better. The OC cable is 5 meters long (16'4") and is the maximum length recommended. For S/PDIF connection, you should use good quality video-type phono cables.

Footswitches

On the rear panel you will find two footswitch jacks labeled [ADVANCE] and [BYPASS]. Any momentary single-pole/single-throw footswitch, normally open or normally closed, will work for the two footswitch functions. These should be plugged in prior to power-up so that the Q20 can configure itself for the type of footswitch being used.

Advance

The [ADVANCE] jack lets you scroll through the Programs in memory by advancing to the next higher numbered Program each time the connected footswitch is pressed. The Q20 will “wrap-around” whenever it reaches the end of available Programs and the Advance footswitch is pressed again. You can set a range of Programs to be used, thereby cutting off other Programs from being recalled in this manner. For example, if you set the range to be User 0-10 through User 0-24, only Programs within this range will be recalled using the Advance footswitch. If Program 0-24 is selected and the footswitch is pressed again, Program 0-10 is recalled.

To adjust the Advance Footswitch’s set of Programs:

- ① Press [GLOBAL].
The [GLOBAL] LED will light.
- ② Press [PAGE >] once.
This selects page 2, and the display will read:

```
FOOTSWITCH: Preset00 TO User1-99
```

- ③ Turn the [VALUE/ENTER] knob to adjust the Program number to begin the range (Preset 00 — 99, User 0-00 — 1-99).
- ④ Press [PAGE >] once and use the [VALUE/ENTER] knob to adjust the Program number to end the range (Preset 00 — 99, User 0-00 — 1-99).

Bypass

The Bypass footswitch jack lets you turn the Bypass function on and off from a connected footswitch. When pressed, the [BYPASS] LED will light, indicating that Bypass mode is enabled. When pressed again, the [BYPASS] LED will turn off. For more information about Bypass mode, see Chapters 2 and 5.

Tap Tempo

Either footswitch jack can be used to provide a tap tempo source for setting delay time, provided the selected Program uses one of the two available tap tempo delay types. This requires that you have defined an Effect Block as one of the two Tap Tempo delay types, and that the desired footswitch jack has been selected for controlling tap tempo. To select a footswitch jack for use with a Tap Tempo Delay:

- ① Press [GLOBAL].
The [GLOBAL] LED will light.
- ② Press [< PAGE] twice to select Global Page 8.
The display will read:

TAP TEMPO FOOTSWITCH: NONE

- ③ Turn the [VALUE/ENTER] knob to select either the ADVANCE or BYPASS footswitch jack, depending on which one you wish to use to control tap tempo.

Note that some programs can override these footswitch settings by re-assigning pedals as Local Generator Sources in the Modulation pages. See Chapter 6 for more information.

CHAPTER 2

YOUR FIRST SESSION WITH THE Q20

Powering Up

After making your connections, turn on the system's power using this procedure:

- ① Before turning on the Q20's power, check the following items:
 - Have all connections been made correctly?
 - Are the volume controls of the amplifier or mixer turned down?
- ② Turn on the [POWER] switch on the front panel of the Q20.
Upon power-up, the Q20 will display the last selected Program, and the [PROGRAM] button's LED will be lit. If this Program has been edited, the display will indicate this by showing the word "EDITED", and by flashing the Program Number and Name in the upper display.
- ③ Turn on the power of the amplifier/mixer, and adjust the volume.

Setting Levels

Proper setting of the [INPUT LEVEL] and [OUTPUT] knobs is crucial in order to achieve the maximum signal-to-noise ratio (the concentric knobs allow the Left and Right Input levels to be adjusted separately). As a good starting point, set both input and output level controls at about 2 o'clock or 65% of full. This will decrease the possibility of overload distortion and keep the amount of background noise to a minimum.

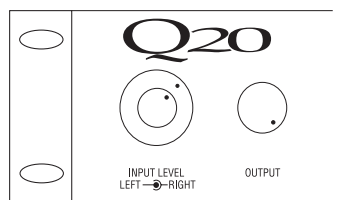

For quietest operation, you should adjust the level of the source being sent to the Q20 so that the green [-3dB] LEDs in the Q20's peak meter flash, but not so loud that the red [CLIP] LEDs turn on. A nominal input sound make the -12dB LED turn on

Note: The Input and Output level controls effect the analog inputs and outputs only. If you need to attenuate the digital inputs, you can do this in Page 2 of the Routing pages. See Chapter 4 for more information.

The Value/Enter Knob

Located just to the right of the custom LCD display, the [VALUE/ENTER] knob is used to select Programs and adjust parameter values that appear in the display. However, it is not just a knob, it is also a button. Depending on what parameter you are editing, the [VALUE/ENTER] knob will work in either one of two ways:

Immediate. The desired value is selected by turning the [VALUE/ENTER] knob, and immediately takes effect. This is the case when adjusting most parameters.

Deferred. The desired value is selected by turning the [VALUE/ENTER] knob, but the new value will only take effect after the [VALUE/ENTER] button has been pressed. The newly selected value will flash in the display until it is selected in this manner. If you change the parameter back to its original setting, the value in the display will not flash. Also, if you go to another Page, or select another Function (by pressing any button), the parameter will be left unchanged. If you went back to look at the previous parameter, it will be set back to its original setting. This mode is used for parameters that cause architectural changes such as changing a Block's function, effect type, and routing signals.

The [VALUE/ENTER] button can also be used to step through Pages in the currently selected mode. Except when a value is flashing on and off in the display, the [VALUE/ENTER] button ordinarily doubles for the [PAGE >] button. If you change the value of a parameter that uses "deferred mode," you must press the [VALUE/ENTER] button to enter the new value (the display will stop flashing), and then you can press it again to move to the next Page (or to the next parameter, if more than one parameter appears in the display). This is a feature for power users who want to be able to move around the various pages quickly and make changes as fast as possible.



Unique Exception: When editing the Delay Time parameter of a Delay Block set to either Tap Tempo Mono Delay or Tap Tempo Ping Pong, the [VALUE/ENTER] button is used to "tap" in a tempo . See Chapter 6 for more information.

Adjusting the Display Contrast

Occasionally, the characters in the LCD display may be difficult to read, depending on the viewing angle and existing lighting conditions. In such a situation, adjust the contrast of the LCD display using the following procedure.

- ① Press [GLOBAL].
The display will go to the Global Mode Page 1.

ADJUST DISPLAY CONTRAST: 5

- ② Adjust the contrast by turning the [VALUE/ENTER] knob.
The display's contrast and its value in the display will change.

Auditioning Internal Programs

You can audition the Programs in the Q20 by using the [VALUE/ENTER] knob or the front panel buttons, whenever the Q20 is in Program mode (the [PROGRAM] button's LED will be lit).

To select a Program using the [VALUE/ENTER] knob:

- ① Press [PROGRAM].
The [PROGRAM] button's LED will light.
- ② Turn the [VALUE/ENTER] knob.

Note: The [VALUE/ENTER] knob has two modes when used for selecting Programs: Direct and Deferred. Direct mode immediately recalls the displayed Program as you turn the [VALUE/ENTER] knob. Deferred mode lets you scroll through the Programs in the display by turning the [VALUE/ENTER] knob, but you must press the [VALUE/ENTER] button to actually recall a Program. For more information on choosing between Direct and Deferred mode, see Chapter 5.

To select a Program using the front panel buttons:

- ① Hold the [PROGRAM] button.
- ② Use the [1] through [0] buttons to directly select Programs 00 through 99.
These are the right-most ten buttons on the front panel, which double for [BLOCK >], [TYPE], [ROUTING], etc.

The top line of the display will change to indicate the currently selected Program number (from 00-99) and its name.

```
PROG: Preset 00 "Concert Hall  "
```



The left side of the display always indicates the currently selected Program number (00 – 99). Directly beneath the two-digit Program number, the word “PRESET” will appear when the Preset bank is selected.

Switching Between Preset and User Banks

There are three banks in the Q20: Preset, User 0 and User 1. They each contain 100 Programs. However, the Preset bank cannot be permanently changed. You can edit the Preset Programs, but you can store them only in the User banks. To switch between the Preset and User banks, follow these steps:

- ① Press and hold the [PROGRAM] button.
- ② Use the [< BLOCK] and [< PAGE] buttons to select either PRESET or USER. Press the [< PAGE] again to toggle between the two User banks.
The currently selected Bank will be displayed in the top row of the LCD display. Also, when the Preset Bank is selected, the display will show the word “PRESET” beneath the PROGRAM number in the lower left corner.

Example Programs

The following are descriptions of the three example Programs in the Preset bank.

96: "VerbOfMyDreams"

This Program is fairly simple in design, using only 3 Blocks to provide EQ, Delay and Reverb. It is designed for a mono audio source to be connected to the [R] INPUT. In the display, you can see the R IN routed to the first Block, which is defined as a 3-Band Parametric EQ. The M output of the EQ then is routed to the next Block, which is a Mono Delay. The M output of the Delay is then routed to the next Block, which is a Room 2 Reverb. The L output of the Reverb is routed to the L OUT while the R output of the Reverb is routed to the R OUT. Also, the R IN is routed to both the L and R OUT, to combine the original dry signal with the wet signal coming from Block #3.

The EQ Block is used to tailor the sound before further processing occurs. You should make adjustments here based on the signal you feed through it; if the higher frequencies of the input signal do not sound as good through the Reverb as the mids and lows, try attenuating them in the EQ. The Delay is used to "thicken" the sound by adding a few very fast echoes. The Reverb adds ambiance, as if you were in a large chamber, and completes the total effect.

Using the Mix function, you can adjust the output level of the Reverb Block and the Direct Signal to create the balance you are looking for.

97: "Guitar Rack"

This Program includes two Pitch Blocks feeding a delay Block, into another Pitch Block, then into a Reverb Block, and finally yet another Pitch Block. This is a prime example of the flexibility the Q20 offers to programmers. The Program creates a thick, swirling, ambient effect that greatly enhances an electric guitar's sound.

The R IN is routed to Blocks 1 and 2, as well as the L and R OUT. The first two Pitch Blocks are defined as Pitch Detune type, but are set to different detune amounts to create a thicker sound. The Delay Block is a Mono Delay which provides a very quick "slap back" by using a small delay time and no feedback. The third Pitch Block provides a Stereo Chorus which swirls the detuned, delay signal and feeds directly to the outputs. The Delay Block's output is also fed into a Hall 1 Reverb which provides ambiance to the un-chorused signal. The Reverb's stereo signals are routed to the Q20's outputs and mixed with the Stereo Chorus's signals. Meanwhile, the Reverb's mono output feeds a Stereo Flanger whose stereo signals are also combined with the Stereo Chorus, Reverb and the original input signal at the outputs. Again, use the Mix parameters to create just the balance you want.

98: "Stereo Plates"

This Program is very simple. It routes the L and R IN through separate stereo type Reverb Blocks (Plate 1 type, to be precise). Both stereo signals coming out of the two Reverb Blocks feed the L/R OUT. This creates a very clean stereo reverb effect that's great for vocals. Play around with the Predelay and Decay parameters to adjust the attack and length of the reverb.

Adjusting Effects Levels

Although we may not want to get started editing Programs just yet (that's left for Chapter 4), it is usually necessary to have immediate control over the output levels of each Effect Block, as well as the amount of direct level going from the inputs to the outputs. These are found within Mix mode.

To adjust a Program's effect levels:

- ① Press the [MIX] button.
The [MIX] button's LED will light.
- ② Use the [< BLOCK >] buttons to select any of the active Blocks in the display.
If the selected Block is routed to the L/R Outputs, the display will read:

```
LEVEL TO L/R: RVB=100%
```

The letters RVB in the display example above indicate the selected Block is of the Reverberation type. Other types are: EQ for Equalization, PCH for Pitch and DLY for Delay.

- ③ Turn the [VALUE/ENTER] knob to adjust the Block's Level to the L/R Outputs, from 0–100%.
If the selected Block is not routed to the L/R Outputs, this setting will be "NONE" and you will not be able to adjust the value.
- ④ Press [PAGE >] to advance to Mix Page 2 and adjust the Direct Level from Input.
The display will read:

```
DIRECT LEVEL FROM INPUT: 100%
```

- ⑤ Turn the [VALUE/ENTER] knob to adjust how much of the dry (unaffected) signal you wish to hear at the Q20's outputs, from 0–100%.
If the L/R Inputs are not routed to the L/R Outputs, this setting will be "NONE" and you will not be able to adjust the value since there is no direct signal.



If the Global Direct Signal Mute function is turned on, the Direct Level From Input parameter will have no audible effect, although its setting is remembered when you store the Program.

- ⑥ Press [PAGE >] to advance to Mix Page 3 and adjust the Master Effects Level.

```
MASTER EFFECTS LEVEL: 100%
```

- ⑦ Use the [VALUE/ENTER] knob to adjust the Master Effects Level to the L/R Outputs, from 0–100%.
This parameter comes between the combined Effect Blocks' outputs and the Q20's outputs, and controls the output levels of all active Blocks that are routed to the L/R Outputs simultaneously. However, it does not change the individual output levels of Effect Blocks that are routed internally (i.e. to other Blocks).

- ⑧ Use the [< BLOCK >] buttons to select other Blocks, and adjust their levels, as described above.



Mix parameters affect the Program and are only temporary unless the Program is stored into memory before a another Program is recalled. See later in this Chapter for more about comparing and storing edited Programs.

Comparing an Edited Program to its Original Settings



The left side of the display always indicates the currently selected Program. Once a Program has been edited, the word “EDITED” appears in the lower left part of the display, just below the Program Number indicator. If the [PROGRAM] button is pressed (the [PROGRAM] button’s LED will light), the display will also indicate the Program has been altered from its stored version by flashing the Program number and name in the upper section of the display.

By pressing [COMPARE], you can temporarily access the original version of the Program you are editing; that is, the last Program saved to the currently selected location number. This allows you to hear the differences created by changing parameters in the Program.

While you are in Compare mode, the [COMPARE] button’s LED will be lit. Also, you cannot adjust any of the Type, Routing, Parameter, Modulation settings. However, you can move around the various pages and view these original settings and therefore see the actual differences in settings you have changed.

Pressing [COMPARE] a second time exits Compare mode; the [COMPARE] button’s LED will turn off and the edited version of the Program will be accessed. You can go in and out of Compare mode as often as you like, as long as the display indicates “EDITED” (i.e., if the Program hasn’t been edited yet, there is nothing to compare it to).

Restoring an Edited Program to its Original Settings

If you decide to abort the changes you have made to a Program, this can be done in two easy steps.

To restore an edited Program to its previous, unedited version:

- ① Press [PROGRAM] to select Program mode.
The [PROGRAM] button’s LED will light, and the display will flash the selected Program number and name.
- ② Press the [VALUE/ENTER] button.
This recalls the last stored version of the currently selected Program number, and the word “EDITED” disappears from the display. Consequently, any changes you had made to the Program before recalling are lost. unless you stored the edited Program into memory.

Storing Edited Programs

Once you are satisfied with the changes you have made to a Program, or are creating a new Program from scratch, you will need to store your edited Program back into memory. The Q20 will store the currently selected Program in memory (which is retained when the unit is turned off). If you edit a Program, the changes you made will still be there the next time you switch on the unit, even if you hadn't stored the edited Program into memory yet. However, if you select another Program from memory **before** storing the edited Program, your changes will be lost. Although the Q20 has two banks (Preset and User), you can only store Programs in the User bank.



The Preset bank cannot be permanently changed. If you edit a Program selected from the Preset bank, you will be able to make changes, but when you attempt to Store the edited Program, it will be stored into the User bank (in the selected number location).

To store an edited Program into memory:

- ① Press the [STORE] button.

The [STORE] button's LED will light. The display will read:

```
STORE AT:  X-YY "nnnnnnnnnnnnnnnn"
```

...whereby X is User Bank 0 or 1, YY is a Program number from 0 to 99 and nnnn is the name of the program that will be overwritten. Both the Program number and name will be flashing.

- ② Turn the [VALUE/ENTER] knob to select the Program number location in the User bank to store the edited Program into.

- ③ Press the [VALUE/ENTER] button.

The display will momentarily read:

```
PROGRAM STORED
```

After storing, the User Program location you chose will automatically be selected and shown in the display (example: if you edited Program 13 and stored it into location 25, Program 25 will be selected).

Auditioning Programs before Storing

Here is a handy trick you can use in a sticky situation. Let's say you've just created a killer Program and you want to store it but you don't know where. If you are using Deferred Mode (Program mode, Page 2), you can scroll through a list of Programs and view their names without actually recalling them (which would result in losing your edited Program). If you want to hear what a Program sounds like, simply press the [COMPARE] button to audition a Program without selecting it. Once you've found the location you want to store into, you can simply press [STORE] twice to replace the selected Program with your newly created Program.

Bypassing Effects

At any time you can bypass all effects at once, thereby allowing the direct signal to pass through the Q20 unchanged. This can be done in two ways:

- by pressing the [BYPASS] button on the front panel; or,
- by connecting a footswitch to the [BYPASS] jack and pressing the footswitch.

Each time either the [BYPASS] button is pressed, or the footswitch connected to the [BYPASS] jack is pressed, Bypass mode is toggled on and off again. When Bypass mode is turned on, the [BYPASS] button's LED will be lit.



When Bypass is enabled, all Effect Blocks are momentarily disabled and will not have audio routed from them to the outputs. However, if the Program does not route the L/R Inputs directly to the L/R Outputs, you will not hear anything.

In order for the Bypass mode to function correctly, make sure the L/R Inputs are routed to the L/R Outputs and that the Global Direct Signal Mute function is turned off (see below). If the inputs are not routed directly to the outputs, the [BYPASS] button acts more like a “mute” since nothing will be heard when it is enabled.

Global Direct Signal Muting

The purpose of this feature is to satisfy the conditions of a recording studio environment. As described in Chapter 1, when connecting the Q20 to a mixing console's aux sends and returns, it is generally desirable to remove the direct signal feed from the outputs of the Q20. This is because the signal coming back from the Q20 should only contain wet (unaffected) signal. The dry signal is then combined with the returning wet signal at the mixing console.

Since most Q20 Programs route the L/R IN signal to the L/R OUT, you will need to mute this connection when connecting to a mixer's aux sends and returns. This can be done globally for all Programs.

To remove all direct routings of inputs to outputs on all Programs simultaneously:

- ① Press [GLOBAL].
The [GLOBAL] LED will light.
- ② Press [< PAGE] once.
This selects Global Page 9. The display will read:

```
GLOBAL DIRECT SIGNAL MUTE: OFF
```

- ③ Turn the [VALUE/ENTER] knob to the right until the display reads “ON.”
The next Program recalled which has the inputs routed to the outputs will not display the routes (“patch cords”) for these connections nor will you hear any direct unaffected signal at the outputs.

CHAPTER 3

OVERVIEW

The Architecture of the Q20

The Q20 provides eight Effect Blocks per Program, each of which can serve as either EQ, Pitch, Delay or Reverb. The display shows these Blocks from first to last, between the L/R IN (left and right inputs) and the L/R OUT (outputs). The display also illustrates the routings between the Blocks. In addition to the Block functions, there is a set of Modulations which may be used in a Program. These allow MIDI messages (such as note numbers, velocity, after-touch, pitch-bend or controllers) to serve as controls over parameters in the Q20. This is discussed in further detail in Chapter 6. For now, let's discuss the essence of Blocks and how they interact with each other.

What is a Block?

A Block is essentially a discrete effects processor that can be used alone or in conjunction with other Blocks. Each Block has a Mono input and up to three outputs (depending on its type): left, right and mix, a mono mix of the left and right outs. A Block requires that a signal be routed to it before it can effect the signal. The Block must also have its output connected either to the L OUT or R OUT (or both), or to the input of another Block (or to a series of Blocks) which is in turn connected to either the L OUT or R OUT (or both) before the Block's effect can be heard.

The four effect functions available in a Block are: Equalization, Pitch, Delay and Reverberation. Each one of these has several effect types. *Example:* Once a Block is assigned to use a Pitch function, you can choose a Chorus, Pitch Shifter, Flanger, etc. A full list of all the available effects and their parameters is shown in Chapter 5.

Selecting and Editing Blocks

Editing a Program is done by first selecting one of the eight Blocks, and then selecting a Block function (Type, Routing, Parameter, or Mix). Use the [`< BLOCK >`] buttons to move the pointer in the display to the left or right. The pointer appears as a down-pointing triangle just above the Blocks, thereby selecting one of the eight Blocks or the L OUT or R OUT (the L OUT and R OUT are special Blocks which aren't really edited, except when adjusting the *mix*). The pointer's position indicates which Block is being edited.

There are four Block functions, which are accessed by using the four Block function buttons: [TYPE], [ROUTING], [PARAMETER], and [MIX]. Pressing any of these buttons takes you to its related parameters, and simultaneously turns on the button's LED to indicate the selected Block function.

TYPE. The Type function is where you go first to define a Block. A Block is defined as either EQ, Pitch, Delay, Reverberation or Off. This is done in Type Page 1. Once a Block is defined, its effect type can be selected. This is done in Type Page 2. If you need to move or copy a defined Block to another position, you would go to Type Page 3 and 4.

ROUTING. Once a Block is defined, you must select its input source and route its outputs either to another Block's input or to the L OUT or R OUT. This is done in Routing Page 1. Once an input source is selected, you can adjust its level feeding to the Block's input using Routing Page 2. If you decide to delete a routing that has already been added, you will use Routing Page 3.

PARAMETER. This is where you adjust the selected Block's parameters. The number of pages available and the parameters found in them will be determined by the Block's type. Some effect types have only one or two parameters on a single page; while other effect types (particularly reverbs) use all nine pages, with as many as four parameters on a single page.

MIX. The Mix function provides three parameters on three separate pages. When a defined Block is selected, Mix Page 1 lets you adjust its level going to the L/R Outputs. Page 2 lets you adjust the Direct Signal Level, and Page 3 lets you adjust the Master Effects Level. If, however, an undefined Block is selected, or the L/R OUT is selected, there will only be two pages available in the Mix function (Direct Signal Level, and Master Effects Level).

Once a Block function is selected, use the [< PAGE >] buttons to scroll through the various pages within a Block function. The number of available pages will vary from function to function. The left side of the display will indicate the total number of pages within the selected Block function. The page currently being displayed will be underlined.

When you find a parameter you wish to edit, turn the [VALUE/ENTER] knob until the desired value is displayed. If the new value flashes in the display, it means you must press the [VALUE/ENTER] button to select the new value.

Routing "Patch Cords" Between Blocks

The concept of routing involves selecting inputs for each active Block (1 through 8) and L OUT and R OUT, and then adjusting the input levels of those routings you are using. The [ROUTING] button will let you create "patch cords" that connect the input jacks to the Blocks, or the Blocks to other Blocks, and finally to the output jacks. You may select the Left Input, Right Input (analog or digital inputs), or the output of a Block: L (left), R (right) or M (mix). You can even route a Block's M (mix) output back to its own input, which can be used to create some rather stunning effects, but the level setting for doing this is critical to avoid unwanted feedback.

Keep in mind that each Block can have many inputs, coming from various sources. All routings are considered "input patch cords"; i.e., you can only make a route from the destination Block. *Example:* To set a route from Block 2 to Block 5, you'd select Block 5 (not Block 2) using the [< BLOCK >] buttons and then select Block 2's output as an input source.



If the Global Direct Signal Mute function is turned on, any Programs which have the L/R IN routed to the L/R OUT will not display these "patch cords" except when editing the Program's routings. This is to avoid confusion when operating in this mode. For more information on Global Direct Signal Mute, see Chapter 2.

Quick Route

A new feature has been added to greatly simplify the task of creating Programs, especially a 1-Block Program. When a new Effect Block is created (by changing its Block Function from OFF to either EQ, Pitch, Delay or Reverb, and pressing the [VALUE/ENTER] button), the display will read the following:

```
ADD ROUTE FROM INPUT: NONE
```

Turning the [VALUE/ENTER] knob lets you select from the following choices: NONE, LEFT, RIGHT or BOTH. After making your selection, press the [VALUE/ENTER]. What occurs depends on what you just selected:

- NONE: No routes are added.
- LEFT: A route is added from the [L] INPUT to the Block's input.
- RIGHT: A route is added from the [R] INPUT to the Block's input.
- BOTH: Two routes are added from the [L] and [R] INPUTs to the Block's input.

The display will have advanced to the next page, which will look like this:

```
ADD ROUTE TO OUTPUT: NONE
```

Turning the [VALUE/ENTER] knob lets you select from the following choices: NONE, LEFT, RIGHT or BOTH. After making your selection, press the [VALUE/ENTER]. What occurs depends on what you just selected:

- NONE: No routes are added.
- LEFT: A route is added from the Block's output to the [L] OUTPUT.
- RIGHT: A route is added from the Block's output to the [R] OUTPUT.
- BOTH: Two routes are added from the Block's output to the [L] and [R] OUTPUTs.

Note: All routes added using this Quick Route method will have a default routing level of -6 dB, until they are edited.

Setting the Routing Levels

Each time you add a "patch cord" to a Program, the Q20's display automatically prompts you to set its level. This is done by adjusting the attenuation level between -48dB and +0dB, or OFF. When set at +0dB, the signal is allowed to pass through at full volume, with no attenuation. When set to OFF, the signal is fully attenuated and will not be heard at the "patch cord's" destination.

The default level for a newly added "patch cord" is -6dB. This provides you with ample headroom for most applications. The ideal level, however, should be as high as possible without causing distortion. There are basically three places in the Q20 that can distort: at the input A/D converter, within the blocks, and at the output. The routing levels within a well-designed program are set so that none of these three will distort before the other ones do. If the input is clipping, it doesn't matter if you've attenuated levels feeding from the input to a block--it will still distort.

Input clipping is controlled by the front panel INPUT LEVEL controls. Block clipping can be caused by routing levels to the block that are too high, or by

processing within the block itself (for example, a boost in EQ or feedback in a chorus or delay). Output clipping can be controlled using the Master Effects Level parameter in the [MIX] function. The OUTPUT LEVEL control is analog, and cannot lower the distortion caused when the output of multiple blocks are too loud for the output D/A converter to handle.

Keep in mind when setting routing levels that each time you double the number of sources, the output rises 6 dB. If there are four blocks feeding another block, those routes may all need to be set to -12 dB to avoid clipping. On the other hand, if a program consists of a single delay or reverb block, input and output routings may be set to 0 dB without distortion.

It is also important to note that each “patch cord” in a Program uses 1% of the total DSP power available. However, if the signal is attenuated (by setting the level below +0dB), 2% of DSP is used. The following section discusses how the Q20 reacts when DSP is nearly fully taxed. One way to free up more DSP power when you need it is to set some or all of your “patch cord” levels to +0dB.

The L/R IN

These appear on the far left side of the Block section in the display. They are not selectable with the [< BLOCK >] buttons. This is because we are always routing from the L/R IN and, in keeping with our convention, all routing is done from the destination Block, not from the source.

Reaching the Outputs - L/R OUT

The L OUT and R OUT are separately selectable (like Blocks) for routing purposes. Whichever Block is determined to be the final effect in the chain (whether your Program has one or multiple Blocks), it needs to be routed to the L/R OUT in order for you to hear it. This can be done in mono (if just one channel is needed) by routing one or more Block outputs to either the L OUT or R OUT, or in stereo by routing to both the L and R OUT.

Limit Handling

Within the limits of the available sample memory and DSP, the Blocks can be linked in any order, in almost any combination of the four basic types. For instance, you might have two EQ Blocks followed by four pitch Effect Blocks; or one Block of each (EQ, Pitch, Delay) type on the left channel and one of each type on the right channel, followed by a stereo reverb (a total of 7 Blocks).

Because the Q20 is so flexible, occasionally you will have a combination of effects and/or parameters that may overtax either the available memory or DSP power on board the unit. When you attempt to program beyond the Q20's capabilities, no harm will be done but one of four error messages will appear in the display indicating you have exceeded the unit's limits. This means you have to create your Program in a slightly different manner to obtain the final result you want. If you are into programming “computationally intensive” combinations of effects, you may have to learn to compromise in certain situations.

There are four categories to consider with regards to programming limitations: DSP power, Effect Memory, LFOs and Microprocessor Assistance.

DSP. The DSP (Digital Signal Processor) chip inside the Q20 is what processes all signals in the digital domain and creates all of the effects (sometimes with the assistance of the microprocessor). The DSP chip has a limit to how many instructions (per sample) it can handle. Some effects take up a large number of instructions, while others take only a few. Generally, reverbs are big DSP hogs, while most other effects use relatively small numbers of instructions. When you route “patch cords” between Blocks, each connection requires 1% of DSP power (2% if the level is not 0.0dB). If you run out of DSP power, the error message “DSP IS FULL” briefly appears. If this happens, consider substituting an effect that uses fewer instructions for one of the more DSP demanding effects you may be using.

Effect Memory. The on-board effect memory is primarily used for delay effects, but sometimes used by reverb effects (for pre-delay). In total you have 5.4559 seconds (or 5,455.9 ms), although the maximum delay time any single delay effect may have is 5 seconds. Once this memory has been allocated, the error message “EFFECT MEMORY IS FULL” will briefly appear when you try to apply more delay time to a delay effect than there is memory available. *Note:* If you have several delay Effect Blocks in a Program, they will share the total amount of effect memory that is available. If the total of all delay times equals that of available effect memory, you will not be able to increase any of the delay times until you decrease the delay time of one or more of the delay Blocks.

LFOs. The term LFO comes from the days of early synthesizers, where tremolo and vibrato effects were created using a Low Frequency Oscillator to modulate another oscillator’s pitch, or the filter or amplifier volume. In effect devices, LFOs are used to create effects such as flanging, chorus and Lezlie speaker emulation. The Q20 provides 4 LFOs per Program. Most pitch effects use 1 LFO, but some use 2. Also, some of the larger reverb effects use an LFO for a bigger sound. *Example:* If you try to add an effect using an LFO and you have already used all four LFOs in other Effect Blocks, the error message “OUT OF LFOs” briefly appears.

Microprocessor Assistance. Like most digital electronic music and audio products, the Q20 uses a microprocessor to run all basic functions like recalling, editing, comparing, storing, and renaming Programs, etc. However, some of the effect types use the microprocessor to assist the DSP chip in creating the effect, and the microprocessor is capable of assisting in this way for only one effect per Program. Three Pitch effects use the microprocessor: Phasor, Stereo Lezlie and Ring Modulator. Only one of these three may be used per Program. *Example:* If you try to create a Ring Modulator effect type when either a Phasor or Stereo Lezlie effect is already in use in the Program, the error message “BLOCK COMBINATION NOT ALLOWED” briefly appears.

In the back of this manual, you will find an index of effect types, listing the percentage of DSP, Effect memory and number of LFOs required by each. Use this as a reference when one or more categories of limit handling have been exceeded and you wish to learn what options exist in reorganizing the Program.

Equalization

Equalization, or EQ, provides the ability to control the timbre, or coloration, of an audio signal by changing the frequency response of a Q20 audio path. Filters and EQ can be used to compensate for frequency deficiencies in microphones and other sound equipment. The EQ family of functions in the Q20 contains filters, equalizers, and several other highly useful studio effects.

Filters

Lowpass, Bandpass, and Highpass

A filter allows the passing of frequencies within a certain range (called a filter's passband), and removes frequencies outside that range. The Q20 features a Lowpass Filter, which removes frequencies above its cutoff frequency (i.e., it allows low frequencies to pass through), and a Highpass Filter, which removes frequencies below its cutoff frequency. At the cutoff frequency, each filter attenuates the signal level by -3dB, and attenuates by 6dB per octave outside the passband. The Bandpass Filter passes frequencies near its center frequency, and removes all others. The Bandpass Filter has a bandwidth parameter to control how wide (in octaves) the passband is. Bandwidth is inversely related to the conventional "Q" value; that is, the higher the Q value, the lower the bandwidth. Bandwidth is used in the Q20 because it is a more familiar term to many musicians, and is more intuitive.

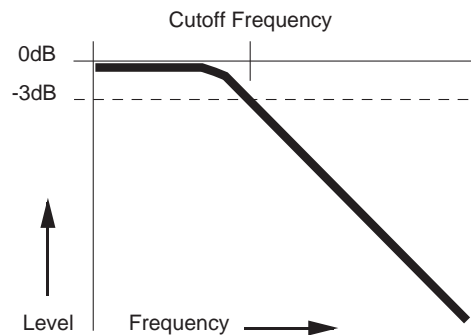

Lowpass Filter

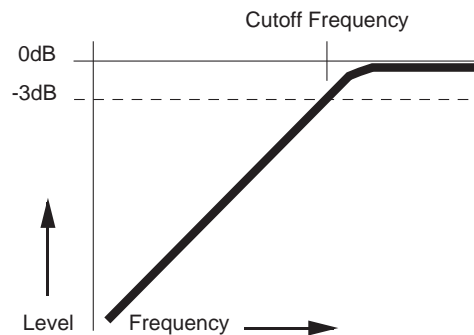

Highpass Filter

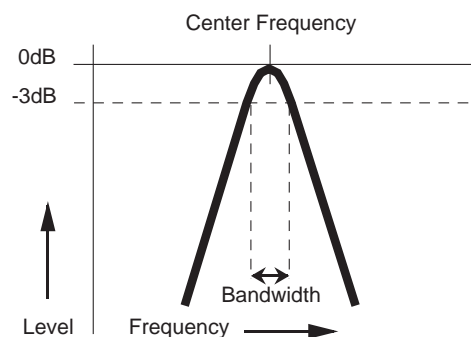

Bandpass Filter
(low bandwidth)

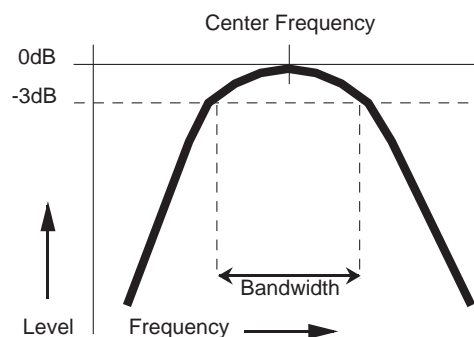

Bandpass Filter
(high bandwidth)

Shelving EQs

Lowpass Shelf and Highpass Shelf

A shelving EQ can boost or cut frequencies in its pass band, while allowing the frequencies outside its pass band to go through it. The shelving EQs of the Q20 provide gains from -14dB to +14dB in 0.1dB increments. Shelving filters are well suited for applications in which high or low frequencies need to be boosted or cut, but the remainder of the audio signal is to pass through unchanged. Applications for shelving EQs include removing high end hiss, and “tightening up” the sound of a bass instrument. The Highpass Shelving EQ is useful to compensate for a lackluster source that needs its high end brightened. The Lowpass Shelving EQ can be set to cut low frequencies to eliminate PA rumble.

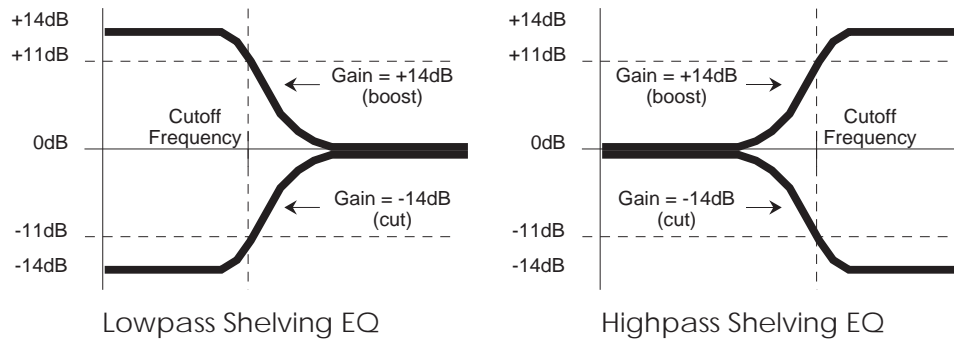

Single Band EQs

1 Band Low Parametric and 1 Band High Parametric

A single band parametric EQ allows frequencies within its passband to be amplified (boosted) or attenuated (cut) while allowing the remainder of the audio information to pass through unchanged. The Q20 provides a low frequency version (20Hz to 2000Hz), and a high frequency version (1500Hz to 10kHz). Single band parametric filters work well to highlight specific frequencies in a mix; for instance, bringing a tambourine to front and center, or boosting a repetitive bass line to achieve a realistic “inner-city throb”.

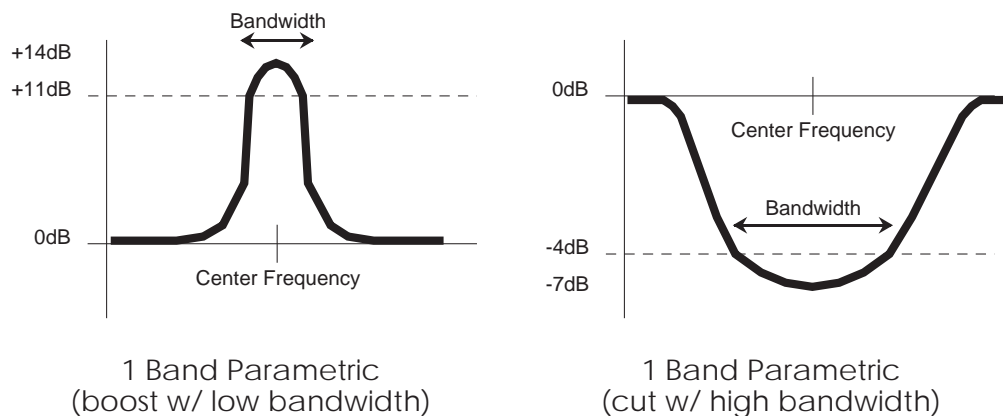

Multiband EQs

2 Band Sweep Shelf EQ, 3 Band Parametric EQ, and 4 Band Parametric EQ

Multiband EQs can be used to flexibly and accurately tailor the tonality of a signal. The 3 band and 4 band parametric EQs in the Q20 can be used to boost and cut multiple bands, with the added flexibility of controlling the bandwidth of one or two mid bands. The multiband EQs provide plenty of equalization in a single Block effect. For instance, the 2 band sweep shelving EQ can be used as a loudness control by boosting both low and high frequencies (Lowpass cutoff frequency set to 150Hz, Highpass cutoff frequency set to 4kHz). The three band parametric can be applied to a mix to simultaneously eliminate hiss, boost bass, and highlight a cowbell. Although it is possible to overlap the different bands, you should be careful to not be redundant.

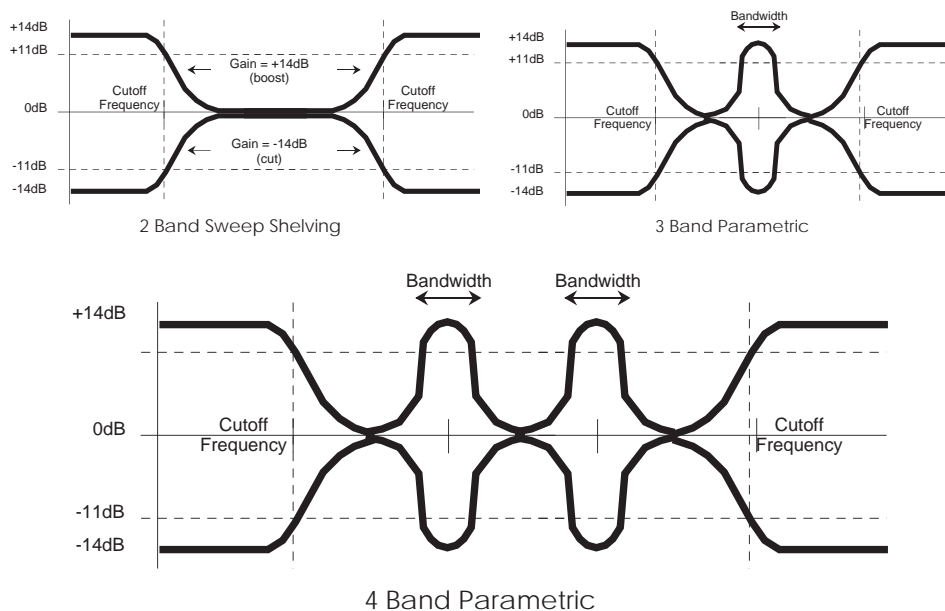

5 Band Graphic EQ

A graphic EQ is a set of bandpass filters of fixed frequencies and of equal bandwidths, spaced evenly across the audible frequency range. The 5 Band Graphic EQ in the Q20 has bandwidths that are two octaves wide at 63Hz, 250Hz, 1kHz, 4kHz and 16kHz. Graphic EQs are used for general tonal shaping.

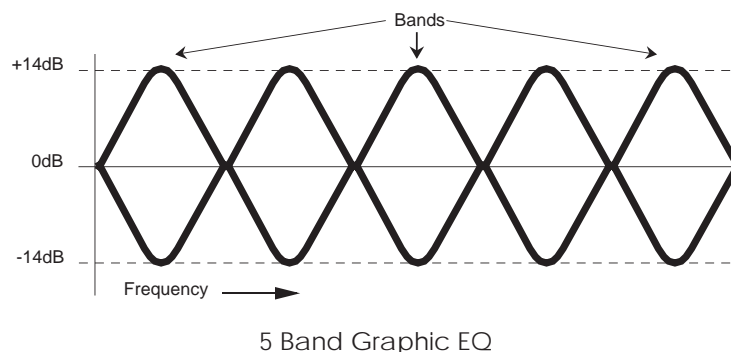

Resonator

A resonator is a special filter whose response is so sharp that it actually imparts a pitch to any signal going through it. By tuning the resonator to your instrument and balancing their relative amplitudes you can accentuate different harmonics in a guitar tone, for instance. This can be very useful to dramatically change the character of an instrument's sound.

Mono/Stereo Tremolo

The Mono Tremolo modulates the amplitude of its input signal according to three parameters: speed, which controls how often the sound changes amplitude; depth, controlling how strong the tremolos will be; and shape, which controls whether the amplitude transitions will be hard (drastic) or soft (gradual). Mono tremolo can recreate the sound of older guitar amps.

Stereo Tremolo alternates the loudness of the signal in opposite channels according to the same three parameters as the Mono Tremolo effect. On slow speeds with a soft shape, stereo tremolo provides continuous automated panning. At low to moderate depths and moderate speeds, the vibrating sound of traditional electric pianos can easily be reproduced.

Stereo Simulator

This effect is useful for “widening” a flat sound to produce a wider stereo field. It takes a mono sound source and creates the illusion that sound is emanating in stereo from a pair of speakers placed somewhere around the listener. By doing so, the sound appears spatially distributed, and takes on a lively new ambiance. When placed at 0 degrees, there is virtually no effect. At 90 degrees, there is an illusion that the speakers are on either side of the listener. At 99 degrees, the sound appears to come from slightly behind the listener's head.

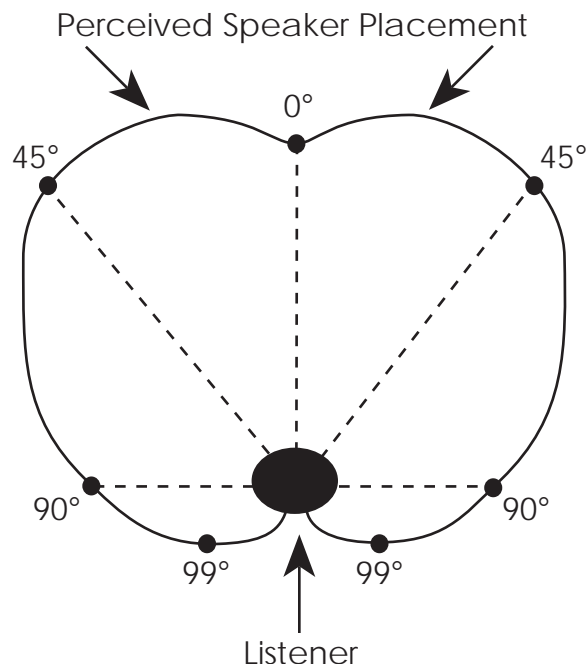

Overdrive

Two new distortion effect types finish out the set of EQ effects: Soft Overdrive and Hard Overdrive. The Soft Overdrive has less gain and provides slightly less distortion than the Hard Overdrive. Also, there will still be a slight bit of distortion when using the Soft setting if the signal feeding the Overdrive effect is below the Drive Level setting (see below). The Hard setting will only provide distortion when the signal feeding the Overdrive effect is above the Drive Level setting.

Tip: In addition to their obvious advantage when used with guitar signals, the Overdrive effects work extremely well with other instruments such as a harmonica, or rock organ sounds (especially when followed by a Lezlie effect).

Balance

The Balance parameter (Parameter mode, Page 1) controls the output mix of the Overdrive effect. It can be set anywhere from "OVERDRIVE<99" to "OVERDRIVE<00>CLEAN" to "99>CLEAN".

- When set to "OVERDRIVE<99". only the overdriven effect is heard.
- When set to "CLEAN<00>CLEAN", you have an even mix between the original, unaffected signal and the overdriven signal.
- When set to "99>CLEAN", the Overdrive effect cannot be heard at all.

Brightness

The Brightness parameter (Parameter mode, Page 2) sets the tone of the Overdrive effect. It can be set between 00 – 99. Higher numbers result in a brighter sounding overdrive. Lower numbers result in a duller distortion sound.

Drive Level

The Drive Level parameter (Parameter mode, Page 2) sets the level which the signal feeding the Overdrive effect must reach before the Overdrive effect will begin distorting. It can be set between 1.0 and 11.0. If this number is very high, the Overdrive effect will start to distort almost right away. When set to a low number, the distortion will not occur until the signal feeding the overdrive becomes louder than the Direct Level setting. When you need that extra "push", try setting the Direct Level to 11. *That's one louder, init?*

Triggered Panning with Doppler

This EQ Type creates the effect of audio moving back and forth between the left and right outputs. The “triggered” part means that the effect only occurs when triggered by one of a variety of sources, including: Audio (Left, Right or Both), Advance Footswitch or Bypass Footswitch. Once the Panning effect is triggered, it can sweep from either left to right or right to left (Retrigger Point), either once or continuously (Sweeping Mode), depending on how you have the parameters set up.

Speed

Speed (Parameter mode, Page 1) controls the rate at which audio will be panned between the two channels. It can be set between 0 and 99, with 99 being the fastest.

Doppler

Doppler (Parameter mode, Page 1) recreates the natural effect of pitch shifting that occurs when an object approaches and then passes you (*example*: an ambulance siren changing pitch as it races past you). It has a range of 0 (off) to 99 (maximum).

Distance

Distance (Parameter mode, Page 1) controls how far forward or back the panned sound appears to be. At higher settings, the far L and R ends of the pan are not audible.

Retrigger Point

Retrigger Point (Parameter mode, Page 2) determines on which channel (Left, Right or Alternating Left/Right) the panning motion will begin.

- When set to LEFT or RIGHT, the Panning effect will begin on the selected channel when triggered.
- When set to ALTERNATING L/R, the panning motion will alternate between beginning on either the Left or Right channel when triggered.

Sweeping Mode

Sweeping Mode (Parameter mode, Page 3) determines whether the Panning effect will occur only once, or continuously.

- When set to ONE CYCLE ONLY, the Panning effect (when triggered) will move from one channel to the other and back, and then stops until it is triggered again.
- When set to CONTINUOUS, the Panning effect (when triggered) will move from one channel to the other and back again over and over, until it is triggered again (at which point the cycle begins again).

Trigger Source

Trigger Source (Parameter mode, Page 4) determines what will trigger the Panning effect. This can be set to: Audio Left, Audio Right, Audio L & R, Advance Footswitch or Bypass Footswitch.

- When set to AUDIO LEFT, AUDIO RIGHT or AUDIO L & R, the Panning effect will be triggered whenever an audio level greater than -12 dB is sensed at the selected input(s).
- When set to either ADVANCE FOOTSWITCH or BYPASS FOOTSWITCH, the selected footswitch will not perform its normal function (that of advancing to the next Program or bypassing effects, respectively). Instead, the Panning effect will be triggered when the selected footswitch is pressed.

Phase Inverter

The Phase Inverter effect serves only one function: it shifts the phase of the audio being fed into its input by 180°. Phase inverting has many useful applications, one of which is used to record additional tracks on a multi-track recorder in order to simulate a surround effect. The Phase Inverter has only one parameter: Output Phase. When the Output Phase is set to INVERTED, the phase of the audio is shifted 180°. When set to NON-INVERTED, the audio is left unchanged.

This can be useful for a variety of sound design applications. Try creating your own feedback loop in a delay (by making a route which feeds back into the delay's input) and inserting this phase inverter. Or try flipping the signal out of phase before sending it through a chorus or flange for a thinner sound. The Phase Inverter can also be useful in video post production as a quick and dirty surround panner.

Pitch Effects

The Pitch effects alter the pitch of a signal in various ways to produce “layered” timbres that are more complex than the original signal. Although some of these effects can sound similar to one another depending on the parameter settings, each is achieved differently and can be quite dramatic under the right circumstances. Pitch effects are achieved by splitting the signal into at least two parts, effecting the pitch of one of the parts, then mixing them back together. This eventual mixing is essential since the overall sound of the effect is achieved by the actual difference between the normal, unaffected signal and the effected signal. The various types of Pitch are:

Mono Chorus

The Chorus effect is achieved by taking part of the signal, slightly delaying it, and then slightly detuning it as well. The detuning is further effected by being modulated by an LFO which causes the detuning to vary. Many parameters are available in this scheme. The Predelay can be varied, the LFO depth can be varied, the LFO speed can be varied, and a portion of the detuned signal can be fed back to the input to increase the effect. Finally, the waveform shape of the LFO can be changed from a sine wave, to a more abrupt squarewave to make the pitch detuning more pronounced.

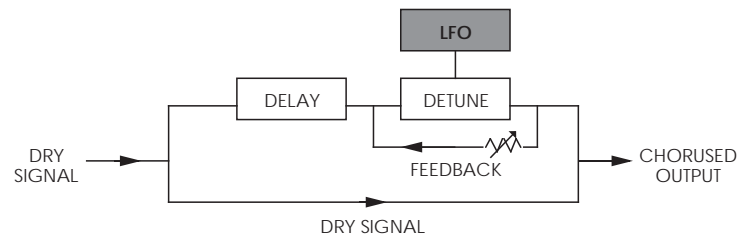

Stereo Chorus

In the case of a Stereo Chorus, the signal is split into three parts with a dry signal and a separate Detuning section for both left and right channels. When the left channel is detuned sharp, the right is detuned flat, and vice versa. Once again, this causes the effect to become more pronounced and dramatic. All the parameters of the Mono Chorus are also found here, although each of the two detuned signals has its own individual Predelay amount.

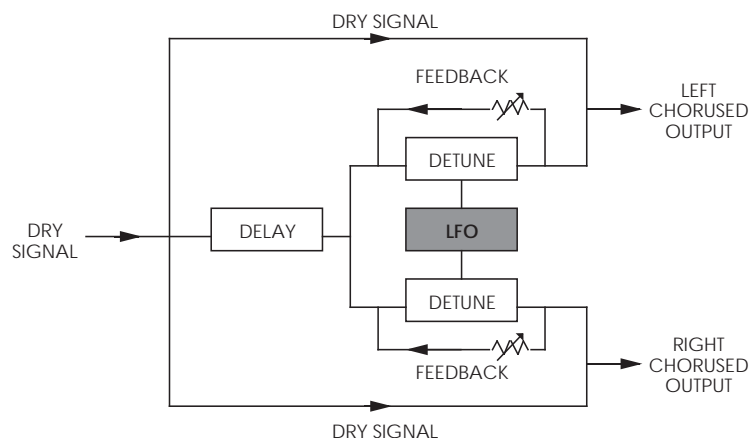

Quad Chorus

Quad Chorus modulates four delayed signals, each with its phase offset by 90° . Each of the four signals has a separate Predelay parameter, allowing you to change the “rhythm” of the phasing.

Mono Flanging

Flanging is similar to chorusing, but modulates the delayed signal over a much shorter delay range (typically 0-12ms). This produces a “jet airplane”-like sound. Mono and stereo flanging is available, and the flange modulation sweep can be triggered in order to sync up with the rhythm of your playing.

First used in the 1960s, “Flanging” was achieved by the use of two tape recorders that would record and play back the same program in synchronization. By slowing down one tape machine, and then letting it catch up with the other, different phase cancellations would occur at different frequencies. Since the slowing down of the tape machines was done by hand pressure against the flanges of the tape supply reels, the term “Flanging” came into being.

The effect of Flanging is achieved by splitting and slightly delaying one part of the signal, then varying the time delay with an LFO. The delayed signal is then mixed with the original sound to produce the “swishing” or “tunneling” sound.

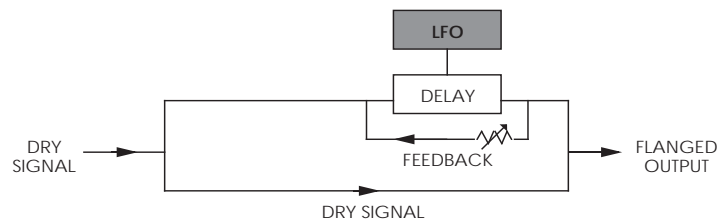

Many parameters are available, from varying the speed and depth of the LFO to feeding back part of the signal to make the effect stronger. The Feedback parameter (Parameter mode, Page 1) of all four Flanger effects (Mono Flanging, Stereo Flanging, Mono Trigger Flange and Stereo Trig. Flange) may be set to negative values as well as positive. Negative values results in the signal being fed back to be out of phase, creating a more hollow sound. The value range goes from -99 to 0 to +99.

Stereo Flanging

In the case of the Stereo Flange, the signal is split into three parts with a dry signal and a separate Delay section for both left and right channels with one channel flanging up while the other channel flanges down. Once again, this causes the effect to become more pronounced and dramatic.

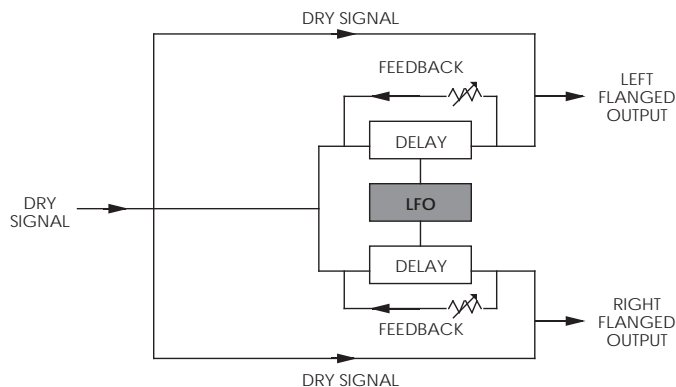

Phasor

Another popular effect is the Phasor or Phase Shifter. Although similar to flanging, this effect is produced differently. Again, part of the signal is split from the original signal. The Phasor shifts the phase of different frequencies in different amounts, resulting in a comb filter effect when combined with the dry signal.

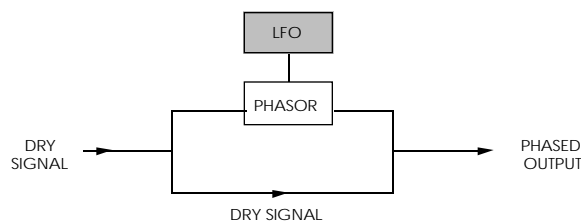

Mono/Stereo Leslie Cabinet

With the Leslie type selected, the pitch change Block becomes a rotating speaker simulator. This effect was extremely popular during the 1960's and was achieved by mechanically rotating the speakers to produce complex timbral changes. The Leslie speaker system is most often used with tone wheel organs, but is occasionally used for guitar amplification as well. You have control over the motor (on/off), speed (slow/fast) and high rotor level (-12/+6dB), which controls the brightness of the effect.

The stereo version gives you an additional parameter called Stereo Separation. This gives you control over how "wide" the stereo signal should appear. There are two different "rotating speaker" simulation types to choose from, circular and linear. "Circular" uses a complex, elliptical equation for a realistic forward/back depth. The "Linear" scheme is a simpler panning routine which provides a wider stereo spread. You can select between the two simulation types by setting the Stereo Separation parameter to either a positive or negative value. Experiment with both to find which works better with your music.

Pitch Shifter

This effect type shifts the pitch of the input signal by a fixed amount. This creates a thickening effect similar to the difference between a 12-string and 6-string guitar.

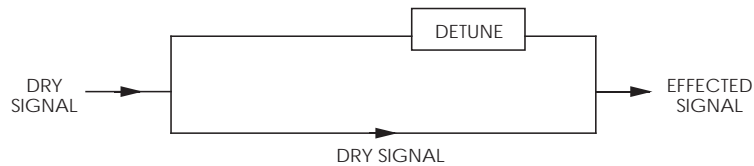

Pitch Detune

This effects detunes the pitch of the input signal by + or - 99 cents. A cent is 1/100 of a semitone. A pitch shift of +99 cents applied to a C natural will make it sound as a C sharp. The input signal is not split, therefore if you want to create dissonance, you must route the input signal to the outputs and blend them together for the desired effect.

Ring Modulator

This generates an outer-spacey, metallic, distorted version of the input signal by modulating it against an internally-generated digital oscillator. This shifts the frequency spectrum upwards or downwards depending on the setting of the Spectrum Shift parameter. For example, if Spectrum Shift is set to +100, the input and all its harmonics will be shifted up nonharmonically by 100 Hz.

Triggered Flanging

The new Mono Trigger Flange and Stereo Trigger Flange effects (Pitch function) are identical in every way to their original counterparts (Mono Flanging and Stereo Flanging, respectively) except that they both provide an additional function: they can be triggered to produce a sweeping effect. Three additional parameters have been added to make this possible.

Retrigger Point

The Retrigger Point parameter (Parameter mode, Page 2) determines at which point in the Flanger effect's cycle it should begin when triggered. This can be set to a value between 0 and 255. On the Mono Triggered Flange, a value of 64 will produce a downward sweep.

Sweeping Mode

The Sweeping Mode parameter (Parameter mode, Page 3) determines whether the Flanger effect will occur only once, or continuously.

- When set to ONE CYCLE ONLY, the Flanger effect (when triggered) will cycle once, and then stop until it is triggered again.
- When set to CONTINUOUS, the Flanger effect (when triggered) will cycle continuously, until it is triggered again (at which point the cycle begins again at the Retrigger Point of the cycle).

Trigger Source

The Trigger Source parameter (Parameter mode, Page 4) determines what will trigger the Flanger effect. This can be set to: Audio Left, Audio Right, Audio L & R, Advance Footswitch or Bypass Footswitch.

- When set to AUDIO LEFT, AUDIO RIGHT or AUDIO L & R, the Flanger effect will be triggered whenever an audio level greater than -12 dB is sensed at the selected input(s).
- When set to either ADVANCE FOOTSWITCH or BYPASS FOOTSWITCH, the selected footswitch will not perform its normal function (that of advancing to the next Program or bypassing effects, respectively). Instead, the Flanger effect will be triggered when the selected footswitch is pressed.

Delay

Delay provides a discrete repetition of a signal. By adding feedback within the effect, the delayed signal can repeat many times, with each successive decay softer than its predecessor. Each Delay type allows you to adjust delay time in milliseconds, but also displays the equivalent tempo in BPM (beats per minute), with the exception of Multi Tap Delay. The Q20 offers four types of delay:

Mono Delay and Stereo Delay

Mono Delay provides a single delay of signal up to 5000.0ms (this is subject to the limit of delay time being used by other Blocks). Feedback is also available to increase the complexity of the signal. The stereo version provides two separate delays which can be individually adjusted for delay time and Feedback.

Ping Pong Delay

So called because the output bounces from left to right in stereo with the speed determined by the delay time.

Multi Tap Delay

This is sort of like having five delays at once. Each of the 5 “taps” have individual volume, delay, panning and feedback controls. By adjusting the delay of each tap, you can create sophisticated rhythms. A Master Feedback control is available, making it easy to adjust the total number of “echoes” for all taps at once.

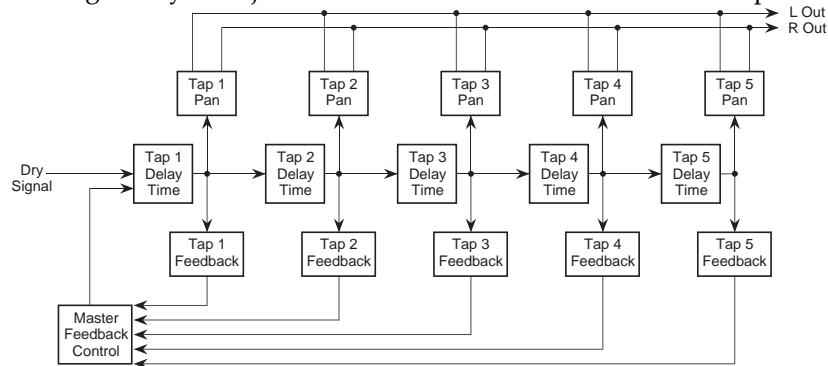

Tap Tempo Mono Delay and Ping Pong

These are similar to the mono delay and ping pong delay types, but can have their delay time parameters set using a technique called “tap tempo” (where you literally tap in the desired tempo to establish delay time), using either the [VALUE/ENTER] button or a footswitch. You can select which footswitch jack (either [ADVANCE] or [BYPASS]) you want to use in Global Page 8. These types also sync to MIDI Clock pulses on the MIDI Inputs, simply plug your sequencer or drum machine into the Q20 to sync the delays to the song’s tempo.

An additional parameter, called Beat Count, is used to determine what note value your tempo tapping represents. For example, if you set the Beat Count to 1/4, then you can tap in quarter-notes to establish delay time (and tempo). If instead you set the Beat Count to 1/8T, you can play in eighth-note triplets to establish the delay time.

Sampling

Once a Block is de-fined as a Delay function, you can select the Sampler effect type. The Sampler has one mono input and one mono output. Two Sampler Blocks can be used in a single Program to provide stereo sampling (one for the Left channel, the other for the Right).

Note: In the case where a Program uses two Sampler Blocks for stereo sampling, both Sampler Blocks will use the same parameters. In other words, changing the parameter settings of either Sampler Block will affect the other.



The Sampler cannot be used if a Stereo Lezlie, Phasor, Ring Modulator, Mono or Stereo Triggered Flanging or Triggered Panning Block is active, and vice-versa.

Before sampling, you should set the Maximum Sample Length parameter (page 2) to determine how long the Sampler effect will record audio once recording has begun. You can sample up to 5 seconds of audio (depending on available memory), using either the analog or digital inputs, depending on which is selected as the Input Audio Source (in Global Mode, page 4). The sampled audio is stored in the Sample Buffer. The Sample Buffer can then be triggered in a variety of ways.



Changing the Maximum Sample Length parameter, bypassing the effects, or changing a Block type or Delay effect's delay time in a Block which comes before the Sampler Block will ERASE THE SAMPLE BUFFER. Therefore, it is recommended that the Sampler effect be used in Blocks 1 and/or 2. If you are adding the Sampler effect to an existing Program, you should use the Move Block command to rearrange the existing Blocks and make room for the Sampler Block.

Sample Play

The Sample Play parameter (Parameter Mode, Page 1) determines how the Sample Buffer will play back once it is triggered. This can be set to either LOOPING, 1 SHOT or GATED. No matter which of these is selected, the Sample Buffer can be played by pressing the [VALUE/ENTER] button while the Sample Play parameter is selected. Additionally, playback of the Sample Buffer can be triggered from a number of other sources, including: MIDI note, either footswitch or audio. This is determined by the Play Trigger parameter (page 4).

- When set to LOOPED, the Sample Buffer will play back in a continuous loop mode when triggered, and will loop indefinitely until another Program is selected, or the Sample Play mode is changed, or a new sample is recorded, or the Maximum Sample Length parameter is changed which would also result in the Sample Buffer being erased.
- When set to 1 SHOT, the Sample Buffer will play only once when triggered.
- When set to GATED, the Sample Buffer will play back in a continuous loop mode only as long as the trigger source is detected; i.e., as long as the [VALUE/ENTER] button is held. If the Play Trigger parameter is not set to ENTER, the sample will play for as long as the selected trigger source is detected. *Example:* If the Play Trigger parameter is set to AUDIO LEFT & RIGHT, the Sample Buffer will play as long as audio is detected at either the analog or digital inputs, depending on which is selected as the Input Audio Source.

If you attempt to trigger sample playback when no audio has been sampled, the display will temporarily read:

SAMPLE BUFFER IS EMPTY

Rec

The Rec parameter (also found on Page 1 of Parameter Mode), determines how recording of audio shall begin. This can be set to either 1 SHOT or GATED. No matter which of these is selected, recording can begin by pressing the [VALUE/ENTER] button while the Rec parameter is selected. Additionally, recording can be triggered from a number of other sources, including: MIDI note, footswitch or audio. This is determined by the Rec Trigger parameter (see page 4).

- When set to 1 SHOT, recording begins immediately once triggered (for example, by pressing [VALUE/ENTER] button) and continues for the amount of time specified in the Maximum Sample Length parameter (see below).
- When set to GATED and recording is triggered (for example, by pressing the [VALUE/ENTER] button), recording of audio will begin and continue for as long as the selected trigger source is detected or until the amount of time specified by the Maximum Sample Length parameter has elapsed. If the Rec Trigger parameter is not set to ENTER, the sample will play for as long as the selected trigger source is detected. *Example:* If the Rec Trigger parameter is set to AUDIO LEFT & RIGHT, recording will begin once audio is detected at either the analog or digital inputs, depending on which is selected as the Input Audio Source, and continues until audio is no longer detected or until the Maximum Sample Length parameter has been reached.

Maximum Sample Length

The Maximum Sample Length (Parameter Mode, Page 2) is the amount of time the Sampler effect will record audio once recording has begun (see previous section). This can be set from 250.0 ms to 5000.0 ms (or 5 seconds), in .1 ms increments.



If the Maximum Sample Length parameter is changed, the Sample Buffer is erased.

Start and End Pointers

The Start and End parameters (Parameter Mode, Page 3) serve as “pointers” which determine the section of recorded audio the Sample Buffer will play back when triggered. If you have recorded audio with the Rec parameter set to 1 SHOT (see above), you may end up with some “empty silence” at the beginning of your sample. By adjusting the Start pointer, you can have the Sample Buffer begin at the desired section of your recording when it is triggered. If, on the other hand, you have an annoying mistake at the end of an otherwise perfect recording, you can adjust the End pointer so that the Sample Buffer stops playback before the mistake occurs.

The Start pointer can be set from 0.0 ms to at least 50 ms below the End pointer’s current setting. The End pointer can be set from at least 50 ms above the Start pointer’s current setting to the Maximum Sample Length parameter’s setting. Both can be adjusted in .1 ms increments.

While adjusting either the Start or End pointer values, you can trigger the Sample Buffer by pressing the [VALUE/ENTER] button. This way you can audition your changes as you make them. *Note:* If the Sample Play parameter is set to LOOPED and the Sample Buffer is triggered, the Sample Buffer will continue to use the same Start and End settings while it is looping playback. If you make changes to the Start and End pointers, you must press the [VALUE/ENTER] button to retrigger the Sample Buffer and hear your changes.

Play Trigger

The Play Trigger parameter (Parameter Mode, Page 4) determines how playback of the Sample Buffer will be triggered.

- When set to ENTER, the Sample Buffer will **only** be triggered by pressing the [VALUE/ENTER] button while the Sample Play parameter is selected. However, even when another trigger type is selected, you will always be able to trigger the Sample Buffer using the [VALUE/ENTER] button in this manner.
- When set to AUDIO LEFT, AUDIO RIGHT or AUDIO LEFT & RIGHT, the Sample Buffer will be triggered whenever an audio level greater than -12 dB is present at either the analog or digital inputs, depending on which is selected as the Input Audio Source.
- When set to MIDI NOTE #, the Sample Buffer will be triggered by an incoming MIDI note message, as determined by the Note # parameter (see below).
- When set to either ADVANCE FOOTSWITCH or BYPASS FOOTSWITCH, the selected footswitch will not perform its normal function (that of advancing to the next Program or bypassing effects, respectively). Instead, the Sample Buffer will be triggered when the selected footswitch is pressed.

Rec Trigger

The Rec Trigger parameter (Parameter Mode, Page 5) determines what will trigger the recording of audio into the Sample Buffer.

- When set to ENTER, recording will **only** be triggered by pressing the [VALUE/ENTER] button while the Rec parameter is selected. However, even when another trigger type is selected, you will always be able to trigger recording using the [VALUE/ENTER] button in this manner.
- When set to AUDIO LEFT, AUDIO RIGHT or AUDIO LEFT & RIGHT, recording will be triggered whenever an audio level greater than -12 dB is present at either the analog or digital inputs, depending on which is selected as the Input Audio Source.
- When set to MIDI NOTE #, recording will be triggered by an incoming MIDI note message, as determined by the Note # parameter (see below).
- When set to either ADVANCE FOOTSWITCH or BYPASS FOOTSWITCH, the selected footswitch will not perform its normal function (that of advancing to the next Program or bypassing effects, respectively). Instead, recording will be triggered when the selected footswitch is pressed.

Note: If the Play Trigger and Rec Trigger parameters are set to the same source, that trigger source will trigger recording only when the Sample Buffer is empty. At all other times, it will trigger playback of the Sample Buffer. *Example:* When using the same footswitch to trigger both recording and playback, the first time you press the footswitch, recording will begin; thereafter, pressing the footswitch will only playback the Sample Buffer, until the Sample Buffer is cleared.

Note

The Note # parameter (Parameter Mode, Page 6) determines which MIDI note message will trigger either recording or playback of the Sample Buffer, if either the Play Trigger or Rec Trigger is set to MIDI NOTE # (see above). This parameter can be set to a specific note number from 0 (C-2) to 127 (A8) or to ALL, in which case any MIDI note message will trigger playback of the Sample Buffer.

Note: The MIDI note messages must be received on the same MIDI channel that the Q20 is set to (MIDI Mode, Page 1).

Rec Audio

The Rec Audio parameter (Parameter Mode, Page 6) determines whether or not the audio being recorded into the Sample Buffer will be routed to the audio outputs. This can be set to either ON or MUTE.

- When set to ON, the audio being fed to the Sampler effect will be heard at the QuadraVerb 2's outputs while recording is taking place.
- When set to MUTE, the audio being fed to the Sampler effect will not be heard at the outputs. This means you can sample audio without hearing it until you are ready to trigger the Sample Buffer.

Reverberation

Reverb is made up of a large number of distinct echoes, called reflections. In a natural acoustic space, each reflection's amplitude and brightness decays over time. This decaying action is influenced by the room size, the location of the sound source in the room, the hardness of the walls, and other factors. The Q20 offers many types of reverberation:

Mono Room

This uses a very small amount of DSP and is useful for combining with other effects, or for dual-mono reverb applications.

Room 1

This algorithm gives you the sound of a medium sized studio room. It doesn't use a lot of DSP, so it's useful for placing at the end of a guitar multi effect program or for using 2 reverbs at once for dual processing. Try it on percussion and brass, too.

Hall 1

This is a simulation of a large concert hall. Halls tend to be large rooms with lots of reflective surfaces, so sounds can swim around, changing timbre over time. It doesn't need a lot of DSP, so you can use it on a guitar multi effect or a dual reverb send program.

Plate 1

This is a simulation of a classic echo plate, a 4' by 8' suspended sheet of metal with transducers at either end used to produce reverb. Popular in the 1970's, it is still prized for its transparent sound, particularly on vocals and guitars.

Chamber 1

Reverb chambers are small rooms made of the hardest, smoothest surfaces available (often marble). A loudspeaker is placed at one end, and 1 or 2 microphones at the other end. The decay time is adjusted by the distance from the microphones to the speaker and by sound diffusers placed in the room. This algorithm works well for keyboards and acoustic instruments.

Room 2

This algorithm uses more DSP for a richer sound and smoother decay. It compares quite favorably to high end studio reverbs for its rich sound. The attack is also more reflective. It sounds good on drums, organs, keyboards and guitars.

Hall 2

More processing is dedicated for a more realistic, airy concert hall. This is a classic reverb which sounds good on just about anything; try it on vocals, drums, acoustic, electric, or orchestral instruments.

Plate 2

A richer version of Plate 1 which uses more processing power for more density and a smoother decay.

Chamber 2

This is similar to Chamber 1, but uses more DSP for a thicker sound. The high end in particular has a glassy decay which sounds excellent on synthesizers and pianos, but try it on vocals, too. This will sound more realistic when using short decay times.

Large Plate

This algorithm uses the most processing available for a truly realistic reverb plate simulation. It works well for a lush lead vocal, piano, or guitar, especially when looking for a classic rock and roll sound.

Large Room

This algorithm uses the most processing for the most realistic possible sound. It has a nice smooth decay for drums and a fat attack to warm up guitars and percussion. Try gating it for that classic British progressive rock drum sound.

Spring

Classic guitar amplifiers used a suspended spring with transducers at either end to simulate reverb. It produces a ringy, resonant sound, which can be good for vintage guitar applications. With this algorithm, you get the character of a spring without the “boing”.

Nonlinear

An effect pioneered in the early 1980's was gated reverb. Either a live room or a digital reverb was sent through a noise gate, which was then triggered by the input signal. This created a large reverberant space which would cut off suddenly. You can get this effect in any of the other reverb algorithms, but “Nonlinear” simulates the sound of classic “gated” digital reverb programs. It is generally used for drums and percussion.

Reverse

Another popular trick in the 80's was to record the reverb with the tape flipped over, so it would play backwards in the mix. It is a useful effect for drums and other percussive sounds — it adds space without washing out the instrument.

Reverb Parameters

Most of the reverb effects in the Q20 operate under the same set of control parameters, which are listed and described in this section. However, reverbs which use more DSP provide parameters which take advantage of their extra processing power; parameters which are not found in the other, smaller reverb algorithms. For example, Reverberation Swirl is a parameter found in the Room 2 and Hall 2 types, but not in Plate 1. And the Nonlinear reverb type does not provide gating options, since it is already a “gated reverb” algorithm. Here are the reverb parameters:

Decay

The Reverb Decay determines how long the Reverb will sound before it dies away. When using the Reverse Reverb type, Reverb Decay controls the Reverse Time.

Damping – Hi & Lo

These two parameters allow the Decay Time to be set separately for both the low and high frequencies of the Reverb. This means that you have control over the tonal shape of the Reverb itself, being able to make the high frequencies die faster if the effect is too bright, and being able to make the lows die faster if the effect is too boomy. This allows you to simulate different surfaces of a room or hall, with softer surfaces absorbing more high frequencies and smaller rooms having faster low frequency decay.

Density

Density controls how the first reflection of the reverb effect will appear. When set to 0, the first reflection is heard alone without any other reflections. When set to 99, the first reflection appears to “fade-in” and then “fade-out”. This is because a number of reflections will occur just before and just after the first reflection, in addition to the remaining reflections heard after the first reflection. Thus, the reverb sounds more “dense”.

Diffusion

Diffusion determines the “thickness” of the reverb sound by adding more reflections to the reverb’s decay. With lower diffusion settings, you may be able to actually hear the individual echoes that make up the overall reverb sound. With higher diffusion settings, the echoes increase in number and blend together, washing out the reverb’s decay. Greater diffusion works better with percussive sounds, whereas less amounts of diffusion work well with vocals and other sustained sounds.

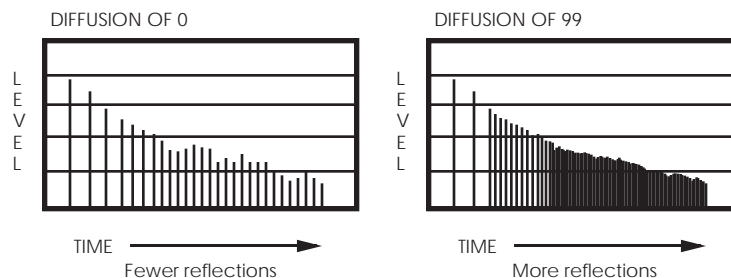

Note: The illustration above reflects a Density setting of 0.

Input High Frequency Roll Off

This is a lowpass filter that can be set between 200Hz and 20kHz, and attenuates all frequencies above this value by 6dB per octave.

Predelay

All the reverb effects also have pre-delay parameters. Predelay slightly delays the reverb itself up to 250 ms, so that the dry signal more easily stands out from the reverb. A bit of predelay can make certain instruments (such as snare drums) sound bigger.

Predelay Mix

This allows you to balance the amount of predelay to direct signal as a percentage of each. This gives you the ability to hear a bit of the reverb before the loudest part of the reverb (the predelayed reverb) sounds, and makes for a bigger, smoother sounding reverb.

Reflection Level and Spread

This is only used with the more complex reverb algorithms, such as Room 2, Hall 2, Plate 2, Chamber 2 and Large Plate. Level controls the amplitude of the early reflections. Spread controls the reflection's density, or how close they are together.

Reverberation Swirl

This adds a type of stereo chorus-like effect to the output of the reverb. Only used in Room 2, Hall 2 and Large Plate, this parameter is most useful for smoothing the decay of the reverb when set at a low value. When set to a high value, it creates a more dramatic detuning effect.

Reverberation Attack

Only used in Plate 2 and Chamber 2, this controls the amount of extra signal added to the beginning of the reverb's effect, which in turn controls the intensity of the reverb's attack.

Gating

Of all the different reverb types, only two types do not provide gating parameters ("Reverse" and "Nonlinear"). Gating is the process which abruptly cuts off the reverb's decay for a more "choppy" sound. This effect was very popular on drums in the 80s because it makes them sound HUGE. It is achieved by dropping the level of the signal very rapidly after the initial attack making a short, sharp sound.

There are four gating parameters available in most of the reverb types. These include: Gate Trigger Source, Hold Time, Gate Release Time and Gate Level. The Trigger Source can be either the Left or Right inputs, or both. Or this can be set to "OFF" when you do not wish to use the gating effect. The Hold Time determines how long the gate will be held open before it begins to turn off; this can be set from 10 to 500 ms. The rate at which it closes is determined by the Gate Release Time, which can be set from 0 to 500 ms. The Gate Level controls the level of the reverb signal after the gate closes. In other words, if the Gate Level is set to 99, then no reverb will sound after the gate turns it off. If the Gate Level is set to 50, then some reverb signal will still be present even after the gate turns off the main reverb signal.

CHAPTER 4

MAKING YOUR OWN PROGRAMS

Getting Started

Because the Q20's custom LCD display clearly shows the audio routings between each of the 8 possible Effect Blocks, creating and modifying your own patches is extremely easy and flexible.

There are 300 possible Program locations available, divided into three banks – Preset, User 0 and User 1 – of 100 Programs each. These Programs are numbered 0 through 99. The Q20 is shipped with 100 factory presets in the Preset bank; these can be modified but not permanently changed. All edited programs must be stored in the User bank .

Let's start by creating a simple single-Block program starting from scratch, then go on from there by adding other blocks. We'll use Preset #99, which has been left un-programmed for the purpose of this tutorial. Refer to Chapter 2 for information on selecting programs.

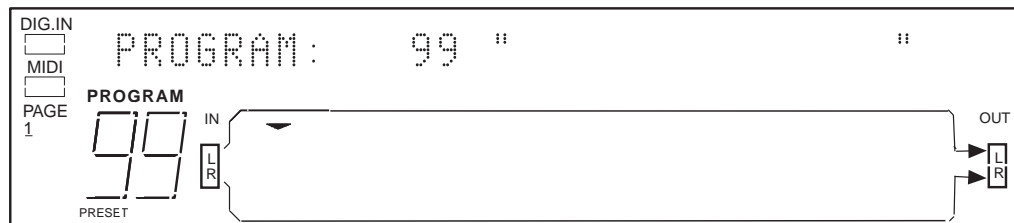

This program has the L/R INs routed directly to the L/R OUTs, respectively. Consequently, there is no audible change to the signal we are feeding to it. Our signal is clean (dry) now, so let's add an effect.



If the Global Direct Signal Mute function is turned on, any Programs which have the L/R IN routed to the L/R OUT will not display these "patch cords" except when editing the Program's routings. This is to avoid confusion when operating in this mode. For more information on Global Direct Signal Mute, see Chapter 2.

There are generally five Block Functions available for creating and editing Programs, which are: Type, Routing, Parameter, Mix and Modulation. Modulation deals with controlling various parameters in real-time via a MIDI controller. This information is covered in Chapter 6. For now, let's stick to the basics, and go through the Functions one at a time.

Programming A Single Block

Type



A Block can provide Equalization, Pitch, Delay, Reverberation or be turned OFF. A program can contain up to eight Blocks, which can be in almost any combination or order within the confines of available DSP memory.

The Block's Type determines not only what parameters are available in the Parameter function, but also what routings are available in the Routing function. Each Block can be modified according to the available parameters (based on the Block's "type"), and routed independently of the other Blocks.

- ① Press the [TYPE] button.
The [TYPE] button's LED will light .
- ② Press the [< BLOCK] button repeatedly until the pointer is above the leftmost Block in the display (this is Block #1's position).
The display will show page 1 of Type mode (there are 3 pages in this mode):

```
BLOCK 1 FUNCTION: OFF
```

- ③ Turn the [VALUE/ENTER] knob to select EQUALIZATION as the Block Function.
The function will flash until you press the [VALUE/ENTER] button.
- ④ Press the [VALUE/ENTER] button. The display will read:

```
ADD ROUTE FROM INPUT: NONE
```

This function allows you to quickly add routes to the new block from the input and to the output when writing simple programs. For the purpose of this tutorial, simply press the [VALUE/ENTER] button twice.

- ⑤ The EQ module will now be displayed as Block 1, and the display automatically advances to Page 2.

```
EQ TYPE: LOWPASS FILTER
```

- ⑥ Turn the [VALUE/ENTER] knob to scroll through the various EQ effect types. *By rotating the dial we can also see various Shelving, Parametric, and Graphic types of EQs. As we dial through the EQ types they will flash in the display. Let's select a 3 Band Parametric EQ.*

```
EQ TYPE: 3 BAND PARAMETRIC EQ
```

- ⑦ Press the [VALUE/ENTER] button.
The EQ type will now be selected for Block 1, and the display will move back to Page 1 of the Type function.

Routing

Routing is the Function used to connect audio between the L/R IN and the Effect Blocks and the L/R OUT. We must route audio to both the inputs and outputs of our EQ Block in order to hear its effect. Routing is always done by selecting the destination (where you want the audio to go to) and assigning it a source (where you want the audio to come from). After making a connection, you can then adjust the level of the source's signal.

- ① Use the [< BLOCK >] buttons to select the EQ Block we just created.
If you just finished the previous tutorial, the EQ Block should already be selected.



The IN L/R is not selectable as a Block.

- ② Press [ROUTING].
The [ROUTING] button's LED will light and the display will read:

```
ADD ROUTE FROM: INPUT LEFT
```

The cursor appears under the setting (INPUT LEFT) which is flashing.

- ③ Turn the [VALUE/ENTER] knob to scroll through the various options.
The choices are INPUT LEFT, INPUT RIGHT or EQ 1 MIX. As you scroll through, notice the flashing "patch cord" which appears in the lower display connecting IN L to EQ IN or IN R to EQ IN or M out to EQ IN, depending on which option you are viewing in the upper display.

All three options are routed to the EQ Block's input, so their nomenclature is determined by their source, i.e. FROM INPUT LEFT, FROM INPUT RIGHT, etc.

- ④ With the "INPUT RIGHT" option selected, press the [VALUE/ENTER] button.
This connects the signal from the Right input of the Q20 (IN R) to the input of the EQ module.

Upon pressing the [VALUE/ENTER] button in step 3, the display automatically advances to Page 2, which is where we may set the level of this connection (the volume from the right input to the EQ in). The display now reads:

```
LEVEL FROM: INPUT RIGHT = -6.0dB
```



The patch cord will still flash until a level has been dialed in.

- ⑤ Turn the [VALUE/ENTER] knob to select the input level for this connection.

Level Setting

The input level is an important parameter, the setting of which can have a drastic impact on the resulting effect. It's default setting of -6.0dB represents the "halfway" point of its range. 0 dB is the loudest using no attenuation, while OFF mutes the route entirely.

You should set the level to accommodate the headroom the effect will need. For example, even if the front panel input levels are below clipping, if you boost an EQ band, it can distort the internal processor of the Q20. The -6.0 dB setting will accommodate most blocks, but if there is clipping internally (when the red LED's flash on input), lower the input level. You may also need to lower the routing level if a block is receiving signal from more than one source.

On the other hand, the best signal-to-noise ratio is achieved when signals are as loud as possible without clipping. In the case of a one-block program, the routing from the block to the L and R outputs should be at 0.0 dB. Multiple-block programs will need lower settings to avoid clipping at the output blocks.

- ⑥ Press the [VALUE/ENTER] button to set the level from -48.0dB to 0dB.
- ⑦ Press the [BLOCK >] button to move the pointer to the OUT R Block.



The OUT L and OUT R are selectable as separate destination Blocks.

The display will flash:

```
ADD ROUTE FROM: EQ 1 MIX
```

Note that the flashing patch cord now connects the EQ1 M to the OUT R and if we turn the [VALUE/ENTER] knob, we can see the following possible input sources for the right output:

```
ADD ROUTE FROM: EQ 1 IN MIX
```

```
ADD ROUTE FROM: INPUT LEFT
```

Note that the route from Input Right can't be added, because it's already there as part of the default patch #99.

As we scroll through the various input sources, the display will flash each one's patch cord while selected.

Let's choose EQ 1 MIX (this is the Mix output of our EQ, which is Block 1). This is not to be confused with EQ 1 IN MIX, which is the signal being received at the EQ Block's input.

- ⑧ With "EQ 1 MIX" selected, press the [VALUE/ENTER] button.

Like before, the display automatically advances to page 2, and now asks us to set the level from the EQ 1 MIX output going to the Right Output.

```
ENTER LEVEL FROM EQ 1 MIX: -6.0dB
```

- ⑨ Turn the [VALUE/ENTER] to select a level from -48.0dB to 0dB (100%).
- ⑩ Press [VALUE/ENTER] button to set the level.

We have now connected the output of the EQ to our Right output.

Having connected both an input and output to our EQ Block, we can now hear the effect and change the parameters.

Parameter

Now we will choose the desired parameters for our EQ.

- ① Press the [PARAMETER] button
The [PARAMETER] button's LED will light.



If the display reads "RIGHT OUTPUT SELECTED" you have not yet moved back to BLOCK 1. Press the [< BLOCK] button to move the pointer in the display to Block 1.

The display will now show you the first of three pages:

```
LOW PASS: 1000Hz  GAIN: +0.0dB
```

These are the only two parameters on this page: Low Pass Frequency and Gain. The cursor appears beneath the Frequency setting (in the display above it is set to 1000Hz; your display may read something different).

- ② Turn the [VALUE/ENTER] knob to select a frequency between 200 and 10000Hz.
- ③ Press the [PAGE >] button to move the cursor to the Gain parameter.
- ④ Turn the [VALUE/ENTER] knob to set the Low Pass gain from -14 to +14 dB.
Set the Gain below 0dB to "cut" or above 0dB to "boost" the selected Frequency; a setting of 0dB has no effect.
- ⑤ Press the [PAGE >] button to advance to Parameter Page 2 of this EQ Block.
The display will look like this:

```
MID BAND: 1000Hz  +0.0dB  1.000CT
```

This page has three parameters: Mid Band Frequency, Gain and Q (or bandwidth).

- ⑥ Turn the [VALUE/ENTER] knob to select a frequency from 200 to 10000Hz.
- ⑦ Press the [PAGE >] button to move the cursor to the Gain parameter.
- ⑧ Turn the [VALUE/ENTER] knob to set the Mid Band gain from -14 to +14 dB.
Set the Gain below 0dB to "cut" or above 0dB to "boost" the selected Frequency; a setting of 0dB has no effect.
- ⑨ Press the [PAGE >] button to move the cursor to the Q parameter.
- ⑩ Turn the [VALUE/ENTER] knob to set the Mid Band EQ's bandwidth from .20 to 2.50 octave.

Set the Q to a small number to effect the specific frequency you selected, or to a larger number to affect a wider range of frequencies centered around the selected frequency.

Continue editing the remaining EQ parameters in a similar manner.

Mix

Once we have setup our EQ Block the way we want, we should then go to the Mix function to adjust the Block's output level. This, however, is only necessary if all we want to do is EQ our input signal. That would be fine, except we have 7 more Blocks we can use to stack effects almost any way we want. In the next section we will see how to route this EQ Block into other Blocks. Most of the time, EQ Blocks are used to tailor the input signal before going into another Block or set of Blocks. However, they can also be useful at the end of the effects chain just before the L/R OUT (especially when you use the parametric and graphic EQs.

However, since this is just a tutorial, let's look at just how we go about mixing the EQ'd signal with the original input signal.

- ① Press the [MIX] button
The [MIX] button's LED will light.



If the display reads "DIRECT LEVEL FROM INPUT" you have not yet moved back to BLOCK 1. Press the [< BLOCK] button to move the pointer in the display to Block 1.

The display will now show you the first of three pages:

```
LEVEL TO L/R: EQ=100%
```

- ② Turn the [VALUE/ENTER] knob to adjust how much of the EQ's output is heard at the L/R OUT.
- ③ Press the [PAGE >] button to advance to Mix Page 2.
The display will read:

```
DIRECT LEVEL FROM INPUT: 100%
```

- ④ Turn the [VALUE/ENTER] knob to adjust how much of the direct input signal is being routed to the L/R OUT. (For an EQ, the level would normally be 0%)
By adjusting this parameter, you can create an ideal balance between the original unaffected signal at the inputs, and the effected signal coming from the EQ Block.



If the Global Direct Signal Mute function is turned on, the Direct Level From Input parameter will appear to have no effect. However, any changes you make will be remembered if you store the edited Program. For more information on Global Direct Signal Muting, see Chapter 2.

Programming Multiple Blocks

When you start adding more Blocks, the same principles apply as described in the previous section. However, the routing options begin to increase, since, as you add more Blocks, the number of input sources increases. Let's take our simple 1 Block Program and add two more Blocks. We'll route the output of the EQ into a Mono Delay, then through a stereo reverb, such as Hall 1, before going to the main outputs. First, we'll add the new Blocks. Then, we'll reroute the signal so that they are chained together in series.

Defining New Blocks

Adding the two additional Blocks is done in the same way as described earlier, except this time we'll choose Delay and Reverb as the functions.

- ① Press [TYPE].
The [TYPE] button's LED will light.
- ② Use the [< BLOCK >] buttons to move the pointer in the display to Block 2.
The display will look like this:

```
BLOCK 2 FUNCTION: OFF
```

- ③ Turn the [VALUE/ENTER] knob until the display reads "DELAY", and press the [VALUE/ENTER] button three times.
The display advances to Type Page 2.

```
DELAY TYPE: MONO DELAY
```

Since this is the type of effect we want, let's move on and add the Reverb.

- ④ Press [BLOCK >] so that the pointer is above Block 3.
- ⑤ Turn the [VALUE/ENTER] knob until the display reads "REVERBERATION", and press the [VALUE/ENTER] button.
The display advances to Type Page 2.

```
REVERB TYPE: PLATE 1
```

- ⑥ Turn the [VALUE/ENTER] knob until the display reads "HALL 1", and press the [VALUE/ENTER] button.
The display will flash until the [VALUE/ENTER] button is pressed.

```
REVERB TYPE: HALL 1
```

Deleting Unnecessary Routings

Now that we've added our new Blocks, we want to reroute the signals so that the EQ output no longer directly feeds the L/R OUT, but instead goes into the Delay Block, and then into the Reverb Block. Then we'll route the Reverb Block to the L/R OUT so we can hear our effects at work. The first step, however, is to delete the unnecessary routings before adding the new ones.

- ① Press [ROUTING].
The [ROUTING] button's LED will light.
- ② Press the [BLOCK >] button until the pointer appears above R OUT.
- ③ Press [< PAGE] to advance to Routing Page 3.
The display will look like this:

```
DELETE ROUTE FROM: INPUT RIGHT
```

- ④ Turn the [VALUE/ENTER] knob until the display reads "EQ 1 MIX" and press the [VALUE/ENTER] button.
The display will flash until the [VALUE/ENTER] button is pressed. At the same time, the "patch cord" connecting the EQ out to the R OUT will disappear.

Patching In The New Blocks

Now its time to reroute the signal so the effects form a chain.

- ① Press [ROUTING].
The [ROUTING] button's LED will light.
- ② Press the [< BLOCK] button until the pointer appears above Block 2.
- ③ Turn the [VALUE/ENTER] knob until the display looks like this:

```
ADD ROUTE FROM: EQ 1 MIX
```

- ④ Press [VALUE/ENTER] to select the route.
The display will flash until the [VALUE/ENTER] button is pressed. At the same time, the "patch cord" connecting the EQ to the Delay will appear. Also, the display will automatically advance to Routing Page 2, where you can adjust the level of this signal going into the Delay in Block 2. This defaults to -6.0dB, which is the halfway point between maximum and minimum. This gives you enough overhead so that, if later you need more gain, you can raise this signal to a higher level.
- ⑤ Press [VALUE/ENTER] to set the input level. The display will automatically return to the "Add Route" page
- ⑥ Press the [BLOCK >] button until the pointer appears above Block 3.

- ⑦ Turn the [VALUE/ENTER] knob until the display looks like this:

```
ADD ROUTE FROM: DLY 2 MIX
```

- ⑧ Press [VALUE/ENTER] to select the route.
The display will flash until the [VALUE/ENTER] button is pressed. At the same time, the “patch cord” connecting the Delay to the Reverb will appear. Set the level on page 2 as before.
- ⑨ Press the [BLOCK >] button until the pointer appears above L OUT, and turn the [VALUE/ENTER] knob until the display looks like this:

```
ADD ROUTE FROM: REB 3 LEFT
```

- ⑩ Press [VALUE/ENTER] to select the route.
The display will flash until the [VALUE/ENTER] button is pressed. At the same time, the “patch cord” connecting the Reverb to the L OUT will appear.
- ⑪ Press [BLOCK >] and then press [VALUE/ENTER] to route the right output of the Reverb in Block 3 to the R OUT.
The display should look like this before pressing [VALUE/ENTER]:

```
ADD ROUTE FROM: REB 3 RIGHT
```

Adjusting Parameters

At this point, the tutorial ends, since there are so many directions you can go in. Each type of effect has its own set of parameters. Using the steps in the first section of this Chapter, you can get an idea of how to edit the other effect’s parameters, even though they each perform a different function. Refer to Chapter 5 for a list of controls, including a list of the parameters used in each of the available effects.

We highly recommend experimentation in this area. Because the Q20 is so flexible, you’ll be able to create effect combinations never before possible. *Example:* You can route a Block’s output to its own input to create interesting “feedback” effects. However, the level of this “patch cord” is very important to avoid unwanted clipping. This is why when such a “feedback” connection is made, the level is automatically set to 100% attenuation (-48dB) to avoid sudden, unexpected loud levels. Only through experimentation, and examination of the Preset Programs, can you start to create truly innovative effect Programs.

Moving, swapping and copying blocks

Block Move

A third page is included in Type mode which allows you to move a defined Block to another position. If you defined Block #1 as a Delay, and later decide to first have the input signal routed through an EQ, you can move the Delay Block to make room for it. First select the Block to be moved, press [PAGE >] to advance the cursor to the next field, and select the Block # you want to move it to. Then to execute the move, press the [VALUE/ENTER] button. The Block is moved and the routings repatched to recreate the same signal path. Now you can redefine Block #1 as an EQ. If you move a Block to a position already occupied by another Block, the two Blocks will swap positions, and their routings will automatically be swapped as well to maintain the identical signal path.

Since blocks can be routed in any order you like, Block Move is primarily for visual feedback. The input could be routed to Block 3 first, for example, then to Blocks 1 and 2 and to the outputs. If you prefer, you can rearrange the blocks so they are in the proper order on the screen.

To move a defined Block to another position:

- ① Press [TYPE].
The [TYPE] button's LED will light.
- ② Press [PAGE >] twice to advance to Type Page 3.
The display will look like this:

```
MOVE BLOCK: 1 INTO BLOCK 2
```

The right half of the display will flash.

- ③ Use the [VALUE/ENTER] knob to select which Block you want to move (1–8).
- ④ Press [PAGE >] to advance the cursor to the next field.

```
MOVE BLOCK: 1 INTO BLOCK 2
```

- ⑤ Turn the [VALUE/ENTER] knob to select where you want to move it to (1–8).
- ⑥ Press [VALUE/ENTER] to execute the move.
If the selected destination is already occupied by a defined Block, the Blocks will slide into the now-vacant positions.

Block Copy & Paste

It is also possible to duplicate a single effect block, including all of its parameter settings, into any other User Program. This feature is called Block Copy & Paste, and it is found in Type mode, Page 4. The concept is simple: first you select a Block with the [< BLOCK >] buttons, and copy it. Then select another Block location (even in another Program) and paste in the original Block.

To copy and paste a Block:

- ① Recall the Program which has the Block effect you wish to copy.
- ② Select the desired Block by using the [< BLOCK >] buttons to position the down-pointing arrow above it in the display.
- ③ With the Block selected, press the [TYPE] button to select Type mode.
- ④ Press the [< PAGE] button once to select Page 4 of Type Mode. This display should look like this:

```
COPY/PASTE BLOCK: COPY
```

- ⑤ Press the [VALUE/ENTER] button to copy the selected block. The display will momentarily read:

```
COPYING BLOCK...
```

- ⑥ *Optional:* Press [PROGRAM] and use the [VALUE] knob to select another Program.
- ⑦ Select the Block position you wish to paste the copied Block into by using the [< BLOCK >] buttons to move the down-pointing arrow in the display.
- ⑧ Press the [TYPE] button, followed by the [< PAGE] button to select Type mode Page 4.
- ⑨ Turn the [VALUE] knob to select the PASTE function. This display should look like this:

```
COPY/PASTE BLOCK: PASTE
```

- ⑩ Press the [VALUE/ENTER] button to paste the copied Block. The display will momentarily read:

```
PASTING BLOCK...
```

The Block will now appear in the selected location. If another Block already existed in the selected location, it will be replaced.

Changing Effect Types

If you already have defined a Block and assigned its routings, you can still change its Function and Effect Type. Usually, this doesn't disturb anything else. However, if the Block was defined as a mono effect and you change it to a stereo effect, the Q20 will make the necessary changes in routings, and vice-versa.

Here's an example: Let's say you have a Mono Delay Block that has its mono output (M) routed to the R OUT. Now you go into Type mode and change it to a Stereo Delay. As soon as you press the [VALUE/ENTER] button and make the change, the display momentarily reads:

```
CONVERTING MONO ROUTES TO STEREO
```

Now, the Block has three outputs: L (left), R (right), and M (mono). In this case, the Q20 automatically assigned the R output of the Delay to the R OUT. Since the M output of the Delay Block had originally gone to the R OUT, the Q20 assumed you wanted to continue having the Block go to this output. So, logically, it routed the Block's new R output to the R OUT.

Let's say we did the opposite; i.e., change a stereo effect into mono. The exact opposite would happen. Once we changed the stereo effect into a mono effect type, the display would momentarily read:

```
CONVERTING STEREO ROUTES TO MONO
```

In this case, if only one of the effects outputs had been routed to one of the Q20's OUTS, it would be rerouted to come from the new mono Block's M output. If both the Left and Right outputs of the stereo Block were connected to the L/R OUT, then the mono effect's M out would now be connected to both the L OUT and R OUT.

CHAPTER 5

DESCRIPTION OF CONTROLS

Front Panel

Input Level

Left and Right: These concentric knobs (one within the other) control the incoming level of our analog signal, and the relative balance between the two input channels. This “gain-staging” allows us to maintain a superior signal-to-noise ratio and eliminate any overloading of the Q20’s inputs. This feeds directly to the LED ladder.

Output Level

This controls how much signal we are returning to our mixing console, or whatever else it’s connected to. Matching levels throughout the recording/mixing chain will allow us to get the cleanest possible recordings .

LED Meter

This is a visual indicator of level. It is a four step LED (light emitting diode) ladder with steps at -32dB, -12dB, -3dB (green LEDs), and the red LED indicating CLIP. The dB markings refer to how much headroom is remaining before overload.

As with all meters, a certain amount of experimentation is necessary before you feel comfortable, as different types of signals with sharper attack times will affect the LEDs differently. The meters have several sources, so they can detect overloads caused by internal gain or feedback, as well as by the [INPUT LEVEL] controls. Internal clipping is shown when the red LEDs flash; if the red LEDs flash while the -3 LEDs do not light, the levels within the Q20’s program should be lowered.

Display

The Q20 is equipped with a custom LCD display, which provides (among other things) a complete view of the signal routing used by the current Program.

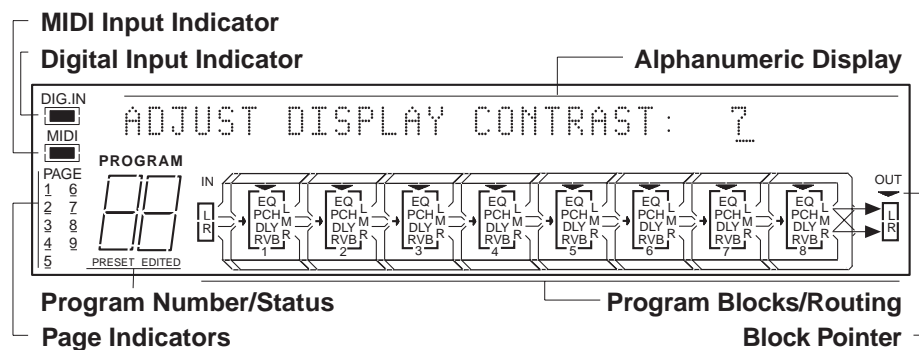

Note: This illustration shows all display flags and routes (“patch cords”) turned on at once. Actual displays show only some of these at any time.

DIG. IN. Illuminates if the INPUT AUDIO SOURCE is switched to OPTICAL DATA in the Global functions.

MIDI. Illuminates if MIDI signals are present at the MIDI IN.

Alphanumeric Display. This 32 character display indicates types of effects, parameters of effect, mode, etc. It also allows us to select and enter types and amounts of an effect. Includes a 14 character entry section for naming the Programs.

PAGE 1-9. Indicates the total number of pages available in the currently selected mode, with an underline to indicate the current page. Some functions have more pages than others. A REVERB effect may have seven pages of parameters, the MIDI button will have six pages, for example. Some pages have more than one parameter field. Use the [< PAGE >] buttons to advance the cursor through each parameter field in a page, and to access the other pages in a selected function.

PROGRAM (00-99). Indicates the PROGRAM number currently selected.

PRESET. Indicates if the PROGRAM selected is a PRESET and if any modifications have been made to the PRESET.

EDITED. This indicates that the currently selected Program has been edited (modified from its original version as it is stored in memory). You must Store a Program after editing it, if you want to make those changes permanent. Otherwise, if you select another Program before saving the edited one, your edits will be lost.

L/R IN. This represents the inputs of the Q20 which need to be routed to the OUT L/R before it can pass along its signal. Along the way the signal may be routed through a variety of effects. These inputs are fed directly by the [L] and [R] INPUT connectors on the rear of the unit.

Blocks 1-8. Eight selectable, discrete effects processors that can be used together or separately. Choices are Off, Equalization (EQ), Pitch (PCH), Delay (DLY) and Reverberation (RVB).

L/R OUT. These are the outputs of the Q20. They feed the [L] and [R] OUTPUT connectors on the rear of the unit.

Patch Cords. A fully programmable series of connections, representing patch cords, that connect the L/R IN to a variety of effects (Blocks), Block outputs to other Blocks, and then to the L/R OUT.

Value/Enter

The [VALUE/ENTER] knob is used to adjust values in the display. However, it is also a button. Depending on what you are editing, the [VALUE/ENTER] knob will work in either one of two modes:

Immediate. The desired value is selected by turning the [VALUE/ENTER] knob, and immediately takes effect. This is normally the case when selecting Programs (see next page) and for adjusting most of the numeric parameters.

Deferred. The desired value is selected by turning the [VALUE/ENTER] knob, but the new value will only take effect after the [VALUE/ENTER] button has been pressed. The newly selected value will flash in the display until it is selected in this manner. If you change the parameter back to its original setting, the value in the display will not flash. Also, if you go to another Page, or select another Function (by pressing any button), the parameter will be left unchanged. If you went back to look at the previous parameter, it will be set back to its original setting. This mode is used for parameters that cause architectural changes such as changing a Block's function, effect type, and routing signals.

For Power Users. The [VALUE/ENTER] button can also be used to step through Pages in the currently selected mode. Except when a value is flashing on and off in the display, the [VALUE/ENTER] button ordinarily doubles for the [PAGE >] button. If you change the value of a parameter that uses "deferred mode," you must press the [VALUE/ENTER] button to enter the new value (the display will stop flashing), and then you can press it again to move to the next Page (or to the next parameter, if more than one parameter appears in the display). This is a feature for power users who want to be able to move around the various pages quickly and make changes as fast as possible.



Unique Exception: When editing the Delay Time parameter of a Delay Block set to either Tap Tempo Mono Delay or Tap Tempo Ping Pong, the [VALUE/ENTER] button is used to "tap" in a tempo . See Chapter 6 for more information.

Program

This button is used, in conjunction with the [VALUE/ENTER] knob, to select the Program number in the display. When its LED is lit, turning the [VALUE/ENTER] knob selects a different Program, using one of two modes: Direct or Deferred. Direct mode immediately recalls the displayed Program as you turn the [VALUE/ENTER] knob. Deferred mode lets you scroll through the Programs in the display by turning the [VALUE/ENTER] knob, but you must press the [VALUE/ENTER] button to actually recall a Program. You can choose between either Direct or Deferred mode by going to Program Page 2, using the following steps:

To select either Direct or Deferred Program Selection Mode:

- ① Press the [PROGRAM] button.
The [PROGRAM] button's LED will light.
- ② Press [PAGE >] to advance to Program Page 2.
The display will look like this:

```
PROGRAM SELECTION MODE: DIRECT
```

- ③ Turn the [VALUE/ENTER] knob to select either Direct or Deferred mode.

You can also directly select Programs using the front panel buttons. By holding the [PROGRAM] button, you can press [PRESET] or [USER] (stenciled in gray) to select either the Preset, User 0 or User 1 bank (100 Programs in each). Also while holding the [PROGRAM] button and using the [1] though [0] buttons (stenciled in gray), you can directly recall any Program (from 00–99) in the current bank (Preset or User) you happen to be in.

Store

Once you have created a new Program you can press [STORE] to store it. The [STORE] button's LED will light. You can now dial in a Program number from the User bank, using the [VALUE/ENTER] knob, that you want to store it into (you cannot store a Program into the Preset bank, since this is stored in ROM). Press either the [STORE] button or the [VALUE/ENTER] button and your Program is stored. The display will momentarily read "PROGRAM STORED". The [STORE] button's LED will turn off and you will be returned to whatever mode you were in prior to storing. To cancel the operation without storing, press any other button before pressing [STORE] or [VALUE/ENTER].



Once a Program is stored, the previous Program in the selected location is replaced, and cannot be retrieved. Before storing, you may want to transmit the entire contents of the User bank into a SysEx storage device. See Chapter 6 for more info.

User Program Write Protect

This function has been added to prevent the accidental erasure of User Programs. Write Protect affects all Programs in the User bank.

To enable User Program Write Protect:

- ① Press [STORE].
The [STORE] button's LED will light.
- ② Press [PAGE >] to advance to Store Page 2.
The display will read:

```
USER PROGRAM WRITE PROTECT: OFF
```

- ③ Use the [VALUE] knob to turn the User Program Write Protect function ON or OFF.

If the User Program Write Protect is enabled and you attempt to store a Program, the display will temporarily read:

```
NOT STORED - WRITE PROTECT IS ON
```

This message indicates that you must first turn off the User Program Write Protect function in order to store a Program into the User banks.

Compare

Once a Program has been edited, the word "EDITED" will appear in the display below the Program number. If [COMPARE] is pressed, its LED will light and you will temporarily hear (and see) the original version of the Program. This allows you to compare the changes you've made with the original.

Bypass

Each time the [BYPASS] button is pressed, Bypass mode is toggled on and off. When Bypass mode is engaged, its LED will light. This bypasses the effects chain allowing you to make an instant comparison between the effected signal and the clean signal. Bypass mode can also be enabled using the [BYPASS] footswitch. For more information, see the Footswitch section in Chapter 6.



When Bypass is enabled, all Effect Blocks are momentarily disabled and will not have audio routed from them to the outputs. However, if the Program does not route the L/R Inputs directly to the L/R Outputs, you will not hear anything.

In order for Bypass mode to function correctly, make sure the L/R Inputs are routed to the L/R Outputs and that the Global Direct Signal Mute function is turned off (see below). If the inputs are not routed directly to the outputs, the [BYPASS] button acts more like a “mute” since nothing will be heard when it is enabled.

Block Bypass

It is possible to bypass individual effect Blocks within a Program, without bypassing all effects. This can be done by holding down the [BYPASS] button and pressing the same numbered button as the Block you wish to bypass. For example, pressing [1] (otherwise known as the [BLOCK >] button) while holding [BYPASS] will result in Block 1 being bypassed. Repeat this process to disable Block Bypass for each separate Block. When the [BYPASS] button is held the display will read:

```
PRESS # FOR BLOCK BYPASS ...
```

When a Block is bypassed, its Block outline will disappear and audio will pass through it unaffected. If you store a Program while one or more of its Blocks are bypassed, the Block(s) will still be bypassed when that Program is recalled.

< Block >

This rocker button allows you to position the Block pointer above Blocks 1 through 8 or above L OUT or R OUT. These buttons are used in conjunction with the [TYPE], [ROUTING], [PARAMETER] and [MIX] buttons to determine which Block you wish to edit.

When you are editing Block parameters, the Q20 remembers which page you were in last for each Block. This makes programming easier since, when you go from one Block to another (which may be of a different effect type with different parameters/ pages), you will be back in the same page you left when you return to the previous Block to do more editing.

< Page >

This rocker button allows you to scroll back and forth through the pages indicated under PAGE (maximum of 9) in the display. Sometimes a Page has more than one parameter in it; in this situation, the [< PAGE >] buttons will step through each parameter field separately before moving on to the next page.

Type

Use the [TYPE] button to define the type of effect in the selected Block. Once a Block has been chosen and the [TYPE] button is pressed, we can dial through with the [VALUE/ENTER] knob to choose the function of that Block from EQUALIZATION, PITCH, DELAY, REVERBERATION or OFF. Once the general function of a Block has been selected by pressing the [VALUE/ENTER] button, the display will automatically advance to the second page of the Type function where we can define the specific effect of the Block. *Example:* If it is a Reverberation Block, you can select Hall 1, Plate 1, Non Linear, etc., using the [VALUE/ENTER] knob.

Another page is included in Type mode which allows you to move a defined Block to another position. If you defined Block #1 as a Delay, and later decide to first have the input signal routed through an EQ, you can move the Delay Block to make room for it. First select the Block to be moved, press [PAGE >] to advance the cursor to the next field, and select the Block # you want to move it to. Then to execute the move, press the [VALUE/ENTER] button. The Block is moved and the routings repatched to recreate the same signal path. Now you can redefine Block #1 as an EQ. If you move a Block to a position already occupied by another Block, the two Blocks will swap positions, and their routings will automatically be swapped as well to maintain the identical signal path.

Selection	Parameter	Page #
Defined Blocks	Block Function	1
	Effect Type	2
	Move Block	3
	Copy/Paste Block	4
Undefined Blocks	Block Function	1
	Move Block	2
	Copy/Paste Block	3

Parameter

Once a type of effect has been chosen, pressing the [PARAMETER] button allows us to see and choose the available parameters for that specific effect. *Example:* This is where you define specific attributes of a Block; the boost or cut of an EQ, or the decay time of a Reverb. Some effects have many more parameters and these can be found by [PAGE]ing through while in Parameter mode.

Routing

In order for us to hear our signal through the Q20 it must be routed from input to output. Also in order for us to hear our effects, the signal must be routed through the Blocks that contain our chosen effects.

Pressing the [ROUTING] button selects Routing Page 1. This is where you can dial through, with the [VALUE/ENTER] knob, all the possible connections. Once you find the route you want, press [VALUE/ENTER] to select it. This automatically advances the display to Routing Page 2, where you can enter a level for that connection. Page 3 allows you to delete any unwanted patches.

Selection	Parameters	Page #
Defined Blocks, L OUT, R OUT	Add Route From:	1
	Level From:	2
	Delete Route From:	3
Undefined Blocks	None ("BLOCK IS OFF")	1

Mix

Allows us to create a mix of the input signal, the levels of effects sent to the outputs, and the Master effects level. If an unassigned Block is selected, or the L/R OUT, the Mix function will have only two pages. These let you control the Direct signal level being routed to the outputs, and adjust the master effects level of all Blocks routed to the outputs. Normally, these are adjusted as a percentage of the total level.

When a defined Block is selected, a new Page 1 is added, and the other two pages move down (Page 1 becomes page 2, Page 2 becomes Page 3). Page 1 will now let you adjust the selected Block's level going to the L/R OUT.

Selection	Parameters	Page #
Defined Blocks	Level to L/R	1
	Direct Level From Input	2
	Master Effects Level	3
L OUT, R OUT,	Direct Level From Input	1
Undefined Blocks	Master Effects Level	2

If the selected Block is not routed to the L/R OUT, the Level to L/R parameter value will be "NONE". If the inputs are not routed to the outputs in the current Program, the Direct Level will be "NONE". Likewise, if none of the defined Blocks are routed to the L/R OUT, the Master Effects Level will be "NONE".

Global

When the [GLOBAL] button is pressed, its LED will light. The [GLOBAL] button gives us access to the following settings which affect the entire instrument:

Page 1: Adjust Display Contrast: 1–10. This controls the contrast of the LCD display. The value range is 1–10, and the default is 5. Use the [VALUE/ENTER] knob to adjust the contrast to a comfortable setting.

```
ADJUST DISPLAY CONTRAST: 5
```

Page 2: Footswitch Range . This page has two values which determine the start and end point of the range of Programs that are selectable via the [ADVANCE] footswitch connector. Both values have a range of Preset 00—99, User0 00—99 and User1 00—99. For more information, see the Footswitch section in Chapter 6.

```
FOOTSWITCH: Preset00 TO User1-99
```

Page 3: VU Meter Peak Hold. When set to “ON”, the VU meters’ peak LED indicators will remain lit for about a second.

```
VU METER PEAK HOLD: OFF
```

Page 4: Input Audio Source. Normally, this is set to “ANALOG DATA” for using the analog input connectors on the rear panel. If using the Alesis Optical DIGITAL [IN] connector, however, this should be switched to “OPTICAL DATA”. When using the S/PDIF inputs, this parameter should be set to “S/PDIF DATA”. When the input is set for either ADAT or S/PDIF, the [DIG.IN] indicator will light. At the same time, the Sample Clock Source parameter (see below) is automatically switched to “OPTICAL” or “S/PDIF”.

```
INPUT AUDIO SOURCE: ANALOG DATA
```

Page 5: Sample Clock Source. Normally, when using the analog inputs, this parameter is set to Internal, so that the Q20 uses its own “INTERNAL” sample clock for processing effects in the digital domain. However, if you are recording digitally onto ADAT using the Q20’s optical connectors, and you are using either an Alesis BRC or AI-2 synchronizer, you must feed the master 48 kHz clock signal back to the Q20 so that it is in sync with the recording system. This is done by connecting a BNC cable from the clock source (BRC or AI-2) to the [48kHz IN] connector on the Q20, and then setting the Sample Clock Source parameter to “48kHz INPUT”. If the Input Audio Source parameter is set to “OPTICAL INPUT” or “S/PDIF INPUT”, this parameter will automatically be set and you will not be able to change its setting.

```
SAMPLE CLOCK SOURCE: INTERNAL
```

Page 6: Dig In/Out Channels. When using the Alesis Optical DIGITAL [IN] connector, (Input Audio Source must be set to “OPTICAL DATA”, see above), this page allows you to select which of the 8 channels on the optical buss will be routed to the L and R IN. Both inputs can be set to receive any channel on the buss, from 1 to 8. You can even route the same channel to both inputs. Since the Q20 has two outputs (left and right), you get to chose which of the 8 channels on the outgoing optical buss they should be sent on. Both outputs can be routed to any channel on the buss, from 1 to 8. However, you cannot assign both outputs to the same channel on the optical buss. For the outputs to be routed at all, the Digital Output Mode must be set to “NORMAL” (see below).

```
DIG CH IN: L=1,R=2  OUT: L=1,R=2
```

Note that the front panel meters only monitor inputs 1 and 2, and the analog outputs will work only if the output channels are set to 1 and 2.

Page 7: Digital Output Mode. This determines how the ADAT DIGITAL [OUT] connector will function. When set to “NORMAL”, the Q20’s L/R OUT is routed to the DIGITAL [OUT] connector. When set to “THRU”, whatever is received at the DIGITAL [IN] connector is passed on to the DIGITAL [OUT] connector without any processing occurring on the digital signal within the Q20. Use this mode when you are connected between to Alesis Optical devices (such as ADAT) between which you wish to bounce digital audio.

```
DIGITAL OUTPUT MODE: NORMAL
```

Page 8: Tap Tempo Footswitch. This lets you choose which footswitch jack (either [ADVANCE] or [BYPASS]) will be used to provide a tap tempo source for setting delay time, provided the selected Program uses one of the two available tap tempo delay types. This requires that you have defined an Effect Block as one of the two Tap Tempo delay types, and that the desired footswitch jack has been selected for controlling tap tempo.

Page 9: Global Direct Signal. The purpose of this feature is to satisfy the conditions of a recording studio environment. When connecting the Q20 to a mixing console’s aux sends and returns, it is generally desirable to remove the direct signal feed from the outputs of the Q20. Since most Q20 Programs route the L/R IN signal to the L/R OUT, you will need to remove this connection from the Program’s routing when connecting to a mixer’s aux sends and returns. However, this can be done globally for all Programs using this function. If it is set to “ON”, the inputs will be heard at the outputs, if the are routed this way in the current Program. By setting this function to “MUTE”, you can remove this connection for all Programs without having to delete the “patch cords” in each that route the inputs to the outputs.

```
GLOBAL DIRECT SIGNAL: ON
```

When set to “MUTE”, recalling a Program which has the L/R IN routed to the L/R OUT will not display those “patch cords” so as to avoid confusion. You can, however, still add or delete these connections, as well as adjust the Direct Signal Level in Mix mode, and these changes will be remembered when you store the edited Program. However, as long as the Global Direct Signal function is set to “MUTE”, you will not hear the effect of any of these edit.

Name

Selecting this button allows us to name, edit a name or rename a Program. Names can contain up to 14 Characters and are selected by turning the [VALUE/ENTER] knob. The cursor is positioned by using the [< PAGE >] buttons. Or, you can press the [VALUE/ENTER] button to advance the cursor to the right; this helps make naming your Programs a fast operation. Once chosen, the name can be stored along with the Program using the [STORE] button (see above). Here is a chart of available characters:

	!	"	#	\$	%	&	'	()	*	+	,	-	.	/	0	1	2	3
4	5	6	7	8	9	:	;	<	=	>	?	@	A	B	C	D	E	F	G
H	I	J	K	L	M	N	O	P	Q	R	S	T	U	V	W	X	Y	Z	[
¥]	^	_	`	a	b	c	d	e	f	g	h	i	j	k	l	m	n	o
p	q	r	s	t	u	v	w	x	y	z	{		}	→	←				

MIDI

When the [MIDI] button is pressed, its LED will light and the display will move to MIDI Page 1. There are a total of 6 pages in all, containing various MIDI related parameters. For more information about MIDI parameters, see Chapter 6.

Page 1: MIDI Channel. This sets the basic MIDI channel of the Q20. This is the channel used to receive MIDI program change messages for recalling Programs, and for receiving controller, pitch-bend, note or velocity information for controlling various effect parameters in realtime from an external MIDI source (such as a controller or sequencer). The MIDI channel can be set between 1—16, or set to Omni (this lets the Q20 respond to all 16 channels).

MIDI CHANNEL: 1

Page 2: MIDI Program Change. This determine whether or not the Q20 will respond to incoming MIDI program change and bank select messages. This can be set to either "ON" (recognize), "OFF" (ignore) or "TABLE" (use Program Table). When turned on, the Q20 will recognize program change messages received on the same MIDI channel it is set to receive on, and respond by calling up the equivalent Program number from the User bank. When set to "TABLE", the Program that is recalled is based on how the Program Table is set up (see below).

MIDI PROGRAM CHANGE: OFF

Page 3: Program Table. The Program Table allows you to intercept incoming program change messages and have them recall specific Programs (in either the Preset bank or the User bank) which may not be the same number value as the program change message received. There are 128 different possible MIDI program change messages (000 through 127). However, the Q20 has 300 Programs to choose from. Therefore, the Program Table allows us to choose which of the 300 Programs will be recalled when certain program change numbers are received. The first value indicates the MIDI program change you wish to remap (000—127). The second value in the display indicates the Program you wish to be recalled (Preset, User 0 or User 1, 00—99). You can remap each of the 128 program change numbers, if so desired.

```
PROGRAM TABLE: 000 = User0-00
```

Page 4: MIDI Thru. This determines whether information received at the [MIDI IN] connector should be routed to the [MIDI OUT] connector. When “ON”, the [MIDI OUT] connector “echoes” any MIDI messages it receives on the [MIDI IN] connector.

```
MIDI THRU: OFF
```

Page 5: System Exclusive Receive. This determines whether the Q20 will respond to any received MIDI SysEx messages. SysEx (System Exclusive) is used to control the various parameters of the Q20. When “ON”, the Q20 will respond to SysEx messages. When off, SysEx messages will be ignored.

```
SYSTEM EXCLUSIVE RECEIVE: OFF
```

Page 6: Send MIDI Program. This page lets you dump out a single Program or the current Program being used/edited), or the entire User bank via MIDI. The data is sent as SysEx information. This can be sent to a MIDI storage device, or to another Q20. Select either “ALL” or a Program number from 00—99 (User bank only) or EDIT (the currently selected Program which is in the edit buffer). When ALL is selected, simply pressing the [VALUE/ENTER] button starts the MIDI dump. The display will read “MIDI PROGRAM DUMP IN PROGRESS...” indicating that all 100 User Programs are being sent out the [MIDI OUT] connector. If EDIT or 00—99 is selected, a second value appears which lets you select which Program location to send the selected Program to. This is useful when you are connected to another Q20, and wish to transfer a Program from one to the other but do not want to store it in the same location.

```
SEND MIDI PROGRAM: 00 TO 00
```

Modulation

The Q20 allows you to set up to 8 modulation routings which can control almost any parameter within a Program in realtime. This is especially useful for live applications, where the performer can actually interact or automate the changes in one or more effects.

When the [MODULATION] button is pressed, its LED will light and the display will advance to Modulation Page 1. There are a total of 9 pages in Modulation mode. Pages 1 through 3 let you select a Modulator (or modulation patch) which provides the means for routing a particular MIDI (such as pitch bend) or one of the Internal Generators to modulate one of the Block parameters used in the current Program. In each of the first three page, the first field lets you select a Modulator from 1 to 8.

```
MOD 1 TO:DLY 1-DELAY TIME
```

The second field of page 1 lets you choose a Block in the current Program. The Block Type will be shown as an abbreviation (EQ, PCH, DLY, REV) along with its location number (i.e. DLY-1 means Block 1 which is a Delay type). The third field is where you choose a particular parameter to be modulated. The list of available parameters depends on the selected Block's type.

```
MOD 1 SOURCE: PITCH BEND
```

The second field of page 2 lets you select a Source to modulate the chosen Target.

The second field of page 3 lets you adjust the amount of modulation (Amplitude), either positively or negatively, from -99 to +99.

```
MOD 1 AMPLITUDE: +0
```

Pages 4 through 9 allow you to define the two Internal Generators. These can be used as an alternative to external MIDI control, allowing the audio signal at the Q20's inputs to control the effect parameters in realtime.

```
GEN 1 TYPE: INPUT ENVELOPE
```

Page 4 lets you choose what type each of the two Input Generators should be. There are two types to choose from: Input Envelope and Peak Follower. The first field lets you select which Input Generator you wish to edit. The remaining pages are used to setup the parameters for the Input Generators.

For more information about the Input Generators, see Chapter 6.

Power

The [POWER] switch turns the AC power to the unit ON or OFF.

Rear Panel

Power

This is a standard IEC-spec power jack for the internal universal power supply. This supply works with almost any power source worldwide, from 90-265VAC, 50-60Hz. The Q20 comes with a line cord suitable for the destination to which the keyboard is shipped.

The AC cord supplied is designed to connect to an outlet that includes three pins, with the third, round pin connected to ground. The ground connection is an important safety feature designed to keep the chassis of electronic devices such as the Q20 at ground potential. Unfortunately, the presence of a third pin does not always indicate that it is properly grounded. Use an AC line tester to determine this. If the outlet is not grounded, consult with a licenced electrician.

MIDI In

This is a 5 pin DIN standard MIDI plug which connects to any MIDI compatible equipment such as a MIDI sequencer that will send program changes and controller information to the unit.

MIDI Thru/Out

This is a 5 pin DIN standard MIDI plug which connects to any MIDI compatible equipment such as a keyboard or another effects device. Provided for sending system exclusive commands for storing programs. It also relays all messages received on the MIDI IN if MIDI THRU is enabled.

Bypass - Bypass Footswitch

This is a 1/4" phone jack which connects to a footswitch, either normally-open or normally-closed. When the footswitch is pressed the signal will bypass the effects chain allowing an instant comparison between the dry and wet signal. The red LED on the [BYPASS] button on the front panel will illuminate.

Advance - Program Advance Footswitch

This is a 1/4" phone jack which connects to a footswitch, either normally-open or normally-closed. When the footswitch is pressed the currently selected program number is advanced by one. When 99 is reached it will roll-over to 00. However, you can create a range of Programs to be used in conjunction with this footswitch in the Global menu, page 2. See Footswitch Range, earlier in this Chapter.

48kHz in - Sample Clock Input

This is a BNC connector which connects to an external master clock from an external device to synchronize digital output. It needs to be used when recording the digital outputs of the Q20 to an ADAT system that uses either an Alesis BRC or AI-2 synchronizer. Once connected, it is necessary to set the Q20's Sample Clock Source to "48kHz INPUT". See Chapter 7 for more information.

Digital In - ADAT Digital Audio In

This is an EIAJ fiber optic jack which connects to the ADAT optical interface for receiving two of any eight digital audio channels. See Chapter 7 for more information.

Digital Out - ADAT Digital Audio Out

This is an EIAJ fiber optic jack which connects to the ADAT optical interface for transmitting on two of any eight digital audio channels. See Chapter 7 for more information.

S/PDIF In - S/PDIF Digital Audio In

This is a phono jack which connects to the S/PDIF digital out of a device (digital mixer, DAT machine, etc.) for receiving digital audio. See Chapter 7 for more information.

S/PDIF Out - S/PDIF Digital Audio Out

This is a phono jack which connects to the S/PDIF digital in of a device (digital mixer, DAT machine, etc.) for transmitting digital audio. See Chapter 7 for more information.

Left/Right In - Analog Audio In

These are combination 1/4" TRS phone and XLR jacks which connect to analog source devices such as the effects sends of mixing consoles. These are true stereo balanced inputs and are represented by the IN Block on the front panel LCD display. They may be used with nominal input levels from -20dBV (guitar level) to +4dBu.

Left/Right Out - XLR Analog Audio Out

These are balanced XLR jacks which connect to analog devices such as the effects returns on a mixing console. These are true stereo balanced outputs and are represented by the OUT Block on the front panel LCD display. These outputs are servo balanced, meaning that if one leg of the signal is grounded, the other leg will automatically increase 6dB to maintain the nominal output level.

Left/Right Out - 1/4" Analog Audio Out

These are 1/4" TRS phone jacks which duplicate the XLR outputs for connection to devices which use 1/4" jacks. These outputs are servo balanced, meaning that if one leg of the signal is grounded, the other leg will automatically increase 6dB to maintain the nominal output level. Only one set of output jacks should be used at a time for optimal performance.

Effect Parameters

The following charts are designed to act as a “road map” to assist you in locating parameters and their value ranges. All of the following parameters may be found by first selecting the appropriate effect type, pressing the [PARAMETER] button, and using the [< PAGE >] buttons to navigate through the various pages. The number of pages available depends on the effect type you’ve selected. The total number of pages will be shown in the left side of the display, and the currently selected page number will have an underline beneath it.

Equalization

EQ Type	Parameters	Page#
Lowpass Filter	Lowpass Fc (frequency): 20Hz-10kHz	1
Bandpass Filter	Bandpass Fc: 200Hz-10kHz, BW (bandwidth): 0.20-2.50 Octaves	1
Highpass Filter	Highpass Fc: 100Hz-20kHz	1
Lowpass Shelf	Lowpass: 20Hz-10kHz, Gain: \pm 14dB	1
Highpass Shelf	Highpass: 100Hz-20kHz, Gain: \pm 14dB	1
1 Band Low Parametric	Bandpass: 20Hz-2000Hz, Gain: \pm 14dB, BW: 0.20-2.00 Octaves	1
1 Band High Parametric	Bandpass: 200Hz-10kHz, Gain: \pm 14dB BW: 0.20-2.50 Octaves	1
2 Band Sweep Shelf	Lowpass: 20Hz-10kHz, Gain: \pm 14dB	1
	Highpass: 100Hz-20kHz, Gain: \pm 14dB	2
3 Band Parametric	Lowpass: 20Hz-10kHz, Gain: \pm 14dB	1
	Mid Band: 200Hz-10kHz, Gain: \pm 14dB, BW: 0.20-2.50 Octaves	2
	Highpass: 100Hz-20kHz, Gain: \pm 14dB	3
4 Band Parametric	Lowpass: 20Hz-10kHz, Gain: \pm 14dB	1
	Low Mid: 20Hz-2kHz, Gain: \pm 14dB, BW: 0.20-2.00 Octaves	2
	High Mid: 1500Hz-10kHz, Gain: \pm 14dB, BW: 0.20-2.50 Octaves	3
	Highpass: 100Hz-20kHz, Gain: \pm 14dB	4
5 Band Graphic	63Hz/250Hz/1kHz/4kHz/16kHz: \pm 14dB <i>Note: All bands have a two octave bandwidth.</i>	1
Resonator	Resonator Tuning: A0-A5 (4 Octaves), Decay 0-99	1
Mono Tremolo	Speed: 0-99, Depth: 0-99, Shape: Soft/Hard	1
Stereo Tremolo	Speed: 0-99, Depth: 0-99, Shape: Soft/Hard	1
Stereo Simulator	Stereo Spread: 0-99 Degrees	1
Soft Overdrive	Effect Mix: Overdrive/Clean	1
	Brightness: 0-99, Drive Level: 1.0-11.0	2
Hard Overdrive	Effect Mix: Overdrive/Clean	1
	Brightness: 0-99, Drive Level: 1.0-11.0	2
Triggered Panning	Speed: 0-99, Doppler: 0-99, Distance: 0-99	1
	Retrigger Point: Left/ Right/ Alternating L/R	2
	Sweeping Mode: Continuous/One Cycle Only	3
	Trigger Source: Audio Left, Audio Right, Audio L&R, Advance Footsw., Bypass Footsw.	4
Phase Inverter	Output Phase: Inverted/Non-Inverted	1

Pitch

Pitch Type	Parameters	Page#
Mono Chorus	Speed: 0-99, Depth: 0-99, Feedback: 0-99	1
	Chorus PreDelay: 0-100mS	2
	Chorus Shape: Sine/Square	3
Stereo Chorus	Speed: 0-99, Depth: 0-99, Feedback: 0-99	1
	PreDelay Chorus 1: 0-100mS, 2: 0-100mS	2
	Chorus Shape: Sine/Square	3
Quad Chorus	Speed: 0-99, Depth: 0-99, Feedback: 0-99	1
	PreDelay Chorus 1: 0-100mS, 2: 0-100mS	2
	PreDelay Chorus 3: 0-100mS, 4: 0-100mS	3
Mono Flanging	Speed: 0-99, Depth: 0-99, Feedback: -99-0-+99	1
	Flanging Shape: Sine/Triangle	2
Stereo Flanging	Speed: 0-99, Depth: 0-99, Feedback: -99-0-+99	1
	Flanging Shape: Sine/Triangle	2
Phasor	Phasor Speed: 0-99, Depth: 0-99	1
Mono Lezlie	Lezlie Motor: On/Off, Speed: Slow/Fast	1
	High Rotor Level: -12dB to +6dB	2
Stereo Lezlie	Lezlie Motor: On/Off, Speed: Slow/Fast	1
	High Rotor Level: -12dB to +6dB	2
	Stereo Separation: 0-99	3
Pitch Shifter	Fine: 0-99, Coarse: ± 12 (semi tone)	1
Pitch Detune	Detune Amount: ± 99	1
Ring Modulator	Spectrum Shift: ± 100	1
Mono Trigger Flange	Speed: 0-99, Depth: 0-99, Feedback: -99-0-+99	1
	Retrigger Point: 0-255,	2
	Sweeping Mode: Continuous/One Cycle Only	3
	Trigger Source: Audio Left, Audio Right, Audio L&R, Advance Footsw., Bypass Footsw.	4
Stereo Trig. Flange	Speed: 0-99, Depth: 0-99, Feedback: -99-0-+99	1
	Retrigger Point: 0-255,	2
	Sweeping Mode: Continuous/One Cycle Only	3
	Trigger Source: Audio Left, Audio Right, Audio L&R, Advance Footsw., Bypass Footsw.	4

Delay

Delay Type	Parameters	Page #
Mono Delay	Delay Time: 0.1-5000mS, Beat Count: 1/2, 1/4., 1/4, 1/4T, 1/8., 1/8, 1/8T, 1/16, 1/32 (. = dotted, T = triplet)	1
	Feedback: 0-99	2
Stereo Delay	Left Delay: 0.1-5000mS, Beat Count: 1/2, 1/4., 1/4, 1/4T, 1/8., 1/8, 1/8T, 1/16, 1/32	1
	Left Feedback: 0-99	2
	Right Delay: 0.1-5000mS, Beat Count: 1/2, 1/4., 1/4, 1/4T, 1/8., 1/8, 1/8T, 1/16, 1/32	3
	Right Feedback: 0-99	4
Ping Pong Delay	Delay Time: 0.1-5000mS, Beat Count: 1/2, 1/4., 1/4, 1/4T, 1/8., 1/8, 1/8T, 1/16, 1/32	1
	Feedback: 0-99	2
Multi Tap Delay	Tap 1, Del: 0.1-5000mS, Vol: Off/-48-0dB, L<->R: <99-<50>-99, FB: 0-99	1
	Tap 2, Del: 0.1-5000mS, Vol: Off/-48-0dB, L<->R: <99-<50>-99, FB: 0-99	2
	Tap 3, Del: 0.1-5000mS, Vol: Off/-48-0dB, L<->R: <99-<50>-99, FB: 0-99	3
	Tap 4, Del: 0.1-5000mS, Vol: Off/-48-0dB, L<->R: <99-<50>-99, FB: 0-99	4
	Tap 5, Del: 0.1-5000mS, Vol: Off/-48-0dB, L<->R: <99-<50>-99, FB: 0-99	5
	Master Feedback 0-99	6
Tap Tempo Mono Delay	Delay Time: 0.1-5000mS, Beat Count: 1/2, 1/4., 1/4, 1/4T, 1/8., 1/8, 1/8T, 1/16, 1/32	1
	Feedback: 0-99	2
Tap Tempo Ping Pong	Delay Time: 0.1-5000mS, Beat Count: 1/2, 1/4., 1/4, 1/4T, 1/8., 1/8, 1/8T, 1/16, 1/32	1
	Feedback: 0-99	2
Sampling	Sample Play: Looping/1 Shot/Gated, Rec: 1 Shot/Gated	1
	Maximum Sample Length: 250.0-5000.0 mS	2
	Start: 0.0-4950.0 mS, End: 50.0-5000.0 mS	3
	Play Trigger: Enter/ Audio Left/ Audio Right/ Audio L&R/ MIDI Note#/ Advance Footswitch/Bypass Footswitch	4
	Rec Trigger: Enter/ Audio Left/ Audio Right/ Audio L&R/ MIDI Note#/ Advance Footswitch/Bypass Footswitch	5
	MIDI Note #: 000-127/ All, Rec Output: On/Mute	6

Reverberation

Reverb Type	Parameters	Page #
Mono Room	Decay: 0-99, Damping Hi: 0-99, Lo: 0-99	1
	Reverb Density: 0-99, Diffusion: 0-99	2
	High Frequency Roll Off: 200Hz-20,000Hz	3
	Predelay: 1-250mS, Mix: <99-<50>-99>	4
	Gate Trig: Off/Left/Right/L&R, Hold: 10-500 mS	5
	Gate Release Time: 0-500mS	6
	Gate Level: 0-99	7
Room 1	Decay: 0-99, Damping Hi: 0-99, Lo: 0-99	1
	Reverb Density: 0-99, Diffusion: 0-99	2
	High Frequency Roll Off: 200Hz-20,000Hz	3
	Predelay: 1-250mS, Mix: <99-<50>-99>	4
	Gate Trig: Off/Left/Right/L&R, Hold: 10-500 mS	5
	Gate Release Time: 0-500mS	6
	Gate Level: 0-99	7
Hall 1	Decay: 0-99, Damping Hi: 0-99, Lo: 0-99	1
	Reverb Density: 0-99, Diffusion: 0-99	2
	High Frequency Roll Off: 200Hz-20,000Hz	3
	Predelay: 1-250mS, Mix: <99-<50>-99>	4
	Gate Trig: Off/Left/Right/L&R, Hold: 10-500 mS	5
	Gate Release Time: 0-500mS	6
	Gate Level: 0-99	7
Plate 1	Decay: 0-99, Damping Hi: 0-99, Lo: 0-99	1
	Reverb Density: 0-99, Diffusion: 0-99	2
	High Frequency Roll Off: 200Hz-20,000Hz	3
	Predelay: 1-250mS, Mix: <99-<50>-99>	4
	Gate Trig: Off/Left/Right/L&R, Hold: 10-500 mS	5
	Gate Release Time: 0-500mS	6
	Gate Level: 0-99	7
Chamber 1	Decay: 0-99, Damping Hi: 0-99, Lo: 0-99	1
	Reverb Density: 0-99, Diffusion: 0-99	2
	High Frequency Roll Off: 200Hz-20,000Hz	3
	Predelay: 1-250mS, Mix: <99-<50>-99>	4
	Gate Trig: Off/Left/Right/L&R, Hold: 10-500 mS	5
	Gate Release Time: 0-500mS	6
	Gate Level: 0-99	7
Room 2	Decay: 0-99, Damping Hi: 0-99, Lo: 0-99	1
	Reverb Density: 0-99, Diffusion: 0-99	2
	High Frequency Roll Off: 200Hz-20,000Hz	3
	Predelay: 1-250mS, Mix: <99-<50>-99>	4
	Reflection Level: 0-99, Spread: 0-99	5
	Reverberation Attack: 0-99	6
	Gate Trig: Off/Left/Right/L&R, Hold: 10-500 mS	7
	Gate Release Time: 0-500mS	8
	Gate Level: 0-99	9

Reverb Type	Parameters	Page #
Hall 2	Decay: 0-99, Damping Hi: 0-99, Lo: 0-99	1
	Reverb Density: 0-99, Diffusion: 0-99	2
	High Frequency Roll Off: 200Hz-20,000Hz	3
	Predelay: 1-250mS, Mix: <99-<50>-99>	4
	Reflection Level: 0-99, Spread: 0-99	5
	Reverberation Swirl: 0-99	6
	Gate Trig: Off/Left/Right/L&R, Hold: 10-500 mS	7
	Gate Release Time: 0-500S	8
	Gate Level: 0-99	9
Plate 2	Decay: 0-99, Damping Hi: 0-99, Lo: 0-99	1
	Reverb Density: 0-99, Diffusion: 0-99	2
	High Frequency Roll Off: 200Hz-20,000Hz	3
	Predelay: 1-250mS, Mix: <99-<50>-99>	4
	Reflection Level: 0-99, Spread: 0-99	5
	Reverberation Attack: 0-99	6
	Gate Trig: Off/Left/Right/L&R, Hold: 10-500 mS	7
	Gate Release Time: 0-500mS	8
	Gate Level: 0-99	9
Chamber 2	Decay: 0-99, Damping Hi: 0-99, Lo: 0-99	1
	Reverb Density: 0-99, Diffusion: 0-99	2
	High Frequency Roll Off: 200Hz-20,000Hz	3
	Predelay: 1-250mS, Mix: <99-<50>-99>	4
	Reflection Level: 0-99, Spread: 0-99	5
	Reverberation Attack: 0-99	6
	Gate Trig: Off/Left/Right/L&R, Hold: 10-500 mS	7
	Gate Release Time: 0-500mS	8
	Gate Level: 0-99	9
Large Plate	Decay: 0-99, Damping Hi: 0-99, Lo: 0-99	1
	Reverb Density: 0-99, Diffusion: 0-99	2
	High Frequency Roll Off: 200Hz-20,000Hz	3
	Predelay: 1-250mS, Mix: <99-<50>-99>	4
	Reflection Level: 0-99, Spread: 0-99	5
	Reverberation Swirl: 0-99	6
	Gate Trig: Off/Left/Right/L&R, Hold: 10-500 mS	7
	Gate Release Time: 0-500mS	8
	Gate Level: 0-99	9
Large Room	Decay: 0-99, Damping Hi: 0-99, Lo: 0-99	1
	Reverb Density: 0-99, Diffusion: 0-99	2
	High Frequency Roll Off: 200Hz-20,000Hz	3
	Predelay: 1-250mS, Mix: <99-<50>-99>	4
	Reflection Level: 0-99, Spread: 0-99	5
	Reverberation Swirl: 0-99	6
	Gate Trig: Off/Left/Right/L&R, Hold: 10-500 mS	7
	Gate Release Time: 0-500mS	8
	Gate Level: 0-99	9

Reverb Type	Parameters	Page #
Spring	Decay: 0-99, Damping Hi: 0-99, Lo: 0-99	1
	Reverb Density: 0-99, Diffusion: 0-99	2
	High Frequency Roll Off: 200Hz-20,000Hz	4
	Predelay: 1-250mS, Mix: <99-<50>-99>	5
	Gate Trig: Off/Left/Right/L&R, Hold: 10-500 mS	7
	Gate Release Time: 0-500mS	8
	Gate Level: 0-99	9
Nonlinear	Gate Hold Time: 0-99	1
	Reverb Density: 0-99, Diffusion: 0-99	
	Input High Frequency Roll Off: 200Hz-20,000Hz	2
	Predelay: 1-250mS, Mix: <99-<50>-99>	3
Reverse	Reverse Time: 0-99	1
	Reverb Density: 0-99, Diffusion: 0-99	
	Input High Frequency Roll Off: 200Hz-20,000Hz	2
	Predelay: 1-250mS, Mix: <99-<50>-99>	3

CHAPTER 6

ADVANCED APPLICATIONS

MIDI Functions

The Q20 provides many MIDI functions, including being able to respond to program changes, sending and receiving Program information via SysEx dumps, and realtime control over various effect parameters via MIDI controllers. For more information about basic MIDI connections, see Chapter 1.

Global MIDI Channel

The Global MIDI Channel is used to receive program change messages, as well as other MIDI events for use with MIDI modulation.

To set the Q20's MIDI channel:

- ① Press [MIDI].
The [MIDI] LED will light and the display will read:

MIDI CHANNEL: 1

- ② Turn the [VALUE/ENTER] knob to set the Global MIDI Channel to either 1 through 16, or OMNI (all 16 channels simultaneously).

Receiving Program Changes

In order to recall programs or control parameters on the Q20 from a MIDI control device (keyboard, drum pad, guitar or bass controller, sequencer, etc.):

- ① Connect the control device's MIDI OUT to the Q20's [MIDI IN].
This provides a one-way connection, since this is all we need to control the Q20 via MIDI (we don't require the Q20 to send MIDI information back to the other device).
- ② Press [MIDI].
The [MIDI] LED will light.
- ③ Press [PAGE >] to access MIDI Page 2.
The display will read:

MIDI PROGRAM CHANGE: OFF

- ④ Turn the [VALUE/ENTER] knob to turn MIDI Program Changes "ON".
Incoming MIDI program change messages received on the same channel the Q20 is set to will recall the same numbered Program in the currently selected Bank (Preset, User 0 or User 1) in the Q20.

Selecting Banks via MIDI

You can use MIDI Controller 0 messages to select one of the three Program Banks (Preset, User 0 or User 1).

Controller 0 messages (like all controllers) can have a value between 0 and 127; however, a value of 0 will select the Preset Bank, a value of 1 will select the User 0 Bank, and values from 2 to 127 will select the User 1 Bank. If a Controller 0 message is received followed by a Program change message, the QuadraVerb 2 will respond by selecting the appropriate Program number in the appropriate Bank.

Note: Controller 0 messages will change Banks only if the Program Change Table is not being used (MIDI Mode, Page 2).

Program Change Table

Alternatively, you can use a Program Change Table in the Q20 which re-maps incoming program change messages so that they recall Q20 Programs of a different number. This is especially useful since MIDI program changes only allow for 128 different programs to be recalled (unless it is preceded by a Bank select message, see above). Using the Program Table, you can have any incoming MIDI program change message recall any of the 300 Programs in the Q20. This is done by assigning the MIDI Program Change parameter (described above) to "TABLE"; then select a MIDI program change number and assign it a Program. *Example:* If you programmed the Table so that program message 101 was mapped to Preset 33, and message 102 was mapped to User 0-39, then sending a MIDI program change message of 101 to the Q20 would recall Program Preset 33, and sending a message of 102 would recall Program User 0-39.

To incorporate and modify the Program Change Table:

- ① Press [MIDI].
The [MIDI] LED will light.
- ② Press [PAGE >] to access MIDI Page 2.
The display will read:

```
MIDI PROGRAM CHANGE: ON
```

- ③ Turn the [VALUE/ENTER] knob to the right to set the MIDI Program Change parameter to "TABLE".

```
MIDI PROGRAM CHANGE: TABLE
```

- ④ Press [PAGE >] to access MIDI Page 3.
You can edit the program change table, which can substitute alternate Programs (Preset 00-99, User0 00-99 and User1 00-99) for each of the 128 MIDI program change messages.

```
PROGRAM TABLE: 000 = User0-00
```

- ⑤ Turn the [VALUE/ENTER] knob to select a program change number from 000–127 to be re-mapped.
- ⑥ Press [PAGE >] to advance the cursor to the second field in the display.

```
PROGRAM TABLE: 000 = User0-00
```

- ⑦ Use the [VALUE/ENTER] knob to select a Q20 Program for the selected MIDI program change message to be re-mapped to (Preset 00–99 or User 0-00–1-99).

SysEx Storage

To send and receive program information via SysEx dumps using a computer, or some other SysEx storage device (such as the Alesis NanoTracker), or another Q20:

- ① Connect the other device's MIDI OUT to the Q20's [MIDI IN].
- ② Connect the Q20's [MIDI OUT] to the other device's MIDI IN.
This provides two-way communication between the devices.
- ③ Press [MIDI].
The [MIDI] LED will light.
- ④ Press [< PAGE] to select MIDI Page 6.
The display will read:

```
SEND MIDI PROGRAM: 0-00 TO 0-00
```

- ⑤ Use the [VALUE/ENTER] knob to select a User Program from 0-00–1-99, or the current Program being used (EDIT), or ALL User Programs.
To send all User Programs, turn the [VALUE/ENTER] knob all the way to the right to select "ALL".

Optionally, when sending a single Program to another Q20, you can choose to send it to a different location. When you select a Program to be sent, the second field (which represents the destination location) is linked and moves along with it. To select a different location number to send this Program to:

- ⑥ Press [PAGE >] and use the [VALUE/ENTER] knob to select a destination location (0-00–1-99 or EDIT).
If you chose to send "ALL" User Programs, the second field will disappear.
- ⑦ Set the receiving MIDI device to receive or record the MIDI information about to be sent from the Q20.
- ⑧ Press the [VALUE/ENTER] button to transmit.
If sending "ALL" User Programs, during the dump the display will read:

```
MIDI PROGRAM DUMP IN PROGRESS...
```

If sending a single Program, the display will not change when the [VALUE/ENTER] button is pressed, since this effectively takes no time at all.

- ⑨ When you send a SysEx dump back to the Q20, it will automatically go into receive mode (you do not have to do anything special). When this occurs, the display will momentarily read:

RECEIVING MIDI DATA...

If you don't want the Q20 to receive SysEx dumps, go to MIDI Page 5, and set System Exclusive Receive to OFF.

MIDI Thru

In order to pass on MIDI information from a control device thru the Q20 to another MIDI device:

- ① Connect the control device's MIDI OUT to the Q20's [MIDI IN].
- ② Connect the Q20's [MIDI OUT] to the MIDI IN of the other device you wish to control.
- ③ Press [MIDI].
The [MIDI] LED will light.
- ④ Press [PAGE >] four times to advance to MIDI Page 4.
The display will read:

MIDI THRU: OFF

- ⑤ Turn the [VALUE/ENTER] knob to the right to turn MIDI Thru "ON".

MIDI THRU: ON

Realtime Modulation Functions

You can use various MIDI messages (such as note number, velocity, aftertouch, or pitch-bend, etc.) to control parameters in the Q20, such as delay time, room size, etc. This is accomplished by way of the Q20's MIDI Modulation Matrix. Modulation parameters are stored in the Program, and therefore can be setup differently for each of the Programs in memory.

Use the [MODULATION] button to program which MIDI messages control which parameters in each Program, and by how much. This is done by following three steps:

- ① Select a Modulator (or modulation patch), of which there are 8 per Program;
- ② Choose the Target; i.e. what is to be modulated;
- ③ Choose the Source; i.e. what is doing the modulating; and,
- ④ Set the Amplitude, or amount, of modulation.

Keep in mind that a target may be modulated by more than one source. Likewise, a single source can modulate as many as 8 different targets. It is this kind of flexibility that matrix modulation affords.



Modulation sources must be received on the same MIDI channel the Q20 is set to in order for the Modulators to function properly.

Selecting the Modulator

Once you press the [MODULATION] button, you can turn the [VALUE/ENTER] knob to select one of the eight Modulators. Think of each Modulator as a modulation patch which routes a Source to a Target using a particular amplitude.

- ① Press [MODULATION].
The [MODULATION] button's LED will light, and the display will read:

```
MOD 1 TO:DLY 1-TAP 1 DELAY TIME
```

The cursor appears beneath the Modulator number. This is Modulation Page 1, which allows you to choose a Target (see below).

- ② Turn the [VALUE/ENTER] knob to select a Modulator (1–8).

At any time you can move between the 8 Modulators by first moving the cursor back to the far left of the display (using the [< PAGE >] buttons), and then turning the [VALUE/ENTER] knob to select a different Modulator.

Choosing a Target

Once you have selected a Modulator, you must then select the Target to be modulated. The Target is broken down into two parts: first, you choose one of the active Blocks in the current Program, then you choose a parameter within the Block.

- With [MODULATION] selected (its LED should be lit), press [PAGE >].
The cursor will advance to the second field in the display:

```
MOD 1 TO:DLY 1-TAP 1 DELAY TIME
```

The cursor appears beneath the Modulator Target Block.

- Turn the [VALUE/ENTER] knob to select a Block.
The display will look different depending on each Block's defined type. In the display example above, the first Block is a Delay (DLY). The number (1) tells us this is Block #1. If you turn the [VALUE/ENTER] knob, you will see other options defining the Block's type and number (example: PCH 2, EQ 3, OUT L, MIX, etc.).
- Press [PAGE >] to advance the cursor to the next field in the display.

```
MOD 1 TO:DLY 1-TAP 1 DELAY TIME
```

The cursor appears beneath the Modulator Target Parameter.

- Turn the [VALUE/ENTER] knob to select a Parameter to be modulated in the selected Block.
The parameters available will of course depend on the selected Block's type.

Here is a list of possible Target Parameters, listed with each effect type:

Type	Effect	Target
EQ	Lowpass Filter	Frequency
	Bandpass Filter	Bandpass Frequency, Bandpass Width
	Highpass Filter	Frequency
	Lowpass Shelf	Frequency, Gain
	Highpass Shelf	Frequency, Gain
	1 Band Low/High Parametric	Bandpass Gain Bandpass Width
	2 Band Sweep Shelf	Lowpass Frequency, Lowpass Gain Highpass Frequency, Highpass Gain
	3 Band Parametric EQ	Lowpass Frequency, Low pass Gain Bandpass Frequency, Bandpass Gain Bandpass Width Highpass Frequency, Highpass Gain

Type	Effect	Target
	4 Band Parametric EQ	Lowpass Frequency, Lowpass Gain Low BP Frequency, Low BP Gain Low BP Bandwidth High BP Frequency, High BP Gain High BP Bandwidth Highpass Frequency, Highpass Gain
	5 Band Graphic EQ	63 Hz Band Gain, 250 Hz Band Gain 1KHz Band Gain, 4KHz Band Gain 16KHz Band Gain
	Resonator	Tuning, Decay
	Mono/Stereo Tremolo	Speed, Depth, Shape
	Stereo Simulator	Stereo Spread
	Soft Overdrive	Effect Mix, Brightness
	Hard Overdrive	Effect Mix, Brightness
	Triggered Panning	Trigger, Speed, Doppler, Distance
	Phase Inverter	Output Phase
Pitch	Mono Chorus	Speed, Depth, Feedback
	Stereo Chorus	Speed, Depth, Feedback
	Quad Chorus	Speed, Depth, Feedback
	Mono Flanging	Speed, Depth, Feedback
	Stereo Flanging	Speed, Depth, Feedback
	Phasor	Speed, Depth
	Mono Lezlie	Speed, Depth, Motor On/Off Speed Slow/Fast, High Rotor Level
	Stereo Lezlie	Speed, Depth, Motor On/Off Speed Slow/Fast, High Rotor Level Stereo Separation
	Pitch Shifter	Pitch Fine, Pitch Coarse
	Pitch Detune	Pitch Detune
	Ring Modulator	Spectrum Shift
	Mono Trigger Flange	Trigger, Speed, Depth, Feedback
	Stereo Trig. Flange	Trigger, Speed, Depth, Feedback
	Delay	Mono Delay
Stereo Delay		Left Feedback, Left Delay Time
Ping Pong Delay		Delay Time, Feedback
Multi Tap Delay		Tap 1-5 Delay Time, Tap 1-5 Level Tap 1-5 Panning, Tap 1-5 Feedback Master Feedback
Tap Tempo Mono Delay Tap Tempo Ping Pong		Delay Time, Feedback
Sampling		Play Trig., Rec. Trig.

Type	Effect	Target
Reverberation	Mono Room Room 1 Hall 1 Plate 1 Chamber 1 Spring	Input Hi Rolloff Predelay Time, Predelay Mix Decay, Density, Diffusion Damping Low Damping High Gate Trigger On/Off, Gate Hold Time Gate Release Time, Gate Level
	Room 2 Hall 2 Plate 2 Chamber 2	Input Hi Rolloff Predelay Time, Predelay Mix Reflection Level, Reflection Spread Decay, Density, Diffusion Damping Low Damping High Reverberation Attack Gate Trigger On/Off, Gate Hold Time Gate Release Time, Gate Level
	Large Plate Large Room	Predelay Time, Predelay Mix Reflection Level, Reflection Spread Decay, Density, Diffusion Damping Low Damping High Reverberation Swirl Gate Trigger On/Off, Gate Hold Time Gate Release Time, Gate Level
	Nonlinear Reverse	Input Hi Rolloff Predelay Time, Predelay Mix Reverb Time (or Gate Time), Diffusion, Density

Choosing a Source

Once you have chosen a Modulator and a Target, it is time to select a Source. This is done in Modulation Page 2. If you have been following along so far, let's continue where we left off from the last set of steps:

- ① After selecting the Target Block and Parameter, press [PAGE >] to advance to Modulation Page 2.

The display will look like this:

```
MOD 1 SOURCE:  PITCH BEND
```

The cursor appears beneath the Modulator, indicating that you can now turn the [VALUE/ENTER] knob to select any of the 8 Modulators.

- ② Press the [PAGE >] button again to advance the cursor to the next field.
- ③ Use the [VALUE/ENTER] knob to select a Modulation Source.
Choose from any of the following Modulation Sources:

Pitch Bend	Aftertouch	Note Number	Note Velocity
Controllers 000–123	Local Generator 1	Local Generator 2	

Setting the Amplitude

Once a Modulator's Target and Source have been defined, it is then time to set the Amplitude. This is the amount of modulation control the Source will have over the Target. This number can be set to 00 (for no effect) all the way to +99 (for maximum effect) or down to -99 (for maximum negative effect; i.e., inverted control). If you have been following along so far, let's continue where we left off from the last set of steps:

- ① After selecting the Target and Source, press [PAGE >] to advance to Modulation Page 3.

The display will look like this:

```
MOD 1 AMPLITUDE:  +0
```

The cursor appears beneath the Modulator, indicating that you can now turn the [VALUE/ENTER] knob to select any of the 8 Modulators.

- ② Press the [PAGE >] button again to advance the cursor to the next field.
- ③ Use the [VALUE/ENTER] knob to set the Modulator's amplitude from -99 to +99.

Local Generators

The Q20 is equipped with two Local Generators which can be used as Modulation Sources. Each Local Generator can be set to either one of five types: Input Envelope, Peak Follower, Ramp, LFO or Footswitch. The first three allow different ways of having the audio signal at the Q20's inputs modulate the parameters of a Program, and the second two use internal sources. The Input Envelope, Peak Follower and Ramp Local Generators may be triggered by either the Left Input or Right Input, or both Left and Right Inputs. They may also be triggered by the Digital Input, if Optical or S/PDIF Data is selected as the Input Audio Source (on Global Page 4).

Input Envelope. This uses an envelope, similar to the type found in most synthesizers, which is triggered once the audio signal at the Q20's input(s) exceeds the Attack Threshold you have chosen (-32 to 0dB). Once this happens, the envelope opens up at a rate determined by the Attack Time (which can be set from 0.00–10.00 seconds). Once the input level has dipped down below the Release Threshold (-50 to 0dB), the envelope closes at a rate determined by the Release Time (0.00–10.00 seconds).

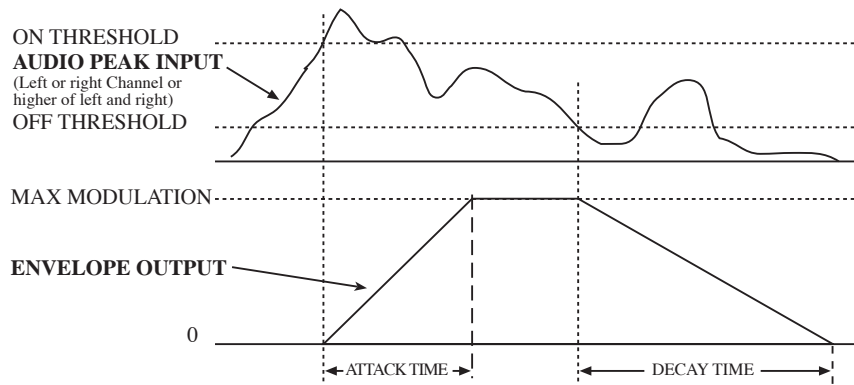

Peak Follower. The peak follower will follow the audio input to its loudest point and, as the input level drops, the peak follower drops at a constant rate determined by the Decay time (0.20–10.00 seconds). Once the input level exceeds the Peak Follower's level, the Peak Follower is raised to accommodate the higher level, and then (as the input signal again falls) proceeds to fall again using the same Decay time. Since the input levels may be too low at times for the Peak Follower to have ample effect, its Gain may be set to multiply the input's level from x1 to x99.

Peak Follower 1 and 2 have identical features and work as shown below:

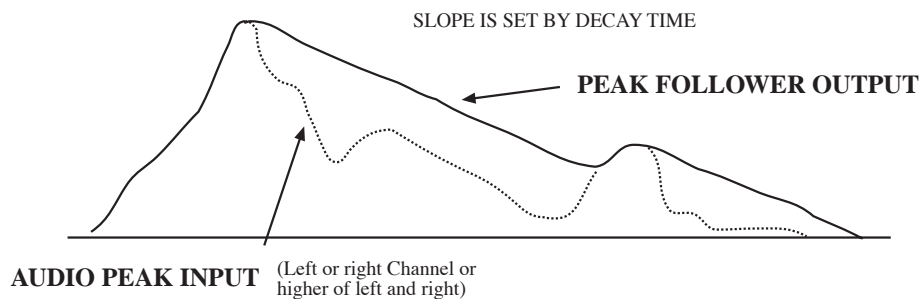

Ramp. The Ramp Local Generator is similar to the Envelope Generator, except that it doesn't have a release stage. It lets you modulate a parameter's value by having it slowly move from a minimum to a maximum setting, or vice-versa depending on whether the modulation amplitude is set to a positive or negative amount. The Ramp is useful for having an effect "fade-in" by modulating its output level. Try it out on a chorus or flanger's output "patch-cord" level to slowly have the effect become more and more dramatic.

The Ramp's Trigger Source can be either the Left or Right input, or both inputs. The Ramp is triggered when the audio at the input(s) exceeds the Attack Threshold you have chosen (-40 to 0 dB). Once triggered, the Ramp will increase or decrease the modulation destination at a rate set by the Rise Time (0.00 to 10.00 seconds). It will then stay set at full indefinitely. When it senses that the audio at the input(s) has fallen below the Attack Threshold setting, the Ramp is ready to be re-triggered. However, it will remain at full until it is re-triggered (when the audio at the input(s) exceeds the Attack Threshold), at which point the Ramp will instantly drop down and climb back up again.

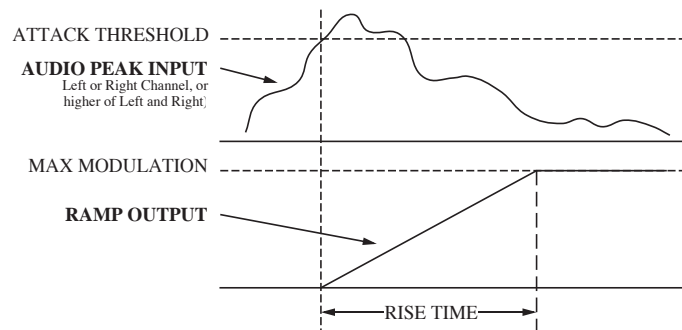

Modulation Page 4 allows you to select the type of each Input Generator. The remaining pages in Modulation Mode will appear differently in the display depending on which type of Input Generators you have selected. This may be confusing at times, since both generators could be set to Input Envelope type, or you could have Input Generator 1 set to an Input Envelope type while Input Generator 2 is set to a Peak Follower type. Once you are in Modulation Pages 4 through 7, you can select which of the two Input Generators you want to edit (much the same way you would select a Modulator in Modulation Pages 1 through 3).

Low Frequency Oscillator. The LFO Local Generator lets you modulate a parameter's value in a cyclical fashion. The LFO has a single parameter, Cycle Time, which can be set between .14 and 35.14 seconds. Because the LFO produces a "back and forth" motion, its effect is identical whether the Modulation Amplitude parameter is set to a positive or negative amount.

Footswitch. This local generator allows you to use the Bypass or Advance Footswitches as modulation sources. This is useful when you want to switch effects on and off, rotary speed fast and slow, or other on/off modulation destinations. Note that assigning the Advance or Bypass footswitches as local generators overrides their default functions (i.e. assigning the Bypass footswitch as a modulation source won't bypass the effect you're modulating).

Editing the Local Generators

To select the Input Generators' types and edit their parameters:

- ① Press [MODULATION].
The [MODULATION] button's LED will light.
- ② Press [PAGE >] seven times (or until Modulation Page 4 is underlined).
The display should look like this:

```
GEN 1 TYPE: ENVELOPE
```

The cursor appears beneath the Generator, indicating that you may now turn the [VALUE/ENTER] knob and select either Input Generator 1 or 2, depending on which you want to define. In the display example above, Input Generator 1 is defined to be an Input Envelope.

- ③ Press the [PAGE >] button to advance the cursor to the next field.
- ④ Turn the [VALUE/ENTER] knob to select either Input Envelope or Peak Follower to be the selected Input Generator's type.
- ⑤ Press the [PAGE >] button to advance to Modulation Page 5.

Each Local Generator's pages differ from page 5. Each Local Generator type's parameters are explained in the chart below:

Generator Type	Page	Display	Description
Envelope	5	Env Trigger Source: Left/Right/L&R	Input which the Envelope looks at for Modulation cues
	6	Env Attack Threshold: -32-0dB	Level which triggers the Envelope to begin Modulating
	7	Env Release Threshold: -48-0dB	Level below which the Envelope will stop Modulating and start to decay
	8	Env Attack: 0.00-10.00, Env Release: 0.00-10.00 Seconds	Time which the Envelope takes to ramp up to its peak value after the Attack Threshold has been passed, and the time it takes to ramp down to zero after the release threshold has been passed.
	9	Env Hold Time: 0.00-10.00 Seconds	The amount of time that the Envelope will hold at peak value before the release segment after the release threshold has been passed.
Peak Follower	5	Peak Follower Source: Left/Right/L&R	Input which the Peak Follower looks at for Modulation cues
	6	Peak Follower Gain: x1-x99	Amount of gain for the input before the Peak Follower looks at its signal (for low level signals)
	7	Peak Folw. Decay: 0.20-10.00 Seconds	After the Generator is triggered, this is the rate of the decay
Ramp	5	Ramp Trigger Source: Left/Right/L&R	Input which the Ramp looks at for Modulation cues
	6	Ramp Atk. Threshold: -40-0dB	This is the level which triggers the Ramp to begin Modulating
	7	Ramp Rise Time: 0.00-10.0 Seconds	This is the rate which the Ramp will rise to its peak value

Generator Type	Page	Display	Description
Low Freq. Oscillator	5	LFO Cycle Time: 0.14-35.14 Seconds	This is the time it takes for the LFO to make one complete cycle
Footswitch	5	Footswitch Source: Advance/Bypass	This is the footswitch that is monitored for Modulation cues. This setting overrides the default function of the footswitch (i.e. The effect won't bypass if the Bypass Footswitch is assigned as a modulator)
	6	Action Type: Momentary/Latched	This specifies the footswitch's function: either active only when stepped on or as an on/off control
	7	Attack Time: 0.00-10.00 Seconds	This is the time the modulator takes to ramp up to the peak value
	8	Decay Time: 0.00-10.00 Seconds	This is the time the modulator takes to ramp down to zero modulation

Footswitch Controls

Two footswitch jacks, [ADVANCE] and [BYPASS], are provided on the back panel of the Q20.

Program Advance

The [ADVANCE] jack allows the Q20's Programs to be advanced remotely from a footswitch. The Program numbers included can be selected by setting the Footswitch Range, found on Global Page 2. The range can be as small or large as you like, including any the Preset or User banks or both. *Example:* If the Footswitch Range is from Preset 89 to User 0-14, the Programs will continuously cycle from Preset 89 to User 0-14 whenever the Advance footswitch is triggered.

To set the Footswitch Range:

- ① Press [GLOBAL].
The [GLOBAL] button's LED will light.
- ② Press [PAGE >] to advance to Global Page 2.
The display will look like this:

```
FOOTSWITCH: 00 Pset TO 00 Pset
```

- ③ Turn the [VALUE/ENTER] knob to select the Program number to be the beginning point of the Footswitch Range (Preset 00–99 or User 0-00–1-99).
- ④ Press [PAGE >] to advance the cursor to the next field, and use the [VALUE/ENTER] knob to select the Program number that is to be the end point of the Footswitch Range.

When the last Program of the Footswitch Range is reached and the Advance footswitch is pressed again, the first Program in the Footswitch Range will once again be selected.

Bypassing Effects

The [BYPASS] jack allows you to bypass the effects of the Q20 via a footswitch. This is the same as pressing the [BYPASS] button on the front panel. Each time either the [BYPASS] button is pressed, or the footswitch connected to the [BYPASS] jack is pressed, Bypass mode is toggled on and off again. When Bypass mode is turned on, the [BYPASS] button's LED will be lit.



When Bypass is enabled, all Effect Blocks are momentarily disabled and will not have audio routed from them to the outputs. However, if the Program does not route the L/R Inputs directly to the L/R Outputs or the Global Direct Signal is Muted, you will not hear anything.

In order for Bypass mode to function correctly, make sure the L/R Inputs are routed to the L/R Outputs, and the Global Direct Signal Mute function is turned off. If the inputs are not routed directly to the outputs, the [BYPASS] button acts more like a “mute” since nothing will be heard when it is enabled.

Block Bypass via MIDI

It is possible to engage Block Bypass via MIDI controller messages which the Q20 receives at its MIDI IN connector. The following controllers can be used to bypass the following Blocks and Block types:

Controller #	Block(s) Bypassed
12	All EQs
13	All Choruses
14	All Flangers
15	All Phasors
16	All Pitch Shifters / Pitch Detunes / Ring Modulators
17	All Delays
18	All Reverbs
19	All Tremolos / Lezlies
71	Block #1
72	Block #2
73	Block #3
74	Block #4
75	Block #5
76	Block #6
77	Block #7
78	Block #8

Note: If one of these controllers is selected as a Modulation Source (Modulation Mode, Page 1) in a Program, that controller's respective bypass function will be temporarily disabled while that Program is selected.

Controlling Delay Time via Tap Tempo

When using either of the two Delay types which allow for "tap tempo" adjustments of delay time, either of the two footswitch jacks may be assigned to provide tap tempo control. This is an alternative way of setting the delay time of a "tap tempo" type delay rather than tapping the [VALUE/ENTER] knob. This can be a great utility for live applications, where the delay time can be adjusted to match your playing tempo simply by tapping your footswitch to the beat of the music.

To select either the [BYPASS] or [ADVANCE] footswitch to control tap tempo:

- ① Press [GLOBAL].
The [GLOBAL] button's LED will light.
- ② Press [PAGE <] twice to move to Global Page 8.
The display will read:

TAP TEMPO FOOTSWITCH: NONE

- ③ Turn the [VALUE/ENTER] knob to select either the ADVANCE or BYPASS footswitch jack, depending on which one you wish to use to control tap tempo.

When either BYPASS or ADVANCE is selected, that footswitch will not perform its normal function until the Tap Tempo Footswitch parameter is set to the other footswitch jack or to "NONE".

MIDI Clock Control of Tap Tempo Delay

If you are using a Program that uses either Tap Tempo Delay effects (Tap Tempo Mono Delay and/or Tap Tempo Ping Pong), you can control the delay time of the effect(s) via MIDI clock. This makes it possible to synchronize the delay time to the precise tempo of an external MIDI sequencer or drum machine.

To synchronize delay time to MIDI clock:

- ① Connect the sequencer or drum machine's MIDI OUT to the Q20's [MIDI IN].
This provides a one-way connection, since this is all we need to control the Q20's delay time via MIDI clock (we don't require the Q20 to send MIDI information back to the sequencer or drum machine).
- ② Select a Program that uses either the Tap Tempo Mono Delay effect or the Tap Tempo Ping Pong effect, or both.
- ③ Set your sequencer or drum machine to output MIDI clock.
Usually, MIDI clock will be output from your sequencer or drum machine only when it is in play; when not playing, no MIDI clock information is sent.
- ④ Play some audio through the Q20 to hear the effect.

Note: If the MIDI clock's tempo changes, the Q20 will chase it. If the MIDI clock signal is discontinued, the delay time will remain set to the last tempo which the MIDI clock had been.

```
DELAY: 500.0mS [120.0BPM] 1/4
```

The delay's Beat Count parameter (found to the right of the Delay Time parameter) is used to determine what note value the effect should synchronize to. *Example:* If you set the Beat value to "1/4", then you can synchronize to the quarter-note beats of the incoming MIDI clock. If instead you set the Beat value to "1/8T", you can synchronize to eighth-note triplets relative to the incoming MIDI clock signal. You can also set the Beat value to a dotted-note variation, such as "1/8.", which lets you synchronize to the dotted-eighth-note beats relative to the incoming MIDI clock signal.

CHAPTER 7

DIGITAL CONNECTIONS

Overview

In addition to the analog inputs and outputs, the Q20 accepts and transmits audio on two digital protocols: ADAT Optical and S/PDIF. If your source and/or destination accept it, “going digital” is often the best way to connect the Q20. By using digital connectors, you avoid the slight noise and distortion caused by converting from digital to analog and back again. However, digital connectivity has its own pitfalls as we’ll see in this chapter.

The S/PDIF inputs and outputs conform to the consumer standard digital protocol, commonly found on DAT machines, CD Players and digital mixers. S/PDIF is a two channel protocol, so you don’t need to worry about setting the input and output channels like on the ADAT Optical inputs and outputs.

The Alesis Optical digital interface provides the means to communicate with other ADAT Group digital audio devices, such as Alesis ADAT Multitrack Recorders. The Alesis optical interface uses a proprietary 8 channel buss, from which the Q20 can provide processing for 2 channels. This means you can come into the Q20’s digital input from one or two tracks of an ADAT, and go out of the Q20’s digital out to one or two ADAT tracks.

Alternatively, you may wish to use the Q20’s analog inputs to process an instrument and record digitally direct to the ADAT or S/PDIF digital outs. This is possible because while the Q20’s inputs are set to either analog or digital, all of the analog and digital outputs are always active. Note that, on the ADAT outputs, you must determine which 2 channels (of the digital buss’ 8 channels) to assign the Q20’s digital outputs to.

Going digital is the preferred method of recording if you use the Q20 with an ADAT. Since the DSP effects are created in the digital realm, why not let them remain there while being transferred to a tape medium?

This chapter is designed to illustrate the precise ways of connecting the Q20 to various digital audio peripherals, and how to manipulate the Q20’s digital routings. It is divided into two parts. The first half of this chapter details the connections to various digital audio sources and destinations. The second half talks about the routing possibilities that are available on the Q20 for processing digital audio sources and transmitting to digital audio recorders.

Digital Clock Synchronization

Before talking about digital clocks, it's important to understand the "one clock theory". This simply states that when you synchronize multiple machines (in this case digital audio recorders, processors, mixers, etc.) there must be one master clock which they all sync to. When there is more than one master clock, these two clocks will eventually drift apart and you will hear clicks and pops in your digital signal.

Digital signals are self-clocking; they carry a word clock along with them. Usually the receiving unit automatically adjusts its sample clock to follow the rate of the incoming digital signal. When the receiving unit must synchronize to another clock--for example, an ADAT synchronized to SMPTE time code--a conflict may occur between the clocks that will result in audible "clicks" in the signal. For this reason, in more complex setups, the Q20 features a 48 kHz IN jack. This is to synchronize the sample clock of the Q20's analog-to-digital converter to the BRC or M20. If you're using the Q20 only to process signals that come via the optical input from the ADATs, this connection is not necessary because the optical clock coming in is already indirectly synchronized by the BRC. The 48 kHz connection IS necessary if the Q20 is the originator (master clock) of the optical for the rest of the system, from its analog inputs, while the rest of the system is seeing the BRC as the master.

A complete diagram of every single possible setup with every possible input would be needlessly complex. Just remember that there can only be one master clock. If the BRC is the master, the Q20 must be synchronized to its clock via the optical or the 48 kHz in. If you have a single ADAT with no BRC, the Q20 becomes the master clock source whenever the ADAT is set to DIGITAL IN and the Q20's Input Audio Source is set to ANALOG.



Note: If you experience problems (clicks, etc.) with an ADAT system set to digital input, it may be that the ADAT's clock source is set to internal, even though its Digital In is pressed. (This will only happen if you've set it this way for making tape copies) See your ADAT manual for more information.

Note that the front panel level controls have no effect on a digital signal. The [INPUT LEVEL] controls will affect an analog input being converted to digital, and the [OUTPUT LEVEL] control affects the analog outputs only. If you need to change the levels in all-digital mode, you must do so by editing the program using page 2 of the Routing function.

When the input is set to Digital, the meters will show only the level of the signals on Channels 1 and 2 of the ADAT Optical interface, regardless of which channels are selected by the Q20. However, internal clipping within a program will still be shown by the Clip LEDs.

Connections

To a Single ADAT

Connection between the Q20 and one or more ADATs is a simple task of creating a digital audio network that loops all the devices together. When using a single ADAT, simply connect two fiber optic cables between the devices to provide two-way communication.

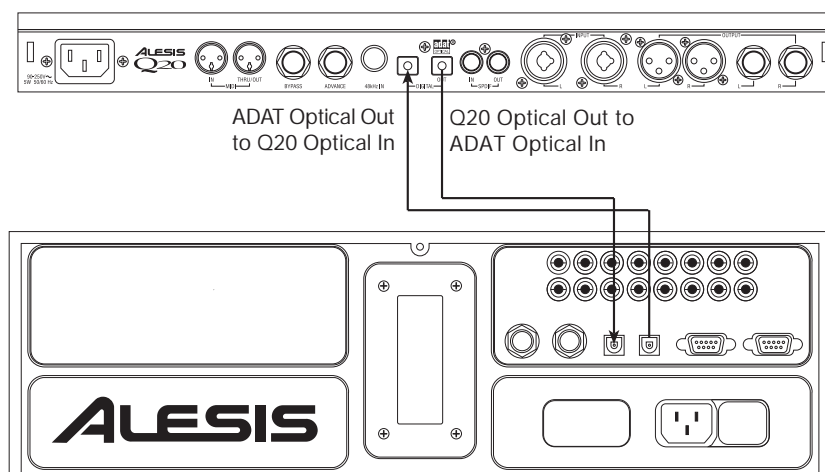

To connect the Q20 to a single ADAT:

- ① Connect an EIAJ fiber optic cable (such as Alesis OC, OA, or O1) from the [DIGITAL OUT] of the Q20 to the DIGITAL IN of the ADAT.
To test the cable and Q20 digital output, plug one cable end into the Q20. The other end should emit a soft red light (it is not dangerous to look directly at this light).
- ② Connect another fiber optic cable from the Q20's [DIGITAL IN] to the DIGITAL OUT of the ADAT .



Note that the ADAT Optical inputs and outputs are 16 bit. This means that a 20 bit signal from an ADAT Type II recorder (M20, ADAT-XT20, ADAT-PCR, etc.) will be truncated down to 16 bits automatically, even if the Q20 is in thru mode. (The S/PDIF I/O is 20 bit.)

To Two or More ADATs

If using two or more ADATs, they must be connected together so that they are in sync with each other. This is accomplished by connecting each ADAT's SYNC OUT connector to the SYNC IN connector of the next ADAT in the chain, as described in the ADAT Reference Manual.

The fiber optic cables that make up the digital buss need to be connected in the same order as the Sync cables. The Q20 is inserted in the fiber optic loop from the output of the second ADAT to the input of the master ADAT. The Q20 lets you turn its digital output into a "throughput" of the digital input. This allows you to move audio through the Q20, even when you don't want to use it to process anything, without having to repatch your fiber optic cables. More information about digital audio routing can be found in the next section.

To connect the Q20 to two ADATs:

- ① Connect an EIAJ fiber optic cable (available from your dealer) from the [DIGITAL OUT] of the Q20 to the [DIGITAL IN] of the first ADAT.
- ② Connect another fiber optic cable from the first ADAT's [DIGITAL OUT] to the second ADAT's [DIGITAL IN].
- ③ Connect another fiber optic cable from the second ADAT's [DIGITAL OUT] to the Q20's [DIGITAL IN].
- ④ Connect a dual male, 9 pin D cable from the first ADAT's [SYNC OUT] to the second ADAT's [SYNC IN].

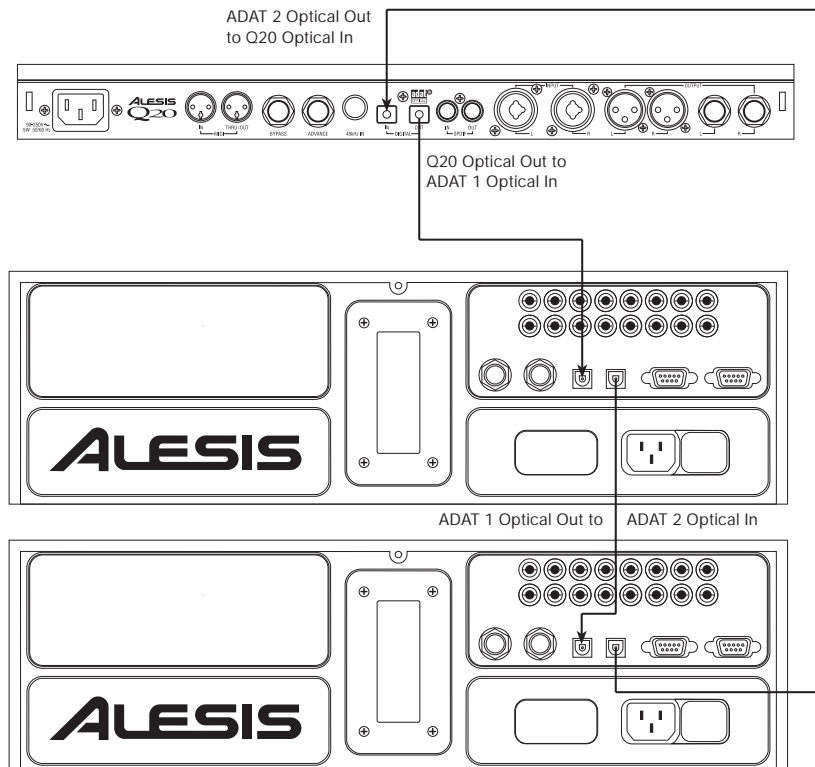

To Two or More ADATs With a BRC or AI-2

If your ADAT system has an Alesis BRC Master Remote Controller, the fiber optic cables that make up the digital buss need to be connected in the same order as the Sync cables. If your ADAT system uses the BRC or the Alesis AI-2 Synchronizer, the Q20's digital clock must be synchronized to the clock coming from the BRC or AI-2. Connect a BNC-to-BNC cable (such as the Alesis BN cable) between the BRC's 48 kHz CLOCK OUT and the Q20's 48 kHz CLOCK IN.



If only using one ADAT without the BRC or AI-2, it is not necessary to connect the 48 kHz Clock.

In Global mode ([GLOBAL] button's LED lit), page 5 lets you select the Sample Clock Source. This can either be Internal or Sample Clock. When set to Internal, the Q20 uses its own internal sample clock as a reference for its DSP. However, if you are recording the Q20's digital output to ADAT using the BRC Master Remote Controller, the Q20 must receive a 48 kHz clock signal from the BRC in order to maintain perfect sync with the ADAT system. This requires that you connect a BNC-to-BNC cable between the BRC's 48 kHz Clock Out to the Q20's 48 kHz Clock In. When you are ready to record onto ADAT from the Q20, be sure to set the Q20's Sample Clock Source function to Sample Clock.

To select the Sample Clock Source:

- ① Press [GLOBAL].
The [GLOBAL] button's LED will light.
- ② Press [PAGE >] 5 times, so that Page 5 is underlined in the display.
The display will read:

```
SAMPLE CLOCK SOURCE: INTERNAL
```



If the Input Audio Source is set to Optical Data, then the Sample Clock Source will be set to Optical and cannot be changed.

- ③ Turn the [VALUE/ENTER] knob to select either "INTERNAL" or "48 kHz IN".

To a Digital Mixer

Many digital mixers allow you to route the aux sends to the digital outputs for connection to external effects. This is an ideal application for the Q20.

To connect the Q20 to a digital mixer using S/PDIF:

- ① Connect the S/PDIF output of the mixer into the S/PDIF input of the Q20.
Make sure that one of the post fader aux sends is routed to the S/PDIF out.
- ② Connect the S/PDIF Output of the Q20 to a S/PDIF Input on the digital mixer.
Make sure that the mixer is configured to return this signal to the L/R bus.
- ③ Press [GLOBAL], then [<PAGE].
The display should read "GLOBAL DIRECT SIGNAL". Make sure this is set to "MUTE" to avoid really nasty feedback.

- ④ Press [**<PAGE**] until you reach Page 4. The display should read:

INPUT AUDIO SOURCE: ANALOG DATA

- ⑤ Turn the [**VALUE/ENTER**] wheel to set the source to “S/PDIF DATA”.
The “DIG IN” pixel will light in the top left corner of the display and the “SAMPLE CLOCK SOURCE” (Page 5) will automatically switch to S/PDIF.

If the “DIG IN” pixel at the top left corner of the display is flashing, this means that the Q20 is not receiving digital clock. Check your connections and the settings in your digital mixer to remedy this.

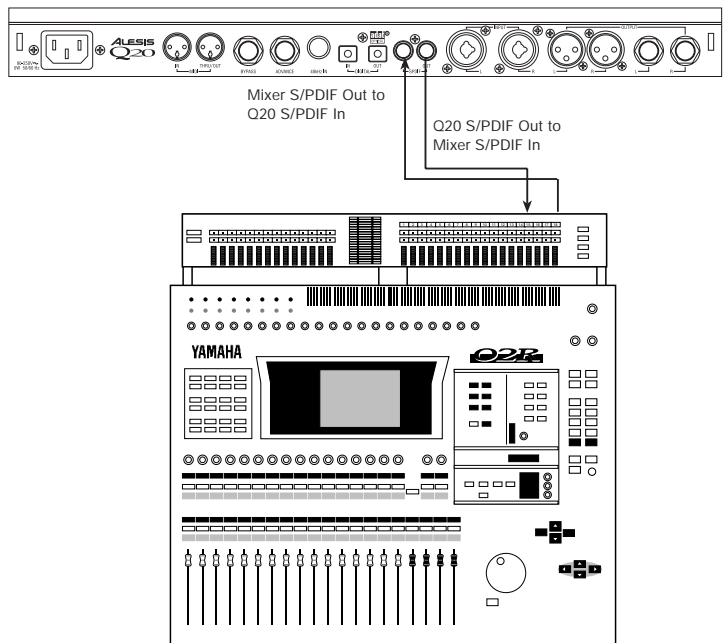

To the AI-1

If you wish to route the digital output to a device that uses the AES/EBU standard, you can connect the Q20 to an Alesis AI-1 (discontinued). This can be done directly, by connecting the Q20's [OPTICAL OUT] to the AI-1's ADAT IN or the Q20's [OPTICAL IN] connected to the AI-1's ADAT OUT. Alternatively, if you are using multiple ADATs and the BRC (as described above), you can simply insert the AI-1 into the fiber optic chain, either before or after the Q20.

From a QuadraSynth or QS-series Synthesizer

The Alesis QuadraSynth, S4, QS7, QS8, QSR and many other synths and sound modules have Alesis Optical digital outputs. These devices provide their four analog audio outputs on the first four channels of the 8 channel digital buss. Simply connect a single fiber optic cable between the QuadraSynth/QS's DIGITAL OUT connector and the Q20's [DIGITAL IN] connector. If an ADAT is being controlled by a BRC or AI-2, the QS's clock must be controlled by the 48 kHz OUT of the BRC or AI-2. Connect a BNC cable from the BRC or AI-2 to the QS's 48 kHz IN jack.

Routings

To specific ADAT tracks

To route the Q20's digital outputs to specific ADAT tracks depends on which of the 8 channels of the buss you use. If you want to record in stereo onto tracks 1 and 2 of ADAT (or 9 and 10 on ADAT #2 in a chain), route the Q20's Left output to channel 1 and its Right output to channel 2. Likewise, if you were recording onto tracks 5 and 6, then it would be channels 5 and 6 that you would use.

To route the Q20's Left and Right outputs to the digital buss:

- ① Press [GLOBAL].
The [GLOBAL] LED will light.
- ② Press [PAGE >] six times to advance to Global Page 6.
The display will read:

```
DIG CH IN: L=1,R=2  OUT: L=1,R=2
```

- ③ Press the [PAGE >] button two more times to advance the cursor to the third field in the display.

```
DIG CH IN: L=1,R=2  OUT: L=1,R=2
```

- ④ Use the [VALUE/ENTER] knob to select an output on the digital buss for the Left channel to be routed to.
You can select any of the 8 channels, except for the channel the Right output is assigned to (you cannot route both the Left and Right outputs to the same channel of the digital buss).
- ⑤ Press the [PAGE >] button to advance the cursor to the next field.

```
DIG CH IN: L=1,R=2  OUT: L=1,R=2
```

- ⑥ Use the [VALUE/ENTER] knob to select an output on the digital buss for the Right channel to be routed to.
You can select any of the 8 channels, except for the channel the Left output is assigned to.
- ⑦ Record-enable those same track numbers (in this case, 1 and 2) on the connected ADAT.
You will be able to monitor the Q20's output on those tracks of the connected ADAT.

From ADAT through the Q20 back to ADAT

When routing ADAT tracks to the Q20 to be recorded back to ADAT, how you go about it depends on whether or not you are using a BRC. If you have one or more ADATs with no BRC, then you simply connect the digital buss of the ADATs and Q20 in a loop (described earlier in this chapter).

With the BRC, you can select up to eight tracks of one ADAT to be output on the digital buss (which connects to all ADATs and the Q20 as described earlier) for track bouncing. In this situation, the BRC determines (by choosing your digital source tracks) which ADAT in the chain is transmitting. Only one ADAT can transmit on the digital buss at any single moment. All other ADATs are put into a “digital thru” mode, whereby they can receive all eight channels (even record them) and pass them along to their digital outputs without adding anything.

Although the BRC does not determine which tracks are going to the Q20, it does determine which ADAT is transmitting. Therefore, even if you do not intend to route the same tracks to the digital buss for bouncing (it is unlikely that you would want to do this at the same time, anyway), you must use the BRC to choose at least one of the tracks on the ADAT you wish to process audio in the Q20. The Q20 then intercepts any two of the 8 channels coming from the transmitting ADAT, and then processes them and routes them to the same or different channel numbers, to be recorded back onto another ADAT in the beginning of the loop.

This means that if you connect Q20 to the digital buss between the last and first ADAT in a multi-unit/BRC system, you can process any two channels; **BUT** you can record the Q20's output only to the same ADAT that is transmitting or any ADAT that comes before it in the chain. This is because the transmitting ADAT does not route the digital audio it receives “thru” to its output.

Example: Let's say you have four ADATs and a BRC. If you were to select tracks 9 and 10 (tracks 1 and 2 on ADAT #2) as your source tracks for digital bouncing on the BRC, you thereby designate ADAT #2 as the transmitter on the digital buss. Q20 can now intercept any of that ADAT's 8 channels, process them, and output them back onto two channels, which connects back to the first ADAT in the chain. The Q20's output could therefore be recorded onto ADAT #1 and #2, but not ADAT #3. This is because ADAT #2 is not routing its digital input thru to its output, because it is routing its tape signal instead. If you wanted to record the Q20's digital output onto ADAT #3, the easiest solution is to swap tapes between ADAT #1 and #3.

From a QuadraSynth or QS-series synth through the Q20 back to ADAT

The QuadraSynth/QS7/QS8/etc. provide their four audio outputs (Main Left/Right and Aux Left/Right) on the first four channels of the Alesis Optical digital buss. If you connect the QuadraSynth/QS's digital output to the digital input of the Q20, you would select channels 1 and 2 if you wanted to process the two Main outputs, or channels 3 and 4 if you wanted to process the Aux channels.

If you are using the QuadraSynth/QS along with an ADAT system and the BRC or an AI-2, you will need to supply the QS with a 48 kHz Clock source from the BRC or AI-2 (see earlier in the chapter for more information about the 48 kHz Clock). The Q20 does not need to receive a 48 kHz Clock from the BRC or AI-2, since it will be synchronizing to the QS's clock coming in on its digital inputs, which in turn will be synchronized to the 48 kHz clock coming from the BRC or AI-2. This is extremely important to make sure that all the digital devices are synchronized to the same sample clock.

Note that this chapter covers only a few of the possible digital connections to the Q20. There are dozens of products in the ADAT Group, with more added every day, which take advantage of the flexible ADAT Optical digital signal. With the addition of the S/PDIF connectors, it's tough to find any product with digital connectors which isn't compatible with the Q20. Use these explanations as examples when designing your own digital studio.

CHAPTER 8

TROUBLESHOOTING

Troubleshooting Index

If you are experience problems while operating the Q20, please use the following table to locate possible causes and solutions before contacting Alesis customer service for assistance.

Symptom	Cause	Solution
The display does not light when the ON/OFF switch is turned on.	No power.	Check that the power cable is plugged in properly.
Display is blank.	Display contrast is set either too high or low.	Adjust the display contrast. Press [GLOBAL], turn [VALUE/ENTER].
No audio is heard.	The digital input is selected.	Press [GLOBAL], press [PAGE >] four times, then turn [VALUE/ENTER] knob counterclockwise.
	Bypass is on with no direct routings set.	Select another program with routings.
	Bypass is on with Global Direct Signal Mute On.	Go to GLOBAL page 9 and set it to OFF.
	Bypass is on, with Direct Level From Input set to NONE.	Go to MIX and set Direct Level to 100% .
	Program being edited has no input or output routings.	Go to ROUTING page 3 (Delete Route) and check the existence of routings for each block and the L/R OUT by rotating the [VALUE] control to see all inputs to that block.
Effect output level is low on a single Program.	Master Effects Level is below 100%.	Press MIX and raise the level.
Clicks are heard in the audio using digital I/O.	Digital clock conflict.	Provide a master 48 kHz clock or repatch the system. Set the receiving unit's clock to external.
	ADAT clock set improperly.	Hold SET LOCATE and press DIGITAL IN until the display says "DIG".
Distortion (red LEDs flash before meter is full).	Internal DSP is clipping.	Lower the LEVEL of any rate feeding a block that is overloading.

Symptom	Cause	Solution
Unit does not respond to front panel controls.	Unknown software conflict, cosmic rays, boogiemán/men or static electricity.	Disconnect MIDI input. Power down and power up. If this doesn't work, try reinitialization, then total reset (see later in this chapter).
MIDI Program Changes are off by 1.	Transmitter doesn't display true MIDI Program Change numbers.	Change the transmitter to display 0-127, or setup a Program Table in the Q20.

Checking the Software Version

The current software version may be determined by holding [GLOBAL] and pressing [PROGRAM]. The display will indicate the currently installed software version.

```
SOFTWARE VERSION:  2.02
```

Re-initializing

To re-initialize the Q20, hold down both [PROGRAM] and [COMPARE] while turning on the power. This will reset all Global parameters to their default settings, and will initialize the edit buffer so that the current Program is set to its default settings (no Blocks/routings). However, none of the Programs in the User bank or the Preset bank are changed when re-initializing the unit this way.

Total Reset

A more drastic version of re-initializing the Q20 will erase all User Programs, as well as resetting all Global parameters. Hold down [PROGRAM], [COMPARE], and [<BLOCK] simultaneously while turning on the power.

Error Messages

Although the digital signal processing power in the Q20 is powerful and features plenty of memory, the programmability of the unit makes it possible to come across various error messages when exceeding its limitations. This is the Q20's limit handling software kicking in. Depending on the message you get, you may have to modify your Program by altering or removing unnecessary Blocks in order to complete the task. The error message will vary depending on what limitations you are attempting to exceed.

If you are using two reverb Blocks and you try to create a third, the following message will appear:

DSP IS FULL

This means there is not enough processing power available to create the additional effect. But there may be enough available to add an EQ, two pitch effects and two delays (or some other combination).

If you have created four pitch Blocks and you try to create a fifth, the following message will appear:

OUT OF LFOs

This means that there are no more available LFOs (low frequency oscillators), which are required by all pitch effects. However, the larger reverb effects (Plate 2, Room 2, Chamber 2 and Hall 2) use 1 LFO each. This means if you had three Pitch Blocks and a reverb Block using one of the larger reverbs, you would not be able to add a fourth Pitch Block. Also, the Pitch type "Mono Lezlie" uses two LFOs, which means that when using it you will only have two LFOs available.

While the Q20 has a custom DSP chip that processes all the effects, some of the effects available require that the main microprocessor assist in handling some of this responsibility. On occasion, you may be using enough effects simultaneously that no more processing power is available from the main microprocessor; *example*: when you try to create more than three Multi Tap Delays in a Program. In these cases, the following message will appear:

BLOCK COMBINATION NOT ALLOWED

Finally, if a Delay Block has its delay time to 5 seconds (5,000.0 ms), and you try to create another Delay Block and set its delay time to 460 ms or higher, you will get a "Effect Memory is Full" message. There is actually 5,455.9 ms of delay memory available. Although you could create 8 Delay Blocks, they all share the available delay memory. Therefore, when setting the delay time of each Delay Block you would only have available the amount of delay memory not being used by the other Delay Blocks. When all memory is being used, the following message will appear:

EFFECT MEMORY IS FULL

Maintenance/Service

Cleaning

Disconnect the AC cord, then use a damp cloth to clean the Q20's metal and plastic surfaces. For heavy dirt, use a non-abrasive household cleaner such as Formula 409 or Fantastik. **DO NOT SPRAY THE CLEANER DIRECTLY ONTO THE FRONT OF THE UNIT AS IT MAY DESTROY THE LUBRICANTS USED IN THE SWITCHES AND CONTROLS!** Spray onto a cloth, then use cloth to clean the unit.

Refer All Servicing to Alesis

We believe that the Q20 is one of the most reliable multi-effects processors that can be made using current technology, and should provide years of trouble-free use. However, should problems occur, **DO NOT** attempt to service the unit yourself. High voltage/high current DC voltages are present at several points within the chassis. Service on this product should be performed only by qualified technicians. **NO USER-SERVICEABLE PARTS INSIDE.**

Obtaining Repair Service

Before contacting Alesis, check over all your connections, and make sure you've read the manual.

Customers in the USA: If the problem persists, call Alesis USA at 1-800-5-ALESIS and request the Product Support department. Talk the problem over with one of our technicians; if necessary, you will be given a return authorization (RA) number and instructions on how to return the unit. All units must be shipped prepaid and COD shipments will not be accepted.

For prompt service, indicate the RA number on the shipping label. If you do not have the original packing, ship the Q20 in a sturdy carton, with shock-absorbing materials such as styrofoam pellets (the kind without CFCs, please) or "bubble-pack" surrounding the unit. Shipping damage caused by inadequate packing is not covered by the Alesis warranty.

Tape a note to the top of the unit describing the problem, include your name and a phone number where Alesis can contact you if necessary, as well as instructions on where you want the product returned. Alesis will pay for standard one-way shipping back to you on any repair covered under the terms of this warranty. Next day service is available for a surcharge.

Field repairs are not normally authorized during the warranty period, and repair attempts by unqualified personnel may invalidate the warranty.

Service address for customers in the USA:

Alesis Product Support
3630 Holdrege Avenue
Los Angeles, CA 90016