

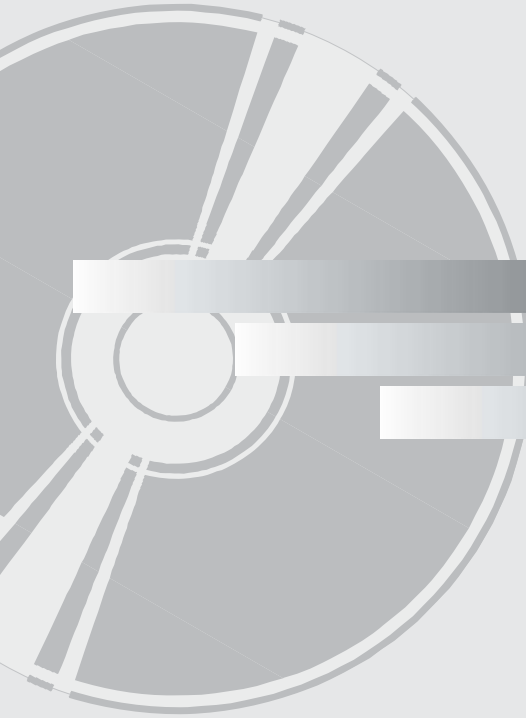

# DVD Player

## DVD-P280K



[www.samsung.com/ph](http://www.samsung.com/ph)

AK68-01506L

# PRECAUTIONS

## 1. Setting up

- Refer to the identification label located on the rear of your player for its proper operating voltage.
- Install your player in a cabinet with adequate ventilation holes (7~10cm). Do not block ventilation holes on any of the components for air circulation.
- Do not push the disc tray in by hand.
- Do not stack components.
- Be sure to turn all components off before moving the player.
- Before connecting other components to this player, be sure to turn them off.
- Be sure to remove the disc and turn off the player after use, especially if you are not going to use it for a long time.
- The mains plug is used as a disconnect device and shall stay readily operable at any time.

## 2. For your safety

- This product utilizes a laser. Use of controls or adjustments or performance of procedures other than those specified herein may result in hazardous radiation exposure.
- Do not open covers and do not repair yourself. Refer servicing to qualified personnel.

## 3. Caution

- Your player is not intended for industrial use but for domestic purposes. Use of this product is for personal use only.
- Apparatus shall not be exposed to dripping or splashing and no objects filled with liquids, such as vases, shall be placed on the apparatus.
- Exterior influences such as lightning and static electricity can affect normal operation of this player. If this occurs, turn the player off and on again with the POWER button, or disconnect and then reconnect the AC power cord to the AC power outlet. The player will operate normally.
- When condensation forms inside the player due to sharp changes in temperature, the player may not operate correctly. If this

occurs, leave the player at room temperature until the inside of the player becomes dry and operational.

## 4. Disc

- Do not clean the disc using record-cleaning sprays, benzene, thinner, or other volatile solvents that may cause damage to the disc surface.
- Do not touch the disc's signal surface. Hold by the edges or by one edge and the hole in the center.
- Wipe the dirt away gently; never wipe a cloth back and forth over the disc.

## 5. Environmental info

- The battery used in this product contains chemicals that are harmful to the environment.
- So, dispose of batteries in the proper manner, according to federal, state, and local regulations.

The product unit accompanying this user manual is licensed under certain intellectual property rights of certain third parties. This license is limited to private non-commercial use by end-user consumers for licensed contents. No rights are granted for commercial use. The license does not cover any product unit other than this product unit and the license does not extend to any unlicensed product unit or process conforming to ISO/OUR 11172-3 or ISO/OUR 13818-3 used or sold in combination with this product unit. The license only covers the use of this product unit to encode and/or decode audio files conforming to the ISO/OUR 11172-3 or ISO/OUR 13818-3. No rights are granted under this license for product features or functions that do not conform to the ISO/OUR 11172-3 or ISO/OUR 13818-3.

**CAUTION: USE OF ANY CONTROLS, ADJUSTMENTS, OR PROCEDURES OTHER THAN SPECIFIED HEREIN MAY RESULT IN HAZARDOUS RADIATION EXPOSURE.**

# BEFORE YOU START

# TABLE OF CONTENTS

## Accessories



Remote Control



Batteries for Remote Control (AAA Size)

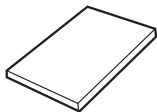

User's Manual



Video/Audio Cable

## Install Batteries in the Remote control

1. Open the battery cover on the back of the remote control.
2. Insert two AAA batteries.  
Make sure that the polarities (+ and -) are aligned correctly.
3. Replace the battery cover.

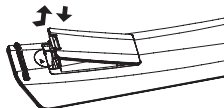

## If remote control doesn't operate properly:

- Check the polarity + - of the batteries (Dry-Cell)
- Check if the batteries are drained.
- Check if remote control sensor is blocked by obstacles.
- Check if there is any fluorescent lighting nearby.

Precautions . . . . .	2
Before you start . . . . .	3
<b>Setup</b>	
General Features . . . . .	4
Disc Type and Characteristics . . . . .	5
Description . . . . .	6
Tour of the Remote Control . . . . .	8
<b>Connections</b>	
Choosing a Connection . . . . .	9
<b>Basic Functions</b>	
Playing a Disc . . . . .	14
Using the Search and Skip Functions . . . . .	15
Using the Display Function . . . . .	15
Using the Disc Menu and Title Menu . . . . .	16
Repeat Play . . . . .	16
Slow Play . . . . .	17
<b>Advanced Functions</b>	
Adjusting the Aspect Ratio (EZ View) . . . . .	17
Selecting the Audio Language . . . . .	18
Selecting the Subtitle Language . . . . .	18
Changing The Camera Angle . . . . .	19
Using the Bookmark Function . . . . .	19
Using the Zoom Function . . . . .	20
Clips Menu for MP3/WMA/JPEG/CD Audio . . . . .	20
Folder Selection . . . . .	20
MP3/WMA/CD Audio Playback . . . . .	21
Playing media files Using the USB Host Feature . . . . .	21
CD Ripping . . . . .	23
Picture CD Playback . . . . .	23
<b>Karaoke Functions</b>	
Karaoke Functions . . . . .	24
<b>Changing Setup Menu</b>	
Using the Setup Menu . . . . .	25
Setting Up the Language Features . . . . .	25
Setting Up the Audio Options . . . . .	26
Setting Up the Display Options . . . . .	27
Setting Up the Parental Control . . . . .	28
<b>Reference</b>	
Troubleshooting . . . . .	30
USB HOST Feature Supported Products . . . . .	31
Specifications . . . . .	32

# SETUP

## General Features

### Excellent Sound

Dolby Digital, a technology developed by Dolby Laboratories, provides crystal clear sound reproduction.

### Screen

Both regular and widescreen(16:9) pictures can be viewed.

### Slow Motion

An important scene can be viewed in slow motion.

### Parental Control (DVD)

The parental control allows users to set the level necessary to prohibit children from viewing harmful movies such as those with violence, adult subject matter, etc.

### Various On-Screen Menu Functions

You can select various languages (Audio/Subtitle) and screen angles while enjoying movies.

### Progressive Scan

Progressive scanning creates an improved picture with double scan lines of a conventional interlaced picture.

### EZ VIEW (DVD)

Easy View enables picture adjustment to match your TV's screen size (16:9 or 4:3).

### Digital Photo Viewer (JPEG)

You can view digital photos on your TV.

### Repeat

You can repeat a song or movie simply by pressing the REPEAT button.

### MP3/WMA

This unit can play discs created from MP3/WMA files.

### CD Ripping

This feature lets you to copy audio files from disc to USB device into MP3 format. (Only Audio CD (CD DA)).

### Note

- Discs which cannot be played with this player.
- DVD-ROM • DVD-RAM
- CD-ROM • CDV
- CDI • CVD
- CDGs play audio only, not graphics.
- Ability to play back may depend on recording conditions.
- DVD-R, +R
- CD-RW
- DVD+RW, -RW (V mode)
- The unit may not play certain CD-R, CD-RW and DVD-R due to the disc type or recording conditions.

## COPY PROTECTION

Many DVD discs are encoded with copy protection. Because of this, you should only connect your DVD player directly to your TV, not to a VCR. Connecting to a VCR results in a distorted picture from copy-protected DVD discs.



This product incorporates copyright protection technology that is protected by methods claims of certain U.S. patents and other intellectual property rights owned by Macrovision Corporation and other rights owners. Use of this copyright protection technology must be authorized by Macrovision Corporation, and is intended for home and other limited viewing uses only unless otherwise authorized by Macrovision Corporation. Reverse engineering or disassembly is prohibited.

## PROGRESSIVE SCAN OUTPUTS (525p)







"CONSUMERS SHOULD NOTE THAT NOT ALL HIGH DEFINITION TELEVISION SETS ARE FULLY COMPATIBLE WITH THIS PRODUCT AND MAY CAUSE ARTIFACTS TO BE DISPLAYED IN THE PICTURE. IN CASE OF 525 OR 625 PROGRESSIVE SCAN PICTURE PROBLEMS, IT IS RECOMMENDED THAT THE USER SWITCH THE CONNECTION TO THE 'STANDARD DEFINITION' OUTPUT. IF THERE ARE QUESTIONS REGARDING YOUR TV SET COMPATIBILITY WITH THIS MODEL 525p AND 625p DVD PLAYER, PLEASE CONTACT SAMSUNG'S CUSTOMER SERVICE CENTER."

## Disc Type and Characteristics

This DVD player is capable of playing the following types of discs with the corresponding logos:

Disc Types (Logos)	Recording Types	Disc Size	Max. Playing Time	Characteristics
<b>DVD</b> 	Audio + Video	12 Cm	Single-sided 240 min. Double-sided 480 min.	- DVD contains excellent sound and video due to Dolby Digital and MPEG-2 system. - Various screen and audio functions can be easily selected through the on-screen menu.
		8 Cm	Single-sided 80 min. Double-sided 160 min.	
<b>VIDEO-CD</b> 	Audio + Video	12 Cm	74 min.	- Video with CD sound, VHS quality & MPEG-1 compression technology.
		8 Cm	20 min.	
<b>AUDIO-CD</b> 	Audio	12 Cm	74 min.	- CD is recorded as a Digital Signal with better audio quality, less distortion and less deterioration of audio quality over time.
		8 Cm	20 min.	

### Disc Markings

	Play Region Number
	NTSC broadcast system in U.S.A, Canada, Korea, Japan, etc
	Dolby Digital disc
	Stereo disc
	Digital Audio disc
	DTS disc
	MP3 disc

### Region Number

Both the DVD player and the discs are coded by region. These regional codes must match in order for the disc to play. If the codes do not match, the disc will not play.

The Region Number for this player is described on the rear panel of the player.

**You must only insert one DVD disc at a time. Inserting two or more discs will not allow to play them back and it may cause damage to the DVD player.**

# Description

## Front Panel Controls

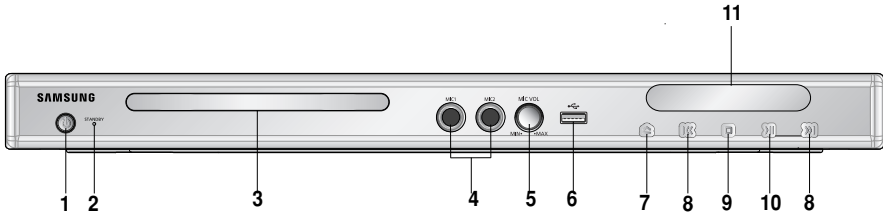

- 1. STANDBY/ON (⏻)**  
When STANDBY/ON is pressed on, the indicator goes out and the player is turned on.
- 2. STANDBY indicator**  
When the unit is first plugged in, this indicator lights.
- 3. DISC TRAY**  
Place the disc here.
- 4. MIC 1/2**  
Connect Microphone for karaoke functions.
- 5. MICROPHONE VOLUME**  
Use to adjust microphone volume level. Use the button by pressing it. Turn it to the left or right to control the volume.
- 6. USB Host**  
Connect digital still camera, MP3 player, memory stick, Card reader, or another removable storage devices
- 7. OPEN/CLOSE (△)**  
Press to open and close the disc tray.
- 8. SKIP (◀ / ▶) SEARCH**  
Allow you to search forward/backward through a disc. Use to skip the title, chapter or track.
- 9. STOP (□)**  
Stops disc play.
- 10. PLAY/PAUSE (▶)**  
Begin or pause disc play.
- 11. DISPLAY**  
Operation indicators are displayed here.

## Front Panel Display



**Total playing time/Displays various messages concerning operations such as PLAY, STOP, LOAD ...**

nodSC: No disc loaded.

OPEn: The disc tray is open.

LOAD: Player is loading disc information.

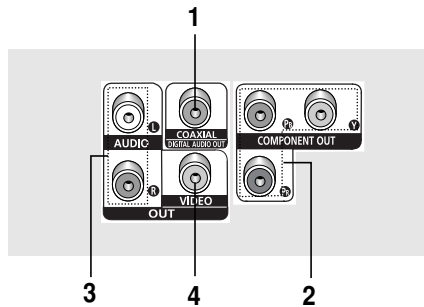

### 1. DIGITAL AUDIO OUT JACKS

- Use either a coaxial digital cable to connect to a compatible Dolby Digital receiver.
- Use to connect to an A/V Amplifier that contains a Dolby Digital, MPEG2 or DTS decoder.

### 2. COMPONENT VIDEO OUT JACKS

- Use these jacks if you have a TV with Component Video in jacks. These jacks provide P<sub>R</sub>, P<sub>B</sub> and Y video.
- If Component(P-SCAN) Video Output is selected in Setup Menu, progressive scan mode will work.
- If Component(I-SCAN) Video Output is selected in Setup Menu, interlaced scan mode will work.

### 3. AUDIO OUT JACKS

Connect to the Audio input jacks of your television or audio/video receiver.

### 4. VIDEO OUT JACK

- Use a video cable to connect to the Video input jack on your television.

### Note

- Consult your TV User's Manual to find out if your TV supports Progressive Scan. If Progressive Scan is supported, follow the TV User's Manual regarding Progressive Scan settings in the TV's menu system.
- See pages 27 to get more information on how to use the setup menu.

# Tour of the Remote Control

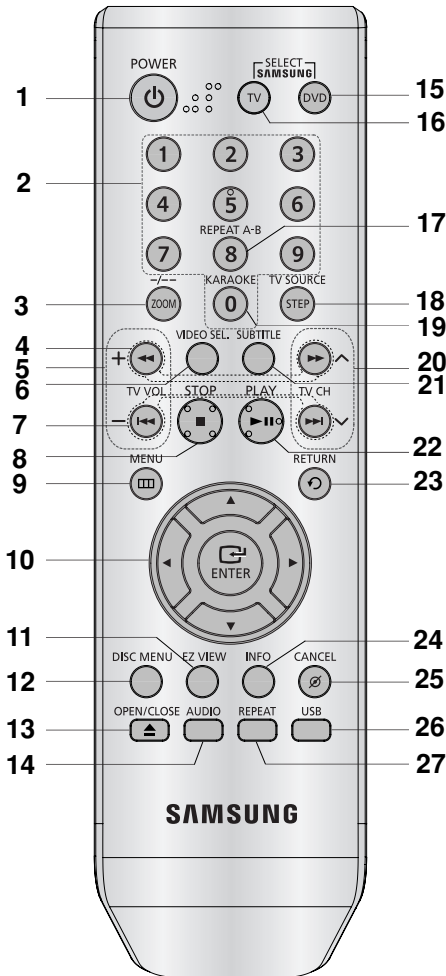

1. **DVD POWER Button**  
Turns the power on or off.
2. **NUMBER Buttons**
3. **ZOOM Button / (-/--)**  
Enlarge DVD Picture / Use this button to select the channel of TV program by inserted the channel number (TV mode)
4. **SEARCH Buttons (◀ / ▶)**  
Allow you to search forward/backward through a disc.

5. **TV VOL (+, -) Buttons**  
Control volume.
6. **VIDEO SEL. Button**  
Selects video output formats
7. **SKIP Buttons (◀◀ / ▶▶)**  
Use to skip the title, chapter or track
8. **STOP Button (■)**
9. **MENU Button**  
Brings up the DVD player's menu.
10. **ENTER/▲/▼, ◀/▶ Buttons**  
This button functions as a toggle switch.
11. **EZ VIEW Button**  
The aspect ratio of a picture can easily be adjusted according to the screen size of your TV (16:9 or 4:3).
12. **DISC MENU Button**  
Brings up the Disc menu.
13. **OPEN/CLOSE (▲) Button**  
To open and close the disc tray.
14. **AUDIO Button**  
Use this button to access various audio functions on a disc.
15. **DVD Button**  
Press this button when you use a DVD player.
16. **TV Button**  
Press this button to operate TV.
17. **REPEAT A-B Button**  
Allows you to repeat A-B disc.
18. **STEP Button/TV Source**  
Advances play one frame at a time/Press this button to select the an available TV source (TV mode).
19. **KARAOKE Button**  
Use to begin Karaoke functions.
20. **TV CH (▲, ▼) Buttons**  
Channel selection.
21. **SUBTITLE Button**
22. **PLAY/PAUSE Button (▶||)**  
Begin/Pause disc play.
23. **RETURN Button**  
Returns to a previous menu.
24. **INFO Button**  
Displays the current disc mode.
25. **CANCEL Button**  
Use to remove menus or status displays from the screen.
26. **USB Button**
27. **REPEAT Button**  
Allows you to repeat play a title, chapter, track, or disc.



# CONNECTIONS

## Choosing a Connection

The following shows examples of connections commonly used to connect the DVD player with a TV and other components.

### Before Connecting the DVD Player

- Always turn off the DVD player, TV, and other components before you connect or disconnect any cables.
- Refer to the user's manual of the additional components you are connecting for more information on those particular components.

### Connection to a TV (For Video)

#### 1

Using video/audio cables, connect the **VIDEO (yellow)/AUDIO (red and white) OUT** terminals on the rear of the DVD player to the **VIDEO (yellow)/AUDIO (red and white) IN** terminals of TV.

#### 2

Turn on the DVD player and TV.

#### 3

Press the **TV/VIDEO** button on the TV's remote control to select **Video**.

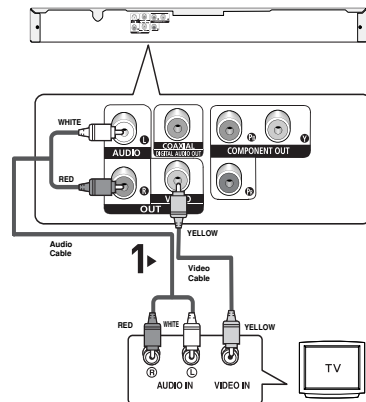

### Note

- **Noise may be generated if the audio cable is too close to the power cable.**
- If you want to connect to an Amplifier, please refer to the Amplifier connection page. (See pages 12 to 13)
- The number and position of terminals can vary depending on your TV set. Please refer to the user's manual of the TV.
- If there is one audio input terminal on the TV, connect it to the [AUDIO OUT][left] (white) terminal of the DVD player.

## Connection to a TV (Interlace)

- Connecting to your TV using Component video cables.
- You will enjoy high quality and accurate color reproduction images. Component video separates the picture element into black and white(Y), blue(P<sub>B</sub>), red(P<sub>R</sub>) signals to present clear and clean images. (Audio signals are delivered through the audio output.)

### 1

Using component video cables (not included), connect the **COMPONENT VIDEO OUT** terminal on the rear of the DVD player to the **COMPONENT IN** terminal of TV.

### 2

Using the audio cables, connect the **AUDIO (red and white) OUT** terminals on the rear of the DVD player to the **AUDIO (red and white) IN** terminals of TV. Turn on the DVD player and TV.

### 3

Press the **TV/VIDEO** button on the TV's remote control to select **Component** or **DVD**.

### 4

Set the Video Output to **(I-SCAN)** in the Display Setup menu. (See pages 27 to 28)

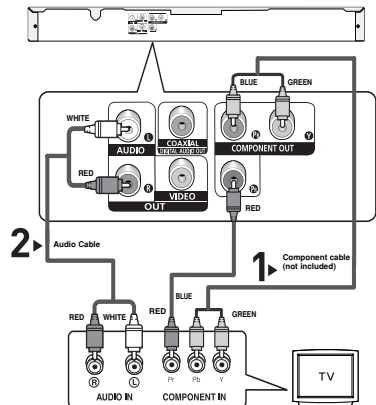

## Note

- If you want to connect to an Amplifier, please refer to the Amplifier connection page. (See pages 12 to 13)
- The component terminal of TV can be marked by "R-Y, B-Y, Y" or "Cr, Cb, Y" instead of "P<sub>R</sub>, P<sub>B</sub>, Y" depending on the manufacturer. The number and position of terminals can vary depending on the TV set. Please refer to the user's manual of the TV.

## Connection to a TV (Progressive)

### 1

Using component video cables (not included), connect the **COMPONENT VIDEO OUT** terminal on the rear of the DVD player to the **COMPONENT IN** terminal of TV.

### 2

Using the audio cables, connect the **AUDIO (red and white) OUT** terminals on the rear of the DVD player to the **AUDIO (red and white) IN** terminals of TV. Turn on the DVD player and TV.

### 3

Press the **TV/VIDEO** button on the TV's remote control to select **Component** or **DVD**.

### 4

Set the Video Output to **(P-SCAN)** in the Display Setup menu. (See pages 27 to 28)

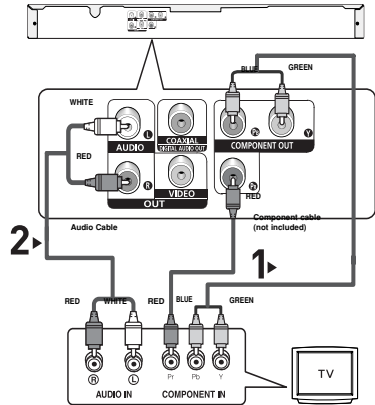

## To see the progressive video output,

- Consult your TV User's Manual to find out if your TV supports Progressive Scan. If Progressive Scan is supported, follow the TV User's Manual regarding Progressive Scan settings in the TV's menu system.
- Depending on your TV, the connection method may differ from the illustration above.

## Note

- What is "Progressive Scan"?  
Progressive scan has twice as many scanning lines as the interlace output method has. Progressive scanning method can provide better and clearer picture quality.

## Connection to an Audio System (2 Channel Amplifier)

### 1

Using the audio cables, connect the **AUDIO (red and white) OUT** terminals on the rear of the DVD player to the **AUDIO (red and white) IN** terminals of the Amplifier.

### 2

Using the video signal cable(s), connect the **VIDEO** or **COMPONENT OUT** terminals on the rear of the DVD player to the **VIDEO** or **COMPONENT IN** terminal of your TV.

### 3

Turn on the DVD player, TV, and Amplifier.

### 4

Press the input select button of the Amplifier to select **external input** in order to hear sound from the DVD player.

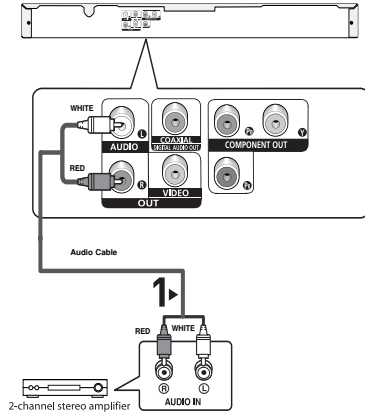

### Note

- Please turn the volume down when you turn on the Amplifier. Sudden loud sound may cause damage to the speakers and your ears.
- Please set the audio in the menu screen according to the Amplifier. (See pages 26 to 27)
- The position of terminals can vary depending on the Amplifier. Please refer to the user's manual of the Amplifier.

## Connection to an Audio System (Dolby digital, MPEG2 or DTS Amplifier)

### 1

If using a coaxial cable (not included), connect the **DIGITAL AUDIO OUT (COAXIAL)** terminal on the rear of the DVD player to the **DIGITAL AUDIO IN (COAXIAL)** terminal of the Amplifier.

### 2

Using the video signal cable(s), connect the **VIDEO** or **COMPONENT OUT** terminals on the rear of the DVD player to the **VIDEO** or **COMPONENT IN** terminal of TV.

### 3

Turn on the DVD player, TV, and Amplifier.

### 4

Press the input select button of the Amplifier to select **external input** in order to hear sound from the DVD player.

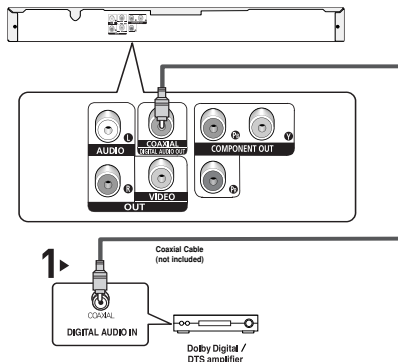

### Note

- **Please turn the volume down when you turn on the Amplifier. Sudden loud sound may cause damage to the speakers and your ears.**
- Please set the audio in the menu screen according to the Amplifier. (See pages 26 to 27)
- The position of terminals can vary depending on the Amplifier. Please refer to the user's manual of the Amplifier.

# BASIC FUNCTIONS

## Playing a Disc

### Before Play

- Turn on your TV and set it to the correct Video Input by pressing TV/VIDEO button on the TV remote control.
- If you connected an external Audio System, turn on your Audio System and set it to the correct Audio Input.

After plugging in the player, the first time you press the DVD **POWER** button, this screen comes up: If you want to select a language, press a **NUMBER** button. (This screen will only appear when you plug in the player for the first time.) If the language for the startup screen is not set, the settings may change whenever you turn the power on or off. Therefore, make sure that you select the language you want to use.

Once you select a menu language, you can change it by pressing the **»** button on the front panel of the unit for more than 5 seconds with no disc in the unit. Then the **SELECT MENU LANGUAGE** window appears again where you can reset your preferred language.



### Playback

1. Press the **OPEN/CLOSE** (**▲**) button. The **STANDBY** indicator light goes out and the tray opens.
2. Place a disc gently into the tray with the disc's label facing up.
  - You must only insert one DVD disc at a time. Inserting two or more discs will not allow to play them back and it may cause damage to the DVD player.
3. Press the **PLAY/PAUSE** (**▶||**) button or **OPEN/ CLOSE** (**▲**) button to close the disc tray.
  - When you stop disc play, the player remembers where you stopped, so when you press **PLAY/PAUSE** (**▶||**) button again, it will pick up where you left off.

### 4. Stopping Play

Press the **STOP** (**■**) button during play.

### 5. Removing Disc

Press the **OPEN/CLOSE** (**▲**) button.

### 6. Pausing Play

Press the **PLAY/PAUSE** (**▶||**) or **STEP** button on the remote control during play.

- Screen stops, no sound.

- To resume, press the **PLAY/PAUSE** (**▶||**) button once again.

### 7. Step Motion Play (Except CD)

Press the **STEP** button on the remote control during play.

- Each time the button is pressed, a new frame will appear.

- No sound is heard during STEP mode.

- Press the **PLAY/PAUSE** (**▶||**) button to resume normal play.

- You can only perform step motion play in the forward direction.

### 8. Slow Motion Play

Press the **SEARCH** (**◀◀ / ▶▶**) button to choose the play speed between 1/8, 1/4 and 1/2 of normal during **PAUSE** or **STEP** mode.

- No sound is heard during slow mode.

- Press the **PLAY/PAUSE** (**▶||**) button to resume normal play.

### Note

- If the player is left in the stop mode for more than one minute without any user interaction, a screen saver will be activated. Press the **PLAY/PAUSE** (**▶||**) button to resume normal play.
- If the player is left in the stop mode for more than about 30 minutes, the power will automatically shut off except when the MIC is connected. (Automatic Power-Off Function)
- If the player is left for about 5 minutes in pause mode, it will stop.
- This (**⊗**) icon indicates an invalid button press.

## Using the Search and Skip Functions

During play, you can search quickly through a chapter or track, and use the skip function to jump to the next selection.

### Searching through a Chapter or Track

During play, press the **SEARCH** (◀◀ or ▶▶) button on the remote control for more than 1 second.

DVD	2X, 4X, 64X, 128X
VCD	4x, 8X
CD	2X, 4X, 8X

#### Note

- The speed marked in this function may be different from the actual speed of playback.
- No sound is hearing during search mode (Except CD).

### Skipping Tracks

During play, press the **SKIP** (◀◀ or ▶▶) button.

- When playing a DVD, if you press the **SKIP** (▶▶) button, it moves to the next chapter. If you press the **SKIP** (◀◀) button, it moves to the beginning of the chapter. One more press makes it move to the beginning of the previous chapter.
- When playing a VCD 2.0 in Menu Off mode, or a VCD 1.1 or a CD, if you press the **SKIP** (▶▶) button, it moves to the next track. If you press the **SKIP** (◀◀) button, it moves to the beginning of the track. One more press makes it move to the beginning of the previous track.
- If a track exceeds 15 minutes when playing a VCD and you press the ▶▶ button, it moves forward 5 minutes. If you press the ◀◀ button, it moves backward 5 minutes.

#### Note







Only Menu Off is available for VCD2.0. Each press of the **DISC MENU** button toggles between Menu On and Menu Off.

## Using the Display Function

### When Playing a DVD/VCD

1. During play, press the **INFO** button on the remote control.
2. Press the ▲/▼ buttons to select the desired item.
  - Only Menu Off is available for VCD2.0. Each press of the **DISC MENU** button toggles between Menu On and Menu Off.
3. Press the ◀/▶ buttons to make the desired setup and then press the **ENTER** button.
  - You may use the number buttons of the remote control to directly access a title, chapter or to start the playback from the desired time.
4. To make the screen disappear, press the **CANCEL** button again.

#### Note

	To access the desired title when there are more than one in the disc. For example, if there is more than one movie on a DVD, each movie will be identified.
 	Most DVD discs are recorded in chapters so that you can quickly find a specific passage (similar to tracks on an video CD).
	Allows playback of the film from a desired time. You must enter the starting time as a reference. The time search function does not operate on some disc.
	Refers to the language of the film soundtrack. In the example, the soundtrack is played in English 5.1CH. A DVD disc can have up to eight different soundtracks.
	Refers to the subtitle languages available in the disc. You will be able to choose the subtitle languages or, if you prefer, turn them off from the screen. A DVD disc can have up to 32 different subtitles.
	To access the desired Bookmark, Angle or EZ View function. Some DVD discs are have more angle function from any picture. Bookmark function make you easily and quickly to find a track or chapter from DVD or VCD ( Menu Off). The EZ View function is use for changing the aspect ratio in DVD.

## Using the Disc Menu and Title Menu

### Using the Disc Menu

1. During Stop mode, press the **MENU** button on the remote control.
2. Press the **▲/▼** buttons to select **Disc Menu**, then press the **▶** or **ENTER** button.

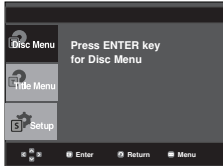

#### Note

- Depending on a disc, the Disc Menu may not work.
- You can also use the Disc Menu, using the DISC MENU button on the remote control.
- Only Menu Off is available for VCD2.0. Each press of the DISC MENU button toggles between Menu On and Menu Off.

### Using the Title Menu

1. During Stop mode, press the **MENU** button on the remote control.
2. Press the **▲/▼** buttons to select **Title Menu**, then press the **▶** or **ENTER** button.

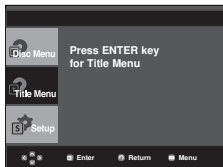

#### Note

- Depending on a disc, the Title Menu may not work.
- Title Menu will only be displayed if there are at least two titles in the disc.

## Repeat Play

Repeat the current track, chapter, title, a chosen section (A-B), or all of the disc.

### When playing a DVD/VCD

1. Press the **REPEAT** button on the remote control. Repeat screen appears.
2. Press the **◀/▶** buttons to select **Chapter**, **Title** or **A-B**, then press the **ENTER** button.
  - DVD repeats play by chapter or title, VCD repeat play by disc or track.
  - Chapter (🔄): repeats the chapter that is playing.
  - Title (📄): repeats the title that is playing.
  - Disc (📀): repeats the disc that is playing.
  - Track (🎵): repeats the track that is playing.
  - A-B: repeats a segment of the disc that you select.

#### DVD

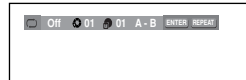

#### VCD

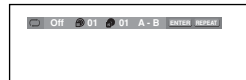

### Using the A-B Repeat function

1. Press the **REPEAT** button on the remote control.
2. Press the **◀/▶** buttons to Select **A-B** button.
3. Press the **ENTER** button at the point where you want repeat play to start (A). **B** is automatically highlighted.
4. Press the **ENTER** button at the point where you want the repeat play to stop (B).
  - To return to normal play, press the **CANCEL** button.
5. To return to normal play, press **REPEAT** button again, then press the **◀/▶** buttons to select **Off** and press **ENTER** button.

#### DVD

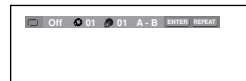

#### VCD

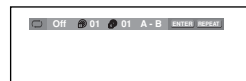



**Note**

- A-B REPEAT allows you to set point (B) until at least 5 seconds of play back time has elapsed after point (A) has been set.
- Depending on a disc, the Repeat function may not work.
- Only Menu Off is available for VCD2.0. Each press of the DISC MENU button toggles between Menu On and Menu Off.

**Slow Play**

This feature allows you to play scenes slowly containing sports, dancing, musical instruments being played etc., so you can study them more closely.

**When playing a DVD**

1. During play, press the **PLAY/PAUSE** (▶||) button.
2. Press the **SEARCH** (◀ / ▶) button to choose the play speed between 1/8, 1/4 and 1/2 of normal during PAUSE or STEP mode.

**ADVANCED FUNCTIONS****Adjusting the Aspect Ratio (EZ View)****To play back using aspect ratio (DVD)**

Press the **EZ VIEW** button.

- The screen size changes when the button is pressed repeatedly.
- The screen zoom mode operates differently depending on the screen setting in the Display Setup menu.
- To ensure correct operation of the **EZ VIEW** button, you should set the correct aspect ratio in the Display Setup menu. (See pages 27 to 28).

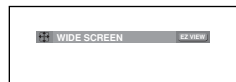
**If you are using a 16:9 TV****For 16:9 aspect ratio discs**

- **WIDE SCREEN**  
Displays the content of the DVD title in 16:9 aspect ratio.
- **SCREEN FIT**  
The top and bottom portions of the screen are cut off. When playing a 2.35:1 aspect ratio disc, the black bars at the top and bottom of the screen will disappear. The picture will look vertically stretched. (Depending on a type of disc, the black bars may not disappear completely.)
- **ZOOM FIT**  
The top, bottom, left and right of the screen are cut off and the central portion of the screen is enlarge

**For 4:3 aspect ratio discs**

- **Normal Wide**  
Displays the content of the DVD title in 16:9 aspect ratio. The picture will look horizontally stretched.
- **SCREEN FIT**  
The top and bottom portions of the screen are cut off and the full screen appears. The picture will look vertically stretched.
- **ZOOM FIT**  
The top, bottom, left and right portions of the screen are cut off and the central portion of the screen is enlarged.
- **Vertical Fit**  
When a 4:3 DVD is viewed on a 16:9 TV, black bars will appear at the left and right of the screen in order to prevent the picture from looking horizontally stretched.

## If you are using a 4:3 TV

### For 16:9 aspect ratio discs

#### - 4:3 Letter Box

Displays the content of the DVD title in 16:9 aspect ratio. The black bars will appear at the top and bottom of the screen.

#### - 4:3 Pan&Scan

The left and right portions of the screen are cut off and the central portion of the 16:9 screen is displayed.

#### - SCREEN FIT

The top and bottom portions of the screen are cut off and a full screen appears. The picture will look vertically stretched.

#### - ZOOM FIT

The top, bottom, left and right of the screen are cut off and the central portion of the screen is enlarged.

### For 4:3 aspect ratio discs

#### - Normal Screen

Displays the content of the DVD title in 4:3 aspect ratio.

#### - SCREEN FIT

The top and bottom portions of the screen are cut off and the full screen appears. The picture will look vertically stretched.

#### - ZOOM FIT

The top, bottom, left and right portions of the screen are cut off and the central portion of the screen is enlarged.

### Note

This function may behave differently depending on the type of disc.

## Selecting the Audio Language

You can select a desired audio language quickly and easily with the AUDIO button.

### Using the AUDIO button

1. Press the **AUDIO** button. The Audio changes when the button is pressed repeatedly.

The audio languages are represented by abbreviations.

DVD



VCD



When playing a VCD, you can select among **Stereo, Left or Right**

2. To remove the **AUDIO** icon, press the **CANCEL** or **RETURN** button.

### Note

- This function depends on audio languages are encoded on the disc and may not work.
- A DVD disc can contain up to 8 audio languages.
- To have the same audio language come up whenever you play a DVD; Refer to "Using the Audio Language" on page 26.

## Selecting the Subtitle Language

You can select a desired subtitle quickly and easily with the SUBTITLE button.

### Using the SUBTITLE button (DVD)

1. Press the **SUBTITLE** button. The subtitle languages are represented by abbreviations. The subtitle changes when the button is pressed repeatedly.

DVD



2. To remove the **SUBTITLE** icon, press the **CANCEL** or **RETURN** button.

### Note

- You have to change the desired subtitle in the Disc Menu, according to discs. Press the DISC MENU button.
- This function depends on what subtitles are encoded on the disc and may not work on all DVDs.
- A DVD disc can contain up to 32 subtitle languages.
- To have the same subtitle language come up whenever you play a DVD; Refer to "Using the Subtitle Language" on page 26.

## Changing the Camera Angle

When a DVD contains multiple angles of a particular scene, you can use the ANGLE function.

### Using the ANGLE Function (DVD)

If the disc contains multiple angles, the ANGLE appears on the screen.

1. During play mode, press the **INFO** button on the remote control.
2. Press the **▲/▼** buttons to select **Shortcut**.
3. Press the **◀/▶** buttons to select **Angle**, then press the **ENTER** button.

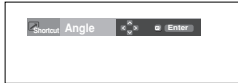

4. Press the **◀/▶** buttons or you can use the number buttons on the remote control to select the desired angle.



#### Note

- If the disc has only one angle, this feature won't work. Currently, very few discs have this feature.
- Depending on the disc, these functions may not work

## Using the Bookmark Function

This feature lets you bookmark sections of a DVD or VCD (Menu Off mode) so you can quickly find them at a later time.

### Using the Bookmark Function (DVD/VCD)

1. During play, press the **INFO** button on the remote control.
2. Press the **▲/▼** buttons to select **Shortcut**.
3. Press the **◀/▶** buttons to select **Bookmark (Except VCD)**, then press the **ENTER** button.

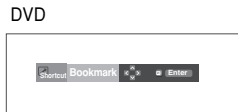

VCD



4. When you reach the scene you want to mark, press the **ENTER** button. Up to three scenes may be marked at a time.



#### Note

- Only Menu Off is available for VCD2.0. Each press of the DISC MENU button toggles between Menu On and Menu Off.
- Depending on a disc, the Bookmark function may not work.

### Recalling a Marked Scene

- 1~3. The first 1~3 steps are the same as those for "Using the Bookmark Function" on page 19.
4. Press the **◀/▶** buttons to select a marked scene.



5. Press the **PLAY/PAUSE (▶||)** button to skip to the marked scene.

### Clearing a Bookmark

- 1~3. The first 1~3 steps are the same as those for "Using the Bookmark Function" on page 19.
4. Press the **◀/▶** buttons to select the bookmark number you want to delete.
5. Press the **CANCEL** button to delete a bookmark number.



# Using the Zoom Function

## Using the Zoom Function (DVD/VCD)

1. During Play or Pause mode, press the **ZOOM** button on the remote control, and then press the **ENTER** button.
  2. Press the **▲/▼** or **◀/▶** buttons to select the part of the screen you want to zoom in on.
- During DVD play, press ENTER to zoom in 2X/4X/2X/Normal in order.
  - During VCD play, press ENTER to zoom in 2X/4X/2X/Normal in order.



## Clips Menu for MP3/WMA/JPEG/CD Audio

CD Audio or discs with MP3/WMA/JPEG contain individual songs and/or pictures that can be organized into folders as shown below. They are similar to how you use your computer to put files into different folders.

Open the disc tray.  
Place the disc on the tray.  
Close the tray.  
The tray closes and this screen displays.



- : Name of currently playing file.
- : Current Playback Time.
- : Current Playback Mode : There are four modes. They can be selected in order by pressing the **REPEAT** button.
  - Off: Normal Playback
  - Track: Repeats the current track.
  - Folder: Repeats the current folder
  - Random: Files in the disc will be played in random order.

- : MP3 file icon.
- : WMA file icon.
- : JPEG file icon.
- : CD Audio file icon.
- : Folder icon.
- : Current Folder icon.

## Folder Selection

The folder can be selected both in Stop or Play mode.

- **To select the Parent Folder**  
Press the **RETURN** button to go to parent folder, or press the **▲/▼** buttons to select “..” and press **ENTER** to go to the parent folder.
- **To select the Peer Folder**  
Press the **▲/▼** buttons to select the desired folder, then press **ENTER**.
- **To select the Sub-Folder**  
Press the **▲/▼** buttons to select the desired folder, then press **ENTER**.

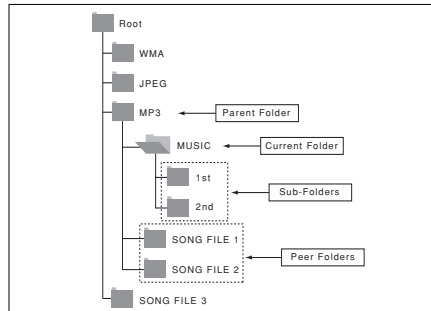

## MP3/WMA/CD Audio Playback

1. Open the disc tray. Place the disc on the tray. Close the tray.
  - Only one kind of file is played back when a disc or a folder contains both MP3 and WMA files.
2. Press the ▲/▼ buttons to select a song file.  
Press **ENTER** to begin playback of the song file.



### Repeat/Random Playback

Press the **REPEAT** button to change the playback mode. There are four modes, such as **Off**, **Track**, **Folder** and **Random**.

- **Off**: Normal Playback
- **Track**: Repeats the current song file.
- **Folder**: Repeats the song files which have the same extension in the current folder.
- **Random**: Song files which have the same extension will be played in random order.

To resume normal play, press the **CANCEL** button.

### CD-R MP3/WMA file

When you record MP3 or WMA files on CD-R, please refer to the following.

- **Your MP3 or WMA files should be ISO 9660 or JOLIET format.**  
ISO 9660 format and Joliet MP3 or WMA files are compatible with Microsoft's DOS and Windows, and with Apple's Mac. This format is the most widely used.
- **When naming your MP3 or WMA files, do not exceed 8 characters, and enter ".mp3, .wma" as the file extension.**  
General name format : Title.mp3. or Title.wma. When composing your title, make sure that you use 8 characters or less, have no spaces in the name, and avoid the use of special characters including: (,/, \, =, +).
- **Use a decompression transfer rate of at least 128 Kbps when recording MP3 files.**  
Sound quality with MP3 files basically depends on the rate of compression/decompression you choose. Getting CD audio sound requires an analog/digital sampling rate, that is conversion to MP3 format, of at least 128 Kbps and up to 160 Kbps. However, choosing higher rates, like 192 Kbps or more, only rarely give better sound quality. Conversely, files with decompression rates below 128 Kbps will not be played properly.

- **Use a decompression transfer rate of at least 64Kbps when recording WMA files.**  
Sound quality with WMA files basically depends on the rate of compression/decompression you choose. Getting CD audio sound requires an analog/digital sampling rate, that is conversion to WMA format, of at least 64Kbps and up to 192Kbps. Conversely, files with decompression rates below 64Kbps or over 192Kbps will not be played properly.
- **Do not try recording copyright protected MP3 files.**  
Certain "secured" files are encrypted and code protected to prevent illegal copying. These files are of the following types: Windows Media™ (registered trade mark of Microsoft Inc) and SDMI™ (registered trade mark of The SDMI Foundation). You cannot copy such files.

#### - Important:

- The above recommendations cannot be taken as a guarantee that the DVD player will play MP3 recordings, or as an assurance of sound quality. You should note that certain technologies and methods for MP3 file recording on CD-Rs prevent optimal playback of these files on your DVD player (degraded sound quality and in some cases, inability of the player to read the files).
- This unit can play a maximum of 500 files and 500 folders per disc.

## Playing Media Files Using the USB Host feature

You can enjoy the media files such as pictures, movies and tunes saved in an MP3 player, USB memory or digital camera in high audio by connecting the storage device to the USB port of the DVD Player.

### Using the USB HOST feature

1. Connect the USB device to the USB port on the front of the unit.
2. If there is partition Of USB, Press the ▲/▼ button to select the one of partition from USB, then Press OK.



- Press the ▲/▼ or ◀/▶ buttons to select a file in USB. Press **OK** to Open file.



### Note

- Each time the USB button on the remote control is pressed, a frame of the USB device selection will appear.
- "USB" appears on the display screen.
- USB MENU screen appears on the TV screen and the saved file is played.

### Safe USB Removal

To prevent damage to the memory stored in the USB device, perform safe removal before disconnecting the USB cable.

- Press the STOP (■) button
- Remove the USB cable.

### Skip Forward/Back

During playback, press the (◀◀ / ▶▶) button.

- When there is more than one file, when you press the ▶▶ button, the next file is selected.
- When there is more than one file, when you press the ◀◀ button, the previous file is selected.

### Fast playback

To play back the disc at a faster speed, press (◀◀ / ▶▶) during playback.

- Each time you press either button, the playback speed will change as follows:  
2x → 4x → 8x.

### Compatible Devices

- USB devices that support USB Mass Storage v1.0.  
(USB devices that operate as a removable disk in Windows (2000 or later) without additional driver installation.)
- MP3 Player: HDD and flash type MP3 player.
- Digital camera: Cameras that support USB Mass Storage v1.0.
  - Cameras that operate as a removable disk in Windows (2000 or later) without additional driver installation.
- USB HDD and USB Flash Drive: Devices that support USB2.0 or USB1.1.
  - You may experience a difference in playback quality when you connect a USB1.1 device.
  - For a USB HDD, make sure to connect an auxiliary power cord to the USB HDD for proper operation.

- USB card Reader: One slot USB card reader and Multi slot USB card reader

- Depending on the manufacturer, the USB card reader may not be supported.
- If you install multiple memory devices into a multi card reader, you may experience problems.

- If you use a USB extension cable, the USB device might not be recognized.

### Supported Formats

	File name	File Extension	Bit rate	Version	Pixel	Sampling Frequency
Still Picture	JPG	JPG, JPEG	-	-	640*480	-
Music	MP3	.MP3	80-384kbps	-	-	44,1kHz
	WMA	.WMA	56-128kbps	V8	-	44,1kHz
Movie	VCD	MPG, MPEG	1.5Mbps	VCD1.1, VCD2.0	320*480	44,1kHz
	DivX	.AVI, ASF	4Mbps	DivX3, 11-DivX5, 1, Xvid	720*480	44,1kHz-48kHz

- CBI (Control/Bulk/Interrupt) is not supported.
- Digital Cameras that use PTP protocol or require additional program installation when connected to a PC are not supported.
- A device using NTFS file system is not supported.  
(Only FAT 16/32 (File Allocation Table 16/32) file system is supported.)
- Some MP3 players, when connected to this product, may not operate depending on the sector size of their file system.
- The USB HOST function is not supported if a product that transfers media files by its manufacturer-specific program is connected.
- Does not operate with Janus enabled MTP (Media Transfer Protocol) devices.
- The USB host function of this product does not support all USB devices.**

**For information on the supported devices, see page 31.**

## CD Ripping

This feature lets you to copy audio files from disc to USB device into MP3 format.

Open the discs tray.

Place the Audio CD(CD DA) disc on the tray, and close the tray.

Connect the USB device to the USB port on the front of the unit.

This screen will be displayed.



### 1. To Select DISC

With the unit in Stop mode, Press the ▲/▼ buttons to select DISC.

#### To Select DEV (storage media device)

Press the ► button to select the DEV (storage media device) menu, then press the ENTER button.

Press the ▲/▼ buttons to select USB, then press the ENTER button.



- Press the ▲/▼ buttons to select **SELECT**, then press the **ENTER** button to mark all files to be copying.
  - To unmarked copying all files press the **ENTER** button again. (**UNSELECT** Menu)
  - If you want to marked several files to be copying, press the ◀ button, then press the **ENTER** button on the selected file.
- Press the ▲/▼ buttons to select **START**, then press the **ENTER** button. File copy begins.
  - To cancel the copying in progress, press the CANCEL button.



### Note

- When the CD ripping being processed the player will automatic in play mode.
- Only the Audio CD(CD DA) discs can be ripping.
- During the CD Ripping process, do not use/press other button besides the CANCEL button.

## Picture CD Playback

- Select the desired folder.
- Press the ▲/▼ buttons to select a Picture file in the clips menu and then press the **ENTER** button.
- Press the **INFO** button on the remote control to select the menu you want to view and then press the **ENTER** button.



### Note

- Press the STOP button to return to the clips menu.
- When playing a Kodak Picture CD, the unit displays the Photo directly, not the clips menu.

### Rotation



: Each time the **ENTER** button is pressed, the picture rotates 90 degrees clockwise.

### Zoom





: Press the ▲/▼ buttons to select the part of the screen you want to zoom in on. Press the **ENTER** button. Each time the **ENTER** button is pressed, the picture is enlarged up to 2X.

### Slide Show



: The unit enters slide show mode.

- Before beginning the Slide Show, the picture interval must be set.
-  : When this icon is selected and **ENTER** is pressed, the pictures change automatically with about a 6 second interval.
-  : The pictures change automatically with about a 12 second interval.
-  : The pictures change automatically with about a 18 second interval.

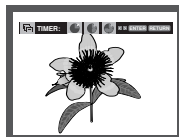

### Note

- Depending on a file size, the amount of time between each picture may be different from the manual.
- If you don't press any button, the slide show will start automatically in about 10 seconds by default.

## CD-R JPEG Discs

- Only files with the ".jpg" and ".JPG" extensions can be played.
- If the disc is not closed, it will take longer to start playing and not all of the recorded files may be played.
- Only CD-R discs with JPEG files in ISO 9660 or Joliet format can be played.
- The name of the JPEG file may not be longer than 8 characters and should contain no blank spaces or special characters (. / = +).
- Only a consecutively written multi-session disc can be played. If there is a blank segment in the multi-session disc, the disc can be played only up to the blank segment.
- A maximum of 3000 images can be stored on a single CD.
- Kodak Picture CDs are recommended.
- When playing a Kodak Picture CD, only the JPEG files in the pictures folder can be played.
- Kodak Picture CD: The JPEG files in the pictures folder can be played automatically.
- Konica Picture CD: If you want to see the Picture, select the JPEG files in the clips menu.
- Fuji Picture CD: If you want to see the Picture, select the JPEG files in the clips menu.
- QSS Picture CD: The unit may not play QSS Picture CD.
- If the number of files in 1 Disc is over 500, only 500 JPEG files can be played.
- If the number of folders in 1 Disc is over 500, only JPEG files in 500 folders can be played

# KARAOKE FUNCTIONS

## Karaoke Functions

### Operation Sequence

1. Connect the Mixed Audio Out terminals with the TV or Amplifier. (see page 9 to 13)
2. Connect Mic into Mic jack. When a MIC is connected, the karaoke functions can be used.

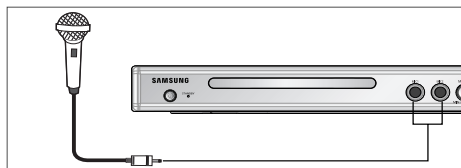

### Key Control

1. Playback the Karaoke Disc containing the wanted songs. Press the **KARAOKE** button.
2. Press the ◀/▶ buttons to change the desired tone.

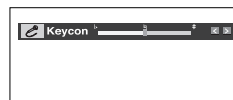

### Note

- If you hear feedback(squealing or howling) while using the karaoke feature, move the microphone away from the speakers or turn down the microphone volume or the speaker volume.
- When playing MP3, WMA, DTS and LPCM disc, the karaoke functions will not operate.
- When the MIC is connected, Digital Out does not work.
- If the MIC is connected in VCD 2.0, Playback is selected to Menu off mode automatically.
- The MIC sound outputs only from Analog Audio Out.
- When microphone is inserted, then there will be no digital audio output through coaxial.



# CHANGING SETUP MENU

## Using the Setup Menu

The Setup menu lets you customize your DVD player by allowing you to select various language preferences, set up a parental level, even adjust the player to the type of television screen you have.

1. With the unit in Stop mode, press the **MENU** button on the remote control. Use the **▲/▼** buttons to select Setup, then press the **▶** or **ENTER** button.

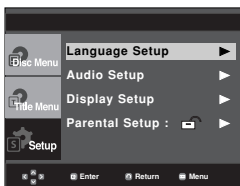

- ① Language Setup: Setup of the Language.
  - ② Audio Setup : Setup of the Audio Options.
  - ③ Display Setup : Setup of the Display Options. Use to select which type of screen you want to watch and several display options.
  - ④ Parental Setup : Setup of the Parental Level. Allows users to set the level necessary to prevent children from viewing unsuitable movies such as those with violence, adult subject matter, etc.
2. Press the **▲/▼** buttons to access the different features. Press the **▶** or **ENTER** button to access the sub features.
  3. To make the setup screen disappear after setting up, press the **MENU** button again.

### Note

Depending on the disc, some Setup Menu selections may not work.

## Setting Up the Language Features

If you set the player menu, disc menu, audio and subtitle language in advance, they will come up automatically every time you watch a movie.

### Using the Player Menu Language

1. With the unit in Stop mode, press the **MENU** button.
2. Press the **▲/▼** buttons to select **Setup**, then press the **▶** or **ENTER** button.
3. Press the **▲/▼** buttons to select **Language Setup**, then press the **▶** or **ENTER** button.
4. Press the **▲/▼** buttons to select **Player Menu**, then press the **▶** or **ENTER** button.
5. Press the **▲/▼** buttons to select the desired language, then press the **▶** or **ENTER** button.
  - The language is selected and the screen returns to Language Setup menu.
  - To make the setup menu disappear, press the **MENU** button.

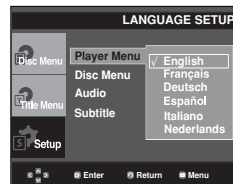

### Using the Disc Menu Language

This function changes the text language only on the disc menu screens.

1. With the unit in Stop mode, press the **MENU** button.
2. Press the **▲/▼** buttons to select **Setup**, then press the **▶** or **ENTER** button.
3. Press the **▲/▼** buttons to select **Language Setup**, then press the **▶** or **ENTER** button.
4. Press the **▲/▼** buttons to select **Disc Menu**, then press the **▶** or **ENTER** button.
5. Press the **▲/▼** buttons to select the desired language, then press the **▶** or **ENTER** button.
  - If the selected language is not recorded on the disc, the original pre-recorded language is selected.
  - The language is selected and the screen returns to Language Setup menu.
  - To make the setup menu disappear, press the **MENU** button.

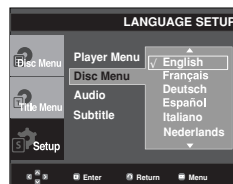

## Using the Audio Language

1. With the unit in Stop mode, press the **MENU** button.
2. Press the **▲/▼** buttons to select **Setup**, then press the **▶** or **ENTER** button.
3. Press the **▲/▼** buttons to select **Language Setup**, then press the **▶** or **ENTER** button.
4. Press the **▲/▼** buttons to select **Audio**, then press the **▶** or **ENTER** button.
5. Press the **▲/▼** buttons to select the desired language, then press the **▶** or **ENTER** button.
  - Select "Original" if you want the default soundtrack language to be the original language the disc is recorded in.
  - If the selected language is not recorded on the disc, the original pre-recorded language is selected.
  - The language is selected and the screen returns to Language Setup menu.
  - To make the setup menu disappear, press the **MENU** button.

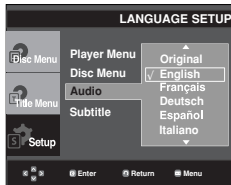

## Using the Subtitle Language

1. With the unit in Stop mode, press the **MENU** button.
2. Press the **▲/▼** buttons to select **Setup**, then press the **▶** or **ENTER** button.
3. Press the **▲/▼** buttons to select **Language Setup**, then press the **▶** or **ENTER** button.
4. Press the **▲/▼** buttons to select **Subtitle**, then press the **▶** or **ENTER** button.
5. Press the **▲/▼** buttons to select the desired language, then press the **▶** or **ENTER** button.
  - Select "Automatic" if you want the subtitle language to be the same as the language selected as the audio language.
  - Some discs may not contain the language you select as your initial language; in that case the disc will use its original language setting.
  - The language is selected and the screen returns to setup menu.
  - To make the setup menu disappear, press the **MENU** button.

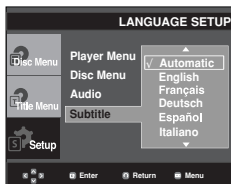

## Setting Up the Audio Options

Audio Options allows you to setup the audio device and sound status settings depending on the audio system in use.

1. With the unit in Stop mode, press the **MENU** button.
2. Press the **▲/▼** buttons to select **Setup**, then press the **▶** or **ENTER** button.
3. Press the **▲/▼** buttons to select **Audio Setup**, then press the **▶** or **ENTER** button.
4. Press the **▲/▼** buttons to select the desired item, then press the **▶** or **ENTER** button.

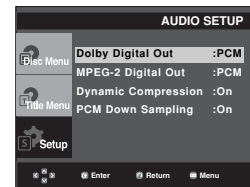

- 1 **Dolby Digital Out**
  - PCM : Converts to PCM(2CH) audio.
  - Bitstream : Outputs Dolby Digital via the digital output. Select Bitstream when connecting to a Dolby Digital Decoder.
- 2 **MPEG-2 Digital Out**
  - PCM : Converts to PCM(2CH) audio.
  - Bitstream : Converts to MPEG-2 Digital Bitstream (5.1CH or 8CH). Select Bitstream when using the Digital Audio Output.
- 3 **Dynamic Compression**
  - On : To select dynamic compression.
  - Off : To select the standard range.
- 4 **PCM Down Sampling**
  - On : Select this when the Amplifier connected to the player is not 96KHz compatible. In this case, the 96KHz signals will be down converted to 48KHz.
  - Off : Select this when the Amplifier connected to the player is 96KHz compatible. In this case, all signals will be output without any changes.

**Note**

- Even when PCM Down sampling is Off
  - Some discs will only output down sampled audio through the digital outputs.
  - To make the Setup menu disappear, press the MENU button.
- There is no analog audio output when you play a DTS sound disc.

Manufactured under license from Dolby Laboratories. "Dolby" and the double-D symbol are trademarks of Dolby Laboratories.

"DTS Digital Out™" is trademarks of Digital Theater Systems, Inc.

## Setting Up the Display Options

Display options enable you to set various video functions of the player.

1. With the unit in Stop mode, press the **MENU** button.
2. Press the **▲/▼** buttons to select **Setup**, then press the **▶** or **ENTER** button.
3. Press the **▲/▼** buttons to select **Display Setup**, then press the **▶** or **ENTER** button.
4. Press the **▲/▼** buttons to select the desired item, then press the **▶** or **ENTER** button.

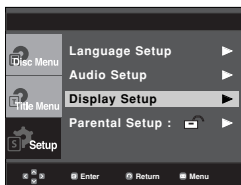
**1 TV Aspect**

Depending on a type of television you have, you may want to adjust the screen setting (aspect ratio).

- 4:3 Letter Box : Select when you want to see the total 16:9 ratio screen DVD supplies, even though you have a TV with a 4:3 ratio screen. Black bars will appear at the top and bottom of the screen.
- 4:3 Pan&Scan : Select this for conventional size TVs when you want to see the central portion of the 16:9 screen. (Extreme left and right side of movie picture will be cut off.)
- 16:9 Wide : You can view the full 16:9 picture on your wide screen TV.

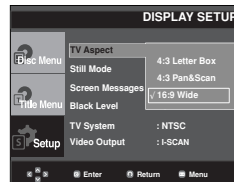
**2 Still Mode**

These options will help prevent picture shake in still mode and display small text clearer.

- Auto : When selecting Auto, Field/Frame mode will be automatically converted.
- Field : Select this feature when the screen shakes in the Auto mode.
- Frame : Select this feature when you want to see small letters more clearly in the Auto mode.

**3 Screen Messages**

Use to turn on-screen messages On or Off.

**4 Black Level**

Adjusts the brightness of the screen.(On or Off) It does not function in Progressive mode.

**5 TV System**

- NTSC : In case of using NTSC disc

- If your TV system only has PAL-Video input, you must choose "PAL". When you choose "PAL", Interlace output format is PAL 60 Hz output.
- If your TV system only has NTSC, input you must choose "NTSC".
- PAL : In case of using PAL disc
- If your TV system only has NTSC-Video input, you must choose "NTSC".
- If your TV system only has PAL input, you must choose "PAL".

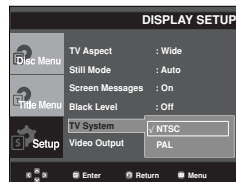

## 6 Video Output

Select Video Output.

- Component (I-SCAN) : Select when you want to use Component Interlace (525i) Out.
- Component (P-SCAN) : Select when you want to use Component Progressive (525p) Out.
- If the Yes/No selection in the Display Setup sub Menu is not made within 10 seconds, the screen returns to the previous menu.

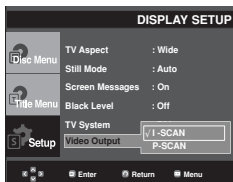

- Consult your TV User's Manual to find out if your TV supports Progressive Scan. If Progressive Scan is supported, follow the TV User's Manual regarding Progressive Scan settings in the TV's menu system.
- If Video Output is set incorrectly, the screen may be blocked.

## Setting Up the Parental Control

The Parental Control function works in conjunction with DVDs that have been assigned a rating, which helps you control the types of DVDs that your family watches. There are up to 8 rating levels on a disc.

### Setting Up the Rating Level

1. With the unit in Stop mode, press the **MENU** button.
2. Press the **▲/▼** buttons to select **Setup**, then press the **▶** or **ENTER** button.

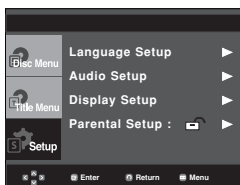

3. Press the **▲/▼** buttons to select **Parental Setup**, then press the **▶** or **ENTER** button.

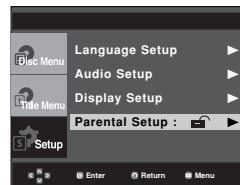

4. Press the **▲/▼** buttons to select **Rating Level**, then press the **▶** or **ENTER** button.

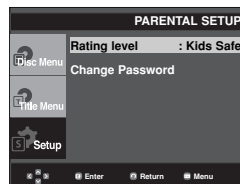

5. Enter your password.
  - By default, password is set to 0000.

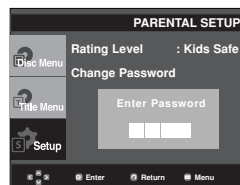

6. Press the **▲/▼** buttons to select the Rating Level you want, then press the **▶** or **ENTER** button.
  - e.g) Setting up in **Kids Safe**.

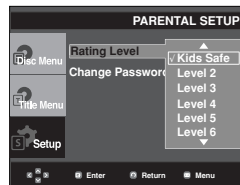

### Note:

- For example, if you select up to Level 6, discs that contain Level 7,8 will not play.
- To make the setup menu disappear, press the **MENU** button.

## Changing the Password

1. With the unit in Stop mode, press the **MENU** button.
2. Press the ▲/▼ buttons to select **Setup**, then press the ► or **ENTER** button.

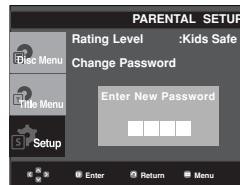
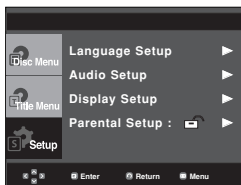

**Note**  
If you have forgotten your password, see "Forgot Password" in the Troubleshooting Guide.

3. Press the ▲/▼ buttons to select **Parental Setup**, then press the ► or **ENTER** button.

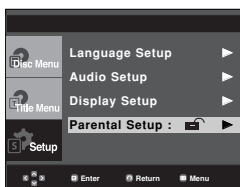

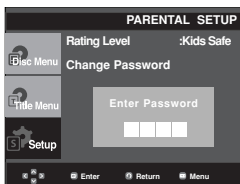
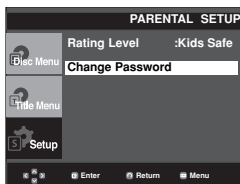

4. Press the ▲/▼ button to select **Change Password**, then press the ► or **ENTER** button. Enter your password (default password). Enter the new password.



# REFERENCE

## Troubleshooting

Before requesting service (troubleshooting), please check the following.

Problem	Action	Page
No operations can be performed with the remote control.	<ul style="list-style-type: none"> <li>• Check the batteries in the remote control. They may need replacing.</li> <li>• Operate the remote control at a distance of no more than 20 feet.</li> <li>• Remove batteries and hold down one or more buttons for several minutes to drain the microprocessor inside the remote control to reset it. Reinstall batteries and try to operate the remote control again.</li> </ul>	P3
Disc does not play.	<ul style="list-style-type: none"> <li>• Ensure that the disc is installed with the label side facing up.</li> <li>• Check the region number of the DVD.</li> </ul>	P5
5.1 channel sound is not being reproduced.	<ul style="list-style-type: none"> <li>• 5.1 channel sound is reproduced only when the following conditions are met :               <ol style="list-style-type: none"> <li>1) The DVD player is connected with the proper Amplifier</li> <li>2) The disc is recorded with 5.1 channel sound.</li> </ol> </li> <li>• Check whether the disc being played has the "5.1 ch" mark on the outside.</li> <li>• Check if your audio system is connected and working properly.</li> <li>• In SETUP Menu, is the Audio Output set to Bitstream?</li> </ul>	P 12-13 P26~27
The  icon appears on screen.	<ul style="list-style-type: none"> <li>• The features or action cannot be completed at this time because:               <ol style="list-style-type: none"> <li>1. The DVD's software restricts it.</li> <li>2. The DVD's software doesn't support the feature (e.g., angles).</li> <li>3. The feature is not available at the moment.</li> <li>4. You've requested a title or chapter number or search time that is out of range.</li> </ol> </li> </ul>	
Disc Menu doesn't appear.	<ul style="list-style-type: none"> <li>• Check if the disc has a Menu.</li> </ul>	
Play mode differs from the Setup Menu selection.	<ul style="list-style-type: none"> <li>• Some of the functions selected in the Setup Menu may not work properly if the disc is not encoded with the corresponding function.</li> </ul>	P25~29
The screen ratio cannot be changed.	<ul style="list-style-type: none"> <li>• The Screen Ratio is fixed on your DVDs.</li> </ul>	P27~28
No audio.	<ul style="list-style-type: none"> <li>• Make sure you have selected the correct Digital Output in the Audio Options Menu.</li> </ul>	P26~27
The screen is blocked	<ul style="list-style-type: none"> <li>• Press the  button (on front panel) for more than 5 seconds under no disc inside. All settings will revert to the factory settings.</li> </ul>	P14
Forgot password	<ul style="list-style-type: none"> <li>• Press the  button (on front panel) for more than 5 seconds under no disc inside. All settings including the password will revert to the factory settings. Don't use this unless absolutely necessary.</li> </ul>	P28
Other problems.	<ul style="list-style-type: none"> <li>• Go to the contents of the instruction book and find the section that contains the explanations regarding the current problem, and follow the procedure once again.</li> <li>• If the problem still cannot be solved, please contact your nearest authorized service center.</li> </ul>	
The picture is noisy or distorted	<ul style="list-style-type: none"> <li>• Make sure that the disc is not dirty or scratched.</li> <li>• Clean the disc.</li> </ul>	P2

## USB HOST Feature Supported Products

### Digital Camera

Product	Company	Type
Finepix-A340	Fuji	Digital Camera
Finepix-F810	Fuji	Digital Camera
Finepix-F610	Fuji	Digital Camera
Finepix-f450	Fuji	Digital Camera
Finepix S7000	Fuji	Digital Camera
Finepix A310	Fuji	Digital Camera
KD-310Z	Konica	Digital Camera
Finecam SL300R	Kyocera	Digital Camera
Finecam SL400R	Kyocera	Digital Camera
Finecam S5R	Kyocera	Digital Camera
Finecam Xt	Kyocera	Digital Camera
Dimage-Z1	Minolta	Digital Camera
Dimage Z1	Minolta	Digital Camera
Dimage X21	Minolta	Digital Camera
Coolpix4200	Nikon	Digital Camera
Coolpix4300	Nikon	Digital Camera
Coolpix 2200	Nikon	Digital Camera
Coolpix 3500	Nikon	Digital Camera
Coolpix 3700	Nikon	Digital Camera
Coolpix 4100	Nikon	Digital Camera
Coolpix 5200	Nikon	Digital Camera
Stylus 410 digital	Olympus	Digital Camera
300-digital	Olympus	Digital Camera
U300	Olympus	Digital Camera
X-350	Olympus	Digital Camera
C-760	Olympus	Digital Camera
C-5060	Olympus	Digital Camera
X1	Olympus	Digital Camera
U-mini	Olympus	Digital Camera
Lumix-FZ20	Panasonic	Digital Camera
DMC-FX7GD	Panasonic	Digital Camera
Lumix LC33	Panasonic	Digital Camera
LUMIX DMC-F1	Panasonic	Digital Camera
Optio-S40	Pentax	Digital Camera
Optio-S50	Pentax	Digital Camera
Optio 33LF	Pentax	Digital Camera
Optio MX	Pentax	Digital Camera
Digimax-420	Samsung	Digital Camera
Digimax-400	Samsung	Digital Camera
Sora PDR-T30	Toshiba	Digital Camera
Coolpix 5900	Nikon	Digital Camera
Coolpix S1	Nikon	Digital Camera
Coolpix 7600	Nikon	Digital Camera
DMC-FX7	Panasonic	Digital Camera
Dimage Xt	Minolta	Digital Camera
AZ-1	Olympus	Digital Camera

### USB Flash Disk

Product	Company	Type
Cruzer Micro	Sandisk	USB 2.0 USB Flash Drive 128M
Cruzer Mini	Sandisk	USB 2.0 128MB
Cruzer Mini	Sandisk	USB 2.0 256M
SONY Micro Vault	Sony	USB 2.0 64MB
FLEX DRIVE	Serotech	USB 2.0 32MB
AnyDrive	A.L tech	USB 2.0 128MB
XTICK	LG	USB 2.0 128M
Micro Mini	lomega	USB 2.0 128M
iFlash	Imation	USB 2.0 64M
LG	XTICK(M)	USB 2.0 64M
RiDATA	EZDrive	USB 2.0 64M

### MP3 Player

Product	Company	Type
Creative MuVo NX128M	Creative	128 MB MP3 Player
Iriver H320	Iriver	20G HDD MP3 Player
YH-920	Samsung	20G HDD MP3 Player
YP-T7	Samsung	MP3 Player
YP-MT6	Samsung	MP3 Player
YP-T6	Samsung	MP3 Player
YP-53	Samsung	MP3 Player
YP-ST5	Samsung	MP3 Player
YP-T5	Samsung	MP3 Player
YP-60	Samsung	MP3 Player
YP-780	Samsung	MP3 Player
YP-35	Samsung	MP3 Player
YP-55	Samsung	MP3 Player
iAUDIO U2	Cowon	MP3 Player
iAUDIO G3	Cowon	MP3 Player
iAudio M3	Cowon	HDD MP3 Player
SI-M500L	Sharp	256MB MP3 Player
H10	Iriver	MP3 Player
YP-T5 VB	Samsung	MP3 Player
YP-53	Samsung	256MB MP3 Player

### Multi Card Reader

Product	Company	Type
UNICORN	Unicorn	USB 2.0 7 IN 1 CARD READER UC-601R
USB 2.0 Card Reader	Billinton(Taiwan)	USB 2.0 Card Reader for SD/MMC/RS-MMC(3-in-1)

### USB External HDD

Product	Company	Type
CUTIE	Serotech	POCKET HARD DISK DRIVE
MOMOBAY UX-2	Dvico	USB 2.0

## Specifications

General	Power Requirements	AC 110-240 V, 60/50 Hz
	Power Consumption	9 W
	Weight	1.5 Kg
	Dimensions	430mm (W) X 207mm (D) X 37mm (H)
	Operating Temperature Range	+5°C to +35°C
	Operating Humidity Range	10 % to 75 %
Disc	DVD (DIGITAL VERSATILE DISC)	Reading Speed : 3.49 ~ 4.06 m/sec. Approx. Play Time (Single Sided, Single Layer Disc) : 135 min.
	CD : 12Cm (COMPACT DISC)	Reading Speed : 4.8 ~ 5.6 m/sec. Maximum Play Time : 74 min.
	CD : 8Cm (COMPACT DISC)	Reading Speed : 4.8 ~ 5.6 m/sec. Maximum Play Time : 20 min.
	VCD : 12Cm	Reading Speed : 4.8 ~ 5.6 m/sec. Maximum Play Time : 74 min. (Video + Audio)
Video Output	Composite Video	1 channel : 1.0 Vp-p (75 Ω load)
	Component Video	Y : 1.0 Vp-p (75 Ω load) Pr : 0.70 Vp-p (75 Ω load) Pb : 0.70 Vp-p (75 Ω load)
Audio Output	2 Channel	L(1/L), R(2/R)
	*Frequency Response	48 kHz Sampling : 4 Hz to 22 kHz 96 kHz Sampling : 4 Hz to 44 kHz
	*Dynamic Range	100 dB

\*: Nominal specification

- Samsung Electronics Co., Ltd reserves the right to change the specifications without notice.
- Weight and dimensions are approximate.



## Contact SAMSUNG WORLD WIDE

If you have any questions or comments relating to Samsung products, please contact the SAMSUNG customer care center.

Region	Country	Customer Care Center ☎	Web Site
North America	CANADA	1-800-SAMSUNG(726-7864)	www.samsung.com/ca
	MEXICO	01-800-SAMSUNG(726-7864)	www.samsung.com
	U.S.A	1-800-SAMSUNG(726-7864)	www.samsung.com
Latin America	ARGENTINE	0800-333-3733	www.samsung.com/ar
	BRAZIL	0800-124-421 , 4004-0000	www.samsung.com
	CHILE	800-SAMSUNG(726-7864)	www.samsung.com/cl
	NICARAGUA	00-1800-5077267	
	HONDURAS	800-7919267	
	COSTA RICA	0-800-507-7267	www.samsung.com/latin
	ECUADOR	1-800-10-7267	www.samsung.com/latin
	EL SALVADOR	800-6225	www.samsung.com/latin
	GUATEMALA	1-800-299-0013	www.samsung.com/latin
	JAMAICA	1-800-234-7267	www.samsung.com/latin
	PANAMA	800-7267	www.samsung.com/latin
	PUERTO RICO	1-800-682-3180	www.samsung.com/latin
	REP. DOMINICA	1-800-751-2676	www.samsung.com/latin
TRINIDAD & TOBAGO	1-800-SAMSUNG(726-7864)	www.samsung.com/latin	
VENEZUELA	0-800-100-5303	www.samsung.com/latin	
COLOMBIA	01-8000112112	www.samsung.com.co	
Europe	BELGIUM	0032 (0)2 201 24 18	www.samsung.com/be
	CZECH REPUBLIC	844 000 844 Distributor pro Českou republiku: Samsung Zrt., česká organizační složka Vyskočilova 4, 14000 Praha 4	www.samsung.com/cz
	DENMARK	70 70 19 70	www.samsung.com/dk
	FINLAND	030-6227 515	www.samsung.com/fi
	FRANCE	3260 SAMSUNG (€ 0,15/Min), 08 25 08 65 65 (€ 0,15/Min)	www.samsung.com
	GERMANY	01805 - SAMSUNG(726-7864) (€ 0,14/Min)	www.samsung.com
	HUNGARY	06-80-SAMSUNG(726-7864)	www.samsung.com
	ITALIA	800-SAMSUNG(726-7864)	www.samsung.com
	LUXEMBURG	0035 (0)2 261 03 710	www.samsung.com/be
	NETHERLANDS	0900-SAMSUNG(726-7864) (€ 0,10/Min)	www.samsung.com/nl
	NORWAY	815-56 480	www.samsung.com/no
	POLAND	0 801 801 881 , 022-607-93-33	www.samsung.com/pl
	PORTUGAL	80820-SAMSUNG(726-7864)	www.samsung.com/pt
	SLOVAKIA	0800-SAMSUNG(726-7864)	www.samsung.com/sk
	SPAIN	902 10 11 30	www.samsung.com
	SWEDEN	0771-400 200	www.samsung.com/se
	U.K	0845 SAMSUNG (7267864)	www.samsung.com
EIRE	0818 717 100	www.samsung.com/ie	
AUSTRIA	0800-SAMSUNG(726-7864)	www.samsung.com/at	
SWITZERLAND	0800-SAMSUNG(726-7864)	www.samsung.com/ch	
CIS	RUSSIA	8-800-555-55-55	www.samsung.com
	KAZAHSTAN	8-10-800-500-55-500	www.samsung.kz
	UZBEKISTAN	8-10-800-500-55-500	www.samsung.uz
	KYRGYZSTAN	00-800-500-55-500	
	TADJIKISTAN	8-10-800-500-55-500	
	UKRAINE	8-800-502-0000	www.samsung.com
	LITHUANIA	8-800-77777	www.samsung.lt
	LATVIA	800-7267	www.samsung.com/lv
	ESTONIA	800-7267	www.samsung.ee
Asia Pacific	AUSTRALIA	1300 362 603	www.samsung.com
	NEW ZEALAND	0800SAMSUNG(726-7864)	www.samsung.com/nz
	CHINA	800-810-5858 , 010-6475 1880	www.samsung.com
	HONG KONG	3698-4698	www.samsung.com/hk
	INDIA	3030 8282 , 1800 110011	www.samsung.com
	INDONESIA	0800-112-8888	www.samsung.com
	JAPAN	0120-327-527	www.samsung.com/jp
	MALAYSIA	1800-88-9999	www.samsung.com/my
	PHILIPPINES	1800-10-SAMSUNG(726-7864)	www.samsung.com/ph
	SINGAPORE	1800-SAMSUNG(726-7864)	www.samsung.com
	THAILAND	1800-29-3232 , 02-689-3232	www.samsung.com
TAIWAN	0800-329-999	www.samsung.com/tw	
VIETNAM	1 800 588 889	www.samsung.com	
Middle East & Africa	TURKEY	444 77 11	www.samsung.com
	SOUTH AFRICA	0860-SAMSUNG(726-7864)	www.samsung.com
	U.A.E	800-SAMSUNG (726-7864), 8000-4726	www.samsung.com

# Memo

# Memo

# Memo

# Memo



Contact SAMSUNG WORLD WIDE  
If you have any questions or comments relating to Samsung products,  
please contact the SAMSUNG customer care centre.  
1800 10-SAMSUNG (726-7864)/ [www.samsung.com/ph](http://www.samsung.com/ph)