

PYLE®

PLDVD198

OWNER'S MANUAL

Mobile Video System

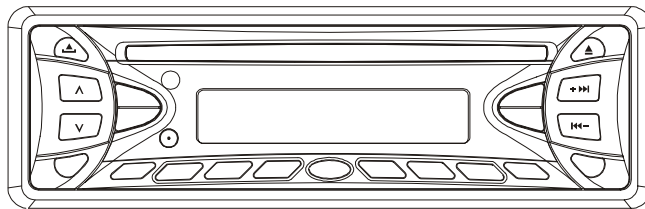
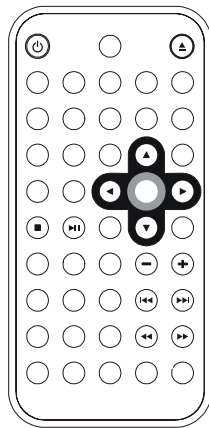

- Digital Audio Out-Coaxial
- PLL Synthesizer Stereo Radio
- DVD Player
- Automatic Memory Storing
- Full Detachable Panel
- Preset Equalization
- Multi-subtitle Languages Function
- Multi-audio Languages Function
- Multi-angle Function
- Parental Control
- Remote Control

www.pyleaudio.com

FEATURES

Compatible with NTSC DVD (Video CD)

This player can play discs recorded in either PAL or NTSC format.

- A single LSI chip now integrates all major DVD playback circuit functions including MPEG2 decoder, video D/A converter, and audio decoders.
- L/R stereo analog audio outputs for connection to existing head unit aux inputs. Video output is composite video.
- Supplied remote handles multi-function software (multi-language audio-track/subtitle, multi-angle, multi-story, etc.), plus all basic functions.

Protect the Disc Mechanism

Avoid inserting any foreign objects into the slot of this player.

Failure to observe this may cause malfunction due to the precise mechanism of this unit.

Use Authorized Service Centres

Do not attempt to disassemble or adjust this precision product. Please refer to the Service Centre list included with this product for service assistance.

For Installation

The unit should be installed in a horizontal position with the front end up at a convenient angle, but not more than 30°.

USE THIS PRODUCT SAFELY

When Driving

Keep the volume level low enough to be aware of road and traffic conditions.

When Car Washing

Do not expose the product to water or excessive moisture. This could cause electrical shorts, fire or other damage.

When Parked

Parking in direct sunlight can produce very high temperatures inside your vehicle. Give the interior a chance to cool down before starting playback.

Use the Proper Power Supply

This product is designed to operate with a 12 volt DC, negative ground battery system (the regular system in a North American car).

CONTENTS

Safety Information	4
Disc Notes	5
Installation	6
Using the Detachable Front Panel	9
Wiring Connection	10
20 Pin Socket Connection	10
Location and Function of Keys	11
The Player	11
Remote Control	12
Remote Control	14
Preparing the Remote Control	14
Loading/ Ejecting a disc	15
Loading a disc	15
Ejecting a Disc	15
Operation	16
Basic Operation	16
Radio Operation	17
Disc (DVD, VCD, CD, MP3) Operation	18
AV IN Operation.....	22
Setup	23
Initial Setup	23
General Setup	23
Audio Setup.....	25
Preferences Setup	26
Defaults Table	28
Trouble Shooting	29
Specifications	30

SAFETY INFORMATION

CAUTION:

MOBILE DVD PLAYER IS A CLASS I LASER PRODUCT. HOWEVER THIS MOBILE DVD PLAYER USES A VISIBLE/INVISIBLE LASER BEAM WHICH COULD CAUSE HAZARDOUS RADIATION EXPOSURE IF DIRECTED. BE SURE TO OPERATE THE MOBILE DVD PLAYER CORRECTLY AS INSTRUCTED. USE OF CONTROLS OR ADJUSTMENTS OR PERFORMANCE OF PROCEDURES OTHER THAN THOSE SPECIFIED HEREIN MAY RESULT IN HAZARDOUS RADIATION EXPOSURE. DO NOT OPEN COVERS AND - DO NOT REPAIR YOURSELF. REFER SERVICING TO QUALIFIED PERSONNEL.

WARNING:

- TO REDUCE THE RISK OF FIRE OR ELECTRIC SHOCK, DO NOT EXPOSE THIS EQUIPMENT TO RAIN OR MOISTURE.
- TO REDUCE THE RISK OF FIRE OR ELECTRIC SHOCK, AND ANNOYING INTERFERENCE, USE ONLY THE RECOMMENDED ACCESSORIES.
- THIS DEVICE IS INTENDED FOR CONTINUOUS OPERATION.

This product incorporates copyright protection technology that is protected by method claims of certain U.S. patents and other intellectual property rights owned by Macrovision Corporation and other rights owners. Use of this copyright protection technology must be authorized by Macrovision Corporation, and is intended for home and other limited viewing uses only unless otherwise authorized by Macrovision Corporation. Reverse engineering or disassembly is prohibited.

REGION MANAGEMENT INFORMATION

Region Management Information:
This Mobile DVD Player is designed and manufactured to respond to the Region Management Information that is recorded on a DVD disc. If the Region number described on the DVD disc does not correspond to the Region number of this Mobile DVD Player, this Mobile DVD Player cannot play this disc.

DISC NOTES

Disc formats supported by this player



DVD
12 cm disc
(Single-sided disc only)



VIDEO CD
12 cm disc



CD
12 cm disc



MP3
12 cm disc

Discs which cannot be played with this player

- DVD-ROM
- DVD-R/DVD-RAM
- CDV
- CD-G

Handling and Cleaning

- Dirt, dust, scratches and warping disc will cause misoperation.
- Do not place stickers or make scratches on discs.
- Do not warp discs.
- A disc should always be kept in its case when not in use to prevent from damaging.
- Do not place discs in the following places:
 1. Direct sunlight
 2. Dirty, dusty and damp areas
 3. Near car heaters
 4. On the seats or dashboard

Disc Cleaning

Use a dry soft cloth to wipe the surface. If the disc is quite dirty, use a soft cloth slightly moistured with isopropyl (rubbing) alcohol. Never use solvents such as benzine, thinner or conventional record cleaners as they may mar the surface of the disc.

Note:

A disc may become somewhat scratched (although not enough to make it

unusable) depending on your handle it and conditions in the usage environment. Note these scratches are not an indication of any problem with the player.

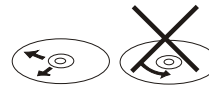
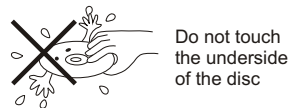
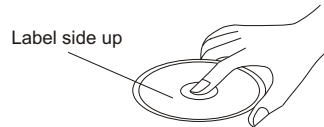

Wipe the disc from center toward the outside edge

Preparing New Discs with Rough Spots

A new disc may have rough edges on its inside and outside edges. If a disc with rough edges is used, the proper setting will not be performed and the player will not play the disc. Therefore, remove the rough edges in advance by using a ball point pen or pencil as shown on the right. To remove the rough edges, press the side of the pen or pencil against the inside and outside edges of the disc.

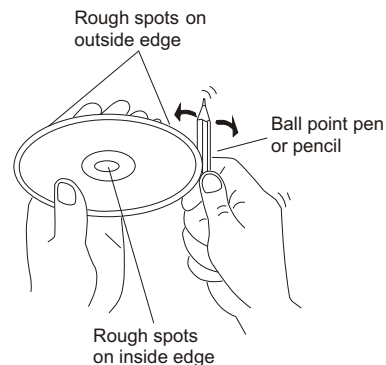

INSTALLATION

Notes:

- Choose the mounting location where the unit will not interfere with the normal driving function of the driver.
- Before finally installing the unit, connect the wiring temporarily and make sure it is all connected up properly and the unit and the system work properly.
- Use only the parts included with the unit to ensure proper installation. The use of unauthorized parts can cause Malfunctions.
- Consult with your nearest dealer if installation requires the drilling of holes or other modifications of the Vehicle.
- Install the unit where it does not get in the driver's way and cannot injure the passenger if there is a sudden stop, like an emergency stop.
- If installation angle exceeds 30° from horizontal, the unit might not give its optimum performance.

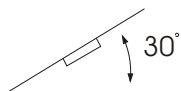

Avoid installing the unit where it would be subject to high temperature, such as from direct sunlight, or from hot air, from the heater, or where it would be subject to dust, dirt or excessive vibration.

DIN FRONT/REAR-MOUNT

This unit can be properly installed either from "Front"(conventional DIN Front-mount) or "Rear"(DIN Rear-mount installation, utilizing threaded screw holes at the sides of the unit chassis). For details, refer to the following illustrated installation methods.

DIN FRONT-MOUNT (Method A) Installation Opening

This unit can be installed in any dashboard having an opening as show below:

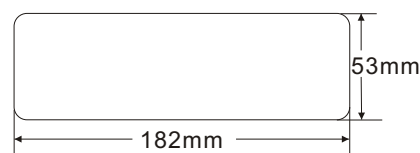

Installing the unit

Be sure you test all connections first, and then follow these steps to install the unit.

1. Make sure the ignition is turned off, and then disconnect the cable from the vehicle battery's negative (-) terminal.
2. Disconnect the wire harness and the Antenna.
3. Press the release button on the front panel and remove the control panel
4. (see the steps of "removing the front panel").
5. Lift the top of the outer trim ring then pull it out to remove it.

The two supplied keys release tabs inside the unit's sleeve so you can remove it. One key is for the right side and the other is for the left side. Insert the keys as far as they will go (with the notches facing up) into the appropriate slots at the middle left and right sides of the unit. Then slide the sleeve off the back of the unit.

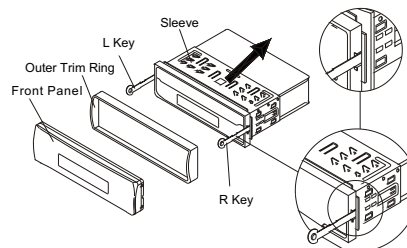

INSTALLATION

6. Mount the sleeve by inserting the sleeve into the opening of the dashboard and bend open the tabs located around the sleeve with a screwdriver. Not all tabs will be able to make contact, so examine which ones will be most effective. Bending open the appropriate tabs behind the dashboard to secure the sleeve in place.

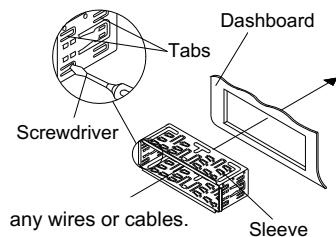

7. Reconnect the wire harness and the antenna and be careful not to pinch any wires or cables.
8. Slide the unit into the sleeve until it locks into place.
9. To further secure the unit, use the supplied metal strap to secure the back of the unit in place. Use the supplied hardware (Hex Nut (M5mm) and Spring Washer) to attach one end of the strap to the mounting bolt on the back of the unit. If necessary, bend the metal strap to fit your vehicle's mounting area. Then use the supplied hardware (Tapping Screw (5x25mm) and Plain Washer) to attach the other end of metal strap to a solid metal part of the vehicle under the dashboard. This strap also helps ensure proper electrical grounding of the unit.

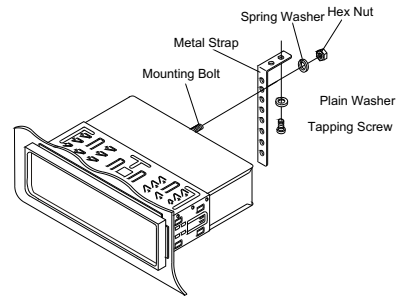

10. Reconnect the cable to the vehicle battery's negative (-) terminal. Then replace the outer trim ring and install the unit's front panel (see the steps of "installing the front panel")

Removing the unit

1. Make sure the ignition is turned off, then disconnect the cable from the vehicle battery's negative (-) terminal.
2. Remove the metal strap attached the back of the unit (if attached).
3. Press the release button to remove the front panel.
4. Lift the top of the outer trim ring then pull it out to remove it.
5. Insert both of the supplied keys into the slots at the middle left and right sides of the unit, then pull the unit out of the dashboard.

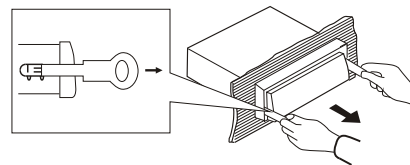

INSTALLATION

DIN REAR-MOUNT (Method B)

If your vehicle is a Nissan, Toyota, follow these mounting instructions.

Use the screw holes marked T (Toyota), N (Nissan) located on both sides of the unit to fasten the unit to the factory radio mounting brackets supplied with your vehicle.

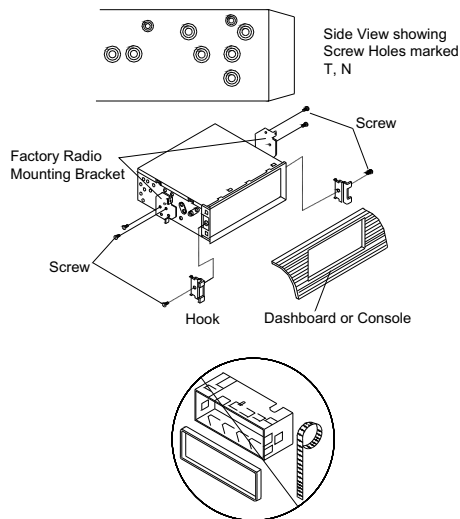

To fasten the unit to the factory radio mounting brackets.

1. Use a screwdriver to loose the hook's screws on the front left and right sides of the unit and remove the hooks.
2. Align the screw holes on the bracket with the screw holes on the unit, and then tighten the screws (5x5mm) on each side.

Note: the outer trim ring, sleeve and the metal strap are not used for method B installation.

USING THE DETACHABLE FRONT PANEL

REMOVING THE FRONT PANEL

1. Press the release button on the front panel and pull off the front panel.

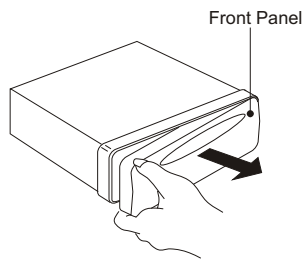
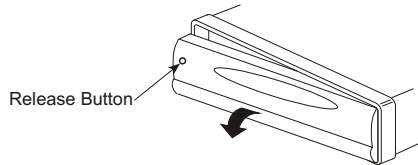

2. Keep front panel into the case.

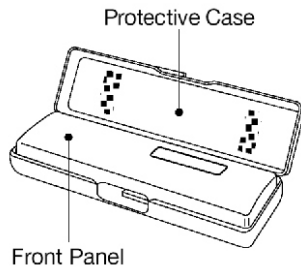

INSTALLING THE FRONT PANEL

To install the front panel, insert the panel into the housing and make sure the panel is properly installed. Otherwise, abnormality occurs on the display or some keys will not function properly.

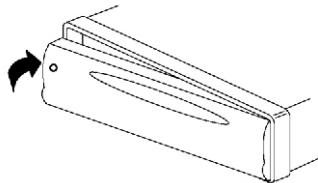

Precautions when handling

1. Do not drop the front panel.
2. Do not put pressure on the display or control buttons when removing or installing the front panel.
3. Do not touch the contacts on the front panel or on the main unit body. It may result in poor electrical contact.
4. If any dirt or foreign substances adhered on the contacts, they can be removed with a clean and dry cloth.
5. Do not expose the front panel to high temperatures or direct sunlight in anywhere.
6. Keep away any volatile agents (e.g. benzene, thinner, or insecticides) from touching the surface of the front panel
7. Do not attempt to disassemble the front panel.

WIRING CONNECTION

20 PIN SOCKET CONNECTION

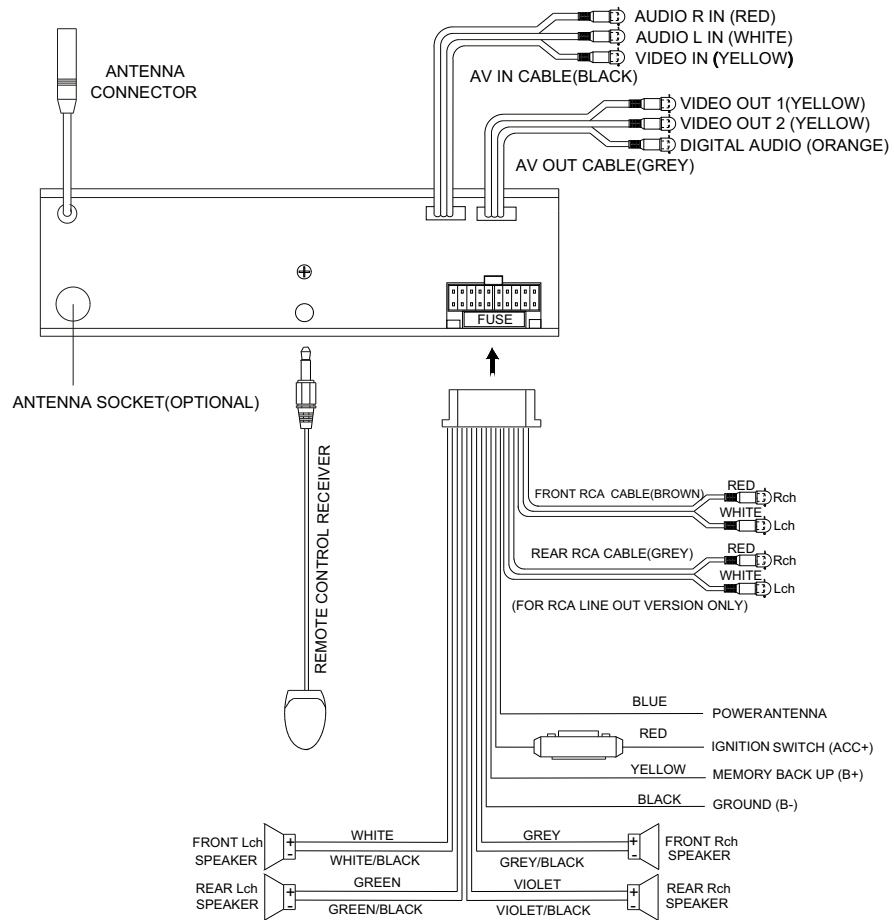

LOCATION AND FUNCTION OF KEYS

THE PLAYER

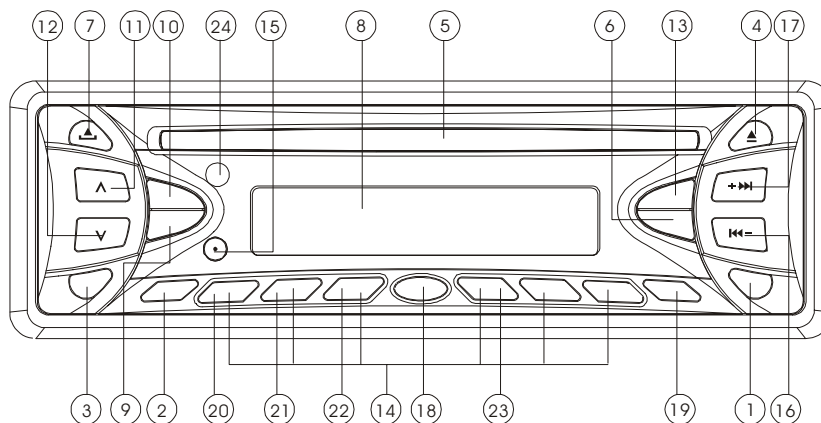

- | | |
|---------------------------|------------------------|
| 1. PWR (power button) | 13. BND/LOU |
| 2. LOC | 14. 1~6 preset buttons |
| 3. MUT | 15. DSP |
| 4. ▲ | 16. MANU/SKIP ◀◀- |
| 5. Disc Slot | 17. MANU/SKIP +▶▶ |
| 6. MODE | 18. AMS ■ |
| 7. ▲ | 19. EQ |
| 8. Liquid Crystal Display | 20. ▶ |
| 9. L/R (ST) | 21. RPT |
| 10. SEL | 22. INT |
| 11. VOL▲ | 23. RDM |
| 12. VOLV | 24. RX |

When remove the front panel:

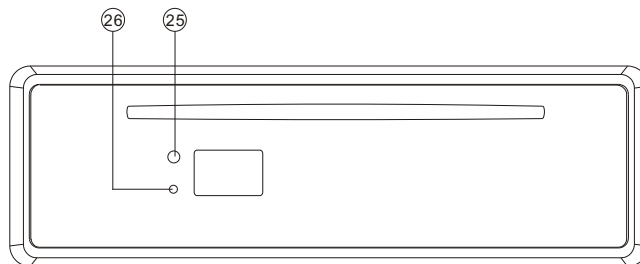

25. LED

26. RESET button

LOCATION AND FUNCTION OF KEYS

REMOTE CONTROL

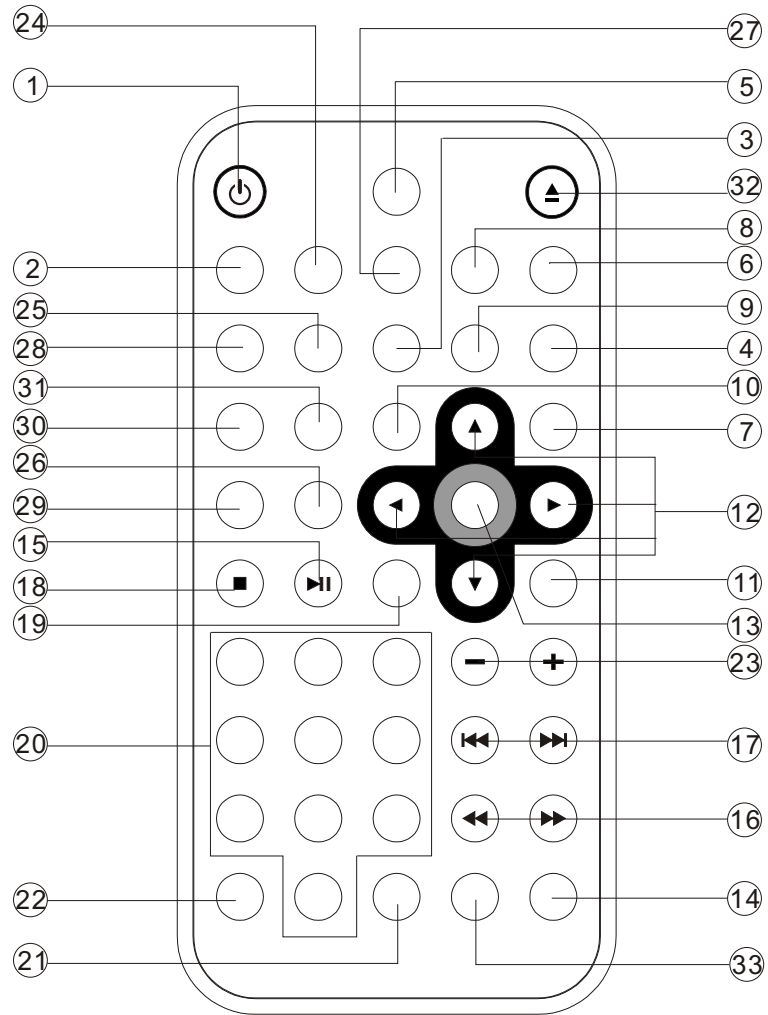

LOCATION AND FUNCTION OF KEYS

1. POWER Press POWER to turn the unit ON or OFF.
2. MUTE Press to mute the sound.
3. SUB-T Changing of the SUBTITLE language on multi-subtitle language DVD disc.
4. ANGLE Changing of the view angle on multi-angle DVD disc.
5. MODE Changing between radio mode, disc (DVD/VCD/CD/MP3) play mode and AV IN mode.
6. DISPLAY Display statistical disc information during playback.
7. SETUP Display the SETUP menu.
8. TITLE Display the TITLE menu that is stored in DVD disc.
9. PROGRAM Allows the track played in the order you programmed (For MP3/CD).
10. PBC (LOC) Changing between PBC ON and PBC OFF on the VCD disc.
In radio mode, press it to select between local and distant stations.
11. SEL Press to select the desired adjustment mode. Then press VOLUME+/- to change settings.
12. ◀/▶, ▲/▼ In case of menu mode, ◀/▶, ▲/▼ buttons served as cursor buttons to select item left/right, ahead/back.
13. OK Confirm the Track/Chapter selected with the numeric buttons or selected with the cursor buttons on screen display.
14. GOTO Disc search button, cooperatively used with numeric buttons.
15. ⏸ Press to play/pause the disc.
16. ⏮/⏭ Press ⏭ to search forward rapidly & ⏮ to search reverse rapidly.
17. ⏩ (SEEK+) Press ⏩ to skip to the next track & press ⏪ to skip back one track.
/⏪ (SEEK-) In radio mode, press ⏩ (SEEK+) shortly to increase frequency or press ⏪ (SEEK-) shortly to decrease frequency by one step of channel spacing. Hold ⏩ (SEEK+)/⏪ (SEEK-) longer for fast tuning.
18. ■ Press it to stop playback.
19. EQ Press it to select the equalization mode, such as CLAS, POP, ROCK.
20. 0-9 Numeric buttons
21. 10+ Digital selecting button cooperatively used with numeric buttons.
22. MENU Display the root menu that is stored on the DVD disc.
23. VOLUME+/- Press VOLUME+/- button to increase or decrease the volume level.
24. ZOOM Allows the picture to be increased in size.
25. RESUME When in stop mode, press the button, the play can be resumed from the stop point.
26. LOUD Press to reinforce the bass output. Press it again to release this function.
27. P/N Switch between PAL mode and NTSC mode.
28. RANDOM Allows the track played in random order (NOT for DVD).
29. ST(AUDIO) In radio mode, press it to select mono or stereo mode.
Changing of the AUDIO soundtrack on multi-audio soundtrack DVD disc.
Changing of the sound mode of the VCD/CD discs.
30. RPT(AMS) Switch the Repeat mode of discs.
In radio mode, press for several seconds to enter into automatic memory storing function; press shortly to scan preset station.
31. A-B (BAND) A-B repeat allows a passage to be repeated continuously.
In radio mode, press it to select desired band.
32. EJECT Press to eject the disc.
33. SLOW Changing for slow forward playback motion (For VCD/DVD).

REMOTE CONTROL

Preparing the Remote Control

Inserting the Batteries

1. Open the battery compartment cover.
2. Insert the new battery. Make sure that the positive and negative terminals of the battery are oriented as indicated.
3. Close the cover.
 - Battery: a button cell lithium battery (CR2025 3V)

Using the Remote Control

Point the remote control towards the player front face remote sensor **RX** (remote control signal receiver). Operation angle: About ± 30 degree in each the direction of the front of the remote sensor.

LOADING/EJECTING A DISC

Loading a Disc

When all connections have completed, you can load a disc as follows:

1. Turn the ignition on to the accessory position.
2. Press the **PWR** button (1) on the front panel or **POWER** button on the remote control to turn on the unit.
3. Insert the disc with printed side facing up into the disc slot (2).
4. The player will start playback automatically.

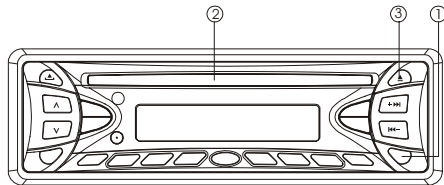

Ejecting a Disc

Press **▲** button (3) on the front panel or to **▲ (EJECT)** button on remote control to eject the disc.

OPERATION

BASIC OPERATION

SWITCHING ON/OFF THE UNIT

Press **PWR** button on the front panel or **POWER** button on the remote control to turn on the unit.

FACEPLATE RELEASE

Press Δ button on the front panel to detach the removable faceplate.

SOUND ADJUSTMENT

Press **SEL** button on the front panel of the unit or on the remote control to select the desired adjustment mode.

The adjustment mode will change in the following order:



By pressing the **VOL Δ /VOL ∇** buttons on the front panel or **VOLUME +/-** buttons on the remote control, it is possible to adjust the desired sound quality.

LOUDNESS

Press and hold **BND/LOU** button on the front panel for several seconds or press **LOUD** button on the remote control to reinforce the bass output. Press **BND/LOU** button on the front panel for several seconds again or press **LOUD** button on the remote control again to release this function.

SET THE CLOCK

Press the **DSP** button on the front panel, the clock is shown on the LCD display. Then hold down the button until the clock flashes. Then press the **VOL ∇** button on the front panel or **VOLUME +** button on the remote control to change hours; press **VOL Δ** button on the front panel or **VOLUME -** button on the remote control to change minutes.

MUTE

Press **MUT** button on the front panel or **MUTE** button on the remote control to mute down the sound instantly. Press it again to resume sound output.

EQUALIZATION

Press **EQ** button shortly to turn on equalization function and to select desired audio mode. There are three kinds of mode as below:



MODE SELECTION

Press **MOD** button on the front panel of the unit or **MODE** button on the remote control to select among radio, disc (DVD/VCD/CD/MP3) play mode and AV IN mode.

LIQUID CRYSTAL DISPLAY

Exhibit current frequency and activated functions on the display of the front panel.

FLASHING LED

If the front panel does not install in the main unit, the LED will be flashing.

REMOTE SENSOR

Point the remote control handset to the remote sensor **RX**. Press the function keys on the handset to control the system.

RESET FUNCTION

RESET button on the housing must be activated with either a ballpoint pen or thin metal object. The **RESET** button is to be activated for the following reasons:

OPERATION

- Initial installation of the unit when all wiring is completed.
- All the function buttons do not operate.
- Error symbol on the display.

Note: if press **RESET** button, the unit can't work yet, please use a cotton swab soaked in isopropyl alcohol to clean the socket on the front panel.

RADIO OPERATION

- **SWITCHING TO RADIO MODE**

Press **MOD** on the front panel or **MODE** on the remote control to select radio mode, the radio mode appears in the display together with the memory band and frequency.

- **SELECTING THE FREQUENCY BAND**

During radio mode, shortly press **BND/LOU** button on the front panel or **A-B (BAND)** button on the remote control to select the desired band. The reception band will change in the following order:

FM1 → FM2 → FM3 → AM1 → AM2

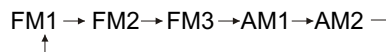

- **SELECTING STATION**

During radio mode, shortly press **MANU/SKIP +>>>** button on the front panel or **>>> (SEEK+)** button on remote control to increase frequency by one step of channel spacing, and shortly press **MANU/SKIP <<<-** on the front panel or **<<< (SEEK-)** button on remote control to decrease frequency by one step of channel spacing. Hold the button longer for fast tuning. The frequency is updated correspondingly on display.

- **LOCAL/DISTANT**

Press **LOC** button on the front panel or **PBC (LOC)** button on the remote

control to select between local and distant stations.

Local setting for reception of strong station, and a distant setting for reception of weaker stations. This function is effect during AUTO SEEK operation.

- **AUTOMATIC MEMORY STORING & PROGRAM SCANNING**

Automatic memory storing

Press **AMS** button on the front panel or **RPT (AMS)** button on the remote control for several seconds, the radio searches from the current frequency and checks the signal strength until one cycle search is finished. And then 6 strongest stations are stored into the corresponding preset number button.

Program scanning

Press **AMS** or **RPT (AMS)** button shortly to scan preset station.

- **STATION STORING**

Press any one of the preset buttons (1 to 6) on the front panel to select a station, which had been stored in the memory. Press this button for several seconds, current station is stored into the number button.

- **MONO/STEREO**

Press **L/R (ST)** button on the front panel or **ST (AUDIO)** button on the remote control to select mono or stereo mode. You can sometimes improve reception of distant stations by selection mono operation.

OPERATION

DISC (DVD/VCD/CD/MP3) OPERATION

STOPPING PLAY

- Briefly press the **■ (Stop)** button to stop the unit playback, when **▶||** button on the front panel or **▶||** button on the remote control is pressed, normal playback will continue.
- Press **■ (Stop)** button twice to stop the playback and go back to initial Track/Chapter.

RAPID FORWARD/RAPID REVERSE

Press **▶▶** & **◀◀** during play.

Each time the button is pressed, the speed of rapid forward /reverse changes according to the disc as follow.

FOR DVD:

Normal playback → 2X → 4X → 6X → 8X

FOR VCD/CD/MP3:

Normal playback → 1X → 2X → 3X → 4X

SKIPPING TRACK

Press **MANU/SKIP +▶▶** / **◀◀** buttons on the front panel or **▶▶** / **◀◀** buttons on the remote control during playback.

Press **+▶▶** or **▶▶** to skip to next track, and **◀◀** or **◀◀** to back one track.

Note: For some VCD2.0 discs (PBC-playback control), **+▶▶** / **◀◀** or **▶▶** / **◀◀** buttons may be unavailable.

SLOW MOTION PLAY

Press **SLOW** button on the remote control during play.

Each time the button is pressed, the speed of slow forward changes according to the disc as follow.

FOR DVD:

Normal playback → 2X → 4X → 8X

FOR VCD:

Normal playback → 1X → 2X → 3X

PAUSING PLAYING

Pressing **▶||** on the remote control or **▶||** on the front panel during playback will stop play temporary. To return to normal playback, press **▶||** or **▶||** once again.

MUTE FUNCTION

Pressing the **MUT** button on the front panel or **MUTE** button on the remote control will mute the sound, but the disc continues playing. When you unmute the sound (press **MUT** or **MUTE** again), sound will resume.

REPEATING PLAYING

FOR DVD:

Press **RPT** button on the front panel or on the remote control to select repeat mode as follow:

CHAPTER REPEAT ON → TITLE REPEAT ON
↑ REPEAT OFF ←

FOR VCD/CD:

Press **RPT** button to select repeat mode as follow.

REP-ONE → REPEAT OFF

1. Continuously repeat the current chapter/track, when REP-ONE mode is selected.
2. When the player finishes playback of the current disc last chapter/track, it will stop and display the elapsed time. When REPEAT OFF mode is selected, REP-ONE disappears from screen display.
3. REPEAT feature does not support VCD2.0 (with PBC ON).

OPERATION

REPEATING PLAYING A PASSAGE

A-B repeat allows a passage to be repeated continuously. Press **A-B** button on the remote control at the start of the required passage, then press **A-B** button again at the end of the passage. To revert to normal playing, press **A-B** button again. Each time the button is pressed, the screen will display as follows:

A TO B SET A→A TO B SET B→A TO B CANCELLED

TIME SEARCH (GOTO)

FOR DVD

Press **GOTO** button twice, the screen will display the following message:

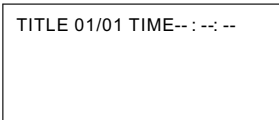

TITLE 01/01 TIME--:--:--

You can select the item you want to watch through TIME setting by using numeric buttons and **OK** button on the remote control.

FOR CD/VCD (WITH PBC OFF):

Press **GOTO** button once, the screen will display the following message:



GO TO --:--

Use numeric buttons to input the time directly.

ZOOM FUNCTION

Allows the picture to be increased in size. Press **ZOOM** button on the remote control to toggle among 1.5 scale, 2.0 scale and 3.0 scale. During Zoom mode, press **◀/▶**, **▲/▼** buttons to move pictures left, right, up or down direction.

PLAYING IN RANDOM ORDER (NOT FOR DVD)

In stop and PBC OFF mode, press **RDM**

On the front panel or **RANDOM** button on the remote control, track selection will be made in random order. The display screen will show "RANDOM ON" on the left-top corner. Then press **▶||** button to start RANDOM playback. Press **RDM** or **RANDOM** button again in stop mode, "RANDOM OFF" appears and release the mode.

PLAYING IN PROGRAMMED ORDER

For CD:

In stop mode, press **PROGRAM** button, the screen will display "PROGRAM P00:00". For example: press numeric button 4, "PROGRAM P01:04" appears, it means track 4 will be played first, then press numeric button 6 and "PROGRAM P02:06" appears. Press the different numeric button to select the corresponding track, and then you can program tracks to your need. If you want to complete program setting, press **▶||** button or **OK** button to play tracks in programmed order.

PREVIEWING PLAYING (FOR CD ONLY)

When play a CD, press **INT** button on the front panel to play first several seconds of each track on the current disc. Press again to stop intro and listen to track.

ON-SCREEN DISPLAY FUNCTION

Press the **DISPLAY** button during playback to display the contents of the current disc on the screen.

Example:

FOR DVD:

(1) Press **DISPLAY** for the first time:

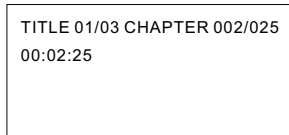

TITLE 01/03 CHAPTER 002/025
00:02:25

OPERATION

Title Number, Total Title Number, Chapter Number, Total Chapter Number of this Title of the disc currently being played will be shown on the screen, along with the elapsed time.

(2) Press **DISPLAY** for the second time:

TITLE REMAIN
01:46:58

(3) Press **DISPLAY** for the third time:

CHAPTER ELAPSED
00:00:24

(4) Press **DISPLAY** for the fourth time:

CHAPTER REMAIN
00:01:39

(5) Press **DISPLAY** for the fifth time:
The message on the screen will be cleared.

FOR VCD:

(1) Press **DISPLAY** for the first time:

SINGLE ELAPSED
00:25 01/13

(2) Press **DISPLAY** for the second time:

SINGLE REMAIN
03:15 01/13

(3) Press **DISPLAY** for the third time:

TOTAL ELAPSED
00:25 01/13

(4) Press **DISPLAY** for the fourth time:

TOTAL REMAIN
40:35 01/13

(5) Press **DISPLAY** for the fifth time:
The message on the screen will be cleared.
FOR CD:

(1) Press **DISPLAY** for the first time:

SINGLE ELAPSED
00:25 01/14

(2) Press **DISPLAY** for the second time:

SINGLE REMAIN
03:15 01/14

(3) Press **DISPLAY** for the third time:

TOTAL ELAPSED
00:25 01/14

(4) Press **DISPLAY** for the fourth time:

TOTAL REMAIN
40:35 01/14

(5) Press **DISPLAY** for the fifth time:
The message on the screen will be cleared.
FOR Mp3:

(1) Press **DISPLAY** for the first time:

CHAPTER ELAPSED 01/18 00:25

OPERATION

(2) Press **DISPLAY** for the second time:

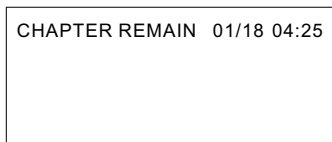

(3) Press **DISPLAY** for the third time:
The message on the screen will be cleared.

MULTI-AUDIO LANGUAGES FUNCTION

For DVD:

Press **L/R (ST)** button on the front panel or **ST (AUDIO)** button on the remote control during playback. Each time the button is pressed, the audio soundtrack language changes on sequential order.

Notes:

- The language number is different according to the disc.
- Some discs only contain one language soundtrack.
- When no different language soundtrack are recorded,  will be displayed at screen left top corner.

For VCD/CD:

Press **L/R (ST)** button on the front panel or **ST (AUDIO)** button on the remote control during playback. It is possible to switch the sound between mono and stereo sound.

MONO LEFT → MONO RIGHT → STEREO

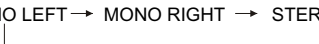
A horizontal sequence of three text labels: "MONO LEFT", "MONO RIGHT", and "STEREO". A right-pointing arrow is positioned between "MONO LEFT" and "MONO RIGHT". Another right-pointing arrow is positioned between "MONO RIGHT" and "STEREO". A bracket is drawn below the "MONO LEFT" and "MONO RIGHT" labels, with a downward-pointing arrow from the center of the bracket.

MENU FUNCTION (For DVD Only)

Press **MENU** button while the disc is playing and the disc root menu will be displayed. You can navigate with the remote control navigation keys and select a feature with the **OK** button on the remote control.

TITLE MENU FUNCTION (For DVD Only)

If the DVD has multiple titles recorded on the disc. It can select preferred title from the title menu to start playback.

1. Press **TITLE** during playback.
 - The title menu is display.
2. Select preferred title by the cursor buttons and confirm by **OK** button on the remote control.

MULTI-SUBTITLE LANGUAGES FUNCTION (For DVD only)

Press **SUB-T** during playback.

Each time the button is pressed, the subtitle language changes in sequential order.

Notes:

- The language number is different according to the disc.
- Some discs only contain one subtitle language.
- When no different subtitle language are recorded,  will be displayed at screen left top corner.

MULTI-ANGLE FUNCTION (For DVD only)

Press **ANGLE** during playback.

Each time the button is pressed, the angle changes in sequential order.

Notes:

- The angle number is different according to the disc.
- The function only works for discs having scenes recorded at different angles.
- When no different angle is recorded,  will be displayed at screen left top corner.

OPERATION

MP3 Disc Play

MP3 disc is playing as the format of FOLDER. For example:

SMART NAVI	
ROOT	
CD01	MP3001 PLUMT
CD02	MP3002 RZID
CD03	MP3003 ASCIS
CD04	MP3004 DCYI
CD05	MP3005 BFZ
PLAY MODE	DISC

In stop mode, use ▲/▼, ◀/▶ on the remote control to select the item or folder (such as CD01, CD02...) and press **OK** button on the remote control to confirm, then select the desired track (such as 001 PLUMT, 002 RZID...) on the current folder to play.

Pressing **RPT** button on the front panel or on the remote control repeatedly can select two kinds of repeat play mode.

REP-ONE: Play the same song over and again.

FOLDER REP: Play all songs in the current directory in sequence, over and again.

Pressing **RDM** on the front panel or **RANDOM** button on the remote control to play tracks in random order. Press **RDM** or **RANDOM** button again to release the mode.

In stop mode, press **PROGRAM** button, "AUTO PLAY" in the menu will change into "PROGRAM P0". For example: first press numeric button 4, "PROGRAM P01:0004" appears on the left-top corner of the screen, it means track 4 will be

played first, then press numeric button 6 and "PROGRAM P02:0006" appears. Press the different numeric button to select the corresponding track, and then press ▶|| button or **OK** button to complete program setting and to play tracks in programmed order. And "PROGRAM P0" changes into "PROGRAM END" on the menu.

When the tracks played in programmed order, press **PROGRAM** button to exit program mode, and "AUTO PLAY" shows in the menu.

During playback, use ▶▶ or ◀◀ to skip an item ahead or back.

◀◀: Rapid reverse, ▶▶: Rapid advance.

Note: The FOLDER cannot be selected during playing. It can be selected after **■ (Stop) button pressed**.

AV IN OPERATION

When you connect another audio/video system to the unit through the AV IN terminals on the back of the unit, press **MOD** button on the front panel or **MODE** on the remote control to select AV IN mode.

SETUP

INITIAL SETUP

SETUP MENU --- MAIN PAGE

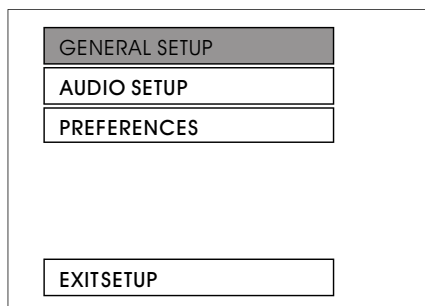

1. Press **SETUP** on the remote control or on the DVD unit in the stop mode. (Press the stop button twice to ensure that the player is in STOP mode.)
2. The initial SETUP menu is displayed.
3. Select the preferred item by using the **▲/▼** buttons.
4. Press **OK** button on the remote control.
 - a/. **GENERAL SETUP**
This setup page includes all the item of TV display & Audio output feature. For details please refer to **GENERAL SETUP MENU**.
 - b/. **AUDIO SETUP**
This setup page includes all the items for AUDIO. Please refer to **AUDIO SETUP MENU**.
 - c/. **PREFERENCES SETUP**
This setup page includes all the configuration of support feature. For details please refer to **PREFERENCES SETUP MENU**.

GENERAL SETUP

-- GENERAL PAGE --

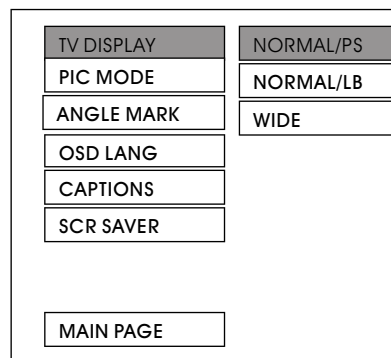

Video Material	TV Screen		
	4:3		Wide (16:9)
	Normal	Pan Scan	Letter-box
4:3			
16:9			

TV display setup

This is to select the appropriate TV aspect ratio (4:3 or 16:9) according to the connected TV set.

Normal/PS (For 4:3 TV)

Played back in the PAN & SCAN style. (If connected to wide-screen TV, the left and right edges are cut off.)

Normal/LB (For 4:3 TV)

Played back in letterbox style. (If connected to wide-screen TV, black bands appear at top and bottom of the screen.)

Wide (For 16:9 TV)

Select when a wide-screen TV set is connected.

SETUP

-- GENERAL PAGE --

TV DISPLAY	
PIC MODE	AUTO
ANGLE MARK	HI-RES
OSD LANG	N-FLICKER
CAPTIONS	
SCR SAVER	
MAIN PAGE	

PIC mode setup

Select AUTO, the player PIC mode will depend on DVD disc.

Select HI-RES format for best image resolution.

Select N-FLICKER format on image or picture with noise or distortion.

-- GENERAL PAGE --

TV DISPLAY	
PIC MODE	
ANGLE MARK	
OSD LANG	ENGLISH
CAPTIONS	FRENCH
SCR SAVER	GERMAN
	SPANISH
MAIN PAGE	

OSD LANG type setup

Select the preferred OSD (On Screen Display) language by using the ▲/▼ buttons.

-- GENERAL PAGE --

TV DISPLAY	
PIC MODE	
ANGLE MARK	ON
OSD LANG	OFF
CAPTIONS	
SCR SAVER	
MAIN PAGE	

ANGLE MARK display setup

If it is set to ON, when the multi-angle DVD disc is playing, “” (the angle mark) will appear on the screen; if it is set to “OFF”, the mark will not appear.

-- GENERAL PAGE --

TV DISPLAY	
PIC MODE	
ANGLE MARK	
OSD LANG	
CAPTIONS	ON
SCR SAVER	OFF
MAIN PAGE	

CAPTIONS setup

When play DVD disc, activate the CAPTIONS feature by selecting ON and the captions (such as the actor dialogue) appear on the screen; deactivate this feature by selecting OFF and the captions will not appear.

SETUP

-- GENERAL PAGE --

TY DISPLAY
PIC MODE
ANGLE MARK
OSD LANG
CAPTIONS
SCR SAVER
ON
OFF
MAIN PAGE

SCR SAVER setup

Select the SCR SAVER ON/OFF.

-- AUDIO SETUP --

SPDIF
OP MODE
DUAL MONO
DYNAMIC
PRO LOGIC
LPCM OUTPUT
LINE OUT
RF REMOD
MAIN PAGE

OP MODE

- LINE OUT: Line out mode, with digital dialog normalization.
- RF REMOD: RF remodulation mode, with heavy compression and digital dialog normalization.

It is recommended to select LINE OUT mode.

AUDIO SETUP

-- AUDIO SETUP --

SPDIF
OP MODE
DUAL MONO
DYNAMIC
PRO LOGIC
LPCM OUTPUT
OFF
ON
MAIN PAGE

SPDIF

This is to activate the digital audio output on or off.

-- AUDIO SETUP --

SPDIF
OP MODE
DUAL MONO
DYNAMIC
PRO LOGIC
LPCM OUTPUT
STEREO
L-MONO
R-MONO
MIX-MONO
MAIN PAGE

DUAL MONO

DUAL MONO reproduction mode, used only when the input consists of two independent audio channels (1/1 mode).

Possible selections are:

- STEREO: Reproduce both channels as is.
- L-MONO: Reproduce the left channel only.
- R-MONO: Reproduce the right channel only.
- MIX-MONO: Mix both channels.

SETUP

-- AUDIO SETUP --

SPDIF	
OP MODE	
DUAL MONO	
DYNAMIC	
PRO LOGIC	
LPCM OUTPUT	
MAIN PAGE	

FULL
6/8
4/8
2/8
OFF

Dynamic range Control

Select DYNAMIC and adjust the dynamic range of a Dolby Digital encoded program. There are 8 steps between full compression and off compression.

-- AUDIO SETUP --

SPDIF	
OP MODE	
DUAL MONO	
DYNAMIC	
PRO LOGIC	
LPCM OUTPUT	
MAIN PAGE	

LPCM 48K
LPCM 96K

LPCM OUTPUT

Select the LPCM (Line Pause Code Modulation) OUTPUT between LPCM 48K and LPCM 96K. The higher the sampling frequency is, the better the output audio quality is. It is recommended to select LPCM 96K.

PREFERENCES SETUP

--PREFERENCES PAGE--

-- AUDIO SETUP --

SPDIF	
OP MODE	
DUAL MONO	
DYNAMIC	
PRO LOGIC	OFF
LPCM OUTPUT	ON
	AUTO
MAIN PAGE	

PRO LOGIC

When select ON, it will convert the 2-channel audio input into 5-channel output. When select OFF, it will cancel this function. When select AUTO, it will depend on the disc.

TV TYPE	AUTO
AUDIO	NTSC
SUBTITLE	PAL
DISC MENU	
PARENTAL	
PASSWORD	
DEFAULTS	
MAIN PAGE	

TV type setup

This player can play discs recorded in either PAL or NTSC format. Select NTSC format, when the unit is connected to NTSC TV. Select PAL format, when the unit is connected to PAL TV. Select AUTO format, the player TV output format will be according to the DVD disc format.

SETUP

--PREFERENCES PAGE--

TV TYPE	
AUDIO	ENGLISH
SUBTITLE	FRENCH
DISC MENU	SPANISH
PARENTAL	CHINESE
PASSWORD	JAPANESE
DEFAULTS	GERMAN
MAIN PAGE	

AUDIO language setup

Select the preferred AUDIO soundtrack by using the cursor buttons.

--PREFERENCES PAGE--

TV TYPE	
AUDIO	
SUBTITLE	
DISC MENU	ENGLISH
PARENTAL	FRENCH
PASSWORD	SPANISH
DEFAULTS	CHINESE
	JAPANESE
	GERMAN
MAIN PAGE	

DISC MENU language setup

Select the preferred DISC MENU language by using the cursor buttons

--PREFERENCES PAGE--

TV TYPE	
AUDIO	
SUBTITLE	ENGLISH
DISC MENU	FRENCH
PARENTAL	SPANISH
PASSWORD	CHINESE
DEFAULTS	JAPANESE
	GERMAN
	OFF
MAIN PAGE	

SUBTITLE language setup

Select the preferred SUBTITLE language by using the cursor buttons.

--PREFERENCES PAGE--

TV TYPE	1 G
AUDIO	2
SUBTITLE	3 PG
DISC MENU	4 PG 13
PARENTAL	5
PASSWORD	6 PG-R
DEFAULTS	7 NC-17
	8 ADULT
	NO-PARENTAL
MAIN PAGE	

PARENTAL

Select suitable parental guidance by the cursor buttons and confirm by pressing OK button on remote control (need to enter password to confirm).

SETUP

--PREFERENCES PAGE--

TV TYPE
AUDIO
SUBTITLE
DISC MENU
PARENTAL
PASSWORD
CHANGE
DEFAULTS
MAIN PAGE

PASSWORD

Select CHANGE and press OK button. Type the old password (The initial factory code is 3308) and key in 4 characters password now you want to use, and retype again to confirm key in correctly.

DEFAULTS TABLE

General Setup	TV display	Normal/PS
	PIC mode	AUTO
	Angle mark	ON
	OSD Language	English
	Captions	OFF
	SCR Saver	OFF
Audio Setup	SPDIF	OFF
	OP Mode	Line Out
	Dual Mono	Stereo
	Dynamic	FULL
	PRO logic	OFF
	LPCM Output	LPCM 48K
Preferences	TV Type	AUTO
	Audio	English
	Subtitle	English
	DISC menu	English
	Parental	6 PG-R
	Password	3308

--PREFERENCES PAGE--

TV TYPE
AUDIO
SUBTITLE
DISC MENU
PARENTAL
PASSWORD
DEFAULTS
RESET
MAIN PAGE

DEFAULTS

Select reset to revert to factory initial settings.

TROUBLE SHOOTING

If it appears that your DVD unit is faulty, first consult this checklist. It may be that something simple has been overlooked.

Under no circumstances should you try to repair the player yourself, as this will invalidate the warranty. Only qualified service personnel can remove the cover or service this player.

NO POWER

- If the power supply is connected to the car accessory circuits, but the engine is not moving, switch the ignition key to "ACC".
- Check if the fuse is blown. Then replace the new fuse.
- Check if the on/off button on the front of the player is set to on.

NO PICTURE

- Check if the monitor or TV is switched on.
- Check if select proper mode, such as Disc Play mode and AV mode.
- Check the video connection.

DISTORTED PICTURE

- Check the disc for fingerprints and clean with soft cloth, wiping from centre to edge.
- Sometimes a small amount of picture distortion may appear. This is not a malfunction.

COMPLETELY DISTORTED PICTURE

- The disc format is not according to the TV-set used (PAL/NTSC).

NO COLOR IN PICTURE

- The disc format is not according to the TV-set used (PAL/NTSC).

DISC DOES NOT PLAY

- Ensure the disc label is upwards.
- Clean the disc.
- Check if the disc is defective by trying another disc.

NO SOUND

- Check audio connections.
- If using a HIFI amplifier, try another sound source.

DISTORTED SOUND FROM HIFI AMPLIFIER

- Check to make sure that no audio connections are made to the amplifier phono input.

THE PLAYER DOES NOT RESPOND TO THE REMOTE CONTROL

- Aim the remote control directly at the sensor on the front of the player.
- Avoid all obstacles which may interfere with the signal path.
- Inspect or replace the remote control battery.

DISTORTED OR B/W PICTURE

- The disc format is not according to the TV-set used (PAL/NTSC).

NO AUDIO AT DIGITAL OUTPUT

- Check the digital connections
- Check the Digital Audio menu to make sure that the digital output is correctly set.
- Check if the audio format of the selected audio language matches your receiver's capabilities.

BUTTONS DO NOT WORK

- Press Reset button on the housing of the DVD unit.

THE RADIO DOES NOT WORK

- Check if the antenna cable is connected firmly.

THE RADIO STATION AUTOMATIC SELECTION DOES NOT WORK

- If the signals are too weak, select a station manually.

SPECIFICATIONS

GENERAL

Power Supply Requirements	: DC 12 Volts, Negative Ground
Chassis Dimensions	: 178 (W) x 160 (D) x 50 (H)
Tone Controls	
Bass (at 100 Hz)	: ± 10 dB
Treble (at 10 kHz)	: ± 10 dB
Maximum Output Power	: 4x40 watts
Current Drain	: 15 Ampere (max.)

CD PLAYER

Signal to Noise Ratio	: More than 55 dB
Channel Separation	: More than 45 dB
Frequency Response	: 20Hz - 20 kHz

RADIO

	FM
Frequency Coverage	87.5 to 107.9 MHz
IF	10.7 MHz
Sensitivity (S/N=30dB)	4 μ V
Stereo Separation	>25dB
	AM
Frequency Coverage	530 to 1710 kHz
IF	450 kHz
Sensitivity (S/N=20dB)	36 dBu

SPECIFICATIONS

Supply voltage:	12V DC (11V-15V), test voltage 14.4V, negative ground
Current consumption:	Less than 2A
Signal system:	Compositive video 1.0Vp-p 75 Ω
Discs played:	(1) DVD-VIDEO disc 5" (12 cm) single-sided, single-layer 5" (12 cm) single-sided, double-layer (2) Compact disc (CD-DA/CD-R/CD-RW/MP3) (3) 5" (12 cm) VIDEO CD
Audio output level:	10k Ω (2 ch 2.0 Vrms)
Power output:	4 x4 0W

Note:

Specifications and design are subject to modification, without notice, due to improvements in technology.

CAUTION:

- To avoid electric shock, this unit must not be exposed to dripping water or water splash.
- Minimum distances around the apparatus for sufficient ventilation.
- The ventilation should not be impeded by covering the ventilation openings with items, such as newspapers, table-cloths, curtains, etc.
- No naked flame sources, such as lighted candles, should be placed on the apparatus.
- The use of apparatus in tropical and/or moderate climates.
- Before scrapping the appliance, remove the batteries and place them in the appropriate battery collection container.

This product incorporates copyright protection technology that is protected by method claims of certain U.S. patents and other intellectual property rights owned by Macrovision Corporation and other rights owners. Use of this copyright protection technology must be authorized by Macrovision Corporation, and is intended for home and other limited viewing uses only unless otherwise authorized by Macrovision Corporation. Reverse engineering or disassembly is prohibited.

www.pyleaudio.com

88-V1005-01