



user manual

DRC275A

IMPORTANT SAFETY INSTRUCTION

WARNING
RISK OF ELECTRIC SHOCK.
DO NOT OPEN



This symbol indicates "dangerous voltage" inside the product that presents a risk of electric shock or personal injury.



This symbol indicates important instructions accompanying the product.

To reduce risk of electrical shock, do not remove cover or back (no user serviceable parts inside). Refer servicing to qualified personnel.

FCC INFORMATION

This equipment has been tested and found to comply with the limits for a Class B digital device, pursuant to Part 15 of the FCC rules. These limits are designed to provide reasonable protection against harmful interference in a residential installation. This equipment generates, uses and can radiate radio frequency energy and, if not installed and used in accordance with the instructions, may cause harmful interference to radio communications. However, there is no guarantee that interference will not occur in a particular installation. If this equipment does cause harmful interference to radio or television reception, which can be determined by turning the equipment off and on, the user is encouraged to try to correct the interference by one or more of the following measures.

- Reorient or relocate the receiving antenna.
- Increase the separation between the equipment and receiver.
- Connect this equipment into an outlet on a circuit different from that to which the receiver is connected.
- Consult the dealer or an experienced radio/TV technician for help.

CAUTION: FCC Regulations state that unauthorized changes or modifications to this equipment may void the user's authority to operate it.

This class B digital apparatus meets all requirements of the Canadian Interference-Causing Equipment Regulations.

The Shock Hazard Marking and Associated Graphical Symbol is provided on the bottom panel of unit.

Refer to the identification/rating label and date code located on the back panel of your product for its proper operating voltage.

CAUTION: This product utilizes a laser. Use of controls or adjustments or performance of procedures other than those specified herein may result in hazardous radiation exposure. Do not open covers and do not repair yourself. Refer servicing to qualified personnel.

CLASS 1 LASER PRODUCT

This product complies with DHHS Rules 21 CFR Subchapter J. Applicable at the date of manufacture.

IMPORTANT: The power cord can be unplugged to turn off the main power to the unit. It should also be easily accessible in an emergency.

- Leave sufficient space around the appliance to allow adequate ventilation: 10cm on either side and at the back, as well as 7cm above it are ideal.

WARNING: To reduce the risk of fire or electric shock, do not expose this apparatus to rain or moisture.



This DVD player has earned the ENERGY STAR.

IMPORTANT SAFETY INSTRUCTION

1. Read these Instructions.
2. Keep these Instructions.
3. Heed all Warnings.
4. Follow all instructions.
5. Do not use this apparatus near water.
6. Clean only with a dry cloth.
7. Do not block any of the ventilation openings. Install in accordance with the manufacturer's instructions.
8. Do not install near any heat sources such as radiators, heat registers, stoves, or other apparatus (including amplifiers) that produce heat.
9. Do not defeat the safety purpose of the polarized or grounding – type plug. A polarized plug has two blades with one wider than the other. A grounding type plug has two blades and a third grounding prong. The wide blade or the third prong are provided for your safety. If the provided plug does not fit into your outlet, consult an electrician for replacement of the obsolete outlet.
10. Protect the power cord from being walked on or pinched particularly at plugs, convenience receptacles, and the point where they exit from the apparatus.
11. Only use attachments/accessories specified by the manufacturer.
12. Use only with a cart, stand, tripod, bracket, or table specified by the manufacturer, or sold with the apparatus. When a cart is used, use caution when moving the cart/apparatus combination to avoid injury from tip-over.
13. Unplug this apparatus during lightning storms or when unused for long periods of time.
14. Refer all servicing to qualified service personnel. Servicing is required when the apparatus has been damaged in anyway, such as power-supply cord or plug is damaged, liquid has been spilled or objects have fallen into the apparatus, the apparatus has been exposed to rain or moisture, does not operate normally, or has been dropped.



Portable Cart Warning

WARNING: The apparatus shall not be exposed to dripping or splashing and that no objects filled with liquid, such as vases, shall be placed on the apparatus.

Product Registration:

Please fill out the product registration card (packed separately) and return it immediately. For U.S. customers: Your RCA Consumer Electronics product may also be registered at www.rca.com/productregistration. Registering this product allows us to contact you if necessary.

Keep your sales receipt to obtain warranty parts and service and for proof of purchase. Attach it here and record the serial and model numbers in case you need them. The numbers are located on the back of the player.

Model number: _____ Serial Number: _____

Purchase date: _____

Dealer address and phone: _____

Basic Connection

DVD + TV

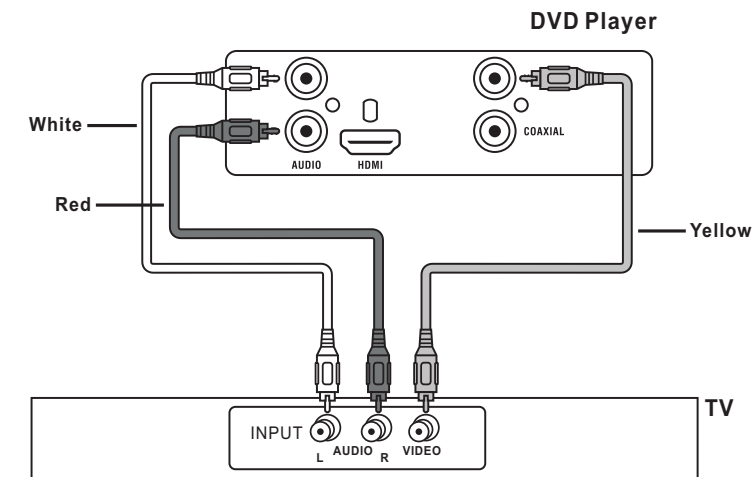

Note: Whenever you are connecting your system cables, turn off the power and make certain that the power cord has been removed from the wall outlet.

1. Connect the audio cables to the AUDIO L and R jacks (red and white) on the back of your DVD player and to the corresponding AUDIO INPUT jacks on your TV.

2. Connect the video Cable.

Basic connection – Connect the video cable to the VIDEO OUT jack (yellow) on the back of the your DVD player, and to the VIDEO INPUT jack on your TV.

Note: If your TV doesn't have Audio and Video Input Jacks and only has an RF jack, you need to connect an RF modulator (not provided).

Basic Connection

Other Connection Options

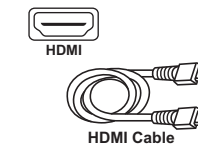

HDMI (High-Definition Multimedia Interface)

The HDMI jack provides optimum picture quality. This jack gives you an uncompressed digital interface that carries both video and audio data by way of an integrated mini-plug cable.

Note: Make sure you set the HDMI Setup option in the menu system to the resolution setting that most closely matches your TV.

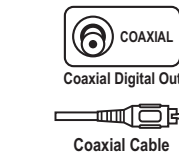

DIGITAL OUT COAXIAL (Audio)

Use the Coaxial Output jack to connect your DVD player to Dolby Digital receiver or decoder. Use the Coaxial cable (not supplied) for the above connection.

Connecting TV with DVI input

Please get a HDMI to DVI cable (not supplied) to connect your DVD player to a TV or monitor with a DVI input jack.

IMPORTANT:

Since DVI connections do not carry audio, you will need to connect the DVD Player's AUDIO jacks to your TV's audio input jacks to hear the audio from the DVD Player.

You can also use the digital coaxial output jack to connect the DVD player to an audio receiver with digital input jack.

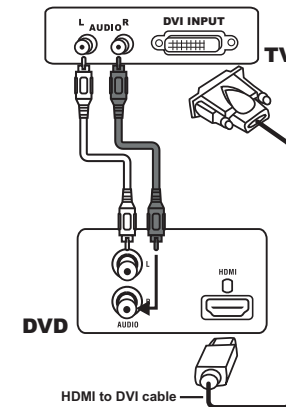

HDMI and High-Definition Multimedia Interface are trademarks or registered trademarks of HDMI Licensing LLC.

Manufactured under license from Dolby Laboratories. "Dolby" and the double-D symbol are trademarks of Dolby Laboratories.

Windows Media and the Windows logo are trademarks or registered trademarks of Microsoft Corporation in the United States and/or other countries.

Playing Discs

Compatible Discs



This DVD Player is capable of playing the following types of discs: DVDs, Audio CDs, Video CDs, CDs and JPEG files on them. Before you put a disc in the player, make sure it is compatible.

You can't play the following types of discs: Laserdiscs, CD-I, CD-ROM (computer-only discs), DVD-ROM, or discs recorded using other broadcast standards (i.e., PAL or SECAM); CD-G discs.

Note: Some discs may not be compatible due to laser pickup, recording formats, and software used. Some technologies and methods used for JPEG file recording on CD-Rs can prevent optimal playback of these files on your DVD player by degrading the quality and/or the ability of the player to read the file.

Front panel Controls

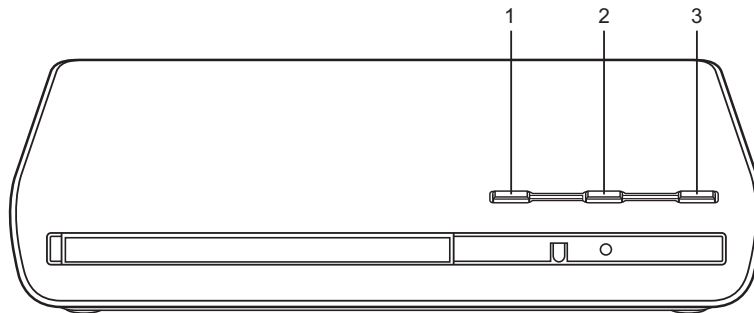

1. **OPEN/CLOSE** – Opens and closes the disc tray.
2. **PLAY/PAUSE** – Starts playing a disc, freezes or unfreezes playback.
3. **ON/STANDBY / STOP** – Press the button to turn on the unit / Press and hold 3 seconds to go to standby mode / Press the button to stop disc playback.

This DVD player is designed and manufactured to respond to the Region Management Information. If the Region number of a DVD disc does not correspond to the Region number of this DVD player, this DVD player cannot play the disc. The Region number for this DVD player is Region No 1.

This product incorporates copyright protected by U.S. patents and other intellectual property rights. Use of this copyright protection technology must be authorized by Macrovision Corporation, and is intended for home and other limited consumer uses only unless otherwise authorized by Macrovision. Reverse engineering or disassembly is prohibited.

Basic Playback Operations

Turn on the DVD Player

1. Plug the power cord into the outlet once the DVD player is connected to your TV.
2. Turn on the TV and tune to its Video Input Channel, if necessary.
3. Press the ON/STANDBY button on the DVD player or the ON/STANDBY button on the remote control to turn it on.
4. Press the OPEN/CLOSE button on the front of the player or remote control to open the disc tray.
5. Place a disc gently into the tray with the disc's label facing up (double-sided discs have content on both sides, so you can place the disc with either side up.)
6. Press OPEN/CLOSE again to close the disc tray. Play starts automatically. If a menu appears, one of its options can be selected to start playing the disc. Highlight it and press ENTER/PLAY ▶.
7. Press STOP to stop playback. The player remembers the point where disc was stopped. If you press PLAY again, playback resumes from this point. To stop playback completely or to start again from the beginning, press STOP twice. If the player is left in STOP mode for more than five minutes without any user interaction, the screen saver is activated.

Picture Scan

While a disc is playing, press FWD or REV repeatedly to scan the disc faster until you reach the fastest scan speed. To resume normal playback, press ENTER/PLAY ▶ or continue to press FWD or REV.

Freeze Frame and Frame Advance

While a disc is playing, press PAUSE/STEP to freeze the picture. To advance one frame at a time, press PAUSE/STEP repeatedly. To resume normal playback, press ENTER/PLAY ▶.

Note: After approximately five minutes in PAUSE with no user interaction, the player goes into screen saver mode.

Slow Motion

While a disc is playing, press PAUSE/STEP. Then press REV or FWD repeatedly to start the slow motion playback and select the slow motion speed until you reach the slowest speed. To resume normal playback, press ENTER/PLAY ▶.

Chapter/Track Advance

While a disc is playing, you can skip forward or backward a chapter or track at a time by pressing ⏪ and ⏩.

Note: Use the numeric buttons to directly access a specific track or chapter number. For single digit tracks or chapters, enter a 0 before single digit numbers; for example, enter 0, then 3 for chapter/track 3.

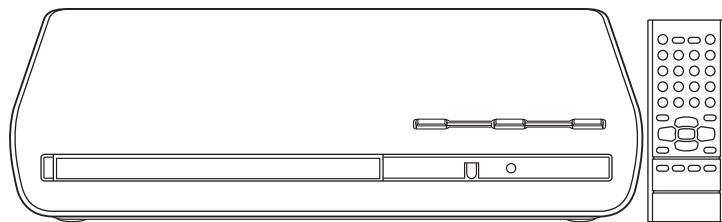

It is important to read this instruction prior to using your new product for the first time.

Remote Control

- ON/STANDBY** ON/OFF function.
- HDMI** Select HDMI output.
- DISPLAY** Shows playback status.
- MUTE** Cuts and restores the volume.
- 0-9** Number entry.
- REPEAT/A-B** Selects the repeat playback mode.
- PAUSE/STEP** Freezes frame, performs frame advance.
- OPEN/CLOSE** Opens and closes the disc tray.
- REV** Searches back through the disc.
- FWD** Searches forward through the disc.
- STOP** Stops playback.
- ANGLE** Selects the camera angle. (if available)
- ZOOM** Accesses the zoom feature. (if available)
- ENTER/PLAY ▶** Selects item highlighted in menu. Starts playing a disc.
- ◀ ▶** Navigates through the menus.
- ⏪ ⏩** Goes to the next/previous chapter or track.
- SEARCH** Goes to a specific play time or track.
- SETUP** Accesses and exits the General setup main menu.
- SUBTITLE** Selects the subtitle language. (if available)
- TITLE** Accesses the title menu of the disc.
- RETURN** Returns to the PBC menu in VCD V.2.0 when PBC is switched on.
- AUDIO** Selects the audio language. (if available)
- DVD MENU** Accesses the disc's menu. (if available)
- PBC** Selects PBC mode for VCD discs.

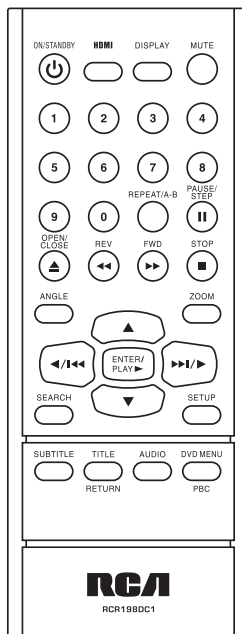

Note: Point remote control unit no more than 6m from the remote sensor and within about 45° of the front of the unit.

Battery installation (Remote Control)

1. Remove the battery cover.
 2. Insert one battery (CR2025) making sure the polarity (+/-) matches the marks inside the unit.
 3. Replace the cover.
- Do not attempt to recharge, short-circuit, disassemble, heat or throw the battery into the fire.

Note: A battery is included in the remote control, remove the protective film before the first time use.

CAUTION: Danger of explosion if battery is incorrectly replaced.

Replace only with the same or equivalent type.

- Dispose of batteries in the proper manner, according to federal, states, and local regulations.
- Dispose of used battery promptly. Keep away from children.
- Do not disassemble and do not dispose of in fire.

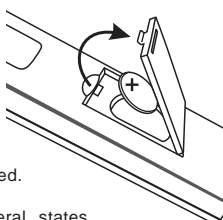

Advanced Playback Operations

Title/Chapter/Time Search

- Press the SEARCH button repeatedly to display a search option:
 - Press once: Title and chapter search
 - Press twice: Title and time search
 - Press three times: Chapter and time search
- Press the ◀ or ▶ button to select a search option and then use the number buttons to enter the desired title, chapter (for title or chapter 5, press "0", "5") or time (hour/minutes/seconds) values. Playback will start immediately from the title, chapter or time you have entered.

Zoom

While a disc is playing, press ZOOM (the player zooms in on the image). Each time you press ZOOM, the picture is magnified even more (until you get to the maximum zoom level). To see other parts of the picture when you've zoomed in on the image, try pressing the ◀, ▶, ▲ and ▼ buttons to go in corresponding directions. This feature is called pan and scan.

Note: Under Zoom function for JPEG file, press ZOOM button once to go to Zoom 1x mode, then press REV or FWD button repeatedly to select the zoom levels. Press ZOOM to quit the zoom mode.

Repeat Playback

While the disc is playing, press the REPEAT/A-B button repeatedly to select a play mode: DVD repeat modes: Title repeat, Chapter repeat, A-B repeat and repeat off.

CD repeat modes: current track repeat, all tracks repeat, A-B repeat and repeat off.

A-B Repeat

To repeat a segment between two points (A and B), press the REPEAT/A-B button three times at the beginning of the segment you want to repeat. Allow the disc to play to the end of the segment or use FWD to advance to the end point (B). Press the REPEAT/A-B button again at the end of the segment. The segment plays repeatedly until you press REPEAT/A-B to resume normal playback.

Audio (Only for DVD, VCD)

Some discs have several audio tracks used for different languages or different audio formats. To change the language or audio format during play, press the AUDIO button one or more times to select one of the available audio formats or languages.

Note: This option is only available if the disc offers a number of languages or formats.

Subtitle

Press the SUBTITLE button to select a subtitle language and to turn the subtitle menu on/off if your subtitle feature is available on the disc.

Display

The Display appears across the top of the screen when you press the DISPLAY button on the remote while playing a disc. Press the DISPLAY button repeatedly to scroll through the playback information.

Menu System

Preferences Setup Menu

The menu gives you options to change some aspects of your DVD player to fit your personal preferences. Preference menu can only be accessed when no disc is played in the disc tray or when the STOP button is pressed twice to enter complete stop mode for this menu access. Press the STOP Button once does not allow this menu access.

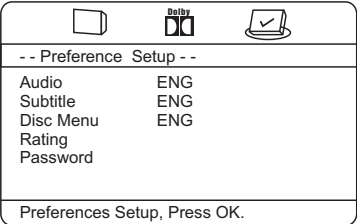

Audio:

Selects the dialogue language: English, French, French, Spanish, German, Italian, Swedish or Portuguese.

Subtitle:

Selects the subtitle language: English, French, Spanish, German, Italian, Swedish, Portuguese or Off.

Disc Menu:

Selects the disc’s menu language: English, French, Spanish, German, Italian, Swedish or Portuguese.

Note: Discs are created differently. The DVD player cannot override some language preferences. If a disc’s software was created to play the movie (title) in a preferred language, the preference you set might be ignored. Also, if the language is not available on the disc you are playing the disc’s default language will be chosen. If the disc was not created with subtitles, you won’t be able to use the Subtitle feature.

Ratings (Parental Control)

You determine the types of discs played and what types require a password to override the rating limit. Ratings are ranked from Level 1 to 8. Level 1 is least offensive material and Level 8 is the most offensive. When adjusting Ratings for the first time:

- Press SETUP on the remote control to display the main menu.
- Select the Preferences menu and highlight Ratings. When asked to enter an old password, enter any number.
- Enter your new password; it is saved.
- Select Ratings and select a level.

Note: To enforce Rating Limits, the disc you're playing must contain a rated movie (or title).

Password

Password is not defined until you set it. Should you select a password and then forget it, go to the Troubleshooting section for instructions on resetting.

Note: There is a lock feature on your DVD player if you want to prevent your child from watching DVDs (don't forget to remove the remote control). Follow the directions for locking and unlocking in the Troubleshooting section.

Advanced Playback Operations

Playback Control (PBC)

The Playback Control feature is available only on Video CDs. Press the DVD MENU/PBC button to turn the PBC feature on and off. The Playback Control feature supports the menus of the VCD format similar to a DVD menu.

HDMI

Press the HDMI button repeatedly to select the HDMI output resolution that best matches your TV.

JPEG Files

Playback of JPEG file

JPEG files are image files (make sure they have a resolution of less than 5 megapixels.)

Note: The time taken for the contents of the disc to be displayed varies according to the size and number of JPEG files actually on the disc. If nothing is displayed after a few minutes, it is likely that certain files are too large. In this case, reduce the files’ resolution to less than 5 megapixels and write another disc.

Before inserting a disc, check that it is compatible with the player:

- Open the tray by pressing the OPEN/CLOSE button. Place a disc with the printed side facing up and close the tray. The disc’s contents are displayed.
- Select a folder using the ▲ and ▼ buttons, then press ENTER/PLAY ▶ to see the folder’s contents.
- Select a file using the ▲ and ▼ buttons, then press ENTER/PLAY ▶ to start playback.
- Press the STOP button to stop playback. To go back to the folder list, press the ◀ button in stop mode.

Note: During playback you can use the ⏮ or ⏭ button to go back to the previous file or go on to the next one.

During playback, press ▲ to flip image horizontally and press ▼ to flip image vertically.

Repeat Play Modes

- Press the REPEAT/A-B button repeatedly to select a play mode:
 - Repeat one: repeats the current file until STOP button is pressed.
 - Repeat all: repeats all files in the current folder until STOP is pressed.
- To cancel the repeat playback mode, press the REPEAT/A-B button until "Off" appears on the TV screen.

Troubleshooting

You can correct most problems you have with your product by consulting the Troubleshooting list that follows.

Player won't work or no power

- Try unplugging the AC power cord, wait two minutes, and plug it back in.

The remote control does not work

- Remember to point the remote control at the front of your player (towards the infrared remote sensor). Make sure there are no objects between the remote and the player.
- Maybe the batteries in the remote are weak, dead, or installed incorrectly. Replace the batteries and make sure the polarity of the terminals (+ and -) is correct.
- Operate the remote control at a distance of no more than 20 feet.

Disc won't play

- Insert a disc with the label side facing up.
- Check the type of disc you put into the disc tray. Refer to Compatible Disc section.
- Make sure the regional code of the disc is Region No. 1.

Forgot password

- Open the tray and press DISPLAY, 0,0,0,0,1. Turn off DVD player and then turn it on by pressing the ON/OFF key, or you can unplug the unit, wait a few seconds and plug it in again.

Lock/Unlock DVD player

- To lock player, press SETUP, 0, 0, 0, 8, 3 (an on-screen message, "Key Lock On" is displayed).
- To unlock, press SETUP, 0, 0, 0, 8, 3.

Play starts, but then stops immediately

- The disc is dirty. Clean it.
- Condensation has formed. Allow player to dry out.

Picture format does not match the screen format

- The picture format is adjustable, refer to GENERAL SETUP menu section. Some discs dictate the format, in which case no adjustment is possible.

Picture is distorted

- The disc might be damaged. Try another disc.
- When using FWD or REV buttons, it is normal for some distortion while scanning.
- Make sure you've selected the correct option for VIDEO OUT feature.

Sound problems

- If a TV is used, check whether the sound is muted or turned down low.
- You may need to read just the settings in the AUDIO menu.
- Sound is muted during still, frame advance, or slow-motion play.

Menu System

To access the DVD player menus:

- Press the SETUP button to display the main menu.
- Select a menu icon using the ◀ and ▶ buttons.
- Use the ▲ and ▼ buttons to select one of the options in the menu.
- Press the ▶ button to access the submenu.
- Use the ▲ and ▼ buttons select one of the options in the submenu.
- Press ENTER/PLAY ▶ to confirm your selection. Return to a previous menu using the ◀ button.
- To exit from the player menus, press the SETUP button.

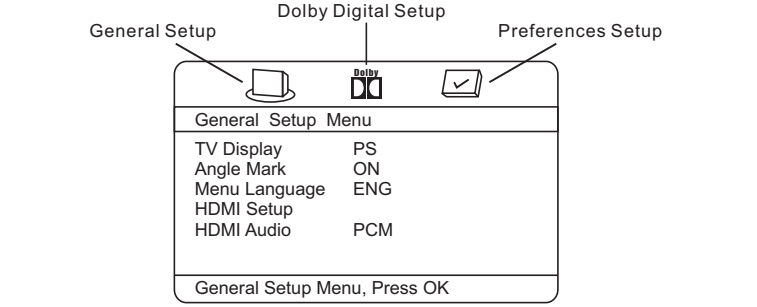

General Setup Menu (shown above)

TV Display

You can choose a display option that affects how a disc’s content appears on your TV screen.

- Normal/PS (4:3 Standard): reproduces a 4:3 picture with some distortion.
- Normal/LB (4:3 Letterbox): gives best reproduction of pictures recorded in this format (i.e., with horizontal bands at the top and bottom of the screen).

- Wide Screen (16:9 Widescreen): reproduces 16:9 format films in full, on a 16:9 screen.

Angle Mark

This only works when the disc you use contains scenes simultaneously shot from multiple angles.

- Select "ON" and the angle mark will appear on the screen when player reaches a scene available in multiple angles.

- Select "OFF" and the angle mark will not appear on the screen when the player reaches a scene shot from multiples.

Troubleshooting

Menu problems

- With a DVD: the disc menus are not displayed in your language. Read the disc jacket to see what languages are available on that disc. Choose one that suits you, if possible.
- With a DVD: there are no subtitles. Read the disc jacket to see if subtitles are available on that disc. Choose subtitles in a language that suits you if possible.
- If the player’s setup menus are not displayed in the language you want, check that your language is among those listed in the MENU LANG menu. If necessary, choose another language.
- To clear a menu from the screen, press ◀ button or repeatedly press SETUP.

The invalid icon (☹) appears on screen

- The action cannot be completed at this time for one of the following reasons: the disc’s software restricts it; the disc’s software doesn’t support that feature (e.g.,angles); the feature is not available at the moment; you’ve requested a title or chapter number that is out of range.

Ratings problems

- If you forget your password, go to "Forget Password" information in this section.
- The default language for dialogues and subtitles may be preset by the DVD.

Limited Warranty (US)

What your warranty covers:

- Defects in materials or workmanship.

For how long after your purchase:

- One year from date of purchase.
- The warranty period for rental units begins with the first rental or 45 days from date of shipment to the rental firm, whichever comes first.

What we will do:

- Provide you with a new, or at our option, a refurbished unit. The exchange unit is under warranty for the remainder of the original product’s warranty period.
- Proof of purchase in the form of a bill of sale or receipted invoice which is evidence that the product is within the warranty period must be presented to obtain warranty service. For rental firms, proof of first rental is also required.

How to make a warranty claim:

- Properly pack your unit. Include any cables, etc., which were originally provided with the product. We recommend using the original carton and packing materials.
- Include evidence of purchase date such as the bill of sale. Also print your name and address and a description of the defect. Send via standard UPS or its equivalent to:

Thomson Inc.
Product Exchange Center
11721 B Alameda Avenue
Socorro, Texas 79927

Menu System

Menu Language

The Menu Lang feature enables you to set the preferred on-screen menu language: English, Spanish, or French.

HDMI Setup

If you are using the DVD player’s HDMI output to connect to your TV, set the HDMI Setup option to the resolution that matches your TV. See the user manual that came with your TV for information on the highest resolution your TV supports.

HDMI Audio

To change the HDMI audio mode. Select "SPDIF" if your TV system is with built-in 5.1 channel digital audio decoder or "PCM" if your TV supports 2 channel digital audio output.

Dobly Digital Setup Menu

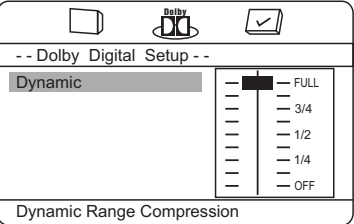

Dynamic

This feature monitors the audio track and controls the different sound levels via dynamic compression. It minimizes sudden volume increases such as when a commercial starts. Select a range using the ▲ and ▼ buttons and press ENTER/PLAY ▶.

Limited Warranty (US)

- Insure your shipment for loss or damage. Thomson accepts no liability in case of damage or loss en route to Thomson.
- Pay any charges billed to you by the Exchange Center for service not covered by the warranty.
- A new or refurbished unit will be shipped to you freight prepaid.

What your warranty does not cover:

- Customer instruction. (Your Owner’s Manual provides information regarding operating Instructions and user controls. For additional information, ask your dealer.)
- Installation and set-up service adjustments.
- Batteries.
- Damage from misuse or neglect.
- Products which have been modified or incorporated into other products.
- Products purchased or serviced outside the USA.
- Acts of nature, such as but not limited to lightning damage.

Product Registration:

- Please complete and mail the Product registration Card packed with your unit. It will make it easier to contact you should it ever be necessary. The return of the card is not required for warranty coverage.

Limitation of Warranty:

- THE WARRANTY STATED ABOVE IS THE ONLY WARRANTY APPLICABLE TO THIS PRODUCT. ALL OTHER WARRANTIES, EXPRESS OR IMPLIED (INCLUDING ALL IMPLIED WARRANTIES OF MERCHANTABILITY OR FITNESS FOR A PARTICULAR PURPOSE) ARE HEREBY DISCLAIMED. NO VERBAL OR WRITTEN INFORMATION GIVEN BY THOMSON INC., ITS AGENTS OR EMPLOYEES SHALL CREATE A GUARANTY OR IN ANY WAY INCREASE THE SCOPE OF THIS WARRANTY.
- REPAIR OR REPLACEMENT AS PROVIDED UNDER THIS WARRANTY IS THE EXCLUSIVE REMEDY OF THE CONSUMER. THOMSON INC. SHALL NOT BE LIABLE FOR INCIDENTAL OR CONSEQUENTIAL DAMAGES RESULTING FROM THE USE OF THIS PRODUCT OR ARISING OUT OF ANY BREACH OF ANY EXPRESS OR IMPLIED WARRANTY ON THIS PRODUCT. THIS DISCLAIMER OF WARRANTIES AND LIMITED WARRANTY ARE GOVERNED BY THE LAWS OF THE STATE OF INDIANA. EXCEPT TO THE EXTENT PROHIBITED BY APPLICABLE LAW, ANY IMPLIED WARRANTY OF MERCHANTABILITY OR FITNESS FOR A PARTICULAR PURPOSE ON THIS PRODUCT IS LIMITED TO THE APPLICABLE WARRANTY PERIOD SET FORTH ABOVE.

How state law relates to this warranty:

- Some states do not allow the exclusion nor limitation of incidental or consequential damages, or limitations on how long an implied warranty lasts, so the above limitations or exclusions may not apply to you.
- This warranty gives you specific legal rights, and you also may have other rights that vary from state to state.

If you purchased your product outside the USA:

- This warranty does not apply. Contact your dealer for warranty information.