

Pioneer

ELITE

FILE-TYPE DVD PLAYER

DV-F07

Operating Instructions



Please read through these operating instructions so you will know how to operate your model properly. After you have finished reading the instructions, put them away in a safe place for future reference.

- This player is not suitable for commercial use.

IMPORTANT



The lightning flash with arrowhead symbol, within an equilateral triangle, is intended to alert the user to the presence of uninsulated "dangerous voltage" within the product's enclosure that may be of sufficient magnitude to constitute a risk of electric shock to persons.



CAUTION:
TO PREVENT THE RISK OF ELECTRIC SHOCK, DO NOT REMOVE COVER (OR BACK). NO USER-SERVICEABLE PARTS INSIDE. REFER SERVICING TO QUALIFIED SERVICE PERSONNEL.



The exclamation point within an equilateral triangle is intended to alert the user to the presence of important operating and maintenance (servicing) instructions in the literature accompanying the appliance.

IMPORTANT SAFETY INSTRUCTIONS

READ INSTRUCTIONS — All the safety and operating instructions should be read before the product is operated.

RETAIN INSTRUCTIONS — The safety and operating instructions should be retained for future reference.

HEED WARNINGS — All warnings on the product and in the operating instructions should be adhered to.

FOLLOW INSTRUCTIONS — All operating and use instructions should be followed.

CLEANING — Unplug this product from the wall outlet before cleaning. The product should be cleaned only with a polishing cloth or a soft dry cloth. Never clean with furniture wax, benzene, insecticides or other volatile liquids since they may corrode the cabinet.

ATTACHMENTS — Do not use attachments not recommended by the product manufacturer as they may cause hazards.

WATER AND MOISTURE — Do not use this product near water — for example, near a bathtub, wash bowl, kitchen sink, or laundry tub; in a wet basement; or near a swimming pool; and the like.

ACCESSORIES — Do not place this product on an unstable cart, stand, tripod, bracket, or table. The product may fall, causing serious injury to a child or adult, and serious damage to the product. Use only with a cart, stand, tripod, bracket, or table recommended by the manufacturer, or sold with the product. Any mounting of the product should follow the manufacturer's instructions, and should use a mounting accessory recommended by the manufacturer.

CART — A product and cart combination should be moved with care. Quick stops, excessive force, and uneven surfaces may cause the product and cart combination to overturn.



VENTILATION — Slots and openings in the cabinet are provided for ventilation and to ensure reliable operation of the product and to protect it from overheating, and these openings must not be blocked or covered. The openings should never be blocked by placing the product on a bed, sofa, rug, or other similar surface. This product should not be placed in a built-in installation such as a bookcase or rack unless proper ventilation is provided or the manufacturer's instructions have been adhered to.

POWER SOURCES — This product should be operated only from the type of power source indicated on the marking label. If you are not sure of the type of power supply to your home, consult your product dealer or local power company.

LOCATION — The appliance should be installed in a stable location.

NONUSE PERIODS — The power cord of the appliance should be unplugged from the outlet when left unused for a long period of time.

GROUNDING OR POLARIZATION

- If this product is equipped with a polarized alternating current line plug (a plug having one blade wider than the other), it will fit into the outlet only one way. This is a safety feature. If you are unable to insert the plug fully into the outlet, try reversing the plug. If the plug should still fail to fit, contact your electrician to replace your obsolete outlet. Do not defeat the safety purpose of the polarized plug.

- If this product is equipped with a three-wire grounding type plug, a plug having a third (grounding) pin, it will only fit into a grounding type power outlet. This is a safety feature. If you are unable to insert the plug into the outlet, contact your electrician to replace your obsolete outlet. Do not defeat the safety purpose of the grounding type plug.

POWER-CORD PROTECTION — Power-supply cords should be routed so that they are not likely to be walked on or pinched by items placed upon or against them, paying particular attention to cords at plugs, convenience receptacles, and the point where they exit from the product.

OUTDOOR ANTENNA GROUNDING — If an outside antenna or cable system is connected to the product, be sure the antenna or cable system is grounded so as to provide some protection against voltage surges and built-up static charges. Article 810 of the National Electrical Code, ANSI/NFPA 70, provides information with regard to proper grounding of the mast and supporting structure, grounding of the lead-in wire to an antenna discharge unit, size of grounding conductors, location of antenna-discharge unit, connection to grounding electrodes, and requirements for the grounding electrode. See Figure A.

LIGHTNING — For added protection for this product during a lightning storm, or when it is left unattended and unused for long periods of time, unplug it from the wall outlet and disconnect the antenna or cable system. This will prevent damage to the product due to lightning and power-line surges.

POWER LINES — An outside antenna system should not be located in the vicinity of overhead power lines or other electric light or power circuits, or where it can fall into such power lines or circuits. When installing an outside antenna system, extreme care should be taken to keep from touching such power lines or circuits as contact with them might be fatal.

OVERLOADING — Do not overload wall outlets, extension cords, or integral convenience receptacles as this can result in a risk of fire or electric shock.

OBJECT AND LIQUID ENTRY — Never push objects of any kind into this product through openings as they may touch dangerous voltage points or short-out parts that could result in a fire or electric shock. Never spill liquid of any kind on the product.

SERVICING — Do not attempt to service this product yourself as opening or removing covers may expose you to dangerous voltage or other hazards. Refer all servicing to qualified service personnel.

DAMAGE REQUIRING SERVICE — Unplug this product from the wall outlet and refer servicing to qualified service personnel under the following conditions:

- When the power-supply cord or plug is damaged.
- If liquid has been spilled, or objects have fallen into the product.
- If the product has been exposed to rain or water.
- If the product does not operate normally by following the operating instructions. Adjust only those controls that are covered by the operating instructions as an improper adjustment of other controls may result in damage and will often require extensive work by a qualified technician to restore the product to its normal operation.
- If the product has been dropped or damaged in any way.
- When the product exhibits a distinct change in performance — this indicates a need for service.

REPLACEMENT PARTS — When replacement parts are required, be sure the service technician has used replacement parts specified by the manufacturer or have the same characteristics as the original part. Unauthorized substitutions may result in fire, electric shock, or other hazards.

SAFETY CHECK — Upon completion of any service or repairs to this product, ask the service technician to perform safety checks to determine that the product is in proper operating condition.

WALL OR CEILING MOUNTING — The product should not be mounted to a wall or ceiling.

HEAT — The product should be situated away from heat sources such as radiators, heat registers, stoves, or other products (including amplifiers) that produce heat.

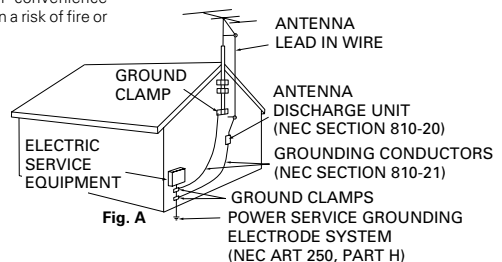

Fig. A

CONGRATULATIONS ON YOUR PURCHASE OF THIS FINE PIONEER PRODUCT.

Pioneer is on the leading edge of DVD research for consumer products and this unit incorporates the latest technological developments.

We are sure you will be fully satisfied with the DVD player.

Thank you for your support.

WARNING: TO PREVENT FIRE OR SHOCK HAZARD, DO NOT EXPOSE THIS APPLIANCE TO RAIN OR MOISTURE.

IMPORTANT NOTICE

[For U.S. and Canadian models]

The serial number for this equipment is located on the rear panel. Please write this serial number on your enclosed warranty card and keep it in a secure area. This is for your security.

CAUTION: This product satisfies FCC regulations when shielded cables and connectors are used to connect the unit to other equipment. To prevent electromagnetic interference with electric appliances such as radios and televisions, use shielded cables and connectors for connections.

This equipment has been tested and found to comply with the limits for a Class B digital device, pursuant to Part 15 of the FCC Rules. These limits are designed to provide reasonable protection against harmful interference in a residential installation. This equipment generates, uses, and can radiate radio frequency energy and, if not installed and used in accordance with the instructions, may cause harmful interference to radio communications. However, there is no guarantee that interference will not occur in a particular installation. If this equipment does cause harmful interference to radio or television reception, which can be determined by turning the equipment off and on, the user is encouraged to try to correct the interference by one or more of the following measures:

- Reorient or relocate the receiving antenna.
- Increase the separation between the equipment and receiver.
- Connect the equipment into an outlet on a circuit different from that to which the receiver is connected.
- Consult the dealer or an experienced radio/TV technician for help.

Information to User

Alteration or modifications carried out without appropriate authorization may invalidate the user's right to operate the equipment.

CAUTION

- Use of controls or adjustments or performance of procedures other than those specified herein may result in hazardous radiation exposure.
- The use of optical instruments with this product will increase eye hazard.

[For Canadian model]

This Class B digital apparatus complies with Canadian ICES-003

[Pour le modèle Canadien]

Cet appareil numérique de la classe B est conforme à la norme NMB-003 du Canada.

[For Canadian model]

CAUTION: TO PREVENT ELECTRIC SHOCK, DO NOT USE THIS (POLARIZED) PLUG WITH AN EXTENSION CORD, RECEPTACLE OR OTHER OUTLET UNLESS THE BLADES CAN BE FULLY INSERTED TO PREVENT BLADE EXPOSURE.





ATTENTION: POUR PREVENIR LES CHOCS ELECTRIQUES NE PAS UTILISER CETTE FICHE POLARISEE AVEC UN PROLONGATEUR, UNE PRISE DE COURANT OU UNE AUTRE SORTIE DE COURANT, SAUF SI LES LAMES PEUVENT ETRE INSEREES A FOND SANS EN LAISSER AUCUNE PARTIE A DECOUVERT.

This product incorporates copyright protection technology that is protected by method claims of certain U.S. patents and other intellectual property rights owned by Macrovision Corporation and other rights owners. Use of this copyright protection technology must be authorized by Macrovision Corporation, and is intended for home and other limited viewing uses only unless otherwise authorized by Macrovision Corporation. Reverse engineering or disassembly is prohibited.

Features of This Player

301 capacity disc changer compatible with DVD Video, Video CD, CD, and CD-R* formats

DVDs, Video CDs, CDs, and CD-Rs that display the logos shown below can be played back on Pioneer DVD players. For more information on discs compatible with this player, refer to the table below.

Types of playable discs and their marks	Diameter/ Playable sides	Playback time
	12 cm (5 in.)/ single-sided	1 layer 2 layer 133 min. 242 min.
	12 cm (5 in.)/ double-sided	1 layer 2 layer 266 min. 484 min.
	12 cm (5 in.)/ single-sided	Digital audio Digital video (MPEG 1) Max. 74 minutes
	VIDEO CD single 8 cm (3 in.)/ single-sided	Digital audio Digital video (MPEG 1) Max. 20 minutes
  	CD 12 cm (5 in.)/ single-sided	Digital audio Max. 74 minutes
	CD single 8 cm (3 in.)/ single-sided	Digital audio Max. 20 minutes

The disc format logos shown above are found on disc labels or on disc jackets.

- To prevent malfunction, be sure to use an adapter when loading 8 cm (3 in.) CDs in the player.
- To prevent malfunction, do not use 8 cm (3 in.) CD adapters with 8 cm (3 in.) DVDs.
- Discs other than the ones indicated above cannot be played on this unit.
- DVDs that have incompatible region numbers cannot be played on this unit. The region number of the player can be found on the rear panel.

- * This unit is capable of playing prerecorded audio CD-R discs.
 - Due to variances in recording processes and disc types as well as minor scratches, dust, fingerprints, or condensation on the disc or pickup lens, playback may not be possible with some discs.
 - If a CD-R disc has not undergone a process called finalization, playback is possible, however other functions such as fast forward and reverse scanning, and track search cannot be performed.
 - Be sure to read the guidelines for using an audio CD-R disc in the documentation supplied with the CD-R disc.

State of the art digital audio and video



Compatible with a wide range of digital audio output formats

The digital audio output jacks of this player can output Dolby Digital*, DTS**, MPEG, and linear PCM digital bitstreams to AV components with built-in decoding capabilities.

Multiple video output formats that can be selected to best suit your TV or monitor

This player features composite, S-video, and component jacks to offer ideal connection possibilities to nearly every type and level of commercially available TV or monitor on the market today.

Hi-bit Legato Link Conversion

The Hi-Bit Legato Link Conversion exceeds traditional digital to analog signal conversion in that it employs the latest in audio technology to digitally restore some of the original integrity of the analog signal, thus producing a signal closer to that of the original.

Digital Noise Reduction (Video Quality Enhancement)

DNR (Digital Noise Reduction) can be used to improve the video image and remove digital noise. Select a preprogrammed setting suited to the program's subject matter, or make manual adjustments to suit your needs or preferences and save them in the player's memory.



TruSurround and Virtual Dolby Digital

TruSurround*** uses technology that simulates multichannel surround sound using only two speakers. Virtual Dolby Digital works in conjunction with Dolby Digital audio sources to create a realistic surround sound. Virtual Dolby Digital is selected automatically when Dolby Digital sources are played.

- * Manufactured under license from Dolby Laboratories. "Dolby" and the double-D symbol are trademarks of Dolby Laboratories. Confidential unpublished works. © 1992-1997 Dolby Laboratories. All rights reserved.
- ** "DTS" is a trademark of Digital Theater Systems, Inc. Manufactured under license from Digital Theater Systems, Inc.
- ***TruSurround and the  symbol are trademarks of SRS Labs, Inc. in the United States and selected foreign countries. TruSurround technology is incorporated under license from SRS Labs, Inc.

New graphical control and disc management

It has never been easier to manage 300 discs than with this player's on-screen graphical control screens. Using the player's Sub Setup screen, you can input titles and artists for the discs loaded in the player, sort them according to number, disc type, title, or artist, organize them into groups, and keep the information updated even if you physically reorganize the discs (page 30).

Organize all of the discs in the rack by inputting disc titles and artist names for easy search and reference.

Disc Type	Title	Artist
1 DVD	Silver Skies	Matt Jones
2 DVD	Someone's Hold	S. Benak
3 VCD	Dance Coll.	Various
4 DVD		
5 CD	Live at Roxyl	Exhibition

Easy text input

This title of a disc and the artist name can be easily input using the remote control or the front panel.

Additionally, you can connect a commercially available PS/2* compatible keyboard or mouse to this player for quicker and more efficient data input and other player functions (page 33).

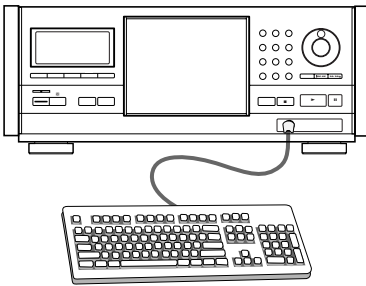

* PS/2 is a registered trademark of IBM corporation.

Connection to another disc changer for increased capacity

This unit can be connected to another DV-F07 unit for combined control of up to 601 discs (page 66).

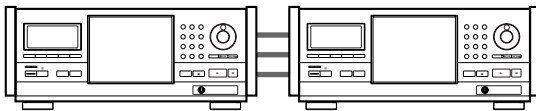

Quick and easy playback with single loader slot

By using the single loader slot, you can quickly load discs, such as rental DVDs, that you may not want to have loaded in the disc rack all of the time. With the touch of a single button, this disc can be called up and played at any time (page 28).

Easy setup and adjustment using on-screen menus

You'll find setting up and adjusting the system easy to do with on-screen menus conveniently organized and arranged. Additionally, on-screen information (Ⓢ) appears to clarify the functions and explain the options available.

Answer a few questions and have all the necessary audio, video, and on-screen language adjustments set automatically by the player using the Setup Navigator (page 20).

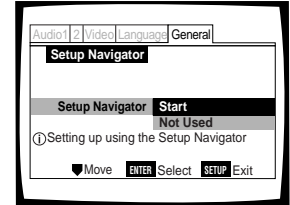

Additionally, you can create a list of menu items that you regularly use with the Function Memory so that they can be easily accessed at any time (page 63).

Variable speed scanning in forward and reverse directions

This player incorporates technology that enables smooth playback of DVDs and Video CDs not only at different speeds but also in both forward and reverse directions. Control the direction and scanning speeds from 1/16 normal play speed to extremely quick scanning using **MULTI DIAL** on the remote control (page 53).

Wide range of DVD viewing options

Multi-Language Subtitles (page 44)★

You can select a subtitle language or turn subtitles off when watching movies or other media with subtitles available.

Multiple Languages (page 45)★

You can select the language when watching movies or other media that have multiple language and/or audio soundtracks recorded on them.

Multi-Angle (page 54)★

You can view scenes from different camera angles when watching movies or other media with multiple angle playback available.

★This mark indicates this may not be possible with certain discs.

Energy-saving design

This unit is designed to use less than 0.9 W of energy when this player is in standby mode.

Differences in Disc Composition

DVD

DVDs are divided into units referred to as titles, and titles are divided into chapters. A DVD which contains a movie may have only one title with many or no chapter divisions. Karaoke DVDs may have many titles, assigning a title to each song on the DVD. Menu screens do not belong to any title.

DVD player functions generally apply to titles on a DVD or chapters within a selected title. The player functions available may also vary from title to title, depending on the DVD. When DVDs have a unique title division, it should be noted that search and program functions may be affected.

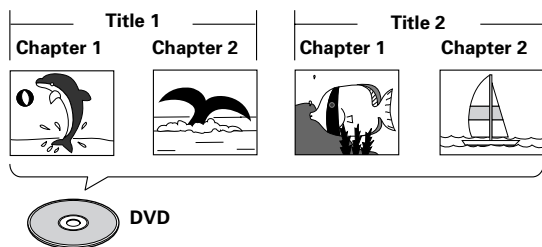

Video CD/CD

Video CDs and CDs are divided into units referred to as tracks (Video CD tracks may also be referred to as scenes). One song generally corresponds to one track. Some tracks are further divided into units referred to as indexes. Video CDs with PBC (Playback Control) also contain menus recorded on the disc which enable easy access to the contents of the disc.

When played back on a DVD player, both Video CDs and CDs are considered to be a single title, regardless of the number of tracks.

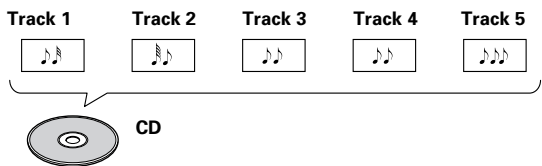
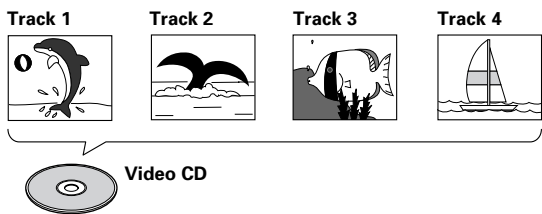

How to Proceed in This Manual

DVD is an incredible format that presents the highest quality digital audio and video available today. Because using the DVD player and DVDs may be confusing at first, following the order below should help you get through the important stages of getting set up so you can start using your player as soon as possible.

Get familiar with the player.

Refer to the section "Before Using" on page 8 to confirm that all the accessories were included with the player. If you are new to DVD, it might be beneficial for you to go through the "Names and Functions" section starting on page 9 to get familiar with the parts and buttons on the main unit and remote control.

There is also a list of terms that can be found on page 76 if you are having trouble understanding some of the terminology associated with DVD.

Make the necessary connections.

No entertainment system seems to be set up exactly the same way. The "Making Connections" section starting on page 15 shows how video and audio connections may be made to suit your home entertainment system.

Set up the player.

Before you can begin to enjoy the benefits of the DVD format, it is first necessary to set up the player to output the video and audio corresponding to your system. The section "Setting Up the Player" starting on page 20 explains how to use the Setup Navigator, a function that automatically sets up your player. The Setup screen menus, described in the section starting on page 39, are also used in a number of other functions. Learning the procedure for operating these menus will make using this player much easier and more enjoyable.

Load the disc rack and play discs.

When all the connections and setups have been made, you are ready to play your DVDs, Video CDs, and CDs with the player. The section "Getting Started Using Your DVD Player" starting on page 23 outlines the basic player operations.

Organize the discs in the disc rack.

The section "Disc Management" on page 30 helps you manage the discs you have loaded in the rack by making use of the Sub Setup screen menus. By taking advantage of this player's text input and cross-referencing capabilities, it is quick and easy to find the disc you want.

Enjoy the other features available.

Once you are comfortable using the basic player functions, you are ready to take advantage of the various options DVD and this player have to offer. The section "Advanced Functions" starting on page 49 describes a number of functions available with this player.

Table of Contents

Before Using 8

- Checking Accessories 8
- Preparing the Remote Control 8

Names and Functions 9

- Front Panel 9
- Display Window 10
- Remote Control 12
- Rear Panel 14

Making Connections 15

- Connecting Your DVD Player 15
- Audio Connections 17
- Video Connections 18
- CD-Deck Synchro Connections 19
- System Control Connections 19

Setting Up the Player 20

- Using the Setup Navigator 20

Getting Started Using Your DVD Player 23

- Loading DVDs, Video CDs and CDs into the Player 23
- Playing DVDs, Video CDs and CDs 24
- Chapter (Track) Skip Forward/Skip Back 27
- Forward and Reverse Scanning 27
- Playing a Disc That Is Not Loaded in the Rack (Single Loader Play) 28
- Stopping Playback and Switching Power Off 29

Disc Management 30

- Registering Information and Inputting Text for Discs Newly Loaded in the Player 30
- Keeping the Disc Order and Information Updated 31
- Inputting and Changing Text Information 31
- Selecting a Disc On-Screen 35
- Searching for a Disc, Title, Chapter, Track, or Location on a Disc 35
- Creating and Selecting Custom Files 37

Adjusting Audio and Video Settings 39

- Using the Setup Screen Menus 39
- Changing to the Setup Screen "Expert" Menu Mode 40
- Setting the Digital Audio Output To Be Compatible with Your AV Component 41
- Turning the Digital Output On and Off 42
- Adjusting the OSD (On-Screen Display) 42
- Setting the TV Screen Size 43

Setting the Language Options 44

- Selecting a Subtitle Language (Multi-Language Subtitles) 44
- Changing the Audio Language (Multi-Language Function) 45
- Setting Language and Subtitle Preferences in the Setup Screen Menus 46

Advanced Functions 49

- Getting Surround Sound from Stereo Speakers 49
- Adjusting the Dynamic Range of the Audio Soundtrack 49
- Adjusting the Video Quality (Digital Noise Reduction) 50
- Still Frame/Slow Play/Frame Advance Playback 52
- Scanning in Forward and Reverse Directions at Different Speeds 53
- Viewing from a Desired Camera Angle (Multi-Angle) 54
- Repeat Play 55
- Random Play 56
- Playback in a Desired Order (Program Play) 57
- To make an ongoing program of your favorite titles, chapters and tracks (Best play) 59
- Reviewing Previously Played Discs (Previous Scan) 60
- Previewing Discs in the Current Play Mode (Hi-Lite Scan) 60
- Continuing Playback from a Specified Location (Last Memory) 61
- Memorizing Settings for Often Viewed DVDs (Condition Memory) 62
- Memorizing Regularly Used Menu Settings (Function Memory) 63
- Viewing Disc Information 64
- Connecting to Another Player for Control of 601 Discs 66
- Utilizing the Audio-Video Output of Another AV Component 68
- Selecting External Input 68
- Setting the Parental Lock Level 69
- Turning the Screen Saver On and Off 70
- Changing the Background Color of the Screen 70

Additional Information 71

- Disc Care 71
- For Proper and Long Use of This Unit 72
- Language Code List 73
- Troubleshooting 74
- Resetting the Player to System Settings 75
- Terms 76
- Specifications 78

Before Using

Checking Accessories

Please confirm that the following were received with the player.

Audio cord

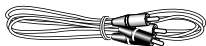

Video cord



Master-Slave control cord



Remote control unit

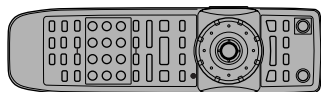

AA/R6P batteries

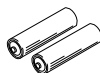

Operating instructions (this manual)

Warranty card

Preparing the Remote Control

Inserting batteries into the remote control

- 1 Push down on the tab on the battery compartment cover, and pull out in the direction indicated by the arrow.

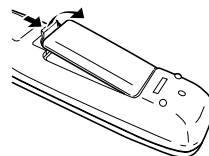

- 2 Insert batteries. Make sure to match the plus (+) and minus (-) polarity guides on the batteries with the marks inside the battery compartment.

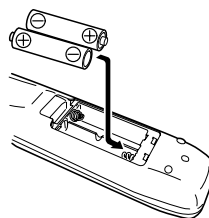

- 3 Close the cover.

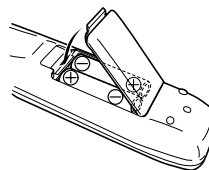

Notes

- Do not mix old and new batteries.
- When replacing batteries, use all new batteries.
- When not using the remote control for a long period of time (over 1 month), remove the batteries to avoid possible damage from battery corrosion. If battery leakage occurs, wipe the battery liquid from the battery component, then insert new batteries.

Remote control operation

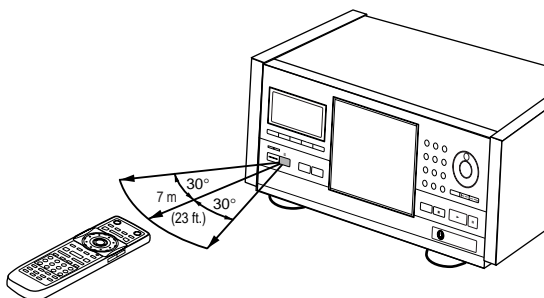

When operating the remote control, point it at the remote sensor (SR) located on the player's front panel. The remote control can be used up to 7 m (23 feet) from the player and within a 30° angle on each side of the sensor.

Notes

- Exposing the remote sensor to direct sunlight or strong light may cause faulty operation.
- When Master-Slave connections are made to another DV-F07 to create a 601-disc changer, only the remote sensor on the first DV-F07 will accept signals from the remote control (page 66).
- If the CONTROL IN jack on the player's rear panel is connected to the CONTROL OUT jack of another component, point the remote control at the other component to operate the player. Operation will not be possible when pointed at this player (page 19).

Names and Functions

Front Panel

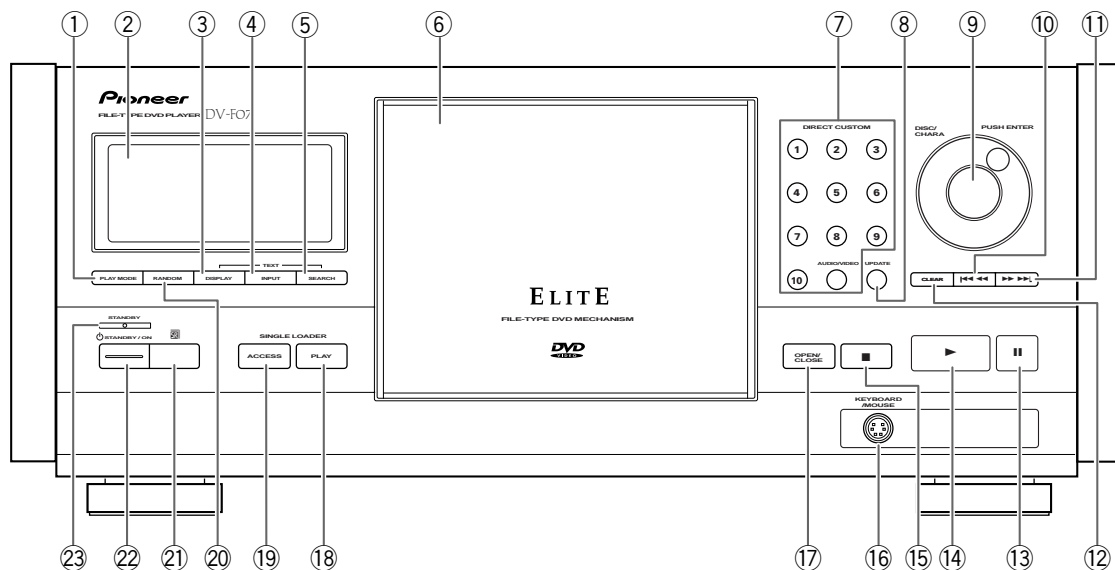

BEFORE USING / NAMES AND FUNCTIONS

① PLAY MODE button

Press repeatedly to select one of the player's play modes. You can select either single play, ALL play, or custom play (page 26).

② Display window

Displays system information (page 10).

③ TEXT DISPLAY button

Press repeatedly to display the disc title or artist name in the display window. When text information is included on the disc, this information will also be displayed.

④ TEXT INPUT button

Press to start text input (page 33).

⑤ TEXT SEARCH button

Press to search for a disc loaded in the rack by format, disc title, or artist (page 37).

⑥ Hood

The hood can be opened and closed by pressing **OPEN/CLOSE** (page 23).

⑦ DIRECT CUSTOM buttons

Number buttons

Press the number button of the custom file you want to play. Playback of the discs in the selected custom file begins automatically (page 38).

AUDIO/VIDEO button

Press repeatedly to select the audio or video custom file bank (page 38).

⑧ UPDATE button

Use to update information on the discs loaded in the rack (page 31).

⑨ Selection dial

Rotate to select a disc number. When inputting text, rotate to select a character (pages 23, 26, and 33).

Enter button

Press to select the disc or enter text that has been selected using the selection dial (pages 26 and 33).

⑩ ◀◀ ◀◀ (reverse) button

Press to go back to previous chapters/tracks. Press and hold to perform reverse playback scanning. When using the front panel to edit input text, use to move the position of the cursor (pages 27 and 33).

⑪ **▶▶▶▶ (forward) button**

Press to advance to chapters/tracks. Press and hold to perform fast-forward scanning. When using the front panel to edit input text, use to move the position of the cursor (pages 27 and 33).

⑫ **CLEAR button**

Use to cancel repeat and random playback, edit programs, and clear text entries (pages 33, 55, 56, 58, and 62).

⑬ **⏸ (pause) button**

Press during playback to pause. Press again to continue playback (page 52).

⑭ **▶ (play) button**

Press to start disc playback (pages 24 and 29).

⑮ **■ (stop) button**

Press to stop playback (page 29).

⑯ **KEYBOARD/MOUSE connection jack**

A PS/2 compatible keyboard or mouse can be connected to this jack for easy entry and editing of text information (pages 33 and 34).

⑰ **OPEN/CLOSE button**

Press to open and close the hood (pages 23 and 24).

⑱ **SINGLE LOADER PLAY button**

Press to play the disc loaded in the single loader slot. This button can be used at any time, even if another disc is being played (page 28).

⑲ **SINGLE LOADER ACCESS button**

Press to have the hood open and the single loader slot brought to the front position (page 28).

⑳ **RANDOM button**

Press to start random playback (page 56).

㉑ **Remote sensor**

Point the remote control toward the remote sensor to operate the player (page 8).

㉒ **⏻ STANDBY/ON button**

Press to switch the player on or to put in standby (pages 20, 23, 29, and 75).

㉓ **STANDBY indicator**

Indicates that the player is in standby, using a minimum amount of power to maintain system settings.

Display Window

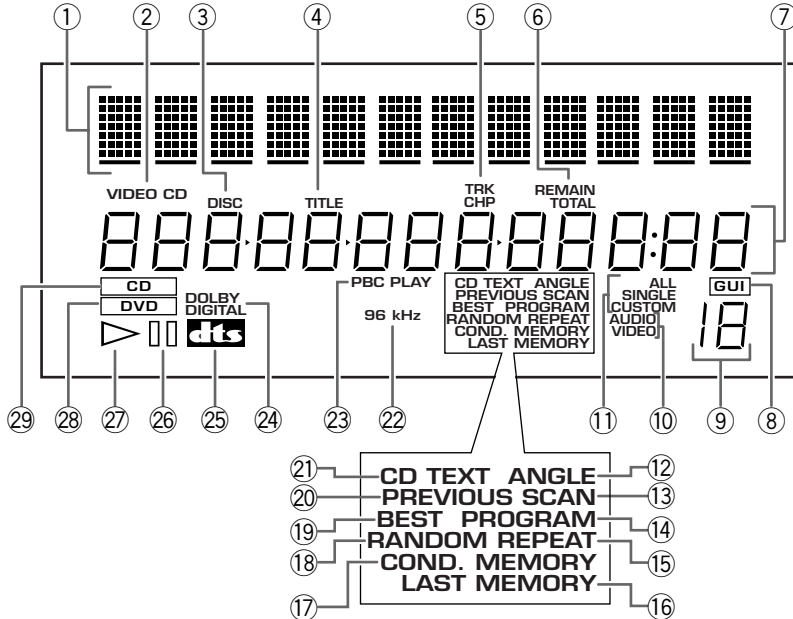

① **Character display**

Displays text information already recorded on the disc such as CD TEXT or DVD text, and also text manually input into the player.

② **VIDEO CD indicator**

Indicates a Video CD is currently selected in the player.

③ **DISC indicator**

Indicates the disc number.

④ **TITLE indicator**

Indicates a title number is being displayed.

- ⑤ **TRK and CHP indicators**
Indicates a chapter or track number is being displayed.
- ⑥ **REMAIN and TOTAL indicators**
REMAIN indicates the remaining playback time of a title or chapter/track is being displayed. TOTAL indicates the disc in the player is stopped and **DISPLAY** has been pressed (page 65).
- ⑦ **Counter display**
Displays title and chapter/track numbers, playback time, etc.
- ⑧ **GUI indicator**
Indicates an on-screen menu operation is being performed.
- ⑨ **Custom file indicator**
Indicates the number of the currently selected custom audio or video file (pages 26 and 38).
- ⑩ **AUDIO and VIDEO indicators**
During custom play, indicate whether the current custom file is an audio (CD) or video (DVD or Video CD) custom file (pages 26 and 38).
- ⑪ **ALL, SINGLE, and CUSTOM indicators**
Indicates the current play mode (page 26).
- ⑫ **ANGLE indicator**
Indicates Multi-Angle playback is in progress (page 54).
- ⑬ **SCAN indicator**
Indicates a Hi-Lite scan is being performed (page 60).
- ⑭ **PROGRAM indicator**
Indicates program playback is being performed (page 57).
- ⑮ **REPEAT indicator**
Indicates repeat playback is being performed (page 55).
- ⑯ **LAST MEMORY indicator**
Indicates the Last Memory location is registered in memory for the DVD currently playing (page 61).
- ⑰ **COND. MEMORY indicator**
Indicates Condition Memory settings are memorized for the DVD currently playing (page 62).
- ⑱ **RANDOM indicator**
Indicates random playback is being performed (page 56).
- ⑲ **BEST indicator**
Indicates Best play is being performed (page 59).
- ⑳ **PREVIOUS SCAN indicator**
Indicates Previous scan is being performed (page 60).
- ㉑ **CD TEXT indicator**
Indicates the CD is recorded with CD TEXT information. When a DVD recorded with text is encountered, only the TEXT indicator lights.
- ㉒ **96 kHz indicator**
Indicates the DVD currently playing contains an audio signal with a sampling frequency of 96 kHz.
- ㉓ **PBC PLAY indicator**
Indicates PBC (playback control) playback of a Video CD.
- ㉔ **DOLBY DIGITAL indicator**
Indicates Dolby Digital audio playback.
- ㉕ **DTS indicator**
Indicates DTS audio playback.
- ㉖ **⏸ (pause) indicator**
Indicates playback is paused.
- ㉗ **▶ (play) indicator**
Indicates a disc is playing.
- ㉘ **DVD indicator**
Indicates a DVD is currently selected in the player.
- ㉙ **CD indicator**
Indicates a CD is currently selected in the player.

Remote Control

All of the command buttons on the remote control glow in the dark for easy control of the player even in the dark. Hold the unit under a light for optimal results.

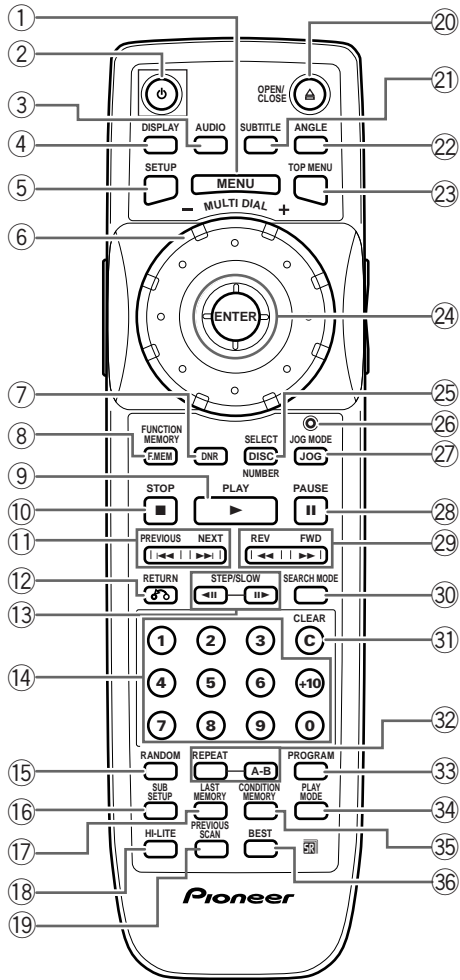

(Buttons indicated with * are used for menu operation.)

- ① **MENU button***
Use to display or close the DVD menu screen (page 25).
- ② **⏻ (standby/on) button**
Press to switch the player on or to put in standby (pages 20, 23, and 29).
- ③ **AUDIO button**
Press repeatedly to select one of the audio languages and/or audio formats programmed on a DVD (page 45).
For Video CD and CD, each press changes the audio output as follows.



- ④ **DISPLAY button**
Press during playback to display statistical disc information. Press repeatedly to display different information (page 64).
- ⑤ **SETUP button***
Press to open and close the Setup screen (pages 20 and 39).
- ⑥ **MULTI DIAL**
In Select Disc Number Mode, use to select one of the discs in the rack. In Jog Mode, use to control the rate and direction of playback (pages 23, 26, and 53).
- ⑦ **DNR button**
Press **DNR** to select a preprogrammed picture quality setting or to adjust various attributes of the video picture (pages 50 and 51).
- ⑧ **FUNCTION MEMORY button***
Press to incorporate a menu item into a shortcut list that is stored in memory and can be called up at any time (page 63).
- ⑨ **PLAY ► button**
Press to start disc playback (pages 24 and 29).
- ⑩ **STOP ■ button**
Press to stop playback (page 29).
- ⑪ **PREVIOUS ◀◀/NEXT ▶▶ buttons***
During playback, press **PREVIOUS ◀◀** to go back to a previous chapter/track and **NEXT ▶▶** to advance to the next chapter/track. Also use to display different sets of information in on-screen displays (pages 27, 32, 38, and 58).
- ⑫ **RETURN ↺ button***
Use to go one menu back (current settings are maintained). Use **RETURN ↺** when you do not want to change the option setting in a menu (pages 25, 40, and 69).
- ⑬ **STEP/SLOW ◀◀/▶▶ buttons**
Press **STEP/SLOW ▶▶** during playback to view slow playback. In pause mode, press **STEP/SLOW ▶▶** to advance DVDs and Video CDs frame by frame and **STEP/SLOW ◀◀** to back up a DVD a few frames at a time (page 52).
- ⑭ **Number buttons (1-9, 0, +10)***
Use to select a disc, perform direct title and chapter/track searches, and to input numerical values (pages 25, 35, and 57).
- ⑮ **RANDOM button**
Press to start random playback (page 56).

- ⑩⑥ **SUB SETUP button***
Press to open and close the player's Sub Setup screen (pages 30, 31, 32, 35, and 36).
- ⑩⑦ **LAST MEMORY button**
Press **LAST MEMORY** during playback to set a Last Memory point (page 61).
- ⑩⑧ **HI-LITE button**
Press to perform a highlight scan of all of the discs included in the current play mode (page 60).
- ⑩⑨ **PREVIOUS SCAN button**
Press to a play highlight from up to 20 previously played discs in order from the most recently played disc (page 60).
- ⑩⑩ **OPEN/CLOSE ▲ button**
Press to open or close the hood (pages 23 and 24).
- ⑩⑪ **SUBTITLE button**
Press repeatedly to select one of the subtitle languages programmed on a DVD or to turn the subtitles off (page 44).
- ⑩⑫ **ANGLE button**
Press repeatedly to display different camera angles as recorded on some DVDs (page 54).
- ⑩⑬ **TOP MENU button***
Press to call up the top menu programmed on the DVD. Depending on the DVD, the top menu may be identical to the DVD menu (page 25).
- ⑩⑭ **Cursor control joystick***
Use to move the cursor through the options on menu screens and to change settings (pages 20, 25, 30, 39, and 57).
ENTER button*
Press to implement settings selected with the cursor control joystick or to set items highlighted in a menu (pages 20, 25, 26, 40, and 57).
- ⑩⑮ **SELECT DISC NUMBER button**
Press to turn on the Select Disc Number Mode. The dial mode indicator lights green and turning **MULTI DIAL** selects the number of a disc loaded in the rack (pages 23 and 26).
- ⑩⑯ **Dial mode indicator**
Lights red when the player is in the Jog Mode and green when the player is in the Select Disc Number mode (pages 23, 26, and 53).
- ⑩⑰ **JOG MODE button**
Press to put the player in the Jog Mode. The dial mode indicator lights red, and turning **MULTI DIAL** controls the playback of DVDs and Video CDs in both forward and reverse directions (page 53).
- ⑩⑱ **PAUSE II button**
Press to pause playback of a disc. Press again to continue playback (page 52).
- ⑩⑲ **REV ◀◀/FWD ▶▶ (fast reverse/ fast forward) buttons**
During playback, press **FWD ▶▶** to perform fast forward scanning and **REV ◀◀** to perform fast reverse scanning (page 27).
- ⑩⑳ **SEARCH MODE button***
Press to perform a title, chapter/track or elapsed time search (page 35).
- ⑩㉑ **CLEAR button**
Press to cancel repeat and random playback, edit programs, and clear text entries (pages 32, 55, 56, 57, and 62).
- ⑩㉒ **REPEAT button**
Press to repeat playback (page 55).
A-B button
Press at the beginning and end of the section you want to repeat or to mark a location you want to return to (page 55).
- ⑩㉓ **PROGRAM button**
You can program discs, titles, chapters, or tracks to play back in a desired order (page 57).
- ⑩㉔ **PLAY MODE button**
Press repeatedly to select one of the player's playback modes. You can select either single play, ALL play, or custom play mode (page 26).
- ⑩㉕ **CONDITION MEMORY button**
Press **CONDITION MEMORY** during DVD playback to memorize playback settings (page 62).
- ⑩㉖ **BEST button**
Press during playback to add tracks or chapters to the Best play program. Press when the player is stopped to begin Best play (page 59).

Rear Panel

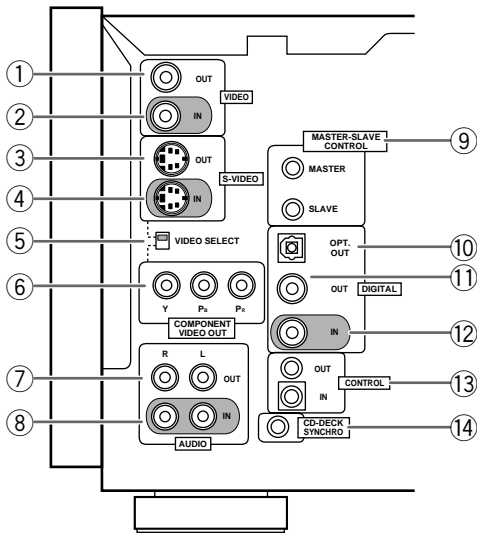

① VIDEO OUT jack

Connect the VIDEO OUT jack to the video input on a TV or monitor or to an AV component with video input capability. When using this jack, be sure to set VIDEO SELECT to the top position (pages 15 and 18).

② VIDEO IN jack

Connect the VIDEO IN jack to the video output of another DV-F07 player or another component with video output capability (page 67).

③ S-VIDEO OUT jack

If your TV or monitor has an S-video input, clear picture reproduction is possible by connecting the S-VIDEO OUT jack to your TV or monitor using a commercially available S-video cable. When using this jack, be sure to set VIDEO SELECT to the top position (pages 16 and 18).

④ S-VIDEO IN jack

Connect the S-VIDEO IN jack to another DV-F07 player or component with S-video output capability (page 67).

⑤ VIDEO SELECT switch

Use to set which output is used to output the video signals. Set to the top position for composite video and S-video output and to the bottom position for component video output (pages 15, 16, and 18).

⑥ COMPONENT VIDEO OUT jacks

If your TV, projection monitor, projector, or similar component has component video inputs, you can produce a high quality picture by connecting to the component video outputs on this unit. When using these jacks, be sure to set VIDEO SELECT to the bottom position (page 18).

⑦ AUDIO OUT jacks

Connect to the stereo audio inputs of a TV or stereo AV component. If you are connecting to an AV component that has both digital and analog input jacks for DVD player connection, it may be beneficial to make both connections (pages 15 and 17).

⑧ AUDIO IN jacks

Connect to the analog audio outputs of another DV-F07 or component with audio output capability (page 66).

⑨ MASTER-SLAVE CONTROL jacks

Connect two DV-F07 players for singular control of both players and a total of 601 discs. Connect the MASTER jack on the player to be used as the "Master" to the SLAVE jack of a second "Slave" player using the supplied Master-Slave control cord. Do not attempt to make connections to other components using this jack (page 66).

⑩ DIGITAL OPT. OUT (optical) jack

Connect the DIGITAL OPT. OUT (optical) to the digital optical input of an AV component with a built-in decoder, etc. to output the digital audio signal recorded on discs. (page 17).

⑪ DIGITAL OUT (coaxial) jack

Connect the DIGITAL OUT (coaxial) to the digital coaxial input of an AV component to output the digital audio signal recorded on discs (pages 16 and 17).

⑫ DIGITAL IN (coaxial) jack

Connect the DIGITAL IN (coaxial) jack of another DV-F07 player or another component with digital output (coaxial) capability (page 66).

⑬ CONTROL jacks

Use to connect this player to another component bearing the Pioneer  mark. This lets you control this unit as though it were a component in a system. Player operations are then performed by pointing the remote control at the component that the player is connected to (page 19).

⑭ CD-DECK SYNCHRO jack

If you have a Pioneer cassette deck that has the CD-Deck synchro function, connect the CD-DECK SYNCHRO jacks on this unit to the identical jack on the cassette deck using a commercially available cord with a mini plug (2.5 mm dia. with no resistance) (page 19).

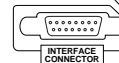

INTERFACE CONNECTOR jack

This jack is intended for use by a system commander in the integration of some systems. Normally, this jack is not used.

Making Connections

Connecting Your DVD Player

Unlike any other audiovisual media format, DVD offers a wide array of audio and video output options which allows playback to be enjoyed in any number of system configurations from a standard TV with stereo audio input to a home theater system with a projection monitor and full surround sound capabilities.

Connecting two DV-F07 players?

If you have chosen to purchase two DV-F07 players for combined control of up to 601 discs, make connections to the player to be used as the Master player following the procedures in this section. When connections are complete, refer to page 66 for a description of how to connect the Slave player.

Connection Guide

The illustration on this page shows the basic setup using the audio and video cords included with this player. Use this illustration as a guide to setting up your home system.

An explanation of each type of audio and video connection available can be found on pages 17 and 18. To determine the best audio and video connection setup for your system, refer to the manuals supplied with the components you are making connections to.

In addition to making physical connections to your TV or monitor, it is also necessary to assign the TV screen size. You can use the [Setup Navigator] in the Setup screen **General** menu to set whether you are using a wide screen or standard size TV or monitor (page 21). Additionally, you can use the [TV Screen] setting in the Setup screen **Video** menu (page 43).

Notes

- When making connections to this unit or when changing connections, check that the unit is off by pressing **STANDBY/ON** and unplug the power cord from the power outlet.
- The video outputs on this player uses copy protect circuitry to prevent the video playback on DVDs from being copied. If you connect the player to a TV via a VCR, or record and play back the contents of a disc with a VCR, the playback picture may not be normal.

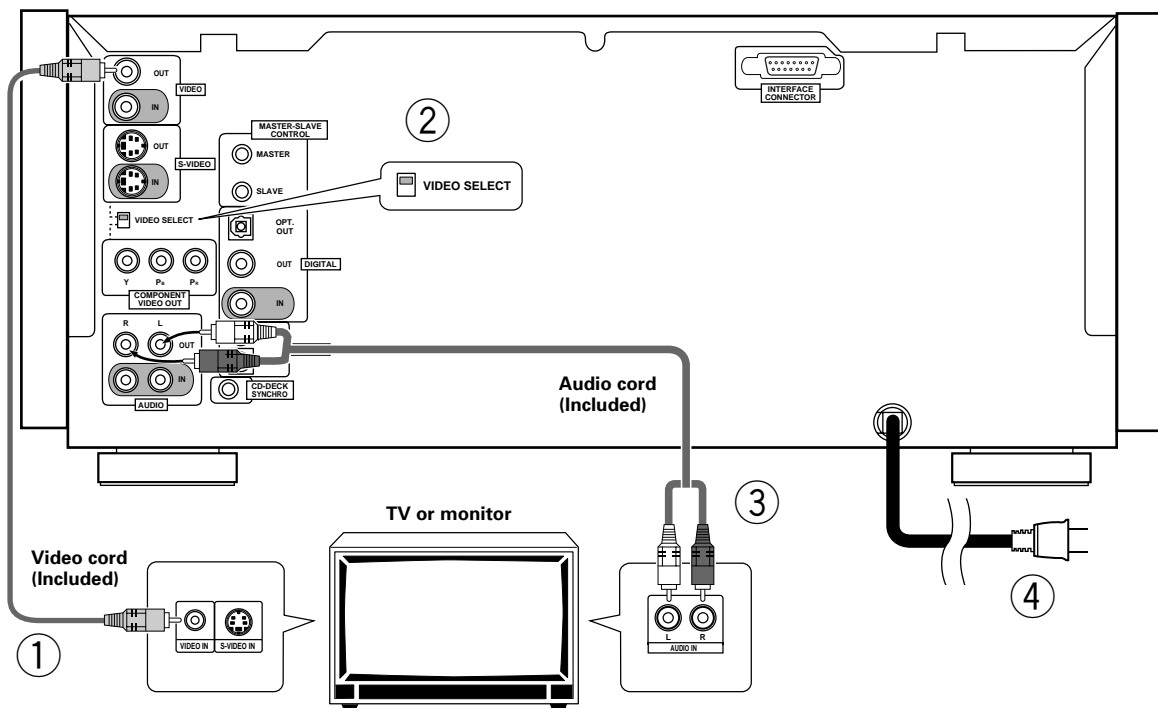

- 1 Make video connections from the VIDEO OUT jack on the player to the VIDEO IN jack on the TV or monitor using the video cord included with the player (page 18).
- 2 When using the VIDEO OUT jack, set VIDEO SELECT to the top position.
- 3 Make audio connections from the AUDIO OUT jacks on the player to the AUDIO IN jacks on the TV or monitor using the stereo audio cord included with the player. Be sure to match the color of the plugs with the color of the jacks (red and white) (page 17).
- 4 After all connections have been made, connect to a power outlet.

Home Theater Component Connections

The connections on this page demonstrate the versatility of this player to conform to any number of home entertainment systems. Please note that the illustration shown on this page is meant as an example. Please refer to the manuals supplied with the components to which you are making connections to determine the best possible setup for your home system.

An explanation of each type of audio and video connection available can be found on pages 17 and 18.

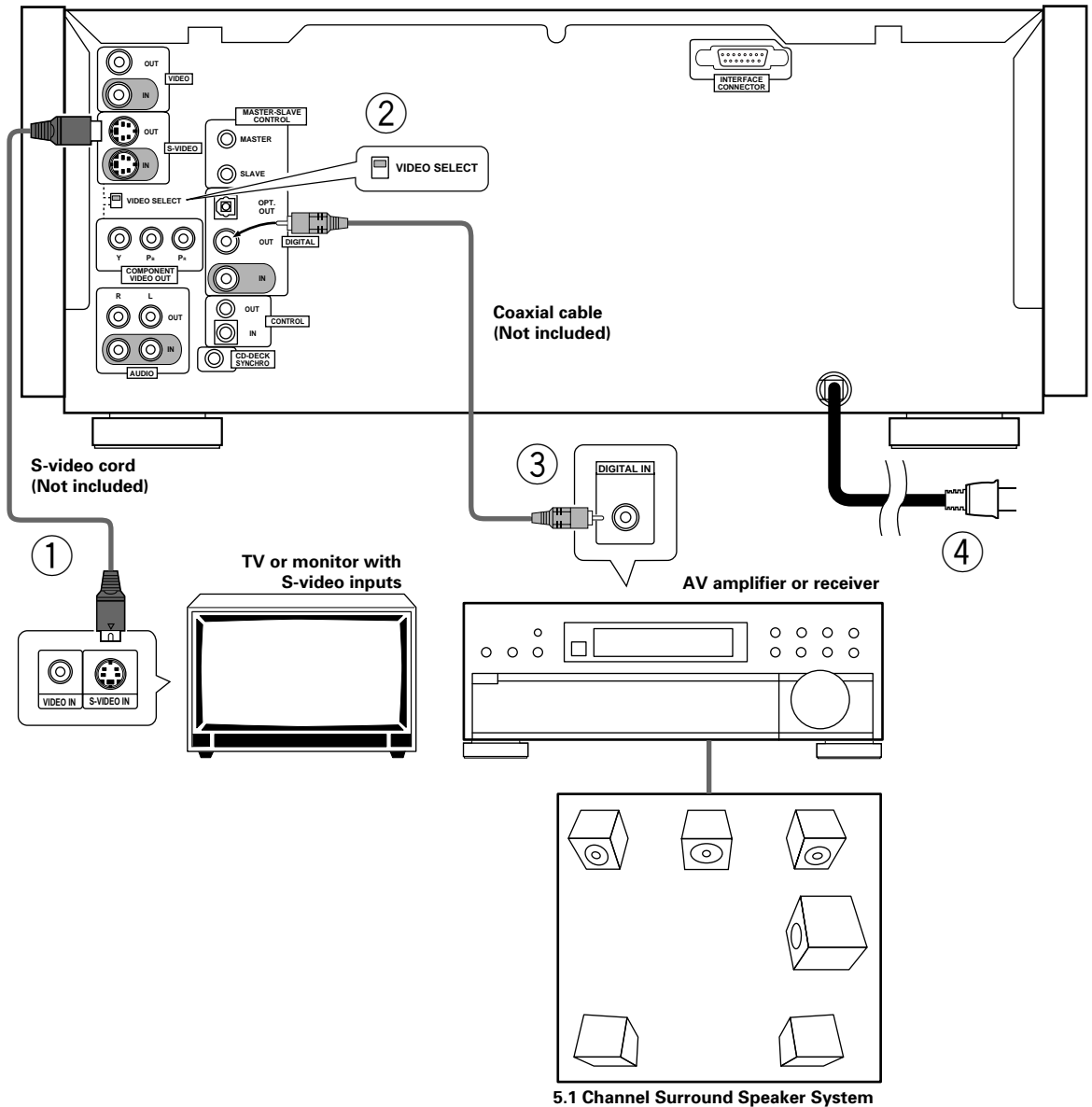

- ① **S-video connection to a TV or monitor with S-video inputs (page 18)*.**
- ② **When using the S-VIDEO OUT jack, set VIDEO SELECT to the top position.**
- ③ **Digital audio connections to an AV component with a built-in decoder, etc. (page 17).**
- ④ **After all connections have been made, connect to a power outlet.**

* It may be possible to make video connections through your AV receiver or amplifier. Please refer to the manual supplied with your component for more information.

Audio Connections

This player features two digital (optical and coaxial) and also analog audio output connection possibilities.

Digital Audio Connections:

You can enjoy the digital audio recorded on DVD discs from both optical digital and coaxial digital output jacks.

When making digital audio connections, use either the coaxial or the optical output jack. It is not necessary to make connections to both digital output jacks.

When a DVD recorded in Dolby Digital, DTS, or MPEG is playing, noise will be output if you have made connections via the digital audio jacks to an AV component that cannot decode a Dolby Digital, DTS, or MPEG digital bitstream. In this case, be sure to set up the Setup Navigator audio settings to best reflect the type of system you are using (page 21). Additionally, the digital audio settings can be adjusted manually in the Setup screen **Audio 1** menu (page 41).

DIGITAL OUT (Optical)

The digital signal is transmitted as light pulses through a fiber-optic cable.

- Use a commercially available fiber-optic cable to connect the DIGITAL OPT. OUT on the player to the digital optical input on an AV component.

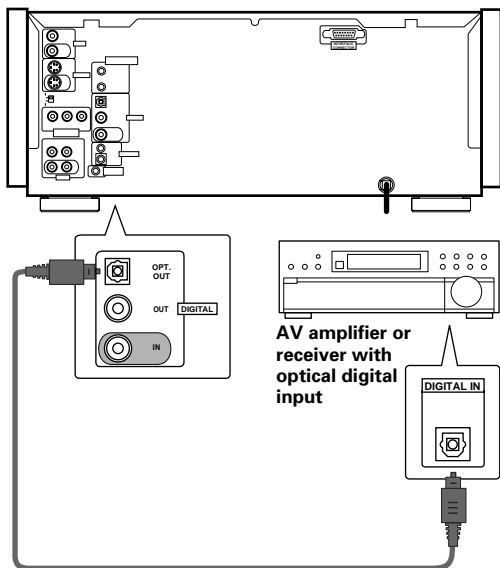

DIGITAL OUT (Coaxial)

The digital signal is transmitted electronically through a coaxial cable.

- Use a commercially available coaxial cable to connect the coaxial digital output on the player to the coaxial digital input on an AV component.

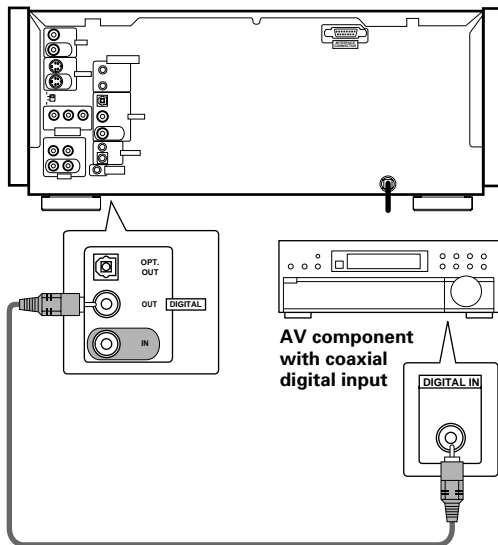

Analog Audio Connections:

AUDIO OUT

- Analog audio connections can be made to a stereo amplifier or receiver, or also can be made to a TV or monitor with stereo input jacks.
- Use the supplied audio cable to connect the AUDIO OUT jacks on the player to the audio input jacks on a stereo amplifier or receiver.
- When making analog audio connections, be sure to match the color of the plugs with the color of the jacks (red and white).

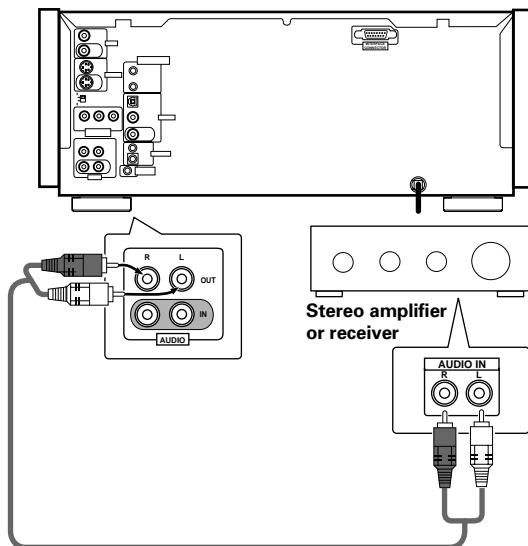

Video Connections

This player features S-video, composite, and component video output possibilities. Check the manual supplied with your TV or monitor to determine the best possible connection for your system.

In addition to making physical connections to your TV or monitor, it is also necessary to assign the TV screen size.

You can use the [Setup Navigator] in the Setup screen **General** to set whether you are using a wide screen or standard size TV or monitor (page 21). Additionally, you can use the [TV Screen] setting in the Setup screen **Video** menu (page 43).

VIDEO OUT

- Make composite video connections to a standard TV or monitor with a video input jack.
- Use the supplied video cable to connect the VIDEO OUT jack on the player to the video input on the TV or monitor.
- Be sure to match the color of the plug with the color of the jack (yellow).
- When making video connections, make sure to set VIDEO SELECT on the rear panel of the player to the top position to assign composite video output.

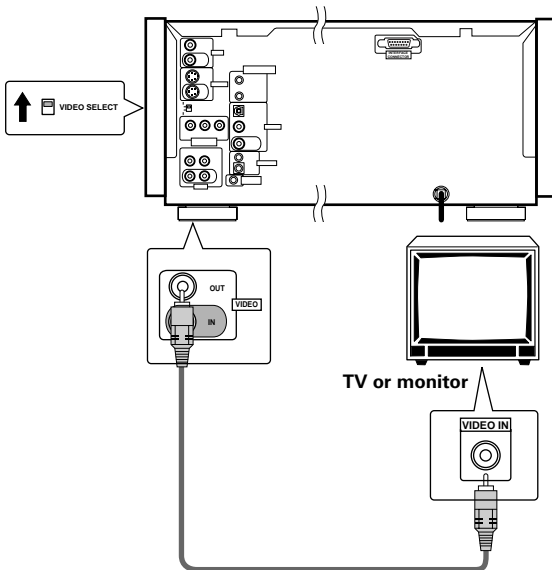

S-VIDEO OUT

- Make S-video connections to a TV or monitor with S-video input to produce a high quality video image.
- Use a commercially available S-video cable to connect the S-VIDEO OUT jack on the player to an S-video input on the TV or monitor.
- When making S-video connections, make sure to set VIDEO SELECT on the rear panel of the player to the top position to assign S-video output.

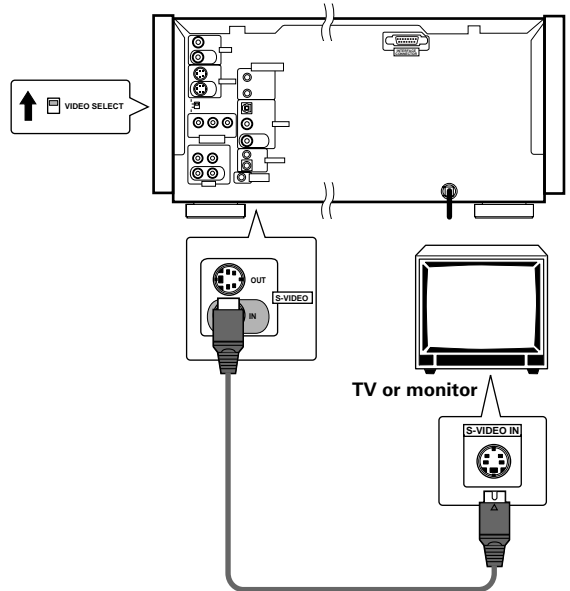

COMPONENT VIDEO OUT

- Make component video connections to a TV, projection monitor, or projector with component inputs for an exceptional video image that best portrays the high quality digital video recorded on DVDs.
- Use a commercially available component video cable or 3 video cords to connect the COMPONENT VIDEO OUT jacks on the player to the component jacks on the monitor.
- When making component video connections, make sure to set VIDEO SELECT on the rear panel of the player to the bottom position to assign component video output.

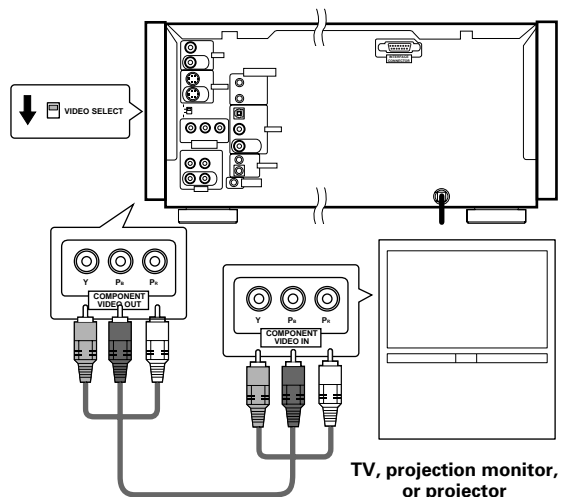

CD-Deck Synchro Connections

If you have a Pioneer cassette deck that has the CD-Deck synchro function, connect the CD-DECK SYNCHRO jacks on this unit to the identical jack on the cassette deck using a commercially available cord with a mini plug (2.5 mm dia. with no resistance).

- For details on connections and operation, refer to the operating instructions supplied with the cassette deck.
- When CD-Deck synchro recording is carried out using several discs in the player, use the program play function (page 57).
- The CD-Deck synchro recording function does not work with Video CDs or DVDs.

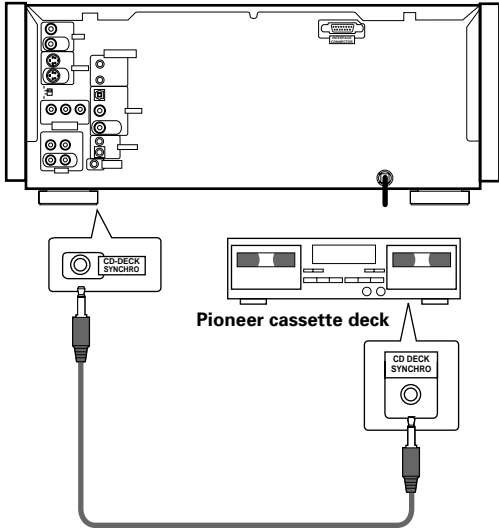

System Control Connections

Using a commercially available cord with a mini plug (3.5 mm dia. with no resistance) to connect this player's CONTROL IN jack to the CONTROL OUT jack of another PIONEER component bearing the **SR** mark, you can control the player as though it were a component in a system (system control).

- If you connect for system control, you cannot operate the player directly. Point the remote control unit at the component (AV amplifier, etc.) connected to the CONTROL OUT jack to operate.
- When controlling as a system, be sure to make a connection to the amplifier **using an audio or video cord**, even when using only digital components.
- For details, refer to the operation manuals of the connected components.

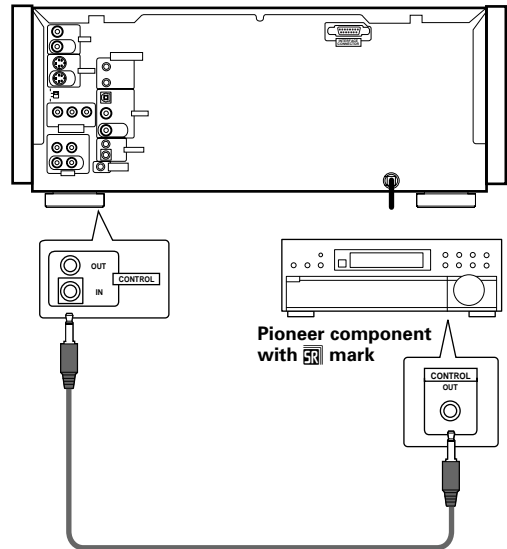

Setting Up the Player

Using the Setup Navigator

The Setup Navigator has been designed to simplify the process of getting the DVD player ready to perform. Designed as a series of on-screen multiple-choice questions, the Setup Navigator automatically sets the audio, video, and language settings according to how the questions are answered. Once this procedure is complete, it will be possible to begin using the DVD player to enjoy DVDs.

The procedure on this page describes the operations necessary to function within the Setup Navigator screens. A detailed description of the contents of each question that appears on the screen can be found on the following pages.

When setting up for the first time

If the disc rack is moving or if a disc is playing, the Setup Navigator will not be displayed as described in the procedure on this page. Therefore, it is recommended to wait until the rack has stopped moving before using the Setup Navigator. If a disc is playing, be sure to press **STOP** ■ before proceeding.

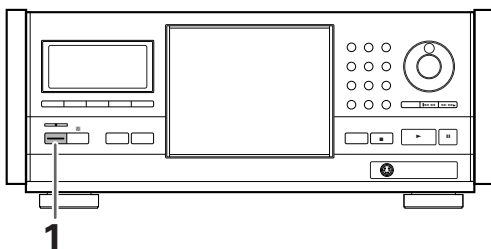
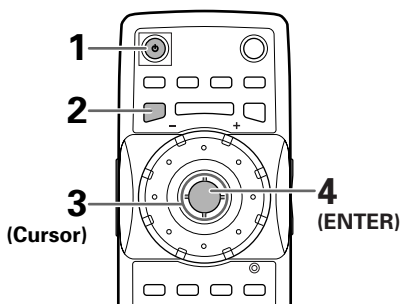

- 1 Press **STANDBY/ON** on the front panel (⏻) on the remote control).

- 2 Press **SETUP**.

When **SETUP** is pressed for the first time, the following screen appears. Though the Setup Navigator may be used more than once, this screen only appears the first time **SETUP** is pressed.

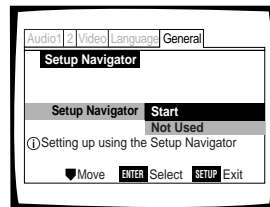

- 3 Move the cursor control joystick up or down to make a selection.

- If you are going to use the Setup Navigator, it is not necessary to change the setting on the first screen. Please proceed to the next step.
- **If you do not want to set up the player using the Setup Navigator, move the cursor control joystick to select "Not Used" at this time.**

The Setup Navigator function may still be used at a later time in manual Setup screen menu operation (page 39).

- 4 Press **ENTER**.

The selection is entered and the next Setup Navigator screen appears.

- 5 Repeat steps 3 and 4 to answer the questions on the all of the Setup Navigator screens as described on the following pages.

To change the answer to a prior question

Move the cursor control joystick left to return to previous screens. Please note, however, that you cannot go forward by moving the cursor control joystick right, so it will be necessary to answer all the questions that occur after the screen that was returned to.

To exit the Setup Navigator

Press **SETUP** while on any of the screens to exit the Setup Navigator. Please note that if the Setup Navigator is exited before all the questions are answered, no settings are changed.

To return to the Setup screen

Press **RETURN** ⏪. The Setup Navigator is exited and the Setup screen **General** menu screen appears. Please note that no settings are changed if **RETURN** ⏪ is pressed before the Setup Navigator is finished.

Setting the OSD Language (On-Screen Display Language)

The [OSD Language] screen establishes the OSD language, or on-screen display language, which refers to the language that is used by the player in menus and on-screen messages. Additionally, the language that is established at this setting will also be set as the audio and subtitle language.

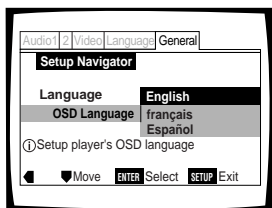

Settings: **English***
français
Español

* Factory setting

Note

In addition to setting the OSD language, the audio and subtitle language are also set at this time. If you wish to change the audio or subtitle language to a different language, make changes in the Setup screen **Language** menu [Audio Language] and [Subtitle Language] as needed (page 46).

Setting the TV screen size

The [TV Connection] screen establishes the size, or more appropriately, the width to height ratio of your television or monitor. The width-to-height ratio of conventional TVs is 4:3, while the width-to-height ratio of wide screen and high-definition TVs is 16:9. This width-to-height ratio is called the aspect ratio.

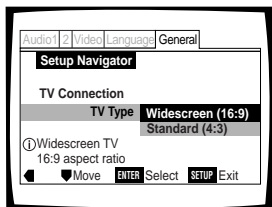

Settings: **Widescreen (16:9)***
Standard (4:3)

* Factory setting

Notes

- There are two screen formats that can be used to display wide-screen format DVDs: letter box and pan & scan. When "Standard (4:3)" is selected in the Setup Navigator, the letter box screen format is automatically selected. To switch the preference to the pan & scan format, make changes in the Setup screen **Video** menu [TV Screen] setting (page 43).
- When "Standard (4:3)" is selected in the Setup Navigator, Linear PCM digital audio playback is output is automatically downsampled to 48 kHz (when the original signal is 96 kHz). In order to hear audio at the sampling rate of 96 kHz, set the Setup screen **Video** menu [TV Screen] setting to either "Wide" or "4:3 (Pan & Scan)" (page 43). Additionally, make sure that your system is set up to output the 96 kHz bitstream using either the Setup Navigator or the Setup screen **Audio 1** menu [96kHz PCM Out] setting (this page and page 41 respectively).

Setting digital audio connections to an AV amplifier or decoder

The [Digital Jacks] screen establishes what kind of digital connections have been made to an AV amplifier, receiver, or external decoder. Please refer to the instructions supplied with the component the player is connected to to determine what digital audio formats can be decoded. If you have made no digital connections, select "Not Connected".

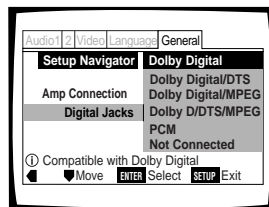

Settings: **Dolby Digital***

Select if the connected AV component is capable of decoding the Dolby Digital bitstream.

Dolby Digital/DTS

Select if the connected AV component is capable of decoding Dolby Digital and DTS bitstreams.

Dolby Digital/MPEG

Select if the connected AV component is capable of decoding Dolby Digital and MPEG bitstreams.

Dolby D/DTS/MPEG

Select if the connected AV component is capable of decoding Dolby Digital, DTS, and MPEG bitstreams.

PCM

Select if the connected AV component has digital input jacks but no internal decoder.

Not Connected

No digital audio connections have been made.

* Factory setting

Setting compatibility with 96 kHz output

The [96 kHz PCM Audio] screen establishes whether or not the AV component the player is connected to is capable of processing an audio signal with a sampling rate of 96 kHz. This screen only appears if connections have been made to an external AV component as determined in the previous screen.

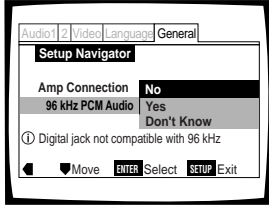

Settings: **No***

Select if the connected AV component cannot process an audio signal with a sampling rate of 96 kHz.

Yes

Select if the connected AV component can process an audio signal with a sampling rate of 96 kHz.

Don't Know

Select if you are uncertain whether the connected AV component can process an audio signal with a sampling rate of 96 kHz.

* Factory setting

Note

When a DVD is played back in the letter box format, Linear PCM digital audio output is automatically downsampled to 48 kHz (when the original signal is 96 kHz). In order to hear audio at the sampling rate of 96 kHz, set the Setup screen **Video** menu [TV Screen] setting to either "Wide" or "4:3 (Pan & Scan)" (page 43).

Confirming the settings

The [Exit Setup Navigator] is the final screen in the Setup Navigator.

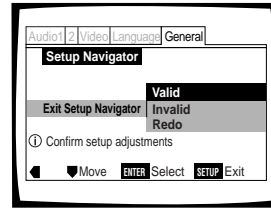

Settings: **Valid***

Select to have the player make all of the necessary audio, video and language settings automatically.

Invalid

Select to exit the Setup Navigator without changing any of the system settings.

Redo

Select to return to the [OSD Language] screen of the Setup Navigator and do the settings again.

* Factory setting

To exit the Setup screen

When you have completed setting up the player using the Setup Navigator or if you exit the Setup Navigator, the Setup screen **General** menu appears. Press **Setup** to close the Setup screen.

To change other player settings in the Setup screen menus

The procedure for changing the settings in the Setup screen menus is described on page 39.

Getting Started Using Your DVD Player

Loading DVDs, Video CDs and CDs into the Player—DVD/Video CD/CD

You can load as many as 300 discs into the rack. Disc positions in the rack are numbered clockwise from 1 to 300 starting after the single loader slot. The procedure on this page describes how to load discs starting from the number 1 position. However, the same procedure can be followed when you want to change or add more discs at a different time.

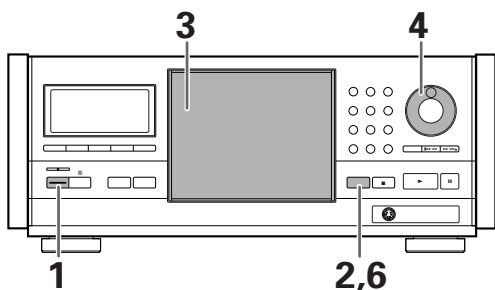
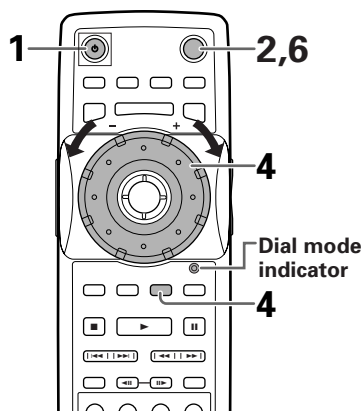

- 1 Press **STANDBY/ON** on the front panel).
- 2 Press **OPEN/CLOSE** on the front panel).
The disc rack hood slides open.

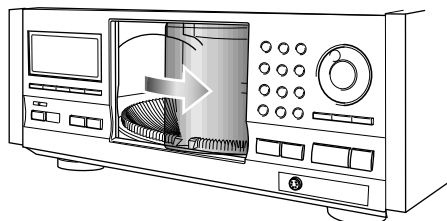

- 3 Load discs in the rack.
 - The number 1 position is immediately to the left of the single loader slot.
 - Load discs with the label side facing to the right. (When loading double-sided DVDs, load the disc in the rack with the label denoting the contents you want to view facing the right.)
 - Do not place more than one disc in the same rack position as that may damage the disc and cause the player to malfunction.

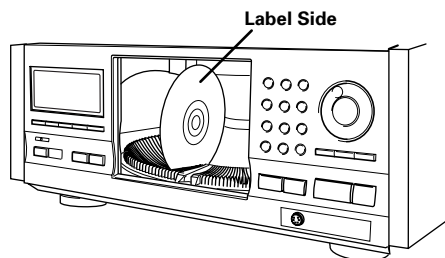

- 4 Press **SELECT DISC NUMBER** (the dial mode indicator lights green) and then turn **MULTI DIAL** to rotate the rack to the next position.
When using the front panel, turn the selection dial clockwise to rotate the rack to the next disc position.
 - The rack rotates the amount that either **MULTI DIAL** or the selection dial is turned.
 - Turning the **MULTI DIAL** or the selection dial counterclockwise rotates the rack in the opposite direction.

- 5 Repeat steps 3 and 4 to continue loading discs in the rack.

- 6 When you have finished loading discs into the rack, press **OPEN/CLOSE** on the front panel).
The hood slides closed and the rack makes a single revolution while the player determines where discs have been loaded in the rack.

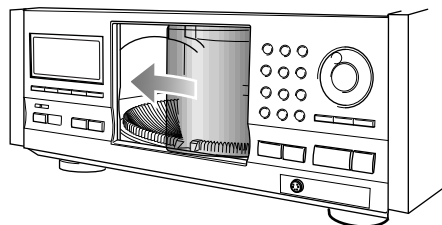



Note
Never force the hood open or closed. Doing so may cause part damage or player malfunction.

To load a 3 inch (8 cm) CD

3 inch (8 cm) discs cannot be inserted as they are. Be sure to attach all 3 inch (8 cm) CDs to a commercially available disc adapter before loading them in the player.

- Do not load an adapter into the rack without a CD attached. Doing so may cause the player to malfunction.
- 3 inch (8 cm) DVDs cannot be used with this player. To prevent malfunction, do not use 8 cm (3 in.) CD adapters with 8 cm (3 in.) DVDs.

To remove discs from the rack

- 1 Press **OPEN/CLOSE**  (**OPEN/CLOSE** on the front panel) to open the hood.
- 2 Select the disc that you want to remove using one of the methods outlined in step 4 of the procedure "Loading DVDs, Video CDs and CDs into the Player" on the previous page.
- 3 Remove the disc from the rack.
- 4 Press **OPEN/CLOSE**  (**OPEN/CLOSE** on the front panel) to close the hood when you are finished.

WARNING

Do not put your hand or any other object inside the rack, as this may result in personal injury and/or part damage.



- **When changing or loading discs, be careful not to press any buttons on the player or remote control. The rack may move suddenly, and may catch your fingers between discs and the side of the hood.**
- **When changing or loading discs, make sure the rack is stopped. Do not attempt to insert a disc while the rack is moving.**



Playing DVDs, Video CDs and CDs – DVD/Video CD/CD

Before you can start to enjoy the digital audio and video on DVDs, be sure that you have either performed the Setup Navigator procedure described in the previous section or made the necessary settings in the Setup screen menus as outlined in the section starting on page 39 to set up the player to correspond to your home system. Having made these settings, you are now ready to start using the player to enjoy DVDs, Video CDs, and CDs.

Make sure that you have already loaded the rack as described in the section starting on the previous page.

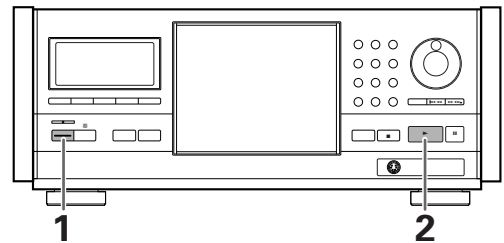
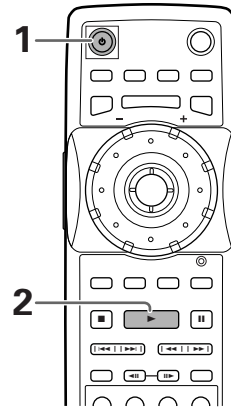
To play a disc



- 1 Press  (**STANDBY/ON** on the front panel).
- 2 Press **PLAY**  (▶ on the front panel).
 - If a play mode has been previously selected, disc(s) will be played according to the selected play mode (page 26).
 - When a disc containing text or a disc that has had text information input is played, the text information appears in the display window. Refer to page 31 for information on inputting text.
 - **Depending on the disc, a menu may be displayed. The section 'When a menu screen is displayed' on the following page provides general guidelines for understanding menu screens.**

Notes

- Noise is output if you make digital audio connections to a receiver or amplifier that does not have a built-in decoder. Check that the digital audio output format selected in the **Audio 1** menu corresponds to the audio components you have made connections to (page 41).
- The TV screen size is factory set to present the wide screen format (16:9 aspect ratio). If you have a standard TV screen (4:3 aspect ratio), this setting can be changed to match your TV screen size in the **Video** menu (page 43).

When an operation is prohibited

There are times when you are using the player and attempt to perform an operation, but for some reason it cannot be performed. When this occurs, one of the two following icons appears on the screen.



The operation is prohibited by the player.



The operation is prohibited by the programming on the disc.

When a menu screen is displayed

Menu screens are displayed for DVDs that have menu screens or Video CDs that include PBC (Playback Control). DVDs often contain extra information that can be accessed in the DVD menu and sometimes makes navigating DVD menu screens as enjoyable as watching the feature presentation.

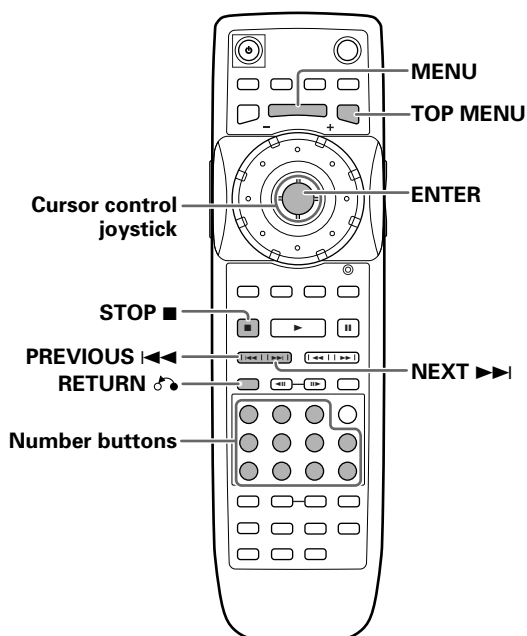

Example: When a DVD that has menu screens is selected



Example: When a Video CD that has Playback Control is selected



To open or return to the DVD or Video CD menu screen

Although this differs depending on the disc, pressing **MENU**, **TOP MENU**, or **RETURN** during DVD playback or **RETURN** during Video CD playback displays the menu screen. Refer to the DVD or Video CD disc jacket and accompanying documentation for more information.

To navigate a menu screen

- Although individual DVD titles may differ, when a menu screen is displayed, use the cursor control joystick and **ENTER** on the remote control. The cursor control joystick is used to move around the options on the screen and **ENTER** is used for selection. Occasionally, the number buttons may also be used to make selections. If this is possible, using number buttons serves to directly select an option on a menu screen.
- Only number buttons are used to make selections on Video CD menu screens.
- When the Video CD has more than one menu, pages can be advanced to or returned to with **PREVIOUS** or **NEXT**.

Turning PBC (Playback Control) on and off

When playing Video CDs with PBC (Playback Control), PBC is technically on by default and a menu screen is displayed. Additionally, the menu screen is returned to when the selected track is complete.

If you would like to turn PBC off so that the menu screen is not displayed, press **STOP** when a Video CD with PBC is selected and then press the number button of the track you want to play. Please note that a number of functions such as random and program playback may not be possible unless PBC is turned off.

Selecting a disc in the disc rack

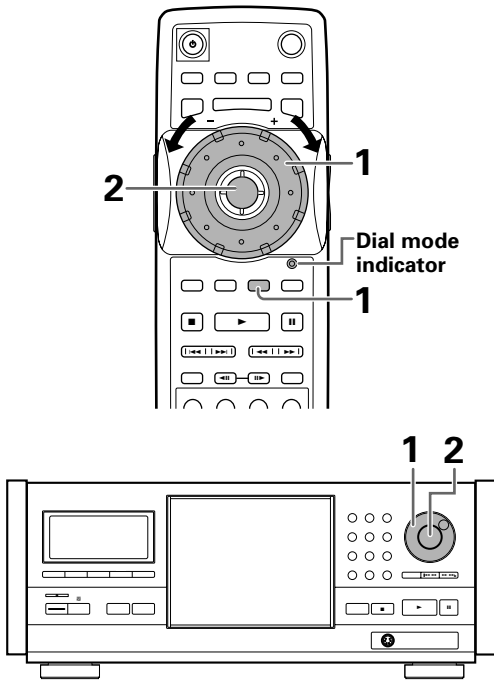

- 1 Press **SELECT DISC NUMBER** (the dial mode indicator lights green) and then turn **MULTI DIAL** to select a disc number.

When using the front panel, turn the selection dial to select a disc number.

- The disc numbers increase when **MULTI DIAL** or the selection dial is turned clockwise, and decrease when **MULTI DIAL** or the selection dial is turned counterclockwise

- 2 Press **ENTER**.

When using the front panel, press the enter button in the center of the selection dial.

- The disc rack rotates to position of the selected disc, and playback of the disc starts.

Note

You can also select a disc on-screen using the Sub Setup screen Text menu (page 35).

Selecting a play mode

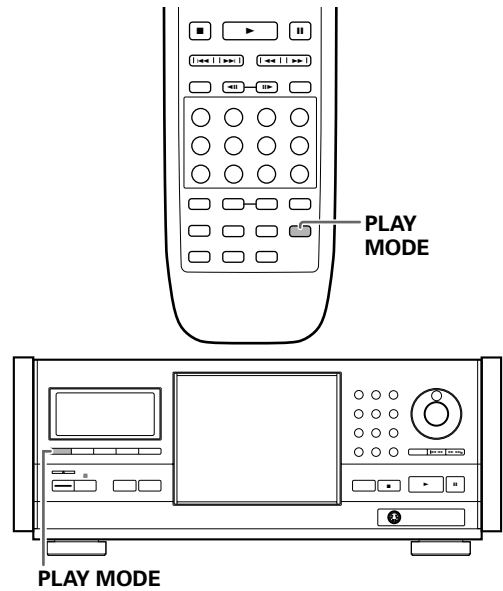

Press **PLAY MODE** repeatedly to select one of the play modes:

- ALL** : All discs are played back in the order they appear in the rack. If DVDs or Video CDs with PBC are loaded in the rack, all discs may not be played back continuously.
- SINGLE** : One disc is played. Playback stops after the disc has been played.
- CUSTOM** : Only discs in the custom file are played back.

The play mode changes each time **PLAY MODE** is pressed as follows.

While disc playback is stopped:

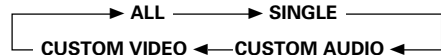

During disc playback:

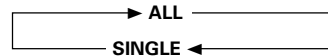

- The ALL, SINGLE, CUSTOM AUDIO, or CUSTOM VIDEO indicators appear in the display window to indicate the current play mode.
- ALL play ends after a full revolution of the rack has been made from the position of the currently selected disc.
- CUSTOM AUDIO and CUSTOM VIDEO cannot be selected until custom files have been created.

To create and select one of the custom play modes

Refer to the section 'Creating and Selecting Custom Files' on page 37.

Notes

- If **PLAY MODE** is pressed during program play, the program is erased.
- The play mode is stored in memory when the player is turned off, and is established when the player is turned on again.
- If no play mode is selected, the default play mode is ALL play.
- The single play mode is automatically set when the disc in the single loader slot is being played (page 28).

Chapter (Track) Skip Forward/ Skip Back – DVD/Video CD/CD

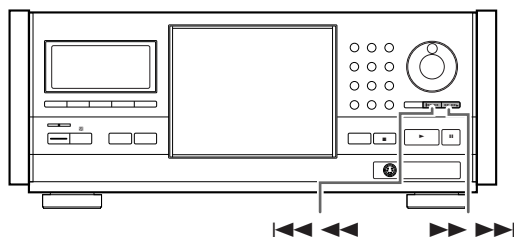
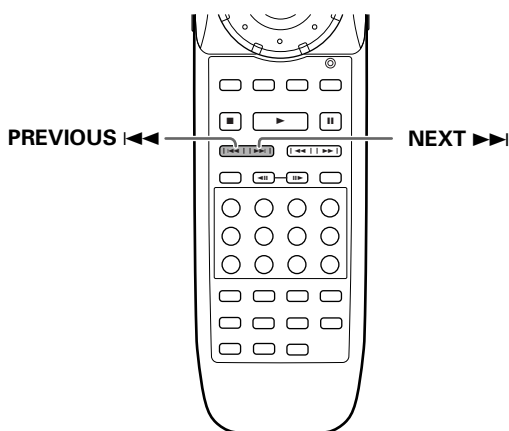

Advancing to the next chapter (track)

Press **NEXT** ►► (►► ►► on the front panel).

- Press to skip forward to the next chapter (track).
- When a CD is playing, you can advance more than one track forward by pressing and holding **NEXT** ►► and releasing when the desired track number appears in the display window.

Skipping back to the previous chapter (track)

Press **PREVIOUS** ◄◄ (◄◄ ◄◄ on the front panel).

- Press once to skip back to the start of the chapter (track) currently playing.
- Press twice to skip back to the start of the previous chapter (track).
- When a CD is playing, you can skip back to the track you want to hear by pressing and holding **PREVIOUS** ◄◄ and releasing when the desired track number appears in the display window.

Forward and Reverse Scanning

– DVD/Video CD/CD

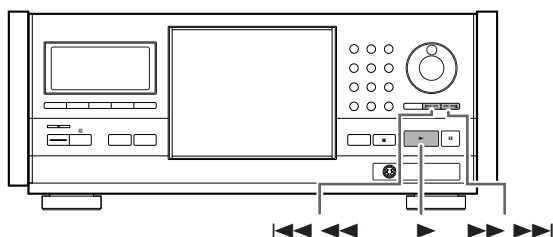
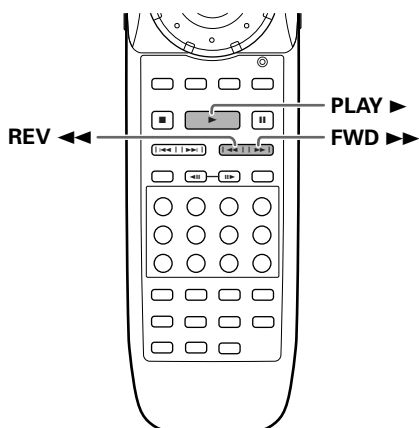

Fast forward scanning

Press and hold **FWD** ►► (►► ►► on the front panel) during playback.

- Release **FWD** ►► when you reach the desired location. Normal playback resumes.
- The three scanning speeds that this player uses increase in speed from "SCAN 1" to "SCAN 3"
- On DVDs, when the flashing "SCAN 2" on the screen changes to a flashing "SCAN 3", fast forward scanning will continue even if the button is released. On Video CDs and CDs, the scanning speeds are "SCAN 1" and "SCAN 2". When the desired location has been reached, press **PLAY** ►.
- Variable speed scanning is also possible using **MULTI DIAL** on the remote control (page 53).

Fast reverse scanning

Press and hold **REV** ◄◄ (◄◄ ◄◄ on the front panel) during playback.

- Release **REV** ◄◄ when you reach the desired location. Normal playback resumes.
- The three scanning speeds that this player uses increase in speed from "SCAN 1" to "SCAN 3"
- On DVDs, when the flashing "SCAN 2" on the screen changes to a flashing "SCAN 3", fast reverse scanning will continue even if the button is released. On Video CDs and CDs, the scanning speeds are "SCAN 1" and "SCAN 2". When the desired location has been reached, press **PLAY** ►.
- Variable speed scanning is also possible using **MULTI DIAL** on the remote control (page 53).

Playing a Disc That Is Not Loaded in the Rack (Single Loader Play)

By using the single loader slot, you can quickly load discs, such as rental DVDs, that you may not want to have loaded in the changer all of the time. With the touch of a single button, this disc can be called up and played at any time.

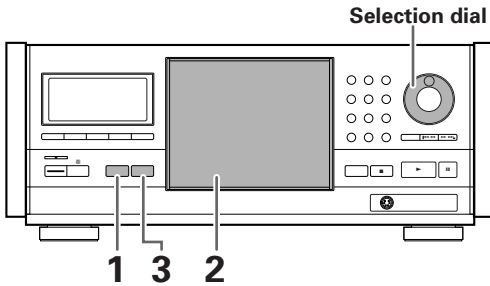

1 Press **SINGLE LOADER ACCESS** on the front panel.

The rack rotates to the single loader slot and the hood opens automatically.

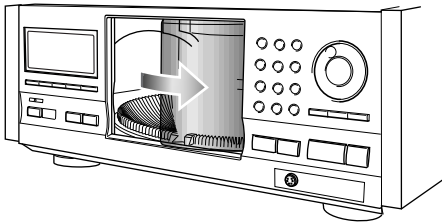

2 Load a disc in the single loader slot with the label side facing the right. (When loading double-sided DVDs, load the disc in the rack with the label denoting the contents you want to view facing the right.)

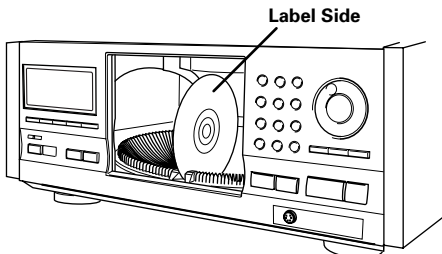

3 Press **SINGLE LOADER PLAY** on the front panel.

- The hood closes automatically and playback of the disc in the single loader slot begins.
- The play mode is automatically set to SINGLE.

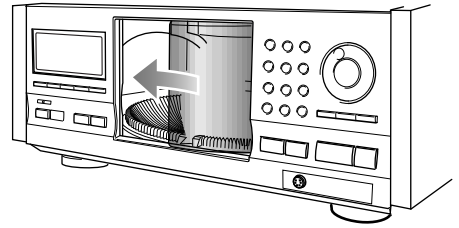

Notes

- The disc in the single loader slot can also be selected with the selection dial on the front panel. Turn the selection dial to select the "P0" disc position between 1 and 300.
- By pressing **SELECT DISC NUMBER** on the remote control (the Jog mode indicator light green), you can also turn **MULTI DIAL** to select the "P0" disc position between 1 and 300.
- If a disc is loaded in the single loader slot, pressing **SINGLE LOADER PLAY** allows you to play the disc at any time, even during playback of a disc loaded in the rack.
- When Master-Slave connections are made, single loader play on the Slave player cannot be performed.

Stopping Playback and Switching Power Off

– DVD/Video CD/CD

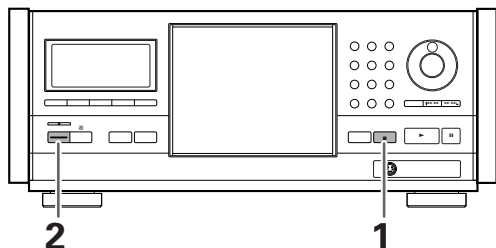
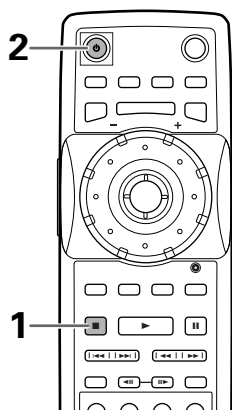

- 1 Press **STOP** ■ (■ on the front panel). Playback stops.
- 2 Press **⏻** (⏻ **STANDBY/ON** on the front panel). The player is put in standby.

Resuming playback from where you stopped — DVD/Video CD

With this player, it is possible to resume play of a DVD even when play has been stopped.

Press **STOP** ■ once to enable play to resume from a point shortly before the DVD was stopped when **PLAY** ► is pressed again.

- To begin playback of the disc that most recently been played from the beginning, press **STOP** ■ twice to turn off resume playback, and then start playback again.
- When **STOP** ■ is pressed, “RESUME” appears in the display window for as long as resume playback is possible. If the function is canceled, “RESUME” disappears.
- Resume playback is canceled in the following conditions:
 - * **OPEN/CLOSE** ▲ (**OPEN/CLOSE** on the front panel) is pressed to open the hood.
 - * **MULTI DIAL** on the remote control (when the dial mode indicator is lit green) or the selection dial on the front panel is turned.
 - * Another disc is selected.

Note

If you want to continue viewing a DVD at a later time or date, it is recommended to use the Last Memory function described on page 61.

About the Last Disc Memory function

Even after you have turned the player's power off, the player maintains in memory what disc was playing, as well as the play mode. When power is turned on again, pressing **PLAY** ► (► on the front panel) starts playback from the last disc that was played in the previously selected play mode.

If the playback is stopped and the player is turned off during program play, random play, Best play, Previous Scan, or Hi-Lite scan, these functions will not be resumed when the player is turned on again and **PLAY** ► (► on the front panel) is pressed.

Disc Management

This player makes it easy to manage all the discs in the player. The Sub Setup screen contains three menu screens that allow you to organize your disc library as you see fit. This section outlines the basic operation of the Sub Setup screen menus.

Note

If the Sub Setup screen is opened during playback of a DVD being viewed in the letter box format, the screen may switch to the wide screen format. This is not a malfunction, and the screen will return to normal when the Sub Setup screen is closed.

Registering Information and Inputting Text for Discs Newly Loaded in the Player

After you have loaded discs in the player for the first time, it is recommended to have the player register the information such as text, and disc format data from all of the discs in the rack.

It is recommended to use [Add. Disc Update] whenever new discs are loaded in the player .

- This function cannot be performed while a disc is playing. Stop playback of the disc before proceeding.

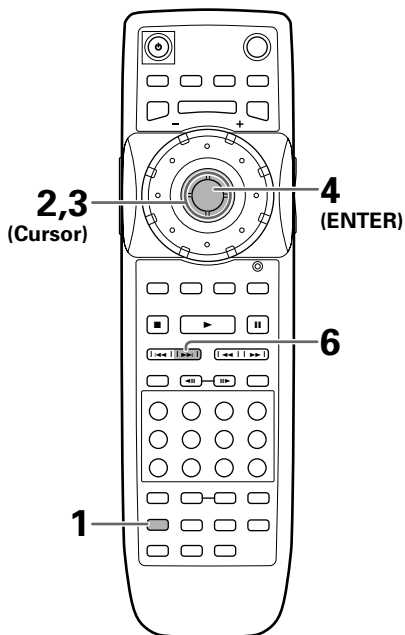

1 Press **SUB SETUP**.

2 Move the cursor control joystick to the right to select the Auto Update menu.

3 Move the cursor control joystick down to select [Add Disc Update].

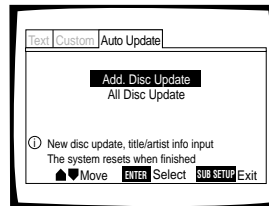

4 Press **ENTER**.

Add. Update begins and the rack starts to rotate as each new disc is read by the player. It takes between 10 and 20 seconds for the player to read a single disc.

5 Input the title of the disc and the artist's name as described in the section "Inputting and Changing Text Information" on pages 31 to 34.

- If the disc already contains text information on it, the information is automatically used for the disc title and artist name, and the confirmation screen is automatically displayed. When this is the case, press **NEXT** (▶▶▶) (▶▶▶▶) on the front panel) to proceed to the next disc.
- With some DVDs that already contain text information, there may be several options to choose from. When this is the case, a selection window appears.
- After both the disc title and artist's name have been entered, a confirmation screen appears.

6 When the confirmation screen appears, press **NEXT** (▶▶▶) (▶▶▶▶) on the front panel) to proceed to the next disc.

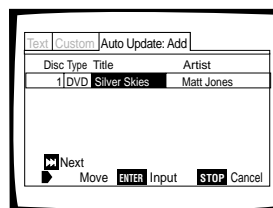

- If you would like to go back and change either the disc title or artist's name at this time, move the cursor control joystick right or left to select the appropriate field and then press **ENTER** to return to the text input screen.
- If you would like to change the disc title or artist's name when the text information is already on the disc, go to the text input screen from the confirmation screen and input the new text information with a space " " for the first character. The new text information will be stored in memory.
- When all the newly loaded discs in the rack has been registered, the system restarts.

To performing Add. Update using controls on the front panel

Press **UPDATE** on the front panel repeatedly until "Add. Update" appears in the display window, then press the enter button.

To proceed to the next disc without inputting text information for the current disc

During Add. Update, if you do not want to input either title or artist information, use the cursor control joystick to move the cursor to "OK" and press **ENTER**. When this is done for both the disc title and artist's name, proceed with step 6 in the procedure on the previous page. Text information can be input later using the Sub Setup screen Text menu.

To cancel Add. Update

Press **STOP** ■.

When the Add. Update procedure is canceled, information that has already been input will be stored in memory. However, because the information is not officially registered until the system is put in standby, if the power cord is unplugged, or the main power to the player is cut, this information may be erased.

Keeping the Disc Order and Information Updated

The player has the ability to store information for as many as 330 discs. After the information on the discs loaded in the player has been registered in the player's memory, even if the discs in the rack are reorganized or if as many as 30 discs are removed from the rack, the player will maintain the information in memory. When the discs are restored to the player, regardless of order, the appropriate information (input text information, etc.) is applied to each disc when All Disc Update is performed.

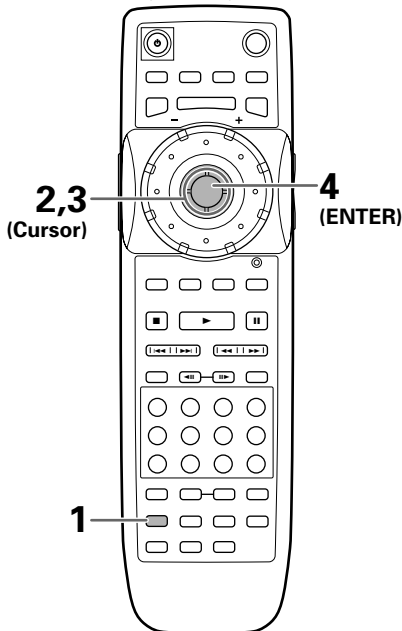

1 Press **SUB SETUP**.

2 Move the cursor control joystick to the right to select the Auto Update menu.

3 Move the cursor control joystick down to select [All Disc Update].

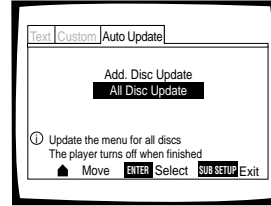

4 Press **ENTER**.

- "Auto Update" is displayed as the rack starts to rotate as each new disc is read by the player. It takes between 10 and 20 seconds for the player to read a single disc.
- When All Disc Update is complete, the player turns off automatically. This is not a malfunction.

To performing Add. Update using controls on the front panel

Press **UPDATE** on the front panel repeatedly until "All Update" appears in the display window, then press the enter button.

To cancel All Update

Press **STOP** ■.

When the All Update procedure is canceled, none of the updated information is retained in memory.

Inputting and Changing Text Information

Disc titles and artist names can be input for all the discs loaded in the player. This information is displayed when the disc is played and is also used when performing searches.

Input information can be as long as 12 characters using your choice of letters, numbers and symbols. Characters can be input using controls on the front panel or remote control unit, and can also be directly input using a PS/2 compatible keyboard or mouse if connections are made to the KEYBOARD/MOUSE jack on the front panel.

Notes

- The input text information is not actually stored in the player's memory until the power has been put in standby. If information has been input, and the power cord is unplugged or the main power to the player is cut, the information may be erased.
- Text information cannot be input for the disc in the single loader slot.

continued

When a disc already contain text information

When text is already present on the disc in the form of CD TEXT or DVD text, the title and artist information appears automatically in the appropriate spaces. However, it is possible to change the information that appears for these discs. When you change the title or artist information, input a space “ ” at the beginning of the entry. The newly input information will be displayed for the disc in place of the information programmed on the disc.

To have the original information programmed on the disc displayed, delete the space “ ” at the beginning of the entry.

Inputting characters using the remote control

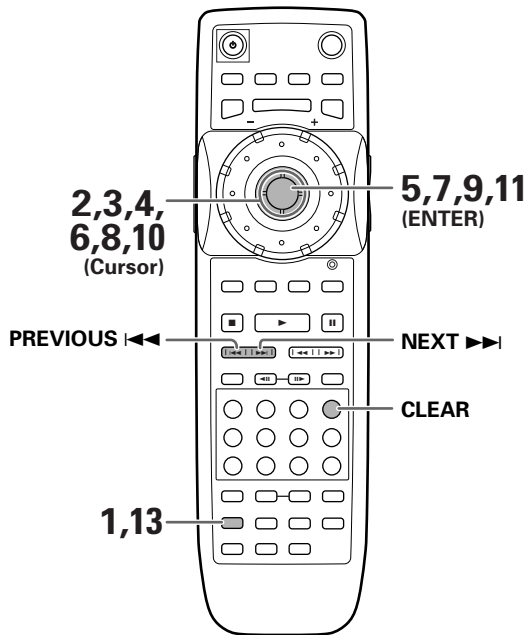

- 1 Press **SUB SETUP**.
- 2 Move the cursor control joystick to select the Text menu.
- 3 Move the cursor control joystick down to select a disc number.

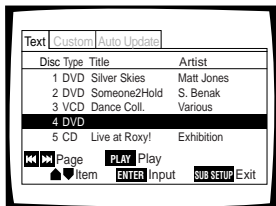

If the disc number you want is not currently displayed on the screen, use **PREVIOUS** ◀◀ or **NEXT** ▶▶ to move in five disc increments until the disc you want appears.

- 4 Move the cursor control joystick right to highlight the title field.
- 5 Press **ENTER**.
The text input screen appears.
- 6 Move the cursor control around the character field to select a character.

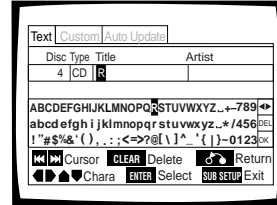

- 7 Press **ENTER** to select a character.
- 8 When you are finished with the title, move the cursor control to select “OK”.
- 9 Press **ENTER**.
The cursor returns to the Text menu screen.
- 10 Move the cursor control joystick right to highlight the artist’s field.
- 11 Press **ENTER**.
The text input screen appears.
- 12 Repeat steps 6 to 8 to complete the artist’s name.
- 13 Press **SUB SETUP**.
The Sub Setup screen closes.

To clear text that has been entered

- 1 Set the character input mode as described in steps 1 through 5 above.
- 2 Use **PREVIOUS** ◀◀ or **NEXT** ▶▶ to move the cursor to the character you want to clear.
- 3 Press **CLEAR**.
- 4 Move the cursor control joystick to select “OK” and press **ENTER**.

To add or insert text

- 1 Set the character input mode as described in steps 1 through 5 above.
- 2 Use **PREVIOUS** ◀◀ or **NEXT** ▶▶ to move the cursor to the character where you want to add or insert new text. New text will be inserted at the cursor location.
- 3 Move the cursor control joystick to select the new text and press **ENTER**.
- 4 Move the cursor control joystick to select “OK” and press **ENTER**.

Inputting characters using controls on the front panel

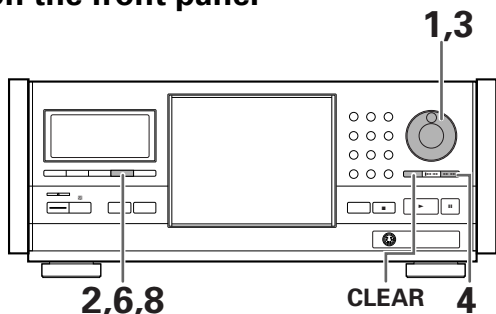

- 1 Turn the selection dial to select the disc you want to input a title for.
- 2 Press **TEXT INPUT**.
The cursor blinks in the leftmost character position.
- 3 Turn the selection dial to select the characters in the display window.
As the selection dial is turned, the cursor scrolls through the characters.
- 4 Press the enter button to advance to the next location.
- 5 Repeat steps 3 and 4 to input the rest of the title.
- 6 Press **TEXT INPUT**.
The disc title is saved in memory. The cursor blinks in the leftmost character position for artist name input.
- 7 Repeat steps 3 and 4 to input the artist's name.
- 8 Press **TEXT INPUT**.
The artist's name is saved in memory and the mode is exited.

To clear text that has been entered

- 1 Set the character input mode as described in steps 1 and 2 above.
- 2 Use the **◀◀◀** or **▶▶▶** to move the cursor underneath the character you want to clear
- 3 Press **CLEAR**.
- 4 Press **TEXT INPUT**.

To add or insert text

- 1 Set the character input mode as described in steps 1 and 2 on this page.
- 2 Use the **◀◀◀** or **▶▶▶** to move the cursor to where you want to add or insert new text.
- 3 Turn the selection dial to select a character and press the enter button.
- 4 Press **TEXT INPUT**.

Note

Please note that when the custom play mode is selected and **TEXT INPUT** is pressed, text input is applied to the name of the custom file and not to the title or artist's name of the currently selected disc.

Inputting characters using a PS/2* compatible keyboard

Be sure to turn off the power to the player when connecting a PS/2 compatible keyboard to the **KEYBOARD/MOUSE** connection jack on the front panel of this player.

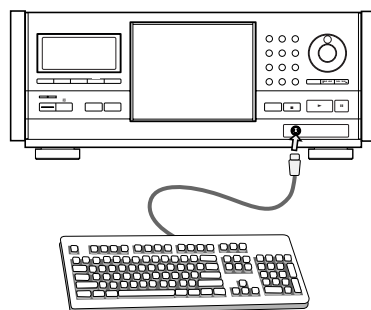

- 1 Use the keyboard's numeric keypad to select the number of the disc.
- 2 Press **F1** on the keyboard.
The character input screen appears.

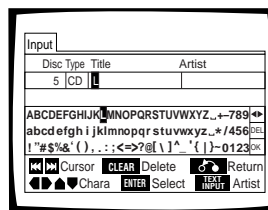

- 3 Enter characters directly from the keyboard.
 - Use the shift or caps key to switch between lower case and upper case letters.
 - Only the characters that appear on the text input screen can be used for text input.
- 4 Press **F1** or the **ENTER** key on the keyboard.
- 5 Repeat step 3 to input the artist's name.
- 6 Press **F1** or the **ENTER** key on the keyboard.

To use a connected keyboard for other player functions

In addition to character input, the keyboard can be used in a number of other player operations. The table below shows the keys that can be used and their corresponding function.

Key	Function
F1	Text input
F2	Text search
F3	Sub Setup
F4	Play mode
ESC	Return
DELETE	Clear
Arrow keys (←,↓,↑,→)	Cursor control
PAGE UP/PAGE DOWN	Previous/Next
ENTER	Enter

Notes

- If you want to use both the mouse and keyboard, connect them both using a commercially available "Y" cable. Because sometimes "Y" cable connections are reversed, if the keyboard and mouse are ineffective after making connections, try switching the mouse and keyboard connections.
- For compatibility reasons, be sure to use only an IBM* compatible keyboard.

* IBM and PS/2 are registered trademarks of IBM Corporation.

Inputting characters using a PS/2* compatible mouse

Be sure to turn off the power to the player when connecting a PS/2 compatible mouse to the KEYBOARD/MOUSE connection jack on the front panel of this player.

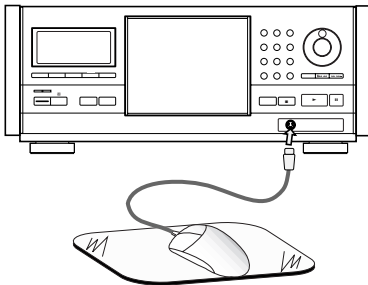

- 1 Click both mouse buttons at the same time. The following menu appears at the bottom of the screen.

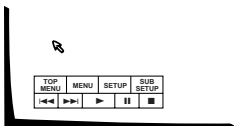

- 2 Move the cursor to SUB SETUP in the menu bar and click the left button.

When the mouse can be used to make a selection, the cursor arrow turns orange.

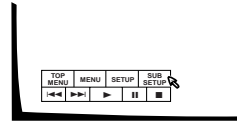

- 3 Click on the disc title or artist's name field that you want to input text for.

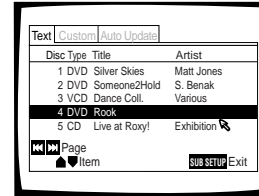

- 4 Click on the characters you want to select.

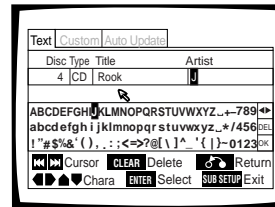

- 5 Click on "OK" on the text input screen to exit the text input screen.
- 6 Repeat steps 3 and 5 to continue input of titles and artist's names.
- 7 When you are finished with input, click on "SUB SETUP".

Notes

- In addition to text input, a connected mouse can be used to perform other player functions by clicking on on-screen command icons.
- If you want to use both the mouse and keyboard, connect them both using a commercially available "Y" cable. Because sometimes "Y" cable connections are reversed, if the keyboard and mouse are ineffective after making connections, try switching the mouse and keyboard connections.
- For compatibility reasons, be sure to use only an IBM* compatible mouse.

* IBM and PS/2 are registered trademarks of IBM Corporation.

Selecting a Disc On-Screen

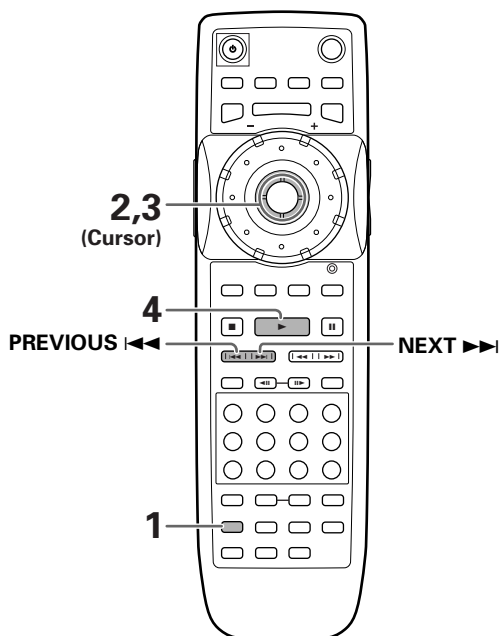

- 1 Press **SUB SETUP**.
- 2 Move the cursor control joystick down to enter the Sub Setup screen Text menu.
- 3 Move the cursor control joystick to highlight the disc number of the disc you want to play. If the disc you want to play is not displayed on the current screen, use **PREVIOUS** ◀◀ and **NEXT** ▶▶ to change the set of discs being displayed.
- 4 Press **PLAY** ▶. Playback of the selected disc begins.

To input disc title and artist name information in the Text menu page

Refer to the section "Inputting and Changing Text Information" starting on page 31.

To perform a disc search for a particular disc number, title, or artist in the Text menu page

Refer to the section "Searching for a Disc, Title, Chapter, Track, or Location on a Disc" on this page.

To sort the discs in the rack according to number, title, or artist in the Text menu page

Move the cursor control joystick right or left to select a category and then press **ENTER**.

- When the Disc column is selected, the discs are sorted by their order in the disc rack.
- When the Type column is selected, the discs are sorted by their format.
- When either Title or Artist columns are selected, the discs are sorted in alphabetical order.

Note

When Master-Slave connections are made, discs on the Master player are numbered from 1 to 300 and 301 to 600 on the Slave player.

Searching for a Disc, Title, Chapter, Track, or Location on a Disc – DVD/Video CD/CD

This player offers different ways of accessing the information on a DVD, Video CD, or CD. Using **SEARCH MODE**, you can search for titles or chapters on a DVD, tracks on a Video CD or CD, and even select the point in time to start playback.

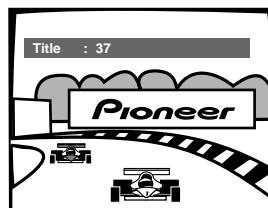
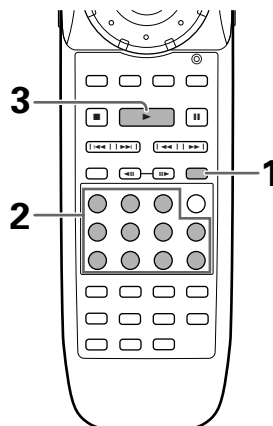

- 1 Press **SEARCH MODE** repeatedly during playback of a disc to select the type of search. The type of search changes which each press as follows.

▶ Title → Chapter/Track

Off ← Disc ← Time ←

 When playback is stopped, only Disc search is performed.

- 2 Press the number button(s) of the desired disc, title, chapter or track or of the specific time where you would like to begin playback.
 - To select number 3, press **3**.
 - To select number 10, press **1** and **0**.
 - To select number 37, press **3** and **7**.
 - To select number 256, press **2**, **5**, and **6** (disc only).**When performing a time search:**
 - To select 21 minutes, 43 seconds, press **2**, **1**, **4**, and **3**.
 - To select 1 hour, 14 minutes, press **7**, **4**, **0**, and **0**.

- 3 Press **PLAY** ▶. Playback of the selected disc, title, chapter or track starts. When a time search is performed, playback begins at the appointed time.

To perform a direct title or chapter/track search using the number buttons

Press the number buttons while the disc is stopped to select a title number.

Press the number buttons while the disc is playing to select a chapter or track.

- To select number 3, press **3**.
- To select number 10, press **+10** and **0**.
- To select number 37, press **+10**, **+10**, **+10** and **7**.

Notes

- For some discs, selection can be made using the top menu on the DVD. In this case, press **TOP MENU** to display the menu screen and then make your selection.
- With some DVDs, the search operation may not be possible and may stop shortly after being performed. In this case, the  mark is displayed.
- Time search is not possible with CDs.
- When performing DVD time search, playback may start from a slightly different time than that specified.
- Time search is not possible during when the disc is stopped.
- Search using **SEARCH MODE** is not possible during PBC playback of Video CDs.

Searching for a disc by format, title, or artist name

There are a number of ways to find a disc that you have loaded in the player. You can search for a disc by disc number, format, title, or artist.

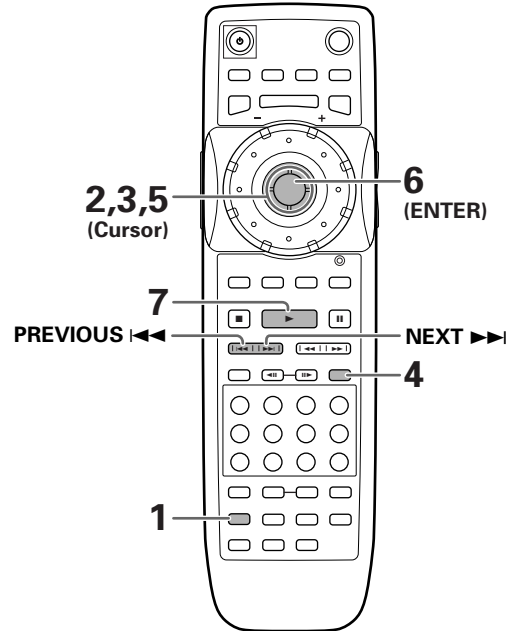

- 1** Press **SUB SETUP**.
- 2** Move the cursor control joystick down to enter the Text menu.
- 3** Move the cursor control joystick to one of the column headings on the screen, that you want to use as the basis of your search.
- 4** Press **SEARCH MODE**.

5 Input the appropriate search item for each type of search as follows.

- For a disc number search, move the cursor control joystick down to the nearest number to the disc you want to access.

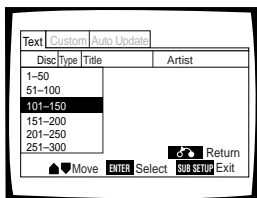

- For a format search, move the cursor control joystick down to the appropriate format.

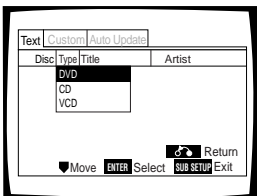

- For a title and artist searches, use the cursor control joystick to select a character (letter, number, symbol) corresponding to the first character of the disc title or artist's name.

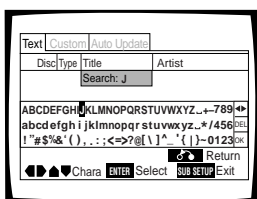

6 Press **ENTER**.

The first group of five titles appears that fit the description of the search. If the disc you are looking for does not appear initially, press **NEXT** ►► to move to the next group of five titles.

7 Move the cursor control joystick to the number of the disc that you want to play, and press **PLAY** ►. Playback of the selected disc begins.

To perform a disc search using controls on the front panel

1 Press **TEXT SEARCH**.

The type of search changes which each press as follows.



2 Turn the selection dial to make a selection.

- Turning the selection dial during a Type search displays the disc types.
- Turning the selection dial during a Title or Artist search displays the characters that can be searched for.

3 Press the enter button.

4 Turn the selection dial to select the disc you want to play.

5 Press ►.

Playback of the selected disc begins.

Creating and Selecting Custom Files

The custom play mode refers to a personalized playback mode in which you can create as many as 20 custom files (10 DVD/Video CD and 10 CD) grouping the various discs in the rack as you like up to 300 discs per file.

To create and select custom files

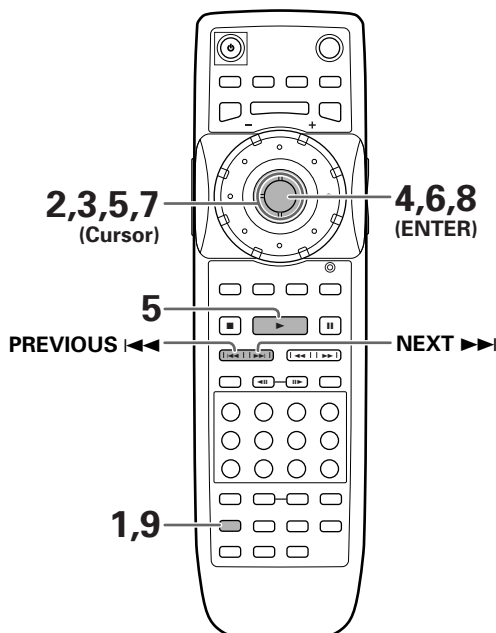

1 Press **SUB SETUP**.

2 Move the cursor control joystick to the right to select the **Custom** menu.

continued

- 3** Move the cursor control joystick down to select one of the custom files.
- Use **PREVIOUS** **◀◀** and **NEXT** **▶▶** to select a different set of custom files.
 - To input a name for the custom file, refer to the section 'To input a name for the custom file' on this page.

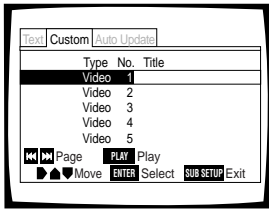

- 4** Press **ENTER** to create or edit the selected custom file or **PLAY** **▶** to start playback of the discs in the custom file.

When you press **ENTER**, the custom file edit screen appears with the cursor at the top of the **Ⓡ** column and the discs registered in the custom file are displayed. To make changes to the custom file, proceed to step 5.

- 5** Move the cursor control joystick right or left to select a category from which to select discs from.

- When the **Ⓡ** column is selected, discs already registered in a custom file can be viewed or removed from the file. Discs that are registered in the custom file appear with a checkmark in the **Ⓡ** column.
- When the Disc column is selected, the discs can be selected in their order in the disc rack.
- When the Type column is selected, the discs can be selected by their format.
- When either Title or Artist columns are selected, the discs can be selected based on alphabetical order.

- 6** Press **ENTER** to sort the discs according to the column selected.

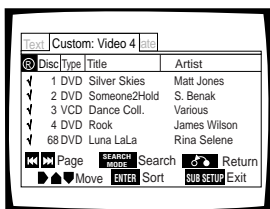

- 7** Move the cursor control joystick up and down to select a disc.

If the disc you want to add to the custom file is not on the screen, use **PREVIOUS** **◀◀** and **NEXT** **▶▶** to select a different group of discs.

- 8** Press **ENTER** to add the disc to the custom file.

- A check mark appears in the **Ⓡ** column when a disc has been successfully added.
- When adding discs to a custom file, please note that only DVDs and Video CDs can be registered in a video custom file and only CDs can be registered in an audio custom file.

- 9** When you are finished, press **SUB SETUP**.

To remove a disc from the custom file

Follow the procedure above to locate the disc you want to remove from the custom file and press **ENTER**. When a disc has been successfully removed from the custom file the checkmark in the **Ⓡ** column is not displayed.

To input a name for the custom file

- 1 In the **Custom** menu, move the cursor control joystick up or down to select one of the custom files.
- 2 Move the cursor control joystick right to highlight the title field for the selected custom file.
- 3 Press **ENTER**.
- 4 Input a title following the text input procedures in the section "Inputting and Changing Text Information" on page 31.

To select a custom file using controls on the front panel.

Press **AUDIO/VIDEO** if necessary to light the appropriate **AUDIO** or **VIDEO** indicator in the display window. Then press one of the **DIRECT CUSTOM** number buttons. The custom file corresponding to the number pressed begins.

To input a name for the custom file using controls on the front panel

- 1 Press **TEXT INPUT** after following the above procedure to select a custom file.
- 2 Input a title following text input procedures in the section "Inputting characters using controls on the front panel" on page 33.

To add the currently playing disc to a custom file

During playback of a disc you want to add to a custom file, press the **DIRECT CUSTOM** number button of the custom file you want the disc to be added to. The disc is automatically placed in the appropriate custom file. Please note that DVDs and Video CDs are automatically placed in a video custom file and CDs are automatically placed in an audio custom file.

Note

During playback of a custom file, the play mode is set to custom. To select either the single or **ALL** play mode, press **PLAY MODE** repeatedly until the play mode you want is selected.

Adjusting Audio and Video Settings

Using the Setup Screen Menus

The procedure on this page describes how to operate the menus on the Setup screen. These menus are used to set and adjust a number of system settings. The various functions that can be adjusted are covered throughout this manual. The procedure on this page provides a basic outline for using the Setup screen menus.

When setting up for the first time

It is recommended to set up the player using the Setup Navigator (page 20). If you selected "Not Used" when the Setup Navigator appeared, you may still set up the player using the Setup Navigator in the **General** menu screen.

If you choose not to use the Setup Navigator, be sure to make the necessary settings in the Setup screen

Audio 1, Audio 2, Video, and Language menus as described on the following pages.

Note

If the Setup screen is opened during playback of a DVD being viewed in the letter box format, the screen may switch to the wide screen format. This is not a malfunction, and the screen will return to normal when the Setup screen is closed.

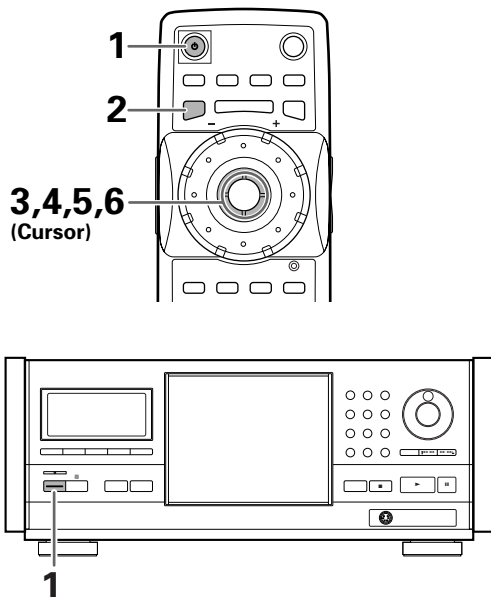

- 1 Press (STANDBY/ON on the front panel).

- 2 Press **SETUP**.
The Setup screen appears.

(Example)

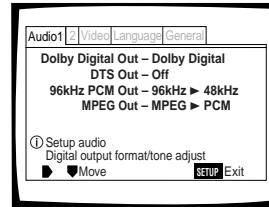

- 3 Move the cursor control joystick right or left to select the menu you want.

As each menu is selected with the cursor, the settings appear below the menu heading.

- 4 Move the cursor control joystick down to enter the menu.
The top item within the menu becomes highlighted.

(Example)

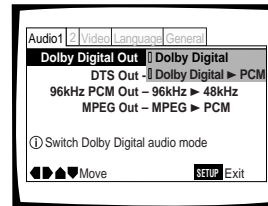

- 5 Move the cursor control joystick up or down to select the setting you want to change.

The options available for each setting appear to the right when the setting is selected. The current setting appears with the setting indicator lit.

- 6 Move the cursor control joystick right to enter the setting options.

(Example)

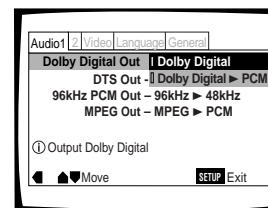

- Not all menu options can be changed while a disc is playing. In these cases, the options appear grayed out on the screen and cannot be adjusted. To change these settings, press **STOP** first before pressing **SETUP**.
- Operating the menu after pressing **STOP** may cancel the resume function.
- Some menu options are not immediately effective if set while a disc is playing. To make these settings effective, stop playback and then start again, or change the settings while the disc is stopped.

IMPORTANT

Changing to the Setup Screen "Expert" Menu Mode

The Setup screen menus are divided into two levels, "Basic" and "Expert", to make this unit more convenient to operate for different levels of users. The "Basic" menu mode contains functions that may be considered necessary for the basic operations of this player and helpful on-screen information identified by the ⓘ mark. The "Expert" menu mode adds to the "Basic" menu mode additional functions of the player that can be adjusted to further personalize performance of the player.

In this manual, functions that are contained in the "Expert" menu mode are identified by the  icon. Make changes to the [Setup Menu Mode] setting in the Setup screen **General** menu.

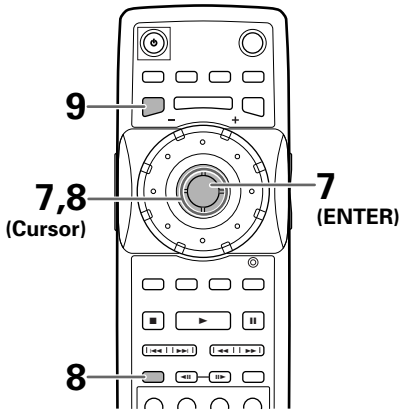

7 Move the cursor control joystick up or down to select a new setting and press **ENTER** to set the new setting in memory. Press **RETURN** or move the cursor control joystick left to exit the options without making any changes.

8 Press **RETURN** or move the cursor control joystick left to go back to the main menu bar to select another menu.

9 Press **SETUP** to close the Setup screen. The Setup screen closes.

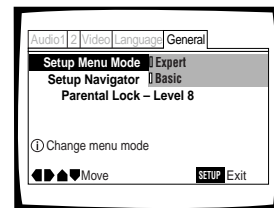

Settings: **Expert**
Basic*

* Factory setting

Note

On-screen information only appears in the "Basic" menu mode.

How to interpret the setting indicator colors in the Setup screen menus

When setting up the system, or when making adjustments, it is convenient to know what settings are applicable to the different disc formats. When the settings appear for each menu option, the currently selected setting appears with the setting indicator highlighted in one of three colors: blue, green or yellow. These colors correspond to what formats the menu option effects as shown in the table below.

Color of indicator	Disc format(s)
Blue	DVD only
Yellow	DVD / Video CD
Green	All compatible formats

Note

If a setting applicable only to DVDs is changed while a Video CD or CD is selected, a blue DVD icon appears in the upper right hand corner of the screen to indicate that the setting is not applicable to the disc that is currently playing. The setting will be effective the next time a DVD is played.

Setting the Digital Audio Output To Be Compatible with Your AV Component – DVD

This player is capable of digital audio output for Dolby Digital, DTS, MPEG, and signals with a sampling rate of 96 kHz. Make settings in the Setup screen **Audio 1** menu to reflect the capabilities of the components that you have made digital connections to.

Notes

- If you have already completed the Setup Navigator screen operations, the settings on this page have already been set by the player.
- If you have made only stereo line connections (analog) using the supplied audio cord, it is not necessary to make any changes in this menu.

Dolby Digital Out

This player is capable of outputting the Dolby Digital surround sound audio signal. When the player is connected to an AV component that has a built-in Dolby Digital decoder, select "Dolby Digital". This player can also convert the Dolby Digital signal to a digital Linear PCM signal, the same digital signal output from a CD. Select "Dolby Digital ► PCM" when you have made connections to an amplifier or receiver with a Dolby Pro Logic decoder or a Digital Analog Converter (DAC).

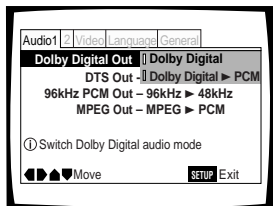

Settings: **Dolby Digital***
Dolby Digital ► PCM

*Factory setting

Note

When the Virtual Dolby Digital function is on during playback, and "Dolby Digital ► PCM" is selected in the [Dolby Digital Out] setting in the Setup screen Audio 1 menu, there is no audio output from the digital output jacks.

DTS Out

This player is capable of outputting DTS digital audio for DVDs recorded in DTS. When this player is connected to an AV component that has a built-in DTS decoder, select "DTS". If your system is not equipped to decode DTS, select "Off". Refer to the operating instructions supplied with your audio components if you are unsure about compatibility with DTS.

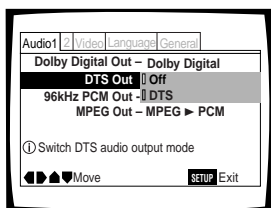

Settings: **Off***
DTS

* Factory Setting

Note

If you have made digital audio connections to component(s) not equipped to decode the DTS digital bitstream, be sure to select "Off". If a DTS signal is output without decoding, the output is digital noise that could potentially cause damage to your speakers.

96 kHz PCM Out

This player is capable of outputting digital signals with a sampling frequency of 96 kHz. If you have made connections to a component capable of processing this signal rate, select "96 kHz" for the signal to be output as is. As some components are incapable of processing digital signal input with sampling rates of 96 kHz, selecting "96 kHz ► 48 kHz" compresses the signal to a standard signal with a sampling rate of 48 kHz.

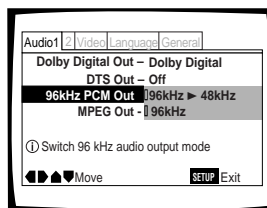

Settings: **96 kHz ► 48 kHz***
96 kHz

* Factory Setting

Notes

- On DVDs that contain copy protection, the 96 kHz signal may only be output from the analog audio jacks. When this type of disc is encountered, even if "96 kHz" is selected, the player automatically outputs the digital audio signal at a compressed rate of 48 kHz.
- When a DVD is played back in the letter box format, Linear PCM digital audio playback is output is automatically downsampled to 48 kHz (when the original signal is 96 kHz). In order to hear audio at the sampling rate of 96 kHz, set the Setup screen **Video** menu [TV Screen] setting to either "Wide" or "4:3 (Pan & Scan)" (page 43).
- Changes to the [96 kHz PCM Out] setting cannot be made when a disc is playing.

MPEG Out

This player is capable of outputting the MPEG digital bitstream. When the player is connected to an AV component that has a built-in MPEG decoder, select the "MPEG" setting. Otherwise, select "MPEG ► PCM" to convert the digital signal to the PCM signal, the digital signal output from a CD.

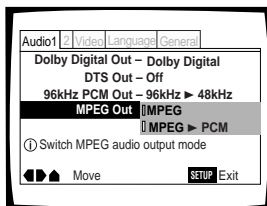

Settings: **MPEG**
MPEG ► PCM*

* Factory Setting

Turning the Digital Output On and Off Expert

Depending on your preferences and the type of connections made, you may opt not to have the digital audio signal output at all. When this setting is set to "Off" there is no signal output from the digital audio output jacks.

Make changes to the [Digital Out] setting in the Setup screen **Audio 1** menu in the "Expert" menu mode (page 40).

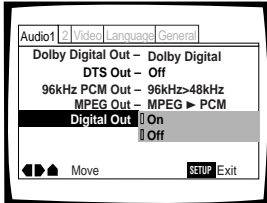

Settings: **On*** (Digital bitstream is output.)
Off (Digital bitstream is not output.)

* Factory Setting

Adjusting the OSD (On-Screen Display)

If you have already completed the Setup Navigator screen operations, the settings on this page have already been set by the player.

Setting the on-screen display (OSD) language

This setting is used to establish the language that operation indicators and on-screen messages and operations display. Change this setting in the Setup screen **Language** menu [OSD Language] setting.

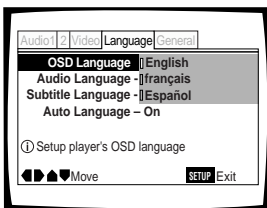

Settings: **English***
français
Español

* Factory Setting

Note

The [OSD Language] setting is factory set to "English". If you want English to be displayed, it is not necessary to adjust this setting.

Turning the on-screen display on or off Expert

If you would rather not have the operation indicators (Play, Stop, Resume, etc.) and other messages displayed on the screen, it is possible to turn them off in the [On Screen Display] setting in the Setup screen **Video** menu in the "Expert" menu mode (page 40).

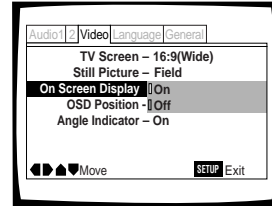

Settings: **On***
Off

* Factory Setting

Setting the position of the on-screen display Expert

When watching conventional software on a wide screen TV, the operation display is at the very top of the screen, and may be difficult to see. Changing the position of the display lets you see operation indicators clearly even on a wide screen TV.

Make changes in the [OSD Position] in the Setup screen **Video** menu in the "Expert" menu mode (page 40).

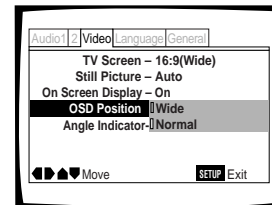

Settings: **Wide**
Normal*

* Factory Setting

Note

This setting is only effective with DVDs that contain a 4:3 aspect ratio video presentation.

Setting the TV Screen Size

The width-to-height ratio of conventional TVs is 4:3, while the width-to-height ratio of wide screen and high-definition TVs is 16:9. This width-to-height ratio is called the aspect ratio.

When viewing software recorded in different aspect ratios, the image's height to width ratio can be switched to match the TV or monitor being used.

Make changes to the TV screen size in the [TV Screen] setting in the Setup screen **Video** menu. Please note that changes to the [TV Screen] setting cannot be made when a disc is playing. Stop playback of the disc before attempting to make any changes.

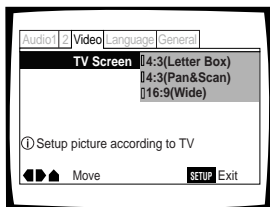

- Settings: **4:3 (Letter Box)**
4:3 (Pan & Scan)
16:9 (Wide)*

* Factory Setting



Notes





- If "Standard (4:3)" is selected in the Setup Navigator screen, "4:3 (Letter Box)" is selected on this screen. If you prefer the pan&scan format, change the settings on this screen.
- Whether the aspect can be switched or not depends on the disc. Please refer to the information written on the disc jacket, etc.
- Some discs may not include the screen format selected in the [TV Screen] setting. When this occurs, the standard TV screen format available on the disc is automatically selected.
- When a DVD is played back in the letter box format, Linear PCM digital audio playback is output is automatically downsampled to 48 kHz (when the original signal is 96 kHz). In order to hear audio at the sampling rate of 96 kHz, select either "Wide" or "4:3 (Pan & Scan)".

Differences in screen sizes and DVD formats

The number of screen size formats currently available can be somewhat confusing. If set incorrectly, the video presentation may not appear as it should. The following diagrams and descriptions are intended to help you set your TV screen size in a way that will allow you to fully enjoy the digital video of DVD.

The settings in the [TV Screen] setting are perhaps most applicable when the DVD you are watching is programmed in the wide screen format. If you have a standard TV, select either "4:3 (Letter Box)" or "4:3 (Pan & Scan)" based on your personal preference. If you have a wide screen TV, select "16:9 (Wide)".

When viewing a wide screen TV or monitor	
DVD screen size format	Setting and Appearance
Wide screen format DVD Please note that there are some wide screen letter box formats that place black bars at the top and bottom of the screen. This is not a malfunction.	 <p>"Wide" setting</p>
Standard screen format DVD When viewing a standard screen format DVD on a wide screen TV, black bars may be automatically placed at the side of the screen to adjust to the DVD format.	 <p>"Wide" setting</p>
Standard screen format DVD (unnatural stretched effect) If you are viewing a standard screen format DVD on a wide screen TV, the picture may appear 'stretched' on the screen. To remedy this condition, change your wide screen TV to display a standard (4:3) screen. Refer to the instructions supplied with your wide screen TV or monitor for more information.	 <p>"Wide" setting</p>

When viewing a standard size TV or monitor	
DVD screen size format	Setting and Appearance
Wide screen format DVD The Letter box presentation places black bars at the top and bottom portions of the screen to provide the full wide screen presentation of a movie on a standard TV (4:3 aspect ratio).	 <p>"Letter Box" setting</p>
Wide screen format DVD The Pan & Scan presentation crops both sides of the wide screen presentation to use the full standard TV screen.	 <p>"Pan & Scan" setting</p>
Standard screen format DVD If you have a standard TV, the standard screen format will be presented regardless of the setting.	 <p>Any setting</p>
Wide screen format DVD (unnatural squeezed effect) If you are viewing a wide screen format DVD on a standard TV and the [TV Screen] setting is set to "Wide", the picture may appear 'squeezed' on the screen. To remedy this condition, select either "Letter Box" or "Pan & Scan".	 <p>"Wide" setting</p>

Setting the Language Options

DVDs have the capacity to contain a great deal of audio information, which includes the ability to hold up to 8 different language tracks and subtitle information in as many as 32 different languages. This section outlines the variety of audio language and subtitle options available with this player.

Please note that if you have completed the Setup Navigator, the audio and subtitle language options have automatically been set in accordance with the OSD language (the language that appears on the screen).

Note

DVDs differ in content and do not all contain multiple language or subtitle information. Therefore making settings in this section may have no effect on some DVDs.

Selecting a Subtitle Language (Multi-Language Subtitles)

– DVD

You can select a desired subtitle language with DVDs that have subtitle data in multiple languages recorded on them.

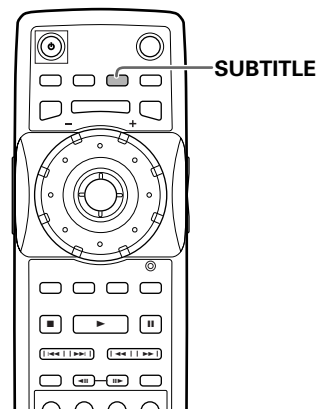
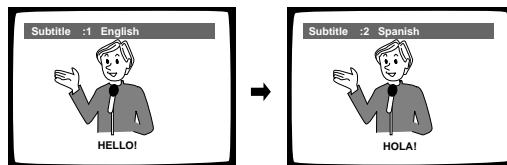

Press **SUBTITLE** repeatedly during playback.

Pressing **SUBTITLE** once displays the currently selected subtitle language. Subsequent presses rotate through the subtitle languages available on the DVD.

Notes

- The subtitle language cannot be switched if the subtitle language is not recorded, or if only one language is recorded.
- Switching the subtitle language may not be possible with some discs. In this case, the  mark will be displayed.
- To clear subtitles during playback, press **SUBTITLE** and then press **CLEAR**, or press **SUBTITLE** until "Off" appears.
- For some discs, subtitle language selection can be made using the menu on the DVD. In this case, press **MENU** to display the DVD menu screen and then make your selection.

Changing the Audio Language (Multi-Language Function) – DVD

Dolby Digital, PCM, and other audio data can be recorded on DVDs in a number of languages or audio tracks, letting you choose the desired language or audio.

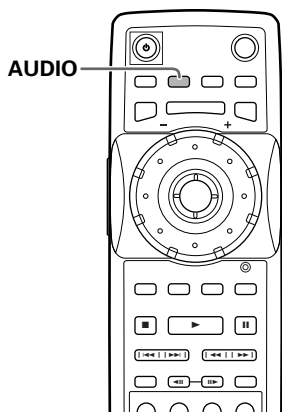
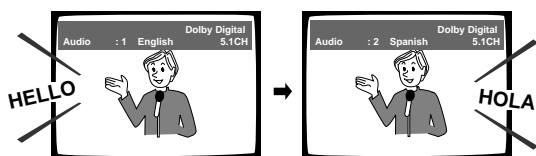

Press **AUDIO** repeatedly to select the desired language.

Pressing **AUDIO** once displays the currently selected language. Subsequent presses rotate through the audio languages available on the DVD.

Notes

- You cannot switch languages if there is only one language recorded on the disc.
- Switching the audio language may not be possible with some titles. In this case, the  mark is displayed.
- For some titles, selection can be made using the DVD menu. In these cases, press **MENU** to display the DVD menu screen and then make your selection.
- Depending on the disc, when the audio track is changed by pressing **AUDIO**, the screen may briefly pause or shake. This is not a malfunction.
- If a DTS audio soundtrack is selected, there is no output from the analog audio jacks.

Changing Audio Type – Video CD/CD

For enjoyment of karaoke or similar format Video CDs and CDs, it is possible to select stereo audio, or either right or left channel mono depending on the requirements of the source.

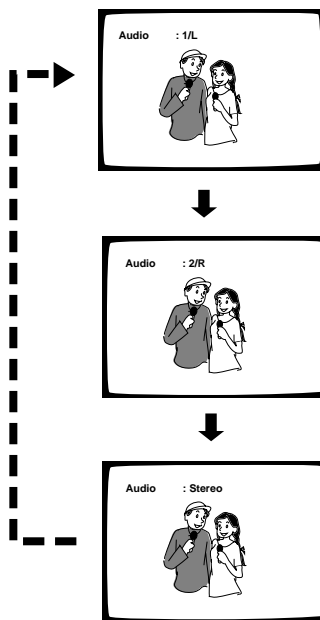

Press **AUDIO** repeatedly during playback to switch the audio type.

Audio output changes from “1/L” (Left channel) to “2/R” (Right channel) to “Stereo”.

Note

With karaoke and other discs, set the appropriate audio type for singing and accompaniment after referring to information on the disc jacket or accompanying material.

Setting Language and Subtitle Preferences in the Setup Screen Menus

The Setup screen **Language** menu contains a number of settings related to the audio and subtitle language preferences.

Please note that changes to the settings in the **Language** menu in this section cannot be made when a disc is playing. Stop playback of the disc before attempting to make any changes.

Selecting an audio language preference

The audio language that you normally listen to can be selected from the various audio languages on a DVD. Even when the audio language is changed during playback by pressing **AUDIO**, the language selected at this setting will be selected as the default when the DVD is changed.

Make changes to the [Audio Language] setting in the Setup screen **Language** menu.



Settings: **English***

French

Spanish

Other (For details on how to select other languages, see 'When "Other" is selected' on the following page.)

*Factory setting

Selecting a subtitle language preference

The subtitle language that you will normally display can be selected from the subtitles programmed on a disc. Even when the subtitle language is changed during playback by pressing **SUBTITLE**, the language selected at this setting will be selected when the disc is changed.

Make changes to the [Subtitle Language] setting in the Setup screen **Language** menu.



Settings: **English***

French

Spanish

Other (For details on how to select other languages, see 'When "Other" is selected' on the following page.)

*Factory setting

When "Other" is selected

When you want to select one of the 136 languages as the main audio language, follow the steps below when the following screen appears.

A language code list can be found on page 73.

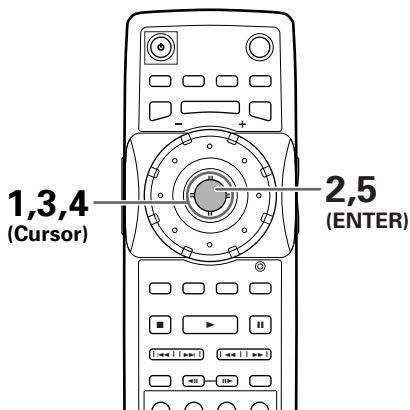
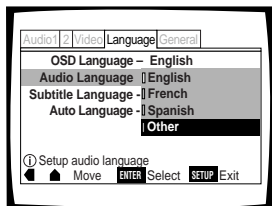

If you select "Code", move the cursor control joystick up or down to input the numbers of the input code. Move the cursor control joystick right or left to change the position of the cursor. You can also use the number buttons to enter the code.

Code (0~2)

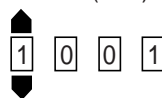

- Press **ENTER** to set the new language. To exit the screen without making any changes, press **RETURN**.

Selecting a DVD menu language preference Expert

In addition to containing different audio languages, DVD may also contain menu screens in different languages as well. Setting a DVD language preference, sets the selected language as a default when DVDs with menu information in that language are encountered.

Selecting "w/ Subtitle Language" automatically assigns the language selected in the [Subtitle Language] setting.

Make changes to the [DVD Language] setting in the Setup screen **Language** menu in the "Expert" menu mode (page 40).

- Move the cursor control joystick to select "Other".

The language selection screen appears.

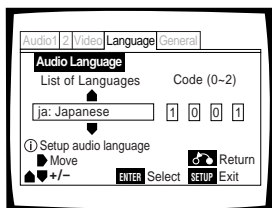

- Press **ENTER**.

- Move the cursor control joystick to select either "List of Languages" or "Code".

- If you select "List of Languages", move the cursor control joystick up or down to select the language.

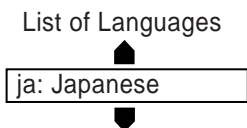

Setting: **w/ Subtitle Language***

English
French
Spanish
Other

* Factory setting

Notes

- The menu settings may look different from the one shown above.
- If this function is not effective, the languages that can be selected may also be selected in the DVD menu. Press **MENU** to open the DVD menu and make your selection accordingly.

Setting Auto Language to control subtitle and audio language based on program content

When the Auto Language function is used, foreign movies are shown with the original audio soundtrack and subtitles in the language selected in the [Subtitle Language] menu option. Domestic films are shown with the original audio soundtrack and no subtitles.

Make changes to the [Auto Language] setting in the Setup screen **Language** menu.



Settings: **On***
Off

* Factory setting

Note

The Auto Language function operates only when this function is set to "On", and the language set for the [Audio Language] and [Subtitle Language] settings is the same.

Selecting subtitles, assist subtitles or no subtitles Expert

Use this function to turn the subtitles on or off. Also, some DVDs provide assist subtitles that give additional explanations of scenes in addition to the standard subtitles for viewers who are hard of hearing. Select "Assist Subtitle" to display these subtitles on DVDs where this function is offered.

Make changes to the [Subtitle Display] setting in the Setup screen **Language** menu in the "Expert" menu mode (page 40).

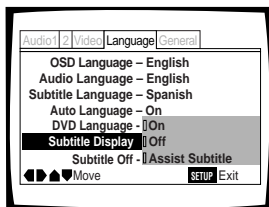

Settings: **On***
Off
Assist Subtitle

* Factory setting

Notes

- If there is no subtitle information recorded on the DVD, no subtitles are displayed even if this function is set to "On".
- This setting serves as a default as to whether or not to display subtitles. Even if this option is set to "Off", subtitles can be displayed by pressing **SUBTITLE**. Similarly, if this option is set to "On", the subtitles can be turned off by pressing **SUBTITLE** and then **CLEAR**.

Selecting the language of forced subtitles Expert

Even when the subtitles are turned off, some DVDs will nevertheless display them on the screen. This setting allows you to select the language of the subtitles to be displayed with this type of DVD.

Select "With Audio" to display the subtitles in the same language as the currently selected audio language. Select "Selected Subtitle" to display the subtitles in the language set in the [Subtitle Language] setting.

Make changes to the [Subtitle Off] setting in the Setup screen **Language** menu in the "Expert" menu mode (page 40).

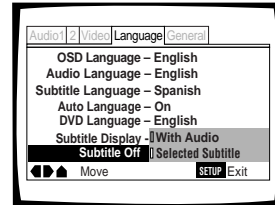

Settings: **With Audio**
Selected Subtitle*

* Factory setting

Advanced Functions

This player is compatible with DVD, Video CD, and CD disc formats. Users already familiar with Video CD or CD will already be familiar with some of the functions the player is capable of performing. With DVD, an even greater number of possibilities and functions are available.

Note

DVDs differ in content and do not all contain the same information. Therefore some functions in this section may not work or have no effect on some DVDs.

Getting Surround Sound from Stereo Speakers – DVD/Video CD

Depending on the audio source, this player is capable of switching between Virtual Dolby Digital (multichannel audio sources) and TruSurround (stereo audio sources) to produce a surround sound effect from stereo speakers.

This function works only when connections are made to the AUDIO OUT jacks.

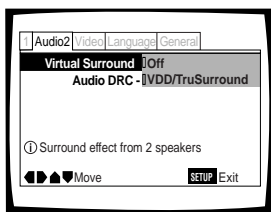

Settings: **Off***

VDD/TruSurround

*Factory setting

Notes

- There is no effect when the audio source is 96 kHz LPCM or during CD playback.
- While the Virtual Dolby Digital function is on, when **AUDIO** is pressed on the remote, "VDD" appears at the upper left of the screen.
- When the Virtual Dolby Digital function is on during playback, and "Dolby Digital ► PCM" is selected in the [Dolby Digital Out] setting in the Setup screen **Audio 1** menu, there is no audio output from the digital output jacks.

TruSurround and Virtual Dolby Digital

TruSurround uses technology that simulates multichannel surround sound using only two speakers. Virtual Dolby Digital works in conjunction with Dolby Digital audio sources to create a realistic surround sound. Virtual Dolby Digital is selected automatically when Dolby Digital sources are loaded.

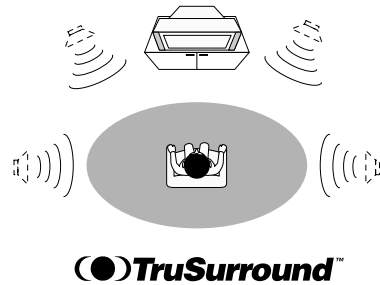

Adjusting the Dynamic Range of the Audio Soundtrack – DVD

Audio DRC stands for Audio Dynamic Range Compression. When Audio DRC is on, soft sounds such as dialog can be heard more clearly without making loud sounds even louder. Select from three levels of compression depending on how much effect you want. When Audio DRC is set to "Off", there is no effect on the audio source.

Make changes to the [Audio DRC] setting in the Setup screen **Audio 2** menu.

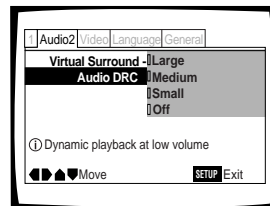

Settings: **Large**

(maximum compression of audio source)

Medium

(moderate compression of audio source)

Small

(slight compression of audio source)

Off*

*Factory setting

Note

Audio DRC is only effective with Dolby Digital audio sources.

Adjusting the Video Quality (Digital Noise Reduction)

– DVD/Video CD

You can either select a preprogrammed setting designed to match certain program types or make adjustments to match your own preferences and save them in the player's memory.

Selecting a preprogrammed setting

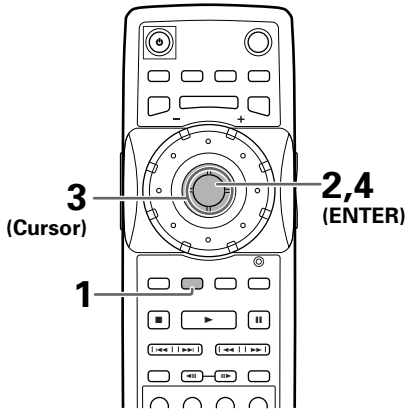

-
- 3** Move the cursor control joystick to select one of the preprogrammed picture quality settings.

Standard*: Preset that presents the source video as it is, with no special adjustments.

Sports: Preset designed to be appropriate for sports and similar media.

Art: Preset designed to be appropriate for art films and similar media.

- If there is a DVD or Video CD playing, the effects of each setting can be viewed while it is highlighted on the screen. This may be useful in selecting an appropriate setting.
- "Memory1", "Memory2", and "Memory3" are user programmable settings. Refer to 'Adjusting the picture quality settings' on the following page for more information on customizing your own picture quality settings.

*Factory setting

-
- 4** Press **ENTER**.

The new selection is set.

Note

Each picture quality setting is defined by a number of individual settings, described in 'Adjusting the picture quality settings' on the following page.

-
- 1** Press **DNR**.

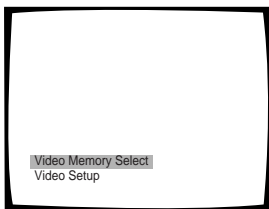

-
- 2** Press **ENTER**.

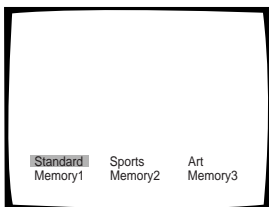

Adjusting the picture quality settings

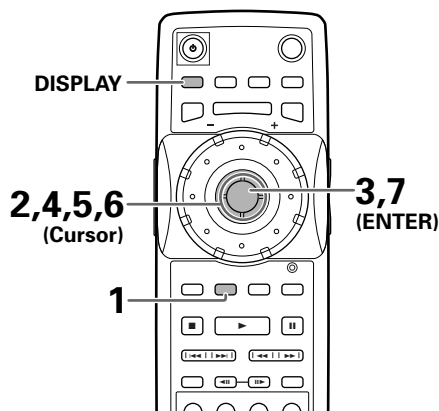

- 1 Press **DNR**.
- 2 Move the cursor control joystick down to select "Video Setup".
- 3 Press **ENTER**.
- 4 Move the cursor control joystick up or down to select the setting to adjust.

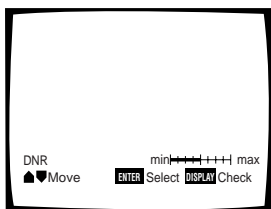

The settings rotate in the following order.

DNR: Adjust to control the amount of signal noise in the luminance component of the video signal.

Sharpness: Adjust the clarity of the picture.

Detail: Adjust the edges in the picture.

Gamma: Adjust the brightness of the darker images in the picture.

Chroma Delay: Adjust the delay of the Y (luminance) and C (color) components of the video signal.

Memory: Select a memory location at which to save your settings.

- 5 Move the cursor control joystick right or left to adjust the settings.

If a DVD or Video CD is playing, the changes will be visible on the screen as they are adjusted.

- 6 Repeat steps 3 and 4 to make adjustments to other settings.

If you would like to save the settings in the player's memory, be sure to select either "1", "2", or "3" in the [Memory] setting to establish which memory location to save the new settings in. Please note that if you select a location where settings have already been saved, the old settings will be replaced by the new ones.

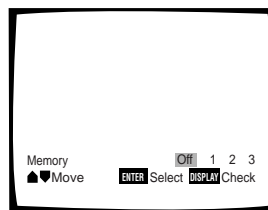

- 7 When you are finished making adjustments, press **ENTER** to establish the new settings.

To display all of the settings at once

Pressing **DISPLAY** while the picture quality setting adjustment screen is displayed enables all of the current settings to be viewed on one screen. Adjustments may also be made when this screen is displayed, by moving the cursor control joystick up and down to select a setting, and right and left to adjust the selected setting.

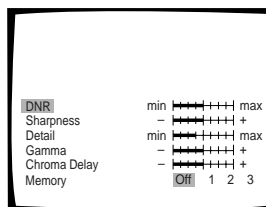

Note

If the Setup screen is opened during playback of a DVD being viewed in the letter box format, the screen may switch to the wide screen format. This is not a malfunction, and the screen will return to normal when the Setup screen is closed.

Still Frame/Slow Play/Frame Advance Playback – DVD/Video CD

The video images on DVD and Video CD can be viewed as a still frame, played back at slow speeds and even advanced frame by frame.

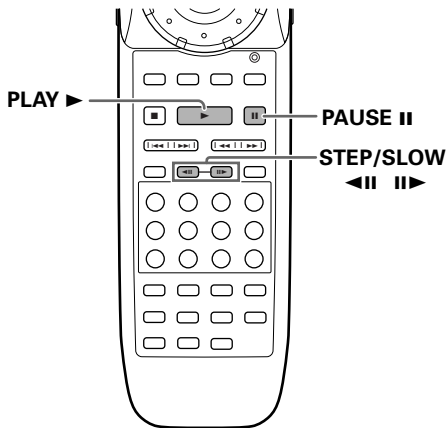

Viewing a still frame

Press **PAUSE**.

When viewing a DVD, if the paused picture shakes, select the "Field" setting in the Setup screen **Video** menu [Still Picture] setting as described in the section below.

To return to normal playback

When viewing a still frame playback, pressing **PAUSE** or **PLAY** restores normal playback operation.

Selecting the type of paused image to display Expert

This function lets you view a clear still-image when DVD playback is paused.

Make changes in the [Still Picture] setting in the Setup screen **Video** menu in the "Expert" menu mode (page 40).

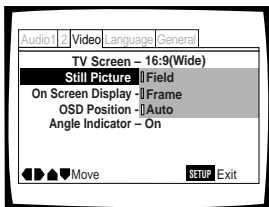

Settings: **Field** (Picture shake will be eliminated during a paused picture.)

Frame (Select to obtain higher picture quality.)

Auto* (Selects field or frame automatically according to the disc.)

* Factory setting

Viewing slow playback

With this function, DVDs can be viewed in both forward and reverse directions. Slow playback of Video CDs can only be viewed in the forward direction.

Press and hold **STEP/SLOW** for about 2 seconds during playback.

- Slow playback is engaged.
- During slow playback, the speed of playback can be adjusted from 1/16 normal playback speed to 1/2 normal playback speed in four steps using **STEP/SLOW**.

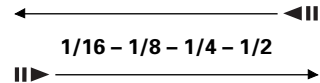

Press and hold **STEP/SLOW** for about 2 seconds during DVD playback.

- Slow playback in the reverse direction is engaged.
- During slow playback, the speed of playback can be adjusted from 1/2 normal playback speed to 1/16 normal playback speed in four steps using **STEP/SLOW**.

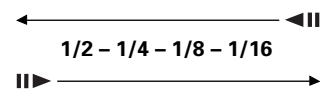

To return to normal playback

When viewing still frames or slow playback, pressing **PLAY** restores normal playback operation.

Frame by frame advance playback: Viewing one frame at a time

With this function, DVDs can be viewed in both forward and reverse directions. Video CDs can only be moved in the forward direction.

1 Press **PAUSE**.

2 Press **STEP/SLOW** or **STEP/SLOW**.

STEP/SLOW: The picture advances one frame each time the button is pressed.

STEP/SLOW: The picture backs up a DVD a few frames each time the button is pressed.

To return to normal playback

When viewing frame by frame playback, pressing **PLAY** restores normal playback operation.

Notes

- There is no sound when viewing still frames or slow playback, or when advancing one frame at a time.
- Still frame, slow play, or frame advance playback may not be possible with certain titles. In this case, the mark is displayed.

Scanning in Forward and Reverse Directions at Different Speeds – DVD/Video CD

This player incorporates technology that enables smooth playback of DVDs and Video CDs not only at different speeds but also in both forward and reverse directions. Video CDs cannot be played slowly in the reverse direction.

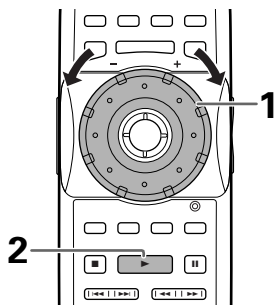

1 Rotate **MULTI DIAL** in the direction you want to scan until the scan speed you want is displayed on the screen.

- Rotate **MULTI DIAL** clockwise to scan in the forward direction.
- Rotate **MULTI DIAL** counterclockwise to scan in the reverse direction.

The incremental rates of scanning is the same in both directions, however, differs depending on the speed at which **MULTI DIAL** is turned as follows.

When **MULTI DIAL** is turned slowly

Clockwise rotation:



PLAY→1/16→1/8→1/4→1/2→1/1→**SCAN 1**→**SCAN 2**→**SCAN 3**

Counterclockwise rotation:



SCAN 3←**SCAN 2**←**SCAN 1**←1/1←1/2←1/4←1/8←1/16→**PLAY**

- It is possible to return to slower scan rates by turning **MULTI DIAL** in the opposite direction.
- Rates preceding "1/1" are slowed playback. "1/1" refers to the normal playback rate. "SCAN 1", "SCAN 2", and "SCAN 3", refer to progressively faster rates of scanning.
- If the dial is turned rapidly after being first turned slowly, the rates of search will jump to the type of scanning described below.

When **MULTI DIAL** is turned quickly

Clockwise rotation:



DVD: SCAN 1→**SCAN 2**→**SCAN 3**
Video CD: SCAN 1→**SCAN 2**

Counterclockwise rotation:



DVD: SCAN 3←**SCAN 2**←**SCAN 1**
Video CD: SCAN 2←**SCAN 1**

- 2 During scanning, turn **MULTI DIAL** quickly in the opposite direction of the search to resume normal playback.

Note

Pressing **PLAY** ► also ends slow or scan playback and returns to normal playback of the disc.

Manual scanning using the Jog Mode – DVD/Video CD

The Jog Mode can additionally be used to locate a frame you want to view, or a scene in a movie you wish to watch at a slow speed.

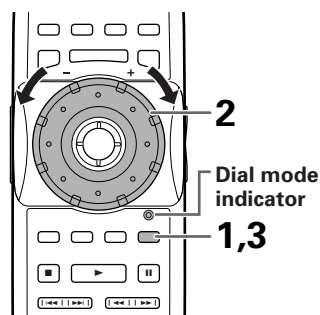

- 1 Press **JOG MODE**.
The dial mode indicator lights red.
- 2 Rotate **MULTI DIAL** clockwise to scan in the forward direction. Rotate **MULTI DIAL** counterclockwise to scan in the reverse direction. Video CDs cannot be scanned in the reverse direction.
 - The rates of scanning are the same in both directions depending on the speed at which **MULTI DIAL** is turned.
 - When **MULTI DIAL** is not being turned, the video image is paused.
- 3 Press **JOG MODE** again to turn the Jog Mode off.
The dial mode indicator turns off.

Notes

- There is no audio when a slow or scan playback function is being performed, even when the speed is "1/1" in forward play.
- Slow or scan playback may not be possible with certain titles. In this case, the mark is displayed.
- With Video CDs, slow or scan playback is not possible when the menu is displayed (PBC playback).
- With Video CDs, slow or scan playback in the reverse direction is not possible.
- Depending on the DVD, slow reverse playback may not be smooth (picture shake or frames jump). This is not a malfunction.

Viewing from a Desired Camera Angle (Multi-Angle)

– DVD

You can select a camera angle when viewing DVDs with the multi-angle option.

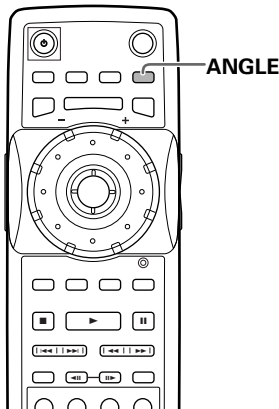
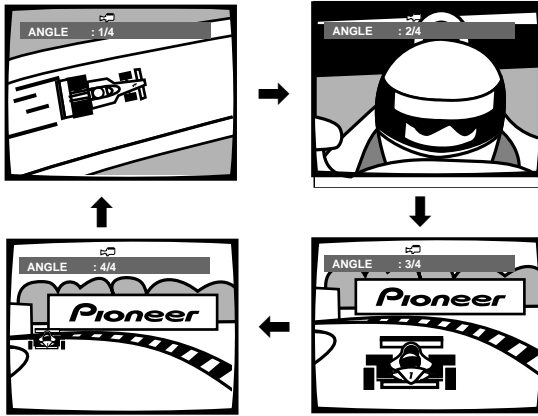

Press **ANGLE** during playback.

The camera angle changes each time you press the button.

Notes

- You can use the Multi-Angle function only with discs featuring recordings of images shot from different camera angles.
- During Multi-Angle playback, the ANGLE indicator in the display lights.
- For some discs, selection can be made using the DVD menu. In this case, press **MENU** to display the DVD menu screen and then make your selection.

To check whether or not a disc is recorded with angles:

The jacket of discs that are recorded with angles will be marked with . When locations on discs that are recorded with angles are played back, the indicator can be displayed.

To cancel the angle mark, set [Angle Indicator] to "Off" in the Setup screen **Video** menu described in the section below.

Turning the angle indicator on and off

When a picture recorded in different angles is played back, is displayed on the screen. This setting lets you see clearly whether the playback picture is recorded in multiple angles or not.

Turn the angle indicator on or off in the [Angle Indicator] setting in the Setup screen **Video** menu in the "Expert" menu mode (page 40).

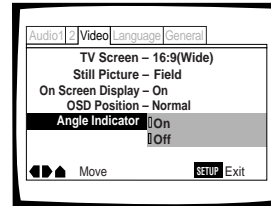

Settings: **On*** (is displayed)

Off (Not displayed)

* Factory setting

Note

Even when the [Angle Indicator] setting is set to "Off", the ANGLE indicator in the display panel of the player lights during multi-angle playback. Therefore, it is possible to know when the multi-angle function can be used without having to display the icon on the screen.

Repeat Play – DVD/Video CD/CD

You can repeat an entire title, chapter or track, or just a part.

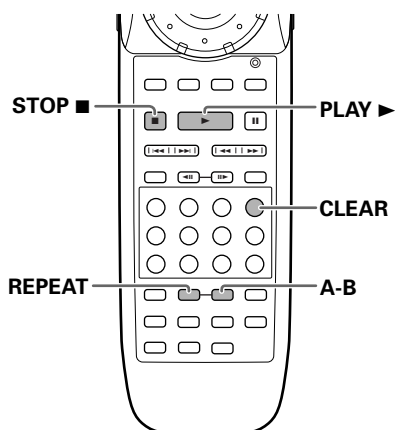

Repeat play of a chapter/track

Press **REPEAT** once during playback of the chapter or track you want to repeat.

Repeat play of a title/disc

Press **REPEAT** twice during playback of the title you want to repeat.

- With DVDs, the title continues playing until the end, and then playback starts once more from the beginning of that title.
- With CDs and Video CDs, repeat play differs according to the current play mode. In single play mode, only the current disc is repeated. In ALL play mode, all of the Video CDs and CDs in the rack are played and then repeated in the same order. In custom play mode, all of the Video CDs and CDs in the current custom file are played and then repeated.

To repeat a program

Press **REPEAT** once during program playback to repeat the program.

To repeat Best Play

Press **REPEAT** once during Best Play to repeat the Best Play program.

To repeat random play

Press **REPEAT** once during any of the random playback modes. When random playback is repeated, the tracks will be played in a different random order.

To cancel repeat play

Press **STOP** ■. Press **CLEAR** if you want to cancel repeat playback and continue normal playback.

Repeat play of a specified section

Press **A-B** at the beginning and end of the section you want to repeat.

- When **A-B** is pressed a second time, the disc returns to the location where **A-B** was pressed first and plays the selected section repeatedly.
- You can only perform A-B repeat within the same title, chapter, or track.

To cancel A-B repeat play

Press **CLEAR**. Playback continues, but the repeat function is canceled.

Return to a specified location on a disc

- 1 Press **A-B** at the desired location.
- 2 When you want to return to the specified location, press **PLAY** ►.

To clear the specified location

Press **CLEAR** to cancel repeat play or to clear the specified location that was set using **A-B**.

Notes

- With some DVD discs, there may be times when repeat playback is not possible. In these cases, the  mark will appear on the screen.
- With Video CDs, repeat play is not possible when the menu is displayed (PBC playback). To perform repeat play, start playback without displaying a menu by pressing the track number to be repeated when the disc is stopped, and then press **REPEAT**.

Random Play – DVD/Video CD/CD

Play titles, chapters, tracks, or discs in random order depending on the play mode..

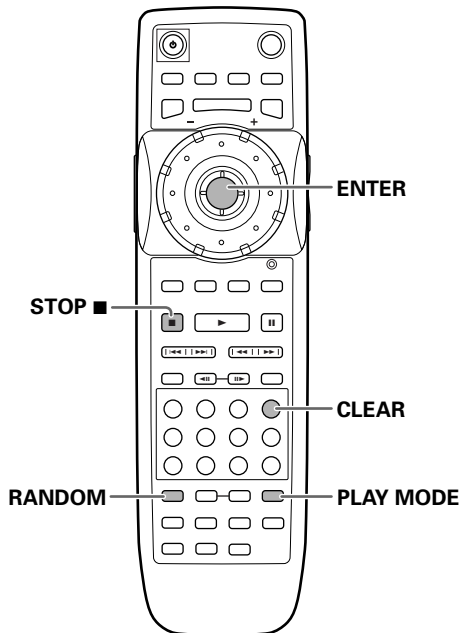

Random playback in Single play mode

Random playback of DVDs

Press **RANDOM** repeatedly to select the random play mode you want, then press **ENTER**.

The random playback mode changes each time **RANDOM** is pressed as follows.

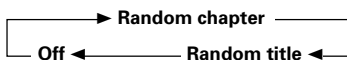

“Random Chapter” and “Random Title” appear on the screen to indicate the current random play mode.

Random playback of Video CD or CD tracks

Press **RANDOM**.

“Random” appears on the screen, and random playback begins.

Random playback of CDs and Video CDs in ALL and custom play modes

Press **RANDOM** repeatedly to select the random play mode you want, then press **ENTER**.

The random playback mode changes each time **RANDOM** is pressed as follows.



“Random 1 Disc” plays all the tracks on the current Video CD or CD in random order. “Random All” plays all of the tracks on all of the discs in the current play mode in random order. When random playback of discs is performed, DVDs will be ignored.

To change titles, chapters, or tracks during random play

- Press **NEXT** ►► and the next randomly selected track starts playing.
- Press **PREVIOUS** ◀◀ and playback of the current track starts again from the beginning.

To stop random play

Press **STOP** ■. Press **CLEAR** if you want to cancel random playback and continue normal playback from the currently selected disc and track.

Notes

- With Video CDs, random play is not possible during playback when the menu is displayed (PBC playback). To perform random play, start playback without displaying a menu by pressing a track number button while in the stop mode, and then press **RANDOM**. However, this may cancel Random play in ALL or custom play modes.
- Random play of programmed chapters/tracks is not possible.
- In the case of DVDs, random playback may not be possible with some discs.
- In ALL and custom play modes, if any of the discs contain more than 25 tracks, random play plays the same number of tracks as the total number of tracks on the discs, but the tracks with track number 26 or higher are not always played once.

Playback in a Desired Order (Program Play) – DVD/Video CD/CD

The titles and chapters on a DVD and similarly the tracks on a Video CD or CD can be arranged to play in the order you want. You can create a program mixing titles, chapters, and tracks on all of the discs loaded in the disc tray.

Programming

A program with a maximum of 36 steps can be memorized from any of discs loaded in this player.

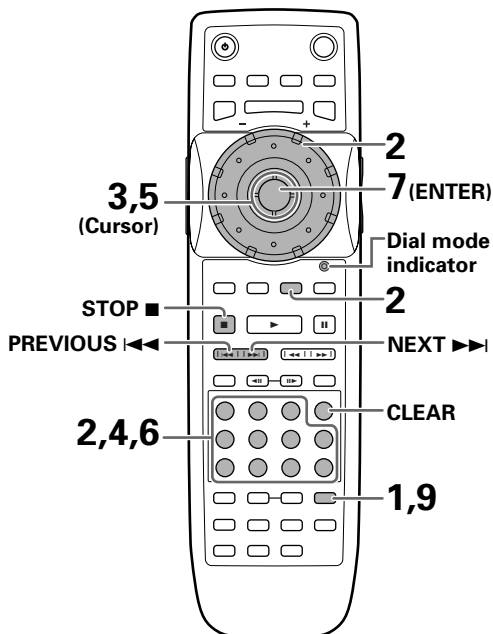

1 Press **PROGRAM**.
The Program screen appears.

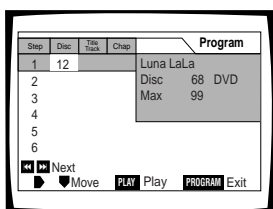

2 Use the number buttons to enter a disc number. By pressing **SELECT DISC NUMBER** (the Jog mode indicator light green), you can also turn **MULTI DIAL** to select the disc number.

- If this is the first step you are programming, the number of the disc that is currently selected appears automatically.
- If the player has already read the contents of the disc you want to program, the disc information appears in the box on the right side of the screen (type of disc, title, artist name, etc.). If the player has not yet read the disc then “? ? ?” appears in the box for disc type.
- If you want to program the entire selected disc, proceed to step 7.

3 Use the cursor control joystick right to select the Title/Track field.

4 Use the number buttons to enter the numbers of the title or tracks in the order you want to program them in.

- For DVDs, this number will be a disc title; for Video CDs and CDs, a track number.
- To enter title/track 6, press **6**. To enter title/track 14, press **1, 4**.

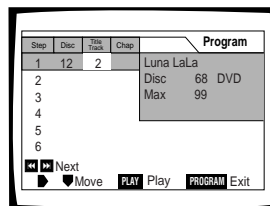

Notes

- If the current disc is a DVD, and you want to program chapters, proceed to the next step.
- If the current disc is a Video CD or CD, or if you want to program entire titles on a DVD, proceed to step 7.

5 Use the cursor control joystick right to select the Chapter field.

6 Use the number buttons to enter the numbers of the chapter in the order you want to program them in.

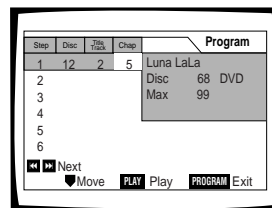

7 Press **ENTER**.





- The cursor moves down to the disc number field in the next step set.

8 Repeat steps 2 to 7 to add additional steps to the program.





9 Press **PLAY** to start playback in the programmed order.

- Press **PROGRAM** to exit the program screen.
- The program remains active even if you open the hood and change discs. If a step in the program cannot be played (because the track number is too high, for example), that step is automatically skipped.

To confirm the contents of a program

- 1 Press **PROGRAM**.
- 2 Use **PREVIOUS**  or **NEXT**  buttons to jump to the next/previous page of six steps (/  on the front panel cannot be used to perform this operation).
- 3 Press **PROGRAM** to exit the program screen.

To change the contents of a program

- 1 Press **PROGRAM**.
- 2 Jump to the page of steps with the contents you want to change using the /  buttons (/  on the front panel cannot be used to perform this operation).
- 3 Move the cursor control joystick up or down to select the step you want to change.
- 4 Move the cursor control joystick right or left to select the appropriate field.
- 5 Press the number button(s) of the number you want to change.
- 6 Press **PROGRAM** to exit the program screen.





To add to a program

Add a new Disc, Title/Track or Chapter at the end of the program by following the steps in the section "Programming" on the previous page.

To repeat the contents of a program

During program playback, press **REPEAT**. The entire program will be repeated.

To delete a step in a program

- 1 Press **PROGRAM**.
- 2 Jump to the page with the contents you want to delete using the /  buttons (/  on the front panel cannot be used to perform this operation).
- 3 Move the cursor control joystick up or down to select the step you want to delete.
- 4 Press **CLEAR**.
- 5 Press **PROGRAM** to exit the program screen.



To clear the entire program

Pressing **CLEAR** when the disc is stopped will clear all program data.

To stop program play

Press **STOP** .

Notes

- If a chapter is programmed for a disc that has not yet been read by the player ("???" is displayed), and a CD or Video CD is later detected in that disc position, the chapter program information is cleared. Additionally, if there is no disc in the selected disc position, or if the programmed chapter number is larger than the number of chapters in the selected title, the chapter program information is erased.
- During DVD playback, when a chapter that cannot be played as part of program playback is encountered,  or  is displayed, and the program automatically proceeds to the next chapter.
- Programming is not possible during PBC playback of Video CDs. To program Video CDs, stop playback before attempting to make a program.
- During programmed playback, if the rack is rotated to play a DVD, an asterisk may be displayed in the upper right corner of the screen. This is to indicate that there is information on the disc that must be played first (First Play PGC). Depending on the disc, the asterisk may blink continuously during playback of chapters that were not programmed and then disappear shortly before playback of the desired location on the disc.

To make an ongoing program of your favorite titles, chapters and tracks (Best play) – DVD/Video CD/CD

With this player, it is possible to make an ongoing program of up to 50 of your favorite chapters or tracks while watching DVDs or Video CDs or while listening to CDs.

To add a title, chapter, or track to the Best play program

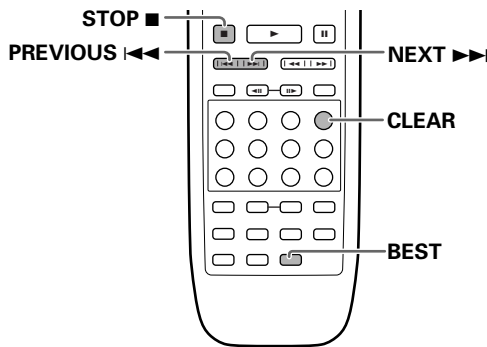



Press **BEST** at any point during playback of a title, chapter, or track you want to program, and it will be added to the Best play program. When a step is successfully added, the BEST indicator blinks in the display window.

- Up to 50 steps can be memorized. When this number is exceeded, steps are erased from the least recently memorized.
- Depending on the DVD, it may not be possible to add the titles or chapters of some discs. When this occurs, on-screen information or  will be displayed.
- Tracks on Video CDs cannot be added to the Best play program while PBC playback is on.

To perform Best play

Press **BEST** when playback is stopped, and playback begins from the most recently memorized step, and proceeds in reverse chronological order.

- When Best play is being performed, “Best” appears in the upper right corner of the screen when the discs are being changed.
- Press **PREVIOUS**  to return to more recent steps and **NEXT**  to move to older steps.

To cancel Best play

Press **STOP** .

To erase a step in the Best play program

Press **CLEAR** during playback of the title, chapter, or track. After the step is erased, playback continues with the next step.

Notes

- The Best play program is preserved even when the player is turned off.
- During Best Play, if the rack is rotated to play a DVD, an asterisk may be displayed in the upper right corner of the screen. This is to indicate that there is information on the disc that must be played first (First Play PGC). Depending on the disc, the asterisk may blink continuously during playback of chapters that were not included in the Best Play program then disappear shortly before playback of the desired location on the disc.

Reviewing Previously Played Discs (Previous Scan)

– DVD/Video CD/CD

This function plays a brief segment from up to 20 previously played discs in reverse chronological order from the most recently played disc.

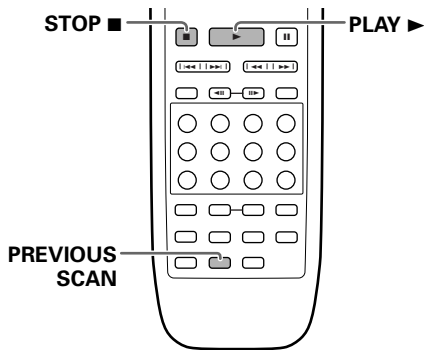

Press **PREVIOUS SCAN**.

The player plays a 10 second portion on each disc in reverse chronological order starting from the most recently played disc.

- When Previous scan is being performed, “Previous” appears in the upper right corner of the screen when the discs are being changed.
- Discs played during random, program, Hi-Lite, Best, and single loader playback are not included in the Previous scan.
- The location on the disc played from each disc may differ according to format and content.

To play a disc played during Previous scan

Press **PLAY** ► (► on the front panel). Playback of the disc starts from the beginning of the disc. A Video CD with PBC cannot be selected in this manner unless PBC is turned off (page 25).

To cancel Previous Scan

Press **STOP** ■ (■ on the front panel). Previous scan is canceled and playback is stopped.

Previewing Discs in the Current Play Mode (Hi-Lite Scan) – Video CD/CD

In this function, the player plays a 10 second portion on each disc in the current play mode.

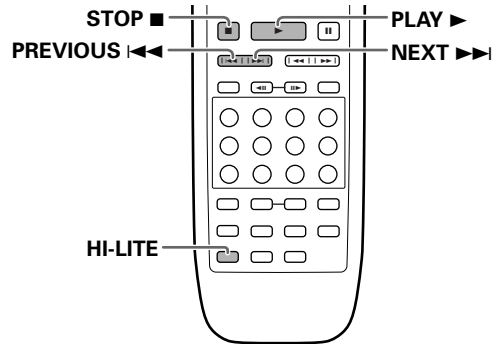

Press **HI-LITE** repeatedly to select the type of Hi-Lite scan.

The type of Hi-Lite scan changes each time **HI-LITE** is pressed as follows.



- Selecting “Hi-Lite Disc” scans a portion on each disc in the current play mode. Selecting “Hi-Lite Track” scans a portion of each track on each disc in the current play mode.
- When Hi-Lite scan is being performed, “Hi-Lite” appears in the upper right corner of the screen when the discs are being changed.
- When **HI-LITE** is pressed during Program play or Best play, the player plays a 10 second portion of each track in the program or Best play program.
- **PREVIOUS** ◀◀ and **NEXT** ▶▶ can be used to skip to different tracks on a disc or to different discs.
- If the first track is less than 1 minute long, the first 10 seconds are played. If the first track is less than 10 seconds long, it is played in its entirety.

To return to standard playback

Press **PLAY** ► (► on the front panel) when Hi-Lite scan reaches a track you want to play.

To cancel to Hi-Lite scanning

Press **STOP** ■ (■ on the front panel).

Notes

- This function does not work with DVDs. When a DVD is detected in the rack, it is skipped, and the player proceeds to the next Video CD or CD.
- When a Video CD with PBC is encountered, the menu screen will be displayed for 10 seconds, and the Hi-Lite scan proceeds to the next disc even during an all track Hi-Lite scan.
- If the player is in ALL repeat mode, Hi-Lite scan will also be repeated.

Continuing Playback from a Specified Location (Last Memory) – DVD

The Last Memory function is convenient when you want to continue viewing a disc from the point where you were watching before. Unlike the resume function, the Last Memory function is effective even if the DVD is removed from the player.

Memorizing a Last Memory location to return to later

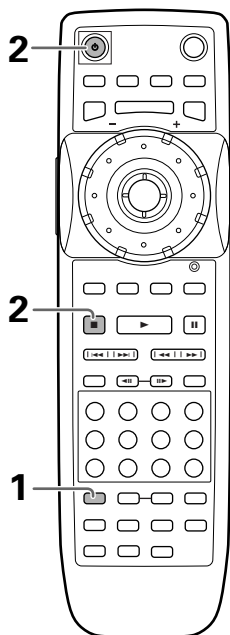

1 Press **LAST MEMORY** during play.
The LAST MEMORY indicator lights on the player.

2 Press **STOP** to stop playback, or **POWER** to put the power in standby.
Once memorized, the memorized point will be recalled even if the power is put in standby, or if the disc is ejected. Points on up to 5 discs can be memorized, and those points are recalled the next time any of the discs are played back.

Resuming playback from where LAST MEMORY was pressed

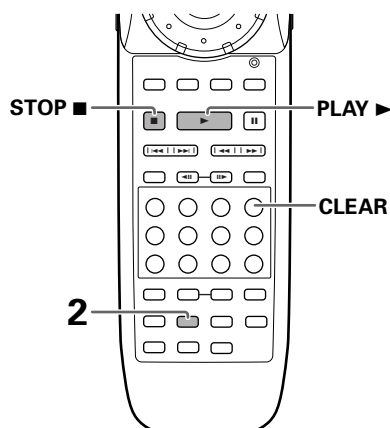

1 Play a disc that has a Last Memory point memorized and then press **STOP** to stop playback.

2 Press **LAST MEMORY**.

The disc begins playback at the memorized point.

- Last Memory mode may not function for some DVDs.
- If you register more than five DVDs, details of the latest disc are memorized, while details of the least recent disc (the disc you registered first) is erased.
- Even with a disc you have memorized with Last Memory, playback begins at the start of the disc if you press **PLAY**.
- This function is only for playback of DVDs.

To clear the Last Memory location

Call up the Last Memory location by pressing **LAST MEMORY**. Then press **CLEAR** while "Last Memory" is still being displayed on the screen.

The LAST MEMORY indicator disappears from the display window.

Memorizing Settings for Often Viewed DVDs (Condition Memory) – DVD

You can store in memory settings for DVDs you often watch. Settings remain in memory even if you remove the disc from the player, or switch power to the player to standby. If you play a disc that has its settings memorized, "COND_MEMO" appears in the display window, and the memorized settings are automatically recalled.

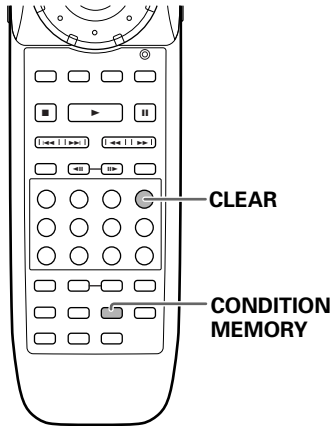

Notes

- Settings are stored in memory for use any time.
- You can store settings for up to 100 DVDs in memory. If you memorize settings for more than 100 DVDs, previously memorized settings are erased in chronological order from the least recently memorized. Subsequently, if you play a disc with erased settings, the settings of the most recently played disc are used.
- If you make changes to any of the settings memorized in Condition Memory, press **CONDITION MEMORY** during playback to memorize new settings.
- Switching of the multi-language mode etc., is automatic on some discs.

Press **CONDITION MEMORY** during playback.

Settings are memorized for the disc currently playing.

The following 6 settings are memorized:

OSD Position (page 42)

Multi-Language subtitles (page 44)

Multi-language (page 45)

Video Adjust (page 50)

Multi-Angle (page 54)

Parental Lock Level (page 69)

When a disc that has memorized settings is played

"Condition Memory" will appear on the screen, and the previously memorized settings will be selected.

Clearing the memorized settings

Play a disc that has memorized settings, and press **CLEAR** while "Condition Memory" is being displayed. Settings memorized for that disc will be cleared.

Memorizing Regularly Used Menu Settings (Function Memory) – DVD/Video CD/CD

You can create a shortcut menu that contains settings that you frequently change and call up this menu whenever you need to change one of the stored settings. Settings remain in memory even if the player is turned off.

Creating the Function Memory item list

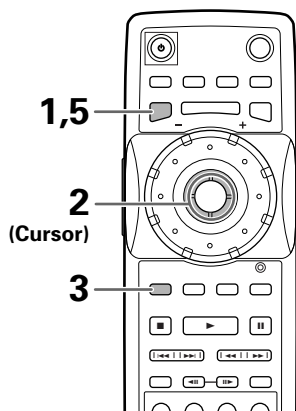

- 1** Press **SETUP** to display the Setup screen.
- 2** Move the cursor control joystick to select the menu and then the menu item you want to add to the Function Memory.
- 3** Press **FUNCTION MEMORY**.
If “FM” appears next to the menu item, the item has been successfully added to the Function Memory.
- 4** Repeat steps 2 and 3 to add as many as 5 items to the Function Memory.
When 5 items have already been stored, “FM” does not appear next to the item when **FUNCTION MEMORY** is pressed.
- 5** Press **SETUP** to close the Setup screen.

Note

Items that cannot be changed when the disc is playing cannot be added to Function Memory if the disc is currently playing. When these items are selected, on-screen information or  will be displayed.

Calling up the Function Memory item list

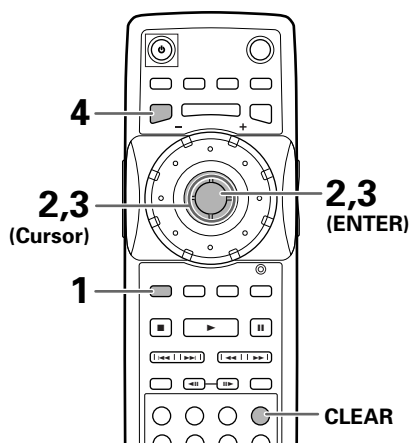

- 1** Press **FUNCTION MEMORY**.
The Function Memory item list appears on the screen.
- 2** Move the cursor control joystick to select the item you want to adjust and press **ENTER**.
The Setup screen opens, and the cursor is moved to the appropriate menu and menu item as selected in the Function Memory item list.
- 3** Move the cursor control joystick to make setting adjustments, then press **ENTER**.
The setting is changed. For more information on making adjustments in the Setup screen menus, refer to the section “Using the Setup Screen Menus” on page 39.
- 4** Press **SETUP** to close the Setup screen.

To clear an item from the FUNCTION MEMORY

- 1** Press **SETUP** to open the Setup screen.
- 2** Move the cursor control joystick to the menu and menu item marked with “FM”.
- 3** Press **FUNCTION MEMORY** to clear the item from the Function Memory. If “FM” disappears, the item has been cleared.
- 4** Press **SETUP** to close the Setup screen.

Viewing Disc Information

– DVD/Video CD/CD

Use **DISPLAY** to get current information about the disc currently playing. You can get information about the titles and chapters on a DVD or tracks on a Video CD or CD. When viewing DVDs, you can also check the digital bitstream transmission rate.

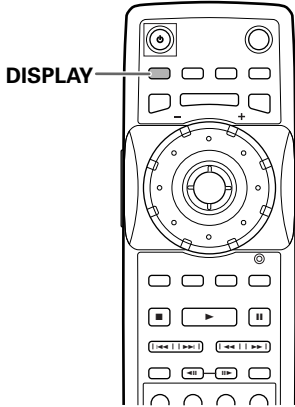

Press **DISPLAY** during while a disc is playing. Press **DISPLAY** repeatedly to change the information being displayed.

The disc information is displayed superimposed over the video image on the screen.

Notes

- Depending on the format and type of disc being used, not all screens may be displayed.
- If text information is not on the disc or text information has not been input for the disc, title and artist information is not displayed.

The display changes for each type of disc as follows each time the button is pressed.

DVD

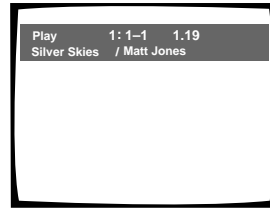

Title and artist information:

Top Row: disc number, title and chapter number, elapsed time of current title

Bottom Row: disc title and artist name (When text is programmed on the disc, chapter text, title text, and/or the disc title is displayed.)

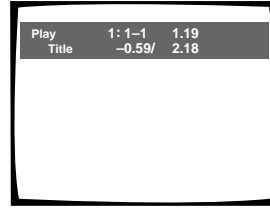

TITLE information:

Top Row: disc number, title and chapter number, elapsed time of current title

Bottom Row: remaining time in title, total time of current title

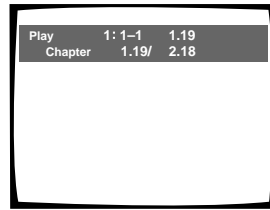

CHAPTER information:

Top Row: disc number, title and chapter number, elapsed time of current title

Bottom Row: time in current chapter, total time of current chapter



CHAPTER information:

Top Row: disc number, title and chapter number, elapsed time of current title

Bottom Row: remaining time in current chapter, total time of current chapter

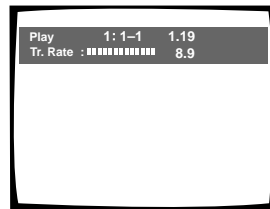

Data transmission rate information:

Top Row: disc number, title and chapter number, total elapsed time of DVD

Bottom Row: bitstream transmission rate level



Display off

Video CD (with PBC turned off)

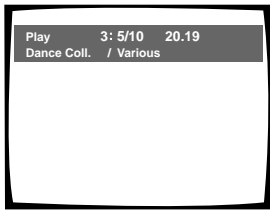

Title and artist information:

Top Row: disc number, title and chapter number, elapsed time of current title

Bottom Row: disc title and artist name (When text is programmed on the disc, track text, and/or the disc title/artist name is displayed.)

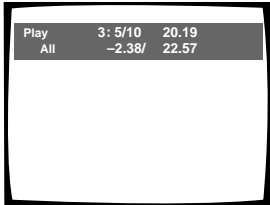

Disc information:

Top Row: disc number, track number, total number of tracks, total elapsed time of Video CD

Bottom Row: remaining time of Video CD, total time of Video CD

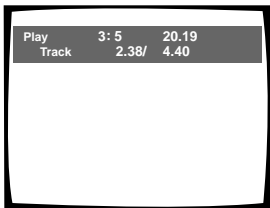

Track information:

Top Row: disc number, track number, total elapsed time of Video CD

Bottom Row: track time, total time of current track

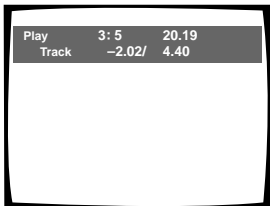

Track information:

Top Row: disc number, track number, total elapsed time of Video CD

Bottom Row: remaining time of track, total time of current track



Display off

CD

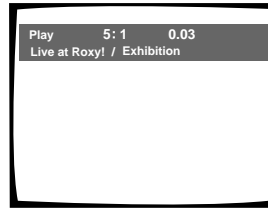

Title and artist information:

Top Row: disc number, title and chapter number, elapsed time of current title

Bottom Row: disc title and artist name (When text is programmed on the disc, track text, and/or the disc title/artist name is displayed.)

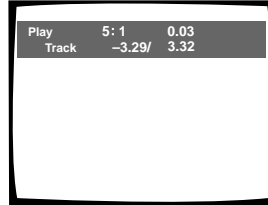

Track Information:

Top Row: disc number, track number, track time

Bottom Row: remaining time of current track, and total time of current track



Disc information:

Top Row: disc number, track number, total number of tracks on CD, total elapsed time of CD

Bottom Row: remaining time of CD, total time of CD



Display off

Press DISPLAY after disc playback has been stopped to display DVD title and chapter information or Video CD and CD track information. Press DISPLAY again to turn the display off.

Information about the titles and chapters or tracks on a disc is displayed. When the information exceeds the space on the screen, move the cursor control joystick right or left (as indicated) to move to other screens.

DVD

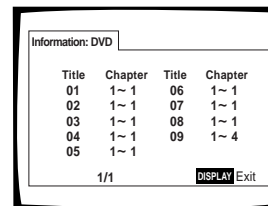

DVD information

With DVDs, each title and the number of chapters within each title is displayed.

CD/Video CD

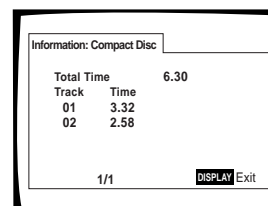

CD and Video CD information

With CDs or Video CDs, the total time of the disc and the time of each track on the disc is displayed.

Connecting to Another Player for Control of 601 Discs

When you have two Pioneer DV-F07 players or decide to add a second Pioneer DV-F07 player to accommodate a growing disc collection, it is possible to make Master-Slave connections to use both players as a single unit for total control of up to 601 discs.

- Before making Master-Slave connections, be sure to complete audio and video connections for the player to be used as the master player (pages 17 and 18).
- When you are adding a second player, it is recommended to use the second player as the Slave player.
- Master-Slave connections can only be made to another Pioneer file-type DVD player. Connections cannot be made to a Pioneer file-type CD player.

Be sure to turn the power off before making any connections. For full and complete Master-Slave connection, be sure to make connections for control, audio, and video as described in the following procedure.

- 1 Connect the supplied control cord from this player's MASTER-SLAVE CONTROL MASTER jack to the MASTER-SLAVE CONTROL SLAVE jack of another Pioneer DV-F07.

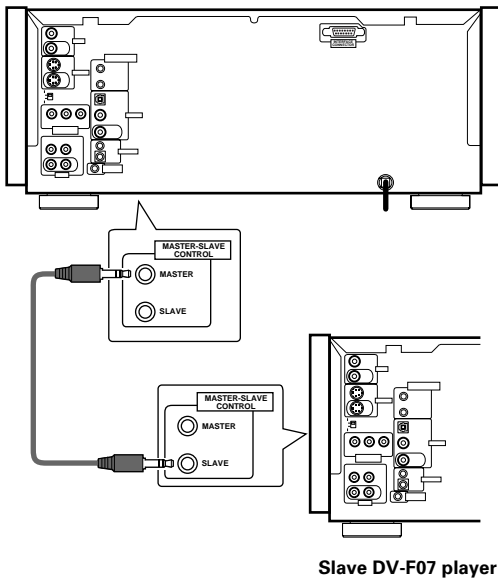

Notes

- One Master-Slave control cord is supplied with each unit, however, only one cord is needed.
- When a Master-Slave control cord is not firmly connected, or transmission is not made successfully, "CONNECT ERR" is displayed in the display window of both units. Should this occur, please make connections again.
- When not making Master-Slave connections, do not make any connections to the MASTER-SLAVE CONTROL jacks.

- 2 Make audio connections from the Slave player to the AUDIO IN jacks or DIGITAL IN (coaxial) jack on this player corresponding to the type of audio connections made from the Master player to the TV or AV component.

Analog audio connections

- Make connections from the AUDIO OUT jacks on the Slave player to the AUDIO IN jacks on the Master player.
- Use the audio cable included with the Slave player when making analog audio connections.
- When making analog audio connections, be sure to match the color of the plugs with the color of the jacks (red and white).

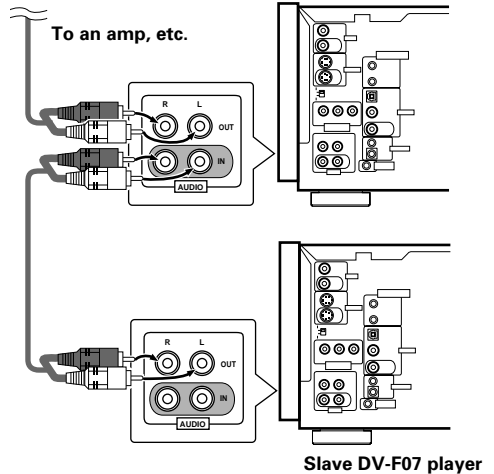

Digital audio connections

- Connect the DIGITAL OUT (coaxial) jack on the Slave player to the DIGITAL IN (coaxial) jack on the Master player.
- Use a commercially available coaxial cable to connect the DIGITAL OUT (coaxial) jack on the Slave player to the DIGITAL IN (coaxial) jack on the Master player.
- The digital audio signal input at the DIGITAL IN (coaxial) jack is output from both the DIGITAL OUT (coaxial) and OPT. OUT (optical) jacks.

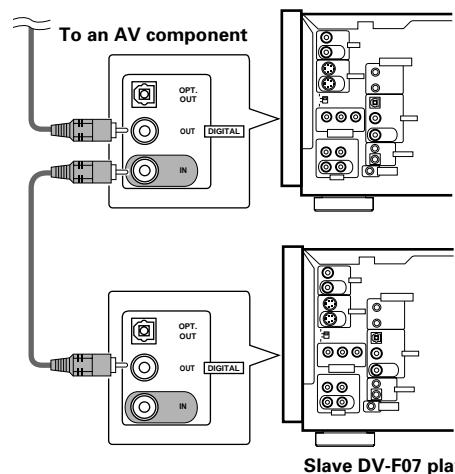

3 Make video connections from the Slave player to either the VIDEO IN or S-VIDEO IN jacks corresponding to the type of video connections made from the Master player to the TV or AV component.

- This player does not perform any processing of the video signals. Therefore, video signals input at the VIDEO IN jacks are not output from the S-VIDEO OUT jacks, and video signals input at the S-VIDEO IN jacks are not output from the VIDEO OUT jacks.
- Component video connection from the Slave player is not possible.

Video connections

When composite video connection is made to a TV or monitor, make composite video connections from the VIDEO OUT jack on the Slave player to the VIDEO IN jack on the Master player.

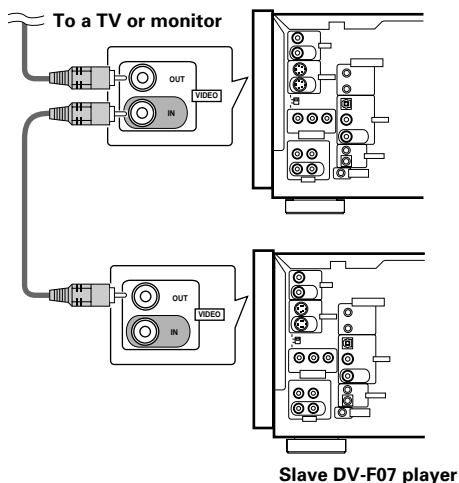

S-video connections

When S-video connection is made to a TV or monitor, use a commercially available S-video cable to make S-video connections from the S-VIDEO OUT jack on the Slave player to the S-VIDEO IN jack on the Master player.

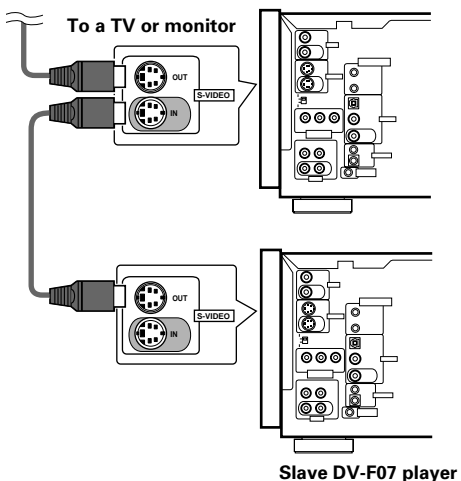

After Master-Slave connections have been made between two DV-F07 players

After connections between the two units have been made, when the power is turned on, “-MASTER-” will appear in the display window of the Master player and “-SLAVE-” will appear in the display window of the Slave player, and the two players will perform as a single unit.

Getting both players set up...

After connections have been made, it is recommended to use the Setup Navigator for simultaneous setup of both players. Settings made in the Setup Navigator are applied to both players, however, the settings in the Setup screen are applied to each player separately. When Setup screen settings are changed during playback, the setting is applied to the operating player. Because some settings cannot be changed during playback, stop disc playback before attempting to make changes.

Notes

- The power of the Slave player is turned on and off when the Master player is turned on and off.
- \odot STANDBY/ON on the Slave player will not work.
- The remote control will not operate when it is pointed at the Slave player. Point the remote control at the Master player to control the Slave player.
- The only button that can be used on the Slave player is OPEN/CLOSE to open and close the hood on the Slave player.
- When loading discs in the players, discs in the Master player are numbered from 1 to 300 and discs in the Slave player are numbered from 301 to 600.
- Single loader play on the Slave player is not possible.
- Make system control connections and CD-Deck synchro connections to the Master player only. Even after CD-Deck synchro connections are made to the Master player, the Slave player playback cannot be used for the CD-Deck synchro function.
- When connecting a commercially available PS/2 compatible keyboard or mouse for text input and other player functions, be sure to make connections to the Master player only.
- When Update All is performed, both players start at the same time, and are shut off when the player with more discs has finished the updating process. When Update Add is performed, the discs in the Master player are updated first, followed by the discs in the Slave player, and then both systems are restarted simultaneously.

Utilizing the Audio-Video Output of Another AV Component

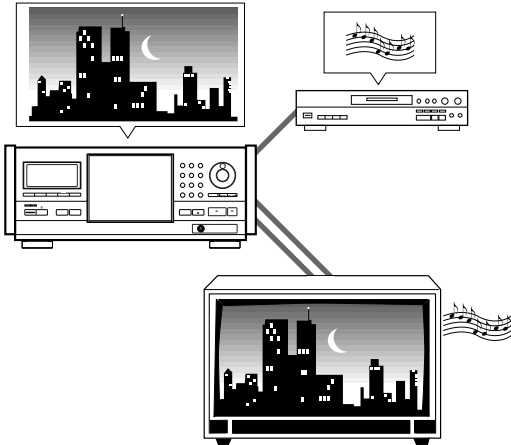

The input jacks on this player can be used for external audio and/or video input from a separate component. Additionally, when these kind of connections are made, it is possible to mix and match the audio and video inputs as you like.

Make audio and/or video connections to the input jacks on this unit as described in the previous section 'Master-Slave Connections'.

- Select the audio or video input from the component(s) connected to the input jacks on this unit in the Setup screen **General** menu [External Input] setting in the "Expert" menu mode (pages 40 and this page).
- When Master-Slave connections are made to a second Pioneer DV-F07 player, it is not possible to make connections to a separate component even if some jacks are not being used by the Slave player.

Notes

- It is not possible to select two audio or two video sources at the same time.
- If a video signal is being input from an externally connected component and **SETUP** is pressed on the remote, the video signal of the player will appear while the Setup screen is open. This is not a malfunction.
- When external input connections are made, do not make any connections to the MASTER-SLAVE CONTROL jacks.

Selecting External Input Expert

When a component is connected to the video or audio input jacks on this unit as described on pages 17 and 18, it is possible to select the input from that unit. By doing this, you can combine the audio of the connected component with the video of this player or the video of the connected component with the audio of this player, or you can even select both the audio and video input from the connected component(s).

Make selections in the Setup screen **General** menu [External Input] setting in the "Expert" menu mode (page 40).

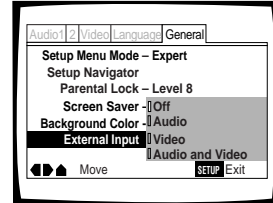

Settings: **Off***

Audio

Selects the audio output from the connected component.

Video

Selects the video output from the connected component.

Audio and Video

Selects both the audio video output from the connected component.

*Factory setting

Notes

- It is not possible to combine two video or two audio sources.
- When "Audio and Video" is selected, there is no output from this unit.
- When Master-Slave connection is made, this setting cannot be selected.
- The output of the connected component(s) is not input when the power of the player is turned off.
- If a video signal is being input from an externally connected component and **SETUP** is pressed on the remote, the video signal of this unit will appear while the Setup screen is open. This is not a malfunction.

Setting the Parental Lock Level

This player lets you set the Parental Lock if the DVD has a parental lock level recorded on it. With Parental Lock capable discs, you can block access to material you feel is inappropriate for your children. Refer to the DVD disc jacket and the accompanying documentation to see if a particular disc contains a parental lock level.

Make changes to the [Parental Lock] setting in the Setup screen **General** menu. Please note that changes to the Parental Lock level cannot be made when a disc is playing. Stop playback of the disc before attempting to make any changes.

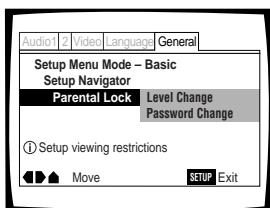

Settings: **Level Change** (For information, refer to 'Setting the Parental Lock level' on this page.)

Password Change (For information, refer to 'Changing the password' on the following page.)

When a DVD with a set Parental Lock level is played

Playback cannot be started until the password has been correctly input by moving the cursor control joystick or the number buttons, and **ENTER** has been pressed.

Entering the password

When you select either "Level Change" or "Password Change", it is necessary to enter the password (4-digit code number). Use the following steps at any time you are asked to enter or confirm your password.

- 1 Move the cursor control joystick up or down or the number buttons to select a number between 0 and 9.

You can also use the number buttons to enter the numbers directly. When entering your password for the first time, or changing it, you will be asked to reenter your password. When using the number buttons to confirm the password, the numbers appear as asterisks, and the cursor advances automatically to the next position.

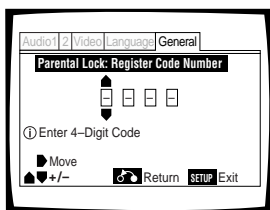

- 2 Move the cursor control joystick right or left to move the cursor to a different position in the password.

When all four numbers of the password have been entered, "ENTER" appears on the screen.

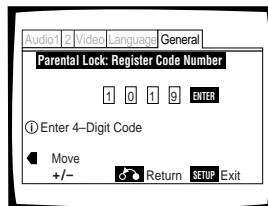

- 3 Press **ENTER** to set the password. The password is entered.

Note

Be sure not to forget your password. If you should forget it, reset the system, and enter a new password. To reset the system, see 'Resetting the Player to System Settings' (page 75). Please note that this procedure resets the system, and clears all saved settings, not just the password.

Setting the Parental Lock level

Parental Lock level information should be printed on the DVD disc jacket or accompanying documentation if it is featured. Generally speaking, level 8 offers no restriction on viewing and level 1 provides the strictest viewing restrictions.

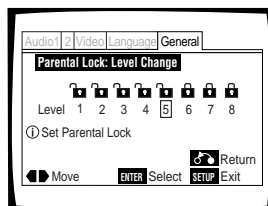

- 1 Select "Level Change" in the [Parental Lock] setting and press **ENTER**.

The screen changes to the password input screen. If you have not yet set a password, you will be asked to do so at this time. To enter the password, refer to 'Entering the password' on this page.

- 2 Move the cursor control joystick right or left to adjust the Parental Lock level.

The lock icons appear "unlocked" up to the selected level to indicate that access is available.

- 3 Press **ENTER** to set the new level.

The new Parental Lock level is set and the screen returns to the **General** menu screen. To go back to the **General** menu screen without making any changes, press **RETURN**.

Note

The Condition Memory function can be used to save the Parental Lock level. Therefore, Parental Lock levels can be set for individual discs according to their content rather than a set level for all DVDs.

Changing the password

Change your password whenever you feel it is necessary. However, if you forget your existing password, you cannot enter this screen to change it.

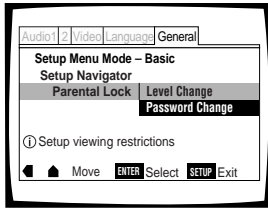

- 1 Select "Password Change" in the [Parental Lock] setting and press **ENTER**.

The screen changes to the password input screen as shown in the section 'Entering the password' on the previous page.

- 2 Enter your current password.

To enter the password, refer to 'Entering the password' on the previous page.

If you have not yet set a password, you cannot select this setting. Establish a password by selecting "Level Change" first.

- 3 Move the cursor control joystick or the number buttons to enter the new password.

- 4 When the new password has been entered, press **ENTER**.

The new password is set and the screen returns to the **General** menu screen. To go back to the **General** menu screen without making any changes, press **RETURN** ↵.

Turning the Screen Saver On and Off Expert

As a protective function against residual images on the TV screen or monitor, a phenomenon referred to as "screen burn", the screen saver appears when the same screen has been displayed for a length of time.

Make changes to the [Screen Saver] setting in the Setup screen **General** menu in the "Expert" menu mode (page 40).

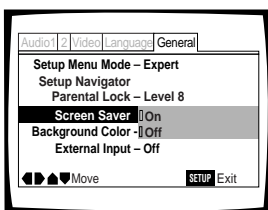

Settings: **On**
Off*

*Factory setting

Changing the Background Color of the Screen Expert

You can select a blue or black background to appear when the player is in the stop mode.

Make changes to the [Background Color] setting in the Setup screen **General** menu in the "Expert" menu mode (page 40).

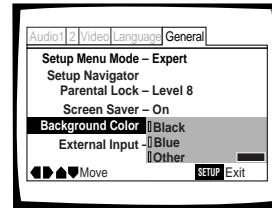

Settings: **Black**
Blue*
Other

*Factory setting

When "Other" is selected

This player gives you the option of creating your own background color by adjusting the red, green and blue levels.

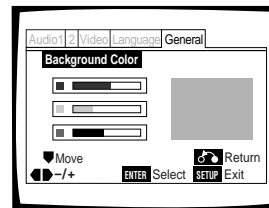

- 1 Move the cursor control joystick up or down to select a color bar.
The selected color bar becomes highlighted.
- 2 Move the cursor control joystick right or left to adjust the level of the color.
As the color bar is adjusted, the square on the right side of the screen indicates how the current mix of the three colors appears.
- 3 Repeat steps 1 and 2 until you have achieved a color that you like.
- 4 Press **ENTER** to set the color as the background color.

Additional Information

NEVER PLAY CRACKED OR WARPED DISCS

The disc revolves in the player at high speed when it is played. Never play a cracked, scratched or warped disc. This may damage the player or cause it to malfunction.

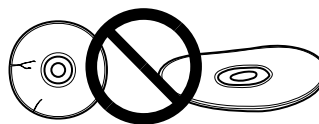

Disc Care

DISC CAUTIONS WHEN USING THIS PLAYER

- When changing or inserting discs, make sure that the rack is stopped. Do not attempt to load a disc into the player when the rack is moving.
- Never insert more than one disc at a time into one slot. This can scratch or damage the discs.
- To prevent malfunction, be sure to use an adapter when loading 8 cm (3 in.) CDs in the player.
- To prevent malfunction, do not use 8 cm (3 in.) CD adapters with 8 cm (3 in.) DVDs.

HOW TO HOLD DISCS

When loading or removing discs, try not to touch their playing surfaces.



CLEANING

Fingerprints or other dirt on the disc may affect sound and picture quality.

To clean your discs, use a soft clean cloth to wipe them. If necessary, moisten a soft cloth with diluted neutral detergent to remove heavy dirt or fingerprints.



Do not wipe in a circular direction (Concentric scratches in the disc groove tend to cause noise.)

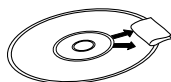

Gently wipe from the inside toward the outer edge.

Discs must not be cleaned with record cleaning sprays, or static prevention sprays, etc. Also do not use volatile liquids such as benzene, or thinner, etc.

LENS CLEANER

The player's pickup lens should not become dirty in normal use, but if for some reason it should malfunction due to soiling, contact your nearest Pioneer authorized service center. Lens cleaners are commercially available, however their use is not recommended because some may cause damage to the lens.

NEVER USE DISCS WITH SPECIAL SHAPES

CD's with special shapes (heart-shaped CDs, octagonal CDs, etc.) cannot be played on this set.

Attempting to do so may damage the set. Do not use such CDs.



CAUTION WHEN USING THE DISC

All rights reserved.

Unauthorized public performance, broadcasting or copying is a violation of applicable laws.

Notes on using optical cables

- Do not route cords around sharp angles. When storing, wind the cords so that they have a diameter of at least 15 cm (6 in.).
- When connecting, push all the way into the jack.
- Do not use cords with a length of over 3 m (10 ft.).
- If moisture or dust has collected on the plug, wipe it with a soft cloth before connecting.

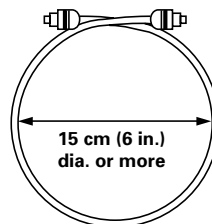

For Proper and Long Use of This Unit

DISC RACK CAUTION



- While changing or inserting discs, be careful not to press any buttons on the main unit or the remote control. The rack may move suddenly, and then your fingers may be caught between discs in the rack.
- When changing or inserting discs, make sure that the rack is stopped. Do not attempt to load a disc into the player when the rack is moving.
- Never insert your hand or any object into the interior. This can cause a malfunction.
- Never insert more than one disc at a time into one slot. This can scratch or damage the discs.
- Do not apply force to the rack. This can cause a malfunction.

DO NOT MOVE THE UNIT WHEN DISCS ARE LOADED IN THE RACK

Moving the player when discs are loaded may damage the discs and may cause the player to malfunction.

WHEN MOVING THE UNIT

When changing places of installation or packing the unit for moving, be sure to remove all of the discs from the rack and close the player's hood. Then, press **⏻ STANDBY/ON** and switch the power to standby. **Check that the "–OFF–" indication on the display goes off**, then disconnect the power cord. Moving this unit with the disc rack loaded may result in damage to this unit.

INSTALLATION

- Select a stable place to the side of a TV set or stereo system to be connected to the unit.
- When using the unit with a stereo system, install the speakers a little bit away from the TV.
- Do NOT install the unit on top of a TV or color monitor. Install the unit away from equipment that may be affected by magnetism, such as a cassette deck.
- Do NOT place objects on top of the unit.

AVOID INSTALLING IN A PLACE THAT IS:

- Exposed to direct sunlight
- Exposed to humidity or where ventilation is poor
- Extremely hot or cold
- Exposed to vibration
- Exposed to dust
- Exposed to oily smoke, steam or heat (for example, a kitchen)

DO NOT BLOCK VENTS

Do NOT use the player on top of a long-fibered carpet, bed or sofa, and do not cover it with a cloth, etc. This will prevent heat radiation and could result in damage.

AVOID HEAT

Do NOT place the unit on equipment which generates heat, such as an amplifier.

When installing the unit in a rack, place it on the lowest shelf possible (however, not where it is exposed to dust) and separated from the amplifier to avoid the heat generated by the amplifier or other audio equipment.

CONDENSATION

Moisture may form in the operating section of the player if the player is brought from cool surroundings into a warm room or if the temperature of the room rises suddenly. When this happens, the player's performance will be impaired.

To prevent this, let the player stand in its new surroundings for about an hour before switching it on, or make sure that the room temperature rises gradually.

Condensation may also form during the summer if the player is exposed to the breeze from an air conditioner. In such cases, change the location of the player.



SWITCH POWER TO STANDBY WHEN NOT USING THE UNIT

Depending on the strength of the TV or radio broadcast signal, having the TV or radio on while power to the unit is on may result in stripes on the TV screen or noise. However, this is not a malfunction of this unit or the TV or radio. In such a case, switch the power of the unit to standby.

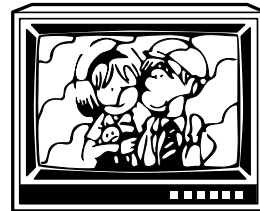

POWER-CORD CAUTION

Handle the power cord by the plug. Do not pull out the plug by tugging the cord and never touch the power cord when your hands are wet as this could cause a short circuit or electric shock. Do not place the unit, a piece of furniture, etc., on the power cord, or pinch the cord. Never make a knot in the cord or tie it with other cords. The power cords should be routed in such a way that they are not likely to be stepped on. A damaged power cord can cause a fire or give you an electrical shock. Check the power cord once in a while. When you find it damaged, ask your nearest Pioneer authorized service center or your dealer for a replacement.

Language Code List

Language codes are used when setting the audio and subtitle language preferences (page 47).

Language	Input-code
Japanese (ja)	1001
English (en)	0514
French (fr)	0618
German (de)	0405
Italian (it)	0920
Spanish (es)	0519
Dutch (nl)	1412
Russian (ru)	1821
Chinese (zh)	2608
Korean (ko)	1115
Greek (el)	0512
Afar (aa)	0101
Abkhazian (ab)	0102
Afrikaans (af)	0106
Amharic (am)	0113
Arabic (ar)	0118
Assamese (as)	0119
Aymara (ay)	0125
Azerbaijani (az)	0126
Bashkir (ba)	0201
Byelorussian (be)	0205
Bulgarian (bg)	0207
Bihari (bh)	0208
Bislama (bi)	0209
Bengali (bn)	0214
Tibetan (bo)	0215
Breton (br)	0218
Catalan (ca)	0301
Corsican (co)	0315
Czech (cs)	0319
Welsh (cy)	0325
Danish (da)	0401
Bhutani (dz)	0426
Esperanto (eo)	0515
Estonian (et)	0520
Basque (eu)	0521
Persian (fa)	0601
Finnish (fi)	0609
Fiji (fj)	0610
Faroese (fo)	0615
Frisian (fy)	0625
Irish (ga)	0701
Scots-Gaelic (gd)	0704
Galician (gl)	0712
Guarani (gn)	0714
Gujarati (gu)	0721
Hausa (ha)	0801

Language	Input-code
Hindi (hi)	0809
Croatian (hr)	0818
Hungarian (hu)	0821
Armenian (hy)	0825
Interlingua (ia)	0901
Interlingue (ie)	0905
Inupiak (ik)	0911
Indonesian (in)	0914
Icelandic (is)	0919
Hebrew (iw)	0923
Yiddish (ji)	1009
Javanese (jw)	1023
Georgian (ka)	1101
Kazakh (kk)	1111
Greenlandic (kl)	1112
Cambodian (km)	1113
Kannada (kn)	1114
Kashmiri (ks)	1119
Kurdish (ku)	1121
Kirghiz (ky)	1125
Latin (la)	1201
Lingala (ln)	1214
Laothian (lo)	1215
Lithuanian (lt)	1220
Latvian (lv)	1222
Malagasy (mg)	1307
Maori (mi)	1309
Macedonian (mk)	1311
Malayalam (ml)	1312
Mongolian (mn)	1314
Moldavian (mo)	1315
Marathi (mr)	1318
Malay (ms)	1319
Maltese (mt)	1320
Burmese (my)	1325
Nauru (na)	1401
Nepali (ne)	1405
Norwegian (no)	1415
Occitan (oc)	1503
Oromo (om)	1513
Oriya (or)	1518
Panjabi (pa)	1601
Polish (pl)	1612
Pashto, Pushto (ps)	1619
Portuguese (pt)	1620
Quechua (qu)	1721
Rhaeto-Romance (rm)	1813

Language	Input-code
Kirundi (rn)	1814
Romanian (ro)	1815
Kinyarwanda (rw)	1823
Sanskrit (sa)	1901
Sindhi (sd)	1904
Sangho (sg)	1907
Serbo-Croatian (sh)	1908
Singhalese (si)	1909
Slovak (sk)	1911
Slovenian (sl)	1912
Samoan (sm)	1913
Shona (sn)	1914
Somali (so)	1915
Albanian (sq)	1917
Serbian (sr)	1918
Siswati (ss)	1919
Sesotho (st)	1920
Sundanese (su)	1921
Swedish (sv)	1922
Swahili (sw)	1923
Tamil (ta)	2001
Telugu (te)	2005
Tajik (tg)	2007
Thai (th)	2008
Tigrinya (ti)	2009
Türkmen (tk)	2011
Tagalog (tl)	2012
Setswana (tn)	2014
Tonga (to)	2015
Turkish (tr)	2018
Tsonga (ts)	2019
Tatar (tt)	2020
Twi (tw)	2023
Ukrainian (uk)	2111
Urdu (ur)	2118
Uzbek (uz)	2126
Vietnamese (vi)	2209
Volapük (vo)	2215
Wolof (wo)	2315
Xhosa (xh)	2408
Yoruba (yo)	2515
Zulu (zu)	2621

Troubleshooting

Incorrect operations are often mistaken for trouble and malfunctions. If you think that there is something wrong with this component, check the points below. Sometimes the trouble may lie in another component. Inspect the other components and electrical appliances being used. If the trouble cannot be rectified even after exercising the checks listed below, ask your nearest Pioneer authorized service center or your dealer to carry out repair work.

The hood opens automatically.

The disc is dirty or warped.

- ➔ Refer to "Disc Care" (page 71).

The disc has been loaded in the rack incorrectly.

- ➔ Check that the disc has been loaded with the label side facing the right. (When loading double-sided DVDs, load the disc in the rack with the label denoting the contents you want to view facing the right.)

DVD region number does not conform with this unit.

- ➔ If the region number on the DVD does not match the number on the player, the DVD cannot be used (page 77).

There is condensation on the operating section of the player.

- ➔ Allow time for condensation to evaporate. If player is near an air conditioning unit, you should move the player (page 72).

mark appears on screen.

The selected function does not operate for that disc.

mark appears on screen.

The operation is prohibited by the player.

Picture playback stops and the operation buttons cannot be used.

- ➔ Stop disc playback (press **STOP** ■), then start playback again.
- ➔ Press **⏻** **STANDBY/ON** on the front panel to turn the player off, and then turn the power back on again.

New settings made in the Setup screen menus while a disc is playing are ineffective.

Some settings can be changed while a disc is playing, but are not effective. This is not a malfunction.

- ➔ Make the same setting when the player is stopped.
- ➔ Stop disc playback (press **STOP** ■), then start playback again. When playback is resumed, the new settings should be in effect. Please note that making settings in the Setup screen menus may cancel the resume function.

When making changes in the Setup screen menus, is displayed.

There is a Video CD or CD loaded in the player and the setting that was changed only applies to DVD performance.

- ➔ The settings will be effective the next time a DVD is loaded.

Settings are canceled.

When the power is turned off by power failure or by unplugging the power cord, settings will be canceled.

- ➔ Before unplugging the power cord, press **⏻** on the remote control checking that "–OFF–" disappears in the display.

No picture.

Connection is incorrect.

- ➔ Check that cord connections are correct and that plugs are firmly connected.

Player settings are incorrect.

- ➔ Check that VIDEO SELECT is set firmly in the correct position.

Operation (settings) of TV or AV component is not appropriate.

- ➔ Be sure that your TV or AV component is set up to view DVD playback.

External input settings are incorrect.

- ➔ Check that the power of the component to be used for external video input has been turned on.
- ➔ Check that the Setup screen **General** menu "External Input" setting is correct (page 68).

The screen is stretched or aspect does not change.

The multi aspect setting is not appropriate.

- ➔ Change the aspect setting in the [TV Screen] setting in the Setup screen **Video** menu to the screen type most appropriate to the TV or monitor you are using (page 43).

The screen is suddenly squeezed when the Setup screen is opened.

If the Setup screen is opened during playback of a DVD being viewed in the letter box format, the screen may switch to the wide screen format.

- ➔ This is not a malfunction. The screen will return to normal when the Setup screen is closed.

Picture disturbance during playback or dark.

This player is compatible with Macro-Vision System copy guard. Some discs include a copy prevention signal, and when this type of disc is played back, stripes etc., may appear on some sections of the picture depending on the TV.

- ➔ This is not a malfunction.

Discs respond differently to particular player functions which may result in the screen becoming black for a brief instant or shaking slightly when the function is executed.

- ➔ These problems are largely due to differences between discs and disc content and are not malfunctions of this player.

When recorded on a VCR or passed through an AV selector, there is disturbance in the playback picture.

This is not a malfunction.

- ➔ Due to the player's copy protection circuits, connection of this device through a VCR or an AV selector may prevent recording or cause picture problems.

Remote control operation is not possible.

The rear panel control input jack on the player is being used.

- ➔ Point the remote control at the component that the player is connected to (page 19).

The remote control is too far from the player, or the angle with the remote sensor is too wide.

- ➔ Be sure to operate the remote from a location within its operating range (page 8).

The batteries are exhausted.

- ➔ Replace the exhausted batteries with all new batteries (page 8).
-

Audio is not output or is distorted.

The Setup screen **Audio 1** menu [96 kHz PCM Out] setting is set to "96 kHz".

- ➔ On DVDs that contain copy protection, it may not be possible to play back the audio at 96 kHz. When this type of disc is encountered, even if "96 kHz" is selected, the player automatically outputs the digital audio output at a compressed rate of 48 kHz. This is not a malfunction.
- ➔ The "4:3 (Letter Box)" screen setting is selected. Even if "96 kHz" is selected, the player automatically downsamples the audio to a compressed rate of 48 kHz. This is not a malfunction.
- ➔ Be sure to make analog audio connections as well as digital connections (page 17).

The disc is dirty.

- ➔ Refer to "Disc Care" (page 71).

The connection plugs are not inserted fully into the terminals or are not connected.

- ➔ Check that all connection plugs are firmly inserted.

The connection plug or terminal is dirty.

- ➔ Check that the plugs and terminals are wiped clean of dirt, etc.

Audio cable connection is wrong.

- ➔ Check to make sure that the audio cables are connected correctly (page 17).

Connection is made to the stereo amplifier's PHONO input terminal.

- ➔ Change connection to any input terminal except PHONO.

The pause mode is engaged.

- ➔ Press **PLAY ►** or **PAUSE II** to exit the pause mode.

Stereo amplifier operation is incorrect.

- ➔ Check input (CD, AUX, etc.) selector to determine if it is selected for DVD playback.

External input settings are incorrect.

- ➔ Check that the power of the component to be used for external audio input has been turned on.
- ➔ Check that the Setup screen **General** menu "External Input" setting is correct (page 68).

The DTS audio soundtrack on a DVD has been selected.

- ➔ There is no audio output from the analog jacks during DTS audio playback. Select another soundtrack.
-

Noticeable difference in DVD and CD volume.

DVDs and CDs use different recording methods.

- ➔ This is not a malfunction.
-

There is no video and/or audio output from a SLAVE DV-F07 or other component connected to the input jacks on this unit.

Connections are incorrect.

- ➔ Check that connections are made firmly from the output jacks on the other component to the IN jacks on this unit (pages 66 and 67).

Menu settings are incorrect

- ➔ Check that the Setup screen **Other** menu [External Input] setting is set appropriately (page 68).
-

The SLAVE DV-F07 does not operate when connected

Connections are incorrect.

- ➔ Check that the control cable is connected to the MASTER jack on this unit and the SLAVE jack on the connected DV-F07 (page 66).
 - ➔ When connections are not made correctly or transmission cannot be performed between the Master and Slave player, "CONNECT ERR" is displayed in the display window. If this message is displayed, connect the cord correctly (page 66).
-

Caution

Static electricity or other external influence may cause malfunctioning of this unit. In this case, unplugging the power cord and then re-plugging it in will usually reset the unit for proper operation. If this does not correct the problem, please consult your nearest Pioneer service center.

Resetting the Player to System Settings

To reset the player, press and hold **■ (stop)** on the front panel when pressing **⏻ STANDBY/ON** on the front panel to turn the unit from standby to on.

All input text data, program memory, saved settings from functions such as Function Memory and Condition Memory are cleared, and all Setup screen menus are returned to factory settings.

Terms

Aspect ratio

Aspect ratio refers to the length to height ratio of TV screens. The ratio of a standard TV is 4:3, while the ratio of a high-definition or wide TV is 16:9. The latter allows you to enjoy a picture with a wider perspective.

CD TEXT

CD TEXT is a system in which text information is stored on a CD. CD TEXT can be used to display the disc's title, the artist's name, and track titles as well as other information. Additionally, this player uses the CD TEXT already on the CD when the discs are updated in the player.

Chapter number

Chapter numbers are the numbers assigned to sections of a title on the disc, similar to chapters in a book. If the disc includes chapter numbers, you can locate the section you want very quickly using search and other functions.

Component (color difference) video output

The color signal of the TV is divided into the luminance (Y) signal and the color (P_B and P_R) signals and then output. In this way mutual interference of each signal is avoided. On a TV with component input jacks, these signals are synthesized to produce the picture.

Condition memory

"Condition" refers to the various mode settings, etc. On this player, various conditions, such as those set during playback, can be memorized. This function allows you to play back the same disc at any time without having to redo your preferred settings.

Digital bitstream

The bitstream does not refer to the audio signal, but rather to the digital data that, once converted, becomes the audio signal. The player outputs digital bitstreams via the digital optical or digital coaxial output. If the bitstream cannot be decoded by the connected AV amplifier etc., digital noise is produced. Digital bitstream formats compatible with different entertainment systems can be selected in the Setup screen **Audio 1** menu.

Digital output (Coaxial)

Output of the digital audio signal is transmitted electronically using a coaxial cable. Because the signal being transmitted is digital, connection must be made to the coaxial digital input of another component. Noise will be output if connected to the analog audio inputs as the digital signal cannot be decoded.

Digital output (Optical)

Normally, audio is converted to an electric signal and transmitted through an electric wire from the player to the amplifier, etc. Changing this signal to a digital signal and transmitting it through an fiber-optic cable is called optical digital output. Similarly, optical digital input receives digital signals from external units such as an AV amplifier or receiver.

DNR (Digital Noise Reduction)

Digital noise reduction, in reference to video picture quality, refers to the detection and removal of digital artifacts, or errant video data, which appear as specks on the screen. When the digital noise reduction function of this player is on, some of this data can be detected and kept from appearing on the screen.

Dolby Digital

Using a maximum of 5.1 channels of audio, this high quality surround system (Surround Digital) is used in many of the finer movie theaters around the world.



In order to enjoy Dolby Digital discs, this unit's digital output jack (either coaxial or optical) must be connected to the digital input jack of an AV amplifier or Dolby Digital decoder to enjoy the sound of Dolby Digital soundtracks.

DTS

DTS stands for Digital Theater System. DTS is a surround system different from Dolby Digital that has become a popular surround sound format for movies.



In order to enjoy the benefits of DTS encoded discs, the digital output jack (either coaxial or optical) of this player needs to be connected to an AV amplifier or receiver or to a DTS decoder to be able to enjoy the surround sound of DTS audio. DTS audio is not output from the analog audio outputs.

Dynamic range

Dynamic range refers to the difference between the maximum and minimum levels of the audio soundtrack as measured in decibels (dB).

Compressing the dynamic range raises the minimum signal level and lowers the maximum signal level. This allows you to hear voices and other low level audio signals clearly while lowering strong audio signals like the sound of explosions.

Function Memory

Function Memory lets you make a shortcut list of up to five regularly used settings from the Setup screen page. By selecting a function from the Function Memory window, the appropriate Setup screen menu and function are automatically opened.

MASTER-SLAVE CONTROL

MASTER-SLAVE control refers to two identical units connected together for joint control. The first player (Master) receives remote control signals for both units and controls the disc selection, audio and video output, and information displays of the second player (Slave).

MPEG

Short for Moving Picture Experts Group. This is an international standard for compression of moving images. On some DVDs, digital audio has been compressed and recorded in this format.

Multi-angle

In a TV or movie studio, a single image is usually filmed by more than one camera at the same time, and one of those images is selected by the program director and transmitted to your TV. Some DVD discs are recorded with the angles of more than one camera used for filming, and these can be selected using this player. These types of discs are called multi-angle discs.

Multi-Language Subtitle

Subtitles are language titles superimposed on movies, or other media. Up to 32 different subtitle languages can be recorded on a DVD disc. The subtitle function can be used to select the language of your choice.

Multiple Language

The Multiple Language feature refers to the actual audio language that you hear while enjoying DVD playback. Up to 8 different language tracks can be recorded on a DVD. The Multiple Language function can be used to select the audio language of your choice.

Parental lock level

This function was suggested by parents concerned about what type of media their children were able to watch. Parental lock restrictions are restrictions incorporated into titles which include scenes that parents may not wish their children to view.

PBC (Playback Control)

This refers to signals recorded on a Video CD (Version 2.0) enabling playback control. You can use menus recorded on discs with PBC for easy, interactive search for desired scenes, and playback. You can also enjoy viewing high-resolution/standard resolution still images.

PCM

PCM stands for Pulse Code Modulation and is digital audio. The digital audio of CDs is PCM. This player also has a function that converts Dolby Digital and MPEG digital bitstreams into PCM to enable you to listen to quality digital sound even without a special decoder.

Regional restriction codes (region number)

Regional restriction codes are built in to DVD players and DVD discs for each sales region. If the regional code of the DVD player does not match one of the regional codes of the DVD disc, playback is not possible.

The region number can be found on the rear panel of the DVD player. The illustration below shows the regions and corresponding region numbers.

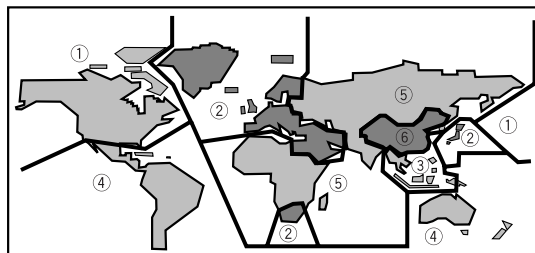

Sampling Frequency

When a sound wave is converted to a digital signal, the sound is sampled and converted to data at a specific frequency rate. For example, a signal with a 96 kHz sampling rate indicates that in one second, the analog signal was sampled 96000 times to produce the digital signal.

S-video

Connecting the S-video output on the player to a TV or monitor with S-video input via an S-video cable produces clearer picture reproduction by sending separate signals for the luminance and the color. These signals are then combined by the television to produce a better quality picture.

System control

When you connect this player via a cord with a mini plug to another Pioneer component such as a receiver or an amplifier bearing the  mark, you can control the player as though it were a component in a system. To control the player, point the player's remote control at the component that the player is connected to, and not the player itself.

TruSurround

TruSurround is a simulated surround system which produces a surround sound effect from stereo speakers.



Virtual Dolby Digital

Virtual Dolby Digital uses Dolby Digital multichannel audio sources to create a realistic surround sound effect from stereo speakers.

Specifications

General

System File-type DVD system and Compact Disc digital audio system

Power requirements AC 120 V, 60 Hz

Power consumption 21 W

Power consumption in standby mode less than 0.9 W

Weight 9.7 kg (21 lbs. 6 oz.)

Dimensions 460 (W) x 434 (D) x 194 (H) mm
(18 $\frac{1}{8}$ (W) x 17 $\frac{1}{16}$ (D) x 7 $\frac{5}{8}$ (H) in.)
(Not including protruding cables, etc.)

Operating temperature ... +5°C to +35°C (+36°F to +96°F)

Operating humidity 5% to 85% (no condensation)

S-Video input/output

Y (luminance) - Output level 1 V_{p-p} (75 Ω)

C (color) - Output level 286 mV_{p-p} (75 Ω)

Jacks S-VIDEO jack

Video input/output

Output level 1 V_{p-p} (75 Ω)

Jacks RCA jack

Component video output

(Y, P_B, P_R)

Output level Y: 1.0 V_{p-p} (75 Ω)
P_B, P_R: 0.7 V_{p-p} (75 Ω)

Jacks RCA jack

Audio input/output

Output level

During audio output 200 mV_{rms} (1 kHz, -20 dB)

Number of channels 2

Jacks RCA jack

Digital audio characteristics

Frequency response 4 Hz to 44 kHz (DVD fs: 96 kHz)

S/N ratio more than 115 dB

Dynamic range more than 103 dB

Total harmonic distortion 0.002%

Wow and flutter Limit of measurement
(±0.001% W. PEAK) or lower

Digital output

Optical digital output Optical digital jack

Coaxial digital input/output RCA jack

Control jacks

Control input/output Monaural minijack (3.5 ø)

MASTER-SLAVE Stereo minijack (3.5 ø)

Other jacks

CD-DECK SYNCHRO jack Minijack (2.5 ø)

KEYBOARD/MOUSE jack 6-pin DIN connection jack

Accessories

Remote control unit 1

AA (R6P) dry cell batteries 2

Audio cord 1

Video cord 1

Master-Slave control cord 1

Operating Instructions this manual

Warranty Card 1

Note

The specifications and design of this product are subject to change without notice, due to improvement.



Dear Customer:

Selecting fine audio equipment such as the unit you've just purchased is only the start of your musical enjoyment. Now it's time to consider how you can maximize the fun and excitement your equipment offers. This manufacturer and the Electronic Industries Association's Consumer Electronics Group want you to get the most out of your equipment by playing it at a safe level. One that lets the sound come through loud and clear without annoying blaring or distortion-and, most importantly, without affecting your sensitive hearing.

Sound can be deceiving. Over time your hearing "comfort level" adapts to higher volumes of sound. So what sounds "normal" can actually be loud and harmful to your hearing. Guard against this by setting your equipment at a safe level BEFORE your hearing adapts.

To establish a safe level:

- Start your volume control at a low setting.
- Slowly increase the sound until you can hear it comfortably and clearly, and without distortion.

Once you have established a comfortable sound level:

- Set the dial and leave it there.

Taking a minute to do this now will help to prevent hearing damage or loss in the future. After all, we want you listening for a lifetime.

We Want You Listening For A Lifetime

Used wisely, your new sound equipment will provide a lifetime of fun and enjoyment. Since hearing damage from loud noise is often undetectable until it is too late, this manufacturer and the Electronic Industries Association's Consumer Electronics Group recommend you avoid prolonged exposure to excessive noise. This list of sound levels is included for your protection.

Decibel

Level	Example
30	Quiet library, soft whispers
40	Living room, refrigerator, bedroom away from traffic
50	Light traffic, normal conversation, quiet office
60	Air conditioner at 20 feet, sewing machine
70	Vacuum cleaner, hair dryer, noisy restaurant
80	Average city traffic, garbage disposals, alarm clock at two feet.

THE FOLLOWING NOISES CAN BE DANGEROUS UNDER CONSTANT EXPOSURE

90	Subway, motorcycle, truck traffic, lawn mower
100	Garbage truck, chain saw, pneumatic drill
120	Rock band concert in front of speakers, thunderclap
140	Gunshot blast, jet plane
180	Rocket launching pad

Information courtesy of the Deafness Research Foundation.



Should this product require service in the U.S.A. and you wish to locate the nearest Pioneer Authorized Independent Service Company, or if you wish to purchase replacement parts, operating instructions, service manuals, or accessories, please call the number shown below.

8 0 0 - 4 2 1 - 1 4 0 4

Please do not ship your product to Pioneer without first calling the Customer Service Department at the above listed number for assistance.

PIONEER ELECTRONICS SERVICE, INC.
CUSTOMER SERVICE DEPARTMENT
P.O. BOX 1760, LONG BEACH,
CA 90801-1760, U.S.A.

For warranty information please see the Limited Warranty sheet included with your product.

Should this product require service in Canada, please contact a Pioneer Canadian Authorized Dealer to locate the nearest Pioneer Authorized Service Company in Canada.

Alternatively, please contact the Customer Service Department at the following address:

Pioneer Electronics of Canada, Inc.
Customer Service Department
300 Allstate Parkway, Markham, Ontario L3R OP2
(905) 479-4411
1-877-283-5901

For warranty information please see the Limited Warranty sheet included with your product.

Si ce produit doit être réparé au Canada, veuillez vous adresser à un distributeur autorisée Pioneer au Canada pour obtenir le nom de la Société de Service Autorisée Pioneer le plus près de chez vous. Ou encore, veuillez communiquer avec le Service de Clientèle de Pioneer:

Pioneer électroniques du Canada, Inc.
Département de service aux consommateurs
300 Allstate Parkway, Markham, Ontario L3R OP2
(905) 479-4411
1-877-283-5901

Pour obtenir des renseignements sur la garantie, veuillez vous reporter au feuillet sur la Garantie Limitée qui accompagne le produit.

Published by Pioneer Corporation.
Copyright © 1999 Pioneer Corporation.
All rights reserved.

PIONEER CORPORATION

4-1, Meguro 1-Chome, Meguro-ku, Tokyo 153-8654, Japan

PIONEER ELECTRONICS [USA] INC. P.O. BOX 1540, Long Beach, California 90801-1540, U.S.A.

PIONEER ELECTRONICS OF CANADA, INC. 300 Allstate Parkway, Markham, Ontario L3R OP2, Canada

PIONEER ELECTRONIC [EUROPE] N.V. Haven 1087, Keetberglaan 1, 9120 Melsele, Belgium TEL: 03/570.05.11

PIONEER ELECTRONICS AUSTRALIA PTY. LTD. 178-184 Boundary Road, Braeside, Victoria 3195, Australia, TEL: 03-9586-6300

PIONEER ELECTRONICS DE MEXICO S.A. DE C.V. San Lorenzo Num 1009 3er piso Desp. 302 Col. Del Valle, Mexico D.F. C.P. 03100
TEL: 5-688-52-90