

***Pioneer***

**DVD PLAYER**

**DV-C503**

**Operating Instructions**



## CONGRATULATIONS ON YOUR PURCHASE OF THIS FINE PIONEER PRODUCT.

Pioneer is on the leading edge of DVD research for consumer products and this unit incorporates the latest technological developments.

We are sure you will be fully satisfied with the DVD player.

Thank you for your support.

**WARNING:** TO PREVENT FIRE OR SHOCK HAZARD, DO NOT EXPOSE THIS APPLIANCE TO RAIN OR MOISTURE.

### IMPORTANT NOTICE

#### [For U.S. model]

The serial number for this equipment is located on the rear panel. Please write this serial number on your enclosed warranty card and keep it in a secure area. This is for your security.

**CAUTION:** This product satisfies FCC regulations when shielded cables and connectors are used to connect the unit to other equipment. To prevent electromagnetic interference with electric appliances such as radios and televisions, use shielded cables and connectors for connections.

#### NOTE:

This equipment has been tested and found to comply with the limits for a Class B digital device, pursuant to Part 15 of the FCC Rules. These limits are designed to provide reasonable protection against harmful interference in a residential installation. This equipment generates, uses, and can radiate radio frequency energy and, if not installed and used in accordance with the instructions, may cause harmful interference to radio communications. However, there is no guarantee that interference will not occur in a particular installation. If this equipment does cause harmful interference to radio or television reception, which can be determined by turning the equipment off and on, the user is encouraged to try to correct the interference by one or more of the following measures:

- Reorient or relocate the receiving antenna.
- Increase the separation between the equipment and receiver.
- Connect the equipment into an outlet on a circuit different from that to which the receiver is connected.
- Consult the dealer or an experienced radio/TV technician for help.

#### Information to User

Alteration or modifications carried out without appropriate authorization may invalidate the user's right to operate the equipment.

**WARNING:** NO NAKED FLAME SOURCES, SUCH AS LIGHTED CANDLE, SHOULD BE PLACED ON THE APPARATUS.

IF NAKED FLAME SOURCES ACCIDENTALLY FALL DOWN, FIRE SPREAD OVER THE APPARATUS THEN MAY CAUSE FIRE.

#### CAUTION

- Use of controls or adjustments or performance of procedures other than those specified herein may result in hazardous radiation exposure.
- The use of optical instruments with this product will increase eye hazard.

#### [For Canadian model]

This Class B digital apparatus complies with Canadian ICES-003.

#### [Pour le modèle Canadien]

Cet appareil numérique de la classe B est conforme à la norme NMB-003 du Canada.

THE STANDBY/ON BUTTON IS SECONDARY CONNECTED AND THEREFORE DOES NOT SEPARATE THE UNIT FROM MAINS POWER IN STANDBY POSITION.

#### [For Canadian model]

**CAUTION:** TO PREVENT ELECTRIC SHOCK, DO NOT USE THIS (POLARIZED) PLUG WITH AN EXTENSION CORD, RECEPTACLE OR OTHER OUTLET UNLESS THE BLADES CAN BE FULLY INSERTED TO PREVENT BLADE EXPOSURE.

**ATTENTION:** POUR PREVENIR LES CHOCS ELECTRIQUES NE PAS UTILISER CETTE FICHE POLARISEE AVEC UN PROLONGATEUR, UNE PRISE DE COURANT OU UNE AUTRE SORTIE DE COURANT, SAUF SI LES LAMES PEUVENT ETRE INSEREES A FOND SANS EN LAISSER AUCUNE PARTIE A DECOUVERT.

This product incorporates copyright protection technology that is protected by method claims of certain U.S. patents and other intellectual property rights owned by Macrovision Corporation and other rights owners. Use of this copyright protection technology must be authorized by Macrovision Corporation, and is intended for home and other limited viewing uses only unless otherwise authorized by Macrovision Corporation. Reverse engineering or disassembly is prohibited.

#### [For U.S. model]



As an ENERGY STAR® Partner, Pioneer Corporation has determined that this product meets the ENERGY STAR® guidelines for energy efficiency.

**WARNING:** BEFORE PLUGGING THE UNIT FOR THE FIRST TIME, READ THE FOLLOWING SECTION CAREFULLY.

THE VOLTAGE OF THE AVAILABLE POWER SUPPLY DIFFERS ACCORDING TO COUNTRY OR REGION, BE SURE THAT THE POWER SUPPLY VOLTAGE OF THE AREA WHERE THIS UNIT WILL BE USED MEETS THE REQUIRED VOLTAGE (E.G., 230V OR 120V) WRITTEN ON THE REAR PANEL.

#### Operating Environment

Operating environment temperature and humidity: +5°C – +35°C (+41°F – +95°F); less than 85%RH (cooling vents not blocked)

Do not install in the following locations

- Location exposed to direct sunlight or strong artificial light
- Location exposed to high humidity, or poorly ventilated location

Please read through these operating instructions so you will know how to operate your model properly. After you have finished reading the instructions, put them away in a safe place for future reference.

- This player is not suitable for commercial use.

## IMPORTANT



The lightning flash with arrowhead symbol, within an equilateral triangle, is intended to alert the user to the presence of uninsulated "dangerous voltage" within the product's enclosure that may be of sufficient magnitude to constitute a risk of electric shock to persons.

### CAUTION

RISK OF ELECTRIC SHOCK  
DO NOT OPEN



The exclamation point within an equilateral triangle is intended to alert the user to the presence of important operating and maintenance (servicing) instructions in the literature accompanying the appliance.

**CAUTION:**  
**TO PREVENT THE RISK OF ELECTRIC SHOCK, DO NOT REMOVE COVER (OR BACK). NO USER-SERVICEABLE PARTS INSIDE. REFER SERVICING TO QUALIFIED SERVICE PERSONNEL.**

# IMPORTANT SAFETY INSTRUCTIONS

**READ INSTRUCTIONS** — All the safety and operating instructions should be read before the product is operated.

**RETAIN INSTRUCTIONS** — The safety and operating instructions should be retained for future reference.

**HEED WARNINGS** — All warnings on the product and in the operating instructions should be adhered to.

**FOLLOW INSTRUCTIONS** — All operating and use instructions should be followed.

**CLEANING** — Unplug this product from the wall outlet before cleaning. The product should be cleaned only with a polishing cloth or a soft dry cloth. Never clean with furniture wax, benzene, insecticides or other volatile liquids since they may corrode the cabinet.

**ATTACHMENTS** — Do not use attachments not recommended by the product manufacturer as they may cause hazards.

**WATER AND MOISTURE** — Do not use this product near water — for example, near a bathtub, wash bowl, kitchen sink, or laundry tub; in a wet basement; or near a swimming pool; and the like.

**ACCESSORIES** — Do not place this product on an unstable cart, stand, tripod, bracket, or table. The product may fall, causing serious injury to a child or adult, and serious damage to the product. Use only with a cart, stand, tripod, bracket, or table recommended by the manufacturer, or sold with the product. Any mounting of the product should follow the manufacturer's instructions, and should use a mounting accessory recommended by the manufacturer.

**CART** — A product and cart combination should be moved with care. Quick stops, excessive force, and uneven surfaces may cause the product and cart combination to overturn.



**VENTILATION** — Slots and openings in the cabinet are provided for ventilation and to ensure reliable operation of the product and to protect it from overheating, and these openings must not be blocked or covered. The openings should never be blocked by placing the product on a bed, sofa, rug, or other similar surface. This product should not be placed in a built-in installation such as a bookcase or rack unless proper ventilation is provided or the manufacturer's instructions have been adhered to.

**POWER SOURCES** — This product should be operated only from the type of power source indicated on the marking label. If you are not sure of the type of power supply to your home, consult your product dealer or local power company.

**LOCATION** — The appliance should be installed in a stable location.

**NONUSE PERIODS** — The power cord of the appliance should be unplugged from the outlet when left unused for a long period of time.

### GROUNDING OR POLARIZATION

- If this product is equipped with a polarized alternating current line plug (a plug having one blade wider than the other), it will fit into the outlet only one way. This is a safety feature. If you are unable to insert the plug fully into the outlet, try reversing the plug. If the plug should still fail to fit, contact your electrician to replace your obsolete outlet. Do not defeat the safety purpose of the polarized plug.
- If this product is equipped with a three-wire grounding type plug, a plug having a third (grounding) pin, it will only fit into a grounding type power outlet. This is a safety feature. If you are unable to insert the plug into the outlet, contact your electrician to replace your obsolete outlet. Do not defeat the safety purpose of the grounding type plug.

**POWER-CORD PROTECTION** — Power-supply cords should be routed so that they are not likely to be walked on or pinched by items placed upon or against them, paying particular attention to cords at plugs, convenience receptacles, and the point where they exit from the product.

**OUTDOOR ANTENNA GROUNDING** — If an outside antenna or cable system is connected to the product, be sure the antenna or cable system is grounded so as to provide some protection against voltage surges and built-up static charges. Article 810 of the National Electrical Code, ANSI/NFPA 70, provides information with regard to proper grounding of the mast and supporting structure, grounding of the lead-in wire to an antenna discharge unit, size of grounding conductors, location of antenna-discharge unit, connection to grounding electrodes, and requirements for the grounding electrode. See Figure A.

**LIGHTNING** — For added protection for this product during a lightning storm, or when it is left unattended and unused for long periods of time, unplug it from the wall outlet and disconnect the antenna or cable system. This will prevent damage to the product due to lightning and power-line surges.

**POWER LINES** — An outside antenna system should not be located in the vicinity of overhead power lines or other electric light or power circuits, or where it can fall into such power lines or circuits. When installing an outside antenna system, extreme care should be taken to keep from touching such power lines or circuits as contact with them might be fatal.

**OVERLOADING** — Do not overload wall outlets, extension cords, or integral convenience receptacles as this can result in a risk of fire or electric shock.

**OBJECT AND LIQUID ENTRY** — Never push objects of any kind into this product through openings as they may touch dangerous voltage points or short-out parts that could result in a fire or electric shock. Never spill liquid of any kind on the product.

**SERVICING** — Do not attempt to service this product yourself as opening or removing covers may expose you to dangerous voltage or other hazards. Refer all servicing to qualified service personnel.

**DAMAGE REQUIRING SERVICE** — Unplug this product from the wall outlet and refer servicing to qualified service personnel under the following conditions:

- When the power-supply cord or plug is damaged.
- If liquid has been spilled, or objects have fallen into the product.
- If the product has been exposed to rain or water.
- If the product does not operate normally by following the operating instructions. Adjust only those controls that are covered by the operating instructions as an improper adjustment of other controls may result in damage and will often require extensive work by a qualified technician to restore the product to its normal operation.
- If the product has been dropped or damaged in any way.
- When the product exhibits a distinct change in performance — this indicates a need for service.

**REPLACEMENT PARTS** — When replacement parts are required, be sure the service technician has used replacement parts specified by the manufacturer or have the same characteristics as the original part. Unauthorized substitutions may result in fire, electric shock, or other hazards.

**SAFETY CHECK** — Upon completion of any service or repairs to this product, ask the service technician to perform safety checks to determine that the product is in proper operating condition.

**WALL OR CEILING MOUNTING** — The product should not be mounted to a wall or ceiling.

**HEAT** — The product should be situated away from heat sources such as radiators, heat registers, stoves, or other products (including amplifiers) that produce heat.

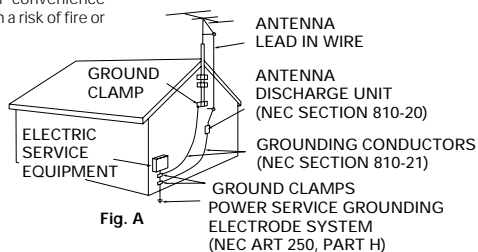





NEC — NATIONAL ELECTRICAL CODE

## Features of This Player

### Compatible with DVD, Video CD and CD formats

DVD, Video CD and CD discs that display the logos shown below can be played back on PIONEER DVD players. For more information on discs compatible with this player, refer to the table below.

Types of playable discs and their marks	Diameter/ Playable sides	Playback time
	DVD VIDEO	Digital audio Digital video (MPEG 2)
	12 cm (5 in.)/ single-sided	1 layer 2 layer 133 min. 242 min.
	12 cm (5 in.)/ double-sided	1 layer 2 layer 266 min. 484 min.
	DVD VIDEO	Digital audio Digital video (MPEG 2)
	VIDEO CD	Digital audio Digital video (MPEG 1) Max. 74 minutes
	12 cm (5 in.)/ single-sided	
	VIDEO CD single	Digital audio Digital video (MPEG 1) Max. 20 minutes
	8 cm (3 in.)/ single-sided	
  	CD	Digital audio
	12 cm (5 in.)/ single-sided	Max. 74 minutes
	CD single	Digital audio
	8 cm (3 in.)/ single-sided	Max. 20 minutes

The disc format logos shown above are found on disc labels or on disc jackets.

- To prevent malfunction, do not use an 8 cm (3 in.) adaptor (for CDs).
- Discs other than the ones indicated above cannot be played on this unit.
- DVDs that have incompatible region numbers, DVD-Audio, DVD-ROM, and CD-ROM cannot be played on this unit. The region number of the player can be found on the rear panel.

#### \*1 Playing recordable CDs

- Note that this unit cannot record onto recordable discs.
- This unit can play music-use CD-R and CD-RW discs. However, depending on the condition of the CD recorder and the disc, you may find that not all discs will play successfully. (For example, if the disc is scratched or dirty, or if the player's pickup lens is dirty.)

### Compatible with a wide range of DVD digital audio output formats



DVDs are recorded in one of four types of digital audio formats (as of October 1998). The digital audio output jacks of this player output Dolby Digital\*<sup>2</sup>, DTS\*<sup>3</sup>, MPEG, and linear PCM digital bitstreams.

This player has a function that converts Dolby Digital and MPEG audio formats into the linear PCM format. This allows playback of DVDs recorded in Dolby Digital and MPEG without the need for a decoder.

### Convenient 5-disc changer

A disc that is currently playing can be easily exchanged with four other discs. In addition, you can play your favorite disc with the press of a button.

### Smart CD mode for audio

Using this feature you can play only the CDs loaded in the disc tray—automatically skipping over any DVDs or Video CDs loaded—useful if you have a mixture of discs loaded but only want to play music: you don't have to keep track of what kind of disc is where in the disc tray.

\*<sup>2</sup> Manufactured under license from Dolby Laboratories. "Dolby" and the double-D symbol are trademarks of Dolby Laboratories. Confidential unpublished works. © 1992-1997 Dolby Laboratories. All rights reserved.

\*<sup>3</sup> "DTS" is trademark of Digital Theater Systems, Inc.

## Easy setup and adjustment using on-screen menus

Press **SETUP** on the remote control to open the Setup screen and you'll find setting up and adjusting the system easy to do with on-screen menus conveniently organized and arranged. Additionally, on-screen information (i) appears to clarify the functions and explain the options available. Below are just a few examples.

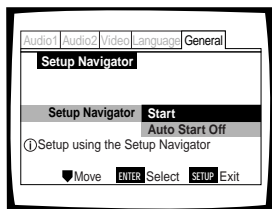

Answer a few questions and have all the necessary audio, video, and on-screen language adjustments set automatically by the player using the Setup Navigator (page 18).

Select the type of TV screen you are using and the preferred screen format you'd like to use when watching DVDs in the **Video** menu (page 30).

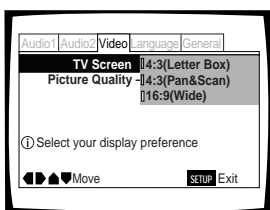

## Wide range of DVD viewing options

### Multi-Angle (page 32)★

You can view scenes from different camera angles when watching movies or other media with multiple angle playback available.

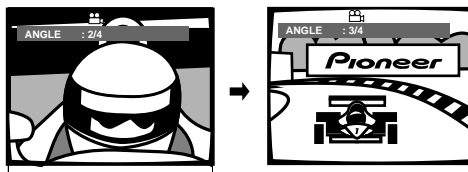

### Multiple Languages (page 34)★

You can select the language on when watching movies or other media that have multiple language and/or audio soundtracks recorded on them.

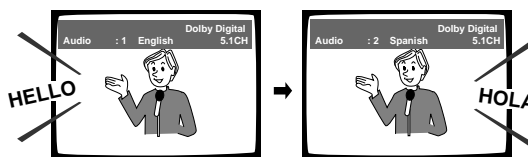

### Multi-Language Subtitles (page 35)★

You can select a subtitle language or turn subtitles off when watching movies or other media with subtitles available.

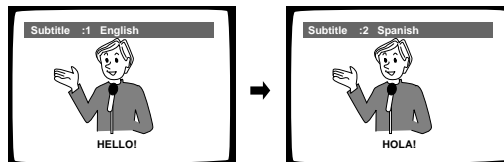

★This mark indicates this may not be possible with certain discs.

## Energy-saving design

This unit is designed to use less than 1 W of energy when this player is in standby mode.

# Differences in Disc Composition

## DVD

DVDs are divided into units referred to as titles, and titles are divided into chapters. A DVD which contains a movie may have only one title with many or no chapter divisions. Karaoke DVDs may have many titles, assigning a title to each song on the disc.

DVD player functions generally apply to titles on a disc or chapters within a selected title. The player functions available may also vary from title to title, depending on the disc. When discs have a unique title division, it should be noted that search and program functions may be affected.

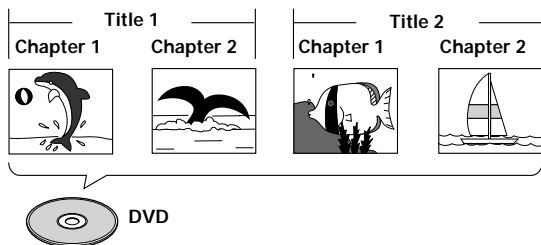

## Video CD/CD

Video CDs and CDs are divided into units referred to as tracks (Video CD tracks may also be referred to as scenes). One song generally corresponds to one track. Some tracks are further divided into units referred to as indexes. Video CDs with PBC (Playback Control) also contain menus recorded on the disc which enable easy access to the contents of the disc.

When played back on a DVD player, both Video CDs and CDs are considered to be a single title, regardless of the number of tracks.

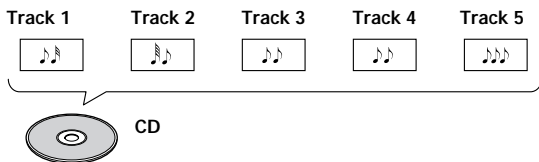
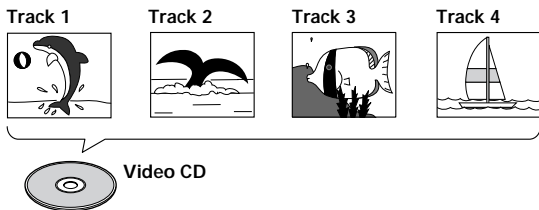

# How to Proceed in This Manual

DVD is an incredible format that presents the highest quality digital audio and video available today. The amount of information that can be recorded onto a DVD disc is remarkable, allowing it to offer numerous functions and features available with no other format. Because using the DVD player and DVDs may be confusing at first, following the order below should help you get through the important stages of getting set up so you can start using your player as soon as possible.

## Get familiar with the player.

Refer to the section *“Before Using”* on **page 8** to confirm that all the accessories were included with the player. If you are new to DVD, it might be beneficial for you to go through the *“Names and Functions”* section starting on **page 9** to get familiar with the parts and buttons on the main unit and remote control as they will be referred to throughout this manual.

There is also a list of terms that can be found on **page 57** if you are having trouble understanding some of the terminology associated with DVD.

## Make the necessary connections.

No entertainment system seems to be set up exactly the same way. The *“Making Connections”* section starting on **page 14** shows how video and audio connections may be made to suit your home entertainment system.

## Set up the necessary player menus.

Before you can begin to enjoy the benefits of the DVD format, it is first necessary to set up the player to output the video and audio information that corresponds to your system. The section *“Setting Up the Player”* starting on **page 18** explains how to use the Setup Navigator, a function that automatically sets up the player corresponding to the answers given in a multiple-choice on-screen procedure. The Setup screen menus, described in the section starting on **page 26**, are also used in a number of other functions. Learning the procedure for operating these menus will make using this player much easier and more enjoyable.

## Play a disc.

When all the connections and setups have been made, you are ready to play a DVD, Video CD, or CD with the player. The section *“Getting Started Using Your DVD Player”* starting on **page 21** outlines the basic player operations.

## Enjoy the many features available.

Once you are comfortable using the basic player functions, you are ready to take advantage of the various options DVD and this player have to offer. The section *“Advanced Functions”* starting on **page 38** describes how to use the features available on many DVDs.

# Table of contents

## Before Using ..... 8

- Checking Accessories ..... 8
- Preparing the Remote Control ..... 8

## Names and Functions ..... 9

- Front Panel ..... 9
- Display Window ..... 10
- Rear Panel ..... 11
- Remote Control ..... 12

## Making Connections ..... 14

- Connecting Your DVD Player ..... 14
- Audio Connections ..... 15
- Video Connections ..... 16
- System Control Connections ..... 17

## Setting Up the Player ..... 18

- Using the Setup Navigator ..... 18

## Getting Started Using Your DVD Player ..... 21

- Playing DVDs, Video CDs and CDs ..... 21
- Changing discs ..... 22
- Chapter (Track) Skip Forward/Skip Back ..... 24
- Forward and Reverse Scanning ..... 24
- Resuming Playback from Where You Stopped ..... 25
- Stopping Playback and Switching Power Off ..... 25

## Adjusting Audio and Video Settings ..... 26

- Using the Setup Screen Menus ..... 26
- Changing to the Setup Screen "Expert" Menu Mode ..... 27
- Setting the Digital Audio Output To Be Compatible with Your AV Component ..... 28
- Adjusting the Dynamic Range of the Audio Soundtrack ..... 29
- Setting the TV Screen Size ..... 30
- Selecting Picture Quality Appropriate for Program Content ..... 31
- Switching the S-Video Output ..... 31
- Selecting the type of paused image to display ..... 31
- Setting the position of the on-screen display ..... 31
- Viewing from a Desired Camera Angle (Multi-Angle) ..... 32

## Setting the Language Options ..... 33

- Setting the on-screen display (OSD) language ..... 33
- Setting Language and Subtitle Preferences in the Setup Screen Menus ..... 33
- Changing the Audio Language (Multi-Language Function) ..... 34
- Selecting a Subtitle Language (Multi-Language Subtitles) ..... 35

## Advanced Functions ..... 38

- Setting the Parental Lock Level ..... 38
- Turning the Screen Saver On and Off ..... 40
- Changing the Background Color of the Screen ..... 40
- Playing CDs Only (CD Mode) ..... 41
- Still Frame/Slow Play/Frame Advance Playback ..... 42
- Searching for a Title, Chapter, Track, or Location on a Disc ..... 43
- Repeat Play ..... 44
- Random Play ..... 45
- Playback in a Desired Order (Program Play) ..... 46
- Continuing Playback from a Specified Location (Last Memory) ..... 48
- Memorizing Settings for Often Viewed DVDs (Condition Memory) ..... 49
- Viewing Disc Information ..... 50
- Resetting the Player to System Settings ..... 51

## Additional Information ..... 52

- Disc Care ..... 52
- For Proper and Long Use of This Unit ..... 53
- Language Code List ..... 54
- Troubleshooting ..... 55
- Terms ..... 57
- Specifications ..... 59

# Before Using

## Checking Accessories

Please confirm that the following were received with the player.

### Audio cord

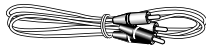

### Video cord



Power cord (plug varies with the country/region, so may not match the illustration)



### Remote control unit



### AA (R6P) dry cell batteries

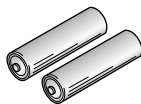

Operating instructions (this manual)

## Preparing the Remote Control

### Inserting batteries into the remote control

- 1 While pushing the tab on the battery compartment cover toward the center of the remote, pull out in the direction indicated by the arrow.

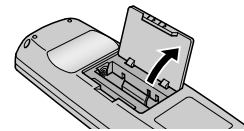

- 2 Insert batteries.

Make sure to match the plus (+) and minus (-) polarity guides on the batteries with the marks inside the battery compartment.

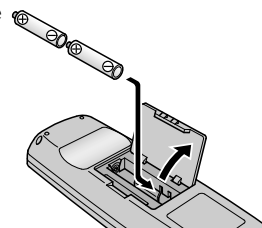

- 3 Close the cover.

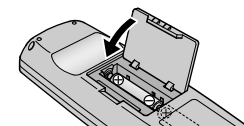

### Notes

- Do not mix old and new batteries.
- When replacing batteries, use all new batteries.
- When not using the remote control for a long period of time (over 1 month), remove the batteries to avoid possible damage from battery corrosion. If battery leakage occurs, wipe the battery liquid from the battery component, then insert new batteries.
- When disposing of used batteries, please comply with governmental regulations or environmental public instruction's rules that apply in your country or area.

## Remote control operation

When operating the remote control, point it at the remote sensor (SR) located on the player's front panel. The remote control can be used up to 7 m (23 feet) from the player and within a 30° angle on each side of the sensor.

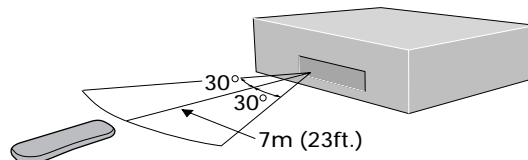

### Notes

- Exposing the remote sensor to direct sunlight or strong light may cause faulty operation.
- If the **CONTROL IN** jack on the player's rear panel is connected to the **CONTROL OUT** jack of another component, point the remote control at the other component to operate the player. Operation will not be possible when pointed at this player (page 17).



# Names and Functions

## Front Panel

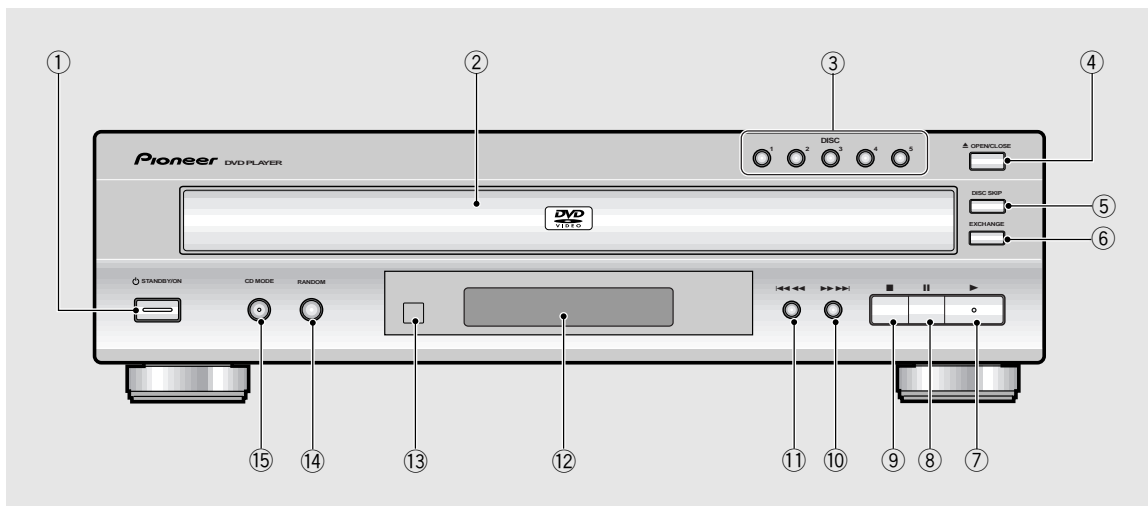

- ① **⏻ STANDBY/ON button**  
Press to switch the player on or to put in standby (pages 21, 25).
- ② **Disc tray**  
When loading a disc, place it in the disc tray with the label side facing up (pages 21, 25).
- ③ **DISC buttons**  
Use to select discs in the player directly (page 21).
- ④ **▲ OPEN/CLOSE button**  
Press to open and close the disc tray (pages 21, 25).
- ⑤ **DISC SKIP button**  
During playback, press to start playing the next disc in the player.  
If the disc tray is open while no disc is playing, the tray rotates one disc space.  
If the disc tray was opened using the **EXCHANGE** button, then pressing **DISC SKIP** rotates the disc tray two disc spaces (pages 21, 22).
- ⑥ **EXCHANGE button**  
Press during playback to open the disc tray without stopping playback. Press again to close the disc tray (page 22).
- ⑦ **▶ (play) button**  
Press to start or resume playback (pages 21, 25).
- ⑧ **⏸ (pause) button**  
Press during playback to pause. Press again to resume playback (page 42).
- ⑨ **■ (stop) button**  
Press to stop playback. Pressing once enables playback to resume from a point shortly before the location where it stopped. Pressing twice causes the disc to return to the beginning of the disc if playback starts again (page 25).
- ⑩ **▶▶▶▶ (forward) button**  
Press to advance to chapters/tracks. Press and hold to perform fast-forward scanning (page 24).
- ⑪ **◀◀◀◀ (reverse) button**  
Press to go back to previous chapters/tracks. Press and hold to perform reverse playback scanning (pages 24).
- ⑫ **Display window**  
Displays system information (page 10).
- ⑬ **Remote sensor**  
Point the remote control toward the remote sensor to operate the player (page 8).
- ⑭ **RANDOM button**  
Press to play discs, titles, chapters or tracks in random order (page 45).
- ⑮ **CD MODE button and indicator**  
Switches CD mode on/off. The indicator lights when on (page 41).

# Display Window

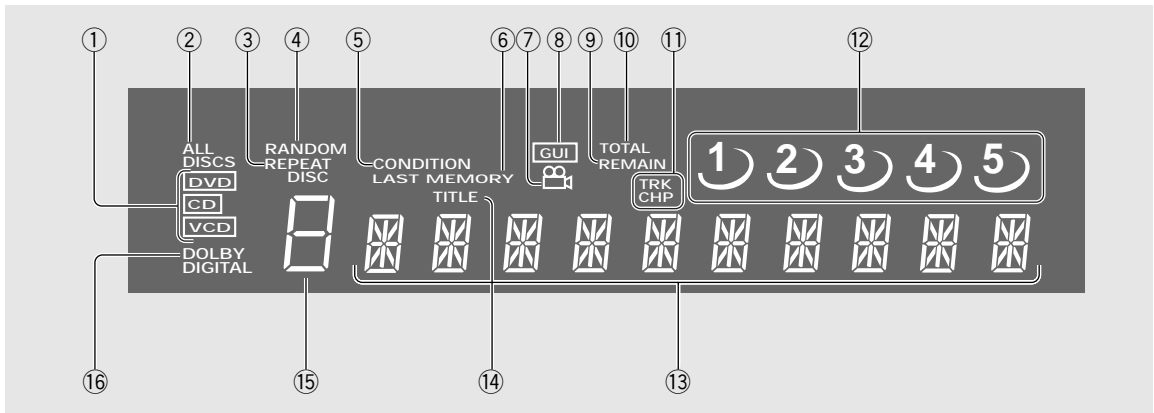

- ① **DVD indicator**  
Lights when a DVD is loaded.
- CD indicator**  
Lights when an audio CD is loaded.
- VCD indicator**  
Lights when a Video CD is loaded.
- ② **1 DISC/ALL DISCS indicator**  
Lights during random or repeat play. If ALL Discs is selected, **ALL DISCS** lights; if 1 Disc is selected, **DISC** lights.
- ③ **REPEAT indicator**  
Indicates that the Repeat function is on (**page 44**).
- ④ **RANDOM indicator**  
Indicates that the Random function is on (**page 45**).
- ⑤ **CONDITION indicator**  
Indicates that Condition Memory settings are memorized for the currently loaded DVD (**page 49**).
- ⑥ **LAST MEMORY indicator**  
Indicates the Last Memory location is recorded in memory for the currently loaded DVD or Video CD (**page 48**).
- ⑦ **GUI (angle) Indicator**  
Indicates Multi-Angle playback is in progress (**page 32**).
- ⑧ **GUI indicator**  
Indicates an on-screen menu operation is being performed.
- ⑨ **REMAIN indicator**  
Indicates that the remaining playback time of a title or chapter/track is being displayed.
- ⑩ **TOTAL indicator**  
Indicates that the total number of titles/chapters or tracks is being displayed (**page 51**).
- ⑪ **TRK indicator**  
Indicates a track number is being displayed.
- CHP indicator**  
Indicates a chapter number is being displayed.
- ⑫ **Disc tray/Disc indicator**  
↻ means that a disc is loaded in that position. In CD mode, ↻ indicates a CD. (However, if the player has not yet determined whether a disc is loaded it also lights.)
- ⑬ **Counter display**  
Displays the playback mode, type of disc, title and chapter/track numbers, playback time, etc.
- ⑭ **TITLE indicator**  
Indicates a title number is being displayed.
- ⑮ **DISC number indicator**  
Shows the disc number currently in the play position.
- ⑯ **DOLBY DIGITAL indicator**  
Indicates Dolby Digital audio playback.

# Rear Panel

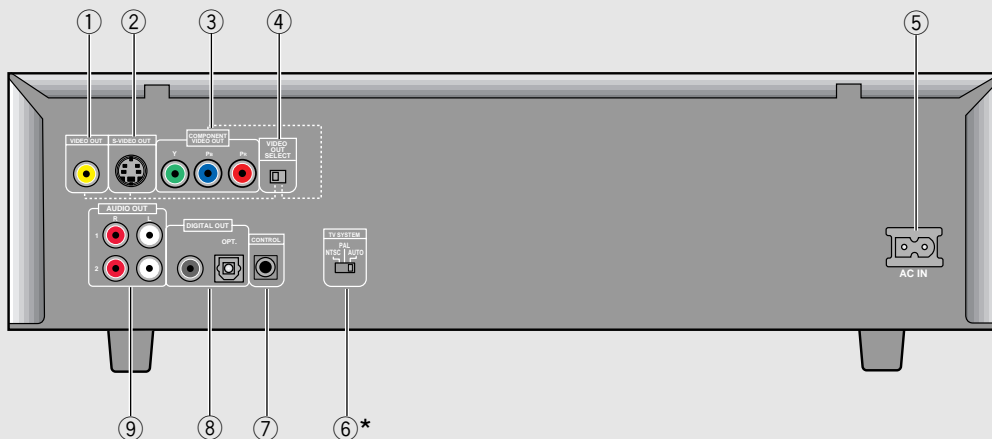

(\*The TV SYSTEM switch is not present on U.S. and Canadian models.)

- ① VIDEO OUT jack**  
 Connect to the video input on a TV or monitor or AV amplifier or receiver with video input capability. When using this output, be sure to set **VIDEO OUT SELECT** to the left position (**pages 14, 16**).
- ② S-VIDEO OUT jack**  
 If your TV or monitor has an S-video input, clear picture reproduction is possible by connecting the player to your TV or monitor via the S-Video jack. When using this output, be sure to set **VIDEO OUT SELECT** to the left position (**page 16**).
- ③ COMPONENT VIDEO OUT jacks**  
 If your TV or monitor has component video inputs, you can produce a higher quality picture on your TV or monitor by connecting to the component video outputs on this unit. When using these jacks, be sure to set **VIDEO OUT SELECT** to the right position (**page 16**).
- ④ VIDEO OUT SELECT switch**  
 Use to set which output is used to output the video signals. Select either video/S-video or component video signal output depending on the connections you make (**page 16**).
- ⑤ AC IN power cord connection terminal (plug varies with the country/region, so may not match the illustration)**  
 Use to connect the power cord to the wall outlet (**page 14**).
- ⑥ TV SYSTEM switch\* (except for U.S. and Canadian models)**  
 Use to change the TV signal mode to either PAL or NTSC according to the type of TV and disc to be used. When the switch is in the **AUTO** position, the player outputs the format on the disc as is (**page 17**).
- ⑦ CONTROL IN jack**  
 Use to connect this player to another component bearing the Pioneer **SR** mark. This lets you control this unit as though it were a component in a system. Player operations are then performed by pointing the remote control at the component that the player is connect to (**page 17**).
- ⑧ DIGITAL OUT jacks (coaxial, optical (OPT.))**  
 Use to output the digital audio signal recorded on discs. You can output the digital signal via either coaxial or optical output jack to an AV amplifier or receiver (**pages 15**).
- ⑨ AUDIO OUT jacks**  
 Use to output two-channel audio (analog) to the audio stereo inputs on a TV or stereo amplifier. If you are connecting to a receiver that has both digital and analog input jacks for DVD player connection, it may be beneficial to make both connections (**pages 14, 15**).

# Remote Control

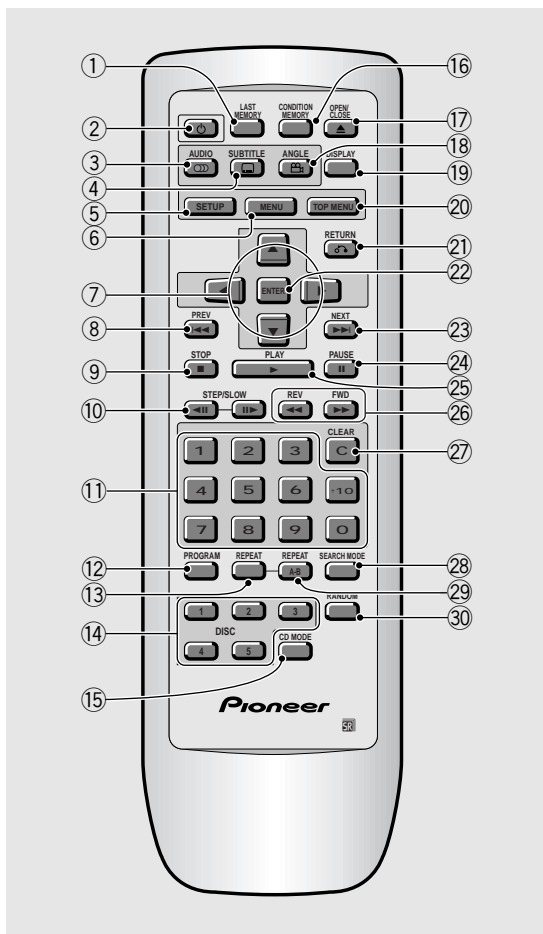

(Buttons indicated with \* are used for menu operation.)

## ① LAST MEMORY button

You can resume DVD or Video CD playback from the point you last watched even if the disc is removed from the player. Press **LAST MEMORY** during playback to set a Last Memory point. When you want to resume playback of that disc, press **LAST MEMORY** in the stop mode and playback starts from the memorized point. Last Memory locations can be stored for up to 5 DVDs and 1 Video CD (**page 48**).

## ② (standby/on) button

Press to switch the player on or to put in standby (**pages 21, 25**).

## ③ AUDIO button

Press repeatedly to select one of the audio languages programmed on a DVD (**page 34**). For Video CD and CD, each press changes the audio output as follows.

→ Stereo → 1/L (Left) → 2/R (Right) →

## ④ SUBTITLE button

Press repeatedly to select one of the subtitle languages programmed on a DVD or to turn the subtitles off (**page 35**).

## ⑤ SETUP button\*

Press when the player is in either play or stop mode to open and close the Setup screen (**page 18, 26**).

## ⑥ MENU button\*

Use to display or close the DVD menu screen (**page 23**).

## ⑦ Cursor buttons (left/right/up/down)\*

Use to move through the options on menu screens and to change settings.

## ⑧ PREV button (previous)

During playback, press **PREV** to go back to a previous chapter/track (**page 24**).

## ⑨ STOP button

Press to stop playback. Pressing once enables playback to resume from a point shortly before the location where it was stopped. Pressing twice causes the disc to return to the beginning of the disc when playback starts again (**page 25**).

## ⑩ STEP/SLOW buttons

Press **STEP/SLOW** during playback to view slow playback. In pause mode, press **STEP/SLOW** to advance DVDs and Video CDs frame by frame and **STEP/SLOW** to back up a few frames at a time (**page 42**).

## ⑪ Number buttons (1-9, 0, +10)\*

Use to perform direct title and chapter/track searches, and to input numerical values.

## ⑫ PROGRAM button

You can program titles, chapters, or tracks to play back in a desired order. Programs can be a maximum of 24 steps. (**pages 46, 47**).

## ⑬ REPEAT button









During playback of a DVD, press once to repeat playback of the current chapter, and twice to repeat playback of the current title. During playback of a Video CD or CD, press once to repeat playback of the current track, twice to repeat playback of the current disc, and 3 times to repeat all the discs loaded in the player (**page 44**).

## ⑭ DISC buttons (1-5)

Use to select discs in the player directly (**page 21**).

## ⑮ CD MODE button

Switches CD mode on/off (**page 41**).

- ⑩⑥ **CONDITION MEMORY button**  
 You can store in memory the settings for up to 15 DVDs. Press **CONDITION MEMORY** during DVD playback to memorize the settings (page 49).
- ⑩⑦ **OPEN/CLOSE ▲ button**  
 Press to open or close the disc tray (pages 21, 25).
- ⑩⑧ **ANGLE  button**  
 Some DVDs are recorded with various camera angle playback options. Press **ANGLE ** repeatedly to display different camera angles (page 32).
- ⑩⑨ **DISPLAY button**  
 Press during playback to display statistical disc information. Press repeatedly to display different information (page 50).
- ⑩⑩ **TOP MENU button\***  
 Press to call up the top menu programmed on the DVD. Depending on the DVD, the top menu may be identical to the DVD menu (page 23).
- ⑩⑪ **RETURN  button\***  
 Use to go one menu back (current settings are maintained). Use **RETURN ** when you do not want to change the option setting in a menu.
- ⑩⑫ **ENTER button\***  
 Use to implement settings selected with the cursor buttons or to set items highlighted in a menu.
- ⑩⑬ **NEXT  button**  
 During playback, press **NEXT ** to advance to the next chapter/track (page 24).
- ⑩⑭ **PAUSE  button**  
 Press to pause playback of a disc. Press again to resume playback (page 42).
- ⑩⑮ **PLAY  button**  
 Press to start disc playback (pages 21, 25).
- ⑩⑯ **◀◀ REV/FWD ▶▶ (fast reverse/forward) buttons**  
 During playback of DVD and Video CD, press **FWD ▶▶** to perform fast forward scanning. Press **REV ◀◀** to perform fast reverse scanning of DVD and Video CD. When a CD is loaded, audio scanning is performed (page 24).
- ⑩⑰ **CLEAR button (C)**  
 Works in conjunction with a number of player functions. Use to cancel repeat and random playback, and to edit programs.
- ⑩⑱ **SEARCH MODE button**  
 Press to perform a title, chapter/track or elapsed time search (page 43).
- ⑩⑲ **REPEAT A-B button**  
 Press at the beginning and end of the section you want to repeat or to mark a location you want to return to (page 44).
- ⑩⑳ **RANDOM button**  
 Press to play discs, titles, chapters or tracks in random order (page 45).

# Making Connections

## Connecting Your DVD Player

Unlike any other audiovisual media format, DVD offers a wide array of audio and video output options which allows playback to be enjoyed in any number of system configurations from a standard TV with stereo audio input to a home theater system with a TV or monitor and full surround sound capabilities.

## Connection Guide

The illustration on this page shows the basic setup using the audio and video cords included with this player. Use this illustration as a guide to setting up your home system.

An explanation of each type of audio and video connection available can be found on **pages 15 to 17**. To determine the best audio and video connection setup for your system, refer to the manuals supplied with the components you are making connections to.

In addition to making physical connections to your TV or monitor, it is also necessary to assign the TV screen size. You can use the **[Setup Navigator]** in the Setup screen **General** menu to set whether you are using a wide screen or standard size TV or monitor (**page 19**).

Additionally, you can use the **[TV Screen]** setting in the Setup screen **Video** menu (**page 30**).

### Notes

- When making connections to this unit or when changing connections, check that the unit is off by pressing **⏻ STANDBY/ON** making sure that nothing is being displayed in the display window, and then unplug the power cord from the power outlet.
- The video output on this player uses copy protect circuitry to prevent the video playback on DVDs from being copied. If you connect the player to a TV via a VCR, or record and play back the contents of a disc with a VCR, the playback picture may not be normal.

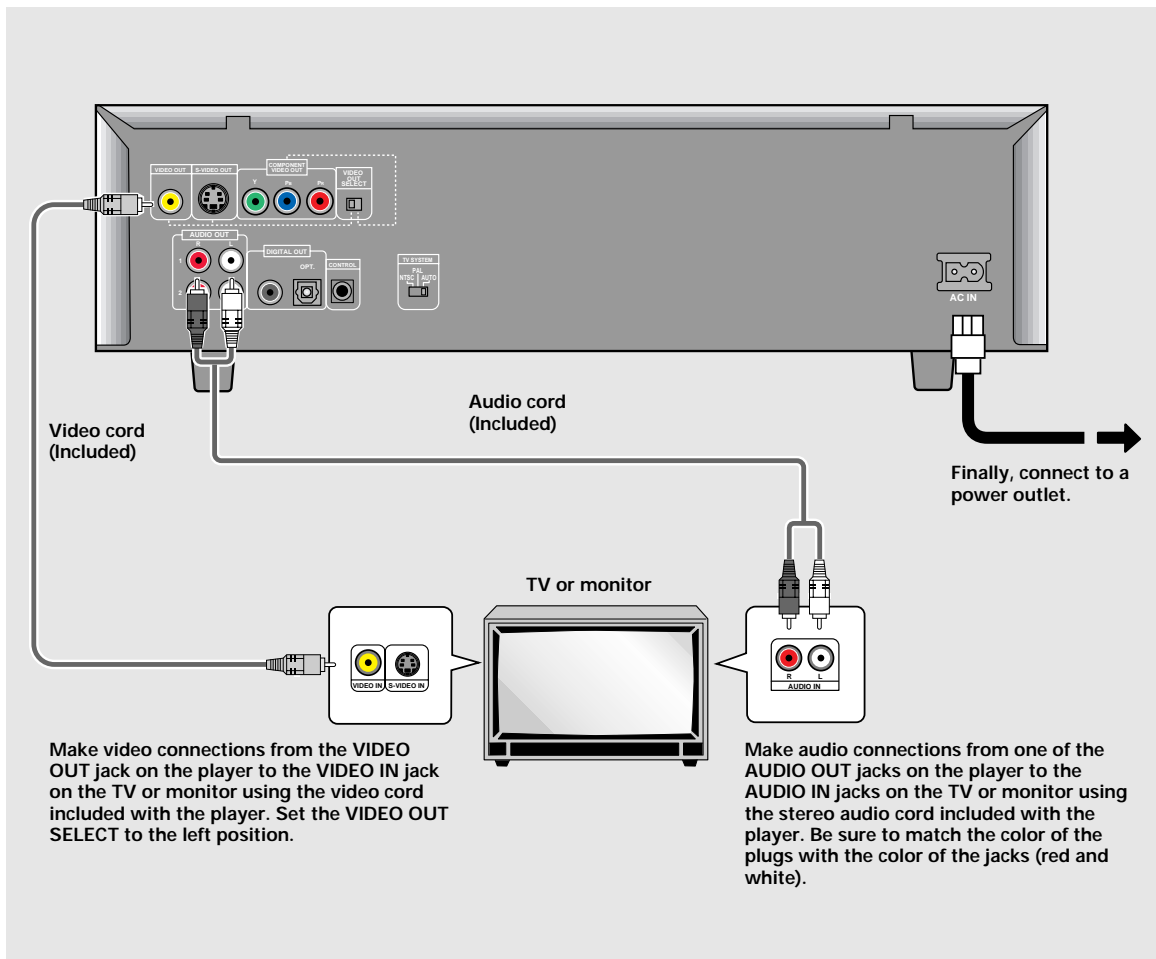

# Audio Connections

This player features two digital (optical and coaxial) and also analog audio output formats.

## Digital Audio Connections:

You can enjoy the digital audio recorded on DVD, Video CD or CD discs from both optical digital and coaxial digital output jacks.

**When making digital audio connections, do not make connections from both the coaxial and optical digital outputs to the same component.**

When a DVD recorded in Dolby Digital, DTS, or MPEG is loaded, noise will be output if you have made connections via the digital audio jacks to a receiver or amplifier that cannot decode a Dolby Digital, DTS, or MPEG digital bitstream. In this case, be sure to set the **[Digital Jack]** setting in the Setup Navigator to best reflect the type of system you are using (page 20). Additionally, the digital audio settings can be adjusted manually in the Setup screen **Audio 1** menu (page 28-29).

### DIGITAL OUT (Optical)

The digital signal is transmitted as light pulses through a fiber-optic cable.

- Use to connect to an AV amplifier or receiver with built-in Dolby Digital, DTS, or MPEG decoder.
- Use a fiber-optic cable (not supplied) to connect the **DIGITAL OUT OPT** (optical digital output) on the player to the optical digital input on an AV amplifier or receiver.

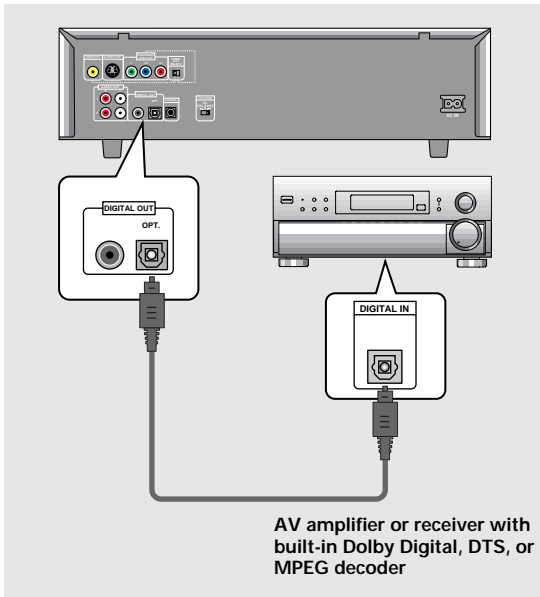

### DIGITAL OUT (Coaxial)

The digital signal is transmitted electronically through a coaxial cable.

- Use to connect to an AV amplifier or receiver with built-in Dolby Digital, DTS, or MPEG decoder.
- Use a coaxial cable (not supplied) to connect the **DIGITAL OUT** (coaxial digital output) on the player to the coaxial digital input on an AV amplifier or receiver.

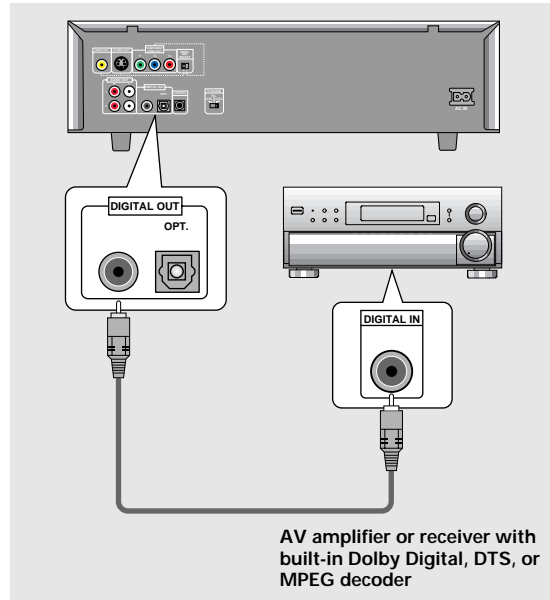

## Analog Audio Connection:

### AUDIO OUT

- Make analog audio connections to a stereo amplifier or receiver.
- Analog audio connections can also be made to a TV or monitor with stereo input jacks.
- Use the supplied audio cord to connect one of the **AUDIO OUT** jack on the player to the audio input on the stereo amplifier or receiver.
- When making analog audio connections, be sure to match the color of the plugs with the color of the jacks (red and white).

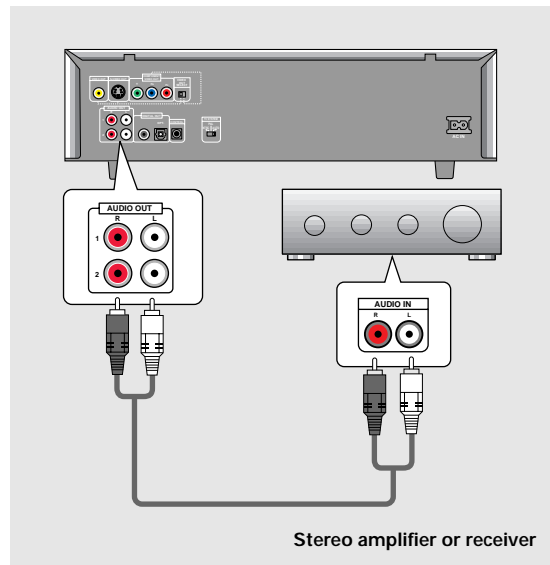

## Video Connections

This player features S-video, composite, and component video output possibilities.

Check the manual supplied with your TV or monitor to determine the best possible connection for your system. In addition to making physical connections to your TV or monitor, it is also necessary to assign the TV screen size. You can use the **[Setup Navigator]** in the Setup screen **General** to set whether you are using a wide screen or standard size TV or monitor (**page 19**). Additionally, you can use the **[TV Screen]** setting in the Setup screen **Video** menu (**page 30**).

### S-VIDEO OUT

- Make S-video connections to a TV or monitor with S-video input to produce a high quality video image.
- Use an S-video cable (not supplied) to connect the **S-VIDEO OUT** jack on the player to S-video input on the TV or monitor.
- When using this jack, be sure to set **VIDEO OUT SELECT** to the left position.

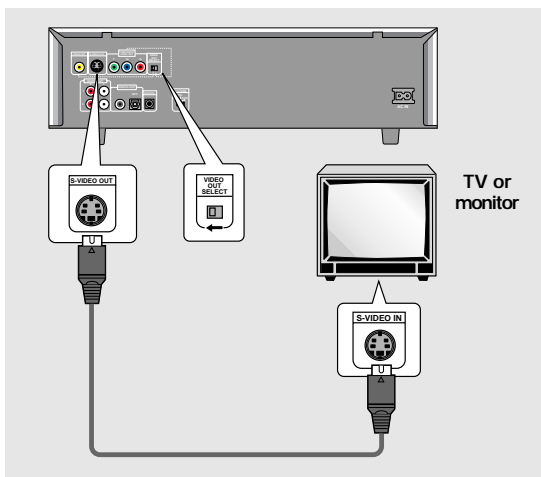

### VIDEO OUT

- Make composite video connections to a standard TV or monitor with a video input jack.
- Use the supplied video cable to connect the **VIDEO OUT** jack on the player to the video input on the TV or monitor.
- Be sure to match the color of the plug with the color of the jack (yellow).
- When using this jack, be sure to set **VIDEO OUT SELECT** to the left position.

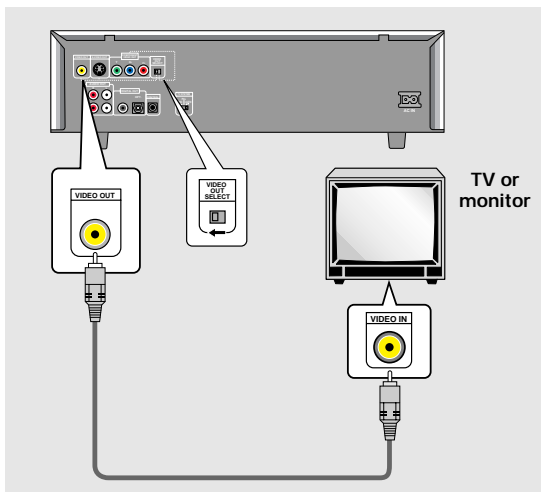

### COMPONENT VIDEO OUT

- Make component video connections to a TV or monitor with component inputs to produce a higher quality video image.
- Use a component video cable or 3 video cords (not supplied) to connect the **COMPONENT VIDEO OUT** jacks on the player to the component jacks on the monitor.
- When making component video connections, make sure to set the **VIDEO OUT SELECT** switch on the rear panel of the player to the right to assign component video output.

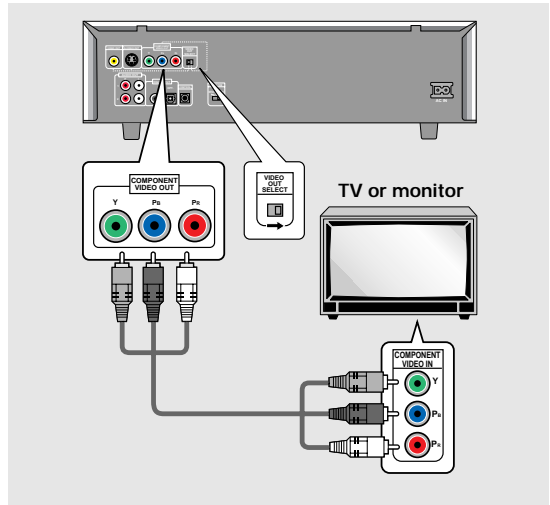



## TV SYSTEM switch (The TV SYSTEM switch is not present on U.S. and Canadian models)

Video output changes as follows according to the playback disc's recorded format.

NTSC → PAL, PAL → NTSC conversion is possible on Video CDs. PAL → NTSC conversion is not possible on DVDs. When the **TV SYSTEM** switch is set to the **AUTO** position, the disc's format will be output as is. When a CD or disc is not loaded, the previous video output format will be selected.

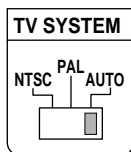

Disc		Output format		
Type	Format	Position of TV SYSTEM switch		
		NTSC	PAL	AUTO
DVD	NTSC	NTSC	MOD. PAL	NTSC
	PAL	—	PAL	PAL
Video CD	NTSC	NTSC	MOD. PAL	NTSC
	PAL	NTSC	PAL	PAL
CD, No disc		NTSC	PAL	NTSC or PAL

### About MOD. (Modulation) PAL

#### • SHRINK

Most models of the newly developed countdown PAL TV system detect 50 Hz (PAL)/60 Hz (NTSC) and automatically switch vertical amplitude, resulting in a display without vertical shrinkage.

- If your PAL TV does not have a V-Hold control, you may not be able to view NTSC disc because the picture may roll. If the TV has a V-Hold control, adjust it until the picture stops rolling. On some TVs, the picture may shrink vertically, leaving black bands at the top and bottom of the screen. This is not a malfunction; it is caused by the NTSC → PAL conversion.

## System Control Connections

Using a commercially available cord with a mini plug (3.5 mm dia. with no resistance) to connect this player's **CONTROL IN** jack to the **CONTROL OUT** jack of another PIONEER component bearing the **SR** mark, you can control the player as though it were a component in a system (system control).

- If you connect for system control, you cannot operate the player directly. Point the remote control unit at the component (AV amplifier, etc.) connected to the **CONTROL OUT** jack to operate.
- When controlling as a system, be sure to make a connection to the amplifier **using an audio or video cord**, even when using only digital components.
- For details, refer to the operation manuals of the connected components.

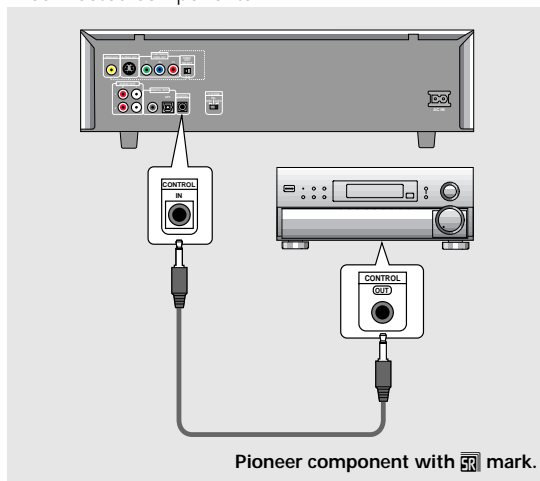

# Setting Up the Player

## Using the Setup Navigator

The Setup Navigator has been designed to simplify the process of getting the DVD player ready to perform. Designed as a series of on-screen multiple-choice questions, the Setup Navigator automatically sets the audio, video, and language settings according to how the questions are answered. Once this procedure is complete, it will be possible to begin using the DVD player to enjoy DVDs.

The procedure on this page describes the operations necessary to function within the Setup Navigator screens. A detailed description of the contents of each question that appears on the screen can be found on the following pages.

### When setting up for the first time

Some DVDs start playing automatically when loaded in the player. Because the Setup Navigator cannot be used if a disc is playing, it is recommended to set up the player using the Setup Navigator before loading a DVD for the first time. If a DVD has been loaded, be sure to press **STOP** ■ before proceeding.

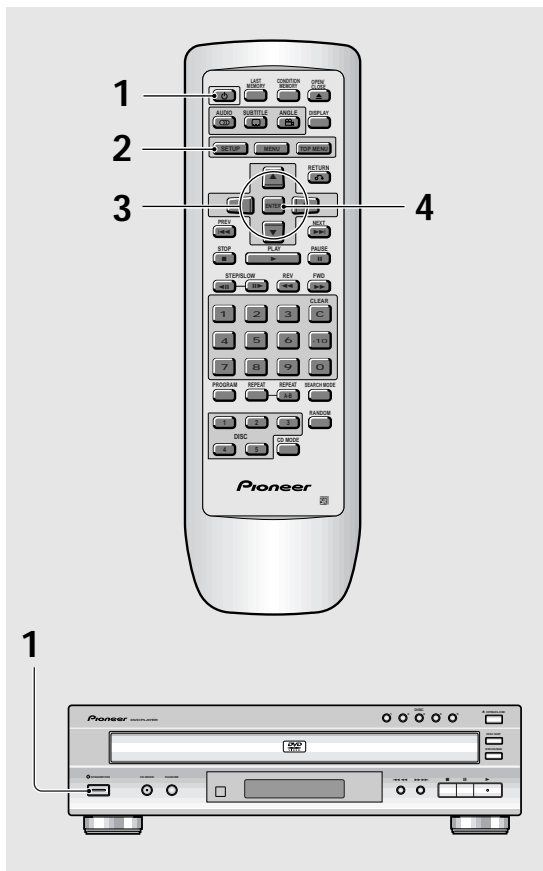

**1** Press **⏻** (⏻ **STANDBY/ON** on the front panel).

**2** Press **SETUP**.

When **SETUP** is pressed for the first time, the following screen appears. Though the Setup Navigator may be used more than once, this screen only appears the first time **SETUP** is pressed.

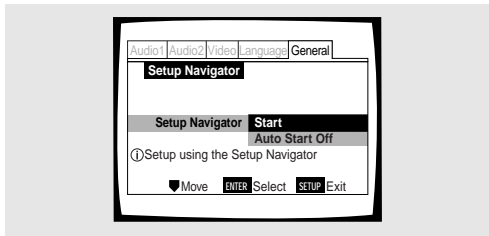

**3** Use the cursor buttons (▲/▼) to make a selection.

- If you are going to use the Setup Navigator, it is not necessary to change the setting on the first screen. Please proceed to the next step.
- **If you do not want to set up the player using the Setup Navigator, use the cursor button (▼) to select [Auto Start Off] at this time.** The Setup Navigator function may still be used at a later time in manual Setup screen menu operation ([page 26](#)).

**4** Press **ENTER**.

The selection is entered and the next Setup Navigator screen appears.

Use steps **3** and **4** as a basis for entering selections on all of the Setup Navigator screens described on the following pages.

### To change the answer to a prior question

Use the **cursor button** (◀) to return to previous screens. Please note, however, that you cannot go forward using the **cursor button** (▶), so it will be necessary to answer all the questions that occur after the screen that was returned to.

### To exit the Setup Navigator

Press **SETUP** while on any of the screens to exit the Setup Navigator. Please note that if the Setup Navigator is exited before all the questions are answered, no settings are changed.

### To return to the Setup screen

Press **RETURN** ⏪. The Setup Navigator is exited and the Setup screen **General** menu screen appears. Please note that no settings are changed if **RETURN** ⏪ is pressed before the Setup Navigator is finished.

## Setting the OSD Language (On-Screen Display Language)

The **[OSD Language]** screen establishes the OSD language, or on-screen display language, which refers to the language that is used by the player in menus and on-screen messages. Additionally, the language that is established at this setting will also be used for the default audio and subtitle language.

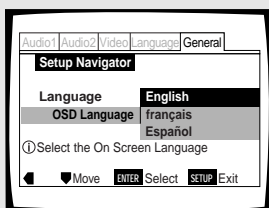

Settings: **English\***  
**français**  
**Español**

\* Factory setting

### Note

In addition to setting the **[OSD Language]**, the audio and subtitle language are also set at this time. If you wish to change the audio or subtitle language to a different language, make changes in the Setup screen **Language** menu **[Audio Language]** and **[Subtitle Language]** as needed ([pages 33, 35](#)).

## Setting the TV screen size

The **[TV Type]** screen establishes the size, or more appropriately the width to height ratio of your television or monitor. The width-to-height ratio of conventional TVs is 4:3, while the width-to-height ratio of wide screen and high-definition TVs is 16:9. This width-to-height ratio is called the aspect ratio.

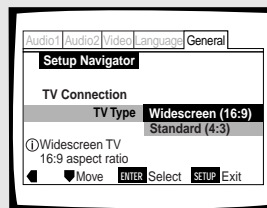

Settings: **Widescreen (16:9)\***  
**Standard (4:3)**

\* Factory setting

### Note

There are two screen formats that can be used to display wide-screen format DVDs: letter box and pan & scan. When **[Standard (4:3)]** is selected in the Setup Navigator, the letter box screen format is automatically selected. To switch the preference to the pan & scan format, make changes in the Setup screen **Video** menu **[TV Screen]** setting ([page 30](#)).

## Setting digital audio connections to an AV amplifier or decoder

The **[Digital Jack]** screen establishes whether digital connections have been made to an AV amplifier, receiver, or external decoder. As there are numerous options available, please refer to the instructions supplied with the component the player is connected to determine what digital audio formats can be decoded. If you have made no digital connections, select **[Not Connected]**.

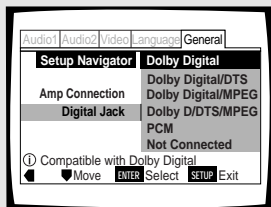

Settings: **Dolby Digital\***

**Dolby Digital/DTS**  
**Dolby Digital/MPEG**  
**Dolby D/DTS/MPEG**  
**PCM**  
**Not Connected**

\* Factory setting

## Setting compatibility with 96 kHz output

The **[96 kHz PCM Audio]** screen establishes whether or not the AV component the player is connected to is capable of processing an audio signal with a sampling rate of 96 kHz. This screen only appears if connections have been made to an external AV component as determined in previous screens.

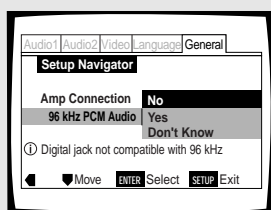

Settings: **No\***

Select if the connected AV component cannot process an audio signal with a sampling rate of 96 kHz.

**Yes**

Select if the connected AV component can process an audio signal with a sampling rate of 96 kHz.

**Don't Know**

Select if you are uncertain whether the connected AV component can process an audio signal with a sampling rate of 96 kHz.

\* Factory setting

## Confirming the settings

The **[Exit Setup Navigator]** is the final screen in the Setup Navigator.

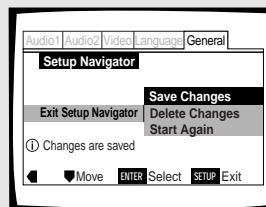

Settings: **Save Changes\***

Select to have the player make all of the necessary audio, video, and language settings according to your responses in the Setup Navigator.

**Delete Changes**

Select to exit the Setup Navigator without changing any of the system settings.

**Start Again**

Select to return to the **[OSD Language]** screen of the Setup Navigator and do the settings again.

\* Factory setting

### To exit the Setup screen

When you have completed setting up the player using the Setup Navigator or if you exit the Setup Navigator, the Setup screen **General** menu appears. Press **SETUP** to close the Setup screen.

### To change other player settings in the Setup screen menus

The procedure for changing the settings in the Setup screen menus is described on **page 26**.

# Getting Started Using Your DVD Player

## Playing DVDs, Video CDs and CDs – DVD/Video CD/CD

Before you can start to enjoy the digital audio and video on DVDs, be sure that you have either performed the Setup Navigator procedure described in the previous section or made the necessary settings in the Setup screen menus as outlined in the next section to set up the player to correspond to your home system. Having made these settings, you are now ready to start using the player to enjoy DVDs, Video CDs, and CDs.

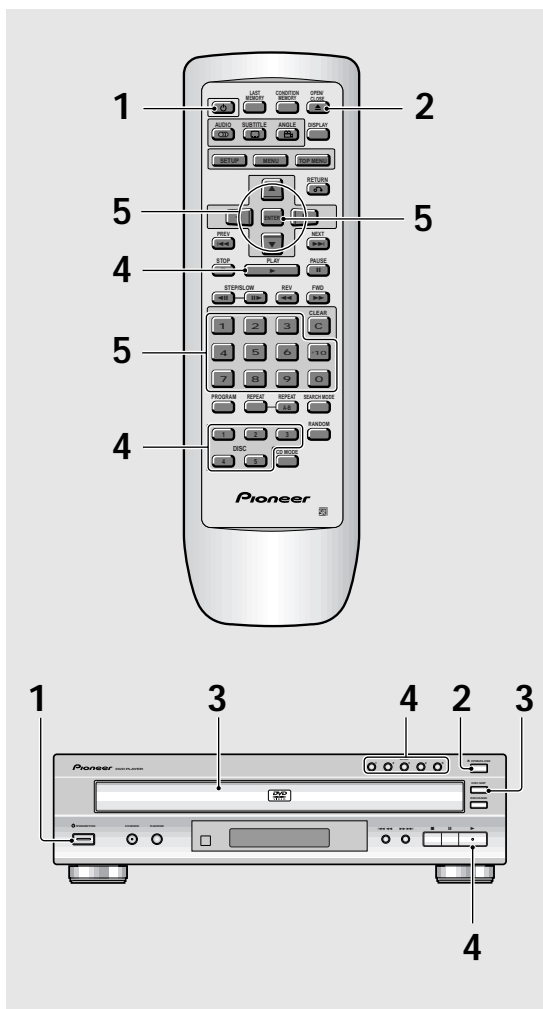

- 1 Press **⏻** (⏻ **STANDBY/ON** on the front panel) to turn on the player.
- 2 Press **OPEN/CLOSE ▲** (▲ **OPEN/CLOSE** on the front panel).  
The disc tray comes out.

- 3 **Load a disc.**
  - Load a disc with the label side facing up, using the disc tray guide to align the disc.
  - If you want to load more discs, press **DISC SKIP** to rotate the disc tray. You can load up to five discs at once.

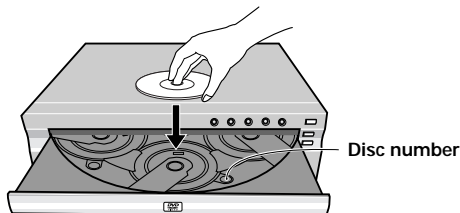

### Notes

- Do not place discs in the two partially accessible disc spaces, as it is easy to misalign them. Use only the front-most space.
- When using the **DISC SKIP** button, wait until the disc tray has come to a complete stop before loading a disc; the player may malfunction if a disc is caught in the disc tray mechanism.
- Do not rotate the disc tray by hand. Always use the **DISC SKIP** button.

- 4 Press **PLAY ►** (► on the front panel).
  - The disc located in the front of the disc table is played.
  - Press one of the **DISC** buttons (1 through 5) to begin playback of the selected disc.
  - **Depending on the disc, a menu may be displayed. If a menu is displayed, proceed to step 5.**

- 5 **Select the item you want to view.**
  - **When a DVD is loaded:**  
Use the **cursor buttons** (◀/▶/▲/▼) to select the item, then press **ENTER**. You may also be able to use the **number buttons** for direct selection (Depending on the disc, you may not be able to use the **number buttons**).
  - **When a Video CD is loaded:**  
Use the **number buttons** to select the item.

### Notes

- Noise maybe output if you make digital audio connections to a receiver or amplifier that does not have a built-in decoder. Check that the digital audio output format selected in the **Audio 1** menu corresponds to the audio components you have made connections to (**page 28-29**).
- The TV screen size is factory set to present the wide screen format (16:9 aspect ratio). If you have a standard TV screen (4:3 aspect ratio), this setting can be changed to match your TV screen size in the **Video** menu (**page 30**).

## Changing discs – DVD/Video CD/CD

You can change any of the discs not in the play position using the **EXCHANGE** button. Because the disc in the play position is unaffected, you can use this button to change discs even during playback.

### Note

If no discs are loaded, the **EXCHANGE** button has no effect.

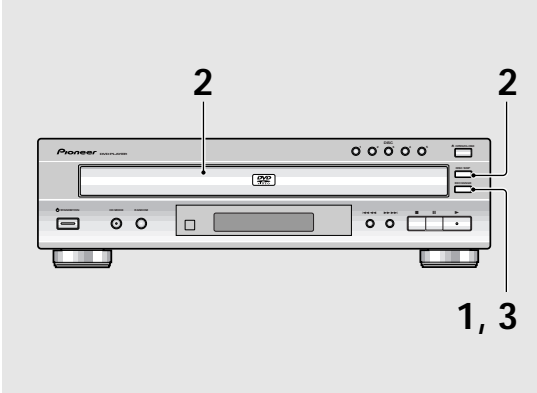

### 1 Press **EXCHANGE**.

The disc tray comes out.

### 2 Load a disc.

- Load a disc with the label side facing up, using the disc tray guide to align the disc.
- If you want to load more discs, press **DISC SKIP** to rotate the disc tray two disc space.

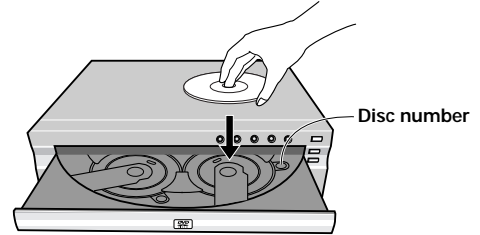

### Notes

- Load discs only in the two fully accessible disc spaces. Do not try and load discs into any of the other spaces; they may not load correctly and cause the unit to malfunction.
- Do not rotate the disc tray by hand. Always use the **DISC SKIP** button.
- Do not obstruct the movement of the disc tray.

### 3 Press **EXCHANGE**.

The disc tray goes back in.

### Note

Always use the **▲ OPEN/CLOSE** or **EXCHANGE** button to close the disc tray after exchanging discs. Do not push the disc tray shut.

## When a menu screen is displayed

Menu screens are displayed for DVDs that have menu screens or Video CDs that include Playback Control (PBC). DVDs often contain extra information that can be accessed in the DVD menu and sometimes makes navigating DVD menu screens as enjoyable as watching the feature presentation.

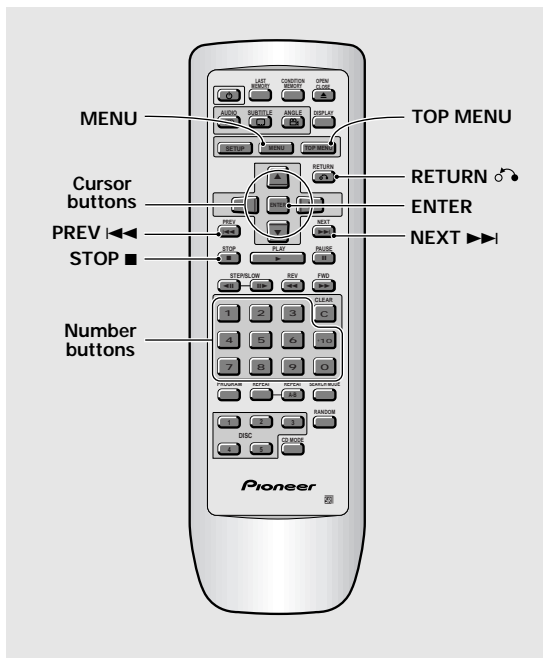

**Example:** When a DVD that has menu screens is loaded

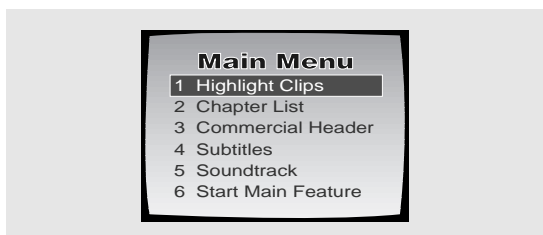

**Example:** When a Video CD that has Playback Control is loaded

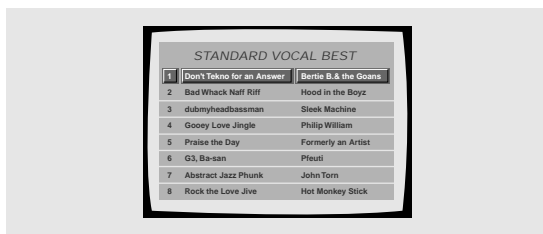

## To open or return to the DVD or Video CD menu screen

Although this differs depending on the disc, pressing **MENU**, **TOP MENU**, or **RETURN** during DVD playback or **RETURN** during Video CD playback displays the menu screen. Refer to the DVD or Video CD disc jacket and accompanying documentation for more information.

## To navigate a menu screen

- Although individual DVD titles may differ, when a menu screen is displayed, use the **cursor buttons** (◀/▶/▲/▼) and **ENTER** on the remote control. The **cursor buttons** are used to move around the options on the screen and **ENTER** is used for selection.
- Occasionally, the **number buttons** may also be used to make selections. If this is possible, using **number buttons** serves to directly select an option on a menu screen. Only **number buttons** are used to make selections on Video CD menu screens.
- When the Video CD has more than one menu, pages can be advanced to or returned to with **NEXT** or **PREV**.

## To play Video CDs without displaying menu screens

Video CDs with Playback Control (PBC) display a menu screen when play is started. It is possible, however, to play back Video CDs without displaying menu screens. When a Video CD with PBC is loaded, press **STOP**, and then the **number button** of the track you want to play.

## Auto Power on Function

Pressing any of the below buttons when the power is standby automatically turns the power on.

**PLAY**, **▶**, **▲** **OPEN/CLOSE\***, **DISC\***, **LAST MEMORY**.

\* These buttons are provided on the main unit only.

## When an operation is prohibited

There are times when you are using the player and attempt to perform an operation, but for some reason it cannot be performed. When this occurs, one of the two following icons appears on the screen.



The operation is prohibited by the player.



The operation is prohibited by the programming on the disc.

## Chapter (Track) Skip Forward/ Skip Back – DVD/Video CD/CD

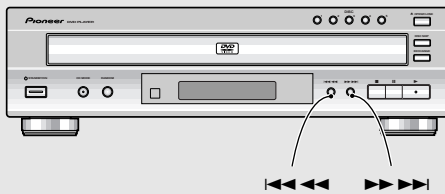
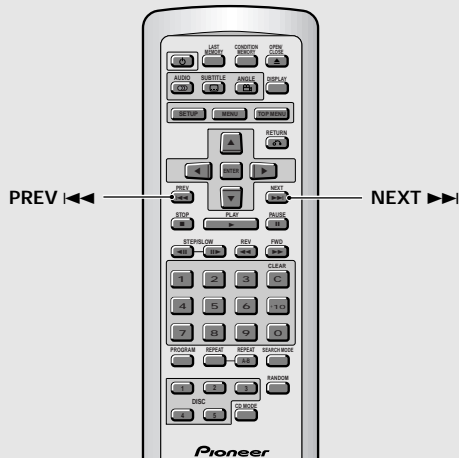

## Advancing to the next chapter (track)

Press **NEXT** ►► (►► ►► on the front panel).

- Press to skip forward to the next chapter (track).
- You can advance more than one chapter (track) forward by pressing and holding **NEXT** ►► (remote control only) and releasing when the desired chapter (track) number appears in the display.

## Skipping back to the previous chapter (track)

Press **PREV** ◄◄ (◄◄ ◄◄ on the front panel).

- Press once to skip back to the start of the chapter (track) currently playing.
- Press twice to skip back to the start of the previous chapter (track).
- You can skip back to previous chapters (tracks) by pressing and holding **PREV** ◄◄ (remote control only) and releasing when the desired chapter (track) number appears in the display.

## Forward and Reverse Scanning – DVD/Video CD/CD

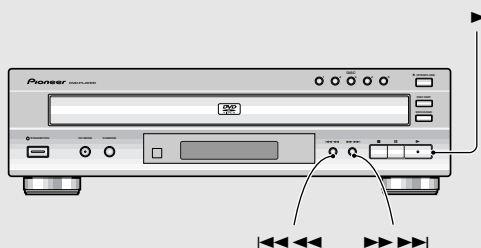
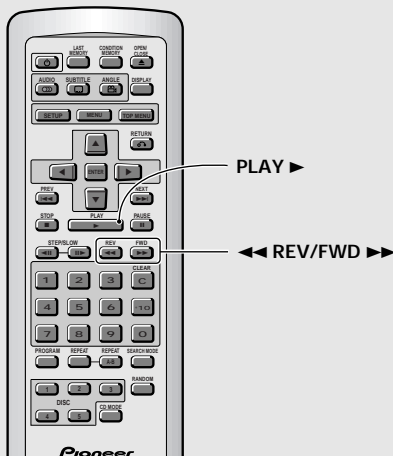

## Fast forward scanning

Press and hold **FWD** ►► (►► ►► on the front panel) during playback.

- Release **FWD** ►► when you reach the desired location. Normal playback resumes.
- When the "Scan" indicator on the screen changes from flashing to lit, fast forward scanning will continue even if the button is released. When the desired location has been reached, press **PLAY** ►.

## Fast reverse scanning

Press and hold **REV** ◄◄ (◄◄ ◄◄ on the front panel) during playback.

- Release **REV** ◄◄ when you reach the desired location. Normal playback resumes.
- When the "Scan" indicator on the screen changes from flashing to lit, fast reverse scanning will continue even if the button is released. When the desired location has been reached, press **PLAY** ►.



## Resuming Playback from Where You Stopped – DVD/Video CD

Use the resume feature to restart playback from the point that the disc was stopped last time.

### Press STOP ■ once.

The display shows “RESUME” and the stop position is memorized.

- The resume position remains memorized as long as the disc is in the play position — even if you switch the power off.  
If you change the disc in the play position or start playing another disc, however, the resume position is lost.
- Pressing **STOP ■** twice causes the disc to return to the beginning when **PLAY ►** is pressed again. The display shows the disc type (DVDs or Video CDs)

### Press PLAY ►.

Playback starts from the resume position.

#### Notes

- The actual restart position may be slightly before or after the resume position.
- If you want to remove or change the disc, but still want to resume playback from the last stopped position, use the **LAST MEMORY** feature instead (page 48).

#### CAUTION: When moving the unit

When changing places of installation or packing the unit for moving, be sure to remove all discs and return the disc table to its original position in the player. Then, press **⏻** **STANDBY/ON** and switch the power to standby. **Check that the “--OFF--” indication on the display goes off**, then disconnect the power cord. Moving this unit with the disc loaded may result in damage to this unit.

## Stopping Playback and Switching Power Off

– DVD/Video CD/CD

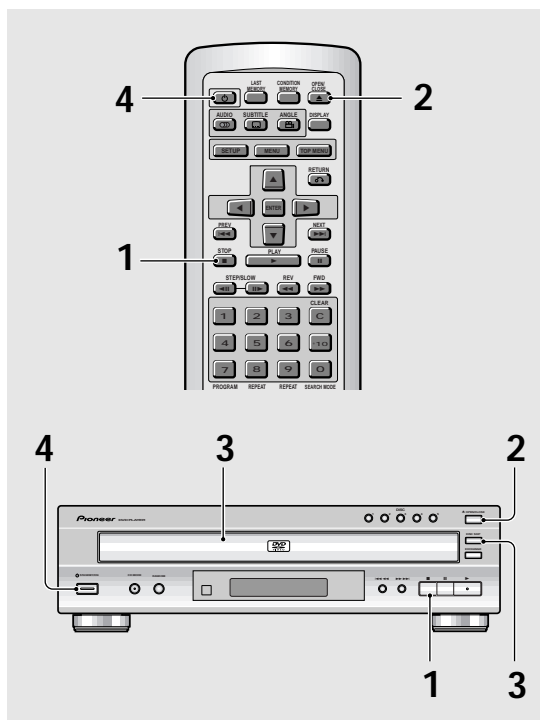

**1 Press STOP ■ (■ on the front panel).**  
Playback stops.

**2 Press OPEN/CLOSE ▲ (▲ OPEN/CLOSE on the front panel).**

- The disc tray comes out.
- The tray rotates and the disc that was playing is located towards the front of the table.

**3 Remove the disc.**

- If you want to remove more discs, press **DISC SKIP** to rotate the disc tray.

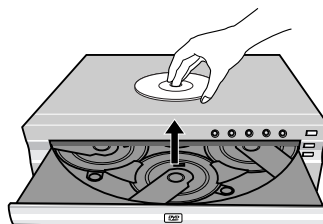

**4 Press ⏻ (⏻ STANDBY/ON on the front panel).**  
The disc tray goes back in.

# Adjusting Audio and Video Settings

## Using the Setup Screen Menus

The procedure on **pages 26 and 27** describes how to operate the menus on the Setup screen. These menus are used to set and adjust a number of system settings. The various functions that can be adjusted are covered throughout this manual. The procedure on this page provides a basic outline for using the Setup screen menus.

### When setting up for the first time

It is recommended to set up player using the Setup Navigator (**page 18**). If you selected **[Auto Start Off]** when the Setup Navigator appeared, you may still set up the player using the Setup Navigator in the **General** menu screen.

If you choose not to use the Setup Navigator, be sure to make the necessary settings in the Setup screen **Audio 1**, **Audio 2**, **Video**, and **Language** menus as described on the following pages.

Some DVDs start playing automatically when loaded in the player. If a DVD has been loaded, be sure to press **STOP ■** before proceeding.

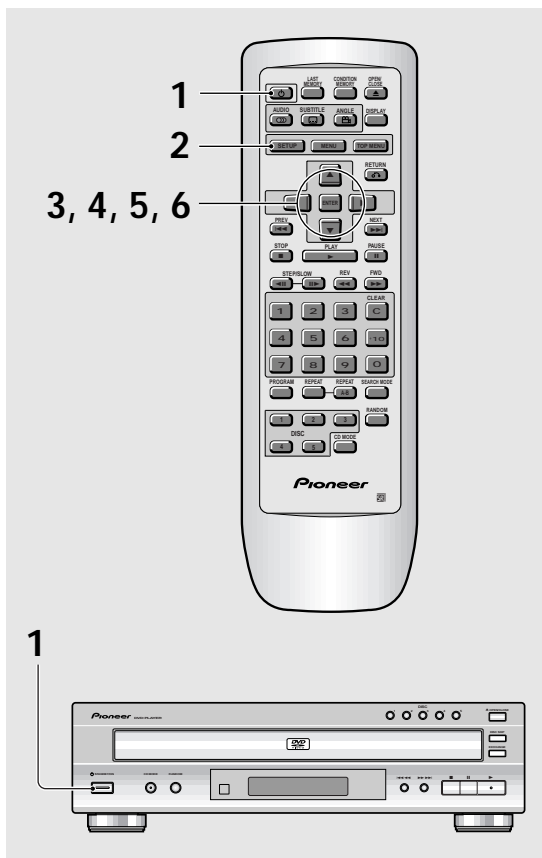

**1** Press **⏻** (**⏻ STANDBY/ON** on the front panel)

**2** Press **SETUP**.  
The Setup screen appears.

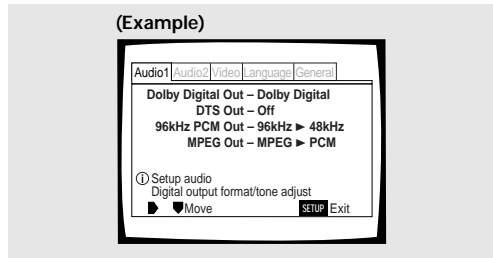

**3** Use the cursor buttons (**◀/▶**) to select the menu you want.

As each menu is selected with the cursor, the settings appear below the menu heading.

**4** Use the cursor buttons (**▼**) to enter the menu.

The top item within the menu becomes highlighted.

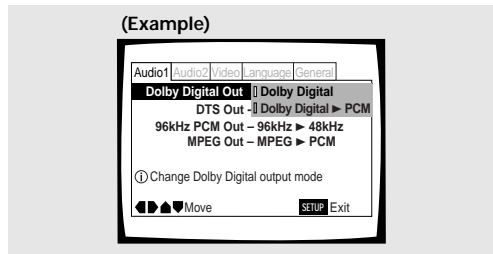

**5** Use the cursor buttons (**▲/▼**) to select the setting you want to change.

The options available for each setting appear to the right when the setting is selected. The current setting appears with the setting indicator lit.

**6** Use the cursor buttons (**▶**) to enter the setting options.

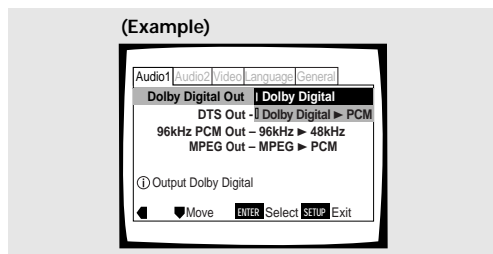

- Not all menu options can be changed while a disc is playing. In these cases, the options appear grayed out on the screen and cannot be adjusted. To change these settings, press **STOP ■** first before pressing **SETUP**.
- Operating the menu after pressing **STOP ■** may cancel the resume function.
- Some menu options are not immediately effective if set while a disc is playing. To make these settings effective, stop playback and then start again, or change the settings while the disc is stopped.

continued

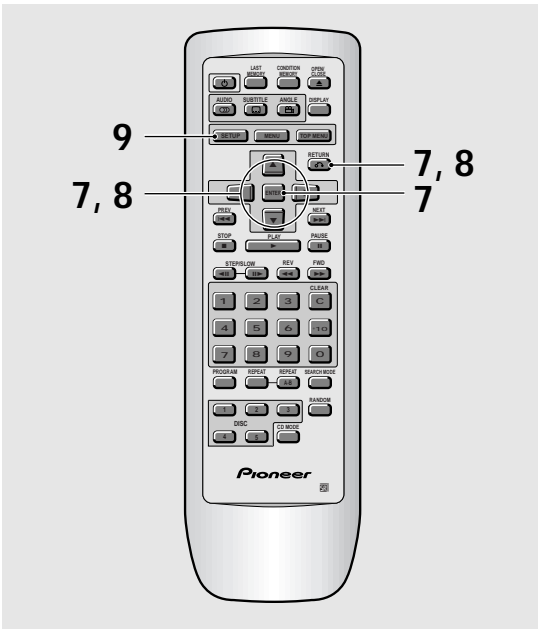

- 7** Use the cursor buttons (▲/▼) to select a new setting and press ENTER to set the new setting in memory. Press RETURN or the cursor button (◀) to exit the options without making any changes.
- 8** Press RETURN or the cursor button (◀) to go back to the main menu bar to select another menu.
- 9** Press SETUP to close the Setup screen.  
The Setup screen closes.

**Note**  
The next time you press **SETUP**, you'll see the menu screen that you exited from last time.

**How to interpret the setting indicator colors in the Setup screen menus**

When setting up the system, or when making adjustments, it is convenient to know what settings are applicable to the different disc formats. When the settings appear for each menu option, the currently selected setting appears with the setting indicator highlighted in one of three colors: blue, green or yellow. These colors correspond to what formats the menu option effects as shown in the table below.

Color of indicator	Disc format(s)
Blue	DVD only
Yellow	DVD / Video CD
Green	All compatible formats

**Note**  
If a setting applicable only to DVDs is changed while a Video CD or CD is loaded, a blue DVD icon appears in the upper right hand corner of the screen to indicate that the setting is not applicable to the currently loaded disc. The setting will be effective the next time a DVD is loaded.

**IMPORTANT**

**Changing to the Setup Screen "Expert" Menu Mode**

The Setup screen menus are divided into two levels, **[Basic]** and **[Expert]**, to make this unit more convenient to operate for different levels of users. The **[Basic]** menu mode contains functions that may be considered necessary for the basic operations of this player and helpful on-screen information identified by the **i** mark. The **[Expert]** menu mode adds to the **[Basic]** menu mode additional functions of the player that can be adjusted to further personalize performance of the player.

In this manual, functions that are contained in the **[Expert]** menu mode are identified by the **[Expert]** icon. Make changes to the **[Setup Menu Mode]** setting in the Setup screen **General** menu.

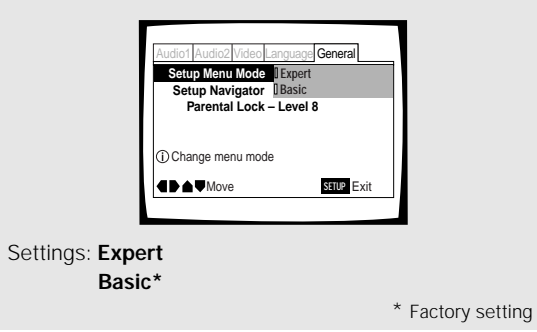

**Note**  
On-screen information only appears in the **[Basic]** menu mode.

## Setting the Digital Audio Output To Be Compatible with Your AV Component – DVD

This player is capable of digital audio output for Dolby Digital, DTS, MPEG, and signals with a sampling rate of 96 kHz. Make settings in the Setup screen **Audio 1** menu to reflect the capabilities of the components that you have made digital connections to.

### Notes

- If you have already completed the Setup Navigator screen operations, the settings on this page have already been set by the player.
- If you have made only stereo line connections (analog) using the supplied audio cord, it is not necessary to make any changes in this menu.

## Dolby Digital Out

This player is capable of outputting the Dolby Digital surround sound audio signal. When the player is connected to an AV component that has a built-in Dolby Digital decoder, select **[Dolby Digital]**. This player can also convert the Dolby Digital signal to a digital Linear PCM signal, the same digital signal output from a CD. Select **[Dolby Digital ► PCM]** when you have made connections to an amplifier or receiver with a Dolby Pro Logic decoder or a Digital Analog Converter (DAC).

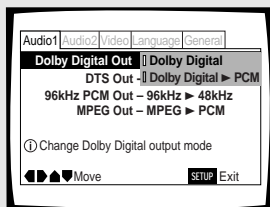

Settings: **Dolby Digital\***  
**Dolby Digital ► PCM**

\* Factory setting

## DTS Out

This player is capable of outputting DTS digital audio for DVDs recorded in DTS. When this player is connected to an AV component that has a built-in DTS decoder, select **[DTS]**. If your system is not equipped to decode DTS, select **[Off]**. Refer to the operating instructions supplied with your audio components if you are unsure about compatibility with DTS.

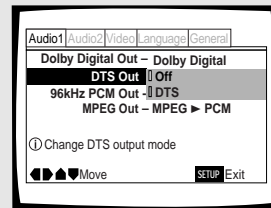

Settings: **Off\***  
**DTS**

\* Factory setting

### Note

If you have made digital audio connections to component(s) not equipped to decode the DTS digital bitstream, be sure to select **[Off]**. If a DTS signal is output without decoding, the output is digital noise that could potentially cause damage to your speakers.

## 96 kHz PCM Out

This player is capable of outputting digital signals with a sampling frequency of 96 kHz. If you have made connections to a component capable of processing this signal rate, select **[96 kHz]** for the signal to be output as is. As some components are incapable of processing digital signal input with sampling rates of 96 kHz, selecting **[96 kHz ► 48 kHz]** compresses the signal to a standard signal with a sampling rate of 48 kHz.

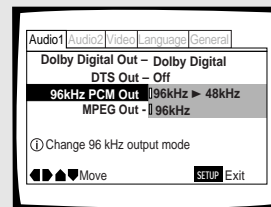

Settings: **96 kHz ► 48 kHz\***  
**96 kHz**

\* Factory setting

### Notes

- Some copy-protected DVDs recorded at 96kHz will not output a digital signal if **[96kHz PCM Out]** is set to **[96kHz]**. Set to **[96kHz ► 48kHz]** to output a digital signal.
- Changes to the **[96 kHz PCM Out]** setting cannot be made when a disc is playing.

## MPEG Out

This player is capable of outputting the MPEG digital bitstream. When the player is connected to an AV component that has a built-in MPEG decoder, select the **[MPEG]** setting. Otherwise, select **[MPEG ▶ PCM]** to convert the digital signal to the PCM signal, the digital signal output from a CD.

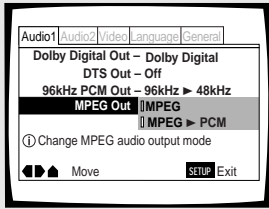

Settings: **MPEG**  
**MPEG ▶ PCM\***

\* Factory setting

## Digital Out **[Expert]** - DVD/Video CD/CD

Depending on your preferences and the type of connections made, you may opt not to have the digital audio signal output at all. When this setting is set to **[Off]** there is no signal output from the digital audio output jacks.

Make changes to the **[Digital Out]** setting in the Setup screen **Audio 1** menu in the **[Expert]** menu mode (page 27).

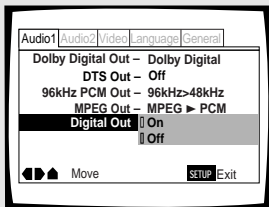

Settings: **On (Digital bitstream is output)\***  
**Off (Digital bitstream is not output)**

\* Factory setting

## Adjusting the Dynamic Range of the Audio Soundtrack - DVD

Audio DRC stands for Audio Dynamic Range Compression. When Audio DRC is on, soft sounds such as dialog can be heard more clearly without making loud sounds even louder. Select from three levels of compression depending on how much effect you want. When Audio DRC is set to **[Off]**, there is no effect on the audio source.

Make changes to the **[Audio DRC]** setting in the Setup screen **Audio 2** menu.

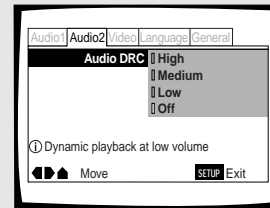

Settings: **High**  
(maximum compression of audio source)  
**Medium**  
(moderate compression of audio source)  
**Low**  
(very little compression of audio source)  
**Off\***

\* Factory setting

### Note

Audio DRC is only effective with Dolby Digital audio sources.

# Setting the TV Screen Size - DVD

The width-to-height ratio of conventional TVs is 4:3, while the width-to-height ratio of wide screen and high-definition TVs is 16:9. This width-to-height ratio is called the aspect ratio.

When viewing software recorded in different aspect ratios, the image's height to width ratio can be switched to match the TV or monitor being used.

Make changes to the TV screen size in the **[TV Screen]** setting in the Setup screen **Video** menu. Please note that changes to the **[TV Screen]** setting cannot be made when a disc is playing. Stop playback of the disc before attempting to make any changes.

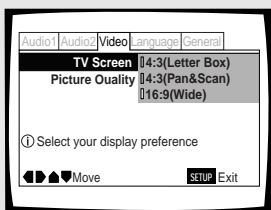

Settings: **4:3 (Letter Box)**

**4:3 (Pan & Scan)**

**16:9 (Wide)\***

\* Factory setting



## Notes





- If **[Standard (4:3)]** is selected in the Setup Navigator screen, **[4:3 (Letter Box)]** is selected on this screen. If you prefer the pan&scan format, change the settings on this screen.
- Whether the aspect can be switched or not depends on the disc. Please refer to the information written on the disc jacket, etc.
- Some discs may not include the screen format selected in the **[TV Screen]** setting. When this occurs, the standard TV screen format available on the disc is automatically selected.

## Differences in screen sizes and DVD formats

The number of screen size formats currently available can be somewhat confusing. If set incorrectly, the video presentation may not appear as it should. The following diagrams and descriptions are intended to help you set your TV screen size in a way that will allow you to fully enjoy the digital video of DVD.

The settings in the **[TV Screen]** setting are perhaps most applicable when the DVD you are watching is programmed in the wide screen format. If you have a standard TV, select either **[4:3 (Letter Box)]** or **[4:3 (Pan & Scan)]** based on your personal preference. If you have a wide screen TV, select **[16:9 (Wide)]**.

Widescreen (16:9) TV or monitor	
DVD screen size format	Setting and Appearance
<b>Wide screen format DVD</b> Please note that there are some wide screen letter box formats that place black bars at the top and bottom of the screen. This is not a malfunction.	 <p>"Wide" setting</p>
<b>Standard screen format DVD</b> When viewing a standard screen format DVD on a wide screen TV, black bars may be automatically placed at the side of the screen to adjust to the DVD format.	 <p>"Wide" setting</p>
<b>Standard screen format DVD (unnatural stretched effect)</b> If you are viewing a standard screen format DVD on a wide screen TV, the picture may appear 'stretched' on the screen. To remedy this condition, change your wide screen TV to display a standard (4:3) screen. Refer to the instructions supplied with your wide screen TV or monitor for more information.	 <p>"Wide" setting</p>

Standard (4:3) TV or monitor	
DVD screen size format	Setting and Appearance
<b>Wide screen format DVD</b> The Letter box presentation places black bars at the top and bottom portions of the screen to provide the full wide screen presentation of a movie on a standard TV (4:3 aspect ratio).	 <p>"Letter Box" setting</p>
<b>Wide screen format DVD</b> The Pan & Scan presentation crops both sides of the wide screen presentation to use the full standard TV screen.	 <p>"Pan &amp; Scan" setting</p>
<b>Standard screen format DVD</b> If you have a standard TV, the standard screen format will be presented regardless of the setting.	 <p>Any setting</p>
<b>Wide screen format DVD (unnatural squeezed effect)</b> If you are viewing a wide screen format DVD on a standard TV and the <b>[TV Screen]</b> setting is set to <b>[16:9 (Wide)]</b> , the picture may appear 'squeezed' on the screen. To remedy this condition, select either <b>[4:3 (Letter Box)]</b> or <b>[4:3 (Pan &amp; Scan)]</b> .	 <p>"Wide" setting</p>

## Selecting Picture Quality Appropriate for Program Content – DVD/Video CD

This lets you select the ideal picture quality for watching movies, animation and other video media. Make changes to the **[Picture Quality]** setting in the Setup screen **Video** menu.

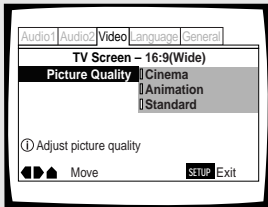

- Settings: **Cinema**  
Provides a sharp, clear black picture for images with high contrast.
- Animation**  
Provides images with bright, clear colors (this setting has no effect when using component video connections).
- Standard\***  
Presents the video with no effect added.
- \* Factory setting

## Switching the S-Video Output

**Expert** – DVD

You can Switch the kind of S-Video signal output from the S-Video outputs. If you connected your TV with an S-Video cord, in rare cases the TV picture may appear stretched. In this case switch the output from **[S2]** to **[S1]**.

Make changes in the **[S-Video Out]** in the Setup screen **Video** menu in the **[Expert]** menu mode (page 27).

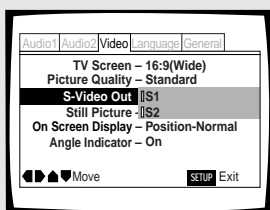

- Settings: **S1**  
**S2\***
- \* Factory setting

## Selecting the type of paused image to display **Expert** – DVD

This function lets you view a clear still-image when DVD playback is paused.

Make changes in the **[Still Picture]** setting in the Setup screen **Video** menu in the **[Expert]** menu mode (page 27).

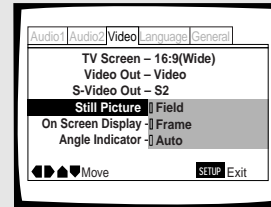

- Settings: **Field**  
(Picture shake will be eliminated during a paused picture.)
- Frame**  
(Select to obtain higher picture quality.)
- Auto\***  
(Selects **[Field]** or **[Frame]** automatically according to the disc.)
- \* Factory setting

## Setting the position of the on-screen display **Expert** – DVD/Video CD

When watching conventional software on a wide screen TV, the operation display is at the very top of the screen, and may be difficult to see. Changing the position of the display lets you see operation indicators clearly even on a wide screen TV.

Alternatively, you can choose to turn them off completely with the **[Off]** setting.

Make changes in the **[On Screen Display]** in the Setup screen **Video** menu in the **[Expert]** menu mode (page 27).

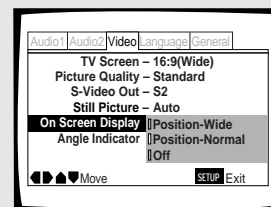



- Settings: **Position-Wide**  
**Position-Normal\***  
**Off**
- \* Factory setting

# Viewing from a Desired Camera Angle (Multi-Angle)

– DVD

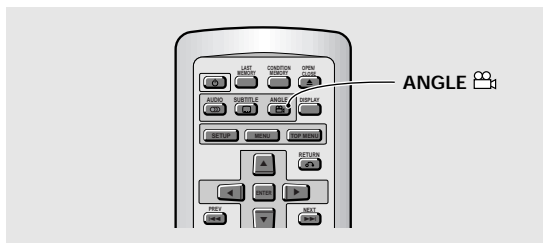
You can select a camera angle when viewing DVDs with the multi-angle option.



Press **ANGLE**  during playback.

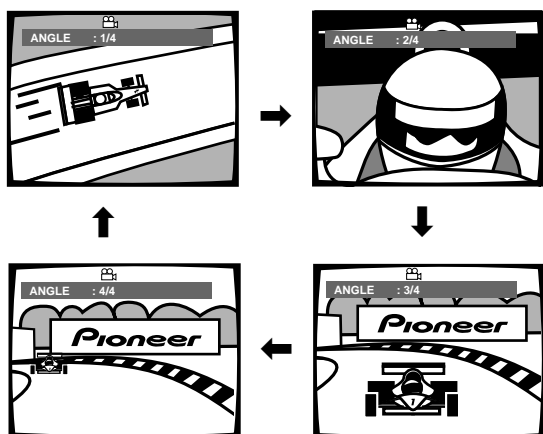

The camera angle changes each time you press the button.



## Notes

- You can use the Multi-Angle function only with discs featuring recordings of images shot from different camera angles.
- During Multi-Angle playback, the  indicator in the display panel of the player lights during playback.
- For some discs, selection can be made using the DVD menu. In this case, press **MENU** to display the DVD menu screen and then make your selection.

**To check whether or not a disc is recorded with angles:**

The jacket of discs that are recorded with angles will be marked with . When locations on discs that are recorded with angles are played back, the  indicator can be displayed.

To cancel the  indicator, set **[Angle Indicator]** to **[Off]** in the Setup screen **Video** menu described in the section below.

## Turning the angle indicator on and off **Expert**

When a picture recorded in different angles is played back  is displayed on the screen. This setting lets you see clearly whether the playback picture is recorded in multiple angles or not.

Turn the angle indicator on or off in the **[Angle Indicator]** setting in the Setup screen **Video** menu in the **[Expert]** menu mode (page 27).

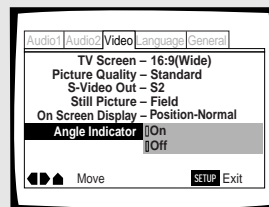

Settings: **On\*** ( is displayed)

**Off** (Not displayed)

\* Factory setting

## Note

Even when the **[Angle Indicator]** setting is set to **[Off]**, the  indicator in the display panel of the player lights during multi-angle playback. Therefore, it is possible to know when the multi-angle function can be used without having to display the icon on the screen.



# Setting the Language Options

DVDs have the capacity to contain a great deal of audio information, which includes the ability to hold up to 8 different language tracks and subtitle information in as many as 32 different languages. This section outlines the variety of audio language and subtitle options available with this player.

Please note that if you have completed the Setup Navigator, the audio and subtitle language options have automatically been set in accordance with the OSD language (the language that appears on the screen).

## Notes

- DVDs differ in content and do not all contain multiple language or subtitle information. Therefore making settings in this section may have no effect on some DVDs.
- If you have already completed the Setup Navigator screen operations, the settings on this page have already been set by the player.

## Setting the on-screen display (OSD) language – DVD/Video CD/CD

This setting is used to establish the language that operation indicators and on-screen messages and operations display. Change this setting in the Setup screen **Language** menu [**OSD Language**] setting.



Settings: **English\***  
**français**  
**Español**

\* Factory setting

## Note

The [**OSD Language**] setting is factory set to [**English**]. If you want English to be displayed, it is not necessary to adjust this setting.

## Setting Language and Subtitle Preferences in the Setup Screen Menus – DVD

The Setup screen **Language** menu contains a number of settings related to the audio and subtitle language preferences.

Please note that changes to the settings in the **Language** menu in this section cannot be made when a disc is playing. Stop playback of the disc before attempting to make any changes.

## Selecting an audio language preference

The audio language that you normally listen to can be selected from the various audio languages on a DVD. Even when the audio language is changed during playback by pressing **AUDIO**, the language selected at this setting will be selected as the default when the DVD is changed.

Make changes to the [**Audio Language**] setting in the Setup screen **Language** menu.



Settings: **English\***

**French**  
**Spanish**  
**Other**

(For details on how to select other languages, see 'When "Other" is selected' on **page 36**.)

\* Factory setting

# Changing the Audio Language (Multi-Language Function) – DVD

Dolby Digital, PCM, and other audio data can be recorded on DVDs in a number of languages or audio tracks, letting you choose the desired language or audio.

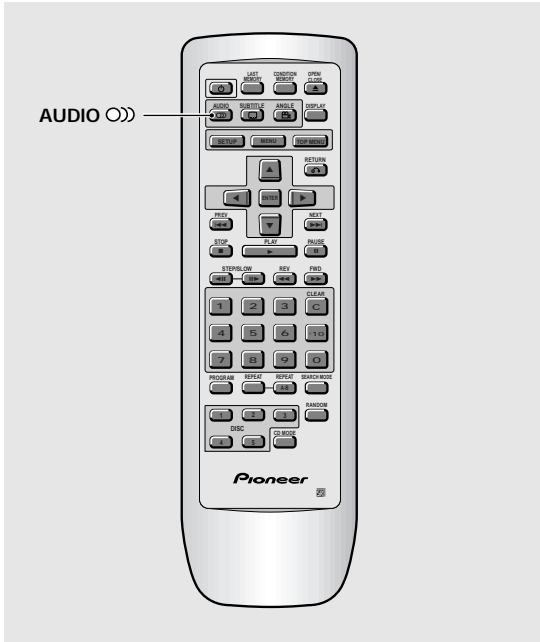

Press **AUDIO** repeatedly to select the desired language.

Pressing **AUDIO** once displays the currently selected language. Subsequent presses rotate through the audio languages available on the DVD.

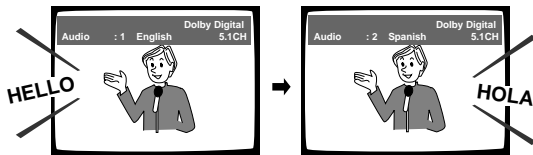

## Notes

- You cannot switch languages if there is only one language recorded on the disc.
  - Switching the audio language may not be possible with some titles. In this case, the mark is displayed.
  - For some titles, selection can be made using the DVD menu.
- In these cases, press **MENU** to display the DVD menu screen and then make your selection.

# Changing Audio Type – Video CD/CD

For enjoyment of karaoke or similar format Video CDs and CDs, it is possible to select stereo audio, or either right or left channel depending on the requirements of the source.

Press **AUDIO** repeatedly during playback to switch the audio type.

Audio output changes from **[1/L]** (Left channel) to **[2/R]** (Right channel) to **[Stereo]**.

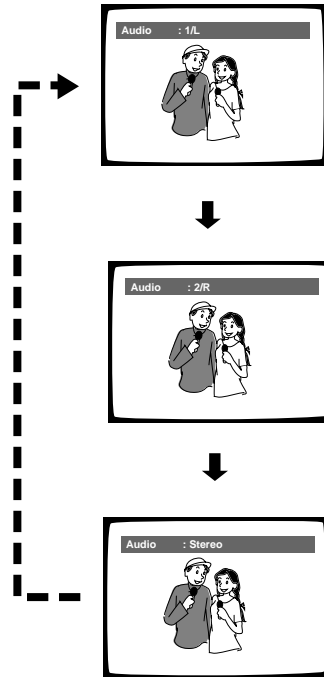

## Note

With karaoke and other discs, set the appropriate audio type for singing and accompaniment after referring to information on the disc jacket or accompanying material.

# Selecting a Subtitle Language (Multi-Language Subtitles)

– DVD

You can select a desired subtitle language with DVDs that have subtitle data in multiple languages recorded on them.

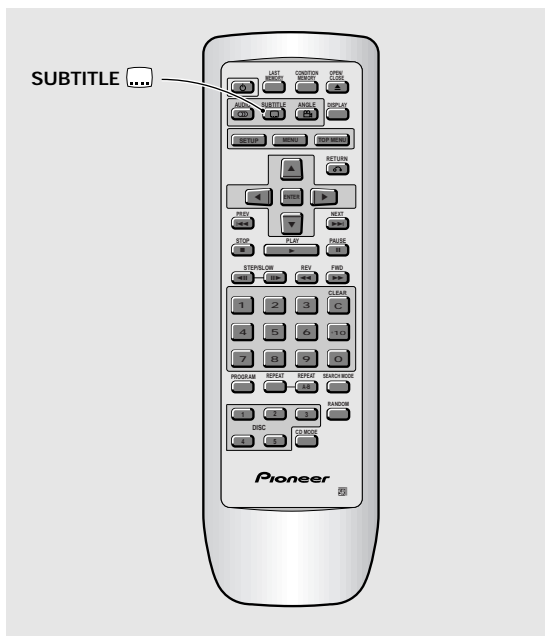

Press **SUBTITLE** repeatedly during playback.

Pressing **SUBTITLE** once displays the currently selected subtitle language. Subsequent presses rotate through the subtitle languages available on the DVD.

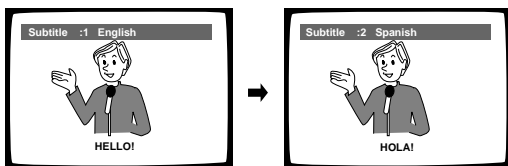

## Notes

- The subtitle language cannot be switched if the subtitle language is not recorded, or if only one language is recorded.
- Switching the subtitle language may not be possible with some discs. In this case, the  mark will be displayed.
- To clear subtitles during playback, press **SUBTITLE** and then press **CLEAR**, or press **SUBTITLE** until **[Off]** appears.
- For some discs, subtitle language selection can be made using the menu on the DVD. In this case, press **MENU** to display the DVD menu screen and then make your selection.

## Selecting a subtitle language preference

The subtitle language that you will normally display can be selected from the subtitles programmed on a disc. Even when the subtitle language is changed during playback by pressing **SUBTITLE**, the language selected at this setting will be selected when the disc is changed.

Make changes to the **[Subtitle Language]** setting in the Setup screen **Language** menu.

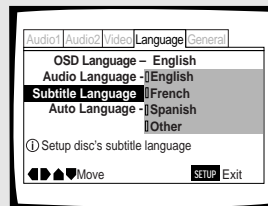

Settings: **English\***

**French**

**Spanish**

**Other**

(For details on how to select other languages, see 'When "Other" is selected' on page 36.)

\*Factory setting

## When "Other" is selected

When you want to select one of the 136 languages as the main audio language, follow the steps below when the following screen appears.

A language code list can be found on page 54.

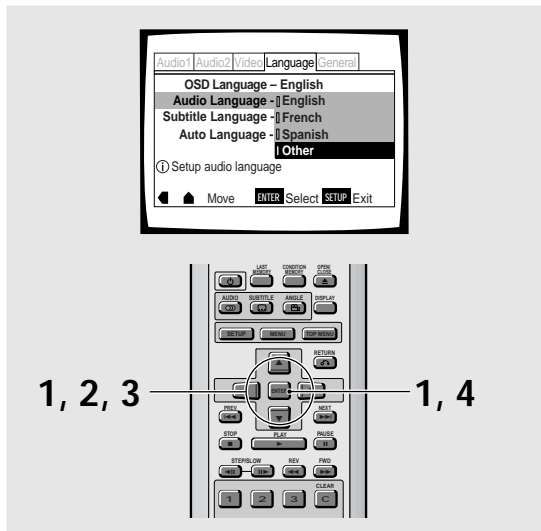

### 1 Use the cursor buttons to select [Other] and press ENTER.

The language selection screen appears.

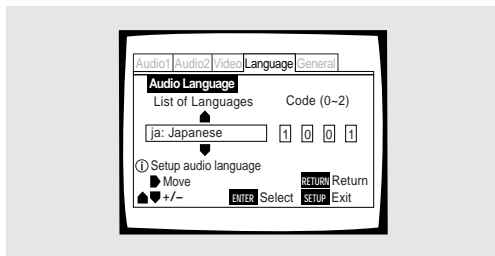

### 2 Use the cursor buttons (◀/▶) to select either [List of Languages] or [Code].

### 3 If you select [List of Languages], use the cursor buttons (▲/▼) to select the language.

For languages which are only shown as a code, please refer to "Language Code List" on page 54.

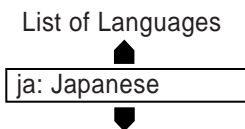

If you select [Code], use the cursor buttons (▲/▼) to input the numbers of the input code.

Use the cursor buttons (◀/▶) to change the position of the cursor. You can also use the number buttons to enter the code.

Code (0~2)

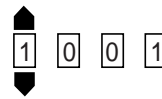

### 4 Press ENTER to set the new language.

To exit the screen without making any changes, press RETURN ⏪.

## Setting Auto Language to control subtitle and audio language based on program content

When the Auto Language function is used, foreign movies are shown with the original audio soundtrack and subtitles in the language selected in the [Subtitle Language] menu option. Domestic films are shown with the original audio soundtrack and no subtitles. (This setting may not be effective with all DVD discs.) Make changes to the [Auto Language] setting in the Setup screen Language menu.

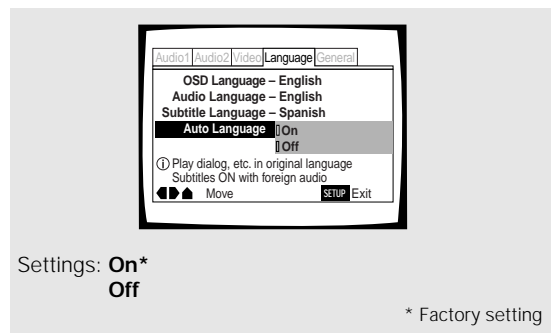

#### Note

The Auto Language function operates only when this function is set to [On], and the language set for the [Audio Language] and [Subtitle Language] settings is the same.

## Selecting a DVD menu language preference Expert

In addition to containing different audio languages, DVD may also contain menu screens in different languages as well. Setting a DVD language preference, sets the selected language as a default when DVDs with menu information in that language are encountered.

Selecting **[w/ Subtitle Language]** automatically assigns the language selected in the **[Subtitle Language]** setting.

Make changes to the **[DVD Language]** setting in the Setup screen **Language** menu in the **[Expert]** menu mode (**page 27**).

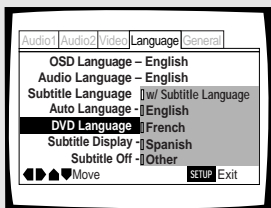

Settings: **w/ Subtitle Language\***

**English**  
**French**  
**Spanish**  
**Other**

(For details on how to select other languages, see *'When "Other" is selected'* on **page 36**.)

\* Factory setting

### Notes

- The menu settings may look different from the one shown above.
- Some discs have their own default menu language. In this case, press **MENU** to open the DVD disc menu and select the language you want from there.

## Selecting subtitles, assist subtitles or no subtitles Expert

Use this function to turn the subtitles on or off. Additionally, some DVDs provide assist subtitles that provide additional explanations of scenes in addition to the standard subtitles for viewers who are hard of hearing. Select **[Assist Subtitle]** to display these subtitles on DVDs where this function is offered. Make changes to the **[Subtitle Display]** setting in the Setup screen **Language** menu in the **[Expert]** menu mode (**page 27**).

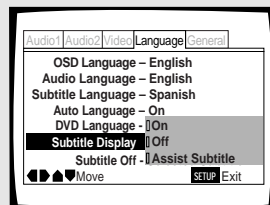

Settings: **On\***

**Off**

**Assist Subtitle**

\* Factory setting

### Notes

- If there is no subtitle information recorded on the DVD, no subtitles are displayed even if this function is set to **[On]**.
- This setting serves as a default as to whether or not to display subtitles. Even if this option is set to **[Off]**, subtitles can be displayed by pressing **SUBTITLE** ( ). Similarly, if this option is set to **[On]**, the subtitles can be turned off by pressing **SUBTITLE** ( ) and then **CLEAR**.

## Forcing subtitles to be displayed Expert

Even when the subtitles are turned off, some DVDs will nevertheless display them on the screen. This setting allows you to select the language of the subtitles to be displayed with this type of DVD.

Select **[With Audio]** to display the subtitles in the same language as the currently selected **[Audio Language]**. Select **[Selected Subtitle]** to display the subtitles in the language set in the **[Subtitle Language]** setting. Make changes to the **[Subtitle Off]** setting in the Setup screen **Language** menu in the **[Expert]** menu mode (**page 27**).

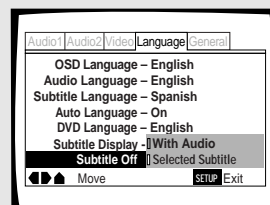

Settings: **With Audio**

**Selected Subtitle\***

\* Factory setting

# Advanced Functions

This player is compatible with DVD, Video CD, and CD disc formats. Users already familiar with Video CD or CD will already be familiar with some of the functions the player is capable of performing. With DVD, an even greater number of possibilities and functions are available.

## Note

DVDs differ in content and do not all contain the same information. Therefore some functions in this section may not work or have no effect on some DVDs.

## Setting the Parental Lock Level – DVD

This player lets you set the Parental Lock if the DVD has a parental lock level recorded on it. With Parental Lock capable discs, you can block access to material you feel is inappropriate for your children. Refer to the DVD disc jacket and the accompanying documentation to see if a particular disc contains a parental lock level.

Make changes to the **[Parental Lock]** setting in the Setup screen **General** menu. Please note that changes to the Parental Lock level cannot be made when a disc is playing. Stop playback of the disc before attempting to make any changes.

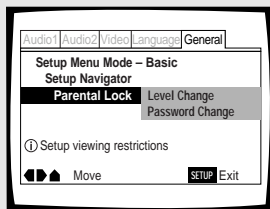

Settings: **Level Change**

(For information, refer to “*Setting the Parental Lock level*” on the following page.)

**Password Change**

(For information, refer to “*Changing the password*” on the following page.)

### When a DVD with a set Parental Lock level is loaded

Playback cannot be started until the code number has been correctly input by using the **cursor buttons** (◀/▶/▲/▼) or the **number buttons**, and **ENTER** has been pressed.

### Entering the password

When you select either **[Level Change]** or **[Password Change]**, it is necessary to enter the password (4-digit code number). Use the following steps at any time you are asked to enter or confirm your password.

- 1 Use the **cursor buttons** (▲/▼) or the **number buttons** to select a number between 0 and 9.

You can also use the **number buttons** to enter the numbers directly. When entering your password for the first time, or changing it, you will be asked to reenter your password. When using the **number buttons** to confirm the password, the numbers appear as asterisks, and the cursor advances automatically to the next position.

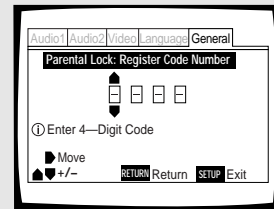

- 2 Use the **cursor buttons** (◀/▶) to move the cursor to a different position in the password.

When all four numbers of the password have been entered, **ENTER** appears on the screen.

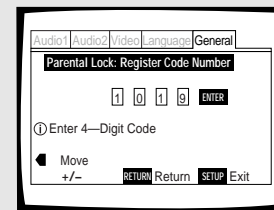

- 3 Press **ENTER** to set the new password. The password is entered.

## Note

Be sure not to forget your password. If you should forget it, reset the system, and enter a new password. To reset the system, see “*Resetting the Player to System Settings*” (page 51). Please note that this procedure resets the system, and clears all saved settings, not just the password.

## Setting the Parental Lock level

Change the Parental Lock level to a higher or lower level according to the settings printed on the DVD disc jacket or accompanying documentation. If you use the Condition Memory function to save the settings for a particular disc, the Parental Lock level is saved as well. Because it is saved in memory, Parental Lock levels can be set for individual discs according to their content rather than a set level for all DVDs.

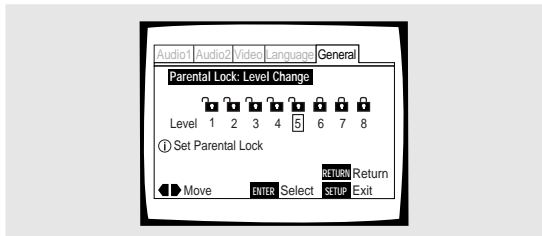

### 1 Select [Level Change] in the [Parental Lock] setting and press ENTER.

The screen changes to the password input screen. If you have not yet set a password, you will be asked to do so at this time. To enter the password, refer to *'Entering the password'* on the previous page.

### 2 Use the cursor buttons (◀/▶) to adjust the Parental Lock level.

The lock icons appear **"unlocked"** up to the selected level to indicate that access is available.

### 3 Press ENTER to set the new level.

The new Parental Lock level is set and the screen returns to the **General** menu screen. To go back to the **General** menu screen without making any changes, press **RETURN** ↵.

## Changing the password

Change your password whenever you feel it is necessary. However, if you forget your existing password, you cannot enter this screen to change it.

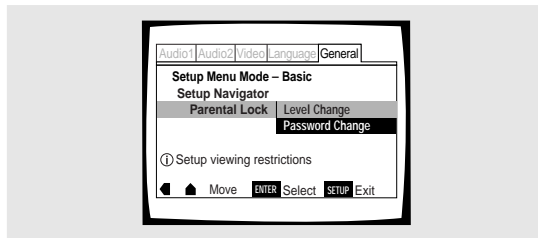

### 1 Select [Password Change] in the [Parental Lock] setting and press ENTER.

The screen changes to the password input screen. To enter the password, refer to *'Entering the password'* on the previous page.

### 2 Enter your current password.

To enter the password, refer to *'Entering the password'* on the previous page.

If you have not yet set a password, you cannot select this setting. Establish a password by selecting **[Level Change]** first.

### 3 Use the cursor buttons (◀/▶/▲/▼) or the number buttons to enter the new password.

### 4 When the new password has been entered, press ENTER.

The new password is set and the screen returns to the **General** menu screen. To go back to the **General** menu screen without making any changes, press **RETURN** ↵.

## Turning the Screen Saver On and Off Expert

As a protective function against residual images on the TV screen or monitor, a phenomenon referred to as "screen burn", the screen saver appears when the same screen has been displayed for a length of time. By default, the screen saver is turned on. However, the screen saver function can be turned on and off at your discretion.

Make changes to the **[Screen Saver]** setting in the Setup screen **General** menu in the **[Expert]** menu mode (page 27).

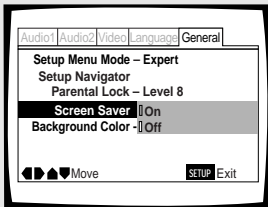

Settings: **On**  
**Off**

Note: Factory setting varies with country/region

## Changing the Background Color of the Screen Expert

You can select a blue or black background to appear when the player is in the stop mode.

Make changes to the **[Background Color]** setting in the Setup screen **General** menu in the **[Expert]** menu mode (page 27).

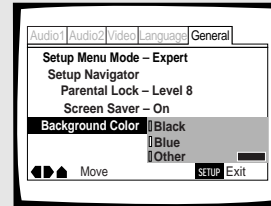

Settings: **Black**  
**Blue\***  
**Other**

\*Factory setting

### When "Other" is selected

This player gives you the option of creating your own background color by adjusting the red, green and blue levels.

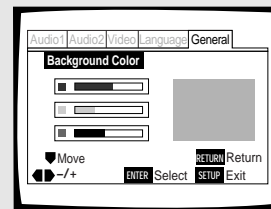

- 1** Use the cursor buttons (**▲/▼**) to select a color bar.  
The selected color bar becomes highlighted.
- 2** Use the cursor buttons (**◀/▶**) to adjust the level of the color.  
As the color bar is adjusted, the square on the right side of the screen indicates how the current mix of the three colors appears.
- 3** Repeat steps 1 and 2 until you have achieved a color that you like.
- 4** Press **ENTER** to set the color as the background color.



## Playing CDs only (CD Mode) – CD

Using this feature you can play only the CDs loaded in the disc tray—automatically skipping over any DVDs or Video CDs loaded. This may be useful if you have a mixture of discs loaded but only want to play music: you don't have to keep track of what kind of disc is where in the disc tray.

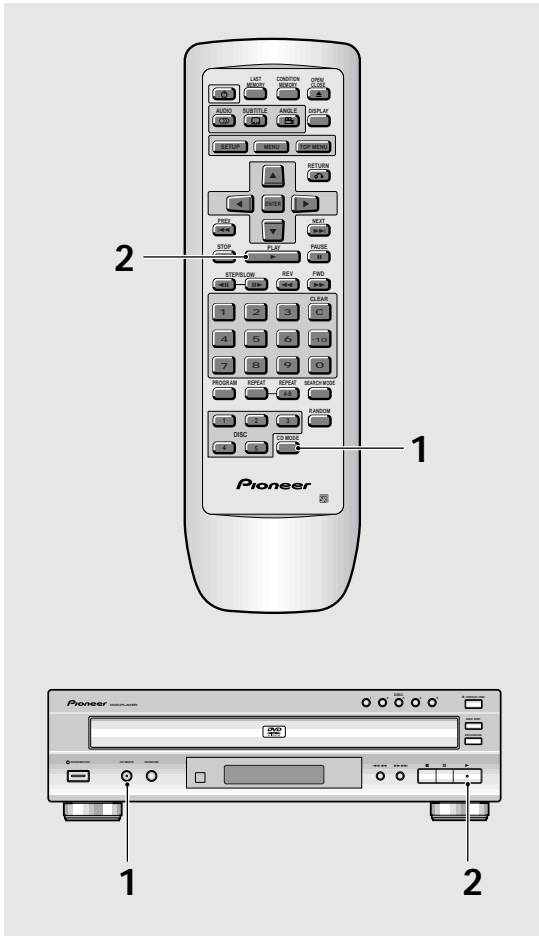

### 1 Press CD MODE.

The button lights when CD mode is on.

### 2 Press PLAY ►.

The player automatically starts playing the first CD loaded.

Once all the CDs loaded have played, the player automatically stops.

### Notes

- You can't switch on CD mode while playing a DVD or Video CD. Stop playback first.
- In CD mode, a disc number with a disc mark (◡) indicates a CD (page 10).
- The **DISC SKIP** button is ineffective if all the other discs loaded are DVDs or Video CDs, or if all the other disc trays are empty.
- Although program play is not possible in CD mode, it is possible to program a playlist. When you start program playback, however, CD mode is canceled (pages 46–47).
- Repeat and random play is possible in CD mode (pages 44, 45).

### To switch off CD mode:

- Press **CD MODE**.  
The button light switches off.
- If you open the disc tray using the ▲ **OPEN/CLOSE** button load a DVD or Video CD in the front-most position then press **PLAY ►**, CD mode automatically switches off.

## Still Frame/Slow Play/Frame Advance Playback – DVD/Video CD

The video images on DVD and Video CD can be viewed as a still frame, played back at slow speeds and even advanced frame by frame.

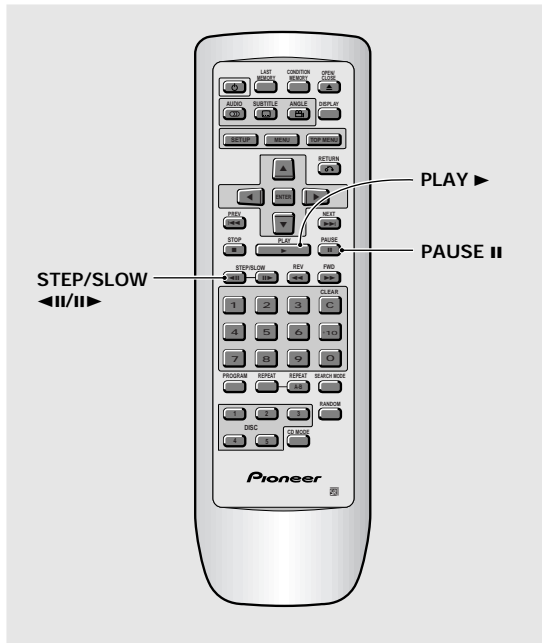

## Viewing a still frame

### Press PAUSE II.

When viewing a DVD, if the paused picture shakes, select the **[Field]** setting in the Setup screen **Video** menu **[Still Picture]** setting as described in the section on **page 31**.

### To return to normal playback

When viewing a still frame playback, pressing **PAUSE II** or **PLAY ►** restores normal playback operation.

## Viewing slow playback

### Press and hold STEP/SLOW II▶ during playback.

- Slow playback is engaged.
- During slow playback, the speed of playback can be adjusted from 1/2 normal playback speed to 1/16 normal playback speed in four steps using **STEP/SLOW ◀II and II▶**.

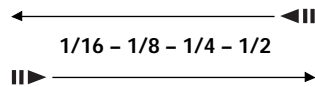

### Press and hold STEP/SLOW ◀II during DVD playback.

- Slow playback in the reverse direction is engaged.
- In the reverse direction, the playback speed cannot be adjusted.

### To return to normal playback

When viewing still frames or slow playback, pressing **PLAY ►** restores normal playback operation.

## Frame by frame advance playback: Viewing one frame at a time

### 1 Press PAUSE II.

### 2 Press STEP/SLOW ◀II or II▶.

**STEP/SLOW II▶:** The picture advances one frame each time the button is pressed.

**STEP/SLOW ◀II:** The picture backs up a DVD a few frames each time the button is pressed.

### To return to normal playback

When viewing frame by frame playback, pressing **PLAY ►** restores normal playback operation.

#### Notes

- There is no sound when viewing still frames or slow playback, or when advancing one frame at a time.
- Still frame, slow play, or frame advance playback may not be possible with certain titles. In this case, the  mark is displayed.

# Searching for a Title, Chapter, Track, or Location on a Disc

– DVD/Video CD/CD

This player offers different ways of accessing the information on a DVD, Video CD, or CD. Using **SEARCH MODE**, you can search for titles or chapters on a DVD, tracks on a Video CD or CD, and even select the point in time to start playback.

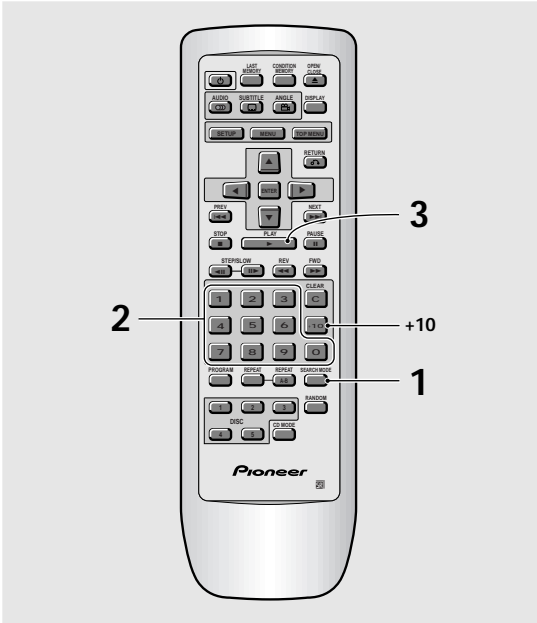

## 1 Press **SEARCH MODE** repeatedly to select the type of search.

The type of search changes which each press as follows.

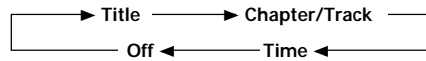

## 2 Press the number button(s) of the desired title, chapter or track or of the specific time where you would like to begin playback.

- To select number 3, press **3**.
- To select number 10, press **1** and **0**.
- To select number 87, press **8** and **7**.

### When performing a time search:

- To select 21 minutes, 43 seconds, press **2, 1, 4,** and **3**.
- To select 1 hour, 14 minutes, press **7, 4, 0,** and **0**.

## 3 Press **PLAY** ▶.

Playback of the selected title, chapter or track starts. When a time search is performed, playback begins at the appointed time.

### To perform a direct title or chapter/track search using the number buttons

Press the **number buttons** while the disc is stopped to select a title or track number.

Press the **number buttons** while the disc is playing to select a chapter or track number.

- To select number 3, press **3**.
- To select number 10, press **+10** then **0**.
- To select number 37, press **+10, +10, +10** then **7**.

### Notes

- For some discs, selection can be made using the top menu on the DVD. In this case, press **TOP MENU** to display the menu screen and then make your selection.
- With some DVDs, the search operation may not be possible and may stop shortly after being performed. In this case, the  mark is displayed.
- Time search is not possible with CDs.
- When performing DVD time search, playback may start from a slightly different time than that specified.
- Time search is not possible during when the disc is stopped.
- Search using time search is not possible during PBC playback of Video CDs.

# Repeat Play – DVD/Video CD/CD

You can repeat chapters or titles on DVDs, or repeat tracks, one disc or all discs (ALL) with CDs and Video CDs. You can also repeat just a specified part of a chapter or track.

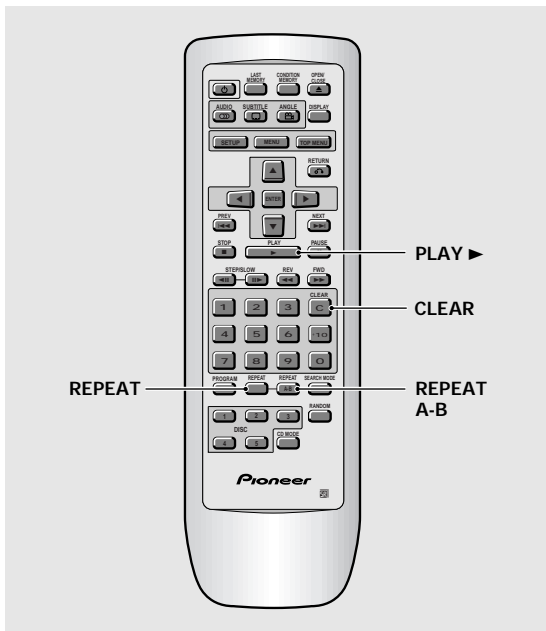

## Repeat play options for DVD

Press **REPEAT** once during playback of the chapter you want to repeat, and twice to repeat playback of the current title. Each time **REPEAT** is pressed, the repeat mode changes as follows.

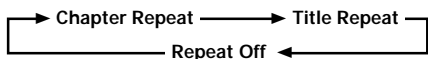

- During repeat title playback, the title continues playing until the end, and then playback starts once more from the beginning of that title.

## Repeat play options for Video CD and CD

Press **REPEAT** once during playback of a track you want to repeat, twice to repeat playback of the current disc, and three times to repeat all of the discs loaded in the player. Each time **REPEAT** is pressed, the repeat mode changes as follows.

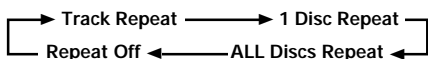

- During ALL Discs Repeat playback, if a DVD is loaded in the player, repeat playback is canceled, and normal playback of the DVD begins.

### To repeat random playback

Press **REPEAT** once during random playback to repeat the random (**pages 45**).

### To repeat a program

Press **REPEAT** once during program playback to repeat the program (**pages 46-47**).

### To cancel repeat play

Press **CLEAR**. Playback continues, but the repeat function is canceled.

## Repeat play of a specified section

Press **REPEAT A-B** at the beginning and end of the section you want to repeat.

- When **REPEAT A-B** is pressed a second time, the disc returns to the location where **REPEAT A-B** was pressed first and plays the selected section repeatedly.
- You can only perform A-B repeat within the same title, chapter, or track.

### To cancel REPEAT A-B repeat play

Press **CLEAR**. Playback continues, but the repeat function is canceled.

## Return to a specified location on a disc

- 1 Press **REPEAT A-B** at the desired location.
- 2 When you want to return to the specified location, press **PLAY**.

### To clear the specified location

Press **CLEAR** to cancel repeat play or to clear the specified location that was set using **REPEAT A-B**.

**Notes**

- With some DVD discs, there may be times when repeat playback is not possible. In these cases, the mark will appear on the screen.
- With Video CDs, repeat play is not possible when the menu is displayed (PBC playback). To perform repeat play, start playback without displaying a menu by pressing the track number to be repeated when the disc is stopped, and then press **REPEAT**.
- If you switch camera angle during repeat play, repeat play is cancelled.

## Random Play – DVD/Video CD/CD

You can play in random order chapters or titles on DVDs, or tracks, 1 disc, or all discs (ALL) with CDs and Video CDs.

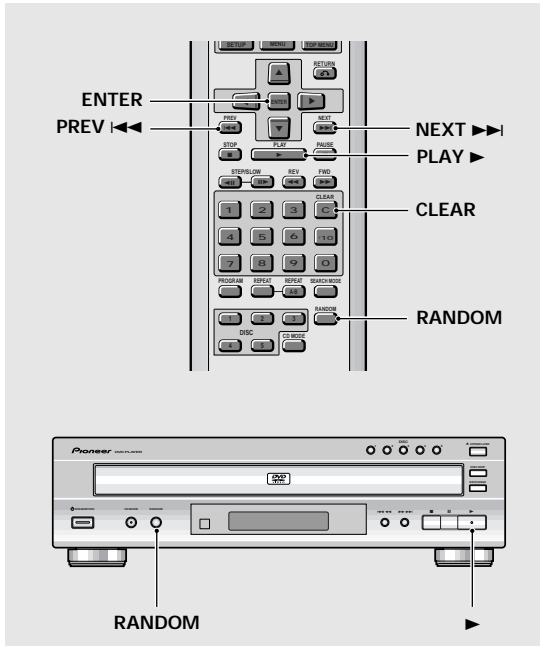

### Random playback of chapters within one title – DVD

Press **RANDOM** once, then press **ENTER** or **PLAY** ► (RANDOM then ► on the front panel).

“Random Chapter” appears on the screen, and chapters within the title will be played back in random order.

### Random playback of titles – DVD

Press **RANDOM** twice, then press **ENTER** or **PLAY** ► (RANDOM then ► on the front panel).

“Random Title” appears on the screen, and titles will be played back in random order.

### Random playback of all tracks on a disc – Video CD/CD

Press **RANDOM** once, then press **ENTER** or **PLAY** ► (RANDOM then ► on the front panel).

“Random 1 Disc” appears on the screen, and random playback begins.

### Random playback of all tracks on all discs – Video CD/CD

Press **RANDOM** twice, then press **ENTER** or **PLAY** ► (RANDOM then ► on the front panel).

“Random All Discs” appears on the screen, and random playback begins.

All tracks on all CDs and Video CDs loaded will play in a random order (DVD discs loaded will be ignored).

### To change titles, chapters, or tracks during random play

- Press **NEXT** ►► and the next randomly selected track starts playing.
- Press **PREV** ◀◀ and playback of the current track starts again from the beginning.

### To stop random play

Press **CLEAR**. This returns you to normal playback of chapters/tracks in order from the chapter/track currently playing.

#### Notes

- Random play is not possible when a PBC Video CD is playing. Stop the disc first, then select either 1 disc or all discs random play.
- Random play of programmed chapters/tracks is not possible.
- In the case of DVDs, random playback may not be possible with some discs.
- To continued random play, press **REPEAT** (page 44)

# Playback in a Desired Order (Program Play) – DVD/Video CD/CD

The titles and chapters on a DVD and similarly the tracks on a Video CD or CD can be arranged to play in the order you want. You can create a program mixing titles, chapters, and tracks on all of the discs loaded in the disc tray.

**Note**

Although program play is not possible in CD mode, it is possible to program a playlist. When you start program playback, however, CD mode is canceled.

## Programming

A program with a maximum of 24 steps can be memorized from any of discs loaded in this player.

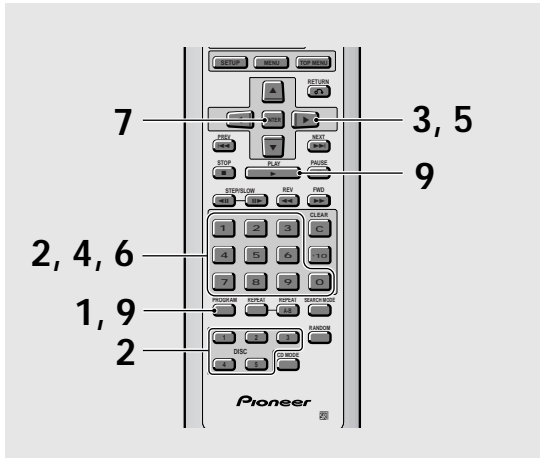

### 1 Press PROGRAM.

The Program screen appears.

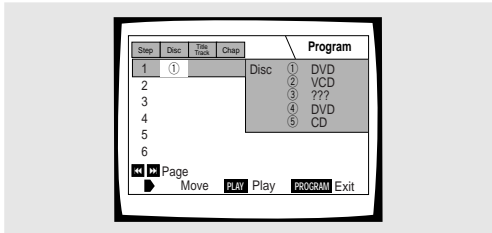

### 2 Use the number buttons or DISC (1 through 5) to enter a disc number.

- If this is the first step you are programming, the number of the disc that is currently in the play position will appear automatically.
- If the player has already read the contents of the disc you want to program, the disc information appears in the box on the right side of the screen (type of disc, number of titles/chapters/tracks, etc.). If the player has not yet read the disc then "???" appears in the box for disc type.

**Note**

If you want to program the entire selected disc, proceed to step 7.

### 3 Use the cursor buttons (▶) to select the Title/Track field.

### 4 Use the number buttons to enter the title or track numbers in the order you want

- For DVDs, this number will be a disc title; for Video CDs and CDs, a track number.
- To enter title/track 6, press 6. To enter title/track 14, press 1, 4.

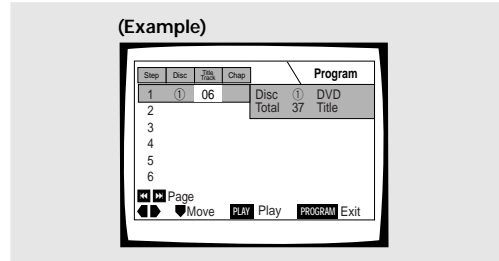

**Notes**

- If the current disc is a DVD, and you want to program chapters, proceed to the next step.
- If the current disc is a Video CD or CD, or if you want to program entire titles on a DVD, proceed to step 7.

### 5 Use the cursor buttons (▶) to select the Chapter field.

### 6 Use the number buttons to enter the chapter numbers in the order you want

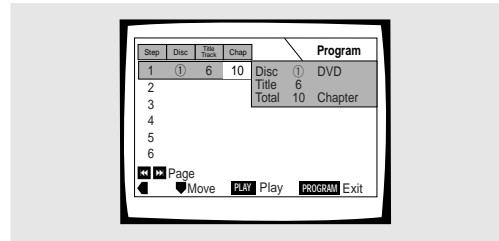

### 7 Press ENTER or the cursor button (▼).

- The cursor moves down to the disc number field in the next step set.

### 8 Repeat steps 2-7.

### 9 Press PLAY ▶ to start playback in the programmed order.

- Press PROGRAM to exit the program screen.
- The program remains active even if you open the disc tray and change discs. If a step in the program cannot be played (because the track number is too high, for example), that step is automatically skipped.

**Note**

If the power is disconnected, the playlist is erased.

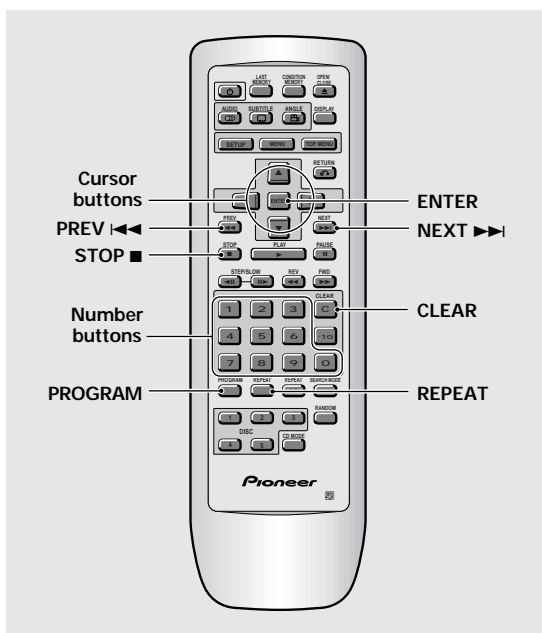

## To confirm the contents of a program

- 1 Press PROGRAM.
- 2 Use the PREVIOUS or NEXT buttons to jump to the previous/next page of six steps (←←←← or →→→→ on the front panel cannot be used to perform this operation).
- 3 Press PROGRAM to exit the program screen.

## To change the contents of a program

- 1 Press PROGRAM.
- 2 Jump to the page of steps with the contents you want to change using the PREVIOUS or NEXT buttons (←←←← or →→→→ on the front panel cannot be used to perform this operation).
- 3 Use the cursor buttons (▲/▼) to select the step you want to change.
- 4 Move the cursor to the appropriate field using the cursor buttons (←/→).
- 5 Press the number button(s) of the number you want to change.
- 6 Press PROGRAM to exit the program screen.

## To add to a program

Add a new Disc, Title/Track or Chapter at the end of the program by following the steps in the section 'Programming' on the previous page.

## To repeat the contents of a program

During program playback, press REPEAT. The entire program will be repeated.

## To delete a step in a program

- 1 Press PROGRAM.
- 2 Jump to the page with the contents you want to delete using the PREVIOUS or NEXT buttons (←←←← or →→→→ on the front panel cannot be used to perform this operation).
- 3 Use the cursor buttons (▲/▼) to select the step you want to delete.
- 4 Press CLEAR.
- 5 Press PROGRAM to exit the program screen.

## To clear the entire program

Pressing CLEAR when the disc is stopped will clear all program data.

## To stop program play

Press STOP ■.

### Notes

- If a chapter is programmed for a disc that has not yet been read by the player ("???" is displayed), and a CD or Video CD is later detected in the tray, the chapter program information is cleared. Additionally, if there is no disc in the tray, or if the programmed chapter number is larger than the number of chapters in the selected title, the chapter program information is erased.
- During DVD playback, when a chapter that cannot be played as part of program playback is encountered, Ⓜ or Ⓜ is displayed, and the program automatically proceeds to the next chapter.
- DVDs follow commands from the disc's memory to playback. Therefore, in certain command areas, there are cases where program play cancels or may not function.
- Programming is not possible during PBC playback of Video CDs. To program Video CDs, stop playback before attempting to make a program.
- During programmed playback, if the disc changer is rotated to play a DVD, an asterisk may be displayed in the upper right corner of the screen. This is to indicate that there is information on the disc that must be played first (First Play PGC). Depending on the disc, the asterisk may blink continuously during playback of chapters that were not programmed and then disappear shortly before playback of the desired location on the disc.

## Continuing Playback from a Specified Location (Last Memory) – DVD/Video CD

The Last Memory function is convenient when you want to continue viewing a disc from the point where you were watching before. Unlike the resume function, the Last Memory function is effective even if the DVD is removed from the player. Last Memory locations can be stored for up to 5 DVDs and 1 Video CD.

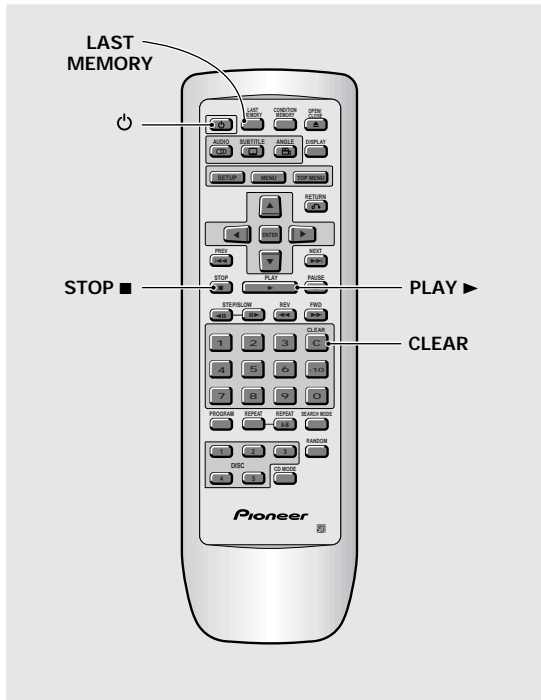

## Memorizing a Last Memory location to return to later

### 1 Press **LAST MEMORY** during play.

The “**LAST MEMORY**” indicator lights on the player.

### 2 Press **⏻** to turn the power to standby, or stop playback with **STOP** ■.

Once memorized, the memorized point on a DVD will be recalled even if the power is turned off, or if the disc is ejected. Points on up to five DVDs can be memorized, and those points are recalled the next time they are played back.

- With Video CDs, the location in playback where **LAST MEMORY** was pressed is cleared when the disc is changed or ejected.

## Resuming playback from where **LAST MEMORY** was pressed

### 1 Load a disc that has a Last Memory point memorized.

Some DVDs will start playback automatically when loaded. In this case, press **STOP** ■ to stop playback.

- When a Last Memory location is registered for a Video CD, the location is cleared when the disc is changed or ejected.

### 2 Press **LAST MEMORY** while in the stop mode.

The disc begins playback at the memorized point.

- Last Memory mode may not function for some DVDs.
- If you register more than five DVDs, details of the latest disc are memorized, while details of the least recent disc (the disc you registered first) is erased.
- Even with a disc you have memorized with Last Memory, playback begins at the start of the disc if you press **PLAY** ► (unless **RESUME** is showing in the display).
- This function is for playback of DVDs or Video CDs only. You cannot use it with CDs.

### To clear the Last Memory location

Call up the Last Memory location by pressing **LAST MEMORY**. Then press **CLEAR** while “**Last Memory**” is still being displayed on the screen.

The “**LAST MEMORY**” indicator disappears from the display.



## Memorizing Settings for Often Viewed DVDs (Condition Memory) – DVD

You can store in memory settings for DVDs you often watch. Settings remain in memory even if you remove the disc from the player, or switch power to the player to standby. If you load a disc that has its settings memorized, **“CONDITION”** appears in the display. When you start playing the disc, the memorized settings are automatically recalled.

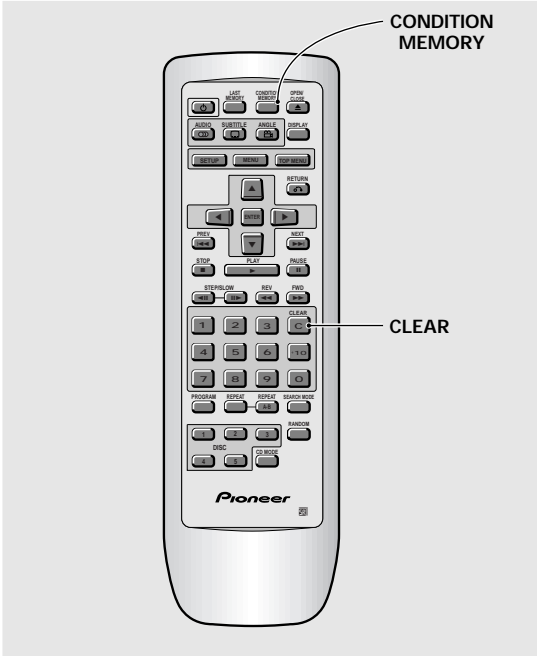

### When a disc that has memorized settings is loaded

**“Condition Memory”** will appear on the screen, and the previously memorized settings will be selected.

### Erasing the recorded contents

Press **CONDITION MEMORY**, then **CLEAR** while **“Condition Memory”** is still being displayed on the screen. The **“CONDITION”** indicator disappears from the display window.

#### Notes

- Settings are stored in memory for use any time.
- You can store settings for up to 15 DVDs in memory. If you memorize settings for more than 15 DVDs, previously memorized settings are erased in chronological order from the least recently memorized. Subsequently, if you load a disc with erased settings, the settings of the most recently played disc are used.
- If you make changes to any of the settings memorized in Condition Memory, press **CONDITION MEMORY** during playback to memorize new settings.
- Switching of the multi-language mode etc., is automatic on some discs.

### Press **CONDITION MEMORY** during playback.

Settings are memorized for the disc currently playing.

#### The following five settings are memorized:

- On Screen Display (page 31)
- Multi-Angle (page 32)
- Multi-language (page 33)
- Multi-Language Subtitles (page 35)
- Parental Lock Level (page 38)

# Viewing Disc Information

– DVD/Video CD/CD

Use **DISPLAY** to get current information about the disc currently loaded. You can get information about the titles and chapters on a DVD or tracks on a Video CD or CD. When viewing DVDs, you can also check the digital bitstream transmission rate.

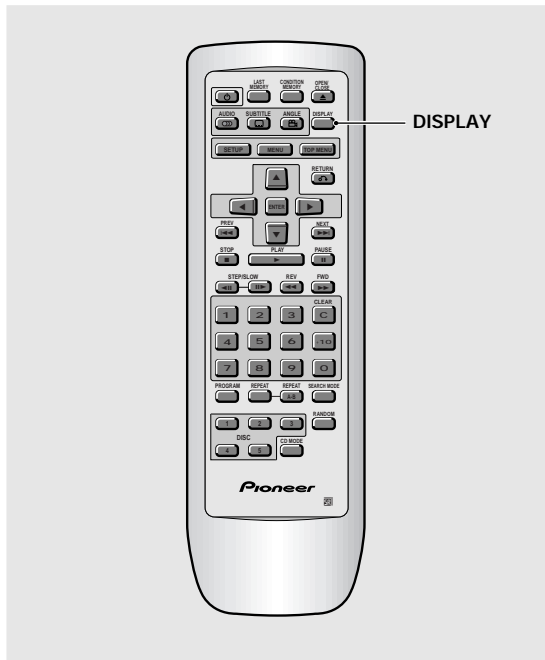

Press **DISPLAY** during while a disc is playing. Press **DISPLAY** repeatedly to change the information being displayed.

The disc information is displayed superimposed over the video image on the screen.

Press and hold **DISPLAY** to display the time remaining on the disc.

When you release the button, the information disappears.

### Notes

- Depending on the format and type of disc being used, not all screens may be displayed.
- When the Angle indicator is being displayed on-screen during playback of DVDs that contain multi-angle information, the disc number is hidden by the angle mark.

The display changes for each type of disc as follows each time the button is pressed.

### DVD



#### TITLE information:

**Top Row:** disc number, title and chapter number, elapsed time of current title

**Bottom Row:** remaining time in current title, total time of current title



#### CHAPTER information:

**Top Row:** disc number, title and chapter number, elapsed time of current title

**Bottom Row:** time in current chapter, total time of current chapter



#### CHAPTER information:

**Top Row:** disc number, title and chapter number, elapsed time of current title

**Bottom Row:** remaining time in current chapter, total time of current chapter



#### Data transmission rate information:

**Top Row:** disc number, title and chapter number, elapsed time of current title

**Bottom Row:** bitstream transmission rate level



Display off

## CD



### Track Information:

**Top Row:** disc number, track number, track time

**Bottom Row:** remaining time of current track, and total time of current track



### Disc information:

**Top Row:** disc number, track number, total number of tracks on CD, track time

**Bottom Row:** remaining time of CD, total time of CD



Display off

## Video CD (with PBC disabled)

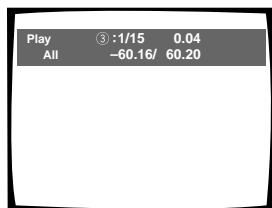

### Disc information:

**Top Row:** disc number, track number, total number of tracks, total elapsed time of Video CD

**Bottom Row:** remaining time of Video CD, total time of Video CD

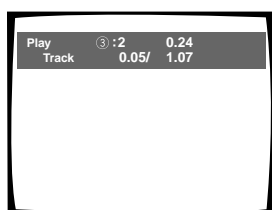

### Track information:

**Top Row:** disc number, track number, total elapsed time of Video CD

**Bottom Row:** track time, total time of current track

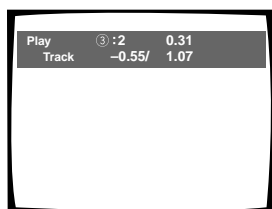

### Track information:

**Top Row:** disc number, track number, total elapsed time of Video CD

**Bottom Row:** remaining time of current track, total time of current track



Display off

### Note

When playing Video CDs in PBC mode or unfinalized CD-Rs not all the above information is displayed.

Press **DISPLAY** during while a disc is stopped to display DVD title and chapter information or Video CD and CD track information. Press **DISPLAY** again to turn the display off.

Information about the titles and chapters or tracks on a disc is displayed. When the information exceeds the space on the screen, use the **cursor buttons** (◀▶) to move to other screens.

## DVD

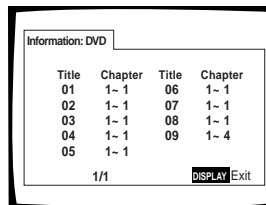

### DVD information

When a DVD is loaded, each title and the number of chapters within each title is displayed.

## CD and Video CD

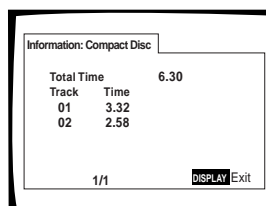

### CD and Video CD information

When a CD or Video CD is loaded, the total time of the disc and the time of each track on the disc is displayed.

## Resetting the Player to System Settings

To reset the player, press and hold **■ (stop)** on the front panel when pressing **⏻ STANDBY/ON** to turn the unit from standby to on .

All program memory, saved settings from functions such as Last Memory and Condition Memory are cleared, and all Setup screen menus are returned to factory settings.

# Additional Information

## Disc Care

### How to hold discs

When loading or removing discs, try not to touch their playing surfaces.



### Cleaning

Fingerprints or other dirt on the disc may affect sound and picture quality.

To clean your discs, use a soft clean cloth to wipe them. If necessary, moisten a soft cloth with diluted neutral detergent to remove heavy dirt or fingerprints.



**Do not wipe in a circular direction (Concentric scratches in the disc groove tend to cause noise.)**



**Gently wipe from the inside toward the outer edge.**

Discs must not be cleaned with record cleaning sprays, or static prevention sprays, etc. Also do not use volatile liquids such as benzine, or thinner, etc.

### Never play cracked or warped discs

The disc revolves in the player at high speed when it is played. Never play a cracked, scratched or warped disc. This may damage the player or cause it to malfunction.

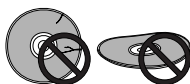

### Never use discs with special shapes

CD's with special shapes (heart-shaped CDs, octagonal CDs, etc.) cannot be played on this set.

Attempting to do so may damage the set. Do not use such CDs.

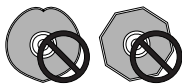

### After using discs, store them upright

After playing a disc, always remove it from the player and return it to its jacket. Then store it standing upright away from heat and humidity.

- Store discs carefully. If you store discs at an angle, or stacked on top of each other, discs may become warped even when in their jackets.
- Do not leave discs in locations such as the seat of a car, which may become excessively hot.

#### CAUTION: WHEN USING THE DISC

All rights reserved.

Unauthorized public performance, broadcasting or copying is a violation of applicable laws.

# For Proper and Long Use of This Unit

## Do not move the unit during playback

During playback, the disc rotates at high speed. Do NOT lift or move the unit during playback. Doing so may damage the disc.

## When moving the unit

When changing places of installation or packing the unit for moving, be sure to remove all discs and return the disc table to its original position in the player. Then, press  $\odot$  **STANDBY/ON** and switch the power to standby. **Check that the "--OFF--" indication on the display goes off**, then disconnect the power cord. Moving this unit with the disc loaded may result in damage to this unit.

## Installation

- Select a stable place to the side of a TV set or stereo system to be connected to the unit.
- When using the unit with a stereo system, install the speakers a little bit away from the TV.
- Do NOT install the unit on top of a TV or color monitor. Install the unit away from equipment that may be affected by magnetism, such as a cassette deck.
- Do NOT place objects on top of the unit.

## Avoid installing in a place that is:

- Exposed to direct sunlight
- Exposed to humidity or where ventilation is poor
- Extremely hot or cold
- Exposed to vibration
- Exposed to dust
- Exposed to oily smoke, steam or heat (for example, a kitchen)

## Do not block vents

Do NOT use the player on top of a long-fibered carpet, bed or sofa, and do not cover it with a cloth, etc. This will prevent heat radiation and could result in damage.

## Avoid heat

Do NOT place the unit on equipment which generates heat, such as an amplifier. When installing the unit in a rack, place it on the lowest shelf possible (however, not where it is exposed to dust) and separated from the amplifier to avoid the heat generated by the amplifier or other audio equipment.

### CAUTION: WHEN PLACING THE UNIT IN A STEREO RACK WITH GLASS DOORS

Be sure there is ample space between the unit and the glass doors when opening the disc table using the remote control. If the disc table opens against strong resistance, such as a closed glass door, damage to the unit may result.

## Condensation

Moisture may form in the operating section of the player if the player is brought from cool surroundings into a warm room or if the temperature of the room rises suddenly. When this happens, the player's performance will be impaired.

To prevent this, let the player stand in its new surroundings for about an hour before switching it on, or make sure that the room temperature rises gradually. Condensation may also form during the summer if the player is exposed to the breeze from an air conditioner. In such cases, change the location of the player.



## Switch POWER to STANDBY when not using the unit

Depending on the strength of the TV or radio broadcast signal, having the TV or radio on while power to the unit is on may result in stripes on the TV screen or noise. However, this is not a malfunction of this unit or the TV or radio. In such a case, switch the power of the unit to standby.

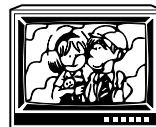

## Power-cord caution

Handle the power cord by the plug. Do not pull out the plug by tugging the cord and never touch the power cord when your hands are wet as this could cause a short circuit or electric shock. Do not place the unit, a piece of furniture, etc., on the power cord, or pinch the cord. Never make a knot in the cord or tie it with other cords. The power cords should be routed in such a way that they are not likely to be stepped on. A damaged power cord can cause a fire or give you an electrical shock. Check the power cord once in a while. When you find it damaged, ask your nearest PIONEER authorized service center or your dealer for a replacement.

## Cleaning the player

To clean the PLAYER, wipe with a soft, dry cloth. For stubborn dirt, wet a soft cloth with a mild detergent solution made by diluting one part detergent to 5 or 6 parts water, wring well, then wipe off the dirt. Also use a dry cloth to wipe the surface dry. Do not use volatile liquids such as benzene and thinner which are harmful to the unit.

## Lens cleaner

The player's pickup lens should not become dirty in normal use, but if for some reason it should malfunction due to soiling, contact your nearest PIONEER authorized service center. Lens cleaners are commercially available, but special care should be exercised in their use since some may cause damage to the lens.

## Notes on using optical cables

- Do not route cords around sharp angles. When storing, wind the cords so that they have a diameter of at least 15 cm (6 in.).
- When connecting, push all the way into the terminal.
- Do not use cords with a length of over 3 m (10 ft.).
- If moisture or dust has collected on the plug, wipe it with a soft cloth before connecting.

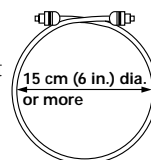

## Language Code List

Language codes are used when setting the audio and subtitle language preferences (**page 36**).

Language	Input-code
Japanese (ja)	1001
English (en)	0514
French (fr)	0618
German (de)	0405
Italian (it)	0920
Spanish (es)	0519
Chinese (zh)	2608
Dutch (nl)	1412
Portuguese (pt)	1620
Swedish (sv)	1922
Russian (ru)	1821
Korean (ko)	1115
Greek (el)	0512
Afar (aa)	0101
Abkhazian (ab)	0102
Afrikaans (af)	0106
Amharic (am)	0113
Arabic (ar)	0118
Assamese (as)	0119
Aymara (ay)	0125
Azerbaijani (az)	0126
Bashkir (ba)	0201
Byelorussian (be)	0205
Bulgarian (bg)	0207
Bihari (bh)	0208
Bislama (bi)	0209
Bengali (bn)	0214
Tibetan (bo)	0215
Breton (br)	0218
Catalan (ca)	0301
Corsican (co)	0315
Czech (cs)	0319
Welsh (cy)	0325
Danish (da)	0401
Bhutani (dz)	0426
Esperanto (eo)	0515
Estonian (et)	0520
Basque (eu)	0521
Persian (fa)	0601
Finnish (fi)	0609
Fiji (fj)	0610
Faroese (fo)	0615
Frisian (fy)	0625
Irish (ga)	0701
Scots-Gaelic (gd)	0704
Galician (gl)	0712
Guarani (gn)	0714

Language	Input-code
Gujarati (gu)	0721
Hausa (ha)	0801
Hindi (hi)	0809
Croatian (hr)	0818
Hungarian (hu)	0821
Armenian (hy)	0825
Interlingua (ia)	0901
Interlingue (ie)	0905
Inupiak (ik)	0911
Indonesian (in)	0914
Icelandic (is)	0919
Hebrew (iw)	0923
Yiddish (ji)	1009
Javanese (jw)	1023
Georgian (ka)	1101
Kazakh (kk)	1111
Greenlandic (kl)	1112
Cambodian (km)	1113
Kannada (kn)	1114
Kashmiri (ks)	1119
Kurdish (ku)	1121
Kirghiz (ky)	1125
Latin (la)	1201
Lingala (ln)	1214
Laothian (lo)	1215
Lithuanian (lt)	1220
Latvian (lv)	1222
Malagasy (mg)	1307
Maori (mi)	1309
Macedonian (mk)	1311
Malayalam (ml)	1312
Mongolian (mn)	1314
Moldavian (mo)	1315
Marathi (mr)	1318
Malay (ms)	1319
Maltese (mt)	1320
Burmese (my)	1325
Nauru (na)	1401
Nepali (ne)	1405
Norwegian (no)	1415
Occitan (oc)	1503
Oromo (om)	1513
Oriya (or)	1518
Panjabi (pa)	1601
Polish (pl)	1612
Pashto, Pushto (ps)	1619
Quechua (qu)	1721

Language	Input-code
Rhaeto-Romance (rm)	1813
Kirundi (rn)	1814
Romanian (ro)	1815
Kinyarwanda (rw)	1823
Sanskrit (sa)	1901
Sindhi (sd)	1904
Sangho (sg)	1907
Serbo-Croatian (sh)	1908
Sinhalese (si)	1909
Slovak (sk)	1911
Slovenian (sl)	1912
Samoan (sm)	1913
Shona (sn)	1914
Somali (so)	1915
Albanian (sq)	1917
Serbian (sr)	1918
Siswati (ss)	1919
Sesotho (st)	1920
Sundanese (su)	1921
Swahili (sw)	1923
Tamil (ta)	2001
Telugu (te)	2005
Tajik (tg)	2007
Thai (th)	2008
Tigrinya (ti)	2009
Turkmen (tk)	2011
Tagalog (tl)	2012
Setswana (tn)	2014
Tonga (to)	2015
Turkish (tr)	2018
Tsonga (ts)	2019
Tatar (tt)	2020
Twi (tw)	2023
Ukrainian (uk)	2111
Urdu (ur)	2118
Uzbek (uz)	2126
Vietnamese (vi)	2209
Volapük (vo)	2215
Wolof (wo)	2315
Xhosa (xh)	2408
Yoruba (yo)	2515
Zulu (zu)	2621

## Troubleshooting

Incorrect operations are often mistaken for trouble and malfunctions. If you think that there is something wrong with this component, check the points below. Sometimes the trouble may lie in another component. Inspect the other components and electrical appliances being used. If the trouble cannot be rectified even after exercising the checks listed below, ask your nearest PIONEER authorized service center or your dealer to carry out repair work.

---

### The disc table comes back out automatically, shortly after the disc table is closed.

The disc is dirty or warped.

- ➔ Refer to 'Disc Care' (page 52).

The disc is not placed properly on the disc table.

- ➔ Use the disc table guide to align the disc (page 21).

Region number does not conform with this unit.

- ➔ If the region number on the disc does not match the number on the player, the disc cannot be used (page 58).

There is condensation on the operating section of the player.

- ➔ Allow time for condensation to evaporate. If player is near an air conditioning unit, you should move the player (page 53).

---

### Playback is not possible.

The disc has been loaded upside down.

- ➔ Check that the disc has been loaded with the label side facing up.

The disc is not aligned in the disc tray properly.

- ➔ Open the disc tray and make sure that the disc is aligned correctly.

---

### mark appears on screen.

The selected function does not operate for that disc.

---

### mark appears on screen.

The operation is prohibited by the player.

---

### Picture playback stops and the operation buttons cannot be used.

Player malfunctions.

- ➔ Stop disc playback (press **STOP** ■), then start playback again.

---

### New settings made in the Setup screen menus while a disc is playing are ineffective.

Some settings can be changed while a disc is playing, but are not effective. This is not a malfunction.

- ➔ Make the same setting when the player is stopped.
- ➔ Stop disc playback (press **STOP** ■), then start playback again. When playback is resumed, the new settings should be in effect. Please note that making settings in the Setup screen menus may cancel the resume function.

---

### When making changes in the Setup screen menus, is displayed.

There is a Video CD or CD loaded in the player and the setting that was changed only applies to DVD performance.

- ➔ The setting will be effective the next time a DVD is loaded.

---

### Settings are canceled.

When the power is turned off by power failure or by unplugging the power cord, settings will be canceled.

- ➔ Before unplugging the power cord, press  **STANDBY/ON** and check that "--OFF--" disappears in the display.

---

### No picture.

The rear panel's **VIDEO OUT SELECT** switch setting is not correct.

- ➔ Check that the **VIDEO OUT SELECT** switch is set to the correct position for the monitor connection you are using (page 16).

Connection is incorrect.

- ➔ Check that cord connections are correct and that plugs are firmly connected.

- ➔ Check that the **TV SYSTEM** switch is set to the correct setting (except for U.S. and Canadian model).

Operation (settings) of TV or AV amplifier is not appropriate.

- ➔ Be sure that your TV, receiver, or amplifier is set up to view DVD playback.

---

### The screen is stretched or aspect does not change.

The multi aspect setting is not appropriate.

- ➔ Change the aspect setting in the **[TV Screen]** setting in the Setup screen **Video** menu to the screen type most appropriate to the TV or monitor you are using (page 30).

If you connected your TV with an S-Video cord, in rare cases the TV picture may appear stretched.

- ➔ Change the **[S-Video Out]** setting to **[S1]** (page 31).

---

### Picture disturbance during playback or dark.

This is not a malfunction.

- ➔ This player is compatible with Macro-Vision System copy guard. Some discs include a copy prevention signal, and when this type of disc is played back, stripes etc., may appear on some sections of the picture depending on the TV.

The position of the **TV SYSTEM** switch was changed during player operations (except for U.S. and Canadian mode).

- ➔ Switching the position of the **TV SYSTEM** switch is not effective if a disc is playing. Stop playback before performing this operation.

---

### No sound from the DIGITAL OUT (optical or coaxial) jacks.

The **[Digital Out]** menu is set to **[Off]**.

- ➔ Set the **[Digital Out]** (**Audio 1** menu) to **[On]** (page 29).

---

### Can't play DVD or Video CD discs loaded

The player is in CD Mode.

- ➔ Press CD mode and make sure that the **CD MODE** button is not lit (page 41).

---

**When recorded on a VCR or passed through an AV selector, there is disturbance in the playback picture.**

This is not a malfunction.

- ➔ Due to the player's copy protection circuits, connection of this device through a VCR or an AV selector may prevent recording or cause picture problems.

---

**Remote control operation is not possible.**

The rear panel control input jack on the player is being used.

- ➔ Point the remote control at the component that the player is connected to (**page 17**).

The remote control is too far from the player, or the angle with the remote sensor is too wide.

- ➔ Be sure to operate the remote from a location within its operating range (**page 8**).

The batteries are exhausted.

- ➔ Replace the exhausted batteries with all new batteries (**page 8**).

---

**Audio is not output or is distorted.**

The Setup screen **Audio 1** menu **[96 kHz PCM Out]** setting is set to **[96 kHz]**. Digital output is prohibited on some discs.

- ➔ Either connect using the analog outputs, or set **[96kHz PCM Out]** in the **Audio 1** menu to **[96kHz ▶ 48 kHz]** (**page 15**).

The disc is dirty.

- ➔ Refer to '*Disc Care*' (**page 52**).

The connection plugs are not inserted fully into the terminals or are not connected.

- ➔ Check that all connection plugs are firmly inserted.

The connection plug or terminal is dirty.

- ➔ Check that the plugs and terminals are wiped clean of dirt, etc.

Audio cable connection is wrong.

- ➔ Check to make sure that the audio cables are connected correctly (**page 16**).

Connection is made to the stereo amplifier's PHONO input terminal.

- ➔ Change connection to any input terminal except PHONO.

The pause mode is engaged.

- ➔ Press **PLAY ▶** or **PAUSE II** to exit the pause mode.

Stereo amplifier operation is incorrect.

- ➔ Check input (CD, AUX, etc.) selector to determine if it is selected for DVD playback.

The DVD or CD is recorded in DTS audio.

- ➔ DTS audio is only output from the digital output jacks. Connect the digital output on the player to the digital input on a receiver or amplifier with a built in DTS decoder to hear DTS audio.

---

**Noticeable difference in DVD and CD volume.**

DVDs and CDs use different recording methods.

- ➔ This is not a malfunction.

**Caution**

Static electricity or other external influence may cause malfunctioning of this unit. In this case, unplugging the power cord and then re-plugging it in will usually reset the unit for proper operation. If this does not correct the problem, please consult your nearest PIONEER service center.



## Terms

### Aspect ratio

Aspect ratio refers to the length to height ratio of TV screens. The ratio of a standard TV is 4:3, while the ratio of a high-definition or wide TV is 16:9. The latter allows you to enjoy a picture with a wider perspective.

### Chapter number

Chapter numbers are the numbers assigned to sections of a title on the disc, similar to chapters in a book. If the disc includes chapter numbers, you can locate the section you want very quickly using search and other functions.

### Component (color difference) video output

The color signal of the TV is divided into the luminance (Y) signal and the color (P<sub>B</sub> and P<sub>R</sub>) signals and then output. In this way mutual interference of each signal is avoided. On a TV with component input jacks, these signals are synthesized to produce the picture.

### Condition memory

“Condition” refers to the various mode settings, etc. On this player, various conditions, such as those set during playback, can be memorized. This function allows you to play back the same disc at any time without having to redo your preferred settings.

### Digital bitstream

The bitstream does not refer to the audio signal, but rather to the digital data that, once converted, becomes the audio signal. The player outputs digital bitstreams via the digital optical or digital coaxial output. If the bitstream cannot be decoded by the connected AV amplifier etc., digital noise is produced. Digital bitstream formats compatible with different entertainment systems can be selected in the Setup screen **Audio 1** menu.

### Digital output (Coaxial)

Output of the digital audio signal is transmitted electronically using a coaxial cable. Because the signal being transmitted is digital, connection must be made to the coaxial digital input of another component. Noise will be output if connected to the analog audio inputs as the digital signal cannot be decoded.

### Digital output (Optical)

Normally, audio is converted to an electric signal and transmitted through an electric wire from the player to the amplifier, etc. Changing this signal to a digital signal and transmitting it through an fiber-optic cable is called optical digital output. Similarly, optical digital input receives digital signals from external units such as an AV amplifier or receiver.

### Dolby Digital

The maximum 5.1 channels of audio used in the surround system (Surround Digital) for movie theaters is digital data compressed by the third generation algorithm encoder.



In order to enjoy Dolby Digital discs, this unit's digital output jack (either coaxial or optical) must be connected to the digital input jack of an AV amplifier or Dolby Digital decoder to enjoy the sound of Dolby Digital soundtracks.

### DTS

DTS stands for Digital Theater System. DTS is a surround system different from Dolby Digital that has become a popular surround sound format for movies. In order to enjoy the benefits of DTS encoded discs, the digital output jack (either coaxial or optical) of this player needs to be connected to an AV amplifier or receiver or to a DTS decoder to be able to enjoy the surround sound of DTS audio. DTS audio is not output from the analog audio outputs.



### Dynamic range

Dynamic range refers to the difference between the maximum and minimum levels of the audio soundtrack as measured in decibels (dB).

Compressing the dynamic range raises the minimum signal level and lowers the maximum signal level. This allows you to hear voices and other low level audio signals clearly while lowering strong audio signals like the sound of explosions.

### MPEG

Short for Moving Picture Experts Group. This is an international standard for compression of moving images. On some DVDs, digital audio has been compressed and recorded in this format.

### Multi-angle

When you watch a TV program, you are watching the image filmed through the TV camera. Because of this, the picture is displayed on your TV from the viewpoint of the TV camera's position. In a TV studio, the image is filmed by many cameras at the same time, and one of those images is selected by the program director and transmitted to your TV. If all the filmed images were transmitted to your TV you would be able to select the camera image you want. Some DVD discs are recorded with the angles of more than one camera used for filming, and these can be selected using this player. These types of discs are called multi-angle discs.

### Parental lock level

This function was suggested by parents concerned about what type of media their children were able to watch. Parental lock restrictions are restrictions incorporated into titles which include scenes that parents may not wish their children to view.

### PCM

PCM stands for Pulse Code Modulation and is digital audio. The digital audio of CDs is PCM. This player also has a function that converts Dolby Digital and MPEG digital bitstreams into PCM to enable you to listen to quality digital sound even without a special decoder.

### Playback Control (PBC)

This refers to signals recorded on a Video CD (Version 2.0) enabling playback control.

You can use menus recorded on discs with PBC for easy, interactive search for desired scenes, and playback.

You can also enjoy viewing high-resolution/standard resolution still images.

---

### Regional restriction codes (region number)

Regional restriction codes are built in to DVD players and DVD discs for each sales region. If the regional code of the DVD player does not match one of the regional codes of the DVD disc, playback is not possible.

The region number can be found on the rear panel of the DVD player. The illustration below shows the regions and corresponding region numbers.

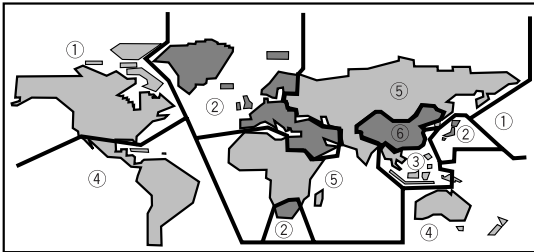

---

### Sampling Frequency

When a sound wave is converted to a digital signal, the sound is sampled and converted to data at a specific frequency rate. For example, a signal with a 96 kHz sampling rate indicates that in one second, the analog signal was sampled 96000 times to produce the digital signal.

---

### Subtitle

Subtitles are language titles superimposed on movies, or other media. Up to 32 different subtitle languages can be recorded on a DVD disc. The subtitle function can be used to select the language of your choice.

---

### S-video

Connecting the S-video output on the player to a TV or monitor with S-video input via an S-video cable produces clearer picture reproduction by sending separate signals for the luminance and the color. These signals are then combined by the television to produce a better quality picture.

---

### System control

When you connect this player via a cord with a mini plug to another Pioneer component such as a receiver or an amplifier bearing the  mark, you can control the player as though it were a component in a system. To control the player, point the player's remote control at the component that the player is connected to, and not the player itself.

---

### Time number

The time number corresponds to the elapsed playback time of a disc from its beginning. When using the time search function, use the time number to locate scenes that occur at the time selected.

---

### Title number

DVD discs are divided into units referred to as titles, and titles are divided into chapters. Menu screens do not belong to any title. A disc which contains a movie may have only one title with many or no chapter divisions. Karaoke discs may have many titles, assigning a title to each song on the disc.

# Specifications

## General

System ... DVD system, Compact Disc digital video system and  
Compact Disc digital audio system

### Power requirements

U.S. and Canadian models ..... AC 120 V, 60 Hz  
Other models ..... AC 110-127/220-240 V, 50/60 Hz

### Power consumption

U.S. and Canadian models ..... 11 W  
Other models ..... 12 W

Power consumption in standby mode ..... less than 1 W

Weight ..... 4.7 kg (10 lb 6 oz)

Dimensions ..... 420 (W) x 375 (D) x 128 (H) mm  
(16 <sup>9</sup>/<sub>16</sub> (W) x 14 <sup>13</sup>/<sub>16</sub> (D) x 5 <sup>1</sup>/<sub>16</sub> (H) in.)  
(Not including protruding cables, etc.)

Operating temperature +5°C to +35°C (+41°F to +96°F)

Operating humidity ..... 5% to 85% (no condensation)

## S-Video output

Y (luminance) - Output level ..... 1 Vp-p (75 Ω)

C (color) - Output level ..... 286 mVp-p (75 Ω)

Jack ..... S-VIDEO jack

## Video output

Output level ..... 1 Vp-p (75 Ω)

Jack ..... RCA jack

## Component video output

(Y, P<sub>B</sub>, P<sub>R</sub>)

Output level ..... Y: 1.0 Vp-p (75 Ω)

P<sub>B</sub>, P<sub>R</sub>: 0.7 Vp-p (75 Ω)

Jacks ..... RCA jacks

## Audio output (2 pairs)

Output level ..... 200 mVrms (1 kHz, -20 dB)

Number of channels ..... 2

Jacks ..... RCA jacks

## Digital audio characteristics

Frequency response ..... 4 Hz to 44 kHz (DVD fs: 96 kHz)

S/N ratio ..... 115 dB

Dynamic range ..... 102 dB

Total harmonic distortion ..... 0.002 %

Wow and flutter ..... Limit of measurement  
(±0.001% W. PEAK) or lower

## Digital output

Optical digital output ..... Optical digital jack

Coaxial digital output ..... RCA jack

## Other terminals

CONTROL IN ..... Minijack (3.5 ø)

## Accessories

Audio cord ..... 1

Video cord ..... 1

Power cord ..... 1

Remote control unit ..... 1

AA (R6P) dry cell batteries ..... 2

Operating instructions ..... 1

### Note

The specifications and design of this product are subject to change without notice, due to improvement.



## Dear Customer:

Selecting fine audio equipment such as the unit you've just purchased is only the start of your musical enjoyment. Now it's time to consider how you can maximize the fun and excitement your equipment offers. This manufacturer and the Electronic Industries Association's Consumer Electronics Group want you to get the most out of your equipment by playing it at a safe level. One that lets the sound come through loud and clear without annoying blaring or distortion-and, most importantly, without affecting your sensitive hearing.

Sound can be deceiving. Over time your hearing "comfort level" adapts to higher volumes of sound. So what sounds "normal" can actually be loud and harmful to your hearing. Guard against this by setting your equipment at a safe level BEFORE your hearing adapts.

### To establish a safe level:

- Start your volume control at a low setting.
- Slowly increase the sound until you can hear it comfortably and clearly, and without distortion.

### Once you have established a comfortable sound level:

- Set the dial and leave it there.

Taking a minute to do this now will help to prevent hearing damage or loss in the future. After all, we want you listening for a lifetime.

## We Want You Listening For A Lifetime

Used wisely, your new sound equipment will provide a lifetime of fun and enjoyment. Since hearing damage from loud noise is often undetectable until it is too late, this manufacturer and the Electronic Industries Association's Consumer Electronics Group recommend you avoid prolonged exposure to excessive noise. This list of sound levels is included for your protection.

### Decibel

Level	Example
30	Quiet library, soft whispers
40	Living room, refrigerator, bedroom away from traffic
50	Light traffic, normal conversation, quiet office
60	Air conditioner at 20 feet, sewing machine
70	Vacuum cleaner, hair dryer, noisy restaurant
80	Average city traffic, garbage disposals, alarm clock at two feet.

### THE FOLLOWING NOISES CAN BE DANGEROUS UNDER CONSTANT EXPOSURE

90	Subway, motorcycle, truck traffic, lawn mower
100	Garbage truck, chain saw, pneumatic drill
120	Rock band concert in front of speakers, thunderclap
140	Gunshot blast, jet plane
180	Rocket launching pad

Information courtesy of the Deafness Research Foundation.



### When moving the unit

Be sure to follow the necessary steps and precautions whenever moving or transporting the player (pages 25, 53).

Published by Pioneer Corporation.  
Copyright © 2000 Pioneer Corporation.  
All rights reserved.

## PIONEER CORPORATION

4-1, Meguro 1-Chome, Meguro-ku, Tokyo 153-8654, Japan

## PIONEER ELECTRONICS [USA] INC.

P.O. BOX 1540, Long Beach, California 90801-1540, U.S.A.

## PIONEER ELECTRONICS OF CANADA, INC.

300 Allstate Parkway, Markham, Ontario L3R 0P2, Canada

## PIONEER EUROPE NV

Haven 1087, Keetberglaan 1, B-9120 Melsele, Belgium TEL: 03/570.05.11

## PIONEER ELECTRONICS AUSTRALIA PTY. LTD.

178-184 Boundary Road, Braeside, Victoria 3195, Australia, TEL: [03] 9586-6300

## PIONEER ELECTRONICS DE MEXICO S.A. DE C.V.

San Lorenzo 1009 3er Piso Desp. 302 Col. Del Valle Mexico D.F. C.P. 03100 TEL: 5-688-52-90