

**Pioneer** *sound.vision.soul*

DVD Player

**DV-595K-s**

**DV-490V-s**

**DV-490V-k**

**DV-393-s**



Operating Instructions

**RW**  
COMPATIBLE

# IMPORTANT



The lightning flash with arrowhead symbol, within an equilateral triangle, is intended to alert the user to the presence of uninsulated "dangerous voltage" within the product's enclosure that may be of sufficient magnitude to constitute a risk of electric shock to persons.



**CAUTION:**  
TO PREVENT THE RISK OF ELECTRIC SHOCK, DO NOT REMOVE COVER (OR BACK). NO USER-SERVICEABLE PARTS INSIDE. REFER SERVICING TO QUALIFIED SERVICE PERSONNEL.



The exclamation point within an equilateral triangle is intended to alert the user to the presence of important operating and maintenance (servicing) instructions in the literature accompanying the appliance.

D3-4-2-1-1\_En-A

## CAUTION

This product is a class 1 laser product, but this product contains a laser diode higher than Class 1. To ensure continued safety, do not remove any covers or attempt to gain access to the inside of the product. Refer all servicing to qualified personnel. The following caution label appears on your unit.



Location: inside of the unit

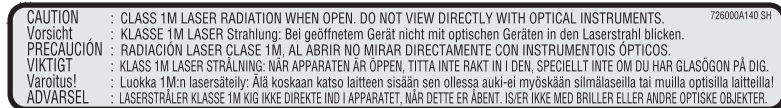

## [Singapore and Taiwanese model only]

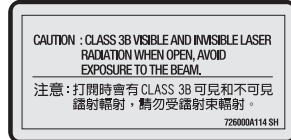

D3-4-2-1-8\_A\_En

## WARNING

Slots and openings in the cabinet are provided for ventilation to ensure reliable operation of the product, and to protect it from overheating. To prevent fire hazard, the openings should never be blocked or covered with items (such as newspapers, table-cloths, curtains) or by operating the equipment on thick carpet or a bed.

D3-4-2-1-7b\_A\_En

## WARNING

Before plugging in for the first time, read the following section carefully.

The voltage of the available power supply differs according to country or region. Be sure that the power supply voltage of the area where this unit will be used meets the required voltage (e.g., 230 V or 120 V) written on the rear panel.

D3-4-2-1-4\_A\_En

## Operating Environment

Operating environment temperature and humidity: +5 °C to +35 °C (+41 °F to +95 °F); less than 85 %RH (cooling vents not blocked)

Do not install this unit in a poorly ventilated area, or in locations exposed to high humidity or direct sunlight (or strong artificial light)

D3-4-2-1-7c\_A\_En

## CAUTION

The  $\odot$  STANDBY/ON switch on this unit will not completely shut off all power from the AC outlet. Since the power cord serves as the main disconnect device for the unit, you will need to unplug it from the AC outlet to shut down all power. Therefore, make sure the unit has been installed so that the power cord can be easily unplugged from the AC outlet in case of an accident. To avoid fire hazard, the power cord should also be unplugged from the AC outlet when left unused for a long period of time (for example, when on vacation).

D3-4-2-2a\_A\_En

If the AC plug of this unit does not match the AC outlet you want to use, the plug must be removed and appropriate one fitted. Replacement and mounting of an AC plug on the power supply cord of this unit should be performed only by qualified service personnel. If connected to an AC outlet, the cut-off plug can cause severe electrical shock. Make sure it is properly disposed of after removal. The equipment should be disconnected by removing the mains plug from the wall socket when left unused for a long period of time (for example, when on vacation).

D3-4-2-2-1a\_A\_En

**[For PX model]**

**NOTE:** This equipment has been tested and found to comply with the limits for a Class B digital device, pursuant to Part 15 of the FCC Rules. These limits are designed to provide reasonable protection against harmful interference in a residential installation. This equipment generates, uses, and can radiate radio frequency energy and, if not installed and used in accordance with the instructions, may cause harmful interference to radio communications. However, there is no guarantee that interference will not occur in a particular installation. If this equipment does cause harmful interference to radio or television reception, which can be determined by turning the equipment off and on, the user is encouraged to try to correct the interference by one or more of the following measures:

- Reorient or relocate the receiving antenna.
- Increase the separation between the equipment and receiver.
- Connect the equipment into an outlet on a circuit different from that to which the receiver is connected.
- Consult the dealer or an experienced radio/TV technician for help.

D8-10-1-2\_En

**CAUTION:** This product satisfies FCC regulations when shielded cables and connectors are used to connect the unit to other equipment. To prevent electromagnetic interference with electric appliances such as radios and televisions, use shielded cables and connectors for connections.

D8-10-3a\_En

**Information to User**

Alteration or modifications carried out without appropriate authorization may invalidate the user's right to operate the equipment.

D8-10-2\_En

**CAUTION :** USE OF CONTROLS OR ADJUSTMENTS OR PERFORMANCE OF PROCEDURES OTHER THAN THOSE SPECIFIED HEREIN MAY RESULT IN HAZARDOUS RADIATION EXPOSURE.

**CAUTION :** THE USE OF OPTICAL INSTRUMENTS WITH THIS PRODUCT WILL INCREASE EYE HAZARD.

D6-8-2-1\_En

**POWER-CORD CAUTION**

Handle the power cord by the plug. Do not pull out the plug by tugging the cord and never touch the power cord when your hands are wet as this could cause a short circuit or electric shock. Do not place the unit, a piece of furniture, etc., on the power cord, or pinch the cord. Never make a knot in the cord or tie it with other cords. The power cords should be routed such that they are not likely to be stepped on. A damaged power cord can cause a fire or give you an electrical shock. Check the power cord once in a while. When you find it damaged, ask your nearest PIONEER authorized service center or your dealer for a replacement.

5002\_En

**WARNING**

**This equipment is not waterproof. To prevent a fire or shock hazard, do not place any container filled with liquid near this equipment (such as a vase or flower pot) or expose it to dripping, splashing, rain or moisture.**

D3-4-2-1-3\_A\_En

**When disposing of used batteries, please comply with governmental regulations or environmental public instruction's rules that apply in your country/area.**

D3-4-2-3-1\_En

This product is for general household purposes. Any failure due to use for other than household purposes (such as long-term use for business purposes in a restaurant or use in a car or ship) and which requires repair will be charged for even during the warranty period.

K041\_En

**WARNING**

**To prevent a fire hazard, do not place any naked flame sources (such as a lighted candle) on the equipment.**

D3-4-2-1-7a\_A\_En

This product incorporates copyright protection technology that is protected by method claims of certain U.S. patents and other intellectual property rights owned by Macrovision Corporation and other rights owners. Use of this copyright protection technology must be authorized by Macrovision Corporation, and is intended for home and other limited viewing uses only unless otherwise authorized by Macrovision Corporation. Reverse engineering or disassembly is prohibited.

This product includes FontAvenue® fonts licensed by NEC corporation. FontAvenue is a registered trademark of NEC Corporation.

For U.S. and Australia Model



**For Taiwan exclusively**

Taiwanese two pin flat-bladed plug

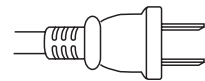

C67-7-3\_En

# Thank you for buying this Pioneer product.

Please read through these operating instructions so that you will know how to operate your model properly. After you have finished reading the instructions, put them in a safe place for future reference.

## Contents

### 01 Before you start

Features .....	5
What's in the box .....	6
Hints on installation .....	6
Disc / content format playback compatibility .....	7

### 02 Connecting up

Easy connections .....	10
Connecting using the S-video output .....	11
Connecting using the component video output .....	11
Connecting to an AV receiver .....	12
Connecting using HDMI (DV-490V only) ..	14
About HDMI .....	14

### 03 Controls and displays

Front panel .....	16
Remote control .....	18

### 04 Getting started

Switching on .....	19
Using the on-screen displays .....	20
Setting up the player for your TV .....	20
Setting the language of this player's on-screen displays .....	21
Playing discs .....	21
Singing Your Favorite Songs Along with Karaoke Discs .....	24

### 05 Playing discs

Scanning discs .....	27
Playing in slow motion .....	27
Frame advance/frame reverse .....	28
Viewing a JPEG slideshow .....	28
Browsing DVD or Video CD/Super VCD disc with the Disc Navigator .....	28
Browsing WMA, MP3, DivX video and JPEG files with the Disc Navigator .....	29

Looping a section of a disc .....	30
Using repeat play .....	30
Using random play .....	31
Creating a program list .....	32
Searching a disc .....	33
Switching subtitles .....	34
Switching audio language/channels .....	34
Zooming the screen .....	34
Switching camera angles .....	34
Displaying disc information .....	35

### 06 Audio Settings and Video Adjust menus

Audio Settings menu .....	36
Video Adjust menu .....	37

### 07 Initial Settings menu

Using the Initial Settings menu .....	38
Digital Audio Out settings .....	38
Video Output settings .....	39
Language settings .....	40
Display settings .....	41
Options settings .....	41
Parental Lock .....	42

### 08 Additional information

Taking care of your player and discs .....	44
Screen sizes and disc formats .....	45
Setting the TV system .....	46
Resetting the player .....	46
DVD-Video regions .....	46
Selecting languages using the language code list .....	47
Glossary .....	48
Language code list .....	50
Country/Area code list .....	50
Specifications .....	51

## Chapter 1

# Before you start

### Features

- **24-bit/96 kHz compatible DAC**

The integrated 24-bit/96 kHz DAC means that this player is compatible with high sampling-rate discs, capable of delivering exceptional sound quality in terms of dynamic range, low-level resolution and high-frequency detail.

- **Excellent audio performance surround sound entertainment with Dolby Digital\*<sup>1</sup> and DTS\*<sup>2</sup> software**

Logos:



When connected to a suitable AV amplifier or receiver, this player gives great surround sound with Dolby Digital and DTS discs.

- **PureCinema Progressive Scan video**

When connected to a progressive scan-compatible TV or monitor using the component video outputs, you can enjoy extremely stable, flicker free images, with the same frame refresh rate as the original movie.

- **New Disc Navigator with moving pictures**

The new Disc Navigator enables you play the first few seconds of each title or chapter in a thumbnail image on screen.

- **HDMI\*<sup>3</sup> digital interface (DV-490V only)**

The HDMI (High Definition Multimedia Interface) interconnect provides high quality digital audio and video, all from a single user-friendly connector. HDMI is the first consumer electronics interface to support uncompressed standard, enhanced, or high-definition video plus standard to multi-channel surround

sound audio\*<sup>4</sup>, all using one interface. You can easily connect to a HDMI-equipped AV receiver or audiovisual device for high quality audio and video, and communication between the video source and (DTV) players, set-top boxes, and other audiovisual devices is also supported.

- **DSP effects for enhanced playback**

See *Audio Settings and Video Adjust menus* on page 36.

- **Picture zoom**

See *Zooming the screen* on page 34.

- **MP3 and WMA compatibility**

See *Compressed audio compatibility* on page 8.

- **JPEG compatibility**

See *JPEG file compatibility* on page 9.

- **DivX\*<sup>5</sup> video compatibility**

See *DivX video compatibility* on page 9.

Logos:



- **Energy saving design**

An auto power-off function switches the player into standby if not used for about 30 minutes.

\*<sup>1</sup> Manufactured under license from Dolby Laboratories. "Dolby" and the double-D symbol are trademarks of Dolby Laboratories.

\*<sup>2</sup> "DTS" and "DTS Digital Out" are registered trademarks of Digital Theater Systems, Inc.

\*<sup>3</sup> HDMI, the HDMI logo and High-Definition Multimedia Interface are trademarks or registered trademarks of HDMI licensing LLC.

\*4 It is not possible to output SACD or DVD-Audio sources from the HDMI connection of this player.

\*5 DivX, DivX Certified, and associated logos are trademarks of DivX, Inc. and are used under license.

## What's in the box

Please confirm that the following accessories are in the box when you open it.

- Remote control
- AA/R6P dry cell batteries x 2
- Audio/video cable (red/white/yellow plugs)
- Power cable (Central American, South American and Taiwan model x2)
- Operating instructions x2 (Australian, Thailand and PX model x1)
- Front panel button names sticker (*Taiwan models only*) — Chinese language button names for the front panel controls.
- Remote control overlay (*Taiwan models only*) — Place the overlay on the remote control to be able to read the buttons in Chinese.

## Putting the batteries in the remote

- **Open the battery compartment cover and insert the batteries as shown.**

Use two AA/R6P batteries and follow the indications (⊕, ⊖) inside the compartment. Close the cover when you're finished.

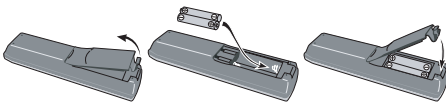

## Important

Incorrect use of batteries can result in hazards such as leakage and bursting. Please observe the following:

- Don't mix new and old batteries together.
- Don't use different kinds of battery together—although they may look similar, different batteries may have different voltages.
- Make sure that the plus and minus ends of each battery match the indications in the battery compartment.
- Remove batteries from equipment that isn't going to be used for a month or more.
- When disposing of used batteries, please comply with governmental regulations or environmental public instruction's rules that apply in your country or area.
- Do not use or store batteries in direct sunlight or other excessively hot place, such as inside a car or near a heater. This can cause batteries to leak, overheat, explode or catch fire. It can also reduce the life or performance of batteries.

## Hints on installation

We want you to enjoy using this product for years to come, so please use the following guidelines when choosing a suitable location:

### Do...

- Use in a well-ventilated room.
- Place on a solid, flat, level surface, such as a table, shelf or stereo rack.

### Don't...

- Use in a place exposed to high temperatures or humidity, including near radiators and other heat-generating appliances.

- Place on a window sill or a place where the player will be exposed to direct sunlight.
- Use in an excessively dusty or damp environment.
- Place directly on top of an amplifier, or other component in your stereo system that becomes hot in use.
- Use near a television or monitor as you may experience interference—especially if the television uses an indoor antenna.
- Use in a kitchen or other room where the player may be exposed to smoke or steam.
- Use on a thick rug or carpet, or cover with cloth—this may prevent proper cooling of the unit.
- Place on an unstable surface, or one that is not large enough to support all four of the unit's feet.



- This unit will play DVD+R/+RW discs.
- **DVD** is a trademark of DVD Format/Logo Licensing Corporation.
-  is a trademark of Fuji Photo Film Co. Ltd.
- Also compatible with KODAK Picture CD

## Disc / content format playback compatibility

This player is compatible with a wide range of disc types (media) and formats. Playable discs will generally feature one of the following logos on the disc and/or disc packaging. Note however that some disc types, such as recordable CD and DVD, may be in an unplayable format—see below for further compatibility information.

*Please also note that recordable discs cannot be recorded using this player.*

This player supports the IEC's Super VCD standard. Compared to the Video CD standard, Super VCD offers superior picture quality, and allows two stereo soundtracks to be recorded. Super VCD also supports the widescreen size.



### About DualDisc playback

A DualDisc is a new two-sided disc, one side of which contains DVD content video, audio, etc. while the other side contains non-DVD content such as digital audio material.

The non-DVD, audio side of the disc is not compliant with the CD Audio specification and therefore may not play.

The DVD side of a DualDisc plays in this product.

For more detailed information on the DualDisc specification, please refer to the disc manufacturer or disc retailer.

### CD-R/RW compatibility

- Compatible formats: CD-Audio, Video CD/ Super VCD, ISO 9660 CD-ROM\* containing MP3, WMA, JPEG or DivX video files  
\* ISO 9660 Level 1 or 2 compliant. CD physical format: Mode1, Mode2 XA Form1. Romeo and Joliet file systems are both compatible with this player.
- Multi-session playback: No
- Unfinalized disc playback: No
- File structure (may differ): Up to 299 folders on a disc; up to 648 folders and files (combined) within each folder

### DVD+R/DVD+RW compatibility

Only DVD+R/DVD+RW discs recorded in 'Video Mode (DVD Video Mode)' which have been finalized, can be played back. However, some editing made during the recording may not be played back accurately.

### DVD-R/RW compatibility

- Compatible formats: DVD-Video, Video Recording (VR)\*  
\* Edit points may not play exactly as edited; screen may go momentarily blank at edited points.
- Unfinalized playback: No
- WMA/MP3/JPEG file playback on DVD-R/RW: No

### Compressed audio compatibility

- Compatible formats: MPEG-1 Audio Layer 3 (MP3), Windows Media Audio (WMA)
- Sampling rates: 32 kHz, 44.1 kHz or 48 kHz
- Bit-rates: Any (128 Kbps or higher recommended)
- VBR (variable bit rate) MP3 playback: No
- VBR WMA playback: No
- WMA lossless encoding compatible: No

- DRM (Digital Rights Management) compatible: Yes (DRM-protected audio files will *not* play in this player—see also *DRM* in the *Glossary* on page 48)
- File extensions: .mp3, .wma (these must be used for the player to recognize MP3 and WMA files – do not use for other file types)

### About WMA



The Windows Media<sup>®</sup> logo printed on the box indicates that this player can playback Windows Media Audio content.

WMA is an acronym for Windows Media Audio and refers to an audio compression technology developed by Microsoft Corporation. WMA content can be encoded by using Windows Media<sup>®</sup> Player version 7, 7.1, Windows Media<sup>®</sup> Player for Windows<sup>®</sup> XP, or Windows Media<sup>®</sup> Player 9 Series.

*Microsoft, Windows Media, and the Windows logo are trademarks, or registered trademarks of Microsoft Corporation in the United States and/ or other countries.*

### About DivX

DivX is a media technology created by DivX, Inc. DivX media files contain compressed video. DivX files can also include advanced media features like menus, subtitles, and alternate audiotracks. This player can play DivX video files burned on CD-R/RW/ROM discs. Keeping the same terminology as DVD-Video,



individual DivX video files are called "Titles". When naming files/titles on a CD-R/RW disc prior to burning, keep in mind that by default they will be played in alphabetical order.

### Displaying DivX subtitle files

The font sets listed below are available for DivX external subtitle files. You can see the proper font set on-screen by setting the **Subtitle Language** (in *Language settings* on page 40) to match the subtitle file.

This player supports the following language groups:

**Group 1:** Albanian (sq), Basque (eu), Catalan (ca), Danish (da), Dutch (nl), English (en), Faroese (fo), Finnish (fi), French (fr), German (de), Icelandic (is), Irish (ga), Italian (it), Norwegian (no), Portuguese (pt), Rhaeto-Romanic (rm), Scottish (gd), Spanish (es), Swedish (sv)

**Group 2:** Albanian (sq), Croatian (hr), Czech (cs), Hungarian (hu), Polish (pl), Romanian (ro), Slovak (sk), Slovenian (sl)

**Group 3:** Bulgarian (bg), Byelorussian (be), Macedonian (mk), Russian (ru), Serbian (sr), Ukrainian (uk)

**Group 4:** Hebrew (iw), Yiddish (ji)

**Group 5:** Turkish (tr)

- Some external subtitle files may be displayed incorrectly or not at all.
- For external subtitle files the following subtitle format filename extensions are supported (please note that these files are not shown within the disc navigation menu): .srt, .sub, .ssa, .smi
- The filename of the movie file has to be repeated at the beginning of the filename for the external subtitle file.
- The number of external subtitle files which can be switched for the same movie file is limited to a maximum of 10.

### DivX video compatibility



- Official DivX<sup>®</sup> Certified product.
- Plays all versions of DivX<sup>®</sup> video (including DivX<sup>®</sup> 6) with standard playback of DivX<sup>®</sup> media files.
- File extensions: .avi and .divx (these must be used for the player to recognize DivX video files). *Note that all files with the .avi extension are recognized as MPEG4, but not all of these are necessarily DivX video files and therefore may not be playable on this player.*

*DivX, DivX Certified, and associated logos are trademarks of DivX, Inc. and are used under license.*

### JPEG file compatibility

- Compatible formats: Baseline JPEG and EXIF 2.2\* still image files up to a resolution of 3072 x 2048.  
*\*File format used by digital still cameras.*
- Progressive JPEG compatible: No
- File extensions: .jpg (must be used for the player to recognize JPEG files – do not use for other file types)

### PC-created disc compatibility

Discs recorded using a personal computer may not be playable in this unit due to the setting of the application software used to create the disc. In these particular instances, check with the software publisher for more detailed information.

Discs recorded in packet write mode (UDF format) are not compatible with this player.

Check the DVD-R/RW or CD-R/RW software disc boxes for additional compatibility information.

## Chapter 2

# Connecting up

### Easy connections

- Before making or changing any connections, switch off the power and disconnect the power cable from the AC outlet.
- The setup described here is a basic setup that allows you to play discs using just the cables supplied with the player. In this setup, stereo audio is played through the speakers in your TV.
- The following illustrations show the DV-393, but connections for the DV-490V and DV-595K are the same except where indicated.

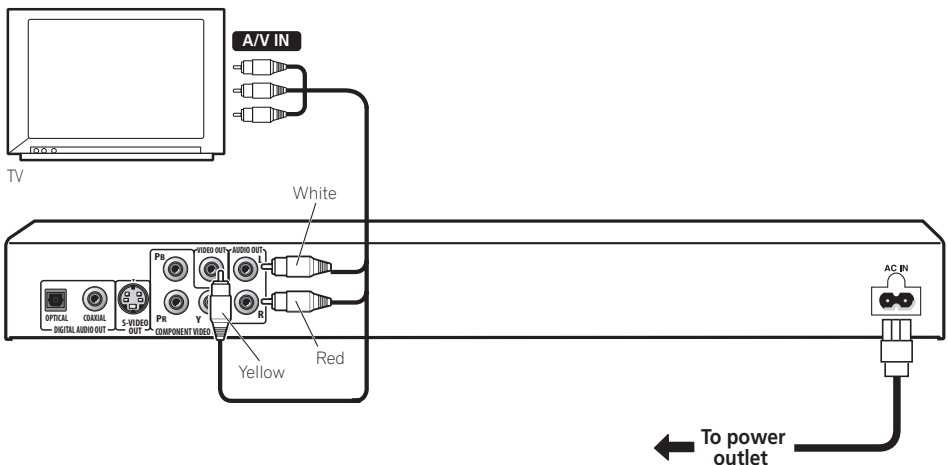

### Important

- This player is equipped with copy protection technology. Do not connect this player to your TV via a VCR using audio/video or S-video cables, as the picture from this player will not appear properly on your TV. (This player may also not be compatible with some combination TV/VCRs for the same reason; refer to the manufacturer for more information.)
- When connecting to your TV as shown above, do not set the **Component Out** setting (See *Video Output settings* on page 39) to **Progressive**.

## 1 Connect the VIDEO OUT and AUDIO OUT L/R jacks to a set of A/V inputs on your TV.

Use the supplied audio/video cable, connecting the red and white plugs to the audio outputs and the yellow plug to the video output. Make sure you match up the left and right audio outputs with their corresponding inputs for correct stereo sound.

See below if you want to use a component or S-video cable for the video connection.

## 2 Connect the supplied AC power cable to the AC IN inlet, then plug into a power outlet.

### Note

- Before unplugging the player from the power outlet, make sure you first switch it into standby using either the front panel **STANDBY/ON** button, or the remote control, and wait of the **-OFF-** message to disappear from the player's display.
- For the above reasons, do not plug this player into a switched power supply found on some amplifiers and AV receivers.

## Connecting using the S-video output

If your TV (or other equipment) has an S-video (S1) input, you can use the S-video output on this player instead of the standard (composite) output for a better quality picture.

- **Use an S-video cable (not supplied) to connect the S-VIDEO OUT to an S-video input on your TV (or monitor or AV receiver).**

Line up the small triangle above the jack with the same mark on the plug before plugging in.

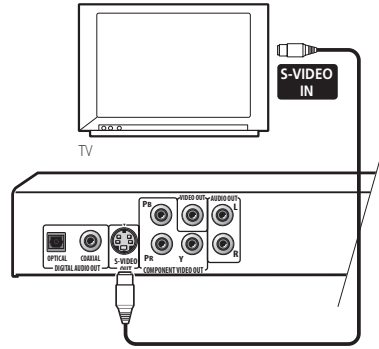

## Connecting using the component video output

You can use the component video output instead of the standard video out jack to connect this player to your TV (or other equipment). This should give you the best quality picture from the three types of video output available.

- **Use a component video cable (not supplied) to connect the COMPONENT VIDEO OUT jacks to a component video input on your TV, monitor or AV receiver.**

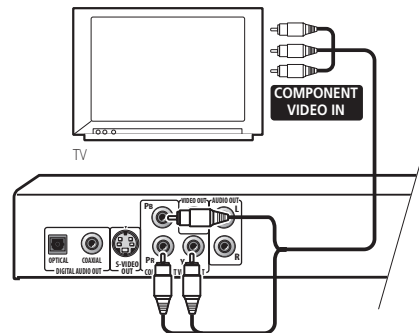

## Watching progressive scan video from the component video outputs

This player can output progressive scan video from the component video output. Compared to interlace video, progressive scan video effectively doubles the scanning rate of the picture, resulting in a very stable, flicker-free image.

To set up the player for use with a progressive scan TV, see *Video Output settings* on page 39. When the player is set to output progressive scan video, the **PRGSVE** indicator lights in the front panel display.



### Important

- When **Component Out** (page 39) is set to **Progressive**, there is no video output from the **VIDEO OUT** (composite) and **S** (S-video) jacks.
- If you want to display video on more than one monitor simultaneously, make sure the player is set to **Interlace**.
- If you connect a TV that is not compatible with a progressive scan signal and switch the player to progressive, you will not be able to see any picture at all. In this case, switch everything off and reconnect using the supplied video cable (see *Easy connections* on page 10), then switch back to **Interlace** (see below).

## Switching the video output to interlace using the front panel controls

Switch the player to standby then, using the front panel controls, press **STANDBY/ON** while pressing **◀◀** to switch the player back to **Interlace**.

- *DV-490V only:* If the player is connected using HDMI, disconnect the HDMI cable before resetting the player to interlace output. (If left connected, the HDMI output

resolution will be reset to its default—see *Resetting the output resolution to the default setting with HDMI connection* on page 15.)

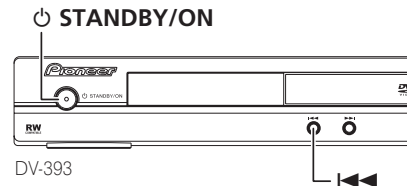
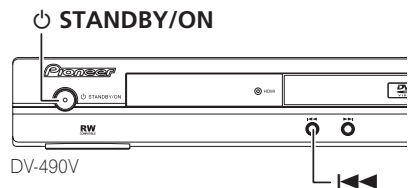
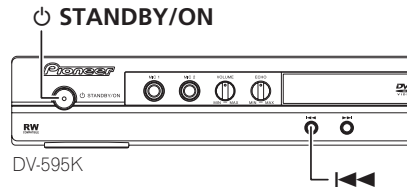

## Connecting to an AV receiver

To enjoy multichannel surround sound you need to connect this player to an AV receiver using the digital audio output. This player has both coaxial and optical digital jacks; use whichever is convenient.

In addition to a digital connection, we recommend also connecting using the stereo analog connection.

You'll probably also want to connect a video output to your AV receiver. You can use any of the video outputs available on this player (the illustration shows a standard (composite) connection).

**1 Connect one of the DIGITAL AUDIO OUT jacks on this player to a digital input on your AV receiver.**

This enables you to listen to multichannel surround sound.

For an optical connection, use an optical cable (not supplied) to connect the **OPTICAL DIGITAL AUDIO OUT** jack to an optical input on your AV receiver.

For a coaxial connection, use a coaxial cable (similar to the supplied video cable) to connect the **COAXIAL DIGITAL AUDIO OUT** jack to a coaxial input on your AV receiver.

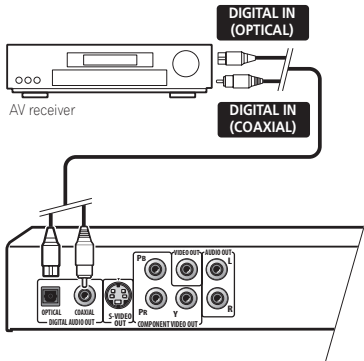

**2 Connect the analog AUDIO OUT L/R and VIDEO OUT jacks on this player to a set of analog audio and video inputs on your AV receiver.**

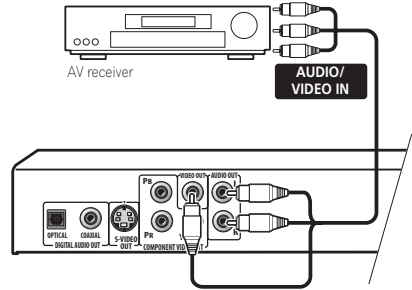

**Tip**

- To use the karaoke function you must have this player connected to your amplifier using the analog outputs.

## Connecting using HDMI (DV-490V only)

If you have a HDMI equipped monitor or display, you can connect it to this player using a commercially available HDMI cable.

The HDMI connector outputs uncompressed digital video, as well as almost every kind of digital audio that the player is compatible with, including DVD-Video, Video CD/Super VCD, CD and MP3.

### 1 Use an HDMI cable to connect the HDMI OUT interconnect on this player to an HDMI interconnect on a HDMI-compatible monitor.

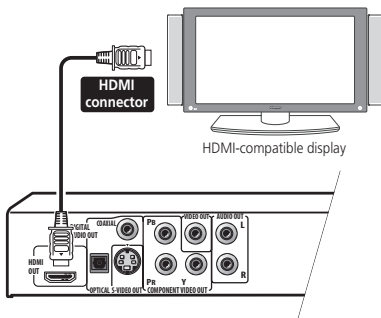

- The arrow on the cable connector body should be face up for correct alignment with the connector on the player.

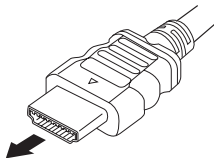

### Note

- This unit has been designed to be compliant with HDMI (High Definition Multimedia Interface) . Depending on the component you have connected, using a DVI connection may result in unreliable signal transfers.
- When you change the component connected to the HDMI output, you will also need to change the HDMI settings to match the new component (see *HDMI Out* on page 39, *HDMI Resolution* on page 40 and *HDMI Color* on page 40 to do this). However, the settings for each component are then stored in memory (for up to 2 components).
- The HDMI connection is compatible with 44.1 kHz/48 kHz, 16 bit/20 bit/24 bit 2 channel linear PCM signals, as well as Dolby Digital, DTS and MPEG audio bitstream.

## About HDMI

HDMI (High Definition Multimedia Interface) supports both video and audio on a single digital connection for use with DVD players, DTV, set-top boxes, and other AV devices. HDMI was developed to provide the technologies of High Bandwidth Digital Content Protection (HDCP) as well as Digital Visual Interface (DVI) in one specification. HDCP is used to protect digital content transmitted and received by DVI-compliant displays.

HDMI has the capability to support standard, enhanced, or high-definition video plus standard to multi-channel surround-sound audio. HDMI features include uncompressed digital video, a bandwidth of up to 2.2 gigabytes per second (with HDTV signals), one connector (instead of several cables and connectors), and communication between the AV source and AV devices such as DTVs.

*HDMI, the HDMI logo and High-Definition Multimedia Interface are trademarks or registered trademarks of HDMI licensing LLC.*

### Resetting the output resolution to the default setting with HDMI connection

Switch the player to standby then, using the front panel controls, press **STANDBY/ON** while pressing **RECALL** to switch the player back to **576P/480P**.

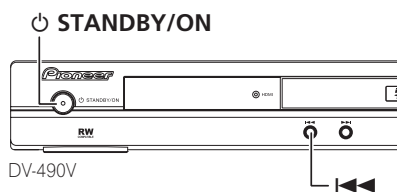

## Chapter 3

## Controls and displays

## Front panel

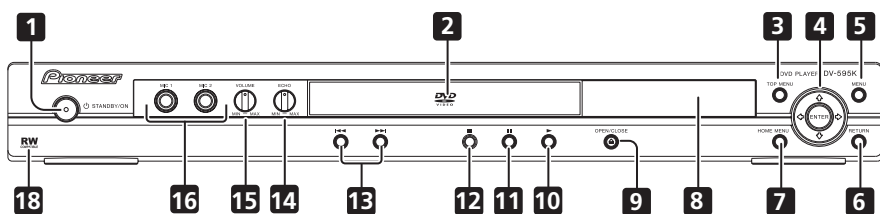

DV-595K

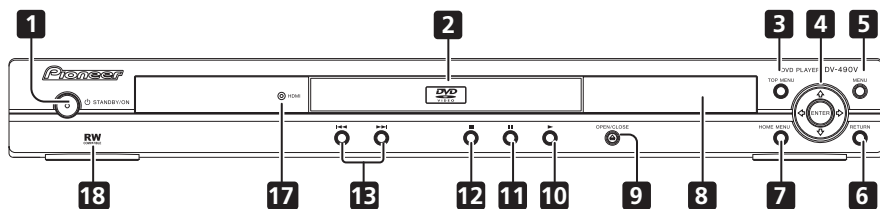

DV-490V

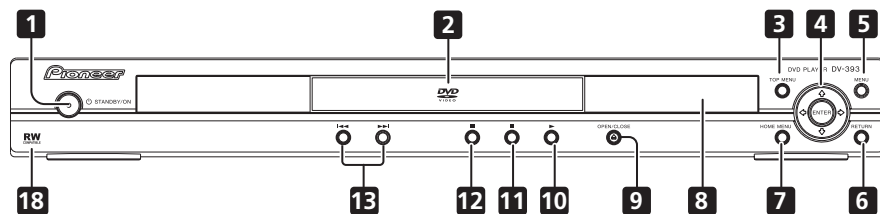

DV-393



- 1 **⏻ STANDBY/ON** (page 19)
- 2 **Disc tray**
- 3 **TOP MENU** (page 23)
- 4 **ENTER & cursor buttons** (page 20)
- 5 **MENU** (page 23)
- 6 **RETURN** (page 23)
- 7 **HOME MENU** (page 20)
- 8 **Display**
- 9 **▲ OPEN/CLOSE** (page 22)
- 10 **▶** (page 22)
- 11 **||** (page 22)
- 12 **■** (page 22)
- 13 **◀◀ and ▶▶** (page 22)
- 14 **ECHO control (DV-595K only)** (page 24)
- 15 **VOLUME control (DV-595K only)** (page 24)
- 16 **MIC input jacks (DV-595K only)** (page 24)
- 17 **HDMI indicator (DV-490V only)**  
Lights when this player is recognized by another HDMI or DVI/HDCP compatible component.
- 18 **RW Compatible** (page 8)

## Remote control

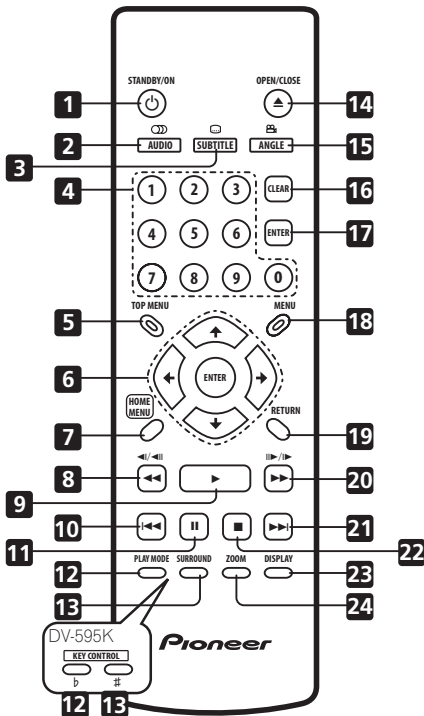

- 1 **STANDBY/ON** (page 19)
- 2 **AUDIO** (page 34)
- 3 **SUBTITLE** (page 34)
- 4 **Number buttons** (page 22)
- 5 **TOP MENU** (page 23)
- 6 **ENTER & cursor buttons** (page 20)
- 7 **HOME MENU** (page 20)
- 8 and (pages 22, 27)
- 9 (page 22)
- 10 (page 22)

11 (page 22)

12 **PLAY MODE (for DV-393 and DV-490V)**  
(page 30)

**LOW (b) (for DV-595K)** (page 24)

13 **SURROUND (for DV-393 and DV-490V)**  
(page 36)

**HIGH (#) (for DV-595K)** (page 24)

14 **OPEN/CLOSE** (page 22)

15 **ANGLE** (page 34)

16 **CLEAR** (page 33)

17 **ENTER** (page 20)

18 **MENU** (page 23)

19 **RETURN** (page 20)

20 and (pages 22, 27)

21 (page 22)

22 (page 22)

23 **DISPLAY** (page 35)

24 **ZOOM** (page 34)

## Using the remote control

Keep in mind the following when using the remote control:

- Make sure that there are no obstacles between the remote and the remote sensor on the unit.
- The remote has a range of about 7 m.
- Remote operation may become unreliable if strong sunlight or fluorescent light is shining on the unit's remote sensor.
- Remote controllers for different devices can interfere with each other. Avoid using remotes for other equipment located close to this unit.
- Replace the batteries when you notice a fall off in the operating range of the remote.

## Chapter 4

# Getting started

### Switching on

After making sure that everything is connected properly and that the player is plugged in, press **STANDBY/ON** on the front panel or remote control to switch the player on.

Also, switch on your TV and make sure that it is set to the input you connected the DVD player to.

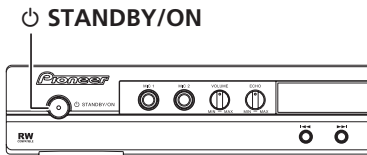

DV-595K

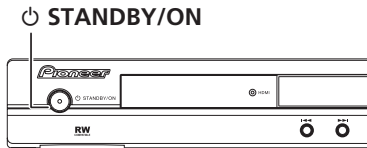

DV-490V

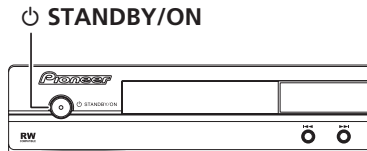

DV-393

### FAQ

- *My DVD player switches on but there is nothing displayed on my TV.*

Make sure that the TV is set to the correct video input (not a TV channel). For example, if you connected this player to the **VIDEO 1** inputs on your TV, switch your TV to **VIDEO 1**.

### Note

- This player features a screen saver and an auto power off function. If the player is stopped and no button is pressed for around five minutes, the screen saver starts. If the disc tray is closed but no disc is playing and no control is pressed for about 30 minutes, the player automatically goes into standby.

## Using the on-screen displays

For ease of use, this player makes extensive use of graphical on-screen displays (OSDs).

All the screens are navigated in basically the same way, using the cursor buttons (↑/↓/←/→) to change the highlighted item and pressing **ENTER** to select it.

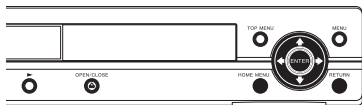
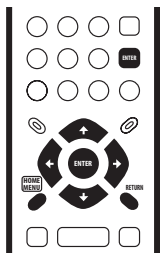

Button	What it does
<b>HOME MENU</b>	Display/exit the on-screen display.
↑/↓/←/→	Changes the highlighted menu item.
<b>ENTER</b>	Selects the highlighted menu item (both <b>ENTER</b> buttons on the remote work in exactly the same way).
<b>RETURN</b>	Returns to the main menu without saving changes.



### Note

- From here on in this manual, the word 'select' generally means use the cursor buttons to highlight an item on-screen, then press **ENTER**.

## Setting up the player for your TV

If you have a widescreen (16:9) TV, you should setup the player so that the picture will be presented correctly. If you have a conventional (4:3) TV, you can leave the player on the default setting and move on to the next section.

### 1 Press HOME MENU and select 'Initial Settings'.

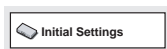

### 2 Select 'TV Screen' from the 'Video Output' settings.

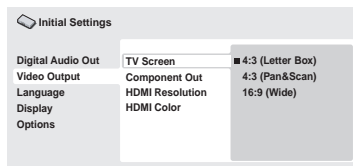

### 3 If you have a widescreen (16:9) TV, select '16:9 (Wide)'.

If you have a conventional (4:3) TV, you can change the setting from **4:3 (Letter Box)** to **4:3 (Pan & Scan)** if you prefer. See *Video Output settings* on page 39 for more details.

### 4 Press HOME MENU to exit the menu screen.

## Setting the language of this player's on-screen displays

This sets the language of the player's on-screen displays.

### 1 Press HOME MENU and select 'Initial Settings'.



### 2 Select 'OSD Language' from the 'Display' settings.

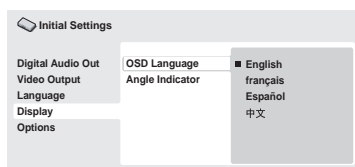

*Taiwanese model only:*

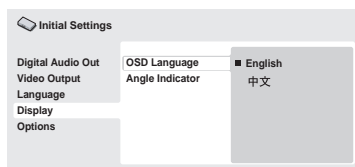

### 3 Select a language.

The on-screen language will change according to your selection.

### 4 Press HOME MENU to exit the menu screen.

## Playing discs

The basic playback controls for playing DVD, CD, Video CD/Super VCD, DivX video and MP3/WMA discs are covered here. Further functions are detailed in the next chapter.

For details on playing JPEG picture discs, see *Viewing a JPEG slideshow* on page 28.



### Important

- Throughout this manual, the term 'DVD' means DVD-Video and DVD-R/RW. If a function is specific to a particular kind of DVD disc, it is specified.

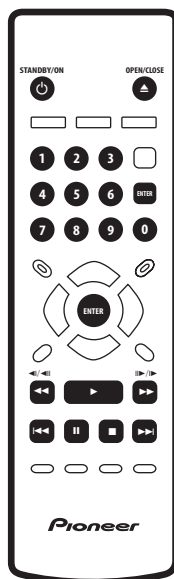

### 1 If the player isn't already on, press **STANDBY/ON** to switch it on.

If you're playing a DVD, disc containing DivX video files or Video CD/Super VCD, also turn on your TV and make sure that it is set to the correct video input.

2 Press **▲ OPEN/CLOSE** to open the disc tray.

### 3 Load a disc.

Load a disc with the label side facing up, using the disc tray guide to align the disc (if you're loading a double-sided DVD disc, load it with the side you want to play face down).

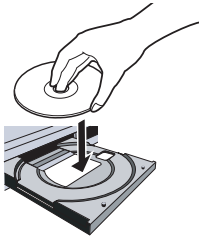

### 4 Press **▶ (play)** to start playback.

If you're playing a DVD or Video CD/Super VCD, an on-screen menu may appear. See *DVD-Video disc menus* on page 23 and *Video CD/Super VCD PBC menus* on page 24 for more on how to navigate these.

- If you're playing a containing DivX video files or MP3/WMA audio files, it may take a few seconds before playback starts, etc. This is normal.
- Please see *Disc / content format playback compatibility* on page 7 if you want to play a DualDisc (DVD/CD hybrid disc).



#### Note

- You may find with some DVD discs that some playback controls don't work in certain parts of the disc. This is not a malfunction.
- If a disc contains a mixture of DivX video and other media file types (MP3, for example), first select whether to play the DivX video files (**DivX**) or the other media file types (**MP3 / WMA / JPEG**) from the on-screen display.

## Basic playback controls

The table below shows the basic controls on the remote for playing discs. The following chapter covers other playback features in more detail.

Button	What it does
<b>▶</b>	Starts playback. If the display shows <b>RESUME</b> or <b>LAST MEM</b> playback starts from the resume or last memory point (see also <i>Resume and Last Memory</i> below.)
<b>  </b>	Pauses a disc that's playing, or restarts a paused disc.
<b>■</b>	Stops playback. See also <i>Resume and Last Memory</i> below.
<b>◀◀</b> (remote only)	Press to start fast reverse scanning. Press <b>▶</b> (play) to resume normal playback.
<b>▶▶</b> (remote only)	Press to start fast forward scanning. Press <b>▶</b> (play) to resume normal playback.
<b>I◀◀</b>	Skips to the start of the current track, title or chapter, then to previous tracks/titles/chapters.
<b>▶▶I</b>	Skips to the next track, title or chapter.
<b>Numbers</b> (remote only)	Use to enter a title/chapter/track number. Press <b>ENTER</b> to select. <ul style="list-style-type: none"> <li>• If the disc is stopped, playback starts from the selected title (for DVD) or track (for CD/Video CD/Super VCD).</li> <li>• If the disc is playing, playback jumps to the start of the selected title (VR mode DVD-RW), chapter (DVD-Video) or track (CD/Video CD/Super VCD).</li> </ul>

## Resume and Last Memory

When you stop playback of a DVD, CD, Video CD/Super VCD or DivX video discs, **RESUME** is shown in the display indicating that you can resume playback again from that point.

If the disc tray is not opened, the next time you start playback the display shows **RESUME** and playback resumes from the resume point. (If you want to clear the resume point, press ■ (stop) while **RESUME** is displayed.)

With DVDs and Video CD/Super VCDs, if you take the disc out of the player after stopping playback, the last play position is stored in memory. If the next disc you load is the same one, the display shows **LAST MEM** and playback will resume. For DVD-Video discs, the player stores the play position of the last five discs. When one of these discs is next loaded, you can resume playback.

### Note

- The Last Memory function doesn't work with VR format DVD-RW discs.
- If you don't need the Last Memory function when you stop a disc, you can press ▲ **OPEN/CLOSE** to stop playback and open the disc tray.

## DVD-Video disc menus

Many DVD-Video discs feature menus from which you can select what you want to watch. They may also give access to additional features, such as subtitle and audio language selection, or special features such as slideshows. See the disc packaging for details. Sometimes DVD-Video menus are displayed automatically when you start playback; others only appear when you press **MENU** or **TOP MENU**.

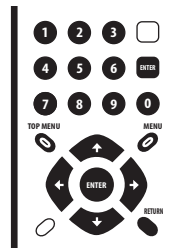

Button	What it does
<b>TOP MENU</b>	Displays the 'top menu' of a DVD disc—this varies with the disc.
<b>MENU</b>	Displays a DVD disc menu—this varies with the disc and may be the same as the 'top menu'.
↑/↓/←/→	Moves the cursor around the screen.
<b>ENTER</b>	Selects the current menu option.
<b>RETURN</b>	Returns to the previously displayed menu screen.
<b>Numbers</b> (remote only)	Highlights a numbered menu option (some discs only). Press <b>ENTER</b> to select.

## Video CD/Super VCD PBC menus

Some Video CD/Super VCDs have menus from which you can choose what you want to watch. These are called PBC (Playback control) menus.

You can play a PBC Video CD/Super VCD without having to navigate the PBC menu by starting playback using a number button to select a track, rather than the ► (play) button.

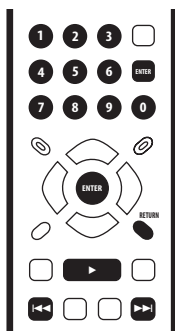

Button	What it does
<b>RETURN</b>	Displays the PBC menu.
<b>Numbers</b> (remote only)	Use to enter a numbered menu option. Press <b>ENTER</b> to select.
◀◀	Displays the previous menu page (if there is one).
▶▶	Displays the next menu page (if there is one).

## Singing Your Favorite Songs Along with Karaoke Discs

*DV-595K only*

This player has a karaoke feature that lets you sing along with your favorite songs, featuring (a) microphone(s) jack conveniently located on the front panel as well as controls for mixing the vocal level and amount of echo effect.

To use the karaoke function you must have this player connected to your TV or amplifier using the analog outputs. See also (pages 10, 12).

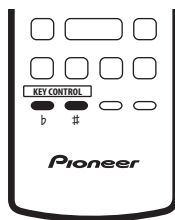
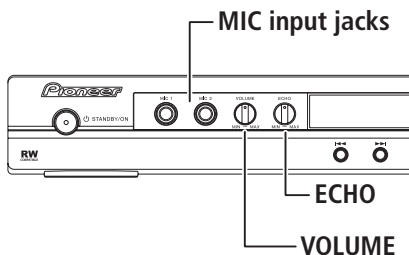

### 1 Turn both **VOLUME** and **ECHO** counter-clockwise to the minimum level.

To avoid possible damage to your speakers, be sure to turn down the volume completely before preceding to step 2.



## 2 Connect (a) microphone(s) (not supplied) to the MIC input jack.

The karaoke function is active whenever (a) microphone(s) is/are connected to the player. Make sure that the plug is inserted firmly and completely into the jack to use the karaoke function.

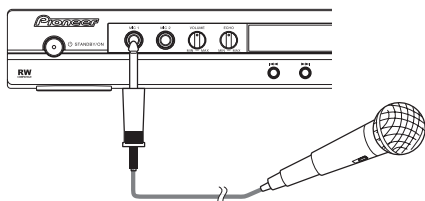

## 3 Load a disc with the music you want to use.

## 4 Play the title, chapter or track and adjust the volume of the audio playback.

- For more information on loading a disc and playing back a title, chapter or track, refer to the section *Playing discs* on page 27.
- Adjust the volume on the TV or component that audio connections are made to. **VOLUME** on the front panel controls only the level of the microphone(s).

## 5 When the music starts, turn **VOLUME** clockwise while speaking or singing into the microphone to adjust the vocal volume to an appropriate level.

## 6 Turn **ECHO** clockwise to adjust the amount of echo effect that you want added to the vocals.

The amount of echo effect needed may differ for different styles of music and for different preferences.

## 7 Adjusting the music to suit your voice

Use the key control on the remote control to match the backing music to your vocal range.

- Press **#** (HIGH) repeatedly to raise the pitch of the backing music.
- Press **b** (LOW) repeatedly to lower the pitch of the backing music.

### Note

- You can adjust the HIGH tone in a range of five steps and the LOW tone in a range of five steps.
- If the microphone level is too high, the sound may distort. In this case, lower the volume.

### When “howling” occurs

If sound from the speakers is picked up by a mic and output again through the speakers, the result is a screeching sound known as “howling”.

To eliminate howling:

- Point the mic away from the speakers.
- Move the mic away from the speakers.
- Turn **VOLUME** counterclockwise to lower the volume level.
- Turn **ECHO** counterclockwise to lower the echo effect.

### Note

- Reduce the volume when plugging in the microphone to prevent feedback.

 **FAQ**

- *After I load a DVD disc, it ejects automatically after a few seconds!*  
Most likely, the disc is the wrong region for your player. The region number should be printed on the disc; check it against the region number of the player (which you can find on the rear panel). See also *DVD-Video regions* on page 46.

If the region number is OK, it may be that the disc is damaged or dirty. Clean the disc and look for signs of damage. See also *Taking care of your player and discs* on page 44.

- *Why won't the disc I loaded play?*  
First check that you loaded the disc the right way up (label side up), and that it's clean and undamaged. See *Taking care of your player and discs* on page 44 for information on cleaning discs.  
If a disc loaded correctly won't play, it's probably an incompatible format or disc type, such as DVD-Audio or DVD-ROM. See *Disc / content format playback compatibility* on page 7 for more on disc compatibility.

- *I have a widescreen TV so why are there black bars at the top and bottom of the screen when I play some discs?*  
Some movie formats are such that even when played on a widescreen TV, black bars are necessary at the top and bottom of the screen. This is not a malfunction.
- *I have a standard (4:3) TV and set the player to show widescreen DVDs in pan & scan format, so why do I still get black bars top and bottom with some discs?*

Some discs override the display preferences of the player, so even if you have **4:3 (Pan & Scan)** selected, those discs will still be shown in letter box format. This is not a malfunction.

- *I've connected to a HDMI compatible component but I can't get any signal and the front panel HDMI indicator won't light!*  
Make sure that you've selected this player as the HDMI input in the settings for the component you're using. You may need to refer to the instruction manual of the component to do this. See *Connecting using HDMI (DV-490V only)* on page 14 for more on HDMI compatibility.
- *There's no picture from the HDMI output!*  
This player cannot display pictures from DVI compatible sources. See *Connecting using HDMI (DV-490V only)* on page 14 for more on HDMI compatibility.  
Make sure the resolution on this player matches that of the component you have connected using HDMI. See *HDMI Resolution* on page 40 to change the HDMI resolution.

## Chapter 5

# Playing discs

### Note

- Many of the functions covered in this chapter apply to DVD discs, Video CDs/Super VCDs, CDs, DivX video and WMA/MP3, JPEG discs, although the exact operation of some varies slightly with the kind of disc loaded.
- Some DVDs restrict the use of some functions (random or repeat, for example) in some or all parts of the disc. This is not a malfunction.
- When playing Video CD/Super VCDs, some of the functions are not available during PBC playback. If you want to use them, start the disc playing using a number button to select a track.

## Scanning discs

You can fast-scan discs forward or backward at four different speeds (DivX video only one speed).

### 1 During playback, press ◀◀ or ▶▶ to start scanning.

- There is no sound while scanning DVDs, DivX video and Video CD/Super VCDs.

### 2 Press repeatedly to increase the scanning speed.

- The scanning speed is shown on-screen.

### 3 To resume normal playback, press ▶ (play).

- When scanning a Video CD/Super VCD playing in PBC mode or a WMA/MP3 track, playback automatically resumes at the end or beginning of the track.

- Depending on the disc, normal playback may automatically resume when a new chapter is reached on a DVD disc.

## Playing in slow motion

You can play DVDs at four different slow motion speeds, forwards and backwards. Video CD/Super VCDs and DivX video can be played at four different forward slow motion speeds.

### 1 During playback, press II (pause).

### 2 Press and hold ◀◀/◀◀II or II▶/▶▶ until slow motion playback starts.

- The slow motion speed is shown on-screen.
- There is no sound during slow motion playback.

### 3 Press repeatedly to change the slow motion speed.

### 4 To resume normal playback, press ▶ (play).

- Depending on the disc, normal playback may automatically resume when a new chapter is reached.

## Frame advance/frame reverse

You can advance or back up DVD discs frame-by-frame. With Video CD/Super VCDs and DivX video file you can only use frame advance.

**1 During playback, press II (pause).**

**2 Press <I/◀II or II>/I▶ to reverse or advance a frame at a time.**

**3 To resume normal playback, press ▶ (play).**

- Depending on the disc, normal playback may automatically resume when a new chapter is reached.

## Viewing a JPEG slideshow

After loading a CD/CD-R/RW containing JPEG picture files, press ▶ (play) to start a slideshow from the first folder/picture on the disc. The player displays the pictures in each folder in alphabetical order.

- If the folder contains WMA/MP3 files, playback of the slideshow and WMA/MP3 files repeats. During the audio playback, you can still use the skip (I◀◀/▶▶I), scan (◀◀/▶▶) and pause (II) functions.

Pictures are automatically adjusted so that they fill as much of the screen as possible (if the aspect ratio of the picture is different to your TV screen you may notice black bars at the sides, or at the top and bottom of the screen).

While the slideshow is running:

Button	What it does
II	Pauses the slideshow; press again to restart.
I◀◀	Displays the previous picture.
▶▶I	Displays the next picture.

Button	What it does
◀/→	Pauses the slideshow and rotates the displayed picture 90° (counter) clockwise. (Press ▶ (play) to restart slideshow.)
↑/↓	Pauses the slideshow and flips the displayed picture horizontally or vertically. (Press ▶ (play) to restart slideshow.)
ZOOM	Pauses the slideshow and zooms the picture. Press again to toggle between 1x, 2x and 4x zoom. (Press ▶ (play) to restart slideshow.)
MENU	Displays the Disc Navigator screen (see below).



### Note

- The time it takes for the player to load a file increases with large file sizes.

## Browsing DVD or Video CD/ Super VCD disc with the Disc Navigator

Use the Disc Navigator to browse through the contents of a DVD or Video CD/Super VCD disc to find the part you want to play.



### Important

- You can't use the Disc Navigator with Video CD/Super VCDs in PBC mode.

**1 During playback, press HOME MENU and select 'Disc Navigator' from the on-screen menu.**

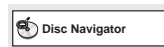

## 2 Select a view option.

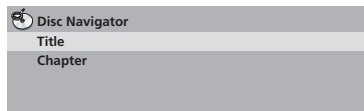

The options available depend on the kind of disc loaded and whether the disc is playing or not, but include:

- **Title** – Titles from a DVD-Video disc.
- **Chapter** – Chapters from the current title of a DVD-Video disc.
- **Track** – Tracks from a Video CD/Super VCD disc.
- **Time** – Thumbnails from a Video CD/Super VCD disc at 10 minute intervals.
- **Original: Title** – Original titles from a VR mode DVD-RW disc.
- **Play List: Title** – Playlist titles from a VR mode DVD-RW disc.
- **Original: Time** – Thumbnails from the Original content at 10 minute intervals.
- **Play List: Time** – Thumbnails from the Playlist at 10 minute intervals.

The screen shows up to six moving thumbnail images displayed one after another. To display the previous/next six thumbnails, press **I◀◀/▶▶I** (you don't have to wait for all the thumbnails to finish playing to display the previous/next page).

## 3 Select the thumbnail image for what you want to play.

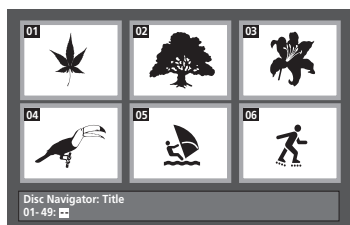

You can use either the cursor buttons (**↑/↓/←/→**) and **ENTER** to select a thumbnail, or the number buttons.

To select using the number buttons, enter a two-digit number then press **ENTER**.



### Tip

- Another way to find a particular place on a disc is to use one of the search modes. See *Searching a disc* on page 33.

## Browsing WMA, MP3, DivX video and JPEG files with the Disc Navigator

Use the Disc Navigator to find a particular file or folder by filename. Note that if there are other types of files on the same disc, these will not be displayed in the Disc Navigator.

### 1 Press HOME MENU and select 'Disc Navigator' from the on-screen menu.

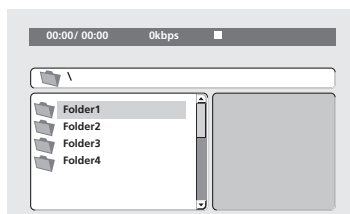

### 2 Use the cursor buttons (**↑/↓/←/→**) and **ENTER** to navigate.

Use the cursor up/down buttons (**↑/↓**) to move up and down the folder/file list.

Use the cursor left button (**←**) to return to the parent folder.

Use **ENTER** or cursor right (**→**) to open a highlighted folder.

- You can also return to the parent folder by going to the top of the list to the '..' folder, then pressing **ENTER**.

- When a JPEG file is highlighted, a thumbnail image is displayed on the right.

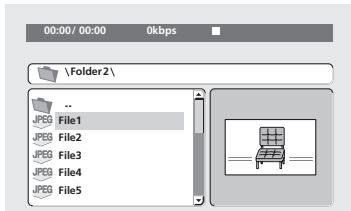

### 3 To play the highlighted track or DivX video file or display the highlighted JPEG file, press ENTER.

- When a WMA/MP3 or DivX video file is selected, playback begins, starting with the selected file, and continues until the end of the folder.
- When a JPEG file is selected, a slideshow begins, starting with that file, and continues to the end of the folder.



#### Tip

- You can also play a JPEG slideshow while listening to WMA/MP3 playback. Simply select the audio file you want to listen to followed by the JPEG from which you want the slideshow to start. Playback of both the slideshow and the audio files repeats. Playback controls are effective for the JPEG slideshow only.
- To play the contents of the whole disc rather than just the current folder, exit the Disc Navigator and start playback using the ► (play) button.

## Looping a section of a disc

The A-B Repeat function allows you to specify two points (A and B) within a track (CD, Video CD/Super VCD) or title (DVD) that form a loop which is played over and over.

- You can't use A-B Repeat with Video CD/Super VCDs in PBC mode, or WMA/MP3/DivX video files.

### 1 During playback, press HOME MENU and select 'PLAY MODE' from the on-screen menu.

### 2 Select 'A-B Repeat' from the list of functions on the left.

*DV-393 and DV-490V*: During playback, press **PLAY MODE** and select 'A-B Repeat' from the list of functions on the left.

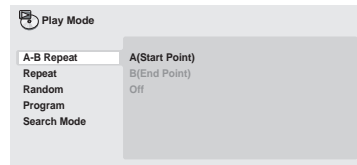

### 3 Press ENTER on 'A(Start Point)' to set the loop start point.

### 4 Press ENTER on 'B(End Point)' to set the loop end point.

After pressing **ENTER**, playback jumps back to the start point and plays the loop.

### 5 To resume normal playback, select 'Off' from the menu.

## Using repeat play

There are various repeat play options, depending on the kind of disc loaded. It's also possible to use repeat play together with program play to repeat the tracks/chapters in the program list (see *Creating a program list* on page 32).

## Important

- You can't use Repeat play with Video CD/ Super VCDs in PBC mode, or with WMA/ MP3 discs.
- You can't use repeat and random play at the same time.

**1 During playback, press HOME MENU and select 'PLAY MODE' from the on-screen menu.**

**2 Select 'Repeat' from the list of functions on the left.**

*DV-393 and DV-490V* : During playback, press **PLAY MODE** and select 'Repeat' from the list of functions on the left.

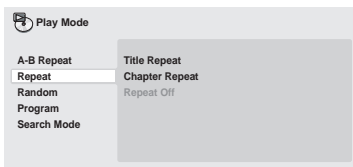

**3 Select a repeat play option.**

If program play is active, select **Program Repeat** to repeat the program list, or **Repeat Off** to cancel.

The repeat options available depend on the kind of disc loaded. For example, for DVD discs, you can select **Title Repeat** or **Chapter Repeat** (or **Repeat Off**).



- For CDs and Video CD/Super VCDs, select **Disc Repeat** or **Track Repeat** (or **Repeat Off**).
- For DivX video discs, select **Title Repeat** (or **Repeat Off**).

## Using random play

Use the random play function to play titles or chapters (DVD-Video), or tracks (CD, Video CD/ Super VCD) at random. (Note that the same track/title/chapter may play more than once.)

You can set the random play option when a disc is playing or stopped.

## Important

- Random play remains in effect until you select **Random Off** from the random play menu options.
- You can't use random play with VR format DVD-RW discs, Video CD/Super VCDs playing in PBC mode, WMA/MP3 discs, DivX video discs, or while a DVD disc menu is being displayed.
- You can't use random play together with program or repeat play.

**1 Press HOME MENU and select 'PLAY MODE' from the on-screen menu.**

**2 Select 'Random' from the list of functions on the left.**

*DV-393 and DV-490V* : Press **PLAY MODE** and select 'Random' from the list of functions on the left.

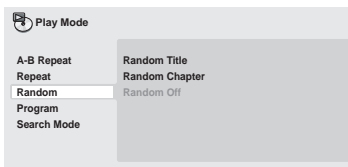

### 3 Select a random play option.

The random play options available depend on the kind of disc loaded. For example, for DVD discs, you can select **Random Title** or **Random Chapter** (or **Random Off**).

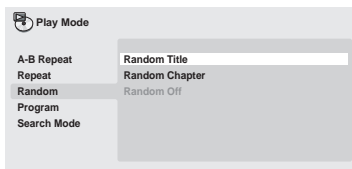

- For CDs and Video CD/Super VCDs, select **On** or **Off** to switch random play on or off.



#### Tip

- Use the following controls during random play:

Button	What it does
▶▶	Selects a new track/title/chapter at random.
◀◀	Returns to the beginning of the current track/title/chapter; further presses select another random track/title/chapter.

## Creating a program list

This feature lets you program the play order of titles/chapters/tracks on a disc.



#### Important

- You can't use Program play with VR format DVD-RW discs, Video CD/Super VCDs playing in PBC mode, WMA/MP3 discs, DivX video discs, or while a DVD disc menu is being displayed.

**1 Press HOME MENU and select 'PLAY MODE' from the on-screen menu.**

**2 Select 'Program' from the list of functions on the left.**

*DV-393 and DV-490V:* Press **PLAY MODE** and select 'Program' from the list of functions on the left.

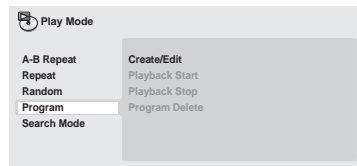

**3 Select 'Create/Edit' from the list of program options.**

**4 Use the cursor buttons and ENTER to select a title, chapter or track for the current step in the program list.**

For a DVD disc, you can add a title or a chapter to the program list.

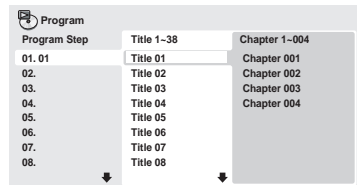

- For a CD or Video CD/Super VCD, select a track to add to the program list.

After pressing **ENTER** to select the title/chapter/track, the step number automatically moves down one.

**5 Repeat step 3 to build up a program list.**

A program list can contain up to 24 titles/chapters/tracks.



- You can insert steps into the middle of a program list by just highlighting the position where you want the new step to appear and entering a title/chapter/track number.
- To delete a step, highlight it and press **CLEAR**.

## 6 To play the program list, press ► (play).

Program play remains active until you turn off program play (see below), erase the program list (see below), eject the disc or switch off the player.



### Tip

- Use the following controls during program play:

Button	What it does
<b>PLAY MODE</b> (DV-393 and DV-490V only)	Save the program list and exit the program edit screen without starting playback.
<b>HOME MENU</b>	Save the program list and exit the program edit screen without starting playback.
▶▶	Skip to the next step in the program list.

## Other functions available from the program menu

There are a number of other options in the program menu in addition to Create/Edit.

- **Playback Start** – Starts playback of a saved program list
- **Playback Stop** – Turns off program play, but does not erase the program list
- **Program Delete** – Erases the program list and turns off program play

## Searching a disc

You can search DVD discs by title or chapter number, or by time; CDs and Video CD/Super VCDs by track number or time; DivX video discs by time.



### Important

- Search functions are not available with Video CD/Super VCDs in PBC mode, or with WMA/MP3 discs.

**1 During playback, press HOME MENU and select 'PLAY MODE' from the on-screen menu.**

**2 Select 'Search Mode' from the list of functions on the left.**

*DV-393 and DV-490V* : During playback, press **PLAY MODE** and select 'Search Mode' from the list of functions on the left.

**3 Select a search mode.**

The search options available depend on the kind of disc loaded.

- The disc must be playing in order to use time search.

**4 Use the number buttons to enter a title, chapter or track number, or a time.**

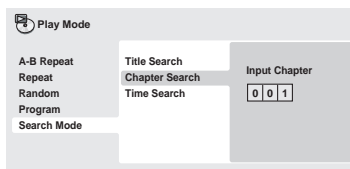

- For a time search, enter the number of minutes and seconds into the currently playing title (DVD/ DivX video) or track (CD/ Video CD/Super VCD) you want playback to resume from. For example, press **4, 5, 0, 0** to have playback start from 45 minutes into the disc. For 1 hour, 20 minutes and 30 seconds, press **8, 0, 3, 0**.

## 5 Press ENTER to start playback.

### Switching subtitles

Some DVD and DivX video discs have subtitles in one or more languages; the disc box will usually tell you which subtitle languages are available. You can switch subtitle language during playback.

#### 1 Press SUBTITLE repeatedly to select a subtitle option.

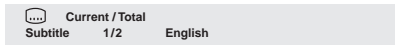

#### Note

- Some discs only allow you to change subtitle language from the disc menu. Press **TOP MENU** or **MENU** to access.
- To set subtitle preferences, see *Subtitle Language* on page 40.
- See *Displaying DivX subtitle files* on page 9 for more on DivX subtitles.

### Switching audio language/channels

When playing a DVD and DivX video disc recorded with dialog in two or more languages, you can switch audio language during playback.

When playing a VR format DVD-RW disc recorded with dual-mono audio, you can switch between the main, sub, and mixed channels during playback.

When playing a Video CD/Super VCD, you can switch between stereo, just the left channel or just the right channel.

#### 1 Press AUDIO repeatedly to select an audio language/channel option.

The language/channel information is shown on-screen.



#### Note

- Some DVD discs only allow you to change audio language from the disc menu. Press **TOP MENU** or **MENU** to access.
- To set DVD audio language preferences, see *Language settings* on page 40.

### Zooming the screen

Using the zoom feature you can magnify a part of the screen by a factor of 2 or 4, while watching a DVD, DivX video title or Video CD/Super VCD or playing a JPEG disc.

#### 1 During playback, use the ZOOM button to select the zoom factor (Normal, 2x or 4x).

- Since DVD, Video CD/Super VCD, DivX video title and JPEG pictures have a fixed resolution, picture quality will deteriorate, especially at 4x zoom. This is not a malfunction.

#### 2 Use the cursor buttons to change the zoomed area.

You can change the zoom factor and the zoomed area freely during playback.

- If the navigation square at the top of the screen disappears, press **ZOOM** again to display it.

### Switching camera angles

Some DVD discs feature scenes shot from two or more angles—check the disc box for details.

When a multi-angle scene is playing, a  icon appears on screen to let you know that other angles are available (this can be switched off if you prefer—see *Display settings* on page 41).

#### 1 During playback, press ANGLE to switch angle.

### Displaying disc information

Various track, chapter and title information, such as the elapsed and remaining playing time can be displayed on-screen while a disc is playing.

#### 1 To show/switch/hide the information displayed, press **DISPLAY** repeatedly.

- When a disc is playing, the information appears at the top of the screen. Keep pressing **DISPLAY** to change the displayed information.

## Chapter 6

# Audio Settings and Video Adjust menu

## Audio Settings menu

The Audio Settings menu offers features for adjusting the way discs sound.

1 Press **HOME MENU** and select 'Audio Settings' from the on-screen display.



2 Select and change settings using the **↑/↓/←/→** (cursor) buttons, and **ENTER**.

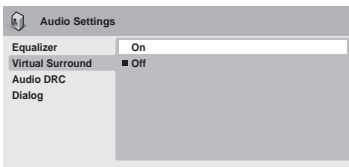

### Audio DRC

- Settings: **High, Medium, Low, Off** (default)

When watching Dolby Digital DVDs at low volume, it's easy to lose the quieter sounds completely—including some of the dialog. Switching Audio DRC (Dynamic Range Control) to on can help by bringing up the quieter sounds, while controlling loud peaks.

How much of a difference you hear depends on the material you're listening to. If the material doesn't have wide variations in volume, you may not notice much change.

### Note

- Audio DRC is only effective with Dolby Digital audio sources.
- Audio DRC is only effective through the digital output when **Digital Out** is set to **On**, and **Dolby Digital Out** is set to **Dolby Digital > PCM** (see *Digital Audio Out settings* on page 38).
- The effect of Audio DRC also depends on your speakers and AV receiver settings.

### Virtual Surround

- Settings: **On, Off** (default)

Switch on Virtual Surround to enjoy realistic surround sound effects from just two speakers.

### Tip

- *DV-393 and DV-490V*: You can also use the **SURROUND** button on the remote control to switch Virtual Surround on.

### Note

- Virtual Surround doesn't work with DTS, through either the analog or digital outputs.
- 96 kHz linear PCM audio is automatically downsampled to 48 kHz if Virtual Surround is switched on.

- If the player is outputting Dolby Digital, DTS or MPEG bitstream audio (in other words, no conversion to PCM), Virtual Surround has no effect on the audio from the digital output. See *Digital Audio Out settings* on page 38 for how to set up the digital output formats.
- How good the surround effect is varies with the disc.

## Dialog

- Settings: **High, Medium, Low, Off** (default)

The Dialog feature is designed to make the dialog stand out from other background sounds in the soundtrack.

## Equalizer

- Settings: **Rock, Pop, Live, Dance, Techno, Classic, Soft, Off** (default)

The various preset EQ curves are designed to suit various styles of music.

### Note

- 96 kHz linear PCM audio is automatically downsampled to 48 kHz if the Equalizer is switched on.

## Video Adjust menu

From the Video Adjust screen you can adjust various settings that affect how the picture is presented.

- 1 Press HOME MENU and select 'Video Adjust' from the on-screen display.



- 2 Make settings using the ↑/↓/←/→ (cursor) buttons, and ENTER.

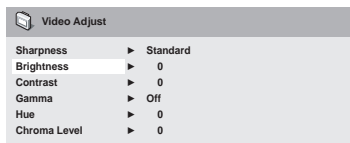

You can adjust the following picture quality settings:

- **Sharpness** – Adjusts the sharpness of edges in the picture (**Fine, Standard** (default), **Soft**).
- **Brightness** – Adjusts the overall brightness (**-20 to +20**).
- **Contrast** – Adjusts the contrast between light and dark (**-16 to +16**).
- **Gamma** – Adjusts the 'warmth' of the picture (**High, Medium, Low, Off** (default)).
- **Hue** – Adjusts the red/green balance (**green 9 to red 9**).
- **Chroma Level** – Adjusts how saturated colors appear (**-9 to +9**).

Adjust the Brightness, Contrast, Hue and Chroma Level settings using the ←/→ (cursor left/right) buttons.



- 3 Press ENTER to return to the Video Adjust screen, or HOME MENU to exit.

## Chapter 7

# Initial Settings menu

## Using the Initial Settings menu

The Initial Settings menu provides audio and video output settings, parental lock settings, and display settings, among others.

If an option is grayed out it means that it cannot be changed at the current time. This is usually because a disc is playing. Stop the disc, then change the setting.

### 1 Press HOME MENU and select 'Initial Settings'.

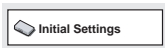

### 2 Use the cursor buttons and ENTER to select the setting and option you want to set.

All the settings and options are explained on the following pages.



#### Note

- In the table below, the default setting is shown in **bold**; other settings are shown in *italics*.

- The Digital Audio Out settings only need to be set if you have connected the digital output of this player to an AV receiver, or other equipment.
- Check the operating instructions supplied with your other equipment to see which digital audio formats it's compatible with.
- Some settings, such as **TV Screen**, **Audio Language** and **Subtitle Language** may be overridden by the DVD disc. Often these settings can also be made from the DVD disc menu.
- The **HDMI Out**, **HDMI Resolution** and **HDMI Color** settings only need to be set if you connected this player to an HDMI-compatible component using the HDMI connector.
- The **Digital Audio Out**, **Component Out** and **AV Connector Out** settings cannot be set if the player is connected to an HDMI-compatible component using the HDMI connector.

## Digital Audio Out settings

Setting	Option	What it means
<b>Digital Out</b>	<b>On</b>	Digital audio is output from the digital outputs.
	<i>Off</i>	No digital audio output.
<b>Dolby Digital Out</b>	<b>Dolby Digital</b>	Dolby Digital encoded digital audio is output when playing a Dolby Digital DVD disc.
	<i>Dolby Digital &gt; PCM</i>	Dolby Digital audio is converted to PCM audio before being output.

Setting	Option	What it means
<b>DTS Out</b>	<b>DTS</b>	DTS encoded digital audio is output when playing a DTS disc. (Noise will be output if your amplifier/receiver is not compatible with DTS audio.)
	<i>Off</i>	No digital audio is output when playing a DTS disc.
<b>96 kHz PCM Out</b>	<b>96kHz &gt; 48kHz</b>	96 kHz digital audio is converted to 48 kHz for digital output.
	<i>96kHz</i>	96 kHz digital audio is output as is at 96 kHz.
<b>MPEG Out</b>	<b>MPEG &gt; PCM</b>	MPEG encoded digital audio is converted to PCM audio for digital output.
	<i>MPEG</i>	MPEG encoded digital audio is output as is.
<b>HDMI Out*</b> * DV-490V only.	<b>LPCM (2CH)</b>	Set if your monitor or device only accepts stereo input. On this setting multichannel audio is downmixed to 2 channels for stereo linear PCM output. (In case of DTS source, the HDMI audio output is turned off.)
	<i>Auto</i>	Dolby Digital, DTS and MPEG sources are processed according to how they were encoded, but if your amplifier/monitor is not compatible with DTS audio, DTS audio output from HDMI is turned off. Linear PCM sources are heard as is.
	<i>Off</i>	No digital audio output.

## Video Output settings

Setting	Option	What it means
<b>TV Screen</b> (This setting effective for analog and HDMI video output. See also <i>Screen sizes and disc formats</i> on page 45.)	<b>4:3 (Letter Box)</b>	Set if you have a conventional 4:3 TV. Widescreen movies are shown with black bars top and bottom.
	<i>4:3 (Pan &amp; Scan)</i>	Set if you have a conventional 4:3 TV. Widescreen movies are shown with the sides cropped so that the image fills the screen.
	<i>16:9 (Wide)</i>	Set if you have a widescreen TV.
<b>Component Out</b>	<b>Interlace</b>	Set if your TV is not compatible with progressive scan video.
	<i>Progressive</i>	Set if your TV is compatible with progressive scan video (see your TV's instruction manual for details). See also <i>Switching the video output to interlace using the front panel controls</i> on page 12. <i>Note that progressive scan video is only output from the component video jacks and that there is no output from the composite and S-video jacks when this setting is selected.</i>

Setting	Option	What it means
<b>HDMI Resolution*</b> (Default changes with TV format (PAL/NTSC).) * DV-490V only.	1920x1080i	Set if your TV supports 1920 x 1080 pixel interlace video.
	1280x720p	Set if your TV supports 1280 x 720 pixel progressive-scan video.
	<b>720x480p (NTSC) / 720x576p (PAL)</b>	Set if your TV supports 720 x 480 pixel (NTSC) / 720 x 576 pixel (PAL) progressive-scan video.
	720x480i (NTSC) / 720x576i (PAL)	Set if your TV supports 720 x 480 pixel (NTSC) / 720 x 576 pixel (PAL) interlace video.
<b>HDMI Color*</b> (Default changes depending on device connected.) * DV-490V only.	Full range RGB	If colors are weak, this gives brighter colors and deeper black.
	RGB	Use this setting if colors appear overly rich on the Full Range RGB setting.
	Component	Outputs component video format (default setting for HDMI-compatible devices).

## Language settings

Setting	Option	What it means
<b>Audio Language</b>	<b>English</b>	If there is an English soundtrack on the disc then it will be played.
	<i>Languages as displayed</i>	If there is the language selected on the disc, then it will be played.
	<i>Other Language</i>	Select to choose a language other than the ones displayed (see page 47).
<b>Subtitle Language</b> (See also <i>Displaying DivX subtitle files</i> on page 9.)	<b>English</b>	If there are English subtitles on the disc then they will be displayed.
	<i>Languages as displayed</i>	If there is the subtitle language selected on the disc, then it will be displayed.
	<i>Other Language</i>	Select to choose a language other than the ones displayed (see page 47).
<b>DVD Menu Lang.</b>	<b>w/Subtitle Lang.</b>	DVD disc menus will be displayed in the same language as your selected subtitle language, if possible.
	<i>Languages as displayed</i>	DVD disc menus will be displayed in the selected language, if possible.
	<i>Other Language</i>	Select to choose a language other than the ones displayed (see page 47).



Setting	Option	What it means
Subtitle Display	On	Subtitles are displayed according to your selected subtitle language (see above).
	Off	Subtitles are always off by default when you play a DVD disc (note that some discs override this setting).

## Display settings

Setting	Option	What it means
OSD Language	English	On-screen displays of the player are in English.
	<i>Languages as displayed</i>	On-screen displays are shown in the language selected.
Angle Indicator	On	A camera icon is displayed on-screen during multi-angle scenes on a DVD disc.
	Off	No multi-angle indication is shown.

## Options settings

Setting	Option	What it means
Parental Lock	–	See <i>Parental Lock</i> on page 42.
DivX VOD	Display	See <i>About DivX® VOD content</i> on page 43.

## Parental Lock

- Default level: **Off**; Default password: *none*;  
Default Country/Area code: **us (2119)**

To give you some control over what your children watch on your DVD player, some DVD-Video discs feature a Parental Lock level. If your player is set to a lower level than the disc, the disc won't play.

Some discs also support the Country/Area Code feature. The player does not play certain scenes on these discs, depending on the Country/Area Code you set.



### Note

- Not all discs use Parental Lock, and will play without requiring the password first.
- If you forget your password, you'll need to reset the player to register a new password (see *Resetting the player* on page 46).

## Registering a new password

You must register a password before you can change the Parental Lock level or enter a Country code.

### 1 Select 'Options', then 'Password'.

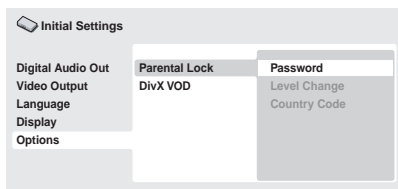

### 2 Use the number buttons to enter a 4-digit password.

The numbers you enter show up as asterisks (\*) on-screen.

### 3 Press ENTER to register the password.

You will return to the Options menu screen.

## Changing your password

To change your password, confirm your existing password then enter a new one.

### 1 Select 'Password Change'.

### 2 Use the number buttons to enter your existing password, then press ENTER.

### 3 Enter a new password and press ENTER.

This registers the new password and you will return to the Options menu screen.

## Setting/changing the Parental Lock

### 1 Select 'Level Change'.

### 2 Use number buttons to enter your password, then press ENTER.

### 3 Select a new level and press ENTER.

- Press ← (cursor left) repeatedly to lock more levels (more discs will require the password); press → (cursor right) to unlock levels. You can't lock level 1.

This sets the new level and you will return to the Options menu screen.

## Setting/changing the Country/Area code

You can find the *Country/Area code list* on page 50.

### 1 Select 'Country Code'.

### 2 Use number buttons to enter your password, then press ENTER.

### 3 Select a Country/Area code and press ENTER.

There are two ways you can do this:

- Select by code letter: Use ↑/↓ (cursor up/down) to change the Country/Area code.
- Select by code number: Press → (cursor right) then use the number buttons to enter the 4-digit Country/Area code.

The new Country/Area code is set and you will return to the Options menu screen. Note that the new Country/Area code doesn't take effect until the next disc is loaded (or the current disc is reloaded).

## About DivX® VOD content

In order to play DivX VOD (video on demand) content on this player, you first need to register the player with your DivX VOD content provider. You do this by generating a DivX VOD registration code, which you submit to your provider.



### Important

- DivX VOD content is protected by a DRM (Digital Rights Management) system. This restricts playback of content to specific, registered devices.
- If you load a disc that contains DivX VOD content not authorized for your player, the message **Authorization Error** is displayed and the content will not play.
- Resetting the player (as described in *Resetting the player* on page 46) will not cause you to lose your registration code.

## Displaying your DivX VOD registration code

**1 Press HOME MENU and select 'Initial Settings'.**

**2 Select 'Options', then 'DivX VOD'.**

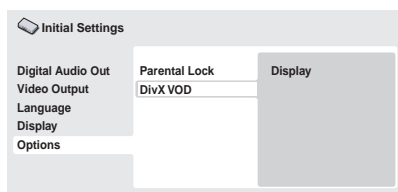

**3 Select 'Display'.**

Your 8-digit registration code is displayed.

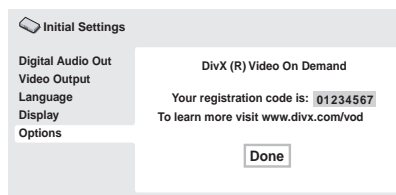

Make a note of the code as you will need it when you register with a DivX VOD provider.

## Playing DivX® VOD content

Some DivX VOD content may only be playable a fixed number of times. When you load a disc containing this type of DivX VOD content, the remaining number of plays is shown on-screen and you then have the option of playing the disc (thereby using up one of the remaining plays), or stopping. If you load a disc that contains expired DivX VOD content (for example, content that has zero remaining plays), the message **Rental Expired** is displayed.

If your DivX VOD content allows an unlimited number of plays, then you may load the disc into your player and play the content as often as you like, and no message will be displayed.

## Chapter 8

# Additional information

## Taking care of your player and discs

### General

Hold discs by the edge or by the center hole and edge.

When you're not using a disc, return it to its case and store upright. Avoid leaving discs in excessively cold, humid, or hot environments (including under direct sunlight).

Don't glue paper or put stickers on to discs. Do not use a pencil, ball-point pen or other sharp-tipped writing instrument to write on the disc.



Don't use self-adhesive disc labels on discs as these can cause the disc to warp slightly during playback causing distortion in the picture and/or sound.

### Damaged and shaped discs

Do not use cracked, chipped, warped, or otherwise damaged discs as they may damage the player.

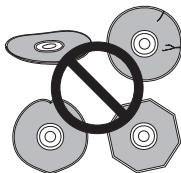

This player is designed to be used only with conventional, fully circular discs. Do not use shaped discs. Pioneer disclaims all liability arising in connection with the use of shaped discs.

### Cleaning discs

Fingerprints and dust on discs can affect playback performance. Clean using a soft, dry cloth, wiping the disc lightly from the center to the outside edge as shown below.



If necessary, use a cloth soaked in alcohol, or a commercially available CD/DVD cleaning kit to clean a disc more thoroughly. Never use benzene, thinner or other cleaning agents, including products designed for cleaning vinyl records.

### Cleaning the unit's exterior

Unplug the unit before cleaning.

Use a dry cloth to wipe off dust and dirt. If the surfaces are very dirty, wipe with a soft cloth dipped in some neutral cleanser diluted five or six times with water and wrung out well, then wipe again with a dry cloth.

Do not use furniture wax or cleaners. Never use thinners, benzene or insecticide sprays or other chemicals on or near this unit.

If you use a chemical-impregnated cleaning cloth, read the instructions carefully before use. These cloths may leave smear marks on half-mirror finish surfaces; if this happens, finish with a dry cloth.

### Cleaning the pickup lens

The DVD player's lens should not become dirty in normal use, but if for some reason it should malfunction due to dust or dirt, consult your nearest Pioneer-authorized service center. We do not recommend using commercially available lens cleaners for CD players.

### Condensation

Condensation may form inside the player if it is brought into a warm room from outside, or if the temperature of the room rises quickly. Although the condensation won't damage the player, it may temporarily impair its performance. Leave it to adjust to the warmer temperature for about an hour before switching on.

### Moving the player

If you need to move the player, first press **⏻ STANDBY/ON** on the front panel to turn the player off. Wait for **-OFF-** to disappear from the display, then unplug the power cable. Never lift or move the unit during playback—discs rotate at a high speed and may be damaged.

### Screen sizes and disc formats

DVD-Video discs come in several different screen aspect ratios, ranging from TV programs, which are generally 4:3, to CinemaScope widescreen movies, with an aspect ratio of up to about 7:3.

Televisions, too, come in different aspect ratios; 'standard' 4:3 and widescreen 16:9.

### Widescreen TV users

If you have a widescreen TV, the **TV Screen** setting (page 39) of this player should be set to **16:9 (Wide)**.

When you watch discs recorded in 4:3 format, you can use the TV controls to select how the picture is presented. Your TV may offer various zoom and stretch options; see the instructions that came with your TV for details.

Please note that some movie aspect ratios are wider than 16:9, so even though you have a widescreen TV, these discs will still play in a 'letter box' style with black bars at the top and bottom of the screen.

### Standard TV users

If you have a standard TV, the **TV Screen** setting (page 39) of this player should be set to **4:3 (Letter Box)** or **4:3 (Pan&Scan)**, depending on which you prefer.

Set to **4:3 (Letter Box)**, widescreen discs are shown with black bars top and bottom.



Set to **4:3 (Pan&Scan)**, widescreen discs are shown with the left and right sides cropped. Although the picture looks larger, you don't actually see the whole picture.



Please note that many widescreen discs override the player's settings so that the disc is shown in letter box format regardless of the setting.

**Note**



- Using the **16:9 (Wide)** setting with a standard 4:3 TV, or either of the 4:3 settings with a widescreen TV, will result in a distorted picture.

## Setting the TV system

(Except Taiwanese model)

The default setting of this player is **AUTO**, and unless you notice that the picture is distorted when playing some discs, you should leave it set to **AUTO**. If you experience picture distortion with some discs, set the TV system to match your country or region's system. Doing this, however, may restrict the kinds of disc you can watch. The table below shows what kinds of disc are compatible with each setting (**AUTO**, **PAL** and **NTSC**).

**1 If the player is on, press  STANDBY/ON to switch it to standby.**

**2 Using the front panel controls, hold down  then press  STANDBY/ON to switch the TV system.**

The TV system changes as follows:

- AUTO** → **NTSC**
- NTSC** → **PAL**
- PAL** → **AUTO**

**Note**

- You have to switch the player into standby (press  **STANDBY/ON**) before each change.

Disc Type	Format	Player setting		
		NTSC	PAL	AUTO
DVD/Super VCD/Video CD/DivX Video	NTSC	NTSC	PAL	NTSC
	PAL	NTSC	PAL	PAL
CD/MP3/WMA/JPEG no disc	—	NTSC	PAL	NTSC or PAL

## Resetting the player

Use this procedure to reset all the player's settings to the factory default.

**1 Switch the player into standby.**

**2 Using the front panel buttons, hold down the  (stop) button and press  STANDBY/ON to switch the player back on.**

All the player's settings are now reset.

## DVD-Video regions

All DVD-Video discs carry a region mark on the case somewhere that indicates which region(s) of the world the disc is compatible with. Your DVD player also has a region mark, which you can find on the rear panel. Discs from incompatible regions will not play in this player. In this case the attention sentence "Incompatible disc region number Can't play disc" is displayed on screen. Discs marked **ALL** will play in any player.

The diagram below shows the various DVD regions of the world.

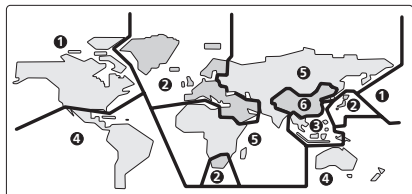

## Selecting languages using the language code list

Some of the language options (such as 'DVD Menu Lang.' in the Setup Navigator) allow you to set your preferred language from any of the 136 languages listed in the language code list on page 50.

- 1 Select 'Other Language'.**
- 2 Use the ←/→ (cursor left/right) buttons to select either a code letter or a code number.**
- 3 Use the ↑/↓ (cursor up/down) buttons to select a code letter or a code number.**  
See *Language code list* on page 50 for a complete list of languages and codes.

## HDMI troubleshooting (DV-490V)

Incorrect operation is often mistaken for trouble or malfunction. If you think that there is something wrong with this component, check the points below. Sometimes the trouble may lie in another component. Inspect the other components and electrical appliances being used. If the trouble cannot be rectified after checking the items below, ask your nearest Pioneer authorized service center or your dealer to carry out repair work.

Problem	Remedy
<b>No HDMI audio output.</b>	<ul style="list-style-type: none"> <li>• This unit has been designed to be compliant with HDMI (High Definition Multimedia Interface). Depending on the component you have connected, unreliable signal transfers may result.</li> <li>• If the front panel HDMI indicator is lit:               <ul style="list-style-type: none"> <li>– You won't hear any sound from the HDMI output if the source component is only DVI/HDCP-compatible.</li> </ul> </li> <li>• If the front panel HDMI indicator is unlit then:               <ul style="list-style-type: none"> <li>– Make sure that you've selected this player as the HDMI input in the settings for the component you're using. You may need to refer to the instruction manual of the component to do this.</li> <li>– Check that the HDMI cable is connected properly and that the cable isn't damaged.</li> <li>– Check that components connected using the HDMI interface are switched on and HDMI compatible.</li> </ul> </li> </ul>

Problem	Remedy
<b>No HDMI video output.</b>	<ul style="list-style-type: none"> <li>• Make sure that you've selected this player as the HDMI input in the settings for the component you're using. You may need to refer to the instruction manual of the component to do this.</li> <li>• Check that the HDMI cable is connected properly and that the cable isn't damaged.</li> <li>• Check that components connected using the HDMI interface are switched on and HDMI compatible.</li> <li>• This unit has been designed to be compliant with HDMI (High Definition Multimedia Interface). Depending on the component you have connected, using a DVI connection may result in unreliable signal transfers.</li> <li>• Make sure the resolution on this player matches that of the component you have connected using HDMI. See <i>HDMI Resolution</i> on page 40 to change the HDMI resolution. See <i>Resetting the output resolution to the default setting with HDMI connection</i> on page 15 if you want to reset the output resolution.</li> </ul>
<b>No multichannel HDMI audio.</b>	<ul style="list-style-type: none"> <li>• Make sure the <b>HDMI Out</b> setting is set to <b>Auto</b> (see <i>HDMI Out</i> on page 39 to do this).</li> </ul>
<b>A connected DVI component (with HDCP) doesn't work with this player.</b>	<ul style="list-style-type: none"> <li>• This unit has been designed to be compliant with HDMI (High Definition Multimedia Interface). Depending on the component you have connected, using a DVI connection may result in unreliable signal transfers.</li> </ul>



### Note

- Static electricity or other external influences may cause malfunctioning of this unit. In this case, unplug the power cord and then plug back in. This will usually reset the unit for proper operation. If this does not correct the problem, please consult your nearest Pioneer service center.

## Glossary

**Analog audio** Direct representation of sound by an electrical signal. See also *Digital audio*.

**Aspect ratio** The width of a TV screen relative to its height. Conventional TVs are 4:3; widescreen models are 16:9.

**Digital audio** Indirect representation of sound using numbers. See also *Sampling frequency* and *Analog audio*.

DivX<sup>\*1</sup>



DivX is a media technology created by DivX, Inc. DivX media files contain compressed video. DivX files can also include advanced media features like menus, subtitles, and alternate audiotracks.

Dolby  
Digital<sup>\*2</sup>



A multi-channel audio encoding system developed by Dolby Laboratories that enables far more audio to be stored on a disc than PCM encoding. See also *PCM (Pulse Code Modulation)*.



**DRM** DRM (digital rights management) copy protection is a technology designed to prevent unauthorized copying by restricting playback, etc. of compressed audio files on devices other than the PC (or other recording equipment) used to record it. For detailed information, please see the instruction manuals or help files that came with your PC and/or software.

**DTS**<sup>\*3</sup> A multi-channel audio encoding system developed by Digital Theater Systems that enables far more audio to be stored on a disc than PCM encoding. See also *PCM (Pulse Code Modulation)*.



**EXIF (Exchangeable Image File)** A file format developed by Fuji Photo Film for digital still cameras. Digital cameras from various manufacturers use this compressed file format which carries date, time and thumbnail information, as well as the picture data.

**File extension** A tag added to the end of a filename to indicate the type of file. For example, ".mp3" indicates an MP3 file.

**HDMI**<sup>\*4</sup> (DV-490V only) HDMI (High-Definition Multimedia Interface) is a high-speed digital interface which has the capability to support standard, enhanced, or high-definition video plus standard to multi-channel surround-sound audio on a single digital connection. HDMI features include uncompressed digital video, a bandwidth of up to 5 gigabytes per second and communication between the AV source and AV devices such as DTVs.

**ISO 9660 format** International standard for the volume and file structure of CD-ROM discs.

**JPEG** A standard file format used for still images. JPEG files are identified by the file extension ".jpg".

**MP3** MP3 (MPEG1 audio layer 3) is a compressed stereo audio file format. Files are recognized by their file extension ".mp3".

**MPEG audio** An audio format used on Video CD/ Super VCDs and some DVD discs.

**PBC (PlayBack Control)** A system of navigating a Video CD/ Super VCD through on-screen menus recorded onto the disc.

**PCM (Pulse Code Modulation)** Digital audio encoding system found on CDs. Good quality, but requires a lot of data compared to Dolby Digital, DTS and MPEG encoded audio. See also *Digital audio*.

**Progressive scan video** All the lines that make up a video picture are updated in one pass (compared to interlace which takes two passes to update the whole picture).

**Regions** These associate DVD-Video discs and players with particular areas of the world. See *DVD-Video regions* on page 46 for more information.

**Sampling frequency** The rate at which sound is measured to be turned into digital audio data. The higher the rate, the better the sound quality. CD is 44.1 kHz; DVD can be up to 96 kHz. See also *Digital audio*.

**WMA** WMA is short for Windows Media Audio and refers to an audio compression technology developed by Microsoft Corporation. Files are recognized by their file extension ".wma". Microsoft, Windows Media, and the Windows logo are trademarks, or registered trademarks of Microsoft Corporation in the United States and/or other countries.

<sup>\*1</sup> *DivX, DivX Certified, and associated logos are trademarks of DivX, Inc. and are used under license.*

<sup>\*2</sup> *Manufactured under license from Dolby Laboratories. "Dolby" and the double-D symbol are trademarks of Dolby Laboratories.*

<sup>\*3</sup> *"DTS" and "DTS Digital Out" are registered trademarks of Digital Theater Systems, Inc.*

<sup>\*4</sup> *HDMI, the HDMI logo and High-Definition Multimedia Interface are trademarks or registered trademarks of HDMI licensing LLC.*

## Language code list

Language (Language code letter), **Language code**

Japanese (ja), <b>1001</b>	Bhutani (dz), <b>0426</b>	Kirghiz (ky), <b>1125</b>	Sinhalese (si), <b>1909</b>
English (en), <b>0514</b>	Esperanto (eo), <b>0515</b>	Latin (la), <b>1201</b>	Slovak (sk), <b>1911</b>
French (fr), <b>0618</b>	Estonian (et), <b>0520</b>	Lingala (ln), <b>1214</b>	Slovenian (sl), <b>1912</b>
German (de), <b>0405</b>	Basque (eu), <b>0521</b>	Laothian (lo), <b>1215</b>	Samoa (sm), <b>1913</b>
Italian (it), <b>0920</b>	Persian (fa), <b>0601</b>	Lithuanian (lt), <b>1220</b>	Shona (sn), <b>1914</b>
Spanish (es), <b>0519</b>	Finnish (fi), <b>0609</b>	Latvian (lv), <b>1222</b>	Somali (so), <b>1915</b>
Chinese (zh), <b>2608</b>	Fiji (fj), <b>0610</b>	Malagasy (mg), <b>1307</b>	Albanian (sq), <b>1917</b>
Dutch (nl), <b>1412</b>	Farøese (fo), <b>0615</b>	Maori (mi), <b>1309</b>	Serbian (sr), <b>1918</b>
Portuguese (pt), <b>1620</b>	Frisian (fy), <b>0625</b>	Macedonian (mk), <b>1311</b>	Siswati (ss), <b>1919</b>
Swedish (sv), <b>1922</b>	Irish (ga), <b>0701</b>	Malayalam (ml), <b>1312</b>	Sesotho (st), <b>1920</b>
Russian (ru), <b>1821</b>	Scots-Gaelic (gd), <b>0704</b>	Mongolian (mn), <b>1314</b>	Sundanese (su), <b>1921</b>
Korean (ko), <b>1115</b>	Galician (gl), <b>0712</b>	Moldavian (mo), <b>1315</b>	Swahili (sw), <b>1923</b>
Greek (el), <b>0512</b>	Guarani (gn), <b>0714</b>	Marathi (mr), <b>1318</b>	Tamil (ta), <b>2001</b>
Afar (aa), <b>0101</b>	Gujarati (gu), <b>0721</b>	Malay (ms), <b>1319</b>	Telugu (te), <b>2005</b>
Abkhazian (ab), <b>0102</b>	Hausa (ha), <b>0801</b>	Maltese (mt), <b>1320</b>	Tajik (tg), <b>2007</b>
Afrikaans (af), <b>0106</b>	Hindi (hi), <b>0809</b>	Burmese (my), <b>1325</b>	Thai (th), <b>2008</b>
Amharic (am), <b>0113</b>	Croatian (hr), <b>0818</b>	Nauru (na), <b>1401</b>	Tigrinya (ti), <b>2009</b>
Arabic (ar), <b>0118</b>	Hungarian (hu), <b>0821</b>	Nepali (ne), <b>1405</b>	Turkmen (tk), <b>2011</b>
Assamese (as), <b>0119</b>	Armenian (hy), <b>0825</b>	Norwegian (no), <b>1415</b>	Tagalog (tl), <b>2012</b>
Aymara (ay), <b>0125</b>	Interlingua (ia), <b>0901</b>	Occitan (oc), <b>1503</b>	Setswana (tn), <b>2014</b>
Azerbaijani (az), <b>0126</b>	Interlingue (ie), <b>0905</b>	Oromo (om), <b>1513</b>	Tonga (to), <b>2015</b>
Bashkir (ba), <b>0201</b>	Inupiak (ik), <b>0911</b>	Oriya (or), <b>1518</b>	Turkish (tr), <b>2018</b>
Byelorussian (be), <b>0205</b>	Indonesian (in), <b>0914</b>	Panjabi (pa), <b>1601</b>	Tsonga (ts), <b>2019</b>
Bulgarian (bg), <b>0207</b>	Icelandic (is), <b>0919</b>	Polish (pl), <b>1612</b>	Tatar (tt), <b>2020</b>
Bihari (bh), <b>0208</b>	Hebrew (iw), <b>0923</b>	Pashto, Pushto (ps), <b>1619</b>	Twi (tw), <b>2023</b>
Bislama (bi), <b>0209</b>	Yiddish (ji), <b>1009</b>	Quechua (qu), <b>1721</b>	Ukrainian (uk), <b>2111</b>
Bengali (bn), <b>0214</b>	Javanese (jw), <b>1023</b>	Rhaeto-Romance (rm), <b>1813</b>	Urdu (ur), <b>2118</b>
Tibetan (bo), <b>0215</b>	Georgian (ka), <b>1101</b>	Kirundi (rn), <b>1814</b>	Uzbek (uz), <b>2126</b>
Breton (br), <b>0218</b>	Kazakh (kk), <b>1111</b>	Romanian (ro), <b>1815</b>	Vietnamese (vi), <b>2209</b>
Catalan (ca), <b>0301</b>	Greenlandic (kl), <b>1112</b>	Kinyarwanda (rw), <b>1823</b>	Volapük (vo), <b>2215</b>
Corsican (co), <b>0315</b>	Cambodian (km), <b>1113</b>	Sanskrit (sa), <b>1901</b>	Wolof (wo), <b>2315</b>
Czech (cs), <b>0319</b>	Kannada (kn), <b>1114</b>	Sindhi (sd), <b>1904</b>	Xhosa (xh), <b>2408</b>
Welsh (cy), <b>0325</b>	Kashmiri (ks), <b>1119</b>	Sangho (sg), <b>1907</b>	Yoruba (yo), <b>2515</b>
Danish (da), <b>0401</b>	Kurdish (ku), <b>1121</b>	Serbo-Croatian (sh), <b>1908</b>	Zulu (zu), <b>2621</b>

## Country/Area code list

Country/Area, **Country/Area code**, **Country/Area code letter**

Argentina, <b>0118</b> , <b>ar</b>	Finland, <b>0609</b> , <b>fi</b>	Malaysia, <b>1325</b> , <b>my</b>	Singapore, <b>1907</b> , <b>sg</b>
Australia, <b>0121</b> , <b>au</b>	France, <b>0618</b> , <b>fr</b>	Mexico, <b>1324</b> , <b>mx</b>	Spain, <b>0519</b> , <b>es</b>
Austria, <b>0120</b> , <b>at</b>	Germany, <b>0405</b> , <b>de</b>	Netherlands, <b>1412</b> , <b>nl</b>	Sweden, <b>1905</b> , <b>se</b>
Belgium, <b>0205</b> , <b>be</b>	Hong Kong, <b>0811</b> , <b>hk</b>	New Zealand, <b>1426</b> , <b>nz</b>	Switzerland, <b>0308</b> , <b>ch</b>
Brazil, <b>0218</b> , <b>br</b>	India, <b>0914</b> , <b>in</b>	Norway, <b>1415</b> , <b>no</b>	Taiwan, <b>2023</b> , <b>tw</b>
Canada, <b>0301</b> , <b>ca</b>	Indonesia, <b>0904</b> , <b>id</b>	Pakistan, <b>1611</b> , <b>pk</b>	Thailand, <b>2008</b> , <b>th</b>
Chile, <b>0312</b> , <b>cl</b>	Italy, <b>0920</b> , <b>it</b>	Philippines, <b>1608</b> , <b>ph</b>	United Kingdom, <b>0702</b> , <b>gb</b>
China, <b>0314</b> , <b>cn</b>	Japan, <b>1016</b> , <b>jp</b>	Portugal, <b>1620</b> , <b>pt</b>	USA, <b>2119</b> , <b>us</b>
Denmark, <b>0411</b> , <b>dk</b>	Korea, Republic of, <b>1118</b> , <b>kr</b>	Russian Federation, <b>1821</b> , <b>ru</b>	

## Specifications

### General

System	DVD player
Power requirements	AC 110–127/ 220–240 V, 50/60 Hz
Power consumption	0.7 W
Power consumption (standby)	0.7 W
	(DV-490V-S, DV-490V-K, DV-393-S)
	0.8 W
	(DV-595K-S)
Weight	1.7 kg
Dimensions	
	420 (W) mm x 49.5 (H) mm x 215.5 (D) mm
	(DV-490V-S, DV-490V-K, DV-393-S)
	420 (W) mm x 49.5 (H) mm x 221 (D) mm
	(DV-595K-S)

Operating temperature	+5 °C to +35 °C
Operating humidity	5 % to 85 %
	(no condensation)

### Component video output

Y (luminance) - Output level	1 Vp-p (75 Ω)
P <sub>B</sub> (color) - Output level	0.7 Vp-p (75 Ω)
P <sub>R</sub> (color) - Output level	0.7 Vp-p (75 Ω)
Jack	RCA

### S-video output

Y (luminance) - Output level	1 Vp-p (75 Ω)
C (color) - Output level	286 mVp-p (75 Ω)
Jack	S-video

### Video output

Output level	1 Vp-p (75 Ω)
Jack	RCA

### Audio output (1 stereo pair)

Output level	During audio output
	200 mVrms (1 kHz, -20 dB)
Number of channels	2
Jacks	RCA

### HDMI output (DV-490V)

HDMI output	19 pin
-------------	--------

### Digital audio characteristics

Frequency response	4 Hz to 44 kHz
	(DVD fs: 96 kHz)
S/N ratio	115 dB
Dynamic range	.88 dB
Total harmonic distortion	0.0065 %
Wow and flutter	Limit of measurement
	(±0.001 % W. PEAK) or lower

### Digital output

Coaxial digital output	RCA jack
Optical digital output	Optical digital jack

### Accessories

Audio/video cable	1
Power cable	
	Central American, South American and
	Taiwan model
	Others
Remote control	1
AA/R6P dry cell batteries	2
Front panel button names sticker	
(Singapore/Taiwan models only)	1
Remote control overlay	
(Singapore/Taiwan models only)	1
Operating Instructions	

*The specifications and design of this product are subject to change without notice, due to improvement.*



J2I81701B SH 06/04

Published by Pioneer Corporation.  
Copyright © 2006 Pioneer Corporation.  
All rights reserved.

---

## **PIONEER CORPORATION**

4-1, Meguro 1-Chome, Meguro-ku, Tokyo 153-8654, Japan

### **PIONEER ELECTRONICS (USA) INC.**

P.O. BOX 1540, Long Beach, California 90810-1540, U.S.A. TEL: (800) 421-1404

### **PIONEER ELECTRONICS OF CANADA, INC.**

300 Allstate Parkway, Markham, Ontario L3R OP2, Canada TEL: 1-877-283-5901

### **PIONEER EUROPE NV**

Haven 1087, Keetberglaan 1, B-9120 Melsele, Belgium TEL: 03/570.05.11

### **PIONEER ELECTRONICS ASIACENTRE PTE. LTD.**

253 Alexandra Road, #04-01, Singapore 159936 TEL: 65-6472-7555

### **PIONEER ELECTRONICS AUSTRALIA PTY. LTD.**

178-184 Boundary Road, Braeside, Victoria 3195, Australia, TEL: (03) 9586-6300

### **PIONEER ELECTRONICS DE MEXICO S.A. DE C.V.**

Blvd.Manuel Avila Camacho 138 10 piso Col.Lomas de Chapultepec, Mexico,D.F. 11000 TEL: 55-9178-4270

K002\_A\_En