

Pioneer *sound.vision.soul*

DVD Player

DV-400V-S

DV-400V-K

DVD
VIDEO™

COMPACT
disc
DIGITAL AUDIO

COMPACT
disc
DIGITAL AUDIO

Register Your Product at

<http://www.pioneerelectronics.com> (US)

<http://www.pioneerelectronics.ca> (Canada)

HDMI™
HIGH-DEFINITION MULTIMEDIA INTERFACE

RW
COMPATIBLE

Operating Instructions

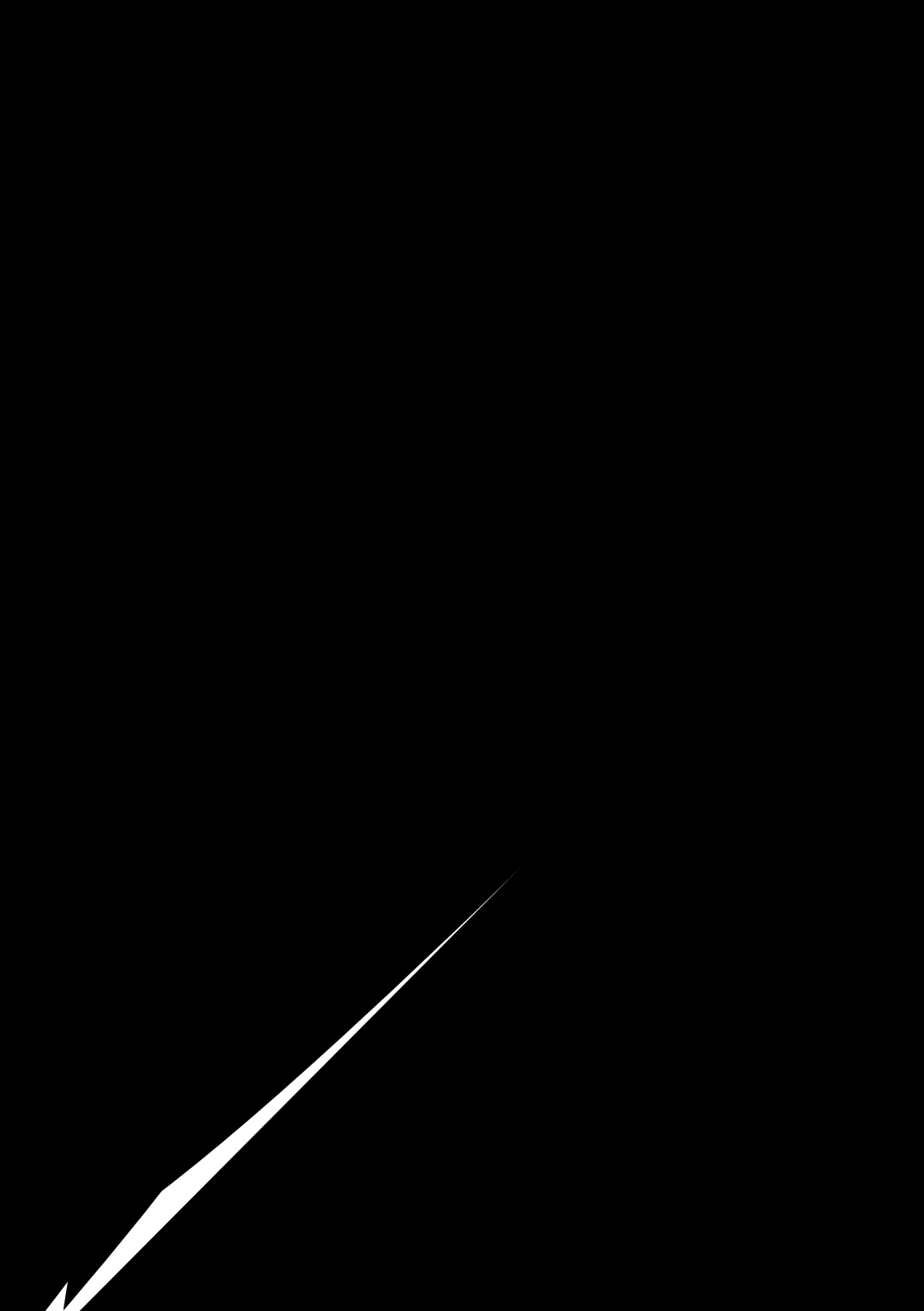

IMPORTANT SAFETY INSTRUCTIONS

READ INSTRUCTIONS — All the safety and operating instructions should be read before the product is operated.

RETAIN INSTRUCTIONS — The safety and operating instructions should be retained for future reference.

HEED WARNINGS — All warnings on the product and in the operating instructions should be adhered to.

FOLLOW INSTRUCTIONS — All operating and use instructions should be followed.

CLEANING — The product should be cleaned only with a polishing cloth or a soft dry cloth. Never clean with furniture wax, benzene, insecticides or other volatile liquids since they may corrode the cabinet.

ATTACHMENTS — Do not use attachments not recommended by the product manufacturer as they may cause hazards.

WATER AND MOISTURE — Do not use this product near water — for example, near a bathtub, wash bowl, kitchen sink, or laundry tub; in a wet basement; or near a swimming pool; and the like.

ACCESSORIES — Do not place this product on an unstable cart, stand, tripod, bracket, or table. The product may fall, causing serious injury to a child or adult, and serious damage to the product. Use only with a cart, stand, tripod, bracket, or table recommended by the manufacturer, or sold with the product. Any mounting of the product should follow the manufacturer's instructions, and should use a mounting accessory recommended by the manufacturer.

CART — A product and cart combination should be moved with care. Quick stops, excessive force, and uneven surfaces may cause the product and cart combination to overturn.



VENTILATION — Slots and openings in the cabinet are provided for ventilation and to ensure reliable operation of the product and to protect it from overheating, and these openings must not be blocked or covered. The openings should never be blocked by placing the product on a bed, sofa, rug, or other similar surface. This product should not be placed in a built-in installation such as a bookcase or rack unless proper ventilation is provided or the manufacturer's instructions have been adhered to.

POWER SOURCES — This product should be operated only from the type of power source indicated on the marking label. If you are not sure of the type of power supply to your home, consult your product dealer or local power company.

LOCATION — The appliance should be installed in a stable location.

NONUSE PERIODS — The power cord of the appliance should be unplugged from the outlet when left un-used for a long period of time.

GROUNDING OR POLARIZATION

- If this product is equipped with a polarized alternating current line plug (a plug having one blade wider than the other), it will fit into the outlet only one way. This is a safety feature. If you are unable to insert the plug fully into the outlet, try reversing the plug. If the plug should still fail to fit, contact your electrician to replace your obsolete outlet. Do not defeat the safety purpose of the polarized plug.

- If this product is equipped with a three-wire grounding type plug, a plug having a third (grounding) pin, it will only fit into a grounding type power outlet. This is a safety feature. If you are unable to insert the plug into the outlet, contact your electrician to replace your obsolete outlet. Do not defeat the safety purpose of the grounding type plug.

POWER-CORD PROTECTION — Power-supply cords should be routed so that they are not likely to be walked on or pinched by items placed upon or against them, paying particular attention to cords at plugs, convenience receptacles, and the point where they exit from the product.

OUTDOOR ANTENNA GROUNDING — If an outside antenna or cable system is connected to the product, be sure the antenna or cable system is grounded so as to provide some protection against voltage surges and built-up static charges. Article 810 of the National Electrical Code, ANSI/NFPA 70, provides information with regard to proper grounding of the lead-in wire to an antenna discharge unit, size of grounding conductors, location of antenna-discharge unit, connection to grounding electrode, and requirements for the grounding electrode. See Figure A.

LIGHTNING — For added protection for this product during a lightning storm, or when it is left unattended and unused for long periods of time, unplug it from the wall outlet and disconnect the antenna or cable system. This will prevent damage to the product due to lightning and power-line surges.

POWER LINES — An outside antenna system should not be located in the vicinity of overhead power lines or other electric light or power circuits, or where it can fall into such power lines or circuits. When installing an outside antenna system, extreme care should be taken to keep from touching such power lines or circuits as contact with them might be fatal.

OVERLOADING — Do not overload wall outlets, extension cords, or integral convenience receptacles as this can result in a risk of fire or electric shock.

OBJECT AND LIQUID ENTRY — Never push objects of any kind into this product through openings as they may touch dangerous voltage points or short-out parts that could result in a fire or electric shock. Never spill liquid of any kind on the product.

SERVICING — Do not attempt to service this product yourself as opening or removing covers may expose you to dangerous voltage or other hazards. Refer all servicing to qualified service personnel.

DAMAGE REQUIRING SERVICE — Unplug this product from the wall outlet and refer servicing to qualified service personnel under the following conditions:

- When the power-supply cord or plug is damaged.
- If liquid has been spilled, or objects have fallen into the product.
- If the product has been exposed to rain or water.
- If the product does not operate normally by following the operating instructions. Adjust only those controls that are covered by the operating instructions as an improper adjustment of other controls may result in damage and will often require extensive work by a qualified technician to restore the product to its normal operation.
- If the product has been dropped or damaged in any way.
- When the product exhibits a distinct change in performance — this indicates a need for service.

REPLACEMENT PARTS — When replacement parts are required, be sure the service technician has used replacement parts specified by the manufacturer or have the same characteristics as the original part. Unauthorized substitutions may result in fire, electric shock, or other hazards.

SAFETY CHECK — Upon completion of any service or repairs to this product, ask the service technician to perform safety checks to determine that the product is in proper operating condition.

WALL OR CEILING MOUNTING — The product should not be mounted to a wall or ceiling.

HEAT — The product should be situated away from heat sources such as radiators, heat registers, stoves, or other products (including amplifiers) that produce heat.

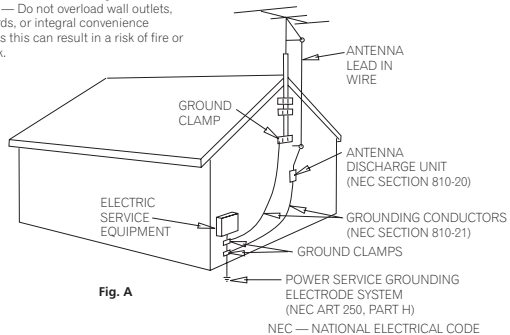

Fig. A

D1-4-2-2_En

This Class B digital apparatus complies with Canadian ICES-003.

Cet appareil numérique de la Classe B est conforme à la norme NMB-003 du Canada.

DB-10-1-3_EF

CAUTION: This product satisfies FCC regulations when shielded cables and connectors are used to connect the unit to other equipment. To prevent electromagnetic interference with electric appliances such as radios and televisions, use shielded cables and connectors for connections.

DB-10-3a_En



Contents

01 Before you start

Features	6
What's in the box	7
Hints on installation	7
Disc/content format playback compatibility	8

02 Connections

Easy connections	11
Important	11
Connecting using the S-video output	12
Connecting using the component video output	12
Connecting to an AV receiver	13
Connecting using HDMI	14
About HDMI	15

03 Controls and displays

Front panel	16
Remote control	17

04 Getting started

Switching on	18
Using the on-screen displays	18
Setting up the player for your TV	19
Setting the language of this player's on-screen displays	19
Playing discs	20

05 Playing discs

Scanning discs	24
Playing in slow motion	24
Frame advance/frame reverse	24
Viewing a JPEG slideshow	25
Browsing DVD or Video CD/ disc with the Disc Navigator	25
Browsing WMA, MP3, MPEG-4 AAC, DivX video, WMV and JPEG files with the Disc Navigator	26
Looping a section of a disc	27
Using repeat play	27
Using random play	27
Creating a program list	28
Searching a disc	29

Switching subtitles	29
Switching audio language/channels	30
Zooming the screen	30
Switching camera angles	30
Displaying disc information	30

06 USB playback

Using the USB interface	31
-----------------------------------	----

07 Audio Settings and Video Adjust menus

Audio Settings menu	32
Video Adjust menu	33

08 Initial Settings menu

Using the Initial Settings menu	34
Digital Audio Out settings	35
Video Output settings	35
Language settings	36
Display settings	37
Options settings	38
Parental Lock	38
About the HDMI audio output settings	41

09 Additional information

Taking care of your player and discs	42
Screen sizes and disc formats	43
Resetting the player	43
DVD-Video regions	44
Selecting languages using the language code list	44
Troubleshooting	44
Glossary	48
Language code list	50
Country/Area code list	50
Specifications	51

Chapter 1

Before you start

Features

- **24-bit/96 kHz compatible DAC**

The integrated 24-bit/96 kHz DAC means that this player is compatible with high sampling-rate discs, capable of delivering exceptional sound quality in terms of dynamic range, low-level resolution and high-frequency detail.

- **Excellent audio performance surround sound entertainment with Dolby Digital¹ and DTS² software**



When connected to a suitable AV amplifier or receiver, this player gives great surround sound with Dolby Digital and DTS discs.

- **HDMI³ digital interface**

The HDMI (High Definition Multimedia Interface) interconnect provides high quality digital audio and video, all from a single user-friendly connector. HDMI is the first consumer electronics interface to support uncompressed standard, enhanced, or high-definition video plus standard to multi-channel surround sound audio, all using one interface. You can easily connect to a HDMI-equipped AV receiver or audiovisual device for high quality audio and video, and communication between the video source and (DTV) players, set-top boxes, and other audiovisual devices is also supported.

- **PureCinema Progressive Scan video**

When connected to a progressive scan-compatible TV or monitor using the component video outputs, you can enjoy extremely stable, flicker free images, with the same frame refresh rate as the original movie.

- **New Disc Navigator with moving pictures**

The new Disc Navigator enables you play the first few seconds of each title or chapter in a thumbnail image on screen.

- **DSP effects for enhanced playback**

See *Audio Settings and Video Adjust menus* on page 32.

- **Picture zoom**

See *Zooming the screen* on page 30.

- **MP3, WMA and MPEG-4 AAC compatibility**

See *Compressed audio compatibility* on page 9.

- **JPEG compatibility**

See *JPEG file compatibility* on page 10.

- **DivX^{®4} video compatibility**



See *DivX video compatibility* on page 10.

- **WMV compatibility**

See *CD-R/-RW compatibility* on page 8 or *About WMV* on page 10.

1. Manufactured under license from Dolby Laboratories. "Dolby", "Pro Logic", and the double-D symbol are trademarks of Dolby Laboratories.

2. "DTS" is a registered trademark of DTS, Inc. and "DTS 2.0+ Digital Out" is a trademark of DTS, Inc.

3. HDMI, the HDMI logo and High-Definition Multimedia Interface are trademarks or registered trademarks of HDMI licensing LLC.

4. DivX, DivX Certified, and associated logos are trademarks of DivX, Inc. and are used under license.

• Energy saving design

An auto power-off function switches the player into standby if not used for about 30 minutes.

What's in the box

Please confirm that the following accessories are in the box when you open it.

- Remote control
- AA/R6P dry cell batteries x 2
- Audio/video cable (red/white/yellow plugs)
- Warranty card
- Operating instructions

Putting the batteries in the remote

• Open the battery compartment cover and insert the batteries as shown.

Use two AA/R6P batteries and follow the indications (⊕, ⊖) inside the compartment. Close the cover when you're finished.

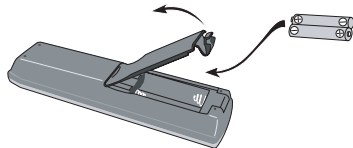

Important

Incorrect use of batteries can result in hazards such as leakage and bursting. Please observe the following:

- Don't mix new and old batteries together.
- Don't use different kinds of battery together—although they may look similar, different batteries may have different voltages.
- Make sure that the plus and minus ends of each battery match the indications in the battery compartment.
- Remove batteries from equipment that isn't going to be used for a month or more.

- When disposing of used batteries, please comply with governmental regulations or environmental public instruction's rules that apply in your country/area.
- Do not use or store batteries in direct sunlight or other excessively hot place, such as inside a car or near a heater. This can cause batteries to leak, overheat, explode or catch fire. It can also reduce the life or performance of batteries.

Hints on installation

We want you to enjoy using this product for years to come, so please use the following guidelines when choosing a suitable location:

Do...

- Use in a well-ventilated room.
- Place on a solid, flat, level surface, such as a table, shelf or stereo rack.

Don't...

- Use in a place exposed to high temperatures or humidity, including near radiators and other heat-generating appliances.
- Place on a window sill or a place where the player will be exposed to direct sunlight.
- Use in an excessively dusty or damp environment.
- Place directly on top of an amplifier, or other component in your stereo system that becomes hot in use.
- Use near a television or monitor as you may experience interference—especially if the television uses an indoor antenna.
- Use in a kitchen or other room where the player may be exposed to smoke or steam.
- Use on a thick rug or carpet, or cover with cloth—this may prevent proper cooling of the unit.
- Place on an unstable surface, or one that is not large enough to support all four of the unit's feet.



DVD-R/-RW compatibility

- Compatible formats: DVD-Video, Video Recording (VR)*
** Edit points may not play exactly as edited; screen may go momentarily blank at edited points.*
- Unfinalized playback: No
- MP3/WMA/MPEG-4 AAC/JPEG or DivX video/WMV file playback on DVD-R/-RW: No

Compressed audio compatibility

- Compatible formats: MPEG-1 Audio Layer 3 (MP3), Windows Media Audio (WMA), MPEG-4 AAC
- Sampling rates: 32 kHz, 44.1 kHz or 48 kHz
- Bit-rates: Any (128 kbps or higher recommended)
- VBR (variable bit rate) MP3/WMA/MPEG-4 AAC playback: No
- WMA lossless encoding compatible: No
- DRM (Digital Rights Management) compatible: No (DRM-protected audio files will *not* play in this player—see also *DRM* in the *Glossary* on page 48)
- File extensions: .mp3, .wma, .m4a (these must be used for the player to recognize MP3, WMA and MPEG-4 AAC files – do not use for other file types)

About MPEG-4 AAC

Advanced Audio Coding (AAC) is at the core of the MPEG-4 AAC standard, which incorporates MPEG-2 AAC, forming the basis of the MPEG-4 audio compression technology. The file format and extension used depend on the application used to encode the AAC file. This unit plays back AAC files encoded by iTunes® bearing the extension '.m4a'. DRM-protected files will not play, and files encoded with some versions of iTunes® may not play, or filenames may display incorrectly.

Apple and iTunes are trademarks of Apple Computer, Inc., registered in the U.S. and other countries.

WMA (Windows Media™ Audio) compatibility

This player can playback Windows Media Audio content.

WMA is an acronym for Windows Media Audio and refers to an audio compression technology developed by Microsoft Corporation. WMA content can be encoded by using Windows Media Player for Windows XP, Windows Media Player 9 or Windows Media Player 10 series.

Windows Media is a trademark of Microsoft Corporation.

This product includes technology owned by Microsoft Corporation and cannot be used or distributed without a license from Microsoft Licensing, Inc.

About DivX video

DivX is a digital video format created by DivX, Inc. This player can play DivX videos burned on CD-R/-RW/-ROM discs. Keeping the same terminology as DVD-Video, individual DivX video files are called "Titles". When naming files/titles on a CD-R/-RW disc prior to burning, keep in mind that by default they will be played in alphabetical order.

Displaying external subtitle files

The font sets listed below are available for external subtitle files. You can see the proper font set on-screen by setting the **Subtitle Language** (in *Language settings* on page 36) to match the subtitle file.

This player supports the following language groups:

Group 1	Albanian (sq), Basque (eu), Catalan (ca), Danish (da), Dutch (nl), English (en), Faroese (fo), Finnish (fi), French (fr), German (de), Icelandic (is), Irish (ga), Italian (it), Norwegian (no), Portuguese (pt), Rhaeto-Romanic (rm), Scottish (gd), Spanish (es), Swedish (sv)
Group 2	Albanian (sq), Croatian (hr), Czech (cs), Hungarian (hu), Polish (pl), Romanian (ro), Slovak (sk), Slovenian (sl)
Group 3	Bulgarian (bg), Byelorussian (be), Macedonian (mk), Russian (ru), Serbian (sr), Ukrainian (uk)
Group 4	Hebrew (iw), Yiddish (ji)
Group 5	Turkish (tr)

- Some external subtitle files may be displayed incorrectly or not at all.
- For external subtitle files the following subtitle format filename extensions are supported (please note that these files are not shown within the disc navigation menu): .srt, .sub, .ssa, .smi
- The filename of the movie file has to be repeated at the beginning of the filename for the external subtitle file.
- The number of external subtitle files which can be switched for the same movie file is limited to a maximum of 10.

DivX video compatibility

- Official DivX[®] Certified product.
- Plays all versions of DivX[®] video (including DivX[®] 6) with standard playback of DivX[®] media files.

- File extensions: .avi and .divx (these must be used for the player to recognize DivX video files). *Note that all files with the .avi extension are recognized as MPEG4, but not all of these are necessarily DivX video files and therefore may not be playable on this player.*

About WMV

WMV is an acronym for Windows Media Video and refers to a video compression technology developed by Microsoft Corporation. WMV content can be encoded by using Windows Media[®] Encoder.

- This player is compatible with WMV9 files that are encoded by using the Windows Media[®] Encoder 9 Series, with .wmv as an extension.
- Compatible with size under 720 x 480 pixels.
- Advanced Profile is not supported.
- DRM-protected video files will not play in this player.

JPEG file compatibility

- Compatible formats: Baseline JPEG and EXIF 2.2* still image files up to a resolution of 3072 x 2048.
**File format used by digital still cameras.*
- Progressive JPEG compatible: No
- File extensions: .jpg (must be used for the player to recognize JPEG files – do not use for other file types)

PC-created disc compatibility

Discs recorded using a personal computer may not be playable in this unit due to the setting of the application software used to create the disc. In these particular instances, check with the software publisher for more detailed information.

Discs recorded in packet write mode (UDF format) are not compatible with this player.

Check the DVD-R/-RW or CD-R/-RW software disc boxes for additional compatibility information.

Chapter 2

Connections

Easy connections



Important

- Before making or changing any connections, switch off the power and disconnect the power cable from the AC outlet.
- The setup described here is a basic setup that allows you to play discs using just the cables supplied with the player. In this setup, stereo audio is played through the speakers in your TV.
- This player is equipped with copy protection technology. Do not connect this player to your TV via a VCR using audio/video or S-video cables, as the picture from this player will not appear properly on your TV. (This player may also not be compatible with some combination TV/VCRs for the same reason; refer to the manufacturer for more information.)

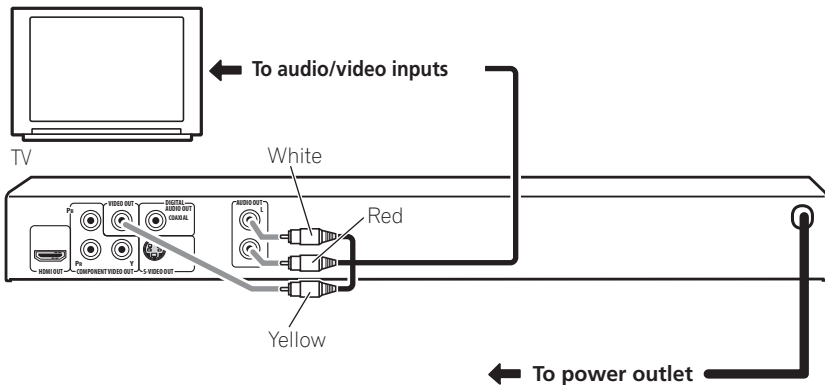

1 Connect the VIDEO OUT and AUDIO OUT L/R jacks to a set of A/V inputs on your TV.

Use the supplied audio/video cable, connecting the red and white plugs to the audio outputs and the yellow plug to the video output. Make sure you match up the left and right audio outputs with their corresponding inputs for correct stereo sound.

See below if you want to use a component or S-video for the video connection.

2 Plug into a power outlet.



Note

- Before unplugging the player from the power outlet, make sure you first switch it into standby using either the front panel **STANDBY/ON** button, or the remote control, and wait of the **-OFF-** message to disappear from the player's display.
- For the above reasons, do not plug this player into a switched power supply found on some amplifiers and AV receivers.

Using the S-video

Equipment) has an S-video output. Use the S-video output on the standard (composite) quality picture.

Use a component video cable (not supplied) to connect the VIDEO OUT to an S-video (or monitor or AV

triangle above the jack with the plug before plugging in.

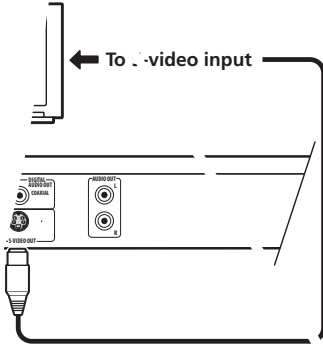

Connecting using the component video output

You can use the component video output instead of the standard video out jack to connect this player to your TV (or other equipment). This should give you the best quality picture from the three types of video output available.

- Use a component video cable (not supplied) to connect the COMPONENT VIDEO OUT jacks to a component video input on your TV, monitor or AV receiver.

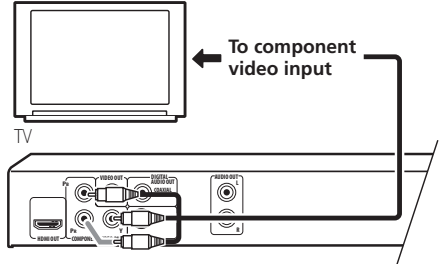

Watching progressive scan video from the component video output

This player can output progressive scan video from the component video output. Compared to interlace video, progressive scan effectively doubles the scanning of the picture, resulting in a very flicker-free image.

To set up the player for progressive scan TV, see *Viewing progressive scan video* on page 35. When the player outputs progressive scan video, the lights in the front panel will blink.



Important

- If you connect a TV that is not compatible with a progressive scan signal and switch the player to progressive, you will not be able to see any picture at all. In this case, switch everything off and reconnect using the supplied video cable (see *Easy connections* on page 11), then switch back to **Interlace** (see below).

Switching the video output to interlace using the front panel controls

Switch the player to standby then, using the front panel controls, press **STANDBY/ON** while pressing **◀◀** to switch the player back to **Interlace**.

- If the player is connected using HDMI, disconnect the HDMI cable before resetting the player to interlace output. (If left connected, the HDMI output resolution will be reset to its default—see *Resetting the output resolution to the default setting with HDMI connection* on page 15.)

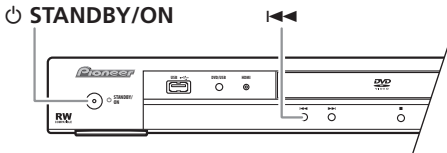

Connecting to an AV receiver

To enjoy multichannel surround sound you need to connect this player to an AV receiver using the digital audio output.

In addition to a digital connection, we recommend also connecting using the stereo analog connection.

You'll probably also want to connect a video output to your AV receiver. You can use any of the video outputs available on this player (the illustration shows a standard (composite) connection).

1 Connect the **DIGITAL AUDIO OUT COAXIAL** jack on this player to a coaxial digital input on your AV receiver.

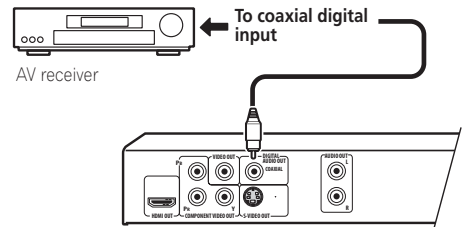

Use a coaxial cable (similar to the supplied video cable) to connect the **DIGITAL AUDIO OUT COAXIAL** jack to a coaxial input on your AV receiver.

2 Connect the analog **AUDIO OUT L/R** and **VIDEO OUT** jacks on this player to a set of analog audio/video inputs on your AV receiver.

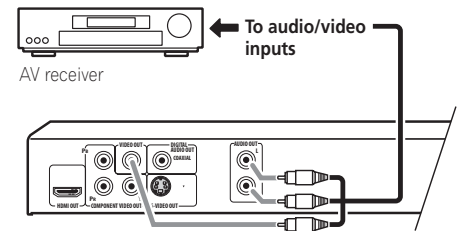

You can use the S-video or component video jacks to connect to the AV receiver if you prefer.

Connecting using HDMI

If you have a HDMI equipped monitor or display, you can connect it to this player using a commercially available HDMI cable.

The HDMI connector outputs uncompressed digital video, as well as almost every kind of digital audio that the player is compatible with, including DVD-Video, Video CD/, CD, WMA, MP3, MPEG-4 AAC, DivX video and WMV.

- **Use an HDMI cable to connect the HDMI OUT interconnect on this player to an HDMI interconnect on a HDMI-compatible monitor.**

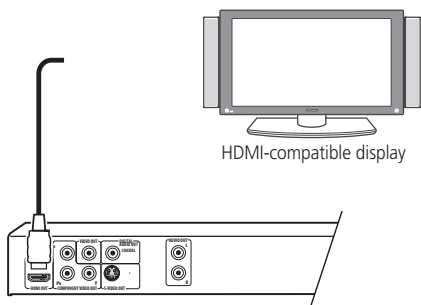

The arrow on the cable connector body should be face up for correct alignment with the connector on the player.

Note

- This unit has been designed to be compliant with HDMI (High Definition Multimedia Interface). Depending on the component you have connected, using a DVI connection may result in unreliable signal transfers.
- When you change the component connected to the HDMI output, you will also need to change the HDMI settings to match the new component (see *HDMI Out* on page 35, *HDMI Resolution* on page 36 and *HDMI Color* on page 36 to do this). However, the settings for each component are then stored in memory (for up to 2 components).
- The HDMI connection is compatible with 44.1 kHz/48 kHz, 16 bit/20 bit/24 bit 2 channel linear PCM signals, as well as Doly Digital, DTS and MPEG audio bitstream.

About HDMI

HDMI (High Definition Multimedia Interface) supports both video and audio on a single digital connection for use with DVD players, DTV, set-top boxes, and other AV devices.

HDMI was developed to provide the technologies of High Bandwidth Digital Content Protection (HDCP) as well as Digital Visual Interface (DVI) in one specification. HDCP is used to protect digital content transmitted and received by DVI-compliant displays.

HDMI has the capability to support standard, enhanced, or high-definition video plus standard to multi-channel surround-sound audio. HDMI features include uncompressed digital video, a bandwidth of up to five gigabytes per second (with HDTV signals), one connector (instead of several cables and connectors), and communication between the AV source and AV devices such as DTVs.

Resetting the output resolution to the default setting with HDMI connection

Switch the player to standby then, using the front panel controls, press **STANDBY/ON** while pressing **RECALL** to switch the player back to **480P**.

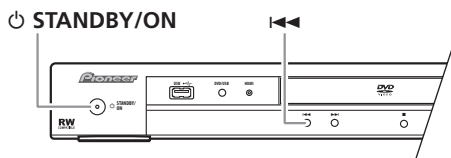

Chapter 3

Controls and displays

Front panel

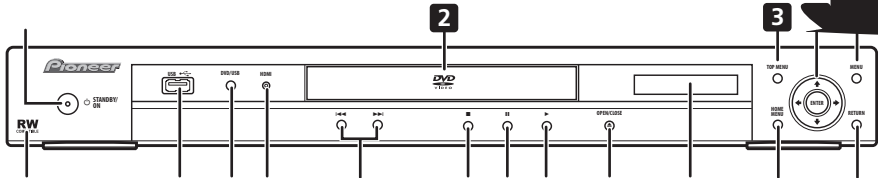

1 **STANDBY/ON** (page 18)

2 **Disc tray**

3 **TOP MENU** (page 22)

4 **ENTER & cursor buttons** (page 18)

5 **MENU** (page 22)

6 **RETURN** (page 22)

7 **HOME MENU** (page 18)

8 **Display**

9 **▲ OPEN/CLOSE** (page 20)

10 **▶** (page 21)

11 **||** (page 21)

12 **■** (page 21)

13 **◀◀ and ▶▶** (page 21)

14 **HDMI indicator**

Lights when this player is recognized by another HDMI or DVI/HDCP compatible component.

15 **DVD/USB** (page 31)

16 **USB port (Type A)** (page 31)

17 **RW Compatible** (page 8)

Remote control

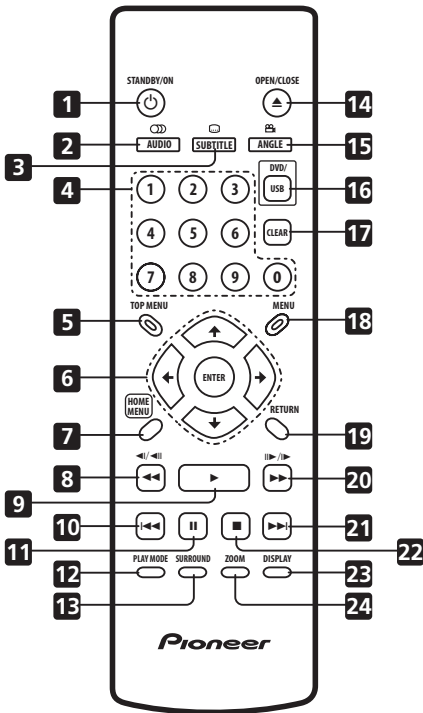

- 1 **⏻ STANDBY/ON** (page 18)
- 2 **AUDIO** (page 30)
- 3 **SUBTITLE** (page 29)
- 4 **Number buttons** (page 21)
- 5 **TOP MENU** (page 22)
- 6 **ENTER & cursor buttons** (page 18)
- 7 **HOME MENU** (page 18)
- 8 **◀◀ and ◀|◀** (page 21, 24)
- 9 **▶** (page 21)
- 10 **◀◀** (page 21)
- 11 **⏸** (page 21)
- 12 **▶ PLAY MODE** (page 27)
- 13 **SURROUND** (page 32)

- 14 **▲ OPEN/CLOSE** (page 20)
- 15 **ANGLE** (page 30)
- 16 **DVD/USB** (page 31)
- 17 **CLEAR** (page 29)
- 18 **MENU** (page 22)
- 19 **RETURN** (page 18)
- 20 **▶▶ and ⏸/▶** (page 21, 24)
- 21 **▶▶|** (page 21)
- 22 **■** (page 21)
- 23 **DISPLAY** (page 30)
- 24 **ZOOM** (page 30)

Using the remote control

Keep in mind the following when using the remote control:

- Make sure that there are no obstacles between the remote and the remote sensor on the unit.
- The remote has a range of about 7 m (23 ft.).
- Remote operation may become unreliable if strong sunlight or fluorescent light is shining on the unit's remote sensor.
- Remote controllers for different devices can interfere with each other. Avoid using remotes for other equipment located close to this unit.
- Replace the batteries when you notice a fall off in the operating range of the remote.

Chapter 4

Getting started

Switching on

After making sure that everything is connected properly and that the player is plugged in, press **STANDBY/ON** on the front panel or remote control to switch the player on.

Also, switch on your TV and make sure that it is set to the input you connected the DVD player to.

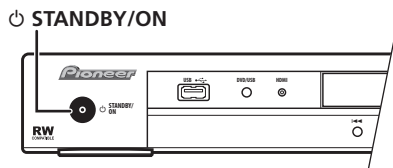

FAQ

- My DVD player switches on but there is nothing displayed on my TV.

Make sure that the TV is set to the correct video input (not a TV channel). For example, if you connected this player to the **VIDEO 1** inputs on your TV, switch your TV to **VIDEO 1**.

Note

- This player features a screen saver and an auto power off function. If the player is stopped and no button is pressed for around five minutes, the screen saver starts. If the disc tray is closed but no disc is playing and no control is pressed for about 30 minutes, the player automatically goes into standby.

Using the on-screen displays

For ease of use, this player makes extensive use of graphical on-screen displays (OSDs). All the screens are navigated in basically the same way, using the cursor buttons (**↑/↓/←/→**) to change the highlighted item and pressing **ENTER** to select it.

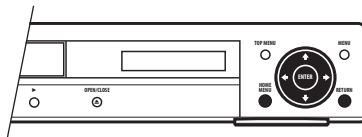
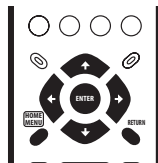

Button	What it does
HOME MENU	Display/exit the on-screen display.
↑/↓/←/→	Changes the highlighted menu item.
ENTER	Selects the highlighted menu item (both ENTER buttons on the remote work in exactly the same way).
RETURN	Returns to the main menu without saving changes.

Note

- From here on in this manual, the word 'select' generally means use the cursor buttons to highlight an item on-screen, then press **ENTER**.

Setting up the player for your TV

If you have a widescreen (16:9) TV, you should setup the player so that the picture will be presented correctly. If you have a conventional (4:3) TV, you can leave the player on the default setting and move on to the next section.

1 Press HOME MENU and select 'Initial Settings'.



2 Select 'TV Screen' from the 'Video Output' settings.

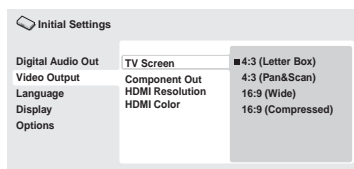

3 If you have a widescreen (16:9) TV, select '16:9 (Wide)' or '16:9 (Compressed)'.

If you have a conventional (4:3) TV, you can change the setting from **4:3 (Letter Box)** to **4:3 (Pan & Scan)** if you prefer. See *Video Output settings* on page 35 for more details.

4 Press HOME MENU to exit the menu screen.

Setting the language of this player's on-screen displays

This sets the language of the player's on-screen displays.

1 Press HOME MENU and select 'Initial Settings'.

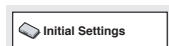

2 Select 'OSD Language' from the 'Display' settings.

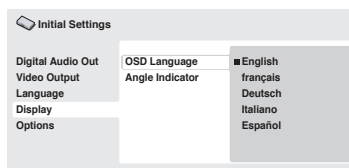

3 Select a language.

The on-screen language will change according to your selection.

4 Press HOME MENU to exit the menu screen.

Playing discs

The basic playback controls for playing DVD, CD, Video CD, DivX video/WMV and MP3/WMA/MPEG-4 AAC discs are covered here. Further functions are detailed in the next chapter.

For details on playing JPEG picture discs, see *Viewing a JPEG slideshow* on page 25.



Important

- Throughout this manual, the term 'DVD' means DVD-Video and DVD-R/-RW. If a function is specific to a particular kind of DVD disc, it is specified.

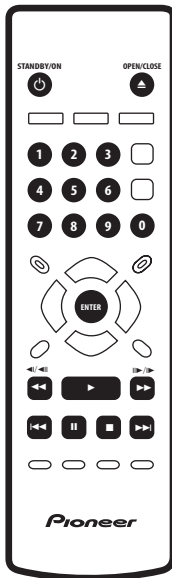

1 If the player isn't already on, press **STANDBY/ON** to switch it on.

If you're playing a DVD, disc containing DivX video/WMV files or Video CD, also turn on your TV and make sure that it is set to the correct video input.

2 Press **OPEN/CLOSE** to open the disc tray.

3 Load a disc.

Load a disc with the label side facing up, using the disc tray guide to align the disc (if you're loading a double-sided DVD disc, load it with the side you want to play face down).

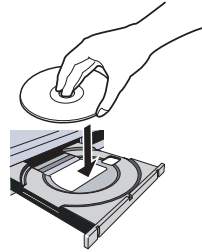

4 Press **(play)** to start playback.

If you're playing a DVD or Video CD, an on-screen menu may appear. See *DVD-Video and DivX disc menus* on page 22 and *Video CD PBC menus* on page 22 for more on how to navigate these.

- If you're playing a containing DivX video/WMV files or MP3/WMA/MPEG-4 AAC audio files, it may take a few seconds before playback starts, etc. This is normal.
- Please see *Disc/content format playback compatibility* on page 8 if you want to play a DualDisc (DVD/CD hybrid disc).











Note

- You may find with some DVD discs that some playback controls don't work in certain parts of the disc. This is not a malfunction.
- If a disc contains a mixture of movie (DivX video/WMV) and other media file types (MP3, for example), first select whether to play the movie files (**DivX/WMV**) or the other media file types (**MP3/WMA/MPEG-4 AAC/JPEG**) from the on-screen display.

Basic playback controls

The table below shows the basic controls on the remote for playing discs. The following chapter covers other playback features in more detail.

Button	What it does
	Starts playback. If the display shows RESUME or LAST MEM playback starts from the resume or last memory point (see also <i>Resume and Last Memory</i> below.)
	Pauses a disc that's playing, or restarts a paused disc.
	Stops playback. See also <i>Resume and Last Memory</i> below.
 (remote only)	Press to start fast reverse scanning. Press  (play) to resume normal playback.
 (remote only)	Press to start fast forward scanning. Press  (play) to resume normal playback.
	Skips to the start of the current track, title or chapter, then to previous tracks/titles/chapters.
	Skips to the next track, title or chapter.
Numbers (remote only)	Use to enter a title/chapter/track number. Press ENTER to select. <ul style="list-style-type: none"> • If the disc is stopped, playback starts from the selected title (for DVD), or track (for CD/Video CD). • If the disc is playing, playback jumps to the start of the selected title (VR mode DVD-RW), chapter (DVD-Video) or track (CD/Video CD).

Resume and Last Memory

When you stop playback of a DVD, CD, or Video CD or DivX video/WMV discs, **RESUME** is shown in the display indicating that you can resume playback again from that point.

If the disc tray is not opened, the next time you start playback the display shows **RESUME** and playback resumes from the resume point. (If you want to clear the resume point, press  (stop) while **RESUME** is displayed.)

With DVDs and Video CDs, if you take the disc out of the player after stopping playback, the last play position is stored in memory. If the next disc you load is the same one, the display shows **LAST MEM** and playback will resume. For DVD-Video discs, the player stores the play position of the last five discs. When one of these discs is next loaded, you can resume playback.

Note

- The Last Memory function doesn't work with VR format DVD-R/-RW.
- If you don't need the Last Memory function when you stop a disc, you can press  **OPEN/CLOSE** to stop playback and open the disc tray.

DVD-Video and DivX disc menus

Some DivX media files and many DVD-Video discs feature menus from which you can select what you want to watch. They may also give access to additional features, such as subtitle and audio language selection, or special features such as slideshows. See the disc packaging for details.

Sometimes DivX and DVD-Video menus are displayed automatically when you start playback; others only appear when you press **MENU** or **TOP MENU**.

Video CD PBC menu

Some Video CD discs feature a menu called PBC (Play Back Control).

You can play back a video clip using a remote control. You can also navigate through the menu using a remote control.

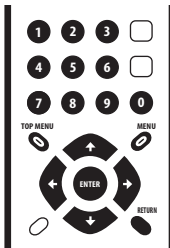

Button	What it does
TOP MENU	Displays the 'top' menu from the disc—this varies by disc.
MENU	Displays a DVD-Video disc's menu (if available) or a DivX media file's menu (if available). The menu is the same as the one displayed when you press the TOP MENU button.
↑/↓/←/→	Move the cursor up, down, left, or right across the screen.
ENTER	Select the item currently highlighted on the screen.
RETURN	Exit the menu and return to the previous screen.
Number	Removes the selected item from the menu (if available).

 **FAQ**

- *After I load a DVD disc, it ejects automatically after a few seconds!*

Most likely, the disc is the wrong region for your player. The region number should be printed on the disc; check it against the region number of the player (which you can find on the rear panel). See also *DVD-Video regions* on page 44.

If the region number is OK, it may be that the disc is damaged or dirty. Clean the disc and look for signs of damage. See also *Taking care of your player and discs* on page 42.

- *Why won't the disc I loaded play?*

First check that you loaded the disc the right way up (label side up), and that it's clean and undamaged. See *Taking care of your player and discs* on page 42 for information on cleaning discs.

If a disc loaded correctly won't play, it's probably an incompatible format or disc type, such as DVD-Audio or DVD-ROM. See *Disc/content format playback compatibility* on page 8 for more on disc compatibility.

- *I have a widescreen TV so why are there black bars at the top and bottom of the screen when I play some discs?*

Some movie formats are such that even when played on a widescreen TV, black bars are necessary at the top and bottom of the screen. This is not a malfunction.

- *I have a standard (4:3) TV and set the player to show widescreen DVDs in pan & scan format, so why do I still get black bars top and bottom with some discs?*

Some discs override the display preferences of the player, so even if you have **4:3 (Pan & Scan)** selected, those discs will still be shown in letter box format. This is not a malfunction.

- *I've connected to a HDMI compatible component but I can't get any signal and the front panel HDMI indicator won't light!*

Make sure that you've selected this player as the HDMI input in the settings for the component you're using. You may need to refer to the instruction manual of the component to do this. See *Connecting using HDMI* on page 14 for more on HDMI compatibility.

- *There's no picture from the HDMI output!*

This player cannot display pictures from DVI compatible sources. See *Connecting using HDMI* on page 14 for more on HDMI compatibility.

Make sure the resolution on this player matches that of the component you have connected using HDMI. See *HDMI Resolution* on page 36 to change the HDMI resolution.

Chapter 5

Playing discs



Note

- Many of the functions covered in this chapter apply to DVD discs, Video CDs, CDs, DivX video/WMV and MP3/WMA/MPEG-4 AAC/JPEG discs, although the exact operation of some varies slightly with the kind of disc loaded.
- Some DVDs restrict the use of some functions (random or repeat, for example) in some or all parts of the disc. This is not a malfunction.
- When playing Video CDs, some of the functions are not available during PBC playback. If you want to use them, start the disc playing using a number button to select a track.

Scanning discs

You can fast-scan discs forward or backward at four different speeds (only one speed for DivX video/WMV).

1 During playback, press ◀◀ or ▶▶ to start scanning.

- There is no sound while scanning DVDs, DivX video/WMV and Video CDs.

2 Press repeatedly to increase the scanning speed.

- The scanning speed is shown on-screen.

3 To resume normal playback, press ▶ (play).

- When scanning a Video CD playing in PBC mode or a MP3/WMA/MPEG-4 AAC track, playback automatically resumes at the end or beginning of the track.
- Depending on the disc, normal playback may automatically resume when a new chapter is reached on a DVD disc.

Playing in slow motion

You can play DVD-Videos and DVD-R/-RW at four different slow motion speeds, forwards and backwards. Video CDs and DivX video/WMV can be played at four different forward slow motion speeds.

1 During playback, press II (pause).

2 Press and hold ◀|/◀|| or |||/|▶ until slow motion playback starts.

- The slow motion speed is shown on-screen.
- There is no sound during slow motion playback.

3 Press repeatedly to change the slow motion speed.

4 To resume normal playback, press ▶ (play).

- Depending on the disc, normal playback may automatically resume when a new chapter is reached.

Frame advance/frame reverse

You can advance or back up DVD-Video and DVD-R/-RW discs frame-by-frame. With Video CDs and DivX video/WMV file you can only use frame advance.

1 During playback, press II (pause).

2 Press ◀|/◀|| or |||/|▶ to reverse or advance a frame at a time.

3 To resume normal playback, press ▶ (play).

- Depending on the disc, normal playback may automatically resume when a new chapter is reached.

Viewing a JPEG slideshow

After loading a CD/CD-R/-RW containing JPEG picture files, press ► (play) to start a slideshow from the first folder/picture on the disc. The player displays the pictures in each folder in alphabetical order.

- If the folder contains MP3/WMA/MPEG-4 AAC files, playback of the slideshow and MP3/WMA/MPEG-4 AAC file repeats. During the audio playback, you can still use the skip (I◀◀/▶▶I), scan (◀◀◀/▶▶▶) and pause (II) functions.

Pictures are automatically adjusted so that they fill as much of the screen as possible (if the aspect ratio of the picture is different to your TV screen you may notice black bars at the sides, or at the top and bottom of the screen).

While the slideshow is running:

Button	What it does
II	Pauses the slideshow; press again to restart.
I◀◀	Displays the previous picture.
▶▶I	Displays the next picture.
◀/➡	Pauses the slideshow and rotates the displayed picture 90° (counter) clockwise. (Press ► (play) to restart slideshow.)
↑/↓	Pauses the slideshow and flips the displayed picture horizontally or vertically. (Press ► (play) to restart slideshow.)
ZOOM	Pauses the slideshow and zooms the picture. Press again to toggle between 1x, 2x and 4x zoom. (Press ► (play) to restart slideshow.)
MENU	Displays the Disc Navigator screen (see below).

Note

- The time it takes for the player to load a file increases with large file sizes.

Browsing DVD or Video CD/ disc with the Disc Navigator

Use the Disc Navigator to browse through the contents of a DVD-Video, VR mode DVD-R/-RW or Video CD disc to find the part you want to play.

Important

- You can't use the Disc Navigator with Video CDs in PBC mode.

- 1 During playback, press HOME MENU and select 'Disc Navigator' from the on-screen menu.

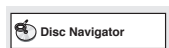

- 2 Select a view option.

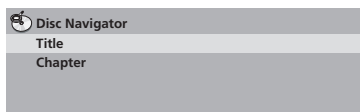

The options available depend on the kind of disc loaded and whether the disc is playing or not, but include:

- **Title** – Titles from a DVD-Video disc.
- **Chapter** – Chapters from the current title of a DVD-Video disc.
- **Track** – Tracks from a Video CD disc.
- **Time** – Thumbnails from a Video CD disc at 10 minute intervals.
- **Original: Title** – Original titles from a VR mode DVD-R/-RW disc.
- **Play List: Title** – Play List titles from a VR mode DVD-R/-RW disc.
- **Original: Time** – Thumbnails from the Original content at 10 minute intervals.
- **Play List: Time** – Thumbnails from the Play List at 10 minute intervals.

The screen shows up to six moving thumbnail images displayed one after another. To display the previous/next six thumbnails, press I◀◀/▶▶I (you don't have to wait for all the thumbnails to finish playing to display the previous/next page).

3 Select the thumbnail image for what you want to play.

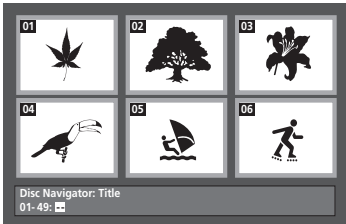

You can use either the cursor buttons (↑/↓/←/→) and **ENTER** to select a thumbnail, or the number buttons.

To select using the number buttons, enter a two-digit number then press **ENTER**.



Tip

- Another way to find a particular place on a disc is to use one of the search modes. See *Searching a disc* on page 29.

Browsing WMA, MP3, MPEG-4 AAC, DivX video, WMV and JPEG files with the Disc Navigator

Use the Disc Navigator to find a particular file or folder by filename. Note that if there are other types of files on the same disc, these will not be displayed in the Disc Navigator.

1 Press HOME MENU and select 'Disc Navigator' from the on-screen menu.

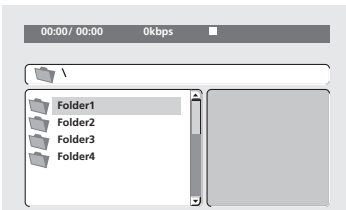

2 Use the cursor buttons (↑/↓/←/→) and ENTER to navigate.

Use the cursor up/down buttons (↑/↓) to move up and down the folder/file list.

Use the cursor left button (←) to return to the parent folder.

Use **ENTER** or cursor right (→) to open a highlighted folder.

- You can also return to the parent folder by going to the top of the list to the '..' folder, then pressing **ENTER**.
- When a JPEG file is highlighted, a thumbnail image is displayed on the right.

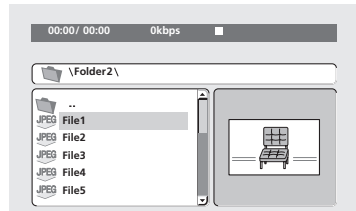

3 To play the highlighted track or DivX video/WMV file or display the highlighted JPEG file, press ENTER.

- When a MP3/WMA/MPEG-4 AAC or DivX video/WMV file is selected, playback begins, starting with the selected file, and continues until the end of the folder.
- When a JPEG file is selected, a slideshow begins, starting with that file, and continues to the end of the folder.



Tip

- You can also play a JPEG slideshow while listening to MP3/WMA/MPEG-4 AAC playback. Simply select the audio file you want to listen to followed by the JPEG from which you want the slideshow to start. Playback of both the slideshow and the audio files repeats. Playback controls are effective for the JPEG slideshow only.
- To play the contents of the whole disc rather than just the current folder, exit the Disc Navigator and start playback using the ► (play) button.

Looping a section of a disc

The A-B Repeat function allows you to specify two points (A and B) within a track (CD, Video CD) or title (DVD-Video and DVD-RW) that form a loop which is played over and over.

- You can't use A-B Repeat with Video CDs in PBC mode, or MP3/WMA/MPEG-4 AAC/DivX video/WMV files.

1 During playback, press PLAY MODE and select 'A-B Repeat' from the list of functions on the left.

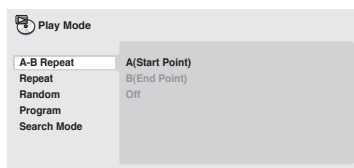

2 Press ENTER on 'A(Start Point)' to set the loop start point.

3 Press ENTER on 'B(End Point)' to set the loop end point.

After pressing **ENTER**, playback jumps back to the start point and plays the loop.

4 To resume normal playback, select 'Off' from the menu.

Using repeat play

There are various repeat play options, depending on the kind of disc loaded. It's also possible to use repeat play together with program play to repeat the tracks/chapters in the program list (see *Creating a program list* on page 28).



Important

- You can't use Repeat play with Video CDs in PBC mode, or with MP3/WMA/MPEG-4 AAC discs.
- You can't use repeat and random play at the same time.

1 During playback, press PLAY MODE and select 'Repeat' from the list of functions on the left.

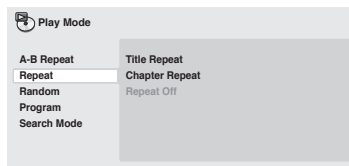

2 Select a repeat play option.

If program play is active, select **Program Repeat** to repeat the program list, or **Repeat Off** to cancel.

The repeat options available depend on the kind of disc loaded. For example, for DVD-Video and DVD-RW discs, you can select **Title Repeat** or **Chapter Repeat** (or **Repeat Off**).

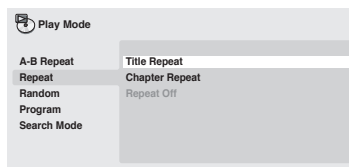

- For CDs and Video CDs, select **Disc Repeat** or **Track Repeat** (or **Repeat Off**).
- For DivX video/WMV discs, select **Title Repeat**, and for some DivX media files, select **Chapter Repeat** (or **Repeat Off**).

Using random play

Use the random play function to play titles or chapters (DVD-Video) or tracks (DVD-Audio, CD, Video CD) at random. (Note that the same track/title/chapter may play more than once.)

You can set the random play option when a disc is playing or stopped.



Important

- Random play remains in effect until you select **Random Off** from the random play menu options.

- You can't use random play with VR format DVD-R/-RW discs, Video CDs playing in PBC mode, MP3/WMA/MPEG-4 AAC discs, DivX video/WMV discs, or while a DVD disc menu is being displayed.
- You can't use random play together with program or repeat play.

1 Press **PLAY MODE** and select 'Random' from the list of functions on the left.

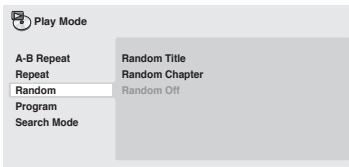

2 Select a random play option.

The random play options available depend on the kind of disc loaded. For example, for DVD-Video discs, you can select **Random Title** or **Random Chapter** (or **Random Off**).

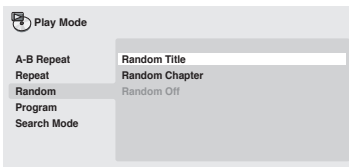

- For CDs and Video CDs, select **On** or **Off** to switch random play on or off.



Tip

- Use the following controls during random play:

Button	What it does
▶▶	Selects a new track/title/chapter at random.
◀◀	Returns to the beginning of the current track/title/chapter; further presses select another random track/title/chapter.

Creating a program list

This feature lets you program the play order of titles/chapters/groups/tracks on a disc.



Important

- You can't use Program play with VR format DVD-R/-RW discs, Video CDs playing in PBC mode, MP3/WMA/MPEG-4 AAC discs, DivX video/WMV discs, or while a DVD disc menu is being displayed.

1 Press **PLAY MODE** and select 'Program' from the list of functions on the left.

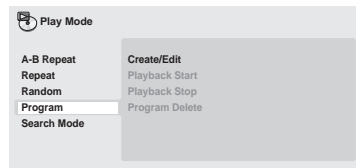

2 Select 'Create/Edit' from the list of program options.

3 Use the cursor buttons and **ENTER** to select a title, chapter or track for the current step in the program list.

For a DVD-Video disc, you can add a title or a chapter to the program list.

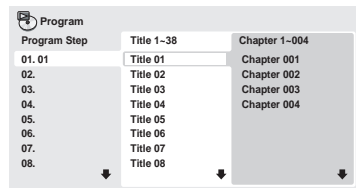

- For a CD or Video CD, select a track to add to the program list.

After pressing **ENTER** to select the title/chapter/group/track, the step number automatically moves down one.

4 Repeat step 3 to build up a program list.

A program list can contain up to 24 titles/chapters/tracks.

- You can insert steps into the middle of a program list by just highlighting the position where you want the new step to appear and entering a title/chapter/group/track number.
- To delete a step, highlight it and press **CLEAR**.

5 To play the program list, press ► (play).

Program play remains active until you turn off program play (see below), erase the program list (see below), eject the disc or switch off the player.

Tip

- Use the following controls during program play:

Other functions available from the program menu

There are a number of other options in the program menu in addition to Create/Edit.

- **Playback Start** – Starts playback of a saved program list
- **Playback Stop** – Turns off program play, but does not erase the program list
- **Program Delete** – Erases the program list and turns off program play

Chapter 6

USB playback

Using the USB interface

It is possible to listen to two-channel audio and watch JPEG files using the USB interface on the front of this unit. Connect a USB mass storage device as shown below.



Note

- This includes playback of MP3/WMA/MPEG-4 AAC/JPEG files (except files with copy-protection or restricted playback).
- Compatible USB devices include portable flash memory (particularly keydrives) and digital audio players (MP3 players) of format FAT16/32. It is not possible to connect this unit to a personal computer for USB playback.
- Pioneer cannot guarantee compatibility (operation and/or bus power) with all USB mass storage devices and assumes no responsibility for any loss of data that may occur when connected to this unit.
- With large amounts of data, it may take longer for the system to read the contents of a USB device.
- The Home Menu cannot be displayed while using the USB mode.

1 With the player switched on, press DVD/USB.

Make sure your TV is on and set to the correct video input, and that **USB MODE** is showing on the front panel display.

2 Connect your USB device.

The USB terminal is located on the front panel.

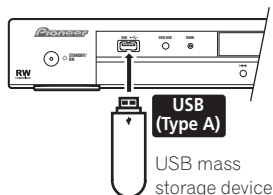

- Disc Navigator is automatically displayed.

3 Press ENTER to start playback.

- The method of playback for files saved on a USB device is the same as for other discs. For more information, see *Basic playback controls* on page 21 and *Playing discs* on page 24.

4 Turn off this player and remove the USB device.

- The next time you turn this player on it will start up in USB mode. To return to DVD mode, either press **DVD/USB** or press **▲ OPEN/CLOSE** to open the disc tray.



Important

If a **USB ERR** message lights in the display, it may mean that the power requirements of the USB device are too high for this player, or that the device is incompatible. Try the following:

- Switch the player off, then on again.
- Reconnecting the USB device with the player switched off.
- Change the player back to DVD mode (**LOADING** will appear in the front panel display whether a disc is inserted or not) by pressing **DVD/USB**, then once again select USB mode (**USB MODE** will appear in the front panel display).
- Using a dedicated AC adapter (supplied with the device) for USB power.

If this doesn't remedy the problem, it is likely your USB device is incompatible.

Chapter 7

Audio Settings and Video Adjust menu

Audio Settings menu

The Audio Settings menu offers features for adjusting the way discs sound.

- 1 Press **HOME MENU** and select 'Audio Settings' from the on-screen display.



- 2 Select and change settings using the **↑/↓/←/→** (cursor) buttons, and **ENTER**.

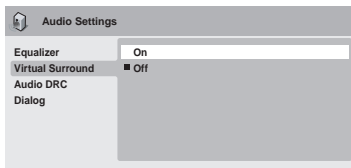

Audio DRC

- Settings: **High, Medium, Low, Off** (default)

When watching Dolby Digital DVDs at low volume, it's easy to lose the quieter sounds completely—including some of the dialog. Switching Audio DRC (Dynamic Range Control) to on can help by bringing up the quieter sounds, while controlling loud peaks. How much of a difference you hear depends on the material you're listening to. If the material doesn't have wide variations in volume, you may not notice much change.

Note

- Audio DRC is only effective with Dolby Digital audio sources.
- Audio DRC is only effective through the digital output when **Digital Out** is set to **On**, and **Dolby Digital Out** is set to **Dolby Digital > PCM** (see *Digital Audio Out settings* on page 35).
- The effect of Audio DRC also depends on your speakers and AV receiver settings.

Virtual Surround

- Settings: **On, Off** (default)

Switch on Virtual Surround to enjoy realistic surround sound effects from just two speakers.

Tip

- You can also use the **SURROUND** button on the remote control to switch Virtual Surround on.

Note

- Virtual Surround doesn't work with DTS, through either the analog or digital outputs.
- 96 kHz linear PCM audio is automatically downsampled to 48 kHz if Virtual Surround is switched on.
- If the player is outputting Dolby Digital, DTS or MPEG bitstream audio (in other words, no conversion to PCM), Virtual Surround has no effect on the audio from the digital output. See *Digital Audio Out settings* on page 35 for how to set up the digital output formats.

Audio Settings and Video Adjust menus

- How good the surround effect is varies with the disc.

Equalizer

- Settings: **Rock, Pop, Live, Dance, Techno, Classic, Soft, Off** (*default*)

The various preset EQ curves are designed to suit various styles of music.



Note

- 96 kHz linear PCM audio is automatically downsampled to 48 kHz if the Equalizer is switched on.

Dialog

- Settings: **High, Medium, Low, Off** (*default*)

The Dialog feature is designed to make the dialog stand out from other background sounds in the soundtracks.

Video Adjust menu

From the Video Adjust screen you can adjust various settings that affect how the picture is presented.

- 1 Press **HOME MENU** and select 'Video Adjust' from the on-screen display.



- 2 Make settings using the **↑/↓/←/→** (cursor) buttons, and **ENTER**.

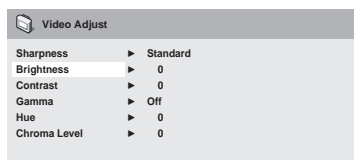

You can adjust the following picture quality settings:

- **Sharpness** – Adjusts the sharpness of edges in the picture (**Fine, Standard** (*default*), **Soft**).

- **Brightness** – Adjusts the overall brightness (**-20** to **+20**).
- **Contrast** – Adjusts the contrast between light and dark (**-16** to **+16**).
- **Gamma** – Adjusts the 'warmth' of the picture (**High, Medium, Low, Off** (*default*)).
- **Hue** – Adjusts the red/green balance (**green 9** to **red 9**).
- **Chroma Level** – Adjusts how saturated colors appear (**-9** to **+9**).

Adjust the Brightness, Contrast, Hue and Chroma Level settings using the **←/→** (cursor left/right) buttons.



- 3 Press **ENTER** to return to the Video Adjust screen, or **HOME MENU** to exit.

Chapter 8

Initial Settings menu

Using the Initial Settings menu

The Initial Settings menu provides audio and video output settings, parental lock settings, and display settings, among others.

If an option is grayed out it means that it cannot be changed at the current time. This is usually because a disc is playing. Stop the disc, then change the setting.

1 Press HOME MENU and select 'Initial Settings'.

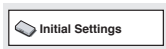

2 Use the cursor buttons and ENTER to select the setting and option you want to set.

All the settings and options are explained on the following pages.



Note

- In the table below, the default setting is shown in **bold**; other settings are shown in *italics*.
- The **Digital Audio Out** settings only need to be set if you have connected the digital output of this player to an AV receiver, or other equipment.
- Check the operating instructions supplied with your other equipment to see which digital audio formats it's compatible with.
- Some settings, such as **TV Screen**, **Audio Language** and **Subtitle Language** may be overridden by the DVD disc. Often these settings can also be made from the DVD disc menu.

- The **HDMI Out**, **HDMI Resolution** and **HDMI Color** settings only need to be set if you connected this player to an HDMI-compatible component using the HDMI connector.
- The **Digital Audio Out** and **Component Out** settings cannot be set if the player is connected to an HDMI-compatible component using the HDMI connector. Additionally, certain settings such as **HDMI Out**, **HDMI Resolution**, and **HDMI Color** may be changed automatically.

Digital Audio Out settings

Setting	Option	What it means
Digital Out	On	Digital audio is output from the digital outputs.
	<i>Off</i>	No digital audio output.
Dolby Digital Out	Dolby Digital	Dolby Digital encoded digital audio is output when playing a Dolby Digital DVD disc.
	<i>Dolby Digital > PCM</i>	Dolby Digital audio is converted to PCM audio before being output.
DTS Out	DTS	DTS encoded digital audio is output when playing a DTS disc. (Noise will be output if your amplifier/receiver is not compatible with DTS audio.)
	<i>DTS > PCM</i>	No digital audio is output when playing a DTS disc. DTS audio is converted to PCM audio before being output.
96 kHz PCM Out	96kHz > 48kHz	96 kHz digital audio is converted to 48 kHz for digital output.
	<i>96kHz</i>	96 kHz digital audio is output as is at 96 kHz.
MPEG Out	<i>MPEG</i>	MPEG encoded digital audio is output as is.
	MPEG > PCM	MPEG encoded digital audio is converted to PCM audio for digital output.
HDMI Out	LPCM (2CH)	Set if your monitor or device only accepts stereo input. On this setting multichannel audio is downmixed to 2 channels for stereo linear PCM output.
	<i>Auto</i>	Dolby Digital, DTS and MPEG sources are processed according to how they were encoded, and linear PCM sources are heard as is.
	<i>Off</i>	No digital audio output. Choose this option when you want to change the Digital Audio Out .

Video Output settings

Setting	Option	What it means
TV Screen (This setting effective for analog and HDMI video output. See also <i>Screen sizes and disc formats on page 43.</i>)	4:3 (Letter Box)	Set if you have a conventional 4:3 TV. Widescreen movies are shown with black bars top and bottom.
	<i>4:3 (Pan & Scan)</i>	Set if you have a conventional 4:3 TV. Widescreen movies are shown with the sides cropped so that the image fills the screen.
	<i>16:9 (Wide)</i>	Set if you have a widescreen TV.
	<i>16:9 (Compressed)</i>	Can be selected when you are connected via HDMI, and have the HDMI Resolution set to 1920 x 1080p , 1920 x 1080i or 1280 x 720p . Video in 4:3 can be properly displayed on a 16:9 high definition television (with black bars shown on either side of the screen).

Setting	Option	What it means
Component Out	Interlace	Set if your TV is not compatible with progressive scan video.
	<i>Progressive</i>	Set if your TV is compatible with progressive scan video (see your TV's instruction manual for details). The PRGSVE indicator lights in the front panel display. See also <i>Switching the video output to interlace using the front panel controls</i> on page 13. <i>Note that progressive scan video is only output from the component jacks.</i>
HDMI Resolution	<i>1920x1080p</i>	Set if your TV supports 1920 x 1080 pixel progressive-scan video.
	<i>1920x1080i</i>	Set if your TV supports 1920 x 1080 pixel interlace video.
	<i>1280x720p</i>	Set if your TV supports 1280 x 720 pixel progressive-scan video.
	720x480p	Set if your TV supports 720 x 480 pixel progressive-scan video.
	<i>720x480i</i>	Set if your TV supports 720 x 480 pixel interlace video.
HDMI Color	<i>Full range RGB</i>	If colors are weak, this gives brighter colors and deeper black.
	<i>RGB</i>	Use this setting if colors appear overly rich on the Full Range RGB setting.
	Component	Outputs component video format (default setting for HDMI-compatible devices).

Language settings

Setting	Option	What it means
Audio Language	English	If there is an English soundtrack on the disc then it will be played.
	<i>Languages as displayed</i>	If there is the language selected on the disc, then it will be played.
	<i>Other Language</i>	Select to choose a language other than the ones displayed (see page 44).
Subtitle Language (See also <i>Displaying external subtitle files</i> on page 10.)	English	If there are English subtitles on the disc then they will be displayed.
	<i>Languages as displayed</i>	If there is the subtitle language selected on the disc, then it will be displayed.
	<i>Other Language</i>	Select to choose a language other than the ones displayed (see page 44).

Setting	Option	What it means
DVD Menu Lang.	w/Subtitle Lang.	DVD disc menus will be displayed in the same language as your selected subtitle language, if possible.
	<i>Languages as displayed</i>	DVD disc menus will be displayed in the selected language, if possible.
	<i>Other Language</i>	Select to choose a language other than the ones displayed (see page 44).
Subtitle Display	On	Subtitles are displayed according to your selected subtitle language (see above).
	<i>Off</i>	Subtitles are always off by default when you play a DVD disc (note that some discs override this setting).

Display settings

Setting	Option	What it means
OSD Language	English	On-screen displays of the player are in English.
	<i>Languages as displayed</i>	On-screen displays are shown in the language selected.
Angle Indicator	On	A camera icon is displayed on-screen during multi-angle scenes on a DVD disc.
	<i>Off</i>	No multi-angle indication is shown.

Q

S

P

D

Di

Pa

.

To g
chil
DVD
If yo
disc.

Som
Code
scene
Count



• N

•

Setting/changing the Parental Lock

- 1 Select 'Level Change'.
- 2 Use number buttons to enter your password, then press ENTER.
- 3 Select a new level and press ENTER.
 - Press ← (cursor left) repeatedly to lock more levels (more discs will require the password); press → (cursor right) to unlock levels. You can't lock level 1.

This sets the new level and you will return to the Options menu screen.

Setting/changing the Country/Area code

You can find the *Country/Area code list* on page 50.

- 1 Select 'Country Code'.
- 2 Use number buttons to enter your password, then press ENTER.
- 3 Select a Country/Area code and press ENTER.

There are two ways you can do this:

- Select by code letter: Use ↑/↓ (cursor up/down) to change the Country/Area code.
- Select by code number: Press → (cursor right) then use the number buttons to enter the 4-digit Country/Area code.

The new Country/Area code is set and you will return to the Options menu screen. Note that the new Country/Area code doesn't take effect until the next disc is loaded (or the current disc is reloaded).

DTS Downmix

- Default setting: **STEREO**

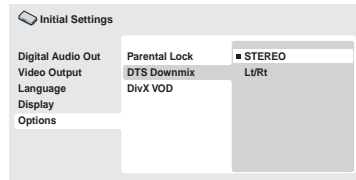

If you've selected **DTS > PCM** in *DTS Out* on page 35, you can choose the way the signal is downmixed to PCM audio. **STEREO** will downmix the DTS signal to 2-channel stereo, whereas **Lt/Rt** will downmix to a 2-channel signal compatible with Dolby surround matrix decoders. (This allows you to hear surround sound if your AV receiver or amplifier has Dolby Pro Logic capability.)

About DivX® VOD content

In order to play DivX VOD (video on demand) content on this player, you first need to register the player with your DivX VOD content provider. You do this by generating a DivX VOD registration code, which you submit to your provider.



Important

- DivX VOD content is protected by a DRM (Digital Rights Management) system. This restricts playback of content to specific, registered devices.
- If you load a disc that contains DivX VOD content not authorized for your player, the message **Authorization Error** is displayed and the content will not play.
- Resetting the player (as described in *Resetting the player* on page 43) will not cause you to lose your registration code.

Displaying your DivX VOD registration code

- 1 Press **HOME MENU** and select '**Initial Settings**'.
- 2 Select '**Options**', then '**DivX VOD**'.

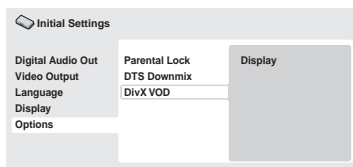

3 Select 'Display'.

Your 8-digit registration code is displayed.

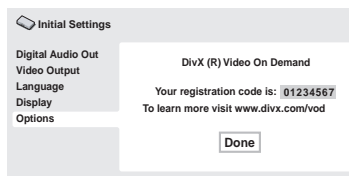

Make a note of the code as you will need it when you register with a DivX VOD provider.

Playing DivX® VOD content

Some DivX VOD content may only be playable a fixed number of times. When you load a disc containing this type of DivX VOD content, the remaining number of plays is shown on-screen and you then have the option of playing the disc (thereby using up one of the remaining plays), or stopping. If you load a disc that contains expired DivX VOD content (for example, content that has zero remaining plays), the message **Rental Expired** is displayed.

If your DivX VOD content allows an unlimited number of plays, then you may load the disc into your player and play the content as often as you like, and no message will be displayed.

About the HDMI audio output settings

The table below shows how the audio settings you make in the **HDMI Out** screen affects the HDMI output with various types of disc.

	Disc audio format	HDMI Out setting	
		LPCM (2CH)	Auto
DVD	Linear PCM ¹	Left/Right	Left/Right
	MPEG ¹	Left/Right	MPEG ²
	Dolby Digital (Karaoke)	Left/Right	Dolby Digital ²
	Dolby Digital ¹	2ch downmix	Dolby Digital ²
	DTS	2ch downmix	DTS ²
CD	CD/MP3/WMA/ MPEG-4 AAC	Left/Right	Left/Right
	Video CD	Left/Right	Left/Right
	DTS CD	Left/Right	DTS ²

1. These formats include DVD-RW discs.

2. If the HDMI device you are using is not compatible with these compressed formats, the signal is output as linear PCM.

Chapter 9

Additional information

Taking care of your player and discs

General

Hold discs by the edge or by the center hole and edge.

When you're not using a disc, return it to its case and store upright. Avoid leaving discs in excessively cold, humid, or hot environments (including under direct sunlight).

Don't glue paper or put stickers on to discs. Do not use a pencil, ball-point pen or other sharp-tipped writing instrument to write on the disc.



Don't use self-adhesive disc labels on discs as these can cause the disc to warp slightly during playback causing distortion in the picture and/or sound.

Damaged and shaped discs

Do not use cracked, chipped, warped, or otherwise damaged discs as they may damage the player.

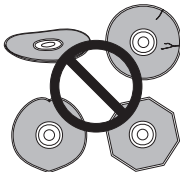

This player is designed to be used only with conventional, fully circular discs. Do not use shaped discs. Pioneer disclaims all liability arising in connection with the use of shaped discs.

Cleaning discs

Fingerprints and dust on discs can affect playback performance. Clean using a soft, dry cloth, wiping the disc lightly from the center to the outside edge as shown below.

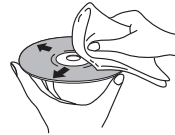

If necessary, use a cloth soaked in alcohol, or a commercially available CD/DVD cleaning kit to clean a disc more thoroughly. Never use benzene, thinner or other cleaning agents, including products designed for cleaning vinyl records.

Cleaning the unit's exterior

Unplug the unit before cleaning.

Use a dry cloth to wipe off dust and dirt. If the surfaces are very dirty, wipe with a soft cloth dipped in some neutral cleanser diluted five or six times with water and wrung out well, then wipe again with a dry cloth.

Do not use furniture wax or cleaners. Never use thinners, benzene or insecticide sprays or other chemicals on or near this unit.

If you use a chemical-impregnated cleaning cloth, read the instructions carefully before use. These cloths may leave smear marks on half-mirror finish surfaces; if this happens, finish with a dry cloth.

Cleaning the pickup lens

The DVD player's lens should not become dirty in normal use, but if for some reason it should malfunction due to dust or dirt, consult your nearest Pioneer-authorized service center. We do not recommend using commercially available lens cleaners for CD players.

Condensation

Condensation may form inside the player if it is brought into a warm room from outside, or if the temperature of the room rises quickly. Although the condensation won't damage the player, it may temporarily impair its performance. Leave it to adjust to the warmer temperature for about an hour before switching on.

Moving the player

If you need to move the player, first press **⏻ STANDBY/ON** on the front panel to turn the player off. Wait for **-OFF-** to disappear from the display, then unplug the power cable. Never lift or move the unit during playback—discs rotate at a high speed and may be damaged.

Screen sizes and disc formats

DVD-Video discs come in several different screen aspect ratios, ranging from TV programs, which are generally 4:3, to CinemaScope widescreen movies, with an aspect ratio of up to about 7:3.

Televisions, too, come in different aspect ratios; 'standard' 4:3 and widescreen 16:9.

Widescreen TV users

If you have a widescreen TV, the **TV Screen** setting (page 35) of this player should be set to **16:9 (Wide)** or **16:9 (Compressed)**.

When you watch discs recorded in 4:3 format with the **16:9 (Wide)** setting, you can use the TV controls to select how the picture is presented. Your TV may offer various zoom and stretch options; see the instructions that came with your TV for details.

Please note that some movie aspect ratios are wider than 16:9, so even though you have a widescreen TV, these discs will still play in a 'letter box' style with black bars at the top and bottom of the screen.

Standard TV users

If you have a standard TV, the **TV Screen** setting (page 35) of this player should be set to **4:3 (Letter Box)** or **4:3 (Pan&Scan)**, depending on which you prefer.

Set to **4:3 (Letter Box)**, widescreen discs are shown with black bars top and bottom.



Set to **4:3 (Pan&Scan)**, widescreen discs are shown with the left and right sides cropped. Although the picture looks larger, you don't actually see the whole picture.

Please note that many widescreen discs override the player's settings so that the disc is shown in letter box format regardless of the setting.

Note

- Using the **16:9 (Wide)** or **16:9 (Compressed)** setting with a standard 4:3 TV, or either of the 4:3 settings with a widescreen TV, will result in a distorted picture.

Resetting the player

Use this procedure to reset all the player's settings to the factory default.

- 1 **Switch the player into standby.**
- 2 **Using the front panel buttons, hold down the **■ (stop)** button and press **⏻ STANDBY/ON** to switch the player back on.**

All the player's settings are now reset.

DVD-Video regions

All DVD-Video discs carry a region mark on the case somewhere that indicates which region(s) of the world the disc is compatible with. Your DVD player also has a region mark, which you can find on the rear panel. Discs from incompatible regions will not play in this player. In this case the attention sentence **Incompatible disc region number Can't play disc** is displayed on screen. Discs marked **ALL** will play in any player. The diagram below shows the various DVD regions of the world.

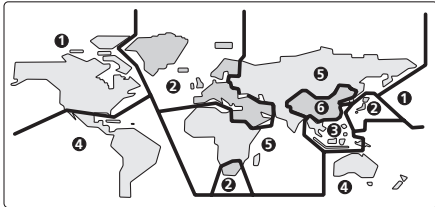

Selecting languages using the language code list

Some of the language options (such as 'DVD Menu Lang.' in the Initial Settings) allow you to set your preferred language from any of the 136 languages listed in the language code list on page 50.

- 1 Select 'Other Language'.
- 2 Use the ←/→ (cursor left/right) buttons to select either a code letter or a code number.
- 3 Use the ↑/↓ (cursor up/down) buttons to select a code letter or a code number.

See *Language code list* on page 50 for a complete list of languages and codes.

Troubleshooting

Incorrect operation is often mistaken for trouble or malfunction. If you think that there is something wrong with this component, check the points below. Sometimes the trouble may lie in another component. Inspect the other components and electrical appliances being used. If the trouble cannot be rectified after checking the items below, ask your nearest Pioneer authorized service center or your dealer to carry out repair work.

Problem	Remedy
The disc won't play or is automatically ejected after loading.	<ul style="list-style-type: none"> • Make sure the disc is free from dirt and dust and is not damaged (page 42). • Make sure the disc is loaded with the label side face-up and aligned properly in the disc tray guide. • Incompatible region number: If the region number on a DVD-Video disc does not match the number on the player, the disc cannot be used (page 44). In this case the attention sentence "Incompatible disc region number Can't play disc" is displayed on screen. • Condensation inside the player: Allow time for condensation to evaporate. Avoid using the player near an air-conditioning unit. • Disc is loaded upside down: Reload the disc with the label side face up.

Problem	Remedy
<p>Picture playback stops and the operation buttons cannot be used.</p>	<ul style="list-style-type: none"> • Press ■, then start playback again (▶). • Press and hold the front panel ⏻ STANDBY/ON button for about 10 seconds to switch the unit off, then press again to switch back on. • Switch the power off once, unplug from the wall socket, then plug back in and switch on again using the front panel ⏻ STANDBY/ON button.
<p>New settings made in the Setup screen menus while a disc is playing are ineffective.</p>	<ul style="list-style-type: none"> • Some settings can be changed while a disc is playing, but are not effective until the disc is stopped then restarted: Press ■, then start playback again (▶).
<p>Settings are canceled.</p>	<ul style="list-style-type: none"> • When the power is cut due to power failure or by unplugging the power cord, settings will be canceled: Press ⏻ STANDBY/ON on the front panel to turn the player off. Wait for --OFF-- to disappear from the display, then unplug the power cord.
<p>The remote control doesn't seem to work.</p>	<ul style="list-style-type: none"> • The remote control is too far from the player, or the angle with the remote sensor is too wide: Use the remote within its operating range (page 17). • The batteries are exhausted: Put in new ones (page 7).
<p>No picture/No color.</p>	<ul style="list-style-type: none"> • Incorrect video connections: Check that connections are correct and that plugs are inserted fully. Also check the video cable for damage. • TV/monitor or AV amplifier settings are incorrect: Check the instruction manual of the connected equipment. • The video output is set to progressive but your TV/monitor is not compatible with progressive scan: See page 13 for how to set to Interlace.
<p>Screen is stretched or aspect does not change.</p>	<ul style="list-style-type: none"> • The TV Screen setting in the Initial Settings menu is incorrect. See page 43 for how to set it correctly for your TV/monitor.
<p>Picture disturbance during playback or the picture is dark.</p>	<ul style="list-style-type: none"> • This player is compatible with Macro-Vision System copy guard. Some discs include a copy prevention signal, and when this type of disc is played back, stripes etc., may appear on some sections of the picture depending on the TV. This is not a malfunction. • Due to the player's copy protection circuits, connection of this device through a VCR or an AV selector may prevent recording or cause picture problems. This is not a malfunction.

Problem	Remedy
No audio, or audio is distorted.	<ul style="list-style-type: none"> • No audio is output during slow motion playback or when scanning discs other than audio CDs. • Some DVD discs do not output digital audio: Switch your amplifier to the player's analog outputs. • Check that the disc is free from dust and dirt, and that it is not damaged (page 42). • Check that all interconnects are firmly inserted. • Check that the plugs and terminals are free of dirt, oxide, etc. and clean if necessary. Also check the cable for damage. • Make sure the player's output is not connected to the amplifier's phono (turntable) inputs. • Check your amplifier/receiver's settings (volume, input function, speaker settings, etc.).
The analog audio is OK, but there appears to be no digital audio signal.	<ul style="list-style-type: none"> • Make sure that the Digital Out setting is set to On (page 35). • Check that the Dolby Digital, DTS and MPEG out settings (page 35) are suitable for your amplifier/receiver—check the instruction manual that came with your amplifier/receiver.
Noticeable difference in DVD and CD volume.	<ul style="list-style-type: none"> • This is due to differences in the audio format and is not a malfunction.
Cannot play multi-channel audio.	<ul style="list-style-type: none"> • Check that the Dolby Digital, DTS and MPEG Out settings (page 35) are suitable for your amplifier/receiver—check the instruction manual that came with your amplifier/receiver. • Check the audio options available from the disc menu.
Cannot listen to high-sampling rate audio through the digital output.	<ul style="list-style-type: none"> • Make sure that 96 kHz PCM Out is set to 96 kHz. • As a copy-protection measure, some DVDs do not output 96kHz audio. In this case, even if set to 96 kHz, the player automatically outputs the audio at 48 kHz. This is not a malfunction.
Cannot output 96kHz or 88.2kHz digital audio.	<ul style="list-style-type: none"> • Check that 96 kHz PCM Out is set to 96 kHz. • Some discs are digital copy protected and do not output high sampling rate digital audio. In this case the output is automatically downsampled.
No DTS audio output.	<ul style="list-style-type: none"> • If this unit is connected to a non-DTS compatible amplifier or decoder using a digital audio cable, set DTS Out to DTS > PCM (page 35). If you do not do this, noise will be output when you play a DTS disc. • If this unit is connected to a DTS-compatible amplifier or decoder using a digital audio cable, check the amplifier settings, and that the cable is properly connected.
Can't hear effect of Virtual Surround.	<ul style="list-style-type: none"> • The effectiveness of Virtual Surround varies with the disc.

HDMI troubleshooting

Problem	Remedy
No HDMI audio output.	<ul style="list-style-type: none"> • Check whether or not HDMI Out is set to Off. (See <i>HDMI Out</i> on page 35.) • This unit has been designed to be compliant with HDMI (High Definition Multimedia Interface). Depending on the component you have connected, unreliable signal transfers may result. <ul style="list-style-type: none"> • If the front panel HDMI indicator is lit: <ul style="list-style-type: none"> – You won't hear any sound from the HDMI output if the source component is only DVI/HDCP-compatible. • If the front panel HDMI indicator is unlit then: <ul style="list-style-type: none"> – Make sure that you've selected this player as the HDMI input in the settings for the component you're using. You may need to refer to the instruction manual of the component to do this. – Check that the HDMI cable is connected properly and that the cable isn't damaged. – Check that components connected using the HDMI interface are switched on and HDMI compatible.
No HDMI video output.	<ul style="list-style-type: none"> • Make sure that you've selected this player as the HDMI input in the settings for the component you're using. You may need to refer to the instruction manual of the component to do this. • Check that the HDMI cable is connected properly and that the cable isn't damaged. • Check that components connected using the HDMI interface are switched on and HDMI compatible. • This unit has been designed to be compliant with HDMI (High Definition Multimedia Interface). Depending on the component you have connected, using a DVI connection may result in unreliable signal transfers. • Make sure the resolution on this player matches that of the component you have connected using HDMI. See <i>HDMI Resolution</i> on page 36 to change the HDMI resolution. See <i>Resetting the output resolution to the default setting with HDMI connection</i> on page 15 if you want to reset the output resolution.
No multichannel HDMI audio.	<ul style="list-style-type: none"> • Make sure the HDMI Out setting is set to Auto (see <i>HDMI Out</i> on page 35 to do this). See also <i>About the HDMI audio output settings</i> on page 41.
Component Out cannot be set to Interlace.	<ul style="list-style-type: none"> • You can use the Interlace setting if the HDMI Resolution is set to 720 x 480i.
A connected DVI component (with HDCP) doesn't work with this player.	<ul style="list-style-type: none"> • This unit has been designed to be compliant with HDMI (High Definition Multimedia Interface). Depending on the component you have connected, using a DVI connection may result in unreliable signal transfers.

USB troubleshooting

Problem	Remedy
USB mass storage device is not recognized by the system.	<ul style="list-style-type: none"> • Make sure you have completely inserted the USB connector to this unit. • Check that the memory format is FAT16 or FAT32. • USB devices with an internal USB hub are not supported.
Files don't show up in the Navigator/Photo Browser.	<ul style="list-style-type: none"> • The files must have the correct file extension: .mp3 for MP3 files; .wma for WMA files; .m4a for MPEG-4 AAC files; .jpg for JPEG files (upper or lower-case is OK). • Make sure the file permission hasn't been restricted (through a password, etc.).
Can't play WMA or MPEG-4 AAC files.	<ul style="list-style-type: none"> • The files were recorded using DRM (digital rights management) or FairPlay copy-protection. This is not a malfunction.



Note

- Static electricity or other external influences may cause malfunctioning of this unit. In this case, unplug the power cord and then plug back in. This will usually reset the unit for proper operation. If this does not correct the problem, please consult your nearest Pioneer service center.

Glossary

Analog audio Direct representation of sound by an electrical signal. See also *Digital audio*.

Aspect ratio The width of a TV screen relative to its height. Conventional TVs are 4:3; widescreen models are 16:9.

Digital audio Indirect representation of sound using numbers. See also *Sampling frequency* and *Analog audio*.

DivX DivX is a digital video format created by DivX, Inc.

Dolby Digital A multi-channel audio encoding system developed by Dolby Laboratories that enables far more audio to be stored on a disc than PCM encoding. See also *PCM (Pulse Code Modulation)*.

DRM

DRM (digital rights management) copy protection is a technology designed to prevent unauthorized copying by restricting playback, etc. of compressed audio files on devices other than the PC (or other recording equipment) used to record it. For detailed information, please see the instruction manuals or help files that came with your PC and/or software.

DTS

A multi-channel audio encoding system developed by Digital Theater Systems that enables far more audio to be stored on a disc than PCM encoding. See also *PCM (Pulse Code Modulation)*.

EXIF (Exchangeable Image File)

A file format developed by FUJIFILM for digital still cameras. Digital cameras from various manufacturers use this compressed file format which carries date, time and thumbnail information, as well as the picture data.

File extension

A tag added to the end of a filename to indicate the type of file. For example, ".mp3" indicates an MP3 file.

HDMI HDMI (High-Definition Multimedia Interface) is a high-speed digital interface which has the capability to support standard, enhanced, or high-definition video plus standard to multi-channel surround-sound audio on a single digital connection. HDMI features include uncompressed digital video, a bandwidth of up to 5 gigabytes per second and communication between the AV source and AV devices such as DTVs.

ISO 9660 format International standard for the volume and file structure of CD-ROM discs.

JPEG A standard file format used for still images. JPEG files are identified by the file extension ".jpg".

MP3 MP3 (MPEG1 audio layer 3) is a compressed stereo audio file format. Files are recognized by their file extension ".mp3".

MPEG-4 AAC MPEG-4 AAC is a compressed stereo audio file format. Files are recognized by the extension '.m4a'. Note that some files purchased with copyright protection (such as files from the iTunes store) may not playback.

MPEG audio An audio format used on Video CDs and some DVD discs.

PBC (PlayBack Control) A system of navigating a Video CD through on-screen menus recorded onto the disc.

PCM (Pulse Code Modulation) Digital audio encoding system found on CDs. Good quality, but requires a lot of data compared to Dolby Digital, DTS and MPEG encoded audio. See also *Digital audio*.

Progressive scan video All the lines that make up a video picture are updated in one pass (compared to interlace which takes two passes to update the whole picture).

Regions (DVD-Video only) These associate DVD-Video discs and players with particular areas of the world. See *DVD-Video regions* on page 44 for more information.

Sampling frequency The rate at which sound is measured to be turned into digital audio data. The higher the rate, the better the sound quality. CD is 44.1 kHz; DVD can be up to 96 kHz. See also *Digital audio*.

WMA WMA is short for Windows Media Audio and refers to an audio compression technology developed by Microsoft Corporation. Files are recognized by their file extension ".wma".

WMV WMV is an acronym for Windows Media Video and refers to a video compression technology developed by Microsoft Corporation. Files are recognized by the file extension ".wmv".

Language code list

Language (Language code letter), **Language code**

Japanese (ja), 1001	Bhutani (dz), 0426	Kirghiz (ky), 1125	Sinhalese (si), 1909
English (en), 0514	Esperanto (eo), 0515	Latin (la), 1201	Slovak (sk), 1911
French (fr), 0618	Estonian (et), 0520	Lingala (ln), 1214	Slovenian (sl), 1912
German (de), 0405	Basque (eu), 0521	Laothian (lo), 1215	Samoan (sm), 1913
Italian (it), 0920	Persian (fa), 0601	Lithuanian (lt), 1220	Shona (sn), 1914
Spanish (es), 0519	Finnish (fi), 0609	Latvian (lv), 1222	Somali (so), 1915
Chinese (zh), 2608	Fiji (fj), 0610	Malagasy (mg), 1307	Albanian (sq), 1917
Dutch (nl), 1412	Faroese (fo), 0615	Maori (mi), 1309	Serbian (sr), 1918
Portuguese (pt), 1620	Frisian (fy), 0625	Macedonian (mk), 1311	Siswati (ss), 1919
Swedish (sv), 1922	Irish (ga), 0701	Malayalam (ml), 1312	Sesotho (st), 1920
Russian (ru), 1821	Scots-Gaelic (gd), 0704	Mongolian (mn), 1314	Sundanese (su), 1921
Korean (ko), 1115	Galician (gl), 0712	Moldavian (mo), 1315	Swahili (sw), 1923
Greek (el), 0512	Guarani (gn), 0714	Marathi (mr), 1318	Tamil (ta), 2001
Afar (aa), 0101	Gujarati (gu), 0721	Malay (ms), 1319	Telugu (te), 2005
Abkhazian (ab), 0102	Hausa (ha), 0801	Maltese (mt), 1320	Tajik (tg), 2007
Afrikaans (af), 0106	Hindi (hi), 0809	Burmese (my), 1325	Thai (th), 2008
Amharic (am), 0113	Croatian (hr), 0818	Nauru (na), 1401	Tigrinya (ti), 2009
Arabic (ar), 0118	Hungarian (hu), 0821	Nepali (ne), 1405	Turkmen (tk), 2011
Assamese (as), 0119	Armenian (hy), 0825	Norwegian (no), 1415	Tagalog (tl), 2012
Aymara (ay), 0125	Interlingua (ia), 0901	Occitan (oc), 1503	Tonga (to), 2014
Azerbaijani (az), 0126	Interlingue (ie), 0905	Oromo (om), 1513	Tswana (tn), 2015
Bashkir (ba), 0201	Inupiak (ik), 0911	Oriya (or), 1518	Turkish (tr), 2018
Byelorussian (be), 0205	Indonesian (in), 0914	Panjabi (pa), 1601	Tsonga (ts), 2019
Bulgarian (bg), 0207	Icelandic (is), 0919	Polish (pl), 1612	Tatar (tt), 2020
Bihari (bh), 0208	Hebrew (iw), 0923	Pashto, Pushto (ps), 1619	Twi (tw), 2023
Bislama (bi), 0209	Yiddish (ji), 1009	Quechua (qu), 1721	Ukrainian (uk), 2111
Bengali (bn), 0214	Javanese (jw), 1023	Rhaeto-Romance (rm), 1813	Urdu (ur), 2118
Tibetan (bo), 0215	Georgian (ka), 1101	Kirundi (rn), 1814	Uzbek (uz), 2126
Breton (br), 0218	Kazakh (kk), 1111	Romanian (ro), 1815	Vietnamese (vi), 2209
Catalan (ca), 0301	Greenlandic (kl), 1112	Kinyarwanda (rw), 1823	Volapük (vo), 2215
Corsican (co), 0315	Cambodian (km), 1113	Sanskrit (sa), 1901	Wolof (wo), 2315
Czech (cs), 0319	Kannada (kn), 1114	Sindhi (sd), 1904	Xhosa (xh), 2408
Welsh (cy), 0325	Kashmiri (ks), 1119	Sangho (sg), 1907	Yoruba (yo), 2515
Danish (da), 0401	Kurdish (ku), 1121	Serbo-Croatian (sh), 1908	Zulu (zu), 2621

Country/Area code list

Country/Area, Country/Area code, Country/Area code letter

Argentina, 0118, ar	Finland, 0609, fi	Malaysia, 1325, my	Singapore, 1907, sg
Australia, 0121, au	France, 0618, fr	Mexico, 1324, mx	Spain, 0519, es
Austria, 0120, at	Germany, 0405, de	Netherlands, 1412, nl	Sweden, 1905, se
Belgium, 0205, be	Hong Kong, 0811, hk	New Zealand, 1426, nz	Switzerland, 0308, ch
Brazil, 0218, br	India, 0914, in	Norway, 1415, no	Taiwan, 2023, tw
Canada, 0301, ca	Indonesia, 0904, id	Pakistan, 1611, pk	Thailand, 2008, th
Chile, 0312, cl	Italy, 0920, it	Philippines, 1608, ph	United Kingdom, 0702, gb
China, 0314, cn	Japan, 1016, jp	Portugal, 1620, pt	USA, 2119, us
Denmark, 0411, dk	Korea, Republic of, 1118, kr	Russian Federation, 1821, ru	

Specifications

General

Power requirements AC 120 V, 60 Hz
 Power consumption 11 W
 Power consumption (standby) 0.7 W
 Weight 1.8 kg (3 lb 16 oz)
 Dimensions
 . . . 420 mm (W) x 49.5 mm (H) x 215 mm (D)
 . . (16-9/16 in. (W) x 1-15/16 in. (H) x 8-1/2 in. (D))
 Operating temperature +5 °C to +35 °C
 (+41 °F to +95 °F)
 Operating humidity. 5 % to 85 %
 (no condensation)

Component video output (Y, P_B, P_R)

Output level Y: 1.0 Vp-p (75 Ω)
 P_B, P_R (color) 0.7 Vp-p (75 Ω)
 Jacks RCA

S-video output

Y (luminance) - Output level. 1 Vp-p (75 Ω)
 C (color) - Output level 286 mVp-p (75 Ω)
 Jack 4-pin mini DIN

Video output

Output level 1 Vp-p (75 Ω)
 Jack RCA

Audio output (1 stereo pair)

Output level During audio output
 200 mVrms (1 kHz, -20 dB)
 Number of channels 2
 Jacks RCA

HDMI output

HDMI output 19 pin

Digital audio characteristics

Frequency response 4 Hz to 44 kHz
 S/N ratio 115 dB
 Dynamic range. 88 dB
 Total harmonic distortion 0.0065 %
 Wow and flutter Limit of measurement
 (±0.001 % W. PEAK) or lower

Digital output

Coaxial digital output. RCA

Accessories

Remote control 1
 AA/R6P dry cell batteries 2
 Audio/video cable (red/white/yellow plugs). . . . 1
 Warranty card 1
 Operating instructions

The specifications and design of this product are subject to change without notice, due to improvement.

Should this product require service in the U.S.A. and you wish to locate the nearest Pioneer Authorized Independent Service Company, or if you wish to purchase replacement parts, operating instructions, service manuals, or accessories, please call the number shown below.

8 0 0 - 4 2 1 - 1 4 0 4

Please do not ship your product to Pioneer without first calling the Customer Support Division at the above listed number for assistance.

PIONEER ELECTRONICS SERVICE, INC.
1925 E. DOMINGUEZ ST. LONG BEACH,
CA 90801-1760, U.S.A.

For warranty information please see the Limited Warranty sheet included with your product.

S017_En



J2K40401A SH 07/03

Published by Pioneer Corporation.
Copyright © 2007 Pioneer Corporation.
All rights reserved.

PIONEER CORPORATION

4-1, Meguro 1-Chome, Meguro-ku, Tokyo 153-8654, Japan

PIONEER ELECTRONICS (USA) INC.

P.O. BOX 1540, Long Beach, California 90801-1540, U.S.A. TEL: (800) 421-1404

PIONEER ELECTRONICS OF CANADA, INC.

300 Allstate Parkway, Markham, Ontario L3R 0P2, Canada TEL: 1-877-283-5901, 905-479-4411

PIONEER EUROPE NV

Haven 1087, Keetberglaan 1, B-9120 Melsele, Belgium TEL: 03/570.05.11

PIONEER ELECTRONICS ASIACENTRE PTE. LTD.

253 Alexandra Road, #04-01, Singapore 159936 TEL: 65-6472-7555

PIONEER ELECTRONICS AUSTRALIA PTY. LTD.

178-184 Boundary Road, Braeside, Victoria 3195, Australia, TEL: (03) 9586-6300

PIONEER ELECTRONICS DE MEXICO S.A. DE C.V.

Blvd.Manuel Avila Camacho 138 10 piso Col.Lomas de Chapultepec, Mexico,D.F. 11000 TEL: 55-9178-4270

K002_B_En